

HISTORICAL COLLECTION

WORLD WAR II



BELL® P-39Q AIRACOBRA

PLACE OF ORIGIN - UNITED STATES
 IN SOVIET SERVICE - 1944 - LATE 40's
 ROLE - FIGHTER
 CREW - 1
 WINGSPAN - 10,36m (34')
 LENGTH - 9,2m (30' 2")
 HEIGHT - 3,78m (12' 5")
 EMPTY WEIGHT - 2 560kg (5 645lb)
 ENGINE - ALLISON V1710-85, 1200HP (895kW)
 RANGE - 1 050km (650mi)
 RATE OF CLIMB - 19m/s (3 800FT/MIN)
 MAXIMUM FLIGHT LEVEL - 10 670m (35 000FT)
 ARMAMENT - 1x 37mm M4 CANNON,
 4x BROWNING M2 12,7mm (.50) MG,
 BOMB OR DROP TANK
 MAXIMUM SPEED - 620km/h (385MPH)



OFFICIAL LICENSED PRODUCT
 68-11121-43210

5747

Bell®, emblems, logos, and body designs are trademarks of Textron Innovations Inc. and are used under license by Cobi.

PAD PRINTED
NO STICKERS

Printed in EU



WARNING: CHOKING HAZARD-
 Toy contains small parts.
 Not for children under 3 years.

380 1

BELL® P-39Q AIRACOBRA

SCALE 1:32

1

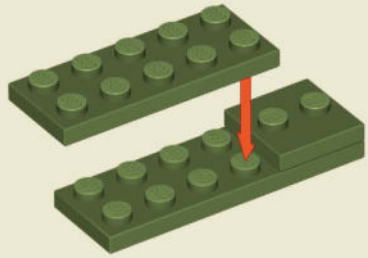

x1



x1



x1

2

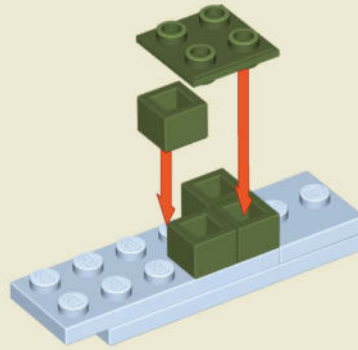

x4



x1

3

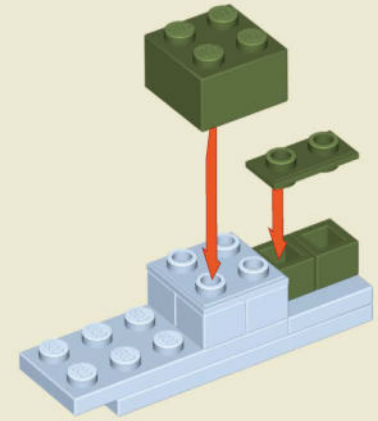

x2



x1



x1

4

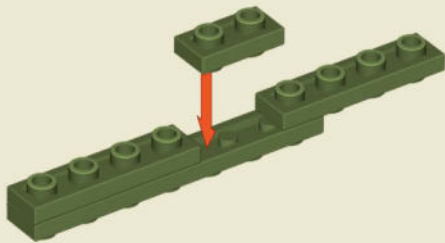

x1



x2



x1

5

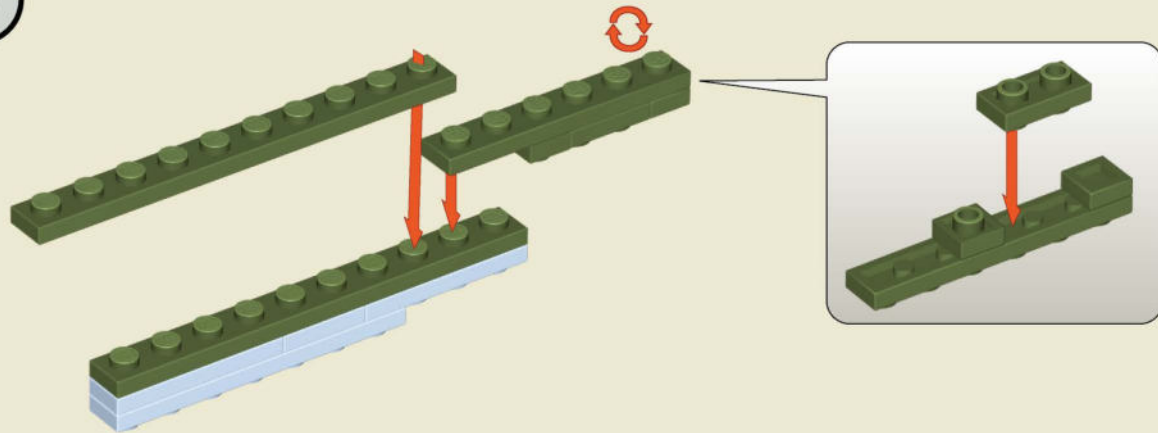

x2



x1



x1



x1



x1

6

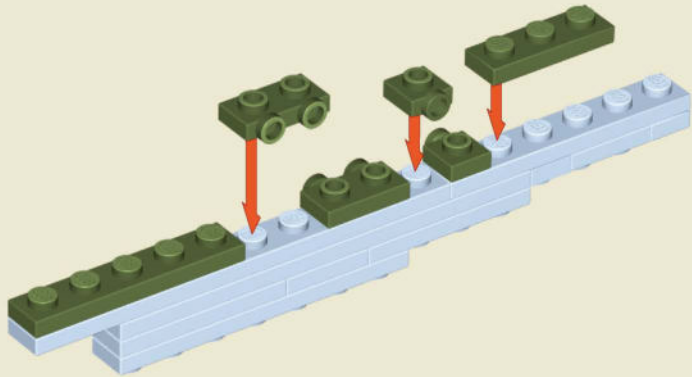

7

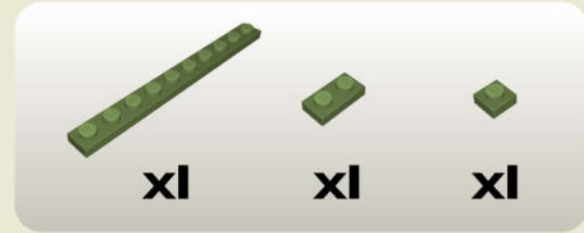
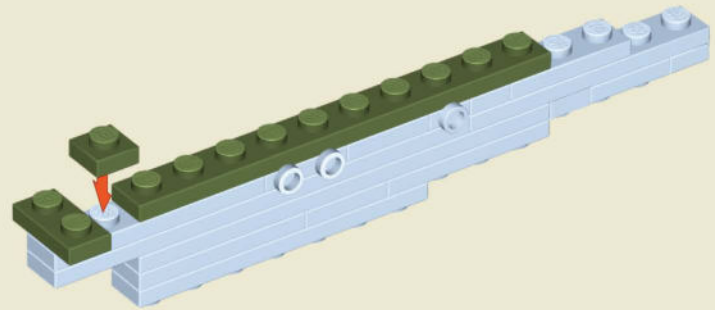

8

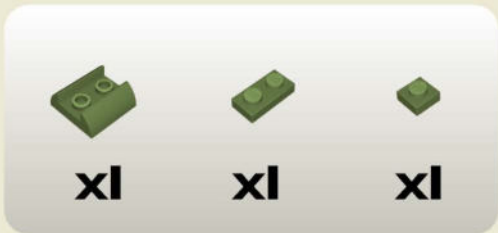
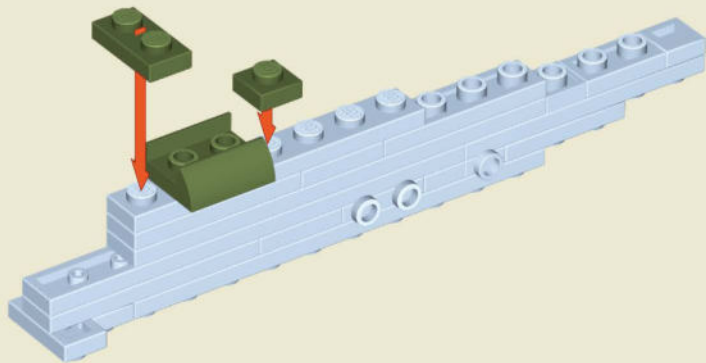

9

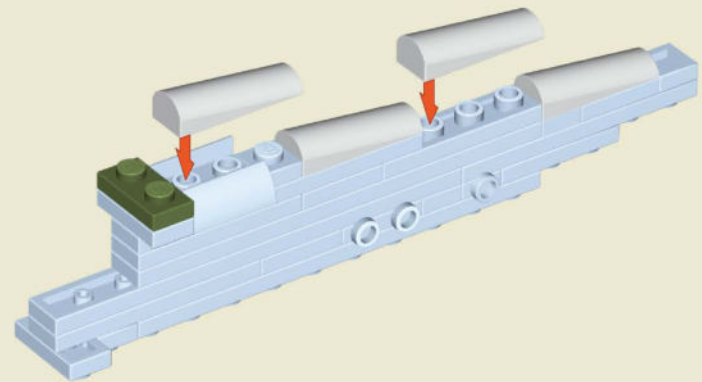

10

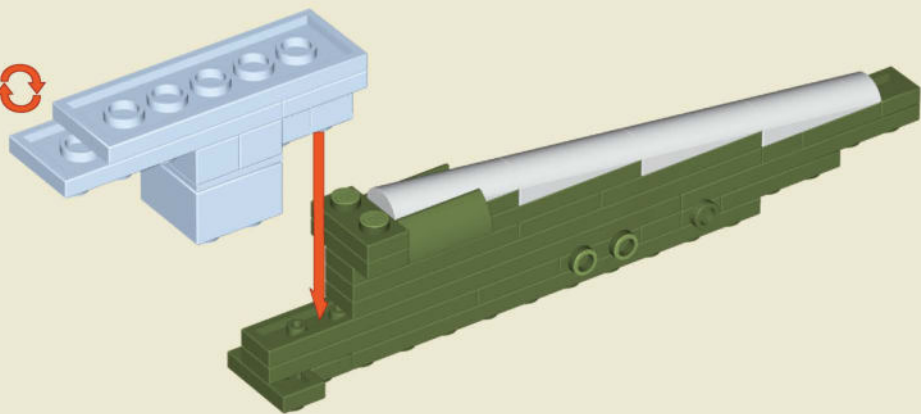

11

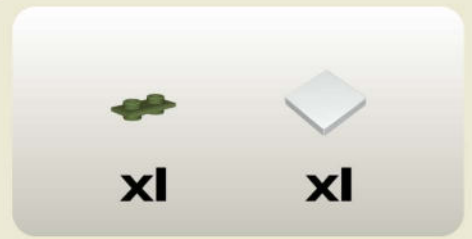
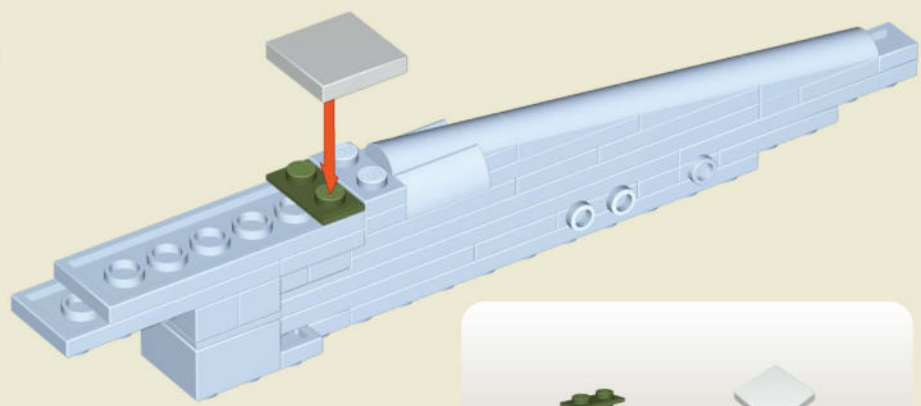

BE CAREFUL: NOTICE THE DIFFERENCE

12

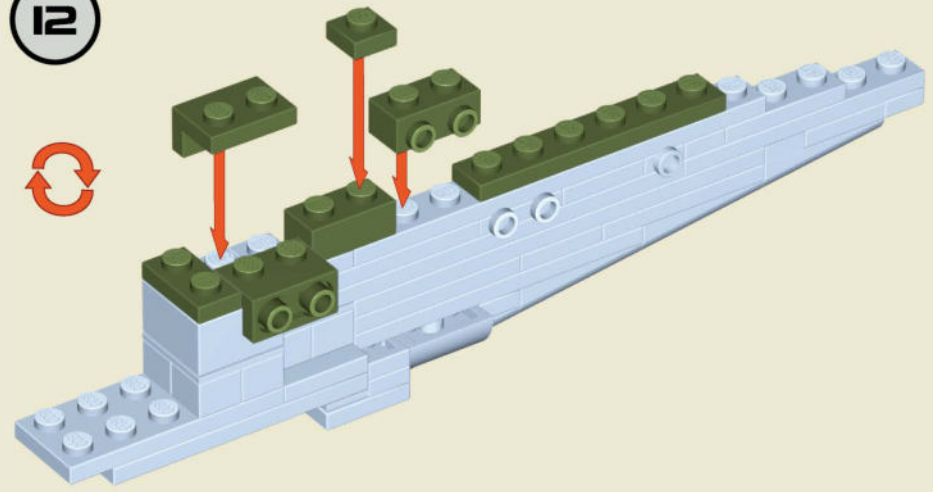

13

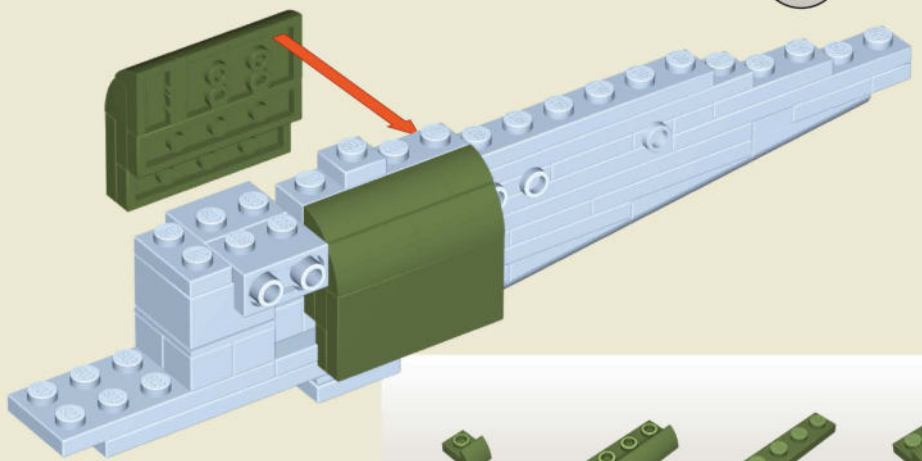
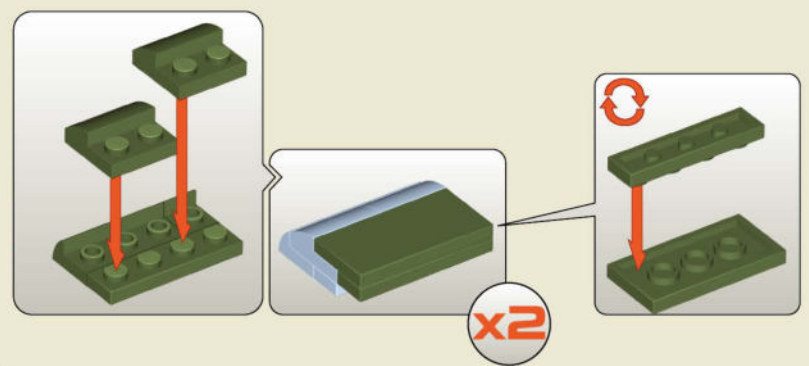

14

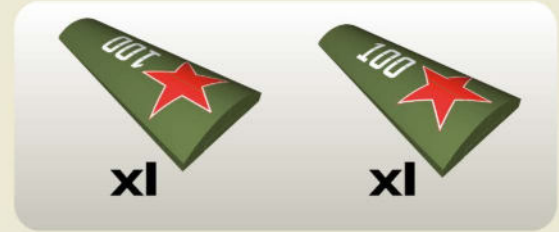
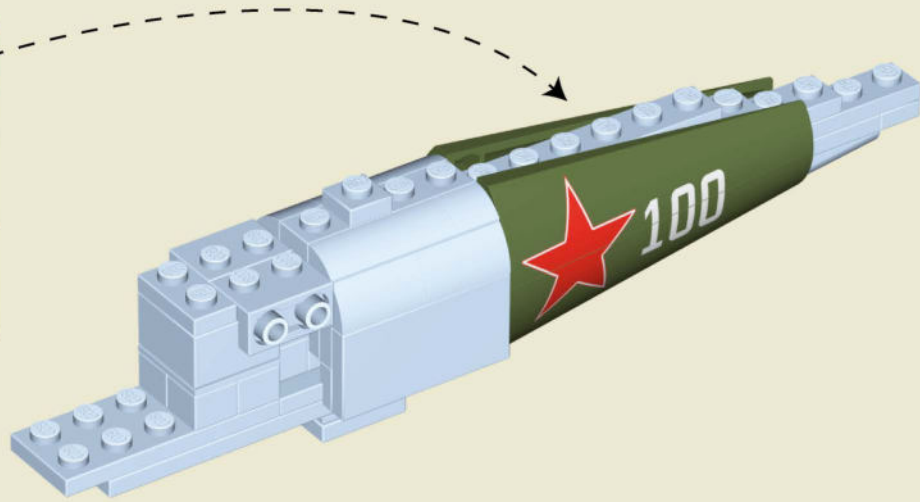
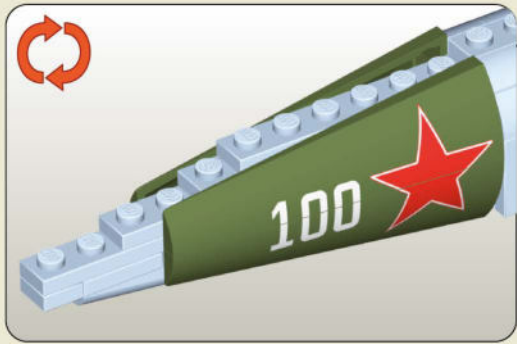

15

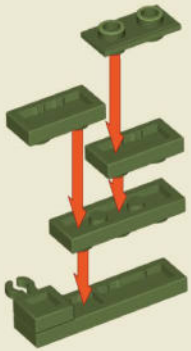

1:1



16

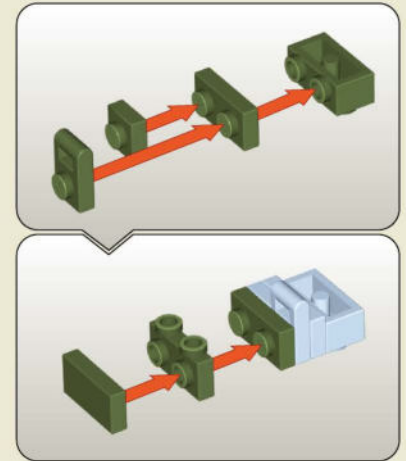
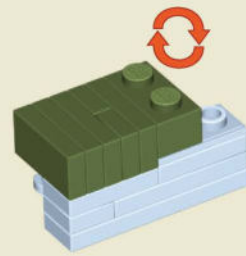

1:1

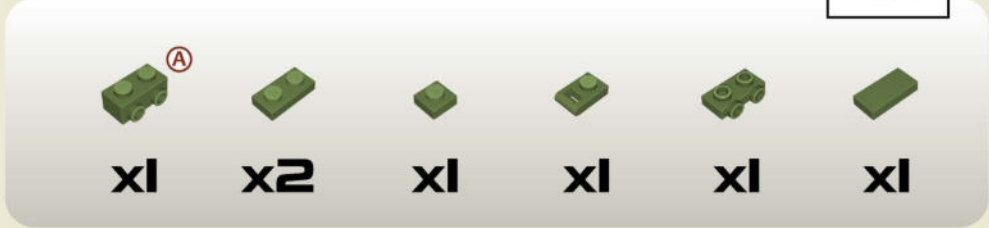

17

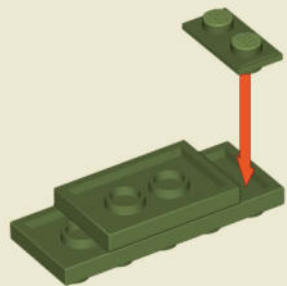

x1



x1



x1

18

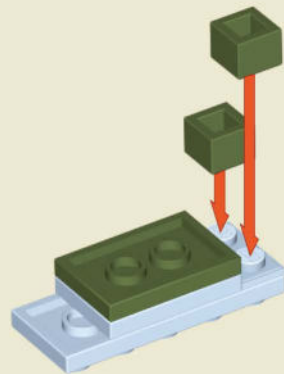

x1



x2

19

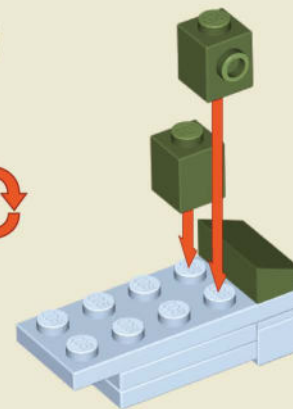

x1



x2

20

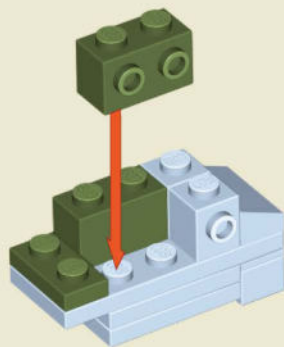

x1



x2

21

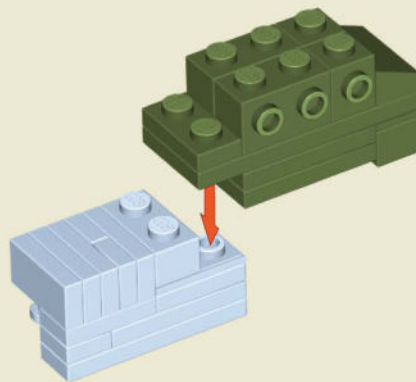

22

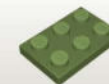
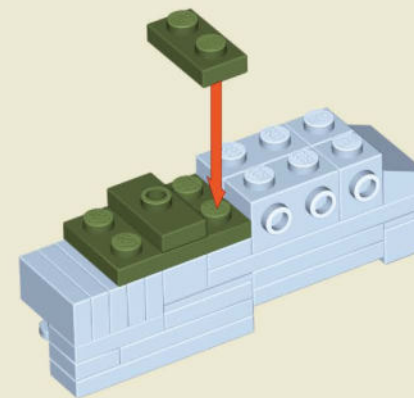

x1







x1

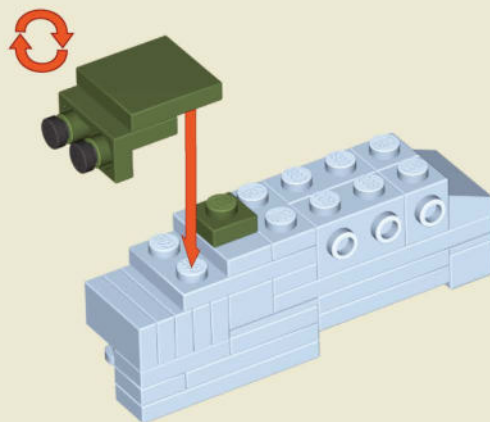
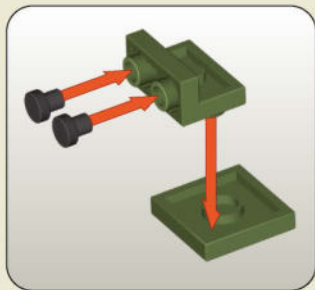

x1

23



-  x1
-  x1
-  x1
-  x2

24

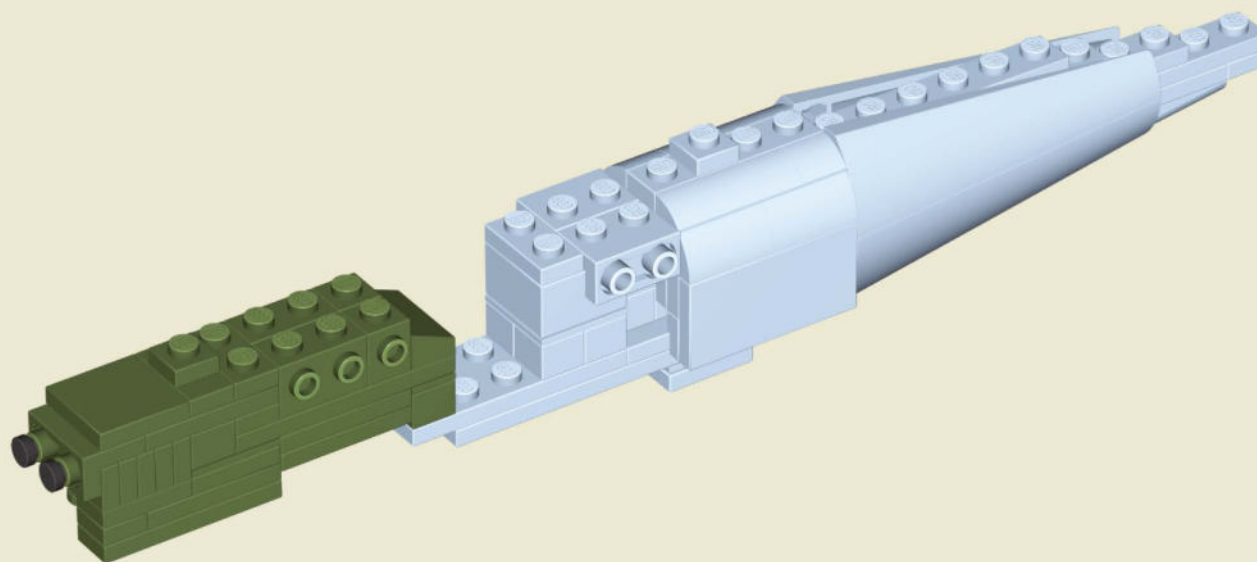

25

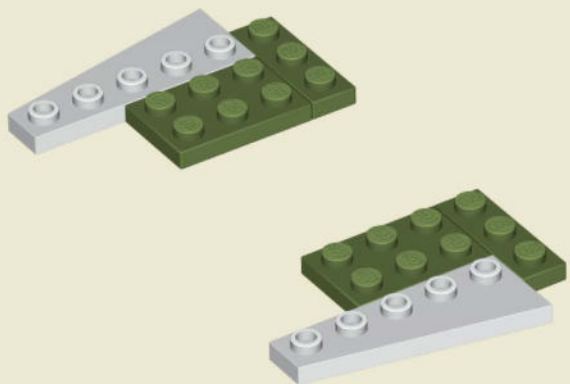

x1



x1



x2



x2

26

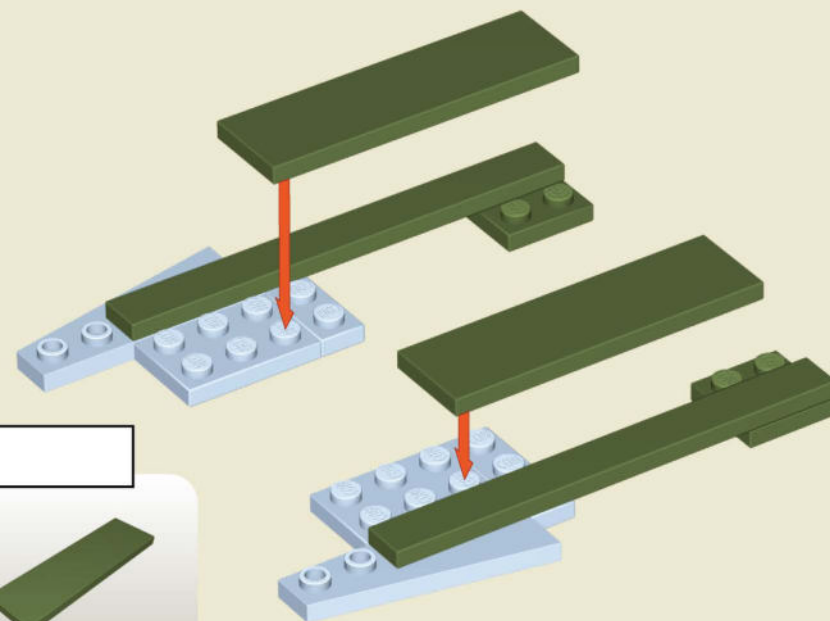

1:1



x2



x2

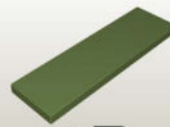

x2

27

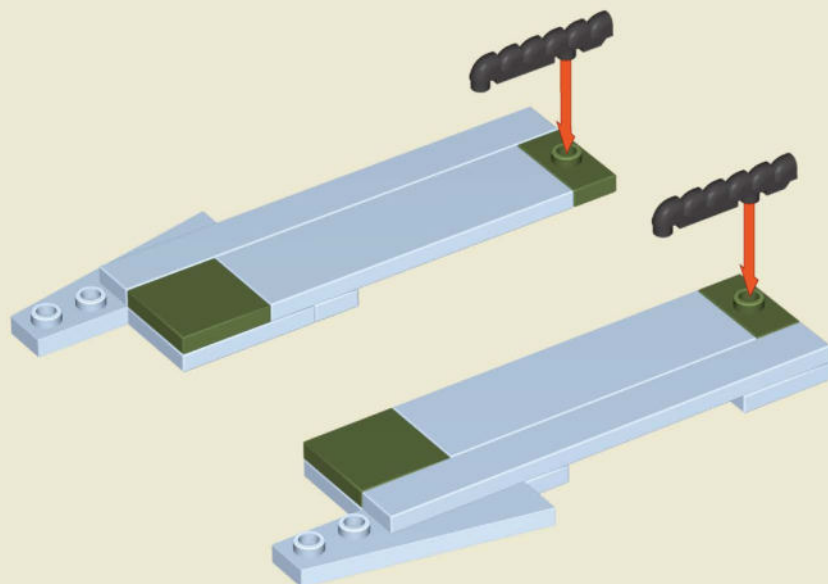

x2



x2





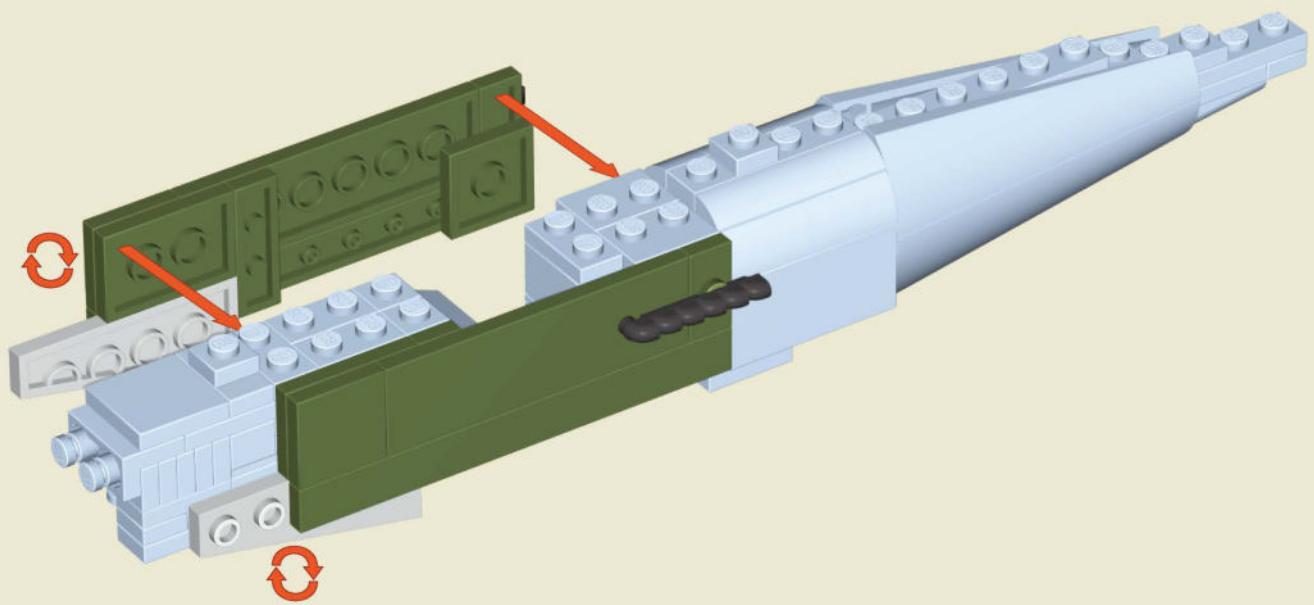

x2

28

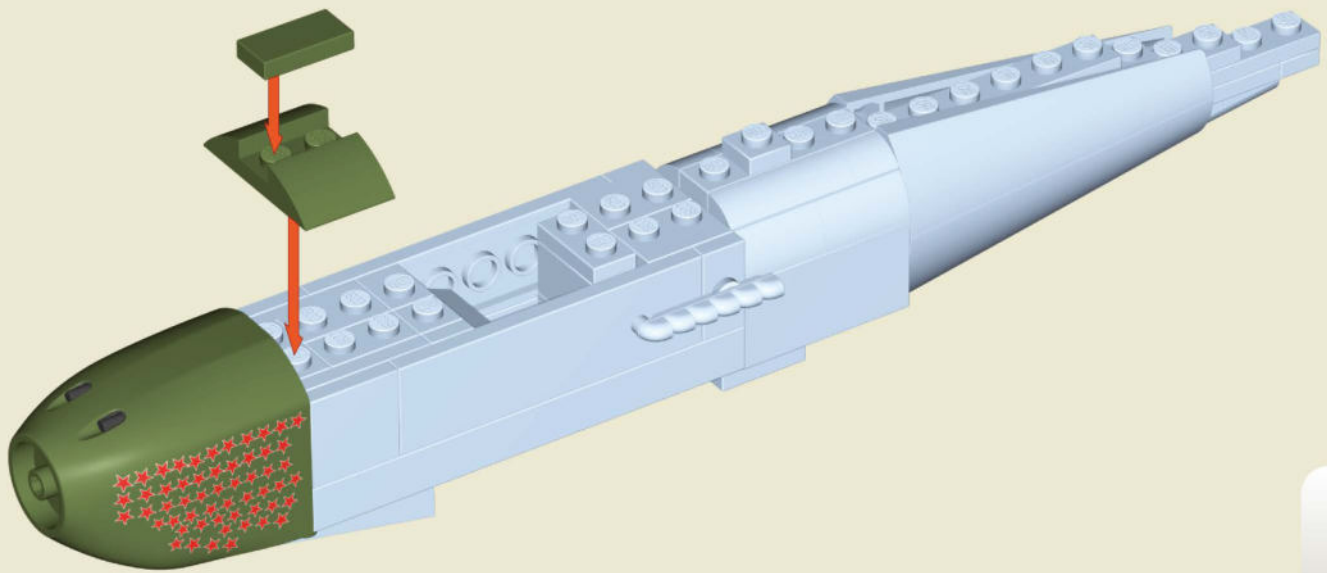

29



			1:1
x1	x1	x1	

30

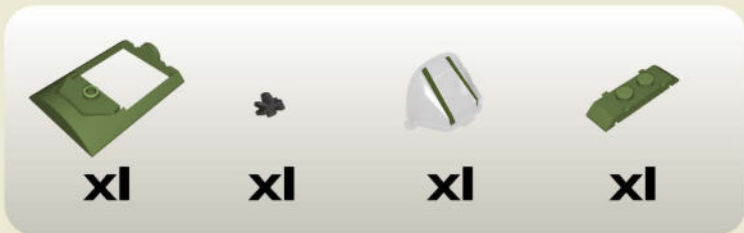
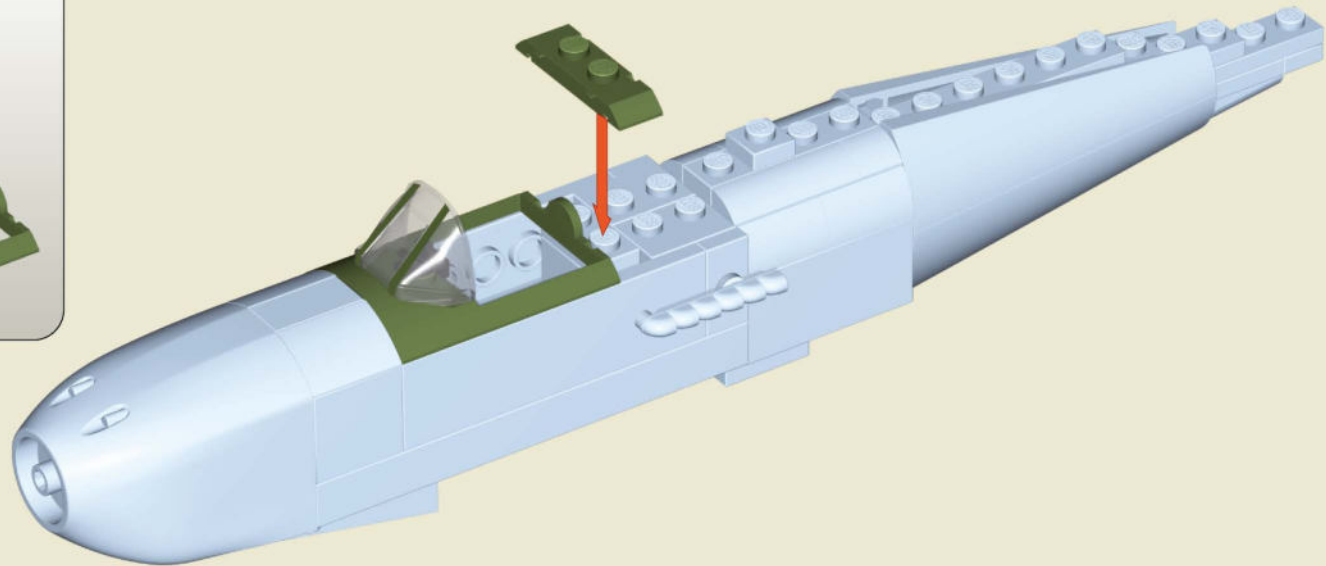

31

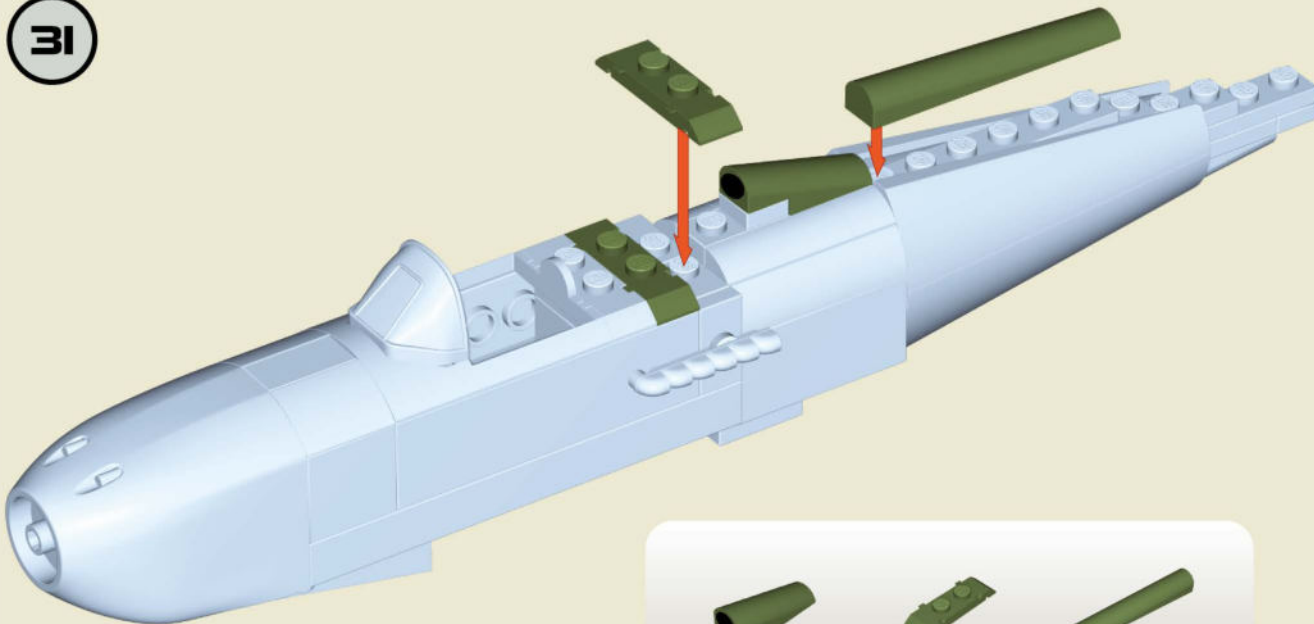

32



1:1	1:1
-----	-----

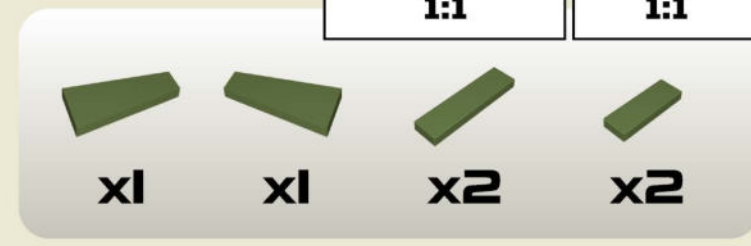

33

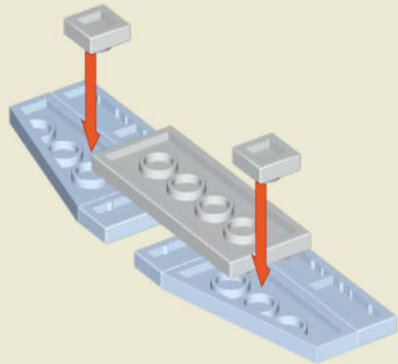

x1



x2

34

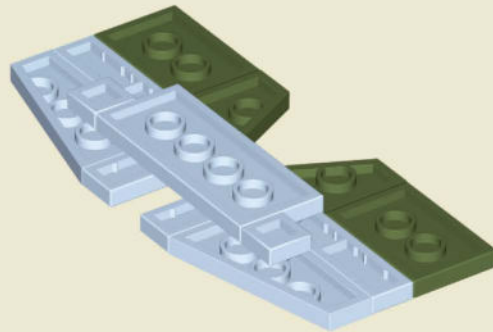

x1



x1



x2

35

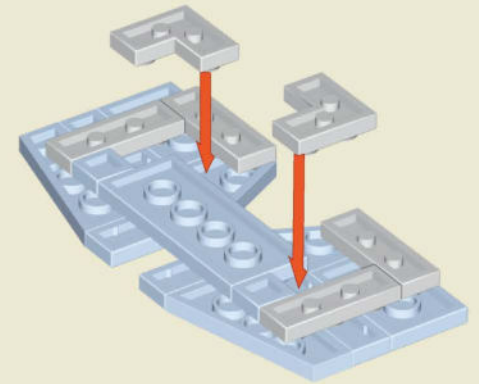

x2



x4

36

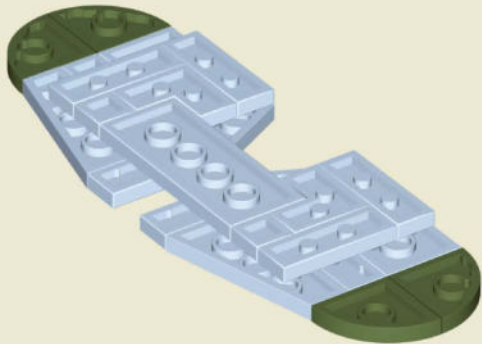

x4

37

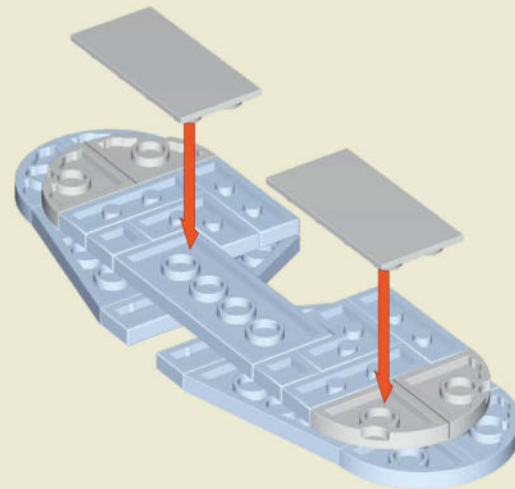

x4



x2

38

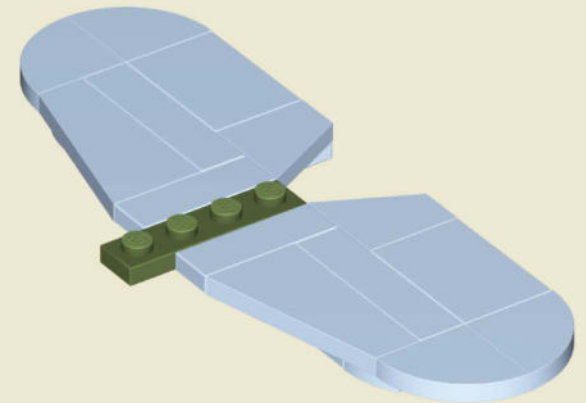

x1

39

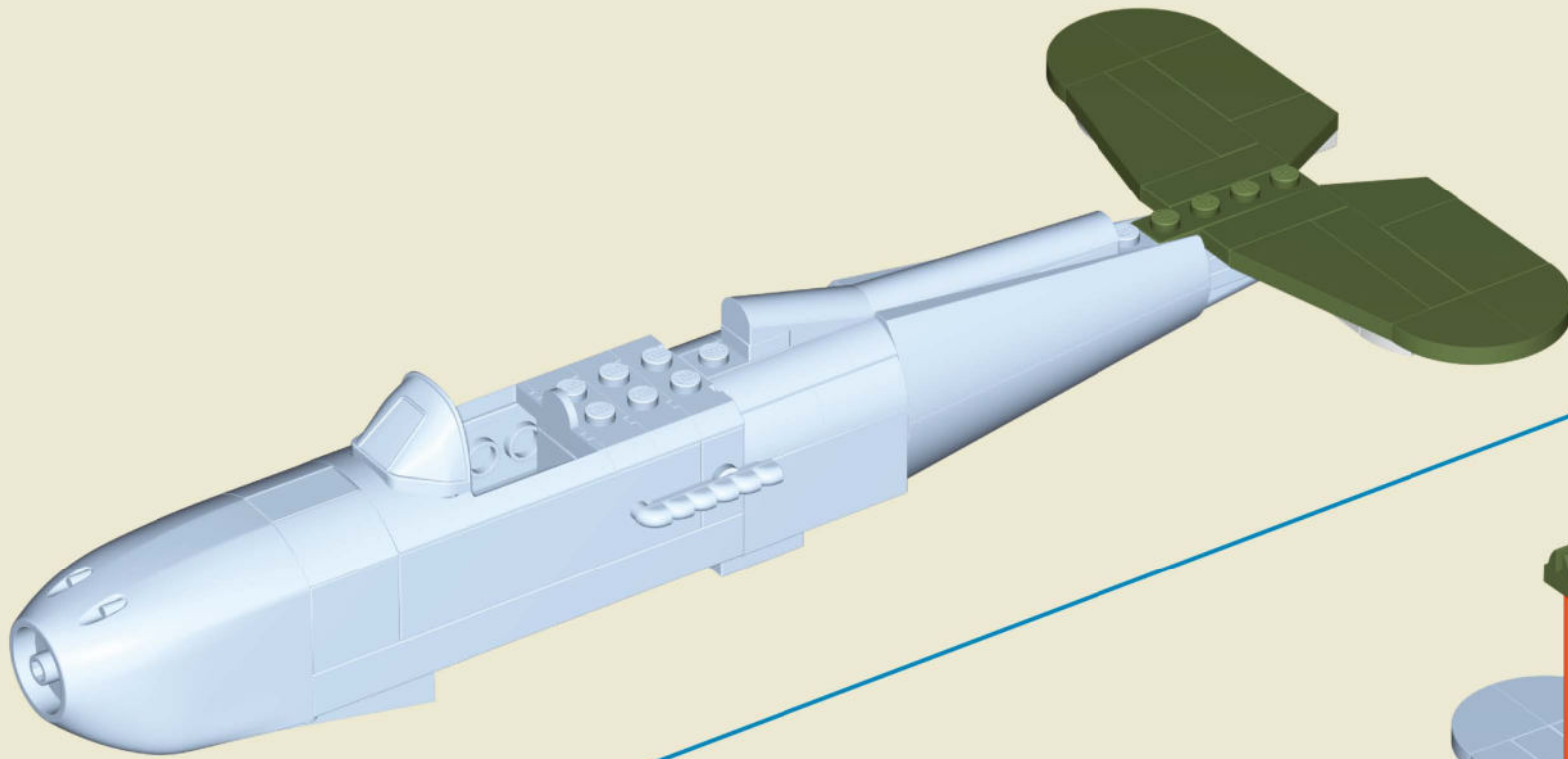

40

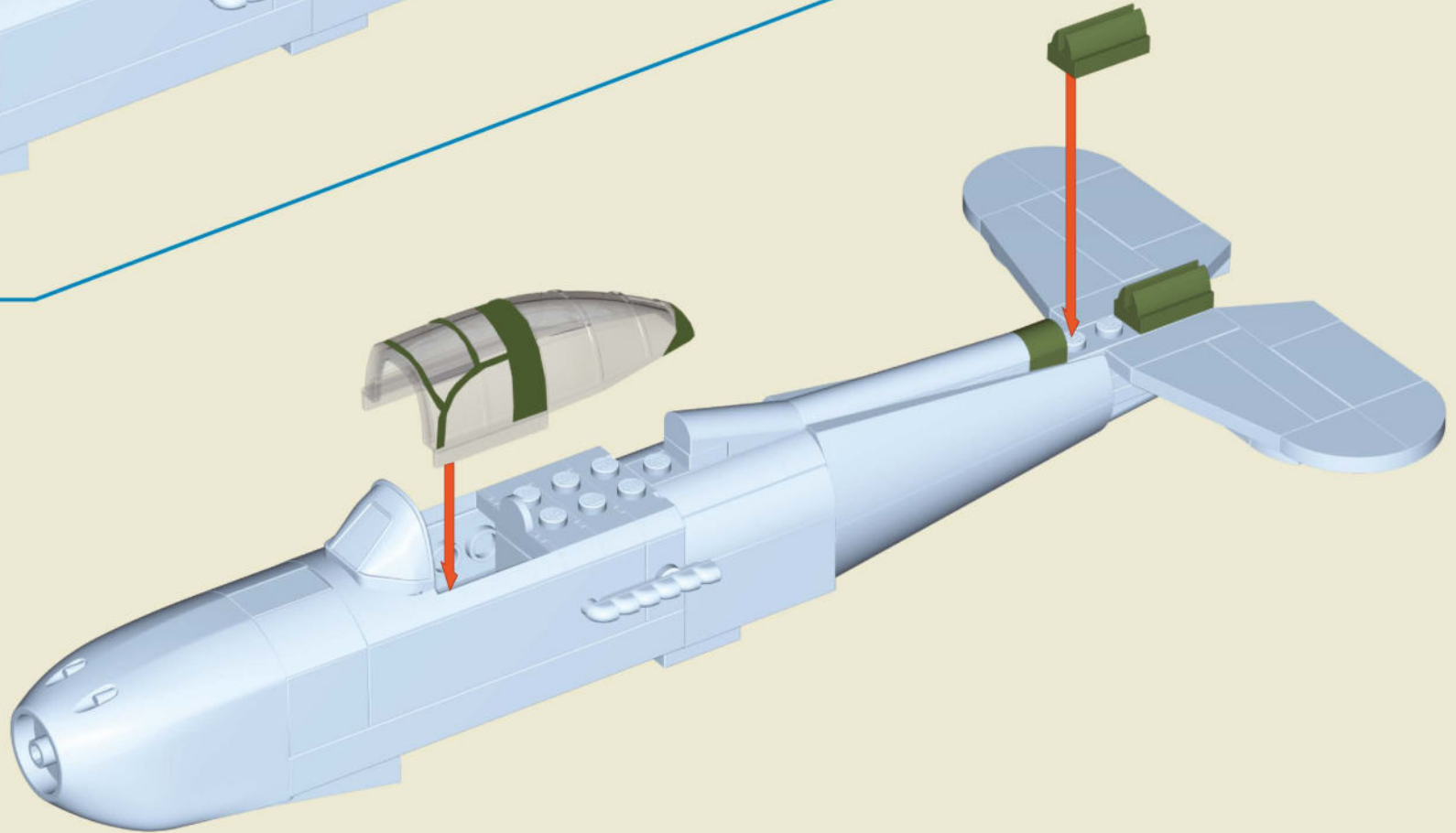

x1



x2



x1

41

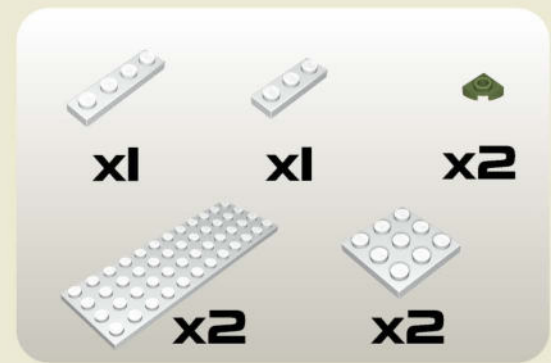

42

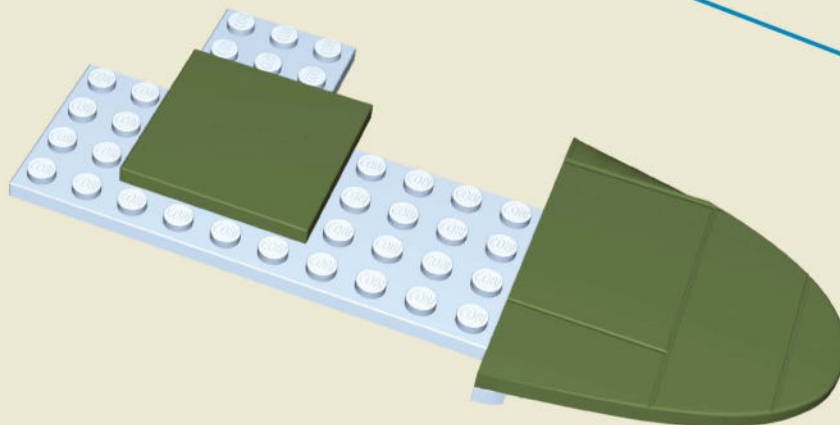
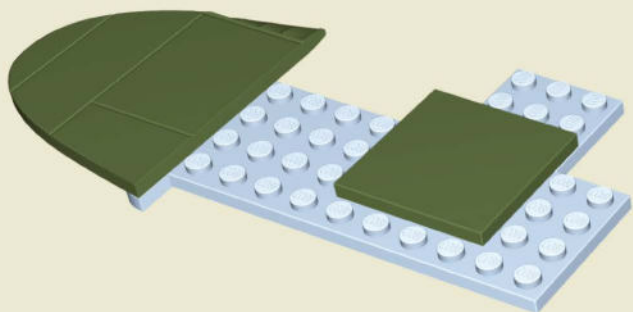
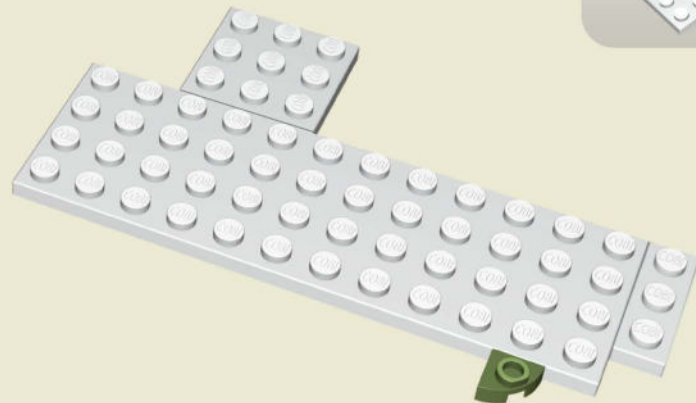

43

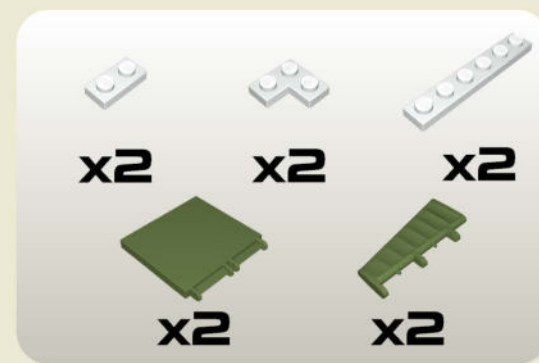
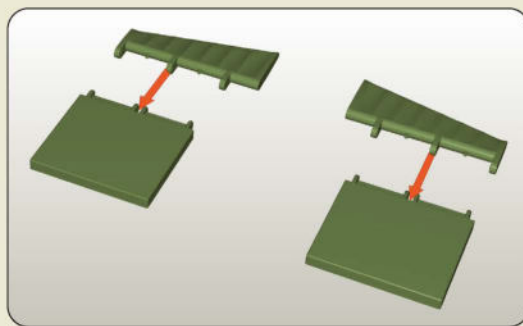
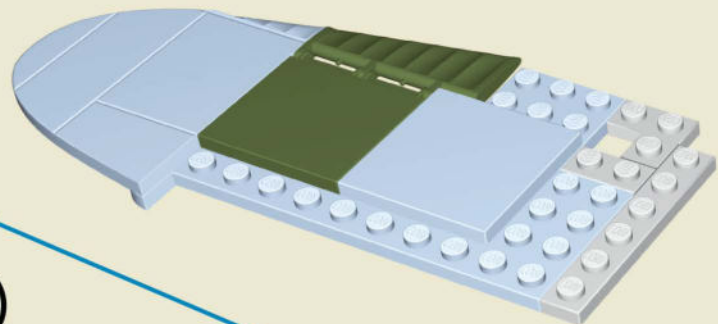

44

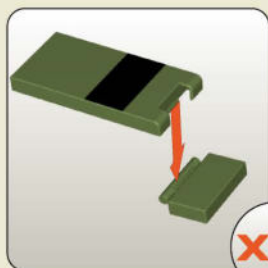
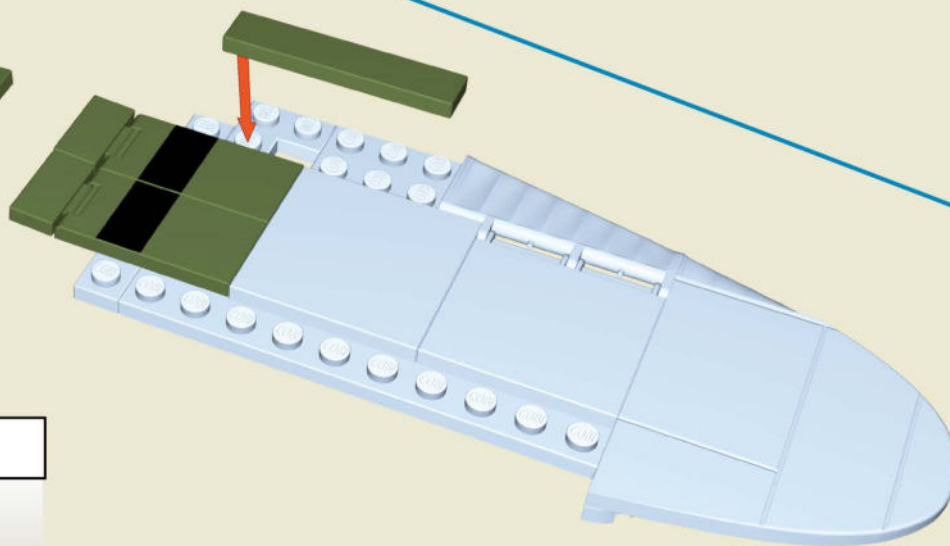
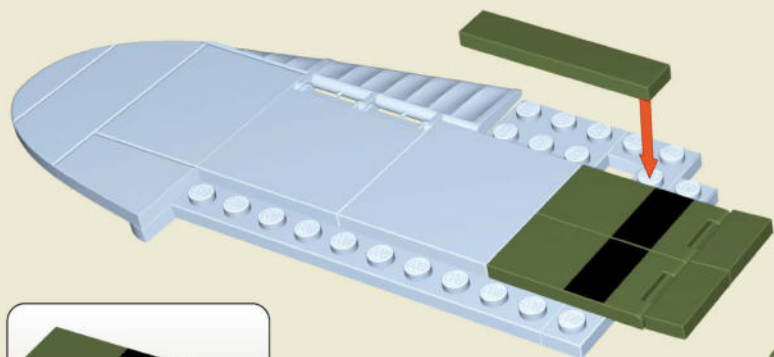
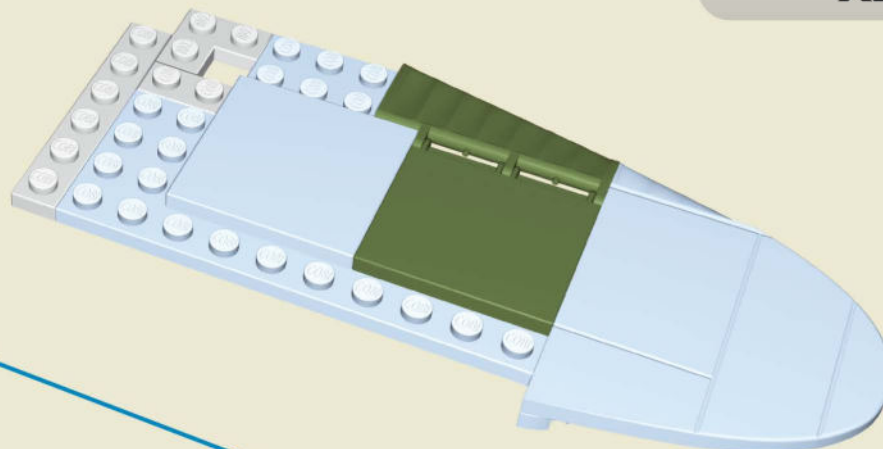

x4

1:1



45

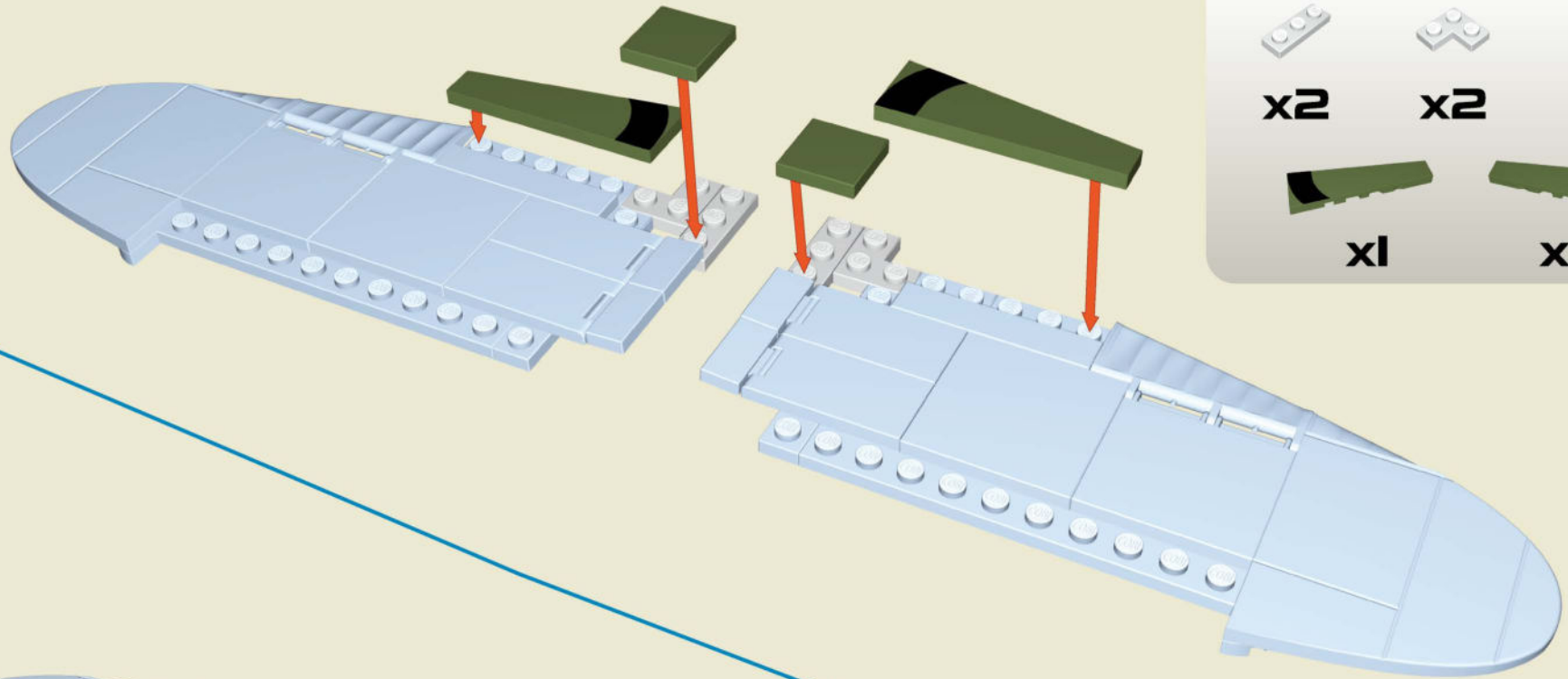

x2	x2	x2
x1	x1	

46

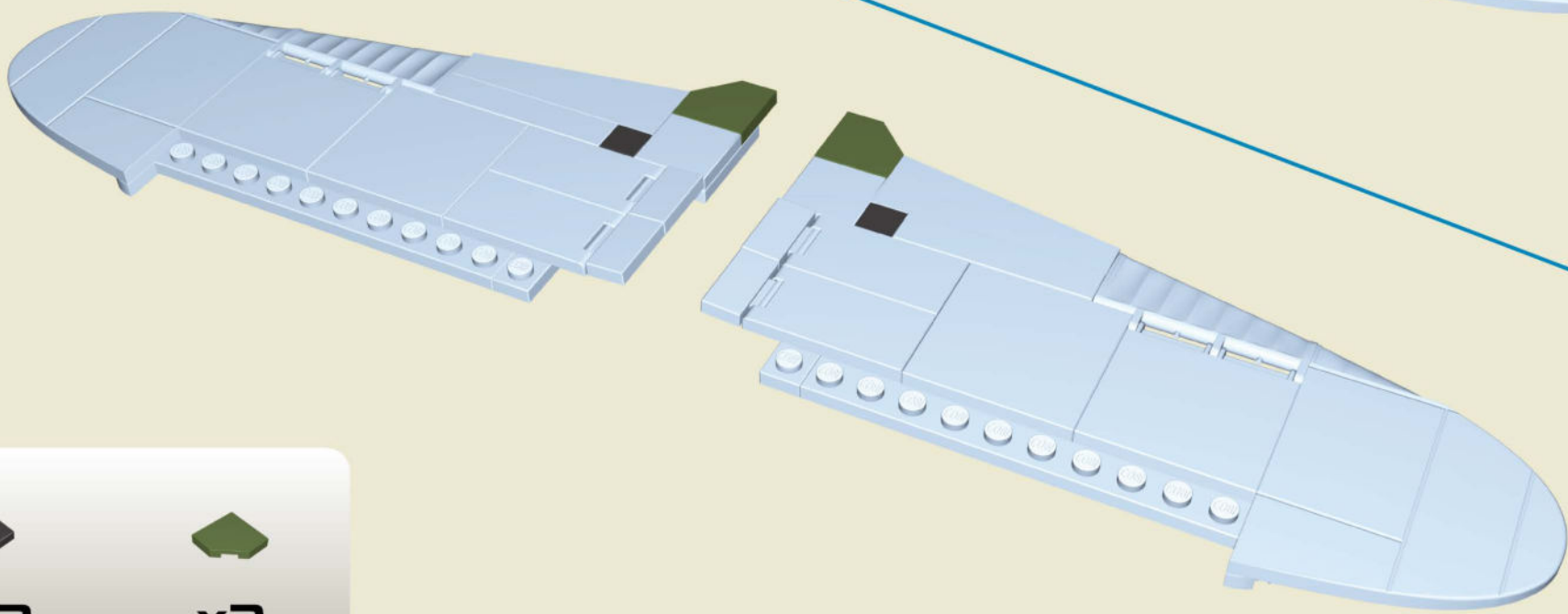

x2	x2

47

x2 x2 x2 x1

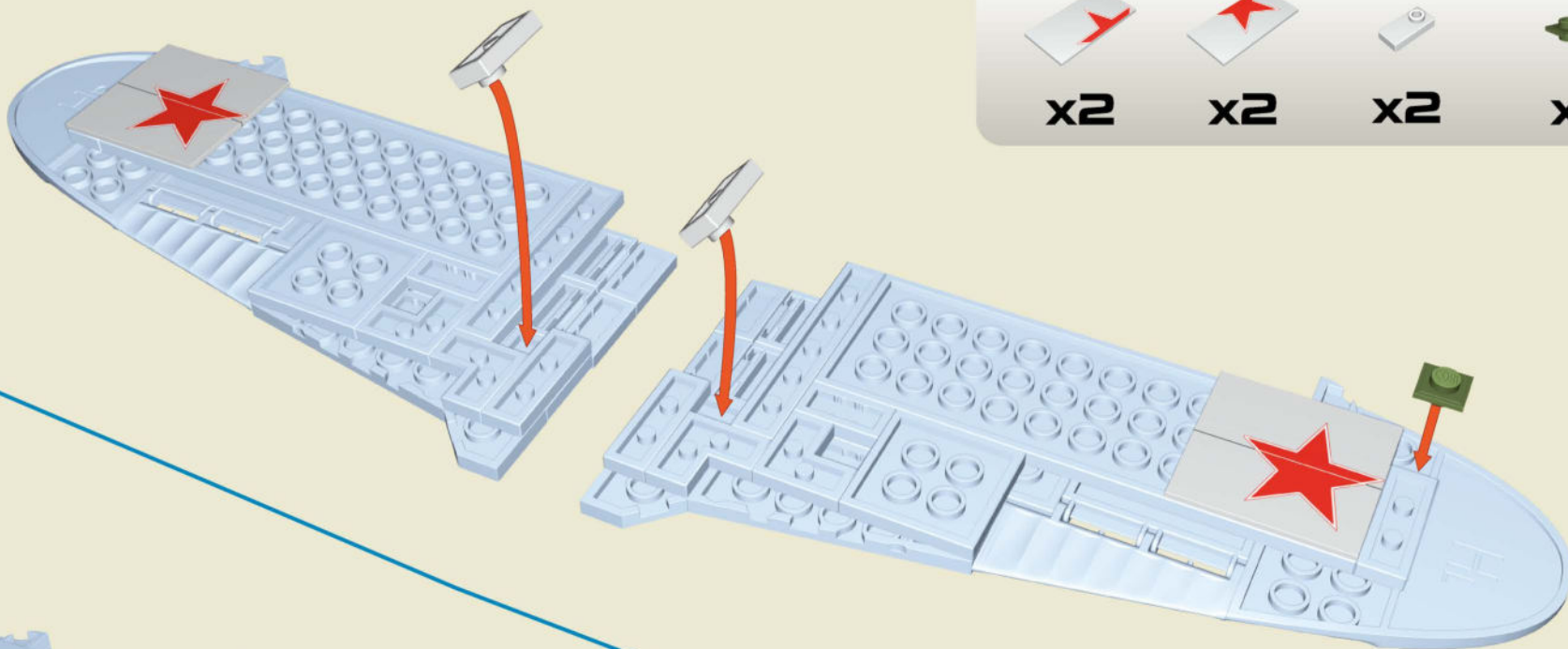



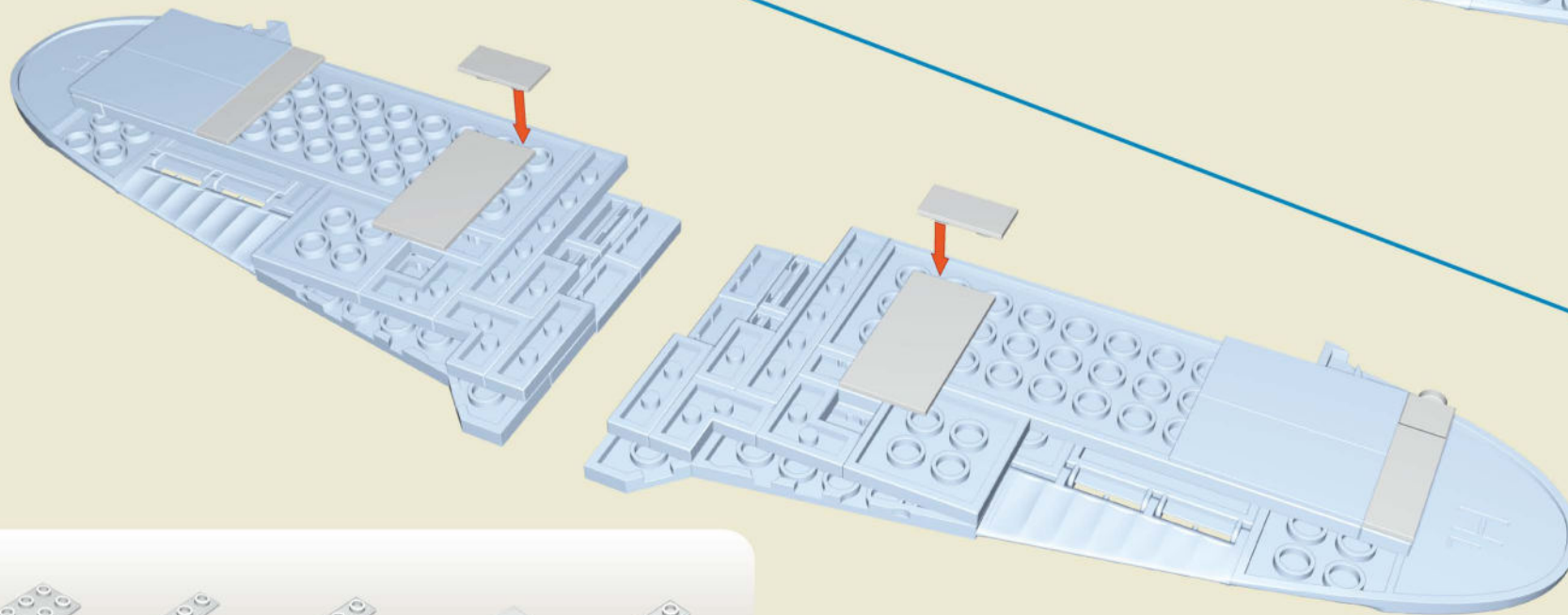

48



x2 x1 x1 x1 x2

49

		
x4	x2	x2
		
x4	x1	

50

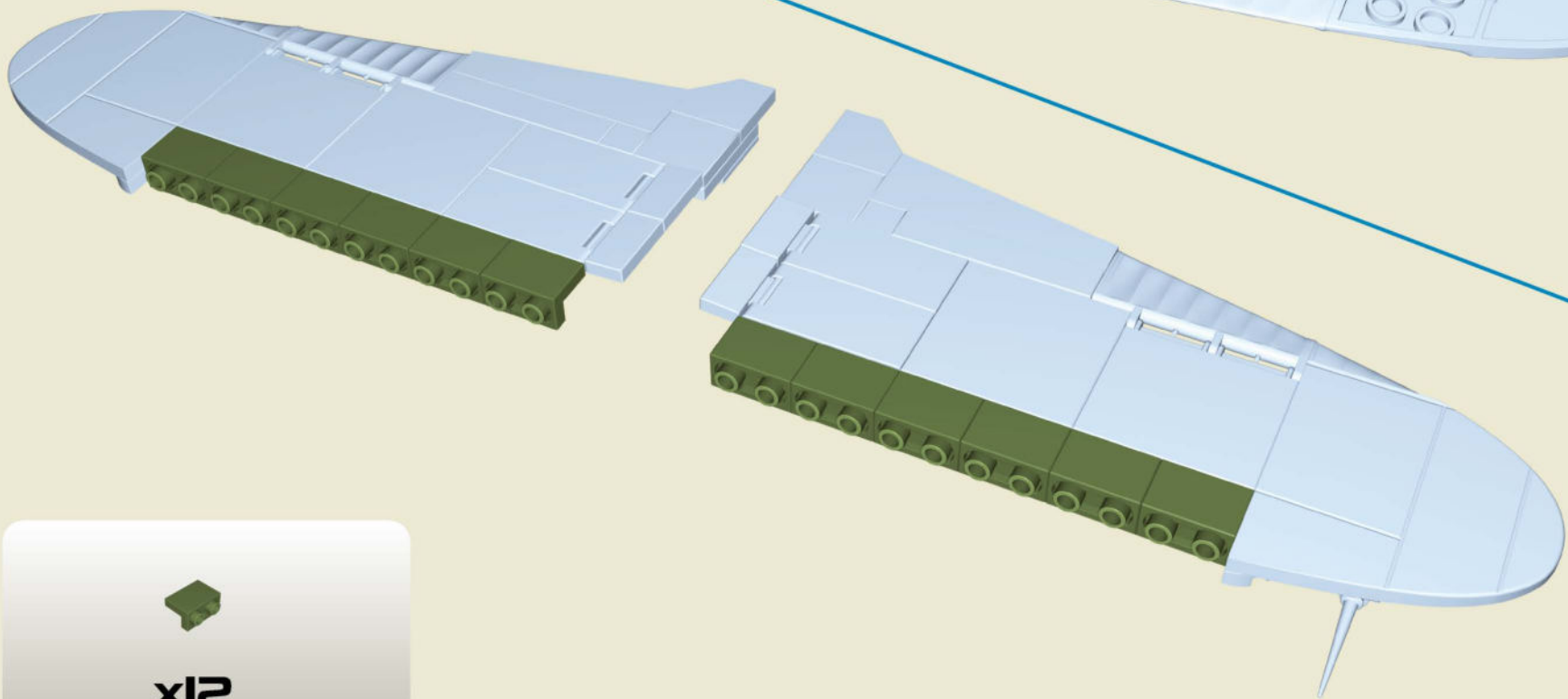

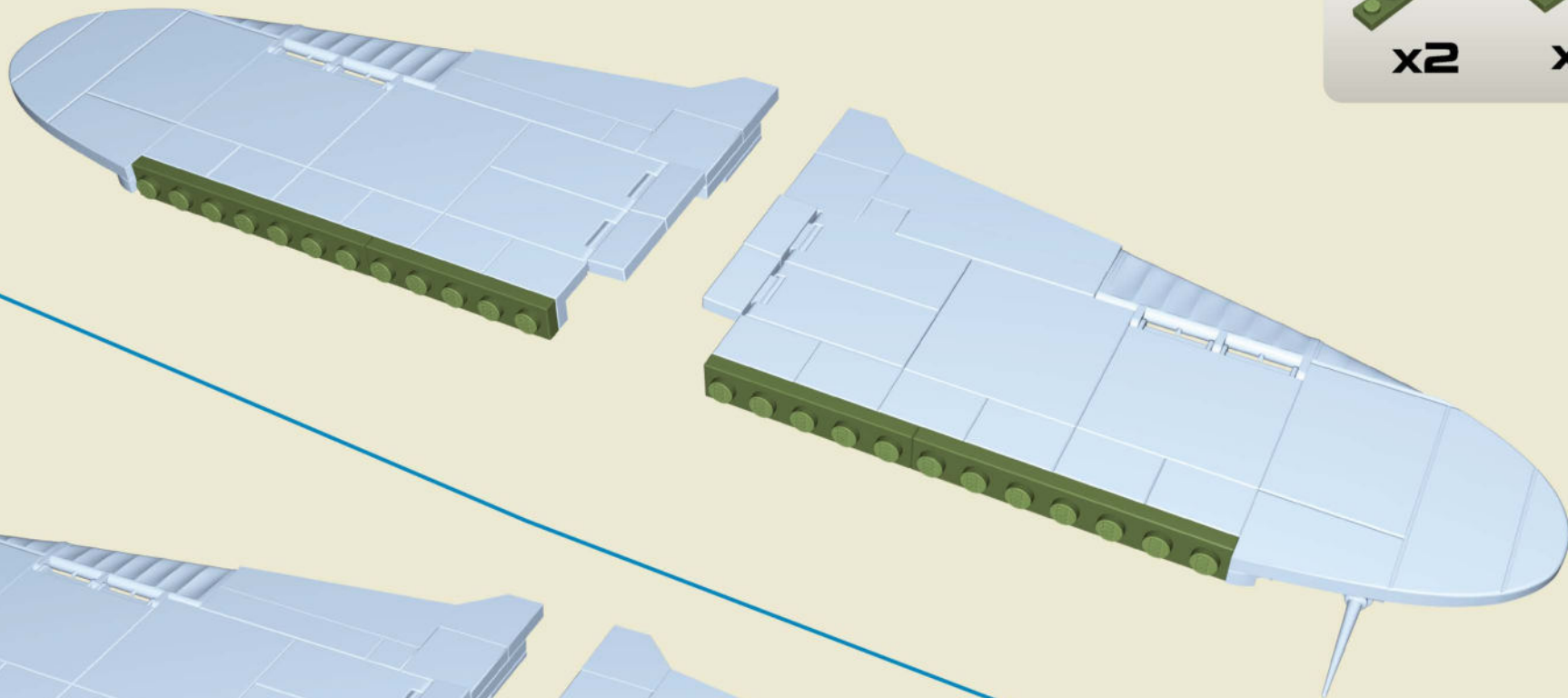
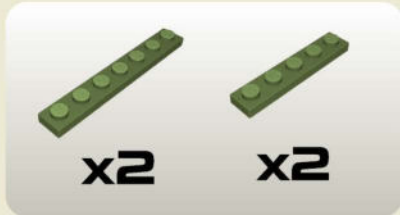

x12

51

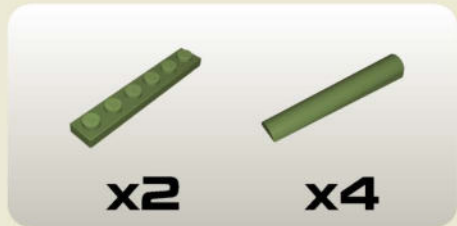
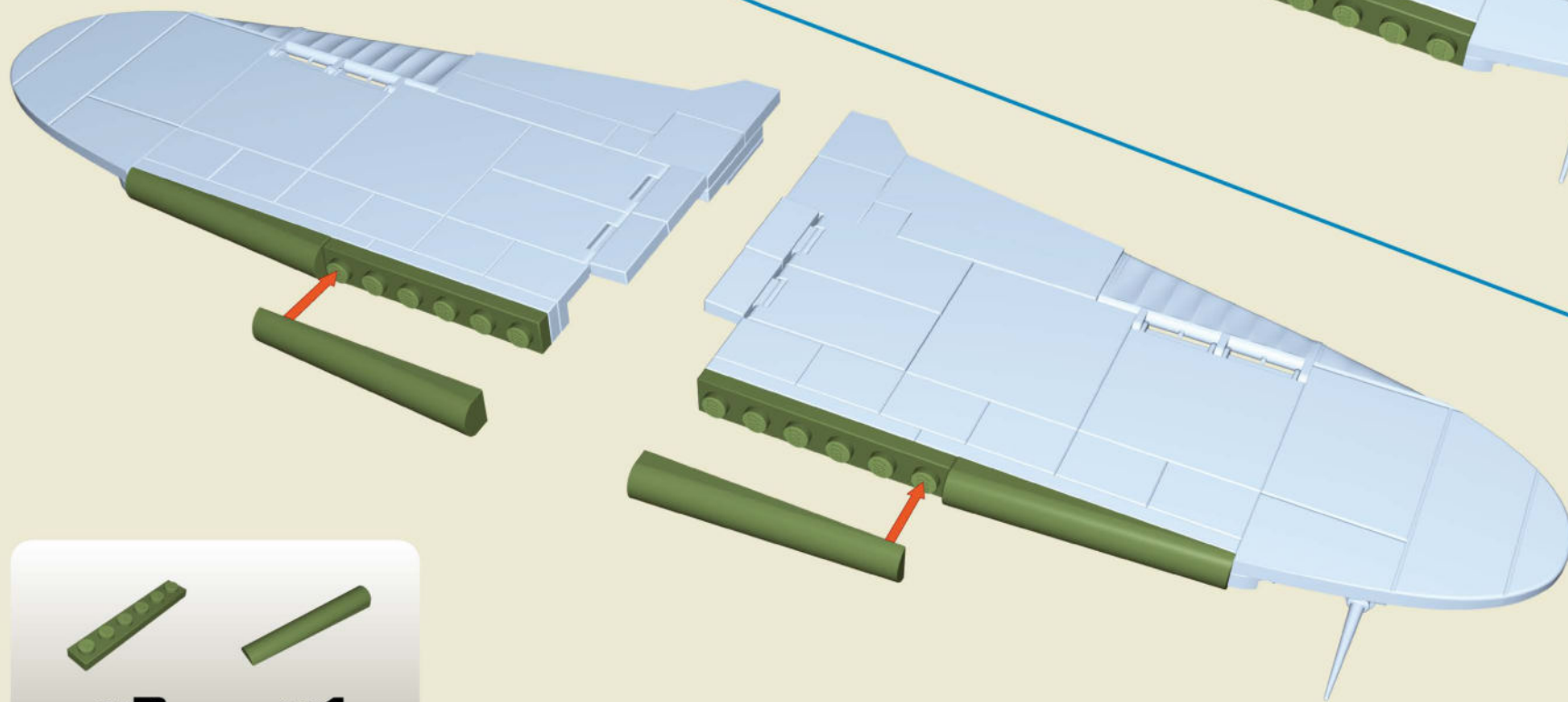

52



53

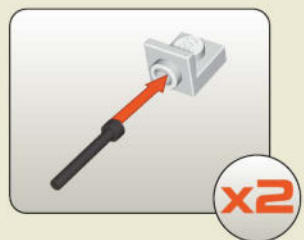
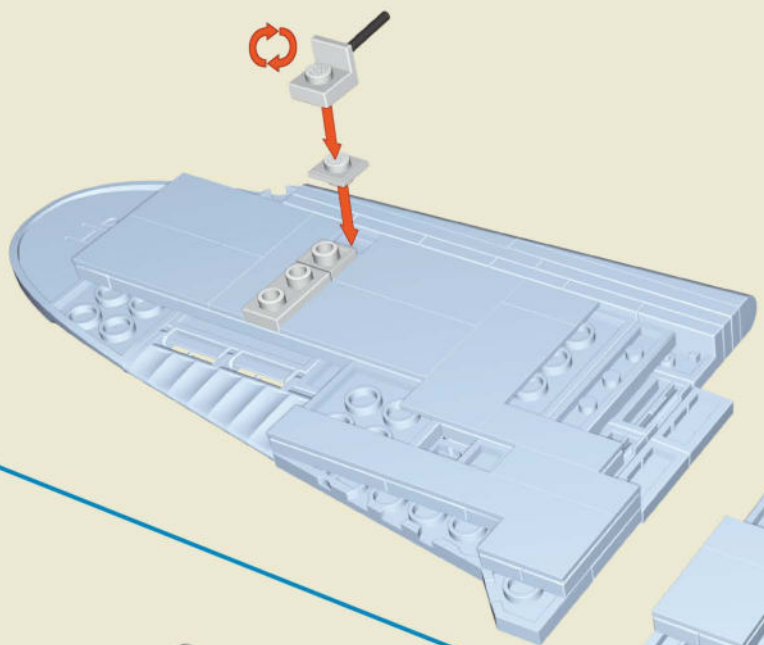

- | | | |
|----|----|----|
| | | |
| x2 | x2 | x2 |
| | | |
| x2 | x2 | |

54

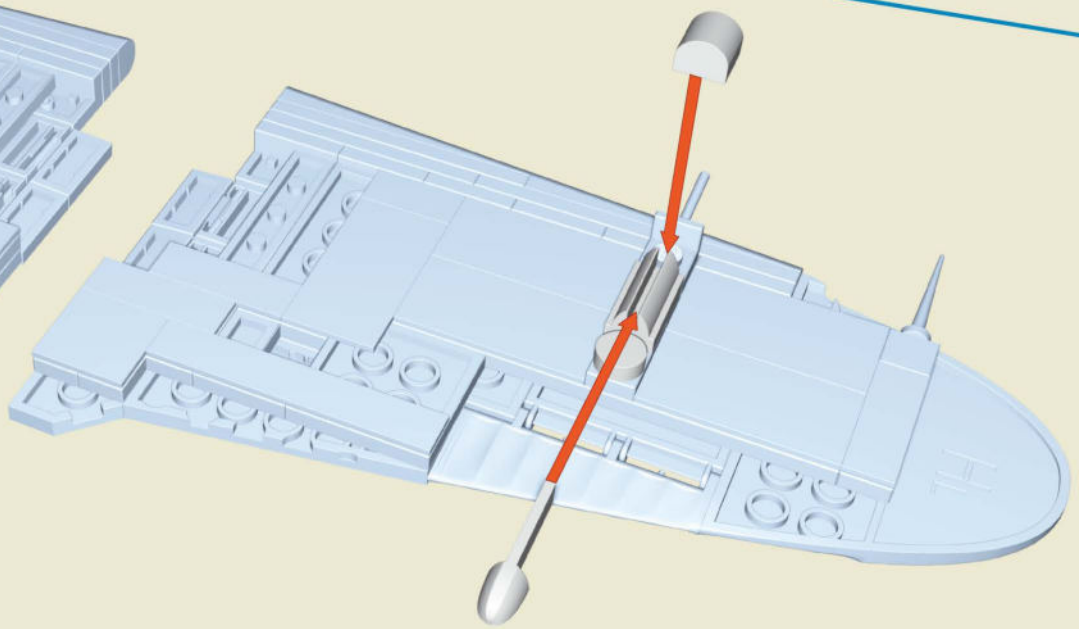
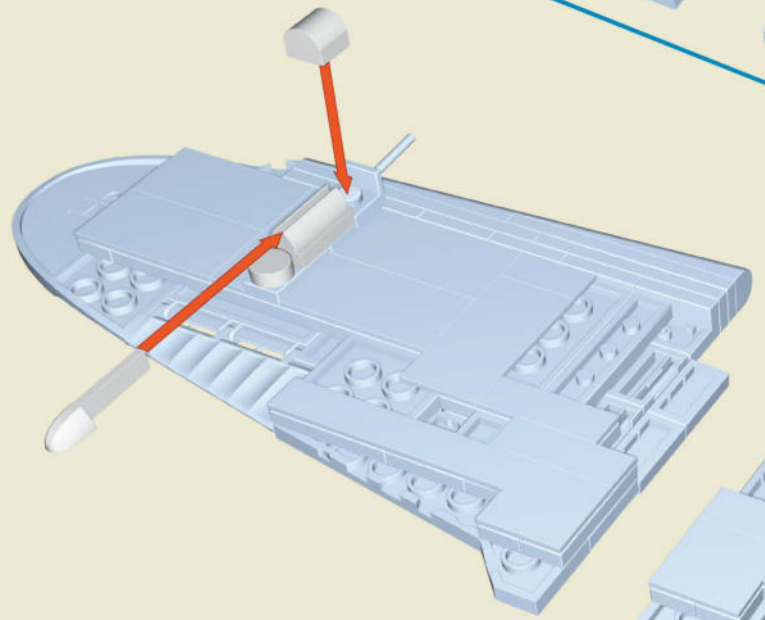
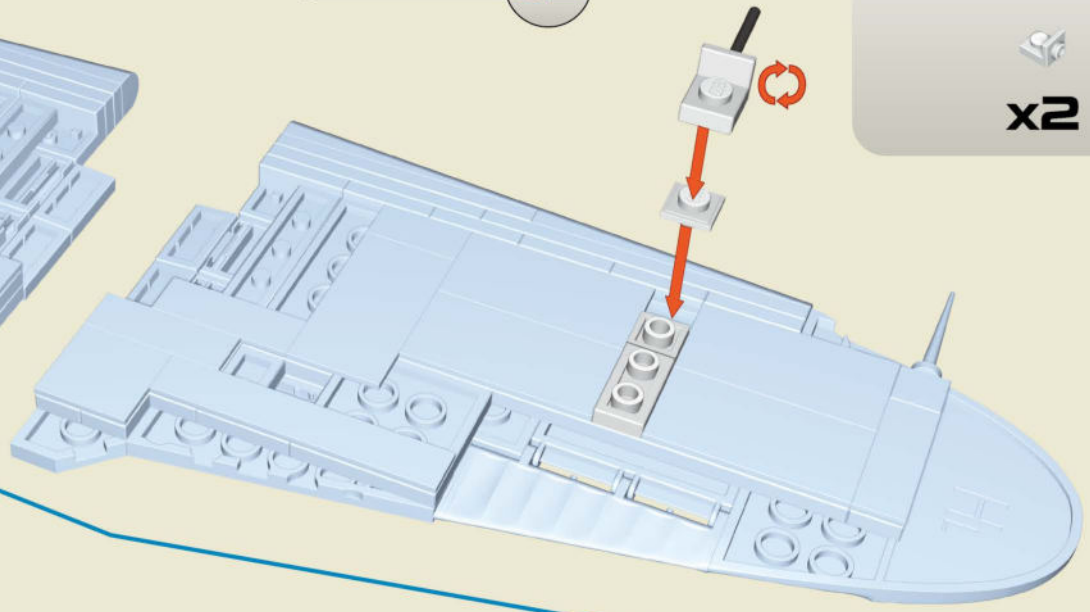

- | | |
|----|----|
| | |
| x2 | x2 |
| | |
| x2 | x2 |

55

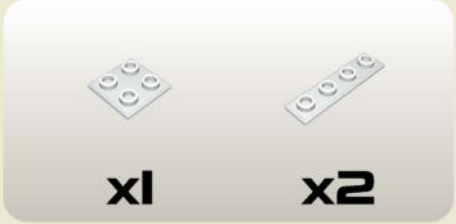

x1

x2

56

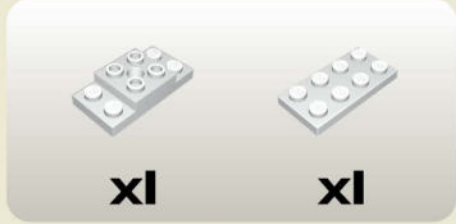

x1

x1

57

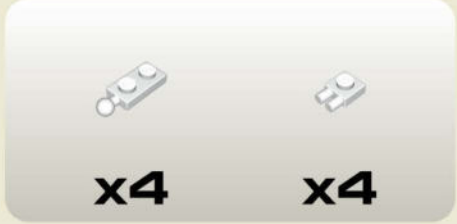
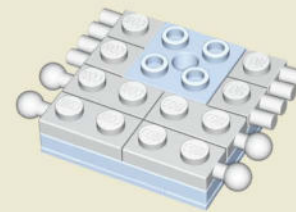

x4

x4

58

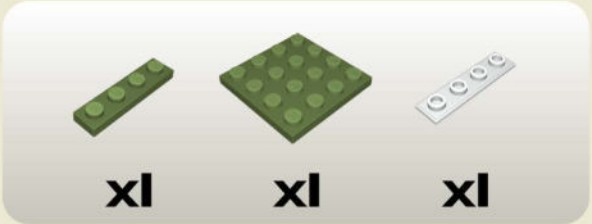
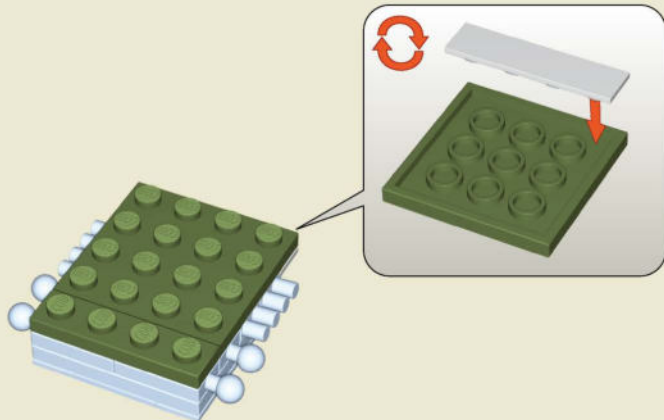

x1

x1

x1

59

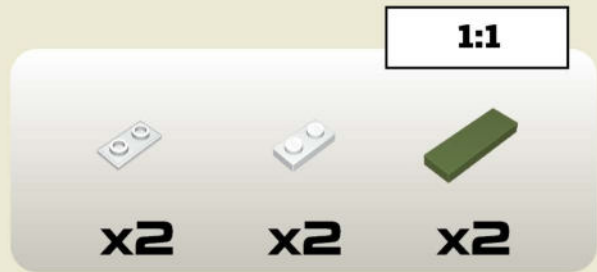
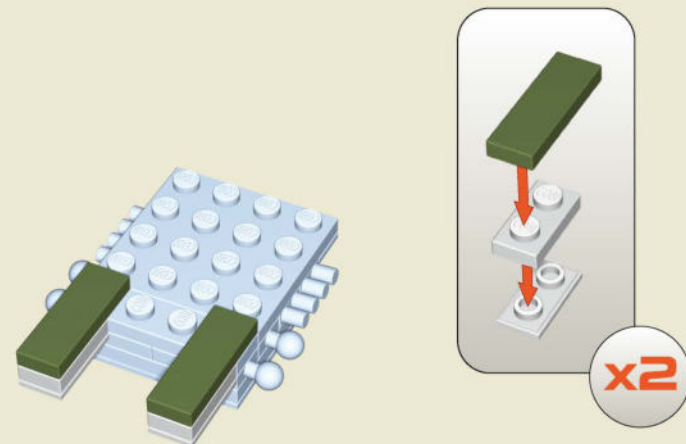

x2

x2

x2

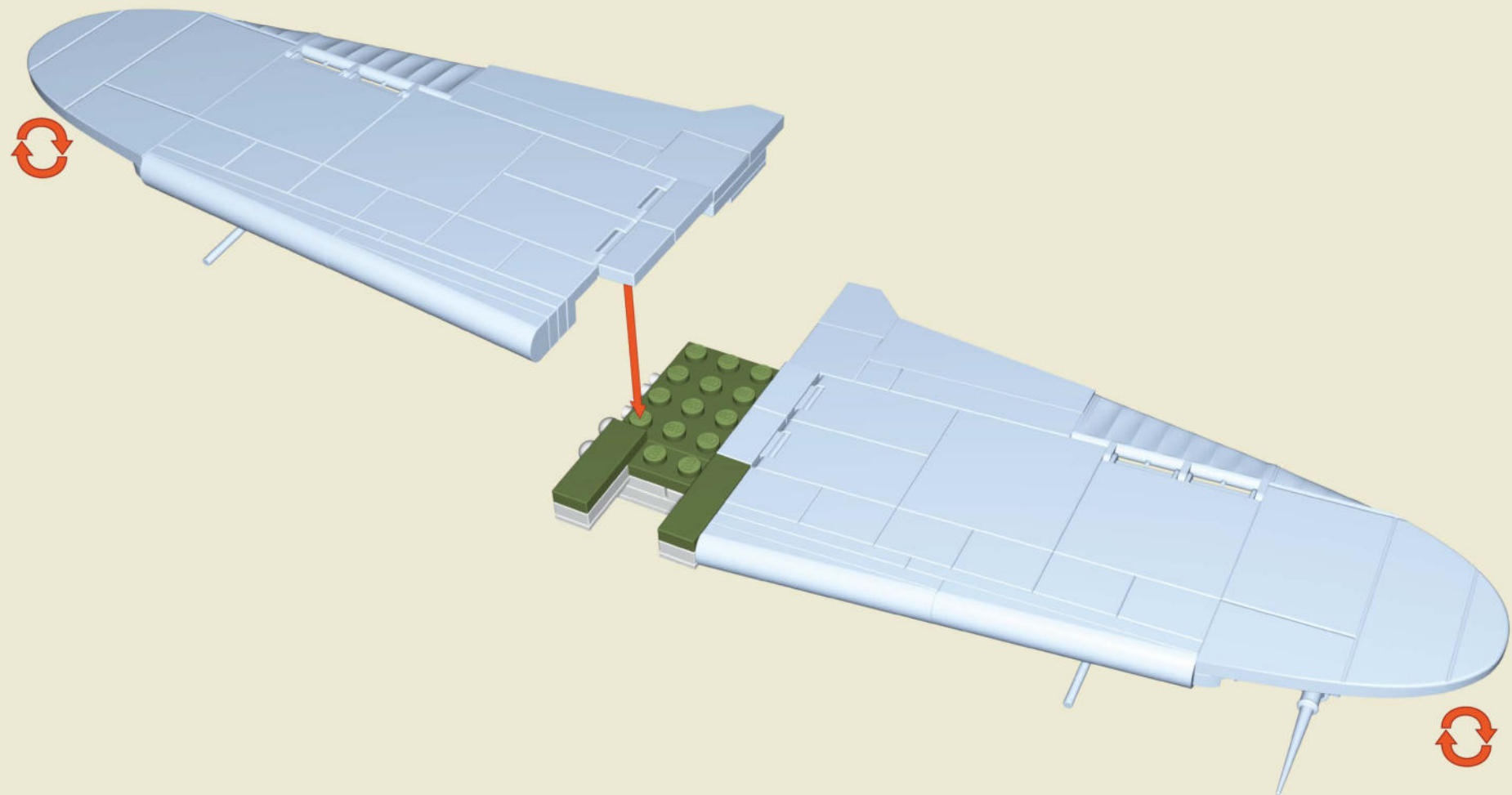

1:1

x2

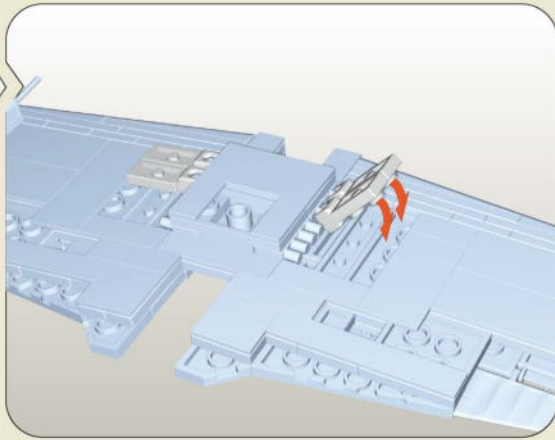
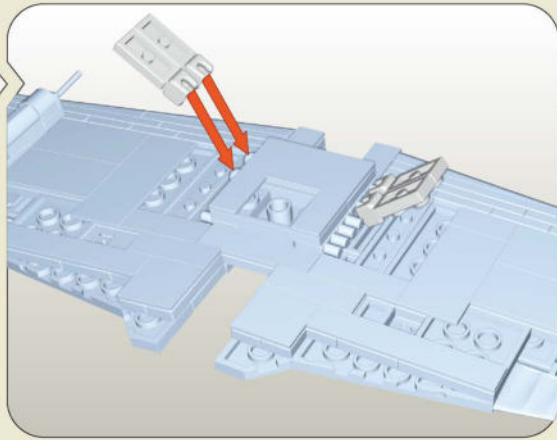
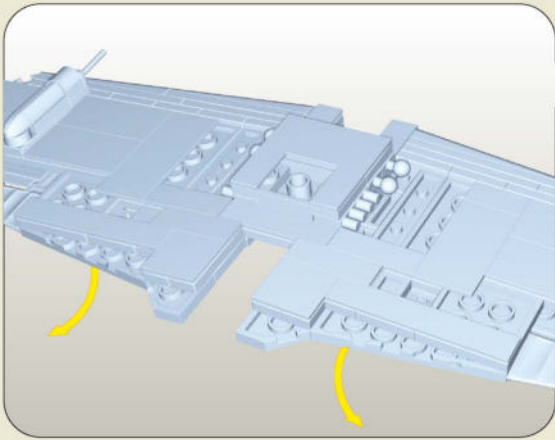

61



-  x4
-  x2
-  x2

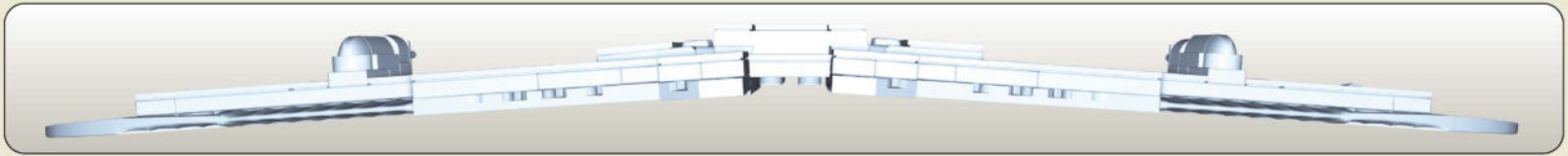
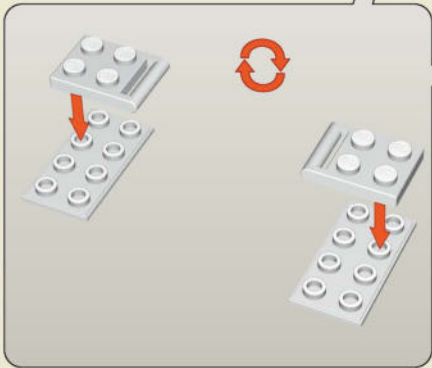
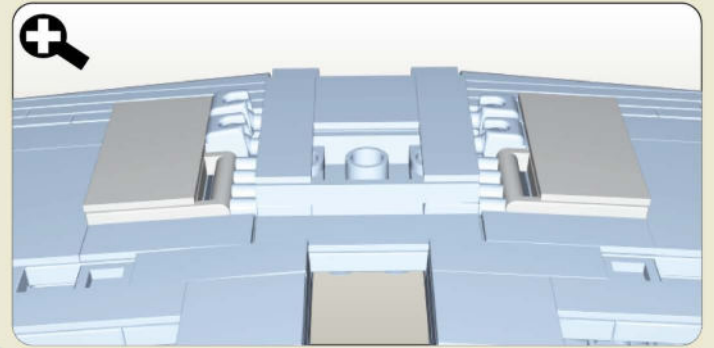
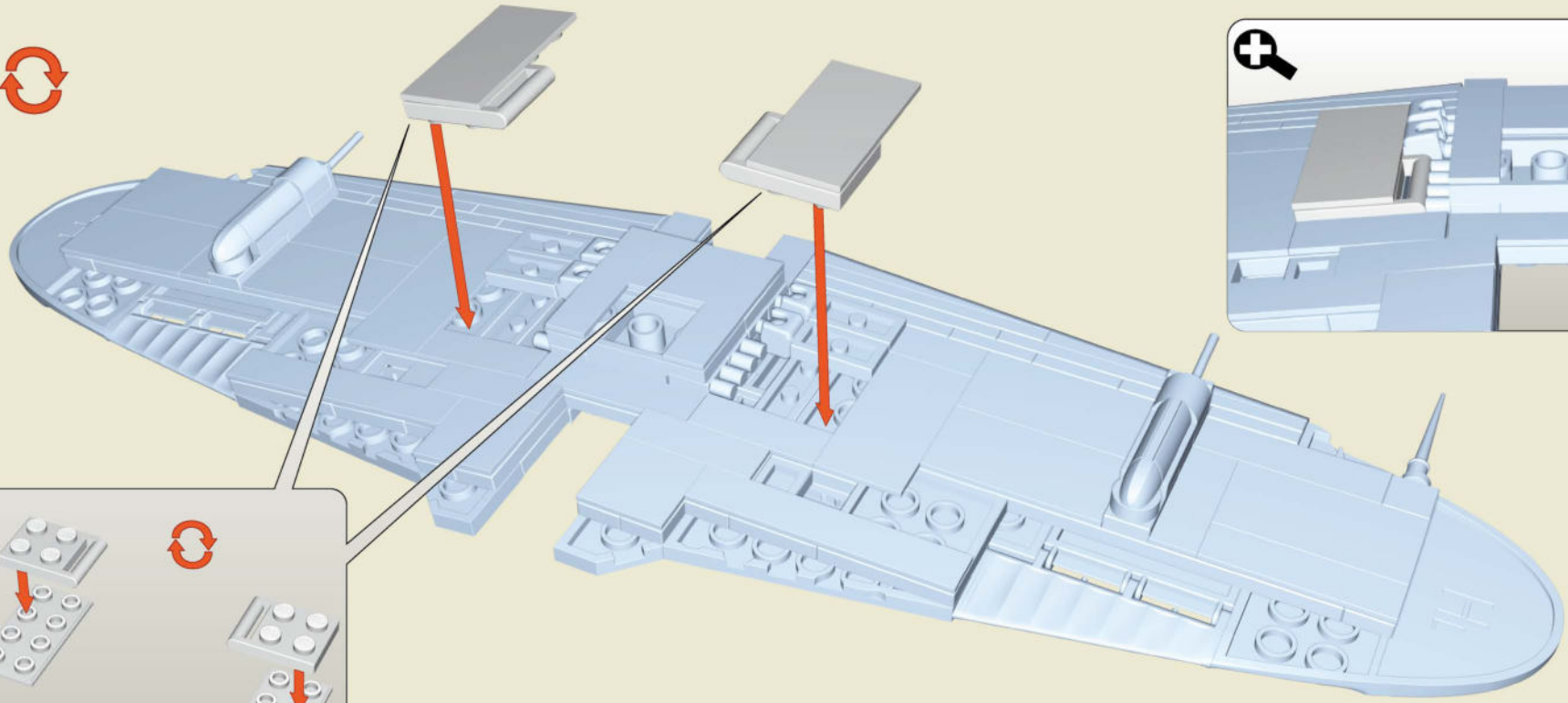

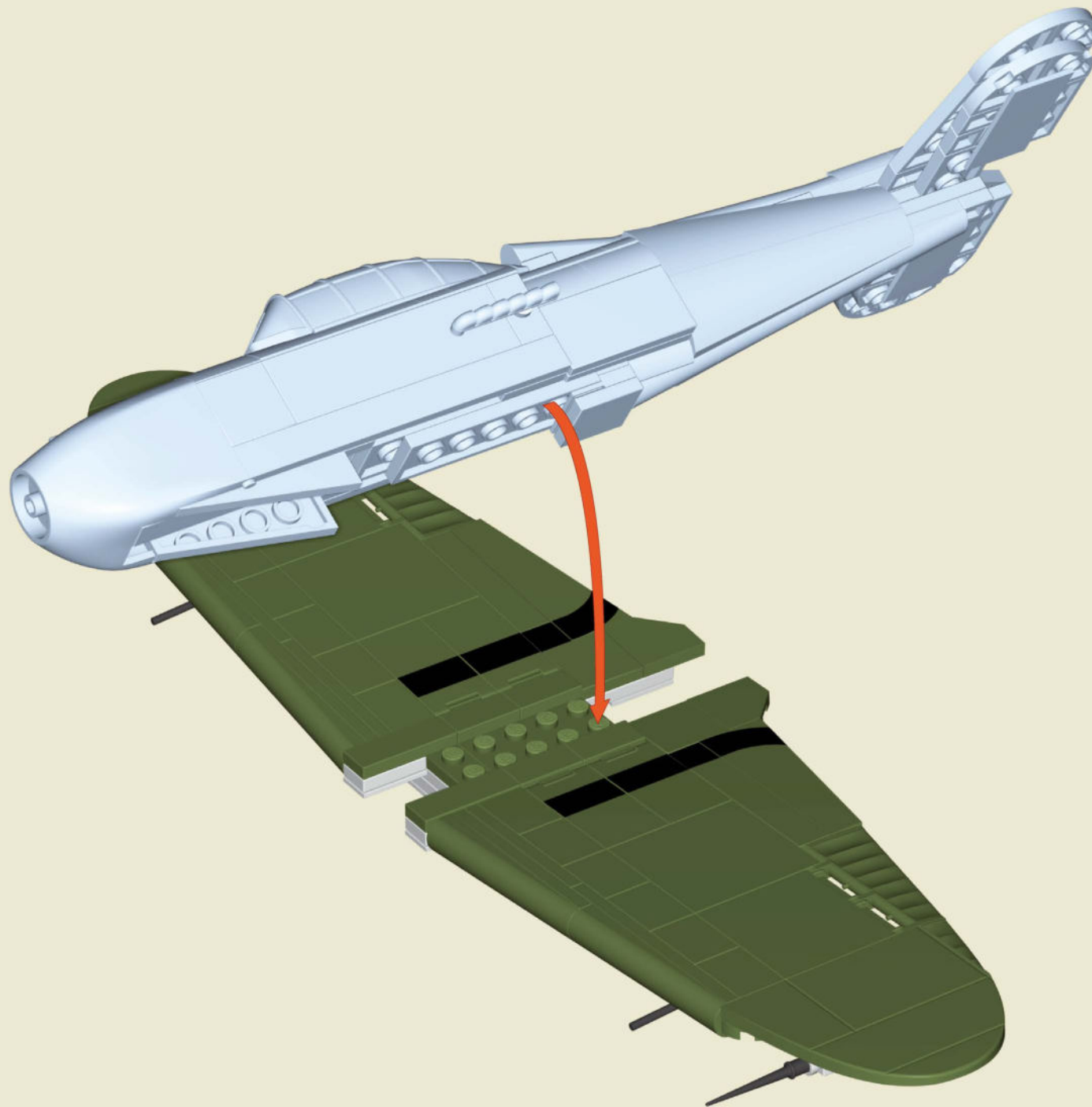

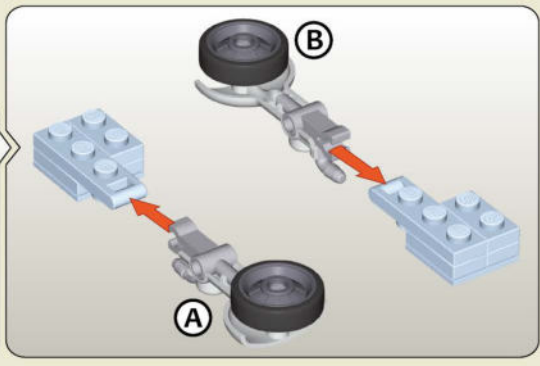
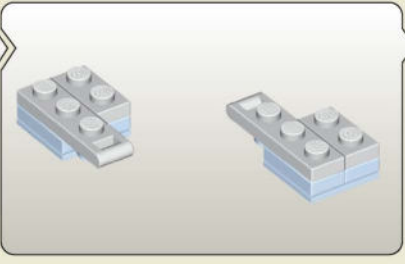
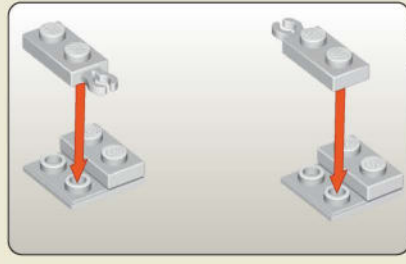
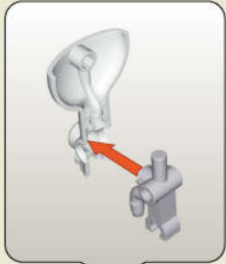
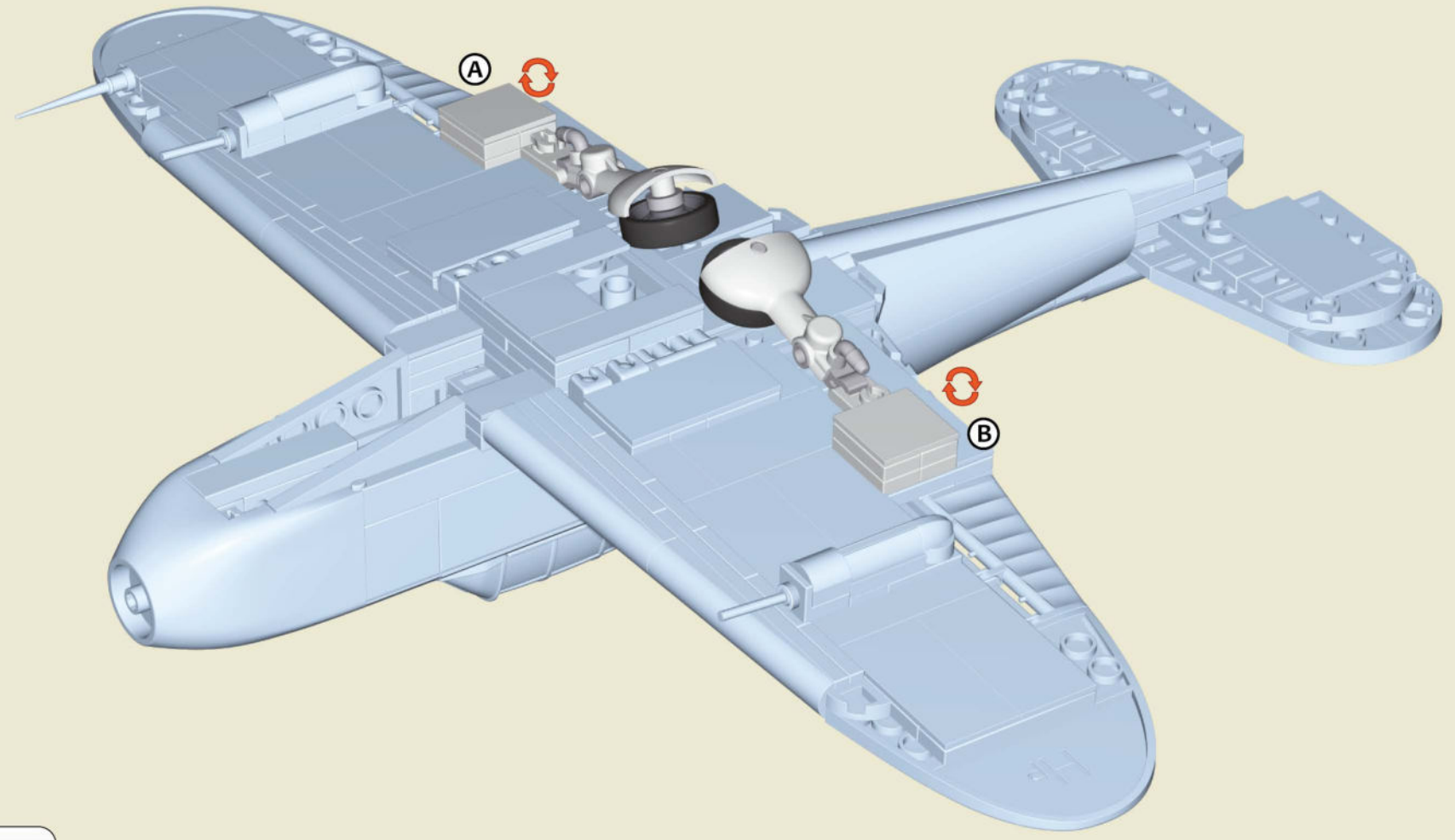



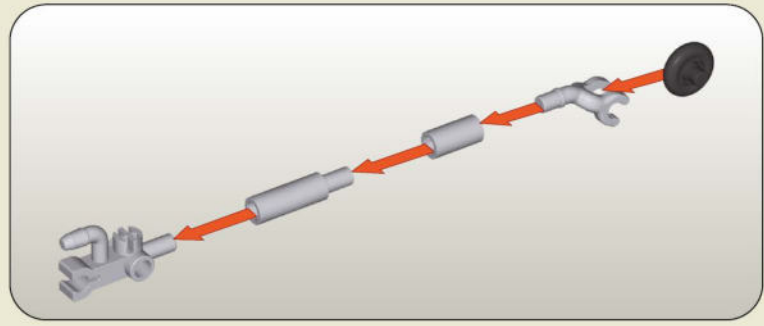
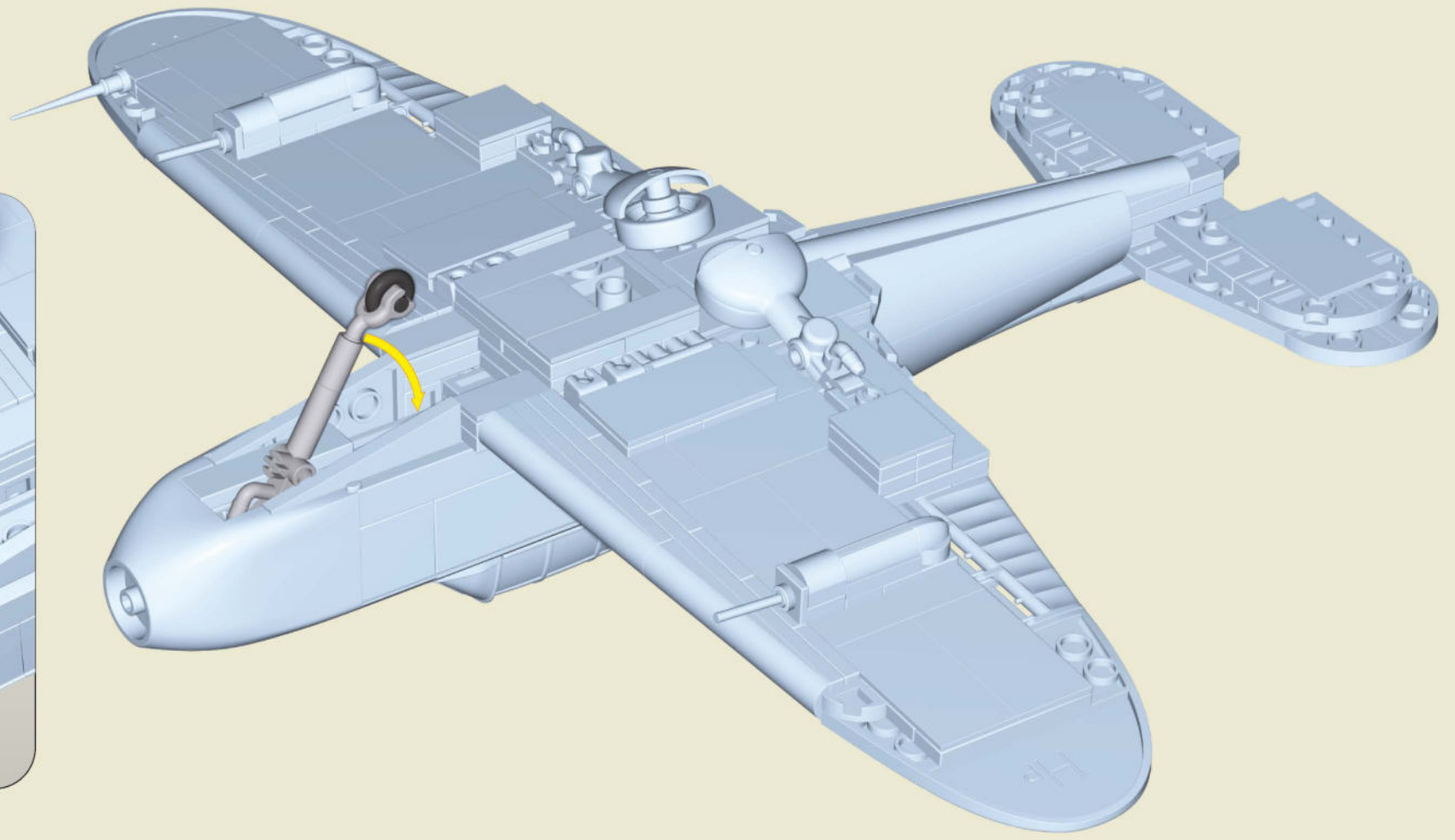
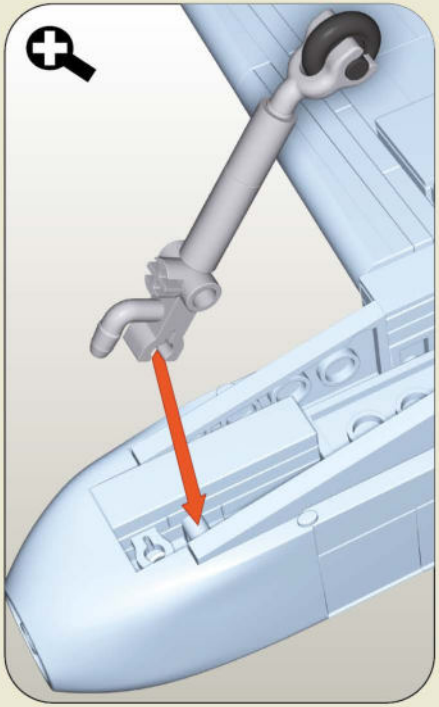

- | | | | | |
|-----------|-----------|-----------|-----------|-----------|
| | | | | |
| x2 | x2 | x4 | x2 | x2 |
| | | | | |
| x2 | x2 | x2 | x2 | |



- | | | |
|---|---|---|
|  |  |  |
| xl | xl | xl |
|  |  | |
| xl | xl | |

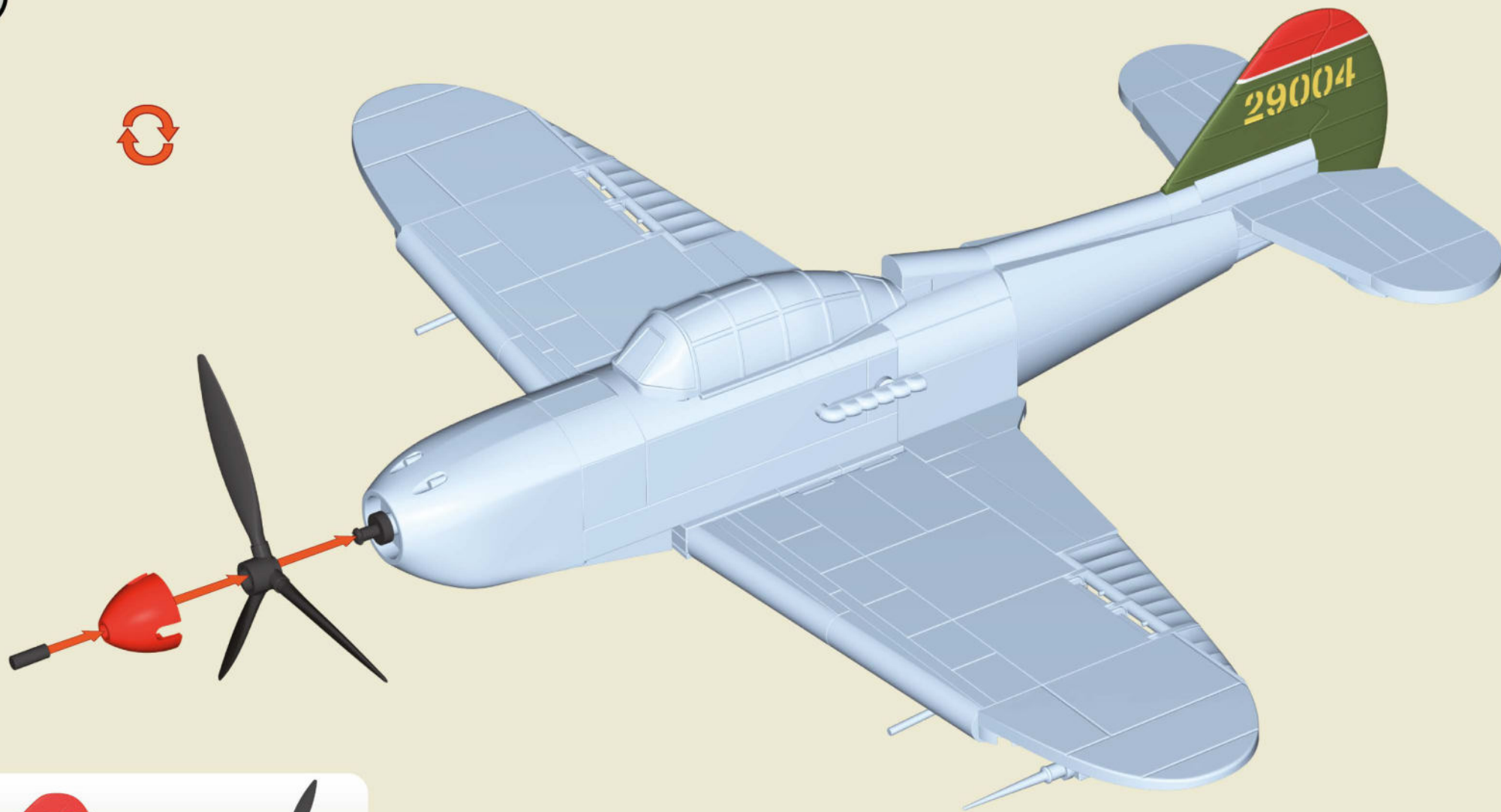

x1



x1



x1



x1



x1

66

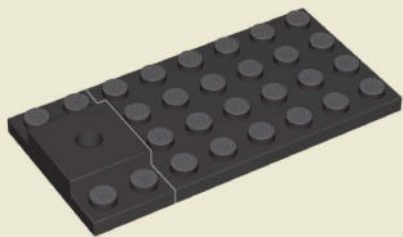

67

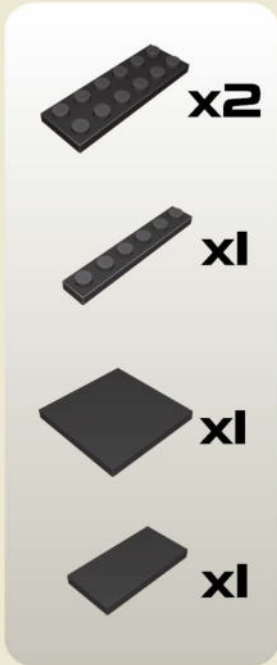
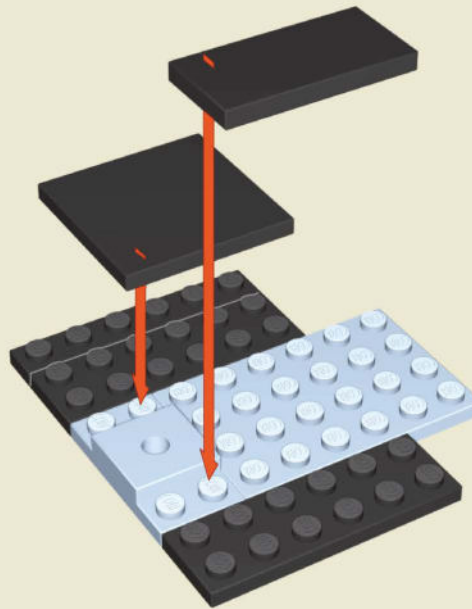

68

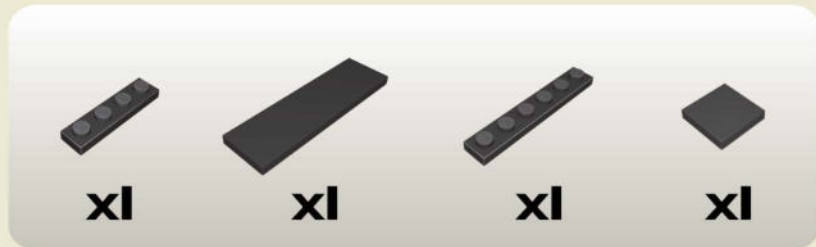
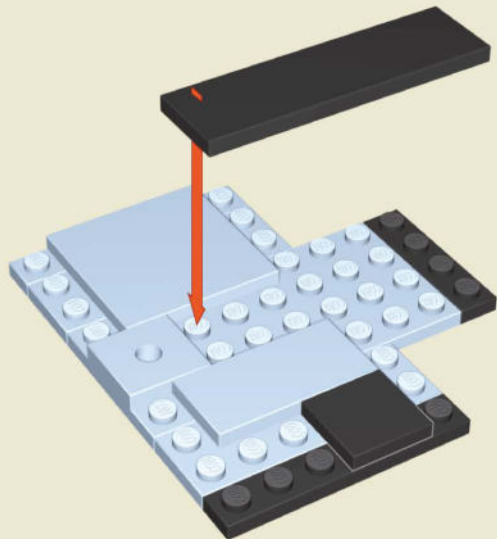

69

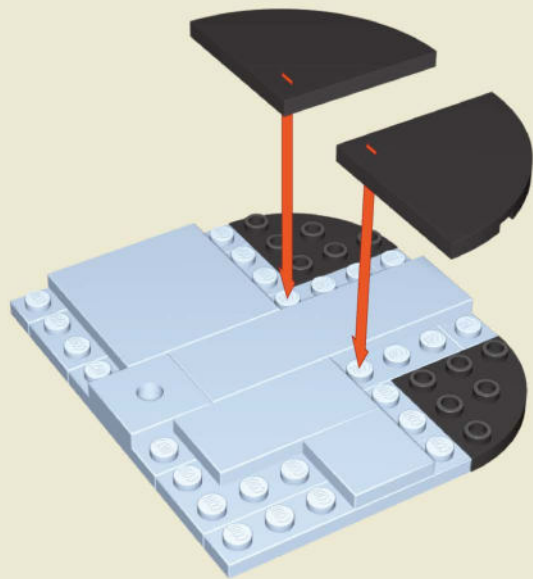

70

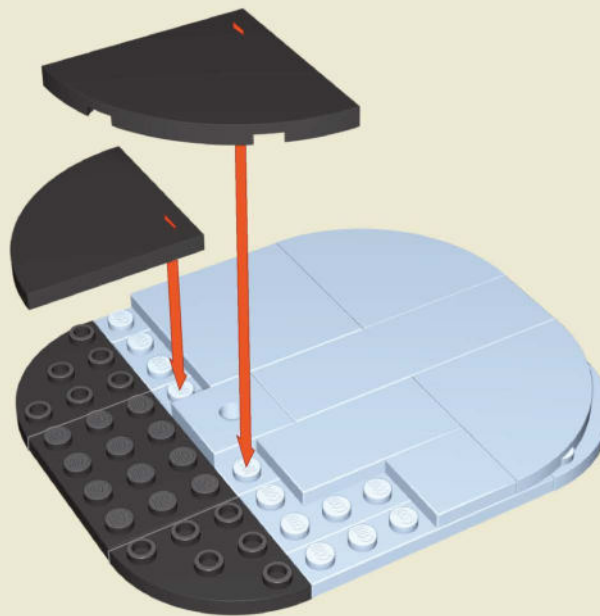

71

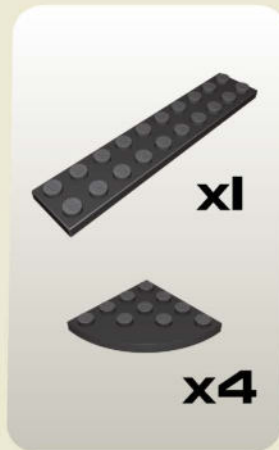
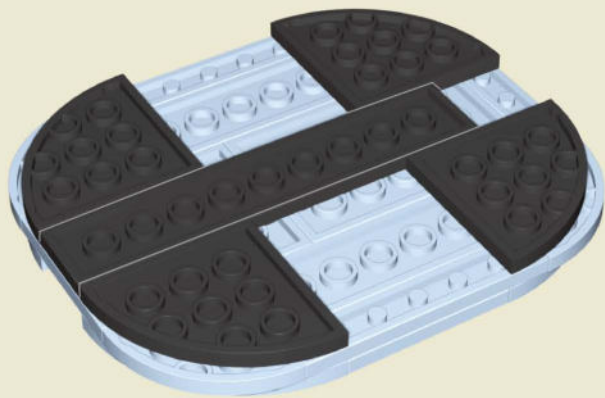

72



1:1

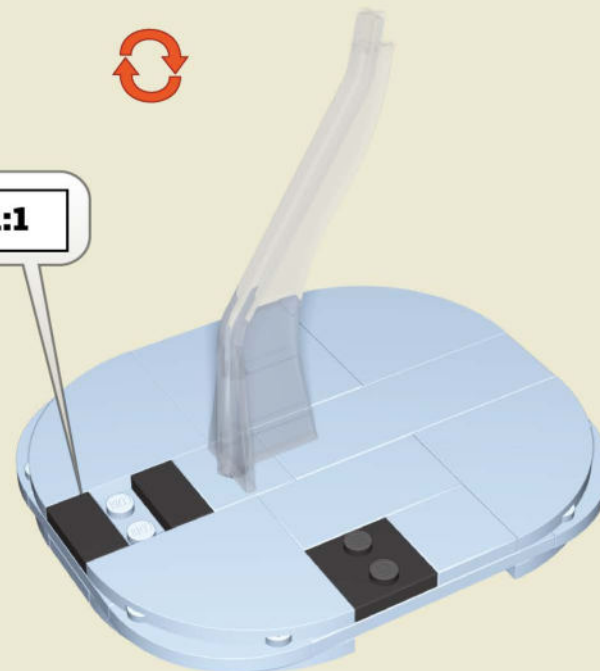

73

		
x2	x1	x1

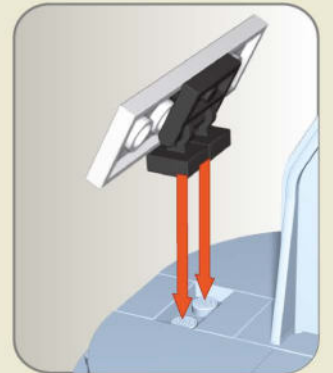
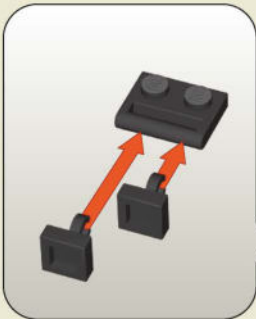
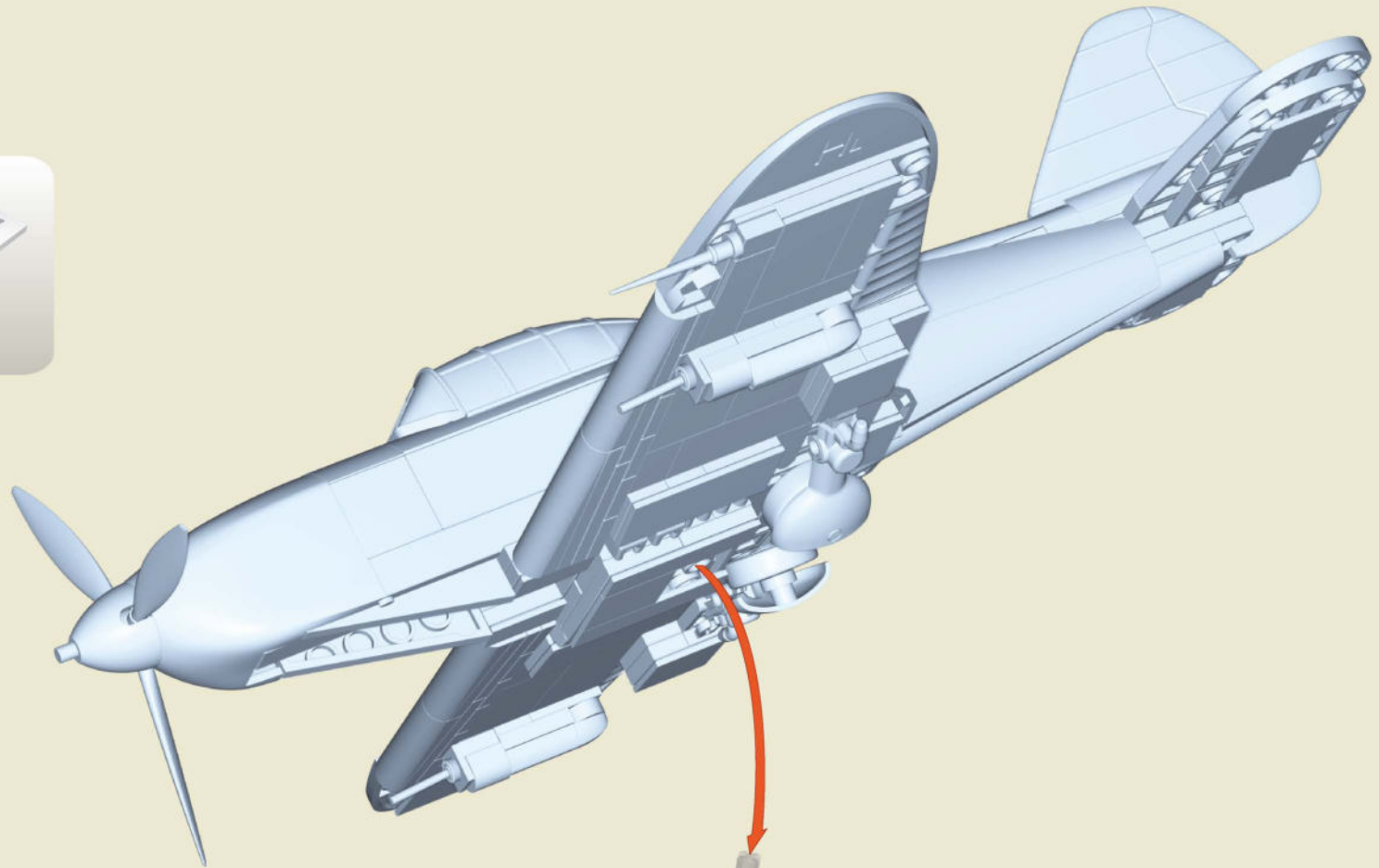

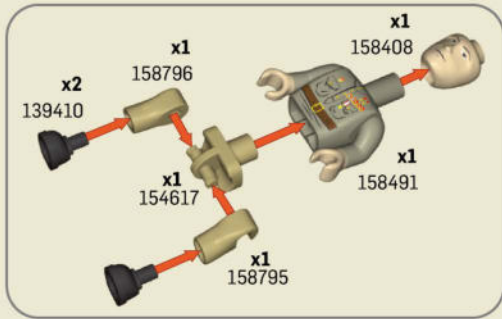

x2 141421	x2 110093	x2 92879	x6 44014	x2 157710	x1 86093	x2 114598	x2 125135	x4 134796	

x2 42875	x2 42880	x2 150425	x1 158620	x2 44969	x8 93052	x1 115046	x2 142502	x2 72799	

x1 128527	x2 138721	x8 92647	x10 42931	x2 42913	x4 92648	x3 104956	x12 142143	x2 45158	x2 45540	x2 117265	x4 146280

x3 132329	x4 146290	x3 42952	x2 118291	x4 83632	x3 113534	x2 73246	x1 92341	x4 114622	x4 132618	x7 92652	x4 42959

x4 93457	x4 122007	x1 158753	x5 120912	x1 42974	x1 92653	x6 42976	x2 42985	x3 135085	x3 64202	x4 134795	x3 67985

x2 85566	x2 43015	x2 92654	x4 43017	x5 158811	x2 134794	x3 74222	x3 43048	x2 70940	x2 43084	x4 129065	x4 138717

x6 92884	x1 43112	x1 92891	x5 43114	x4 80920	x1 122046	x1 123424	x2 118379	x1 77542	x1 77515	x1 43075	x5 122048

x1 121252	x1 141688	x5 43154	x2 86989	x4 158754	x1 92898	x1 43172	x2 43174	x1 92668	x1 118243	x1 118244	x10 119721

x1 121337	x2 107858	x1 157413	x1 157414	x2 43192	x1 43194	x1 158756	x1 158757	x1 158758	x2 158755	x1 120212	x2 108324

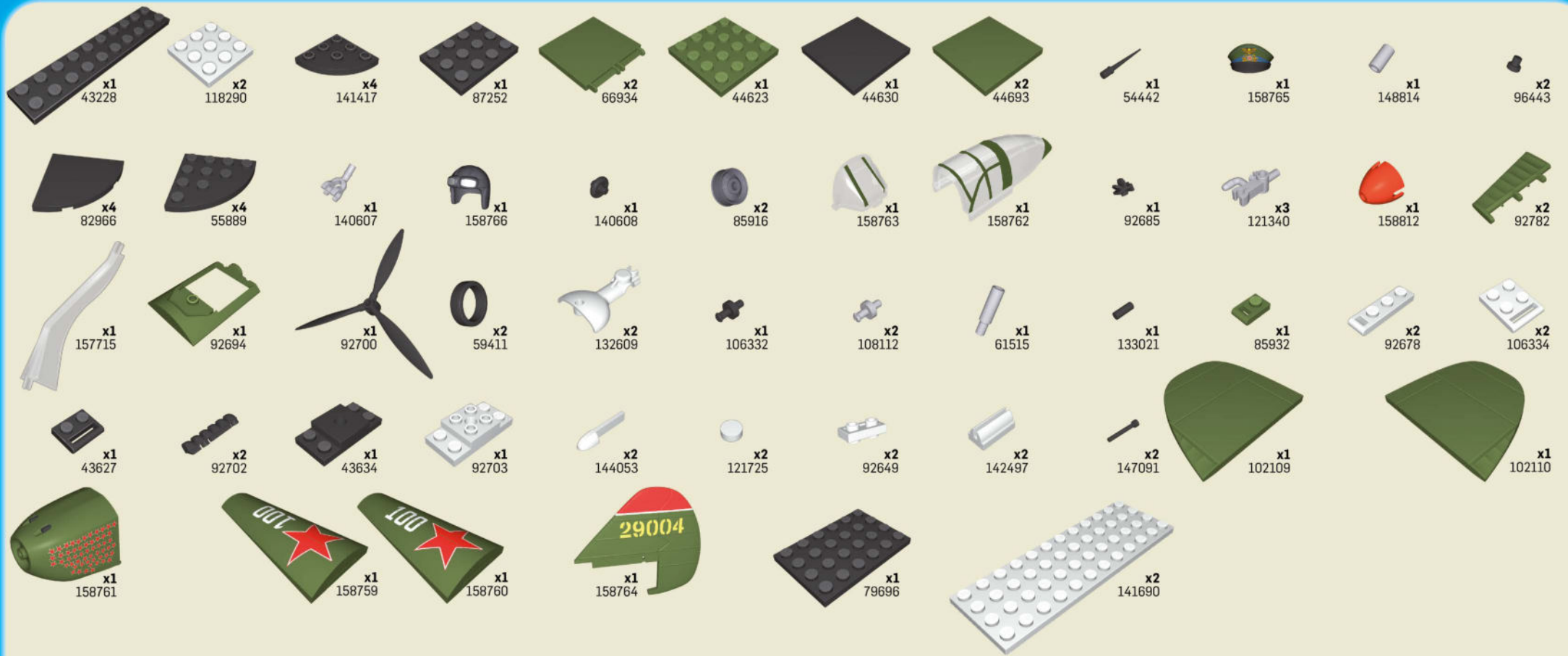



HISTORICAL COLLECTION



FOCKE-WULF FW 190 A-3
+ 5741



ILYUSHIN IL-2 (1943)
★ 5745



PZL P.11c
☐ 5742

NORTHROP GRUMMAN



P-47 THUNDERBOLT™
⊙ 5737



For news and special deals

Find us on:
f cobibricks
i cobiklocki
y COBI SA

WWW.COBIBRICKS.COM

01-05747-368