

# HISTORICAL COLLECTION

## WORLD WAR II



**NORTHROP  
GRUMMAN**

Manufactured under license from Northrop Grumman Systems Corporation. GRUMMAN® TBF Avenger™ is a trademark of Northrop Grumman Systems Corporation.

GRUMMAN™ TBF AVENGER™	
PLACE OF ORIGIN - UNITED STATES	
IN U.S. SERVICE - 1942 - 1950s	
ROLE - TORPEDO BOMBER	
WINGSPAN - 16,5m (54' 2")	
LENGTH - 12,2m (40')	
HEIGHT - 6m (16' 5")	
EMPTY WEIGHT - 4 853kg (10 700lb)	
ENGINE - WRIGHT R-2600-8, 1 268kw (1 700hp)	
RANGE - 1 819km (1 130mi)	
RATE OF CLIMB - 5,44m/s (1 075ft/min)	
MAXIMUM FLIGHT LEVEL - 7 132m (23 400ft)	
ARMAMENT - 3x 12,7mm (.50") M2 HMG, 1x 7,62mm (.30") M2 MG, 907kg (2 000lb) OF BOMBS, TORPEDO OR ROCKETS	
SPEED - 430km/h (267mph)	
CREW - 3	

# 5752

Printed in EU

**PAD PRINTED**  
**NO STICKERS**



**WARNING: CHOKING HAZARD-**

Toy contains small parts.

Not for children under 3 years.



**UK  
CA**



**392**  **1** 

**GRUMMAN® TBF AVENGER™**

**SCALE 1:48**



**BE CAREFUL:  
NOTICE THE DIFFERENCE**

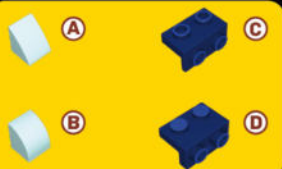

**UWAGA: RÓŻNE KLOCKI**

**DISCONNECT THE BRICKS**



**x4**



**x1**

**ROZŁĄCZ KLOCKI**

**1**

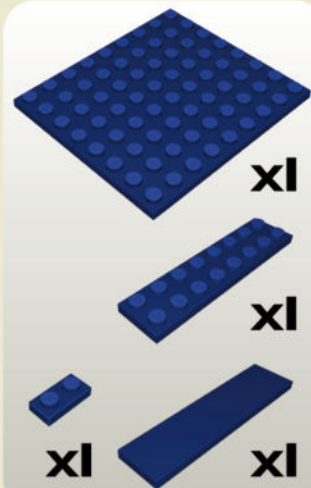
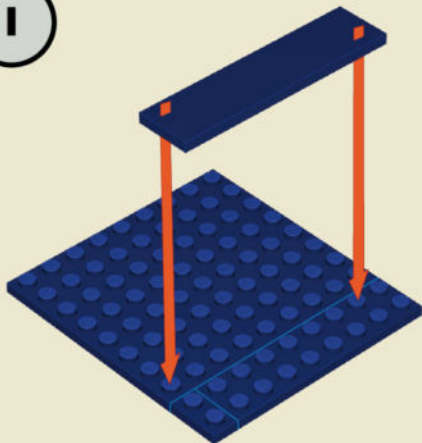

**2**

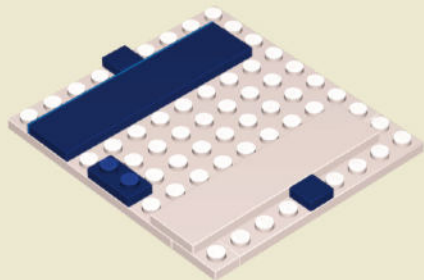

**x2**



**x1**



**x1**

**3**

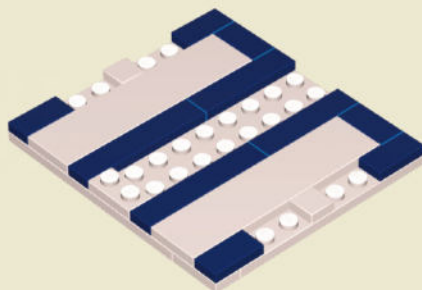

**1:1**

**1:1**

**1:1**



**x6**



**x2**



**x2**

4

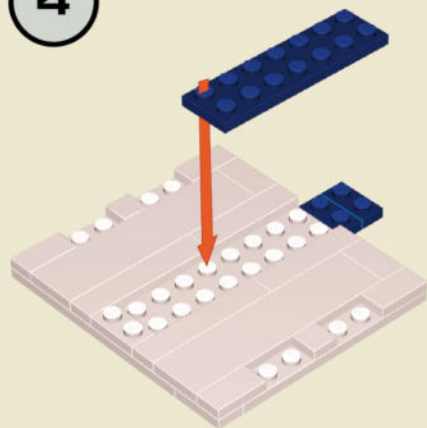

5

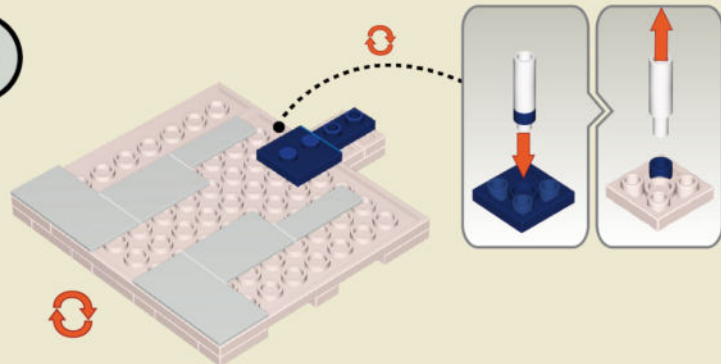

6

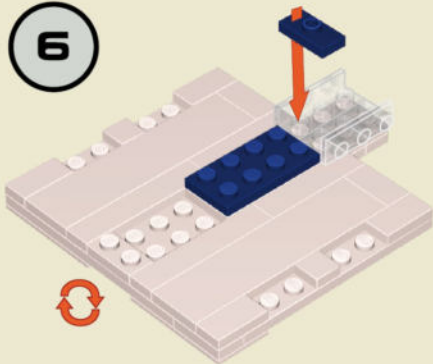

7

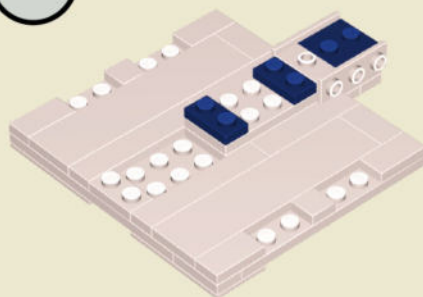

8

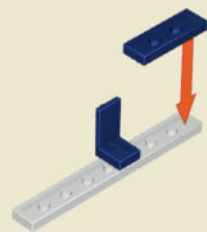

9

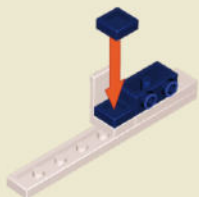

10

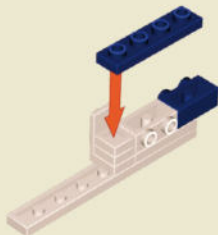

11

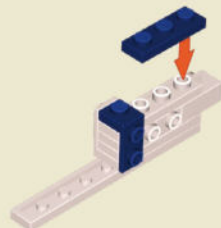

12

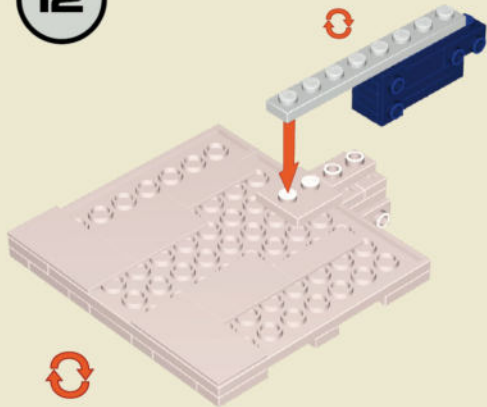

13

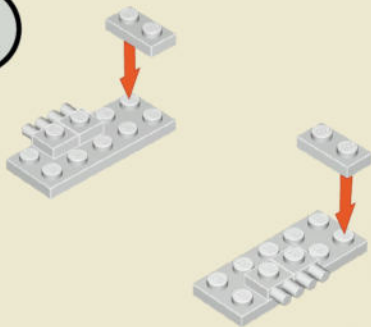

14

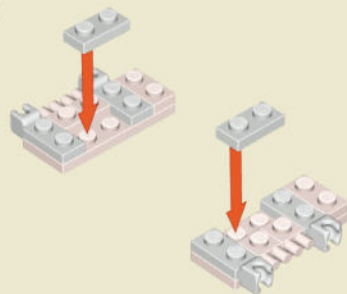

15



x2

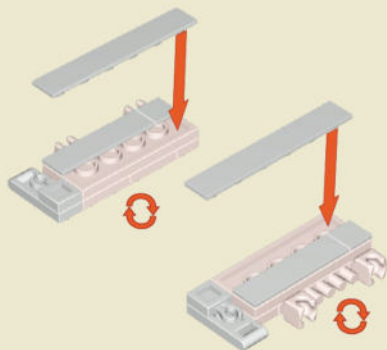

16

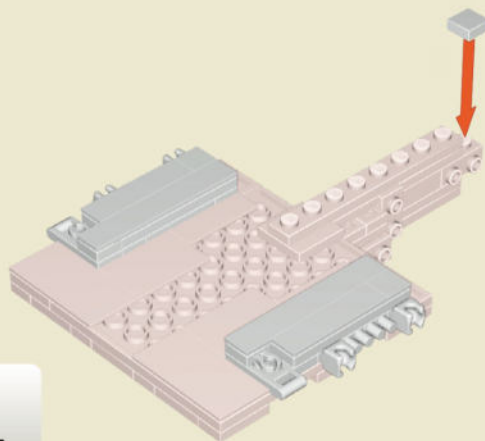

17

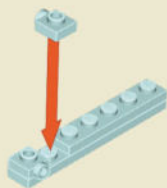

18

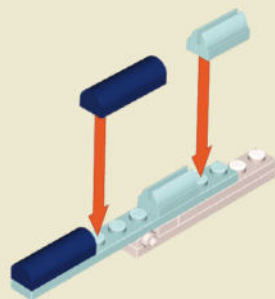

19

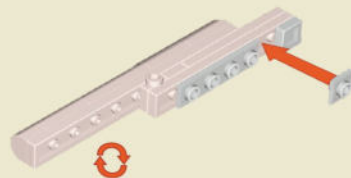



20

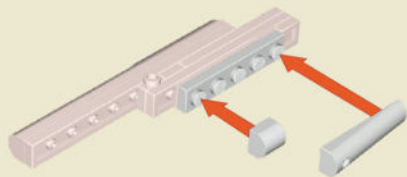

21

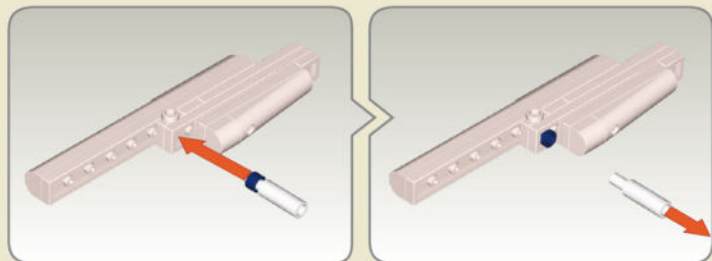

22

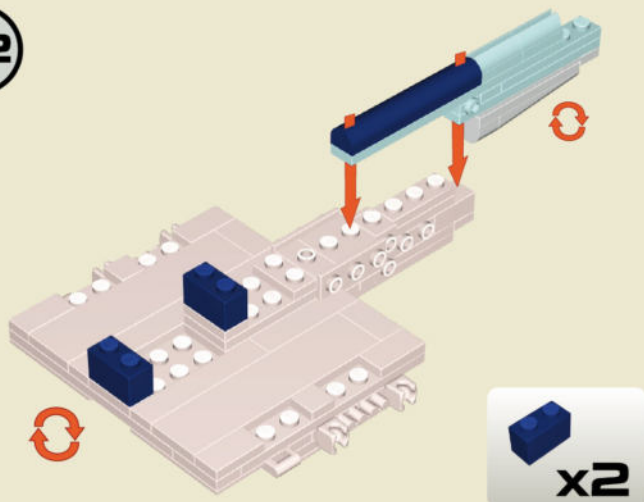

23

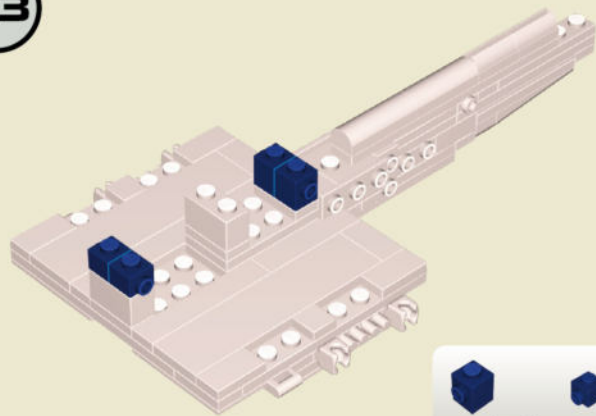

24

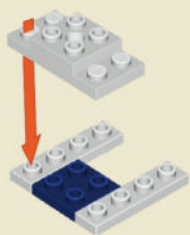

25

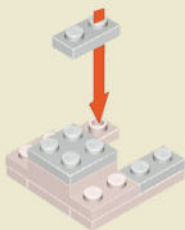

26

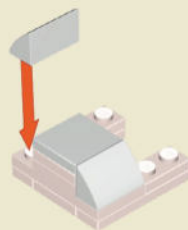

27

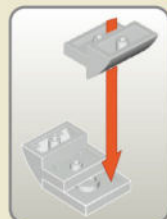
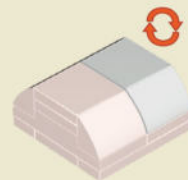

28

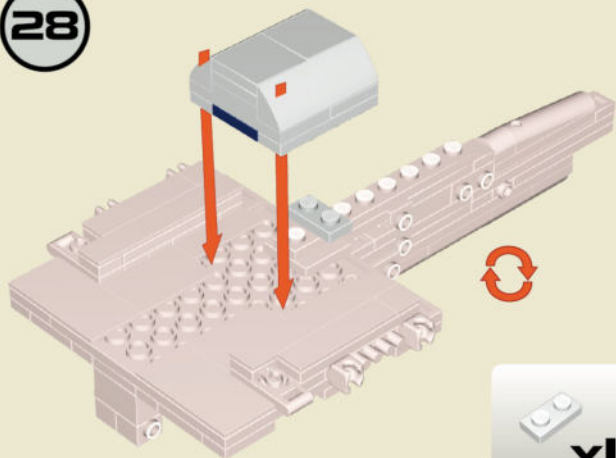

29

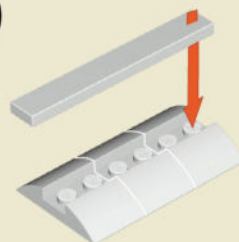

1:1



30

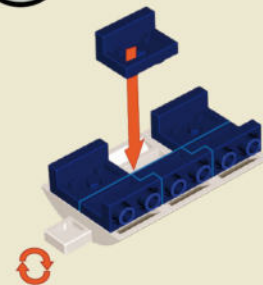

31

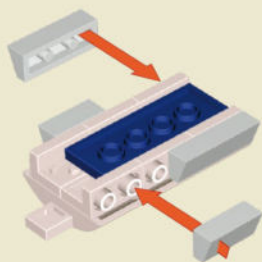

32

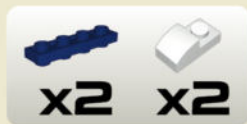
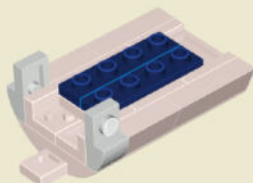

33

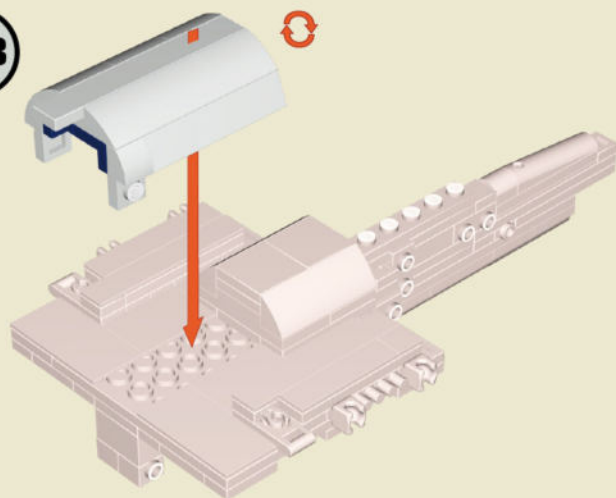

34

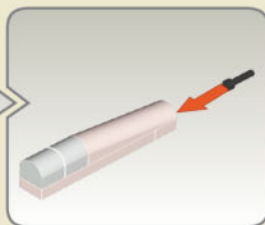
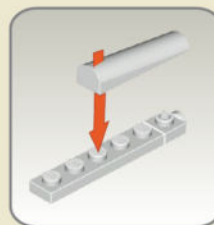
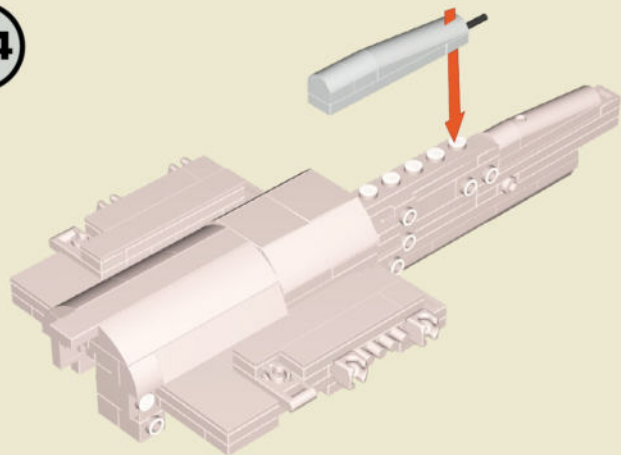



35

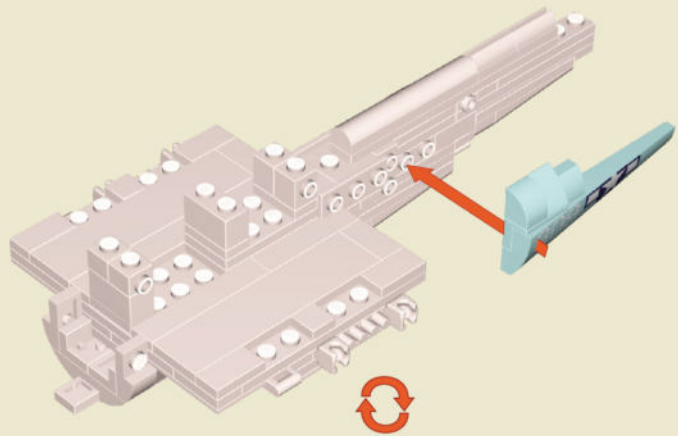
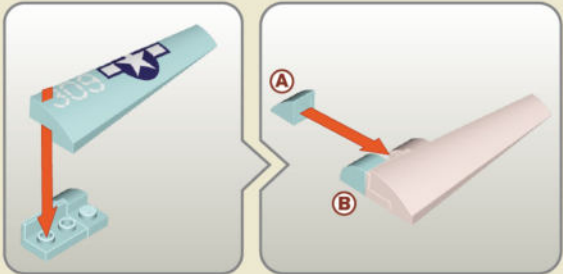

36

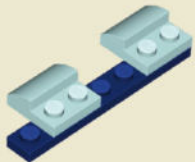

37

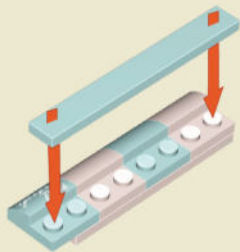

38

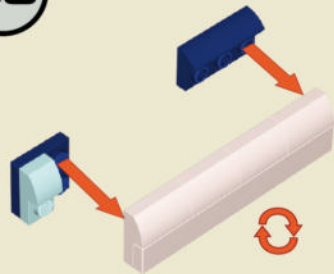

39

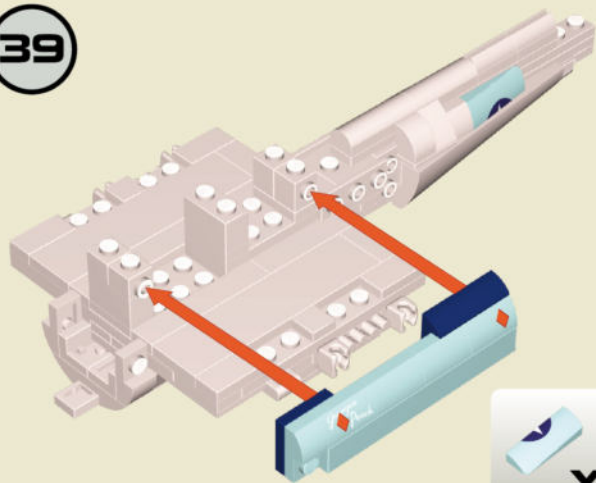

40

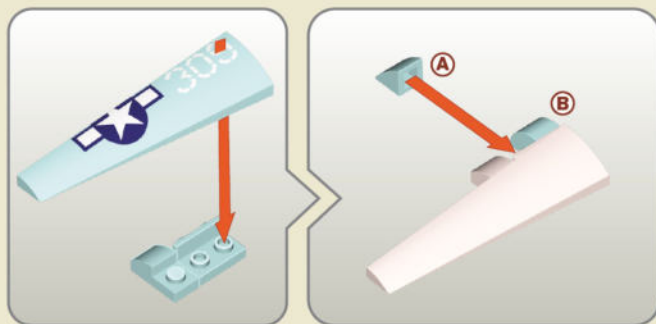

41

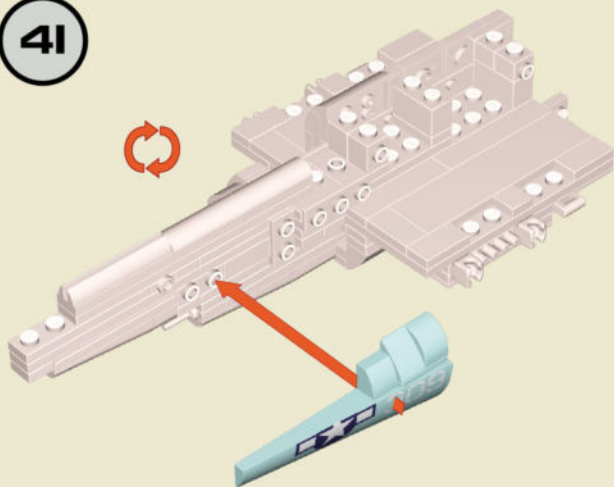

42

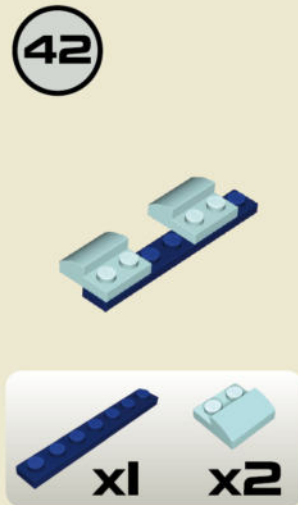

43

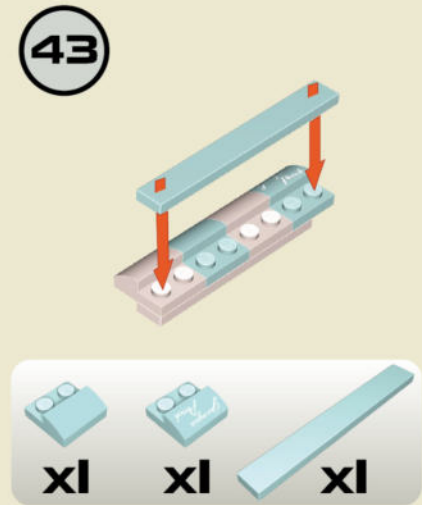

1:1

44

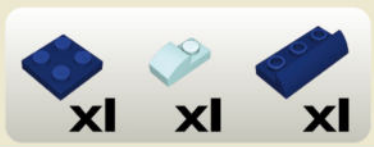
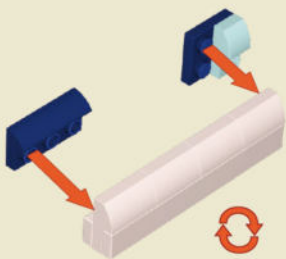

45

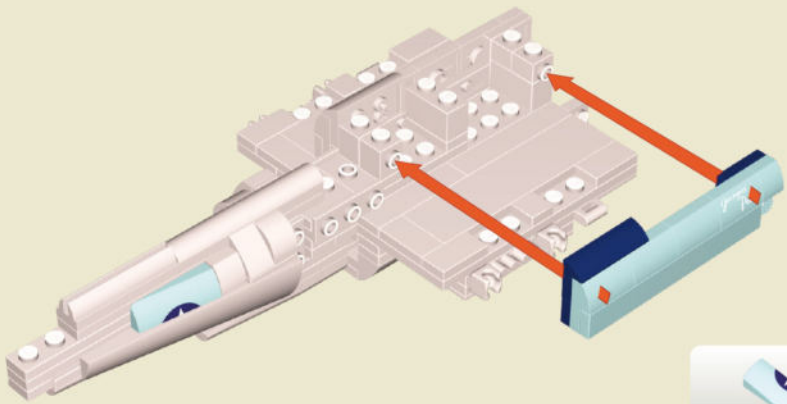

46

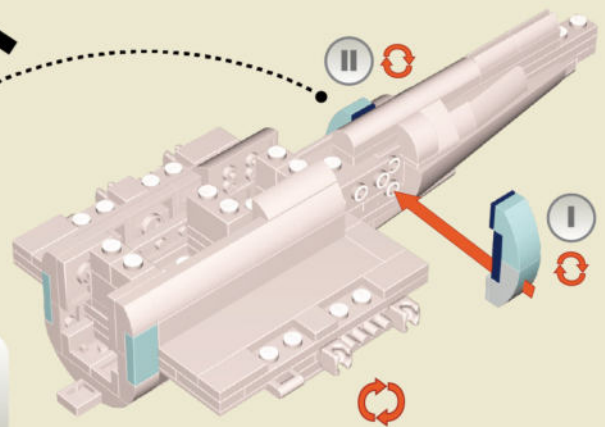
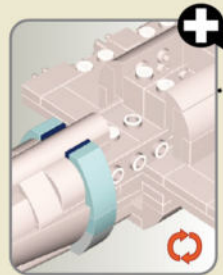
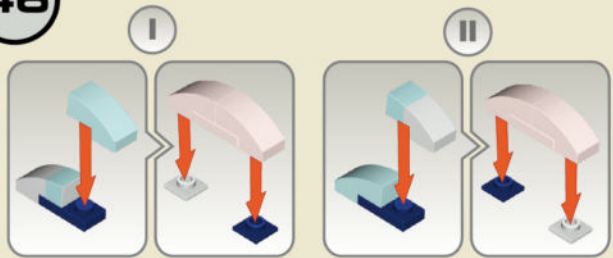

1:1





49

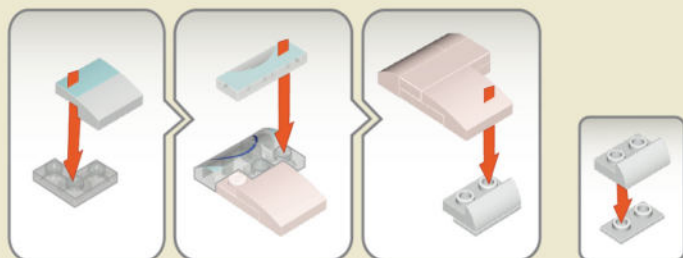
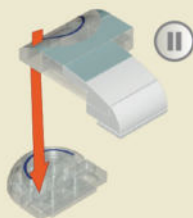
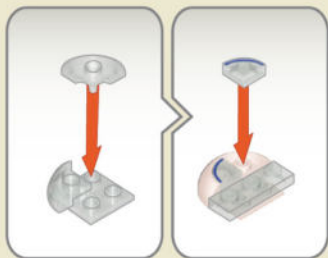

x1



x2



x2



x1



x1



x1



x1



x1



x1



x1



x1

50

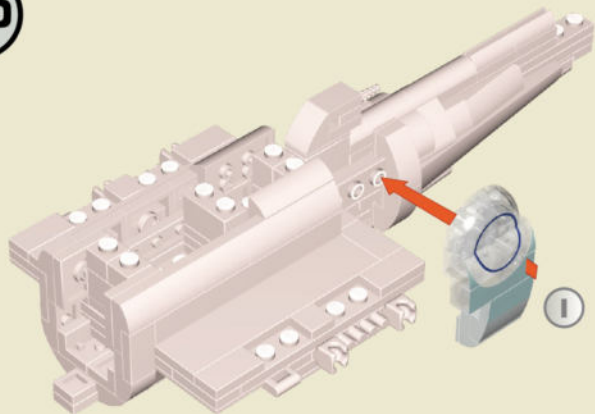

51

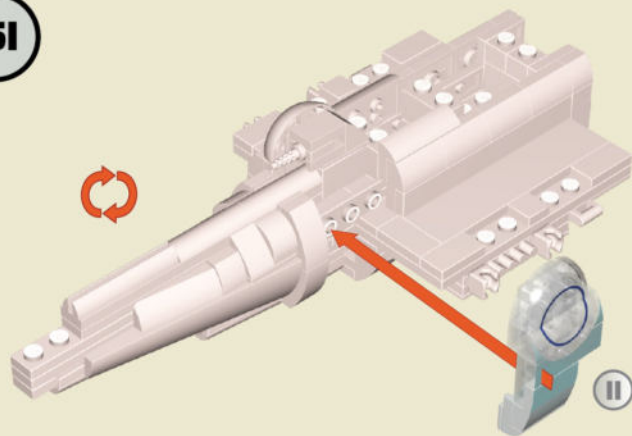





52

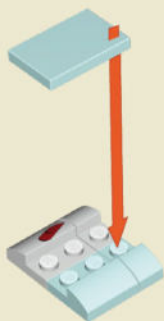

53

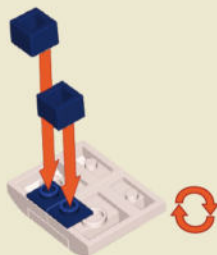

54

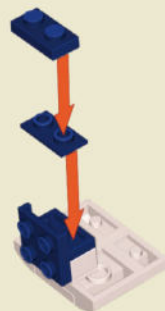

55

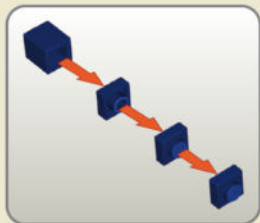
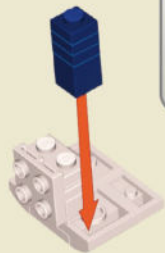

56

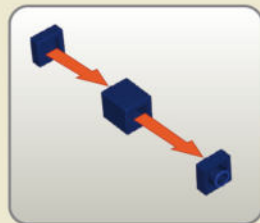

57



58

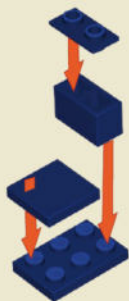

59

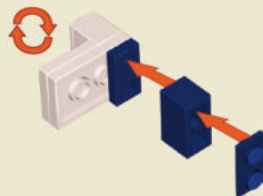

60

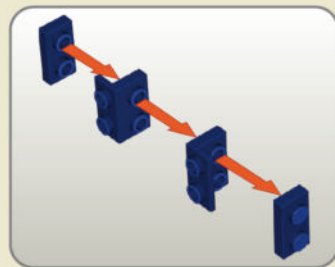
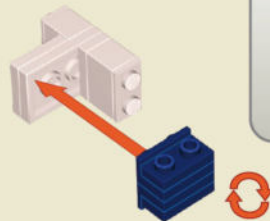

61

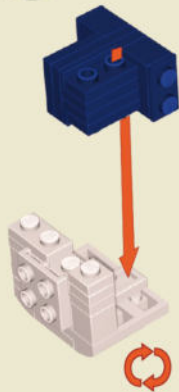

62

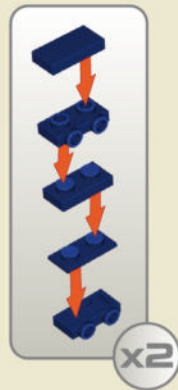
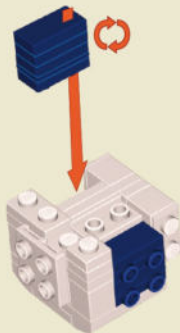

x2

1:1



63



64

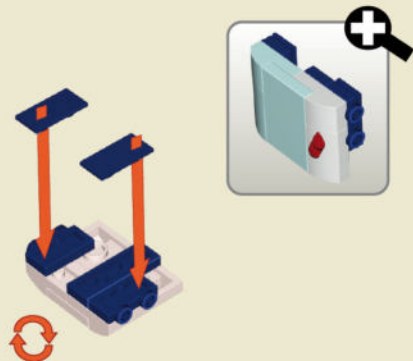

65

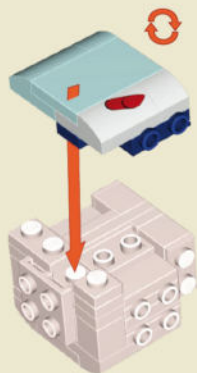

66

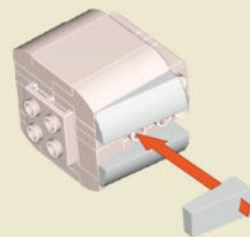

67

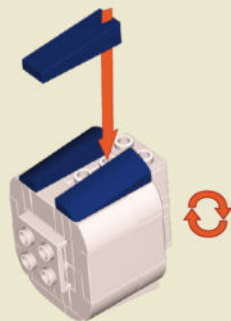

68

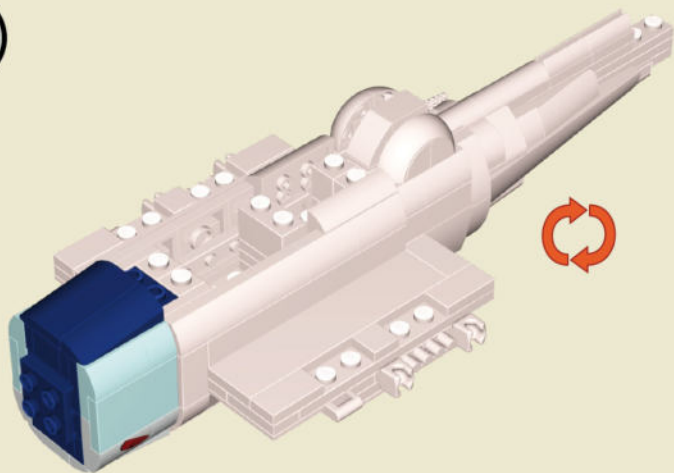

69



70

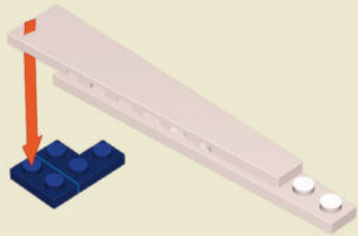
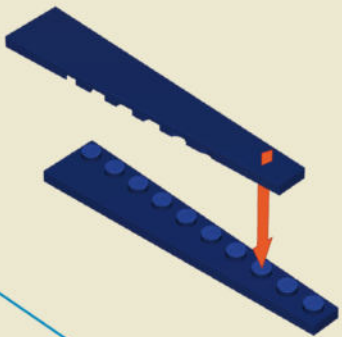
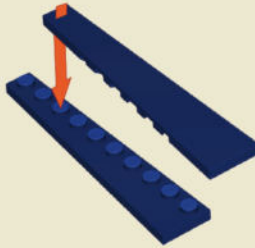
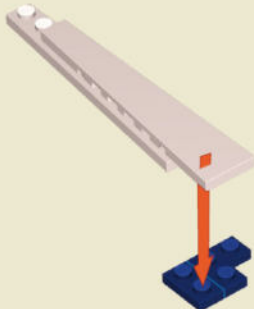

71

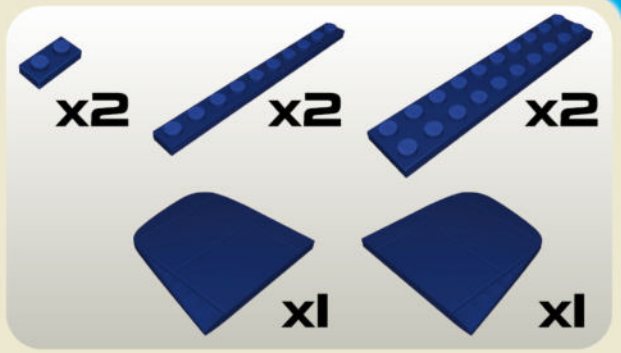
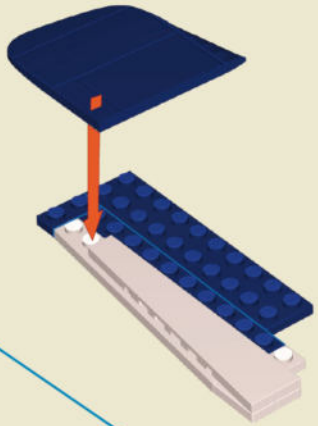

72

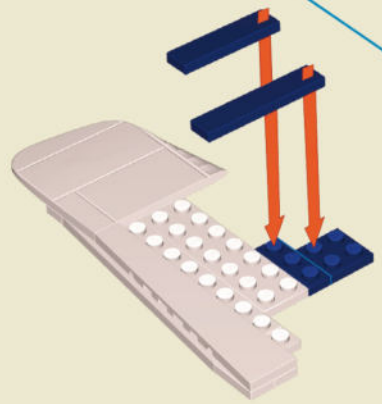

1:1

1:1

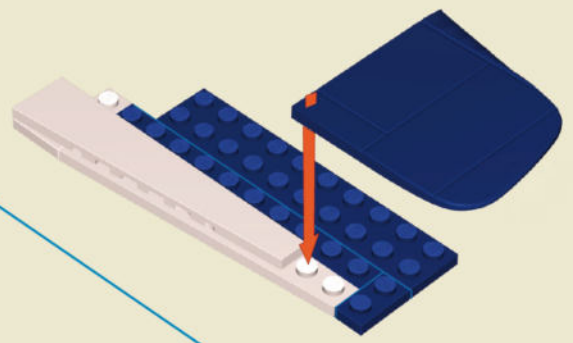
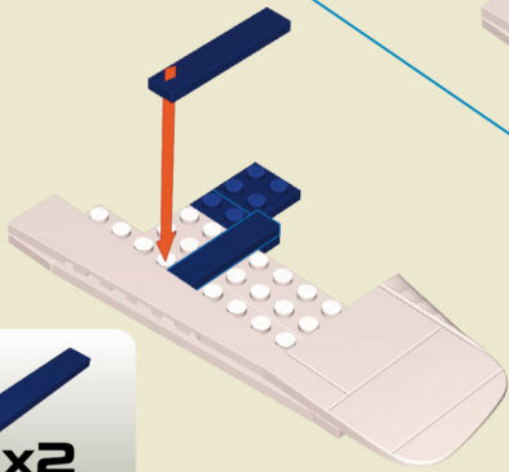



73

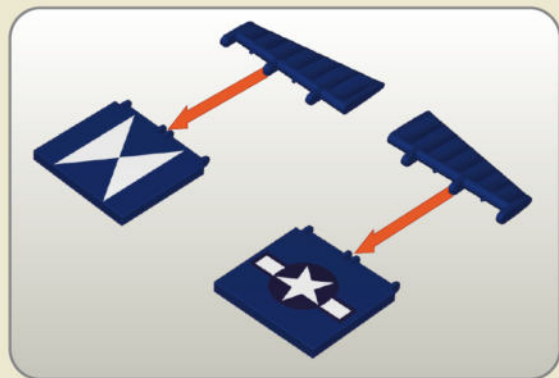
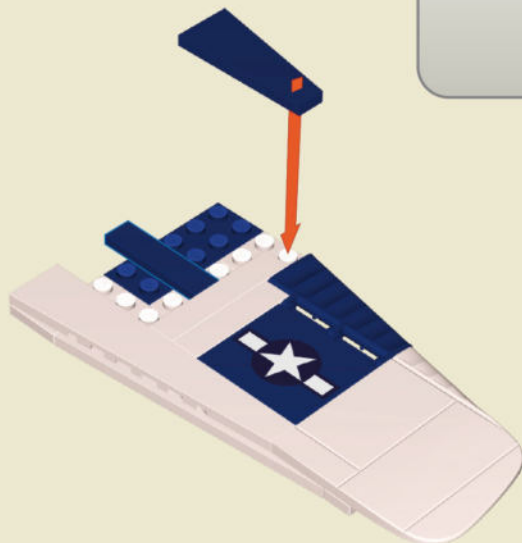
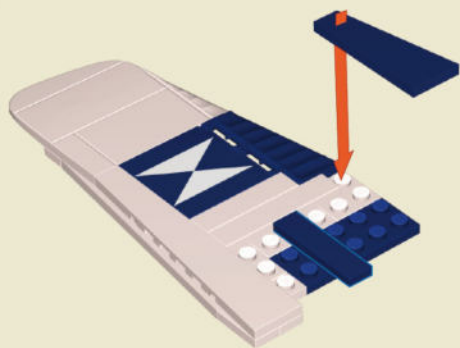

1:1

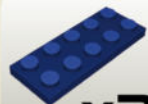

x2



x2



x1



x1



x2



x1

x1

74

75

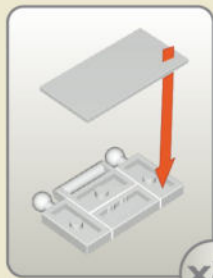
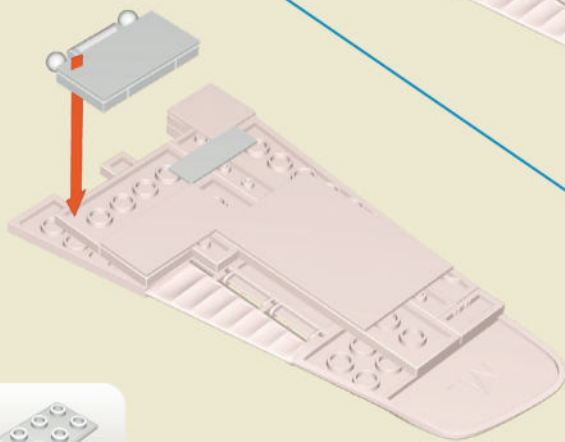
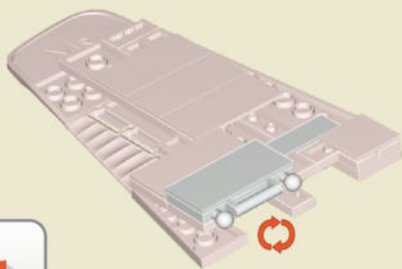
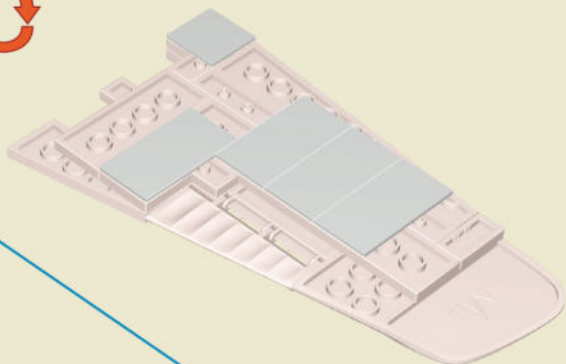
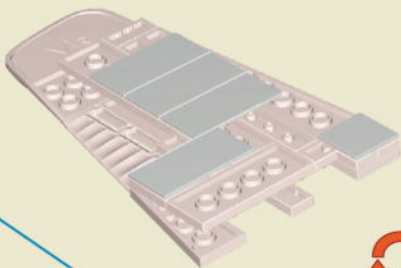

x2



x2



x4



x2



x2



x2

76

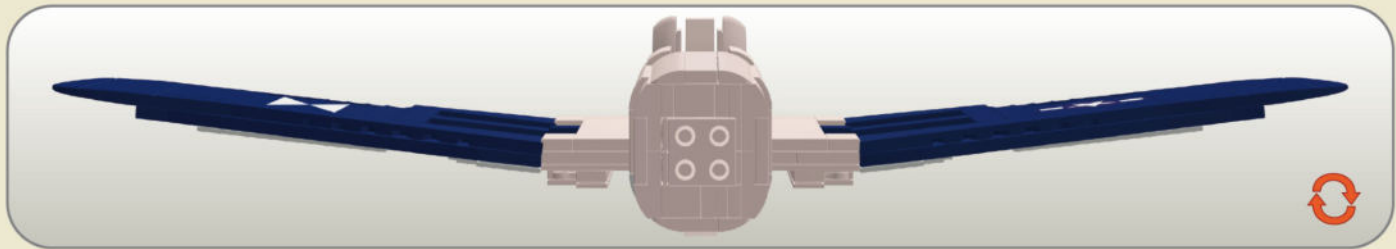
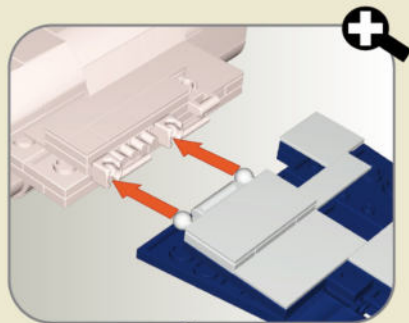
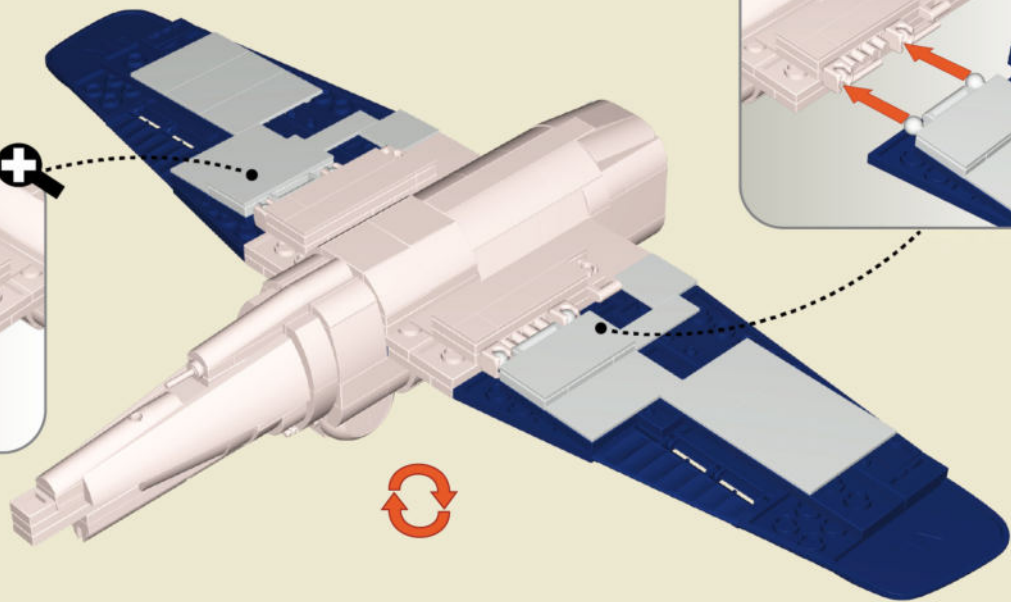
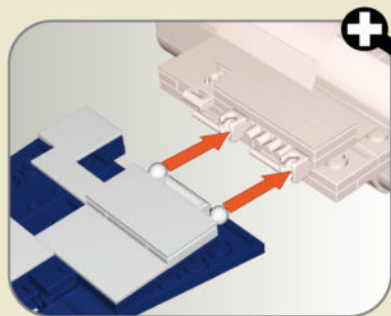

77

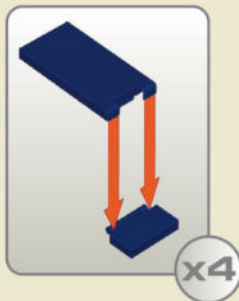

78

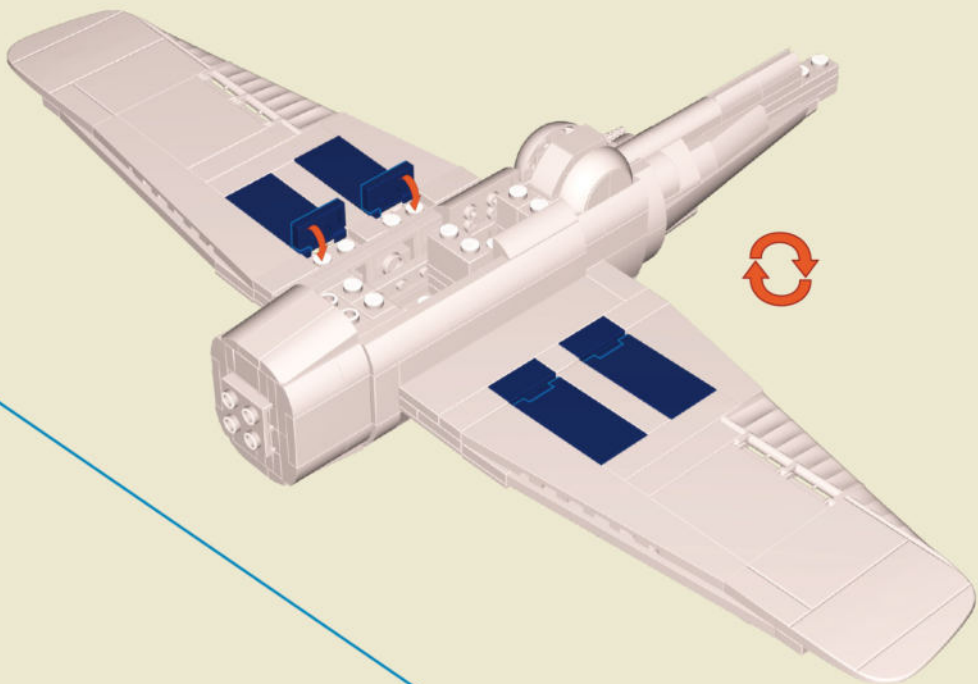
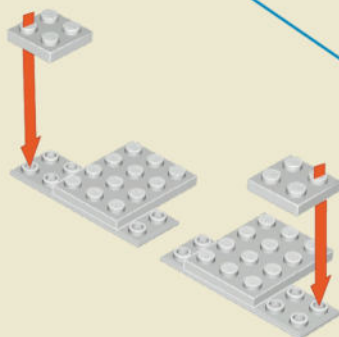

79

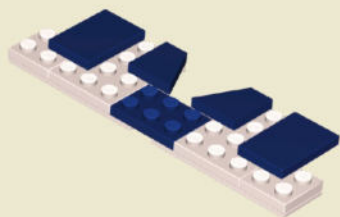

x1



x2



x1



x1

80

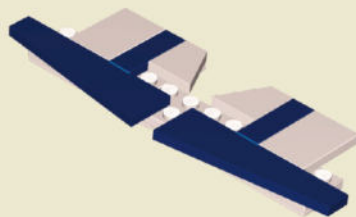

1:1



x1



x2



x1

81

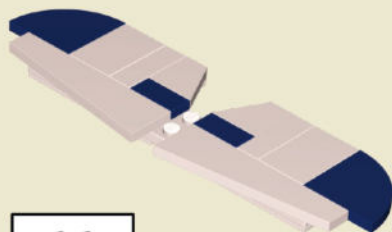

1:1



x2



x2

82

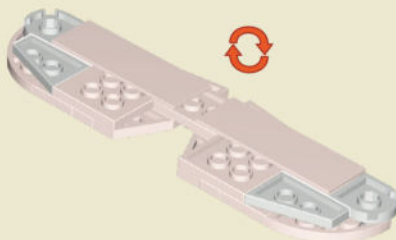

x1



x1



x2

83

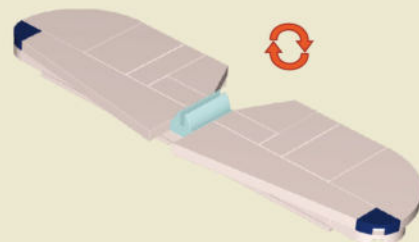

x1



x2



84

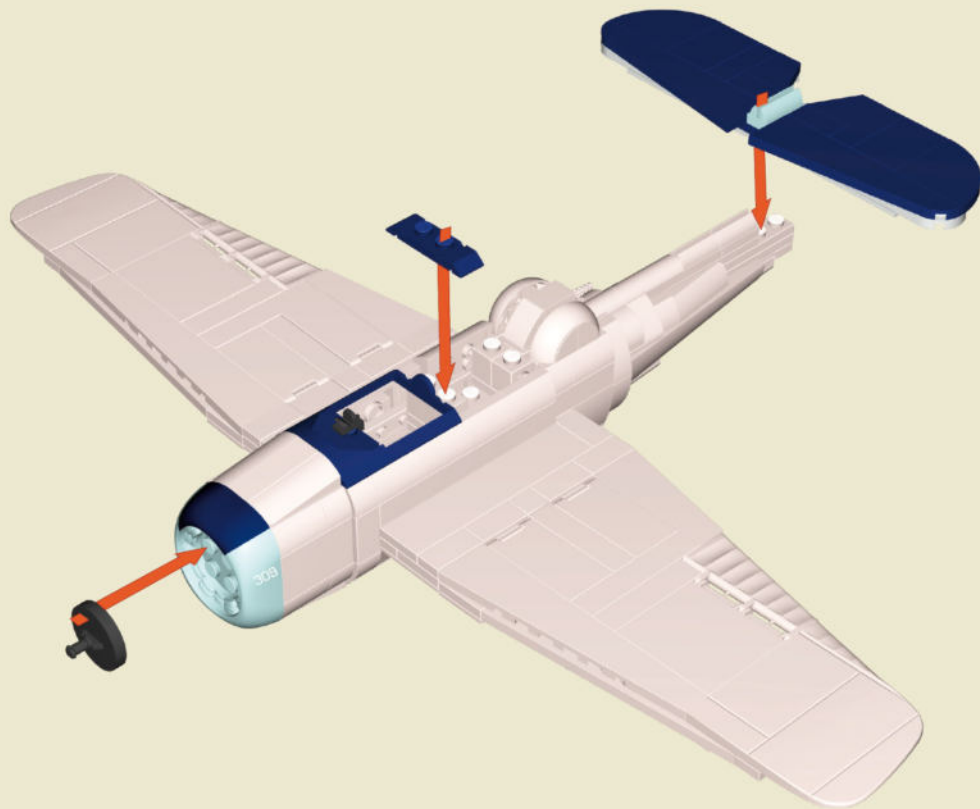

x1



x1



x1



x1



x1

85

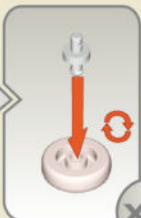

x2

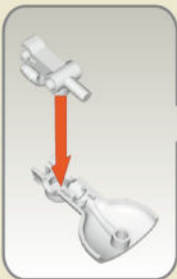

x2

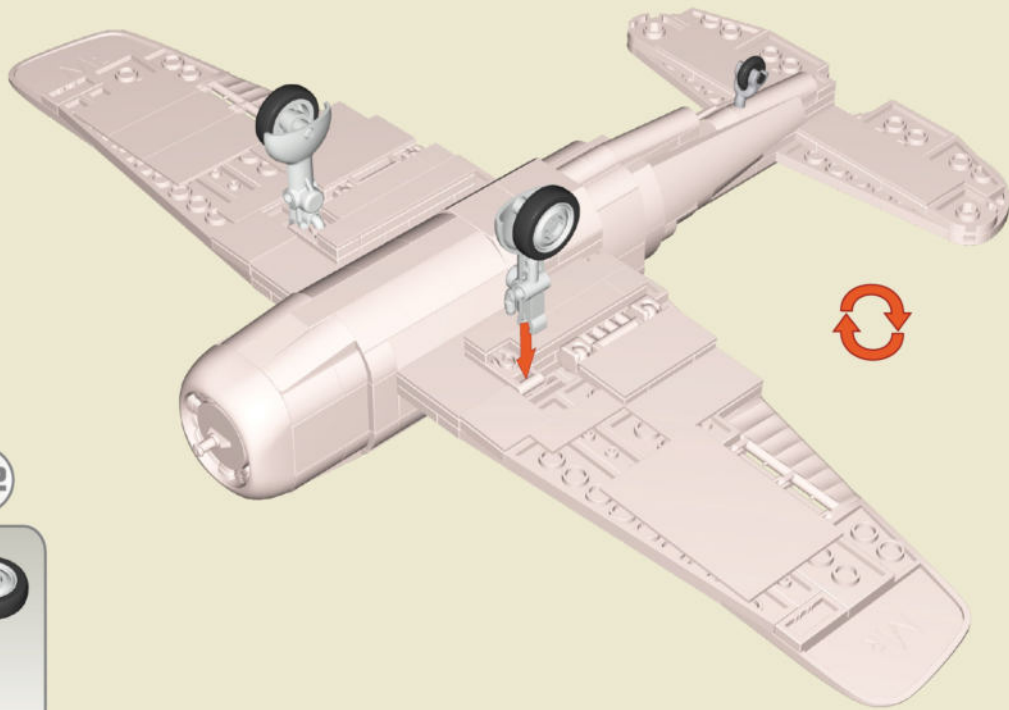

x2



x2



x2



x2



x2



x1







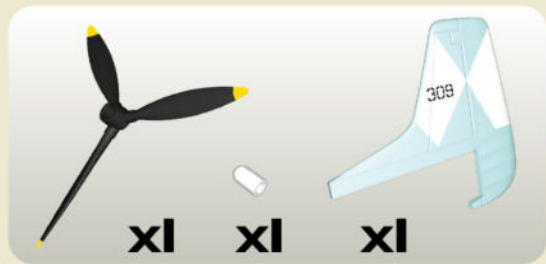
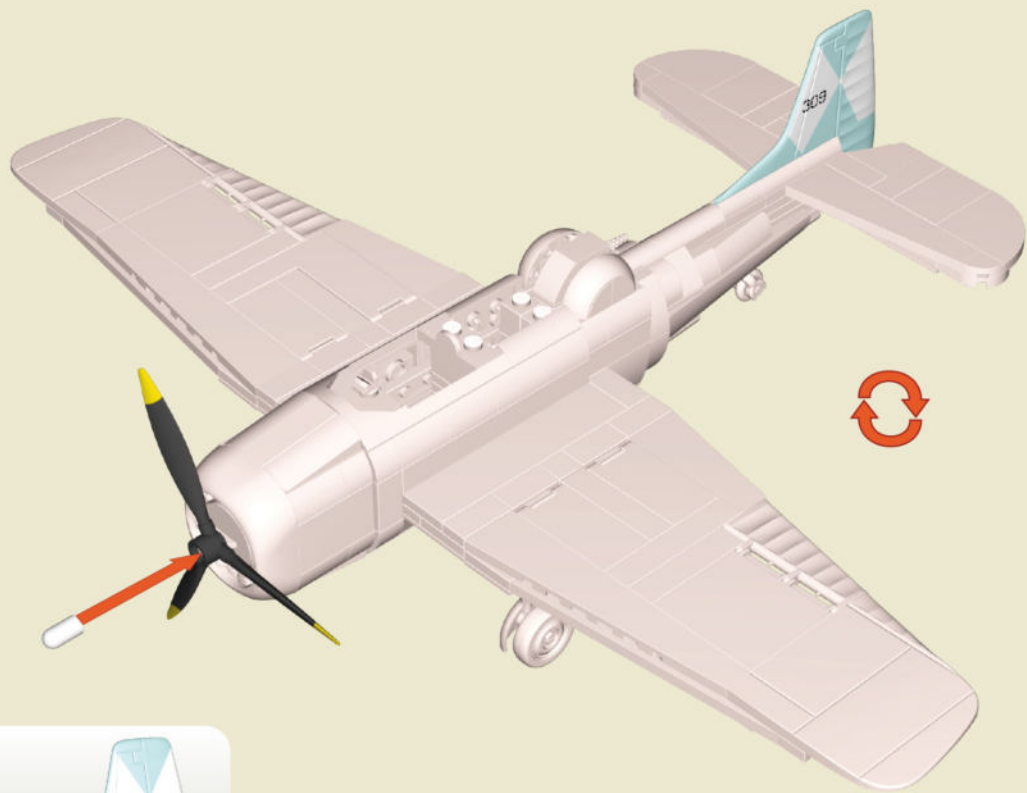



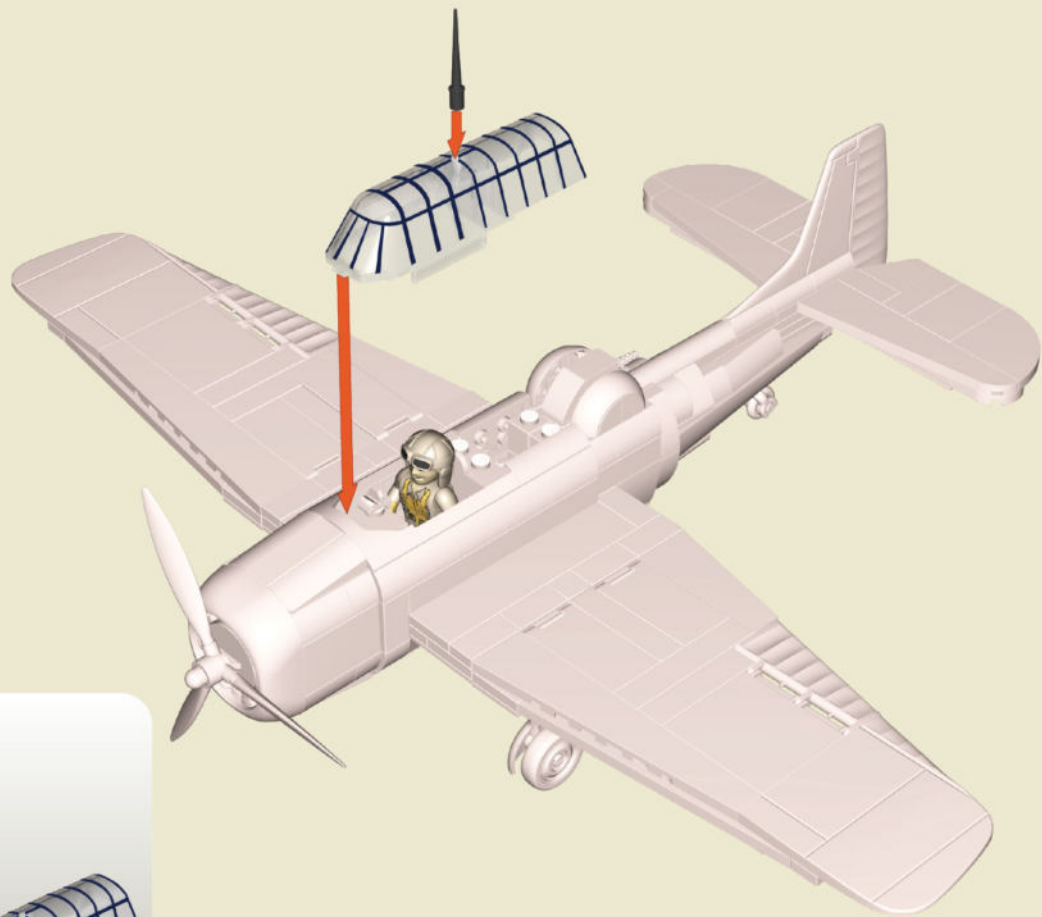
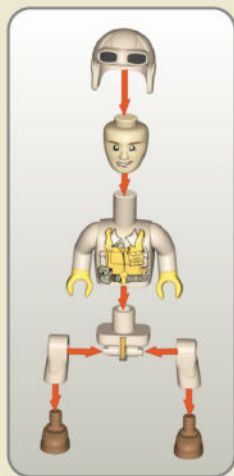































































x1

86



87











 x4 166554	 x2 115177	 x2 112266	 x1 92879	 x6 48787	 x2 159871	 x2 94545	 x4 134796	 x3 93346
 x2 112267	 x1 92880	 x2 92160	 x1 161430	 x2 164643	 x1 151497	 x2 91678	 x2 48786	 x3 142502
 x2 117277	 x2 91679	 x2 164538	 x1 166591	 x2 166590	 x4 134797	 x2 126302	 x1 138721	 x2 159890
 x1 166555	 x1 166592	 x4 166500	 x9 92647	 x19 48788	 x2 68232	 x1 68234	 x2 166610	 x1 110846
 x6 132429	 x2 163036	 x10 57244	 x6 164373	 x4 104720	 x1 166503	 x1 166502	 x3 166553	 x4 146280
 x6 90484	 x4 146290	 x1 91682	 x4 95039	 x3 57442	 x1 79150	 x1 68236	 x2 148219	 x2 153948
 x2 163042	 x1 166899	 x1 166898	 x2 99325	 x1 100794	 x2 114622	 x2 117058	 x1 166561	 x5 132424
 x2 51175	 x5 57211	 x1 166502	 x1 166503	 x2 117059	 x2 166541	 x1 166505	 x1 166506	 x1 120905

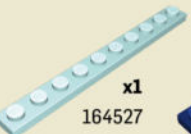



 **x2** 132609   
  **x2** 146302   
  **x1** 92901   
  **x1** 92909   
  **x1** 136534   
  **x2** 93464   
  **x2** 106347   
  **x2** 153947   
  **x1** 92703

 **x1** 92656   
  **x2** 165069   
  **x1** 164527   
  **x2** 55823   
  **x1** 112272   
  **x1** 159897   
  **x1** 159898   
  **x1** 55833

 **x2** 95082   
  **x1** 166510   
  **x1** 166511   
  **x2** 55829   
  **x1** 166607   
  **x1** 166613

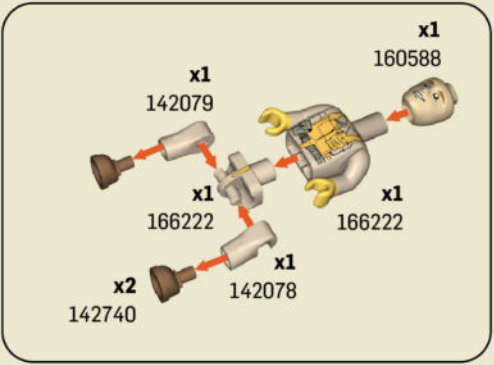

 **x1** 166614   
  **x1** 166606   
  **x1** 166514   
  **x1** 166517   
  **x1** 166609   
  **x1** 166615

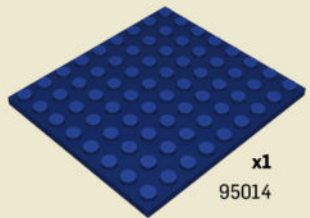

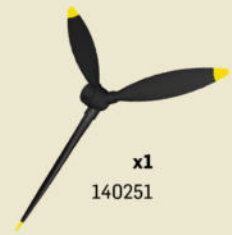
 **x1** 95014

 **x1** 140251

 **x1** 166516   
  **x1** 58332

 **x1** 133469   
  **x1** 107313

**Customer Service**  
 Kundenservice  
 Obstuga Klienta  
[www.cobi.eu/service](http://www.cobi.eu/service)



# HISTORICAL COLLECTION



SCALE 1:48

**MESSERSCHMITT ME 262**

+ 5881



SCALE 1:48

**YAKOVLEV YAK-1b**

★ 5863

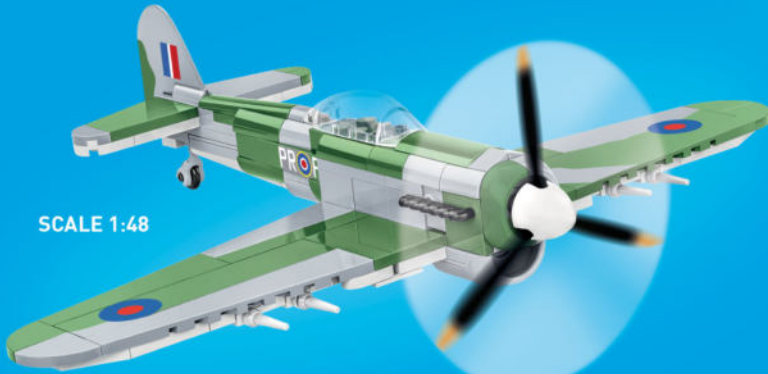

SCALE 1:48

**HAWKER TYPHOON MK.IB**

🇬🇧 5864



# HISTORICAL COLLECTION



SCALE 1:48

MITSUBISHI A6M2 "ZERO"

● 5861

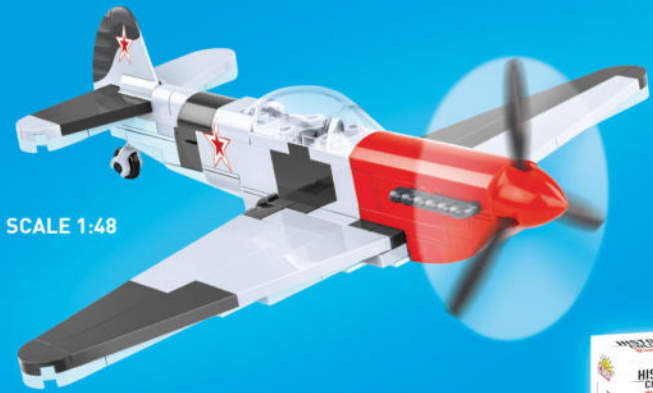

SCALE 1:48

YAKOVLEV YAK 3

★ 5862

