

# HISTORICAL COLLECTION

## WORLD WAR II



### NORTH AMERICAN P-51D MUSTANG™

PLACE OF ORIGIN - UNITED STATES  
 IN SERVICE - 1944 - 1960s  
 ROLE - FIGHTER  
 CREW - 1  
 WINGSPAN - 11,28m (37')  
 LENGTH - 9,83m (32' 3")  
 HEIGHT - 4,08m (13' 4")  
 WEIGHT - 3 465kg (7 635lb)  
 ENGINE - PACKARD MERLIN V-1650-7, 1 111kW (1 490HP)  
 RATE OF CLIMB - 16,3m/s (3 200ft/min)  
 MAXIMUM FLIGHT LEVEL - 12 800m (41 900ft)  
 ARMAMENT - 6x 12,7mm (.50") BROWNING GUNS,  
 453kg (1 000lb) BOMBS, ROCKETS  
 RANGE - 2 655km (1 650mi)  
 SPEED - 708km/h (440mph)

# 5860

Produced under license from Boeing.  
 Boeing, North American Aviation, P-51 Mustang,  
 the distinctive Boeing logos, product markings and  
 trade dress are trademarks of The Boeing Company.

Printed in EU

**PAD PRINTED**  
**NO STICKERS**



**WARNING: CHOKING HAZARD-**  
 Toy contains small parts.  
 Not for children under 3 years.



PEFC Certified  
 This product is from  
 sustainably managed  
 forests  
 www.pefc.pl



UK  
CA



CE



# 152



## NORTH AMERICAN P-51D MUSTANG™

SCALE 1:48

1

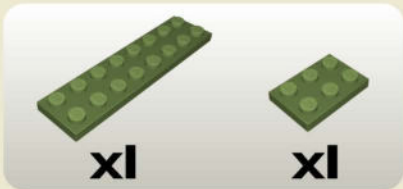
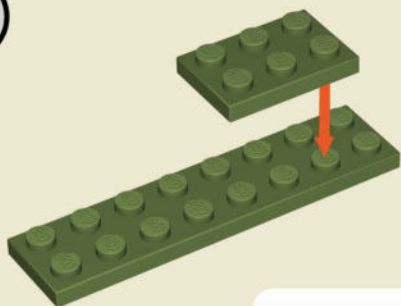

2

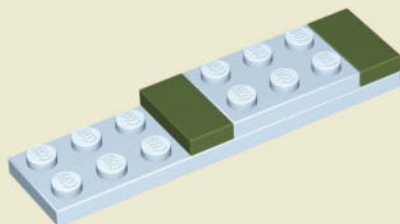

1:1



3

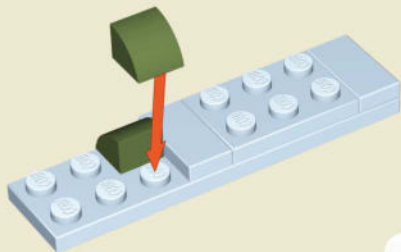

4

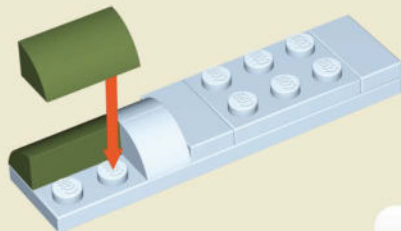

5

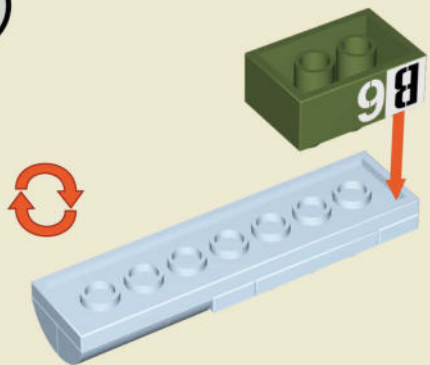

6

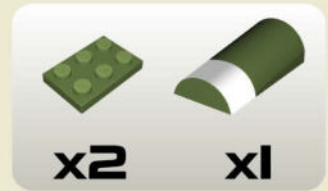
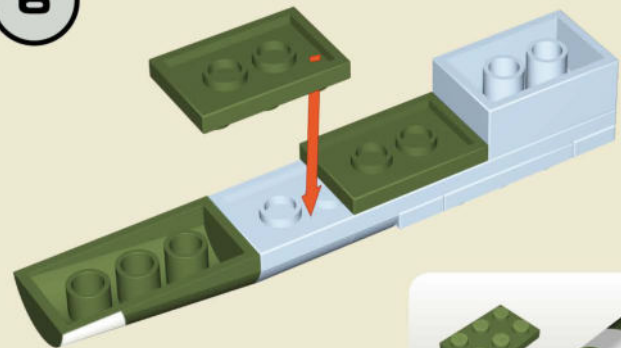

7

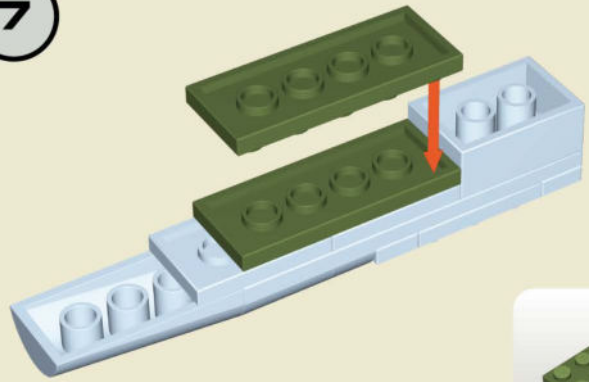

8

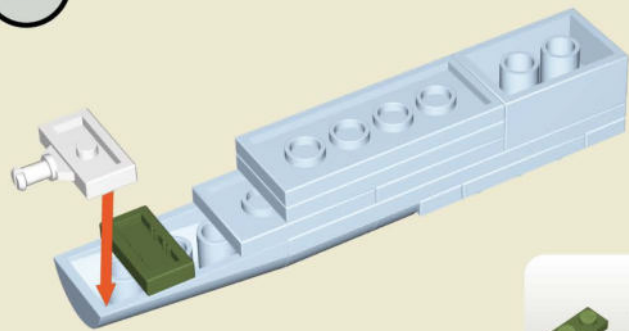

9

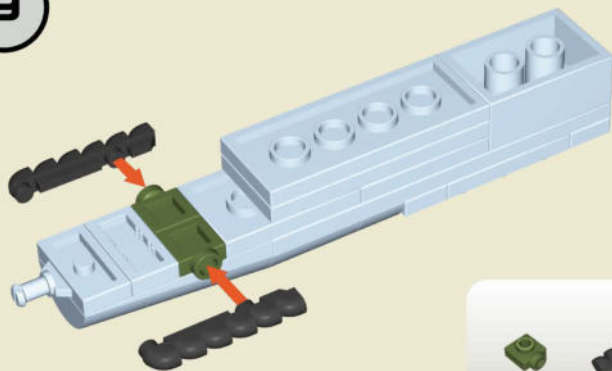

10

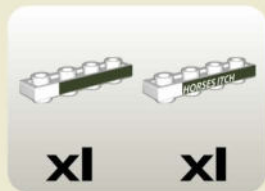
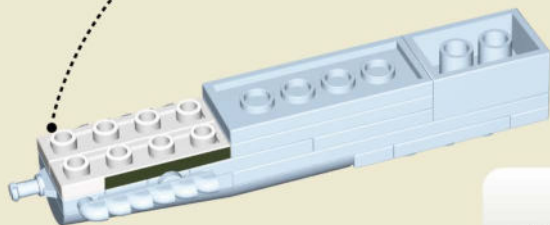

11

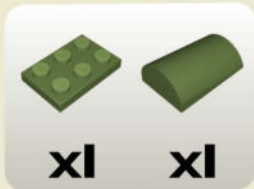
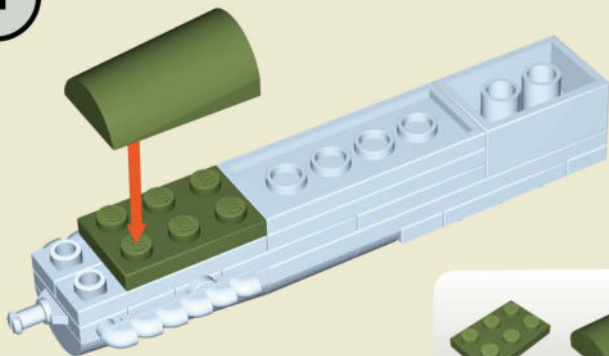

12

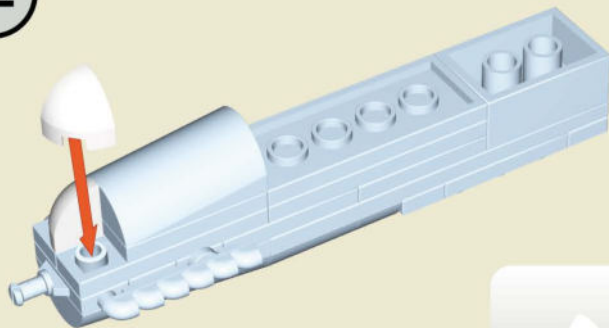

13

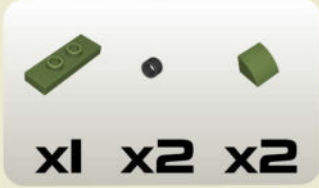
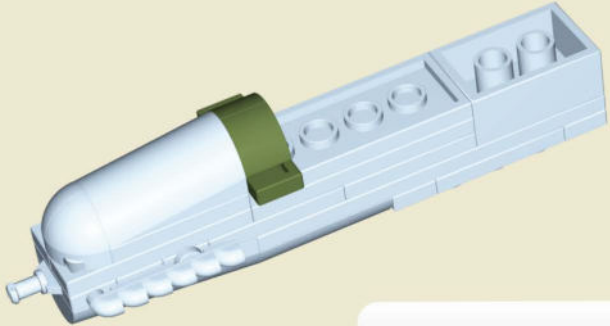
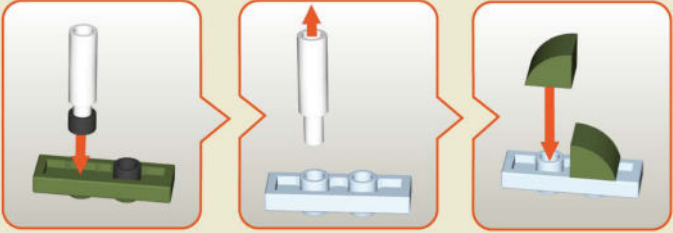

14

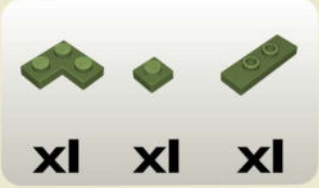
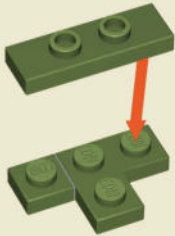

15



16

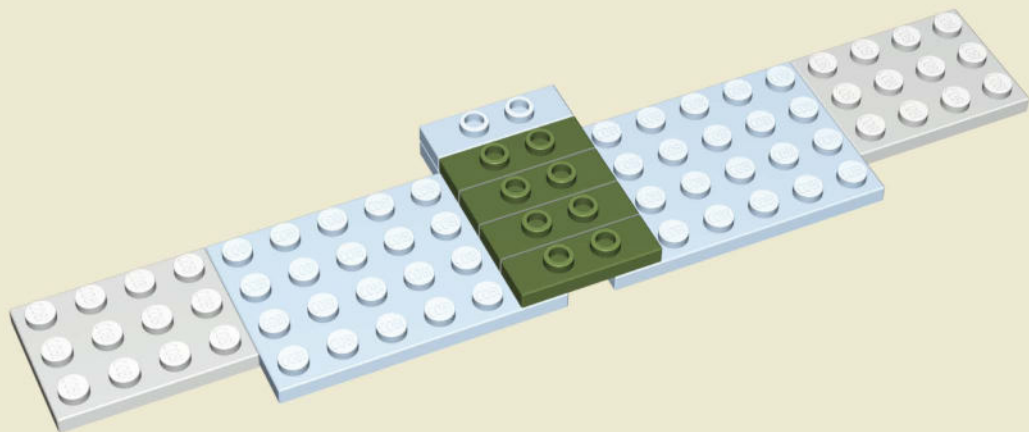

x4



x2

17

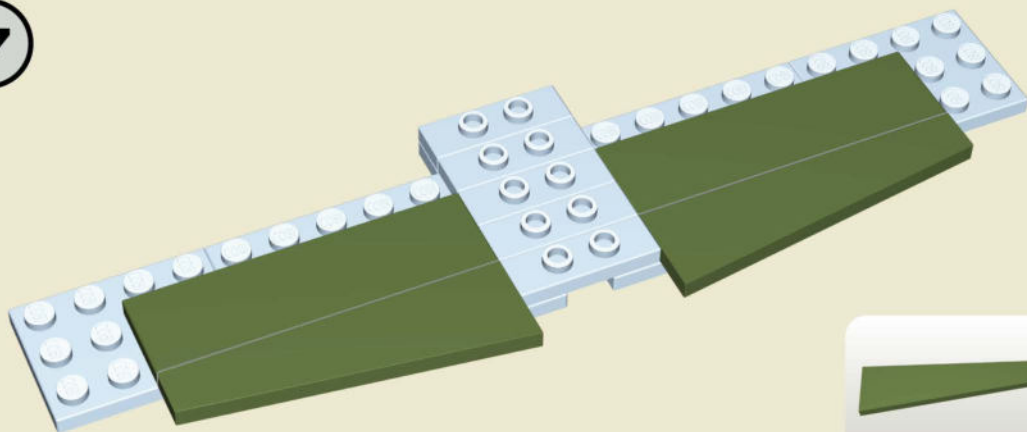

x1



x1

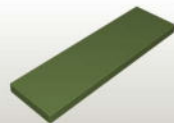

x2



18

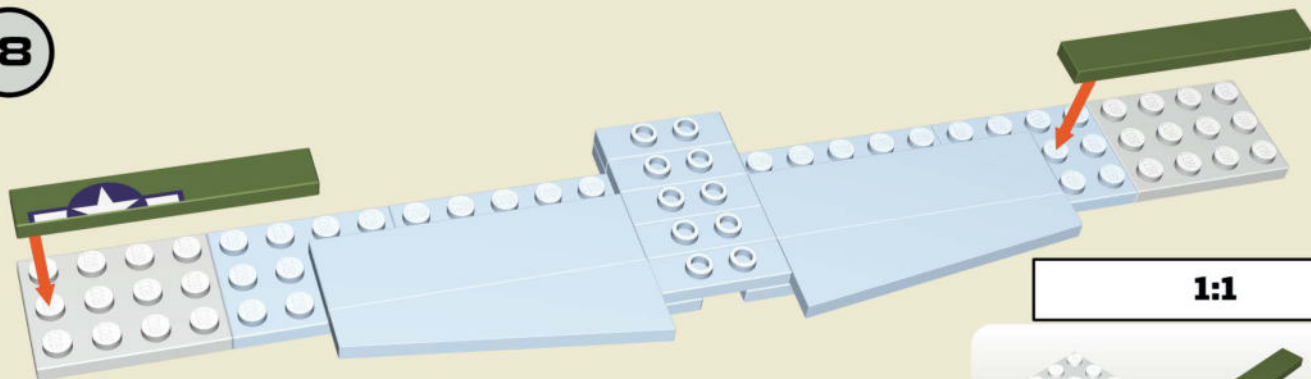

1:1



x2



x1



x1

19

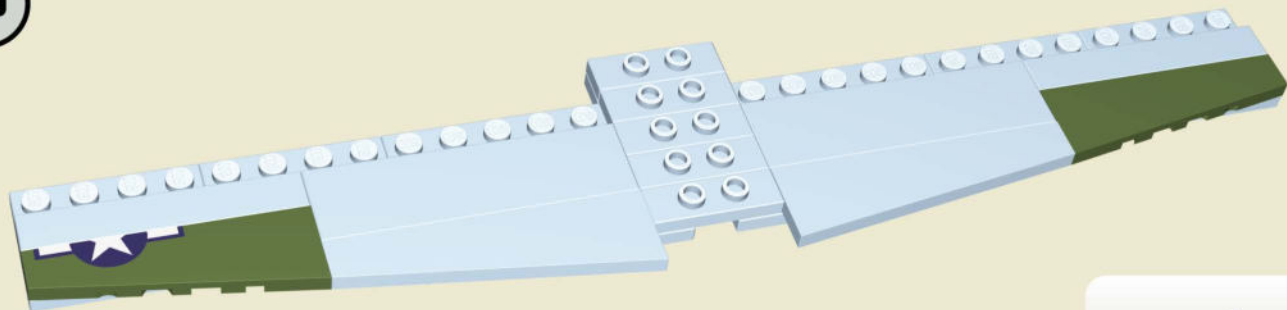

x1



x1

20

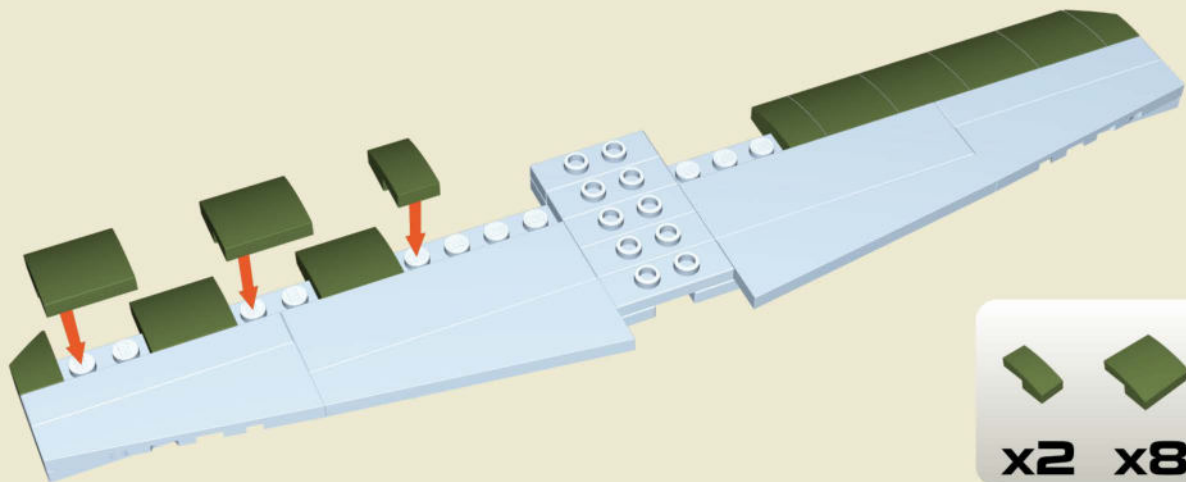

<b>x2</b>	<b>x8</b>	<b>x1</b>	<b>x1</b>

21

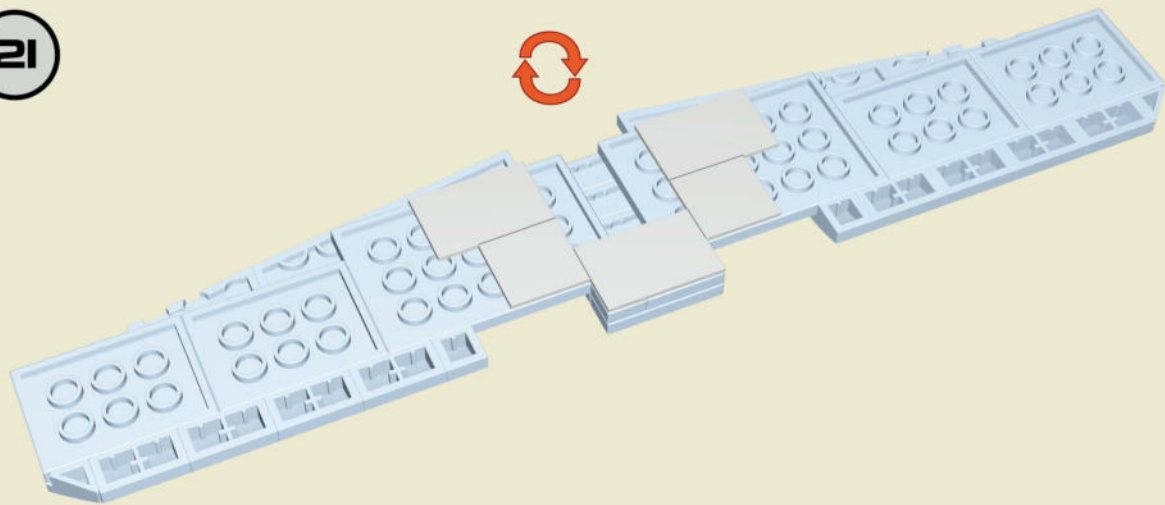

<b>x2</b>	<b>x3</b>



22

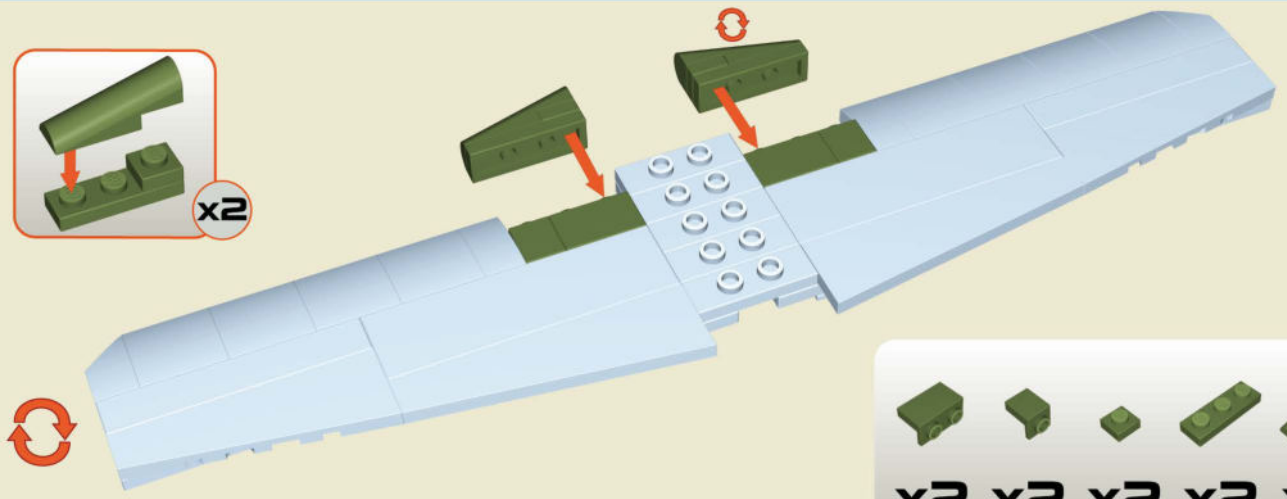

23

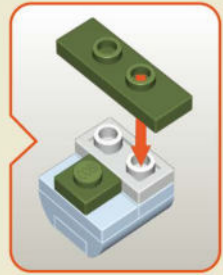

1:1

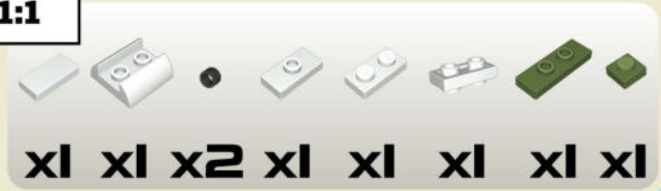

24

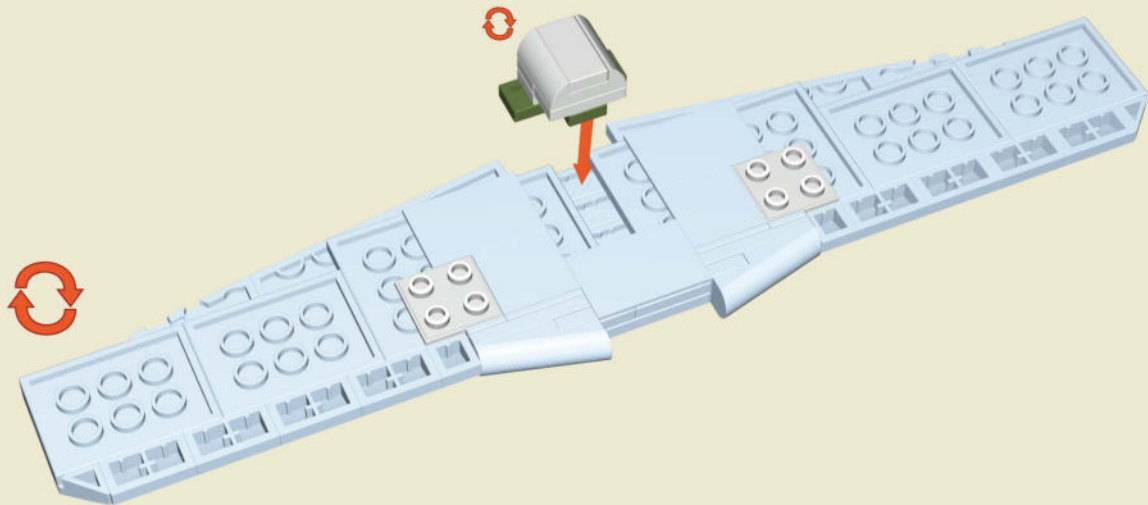

25

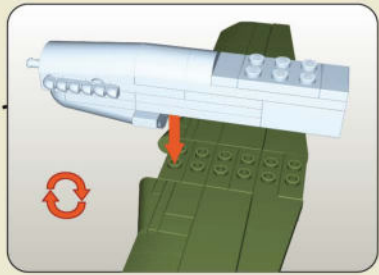
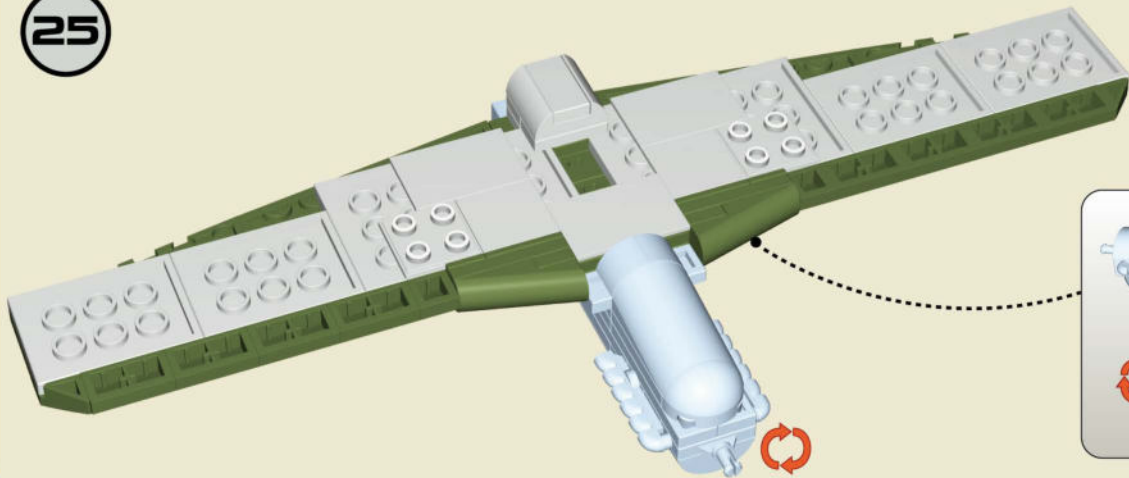

26

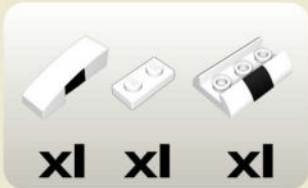
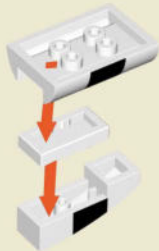

27

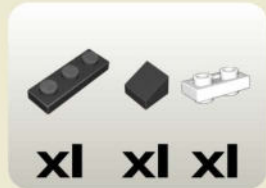
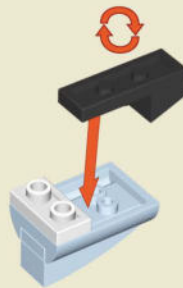

28

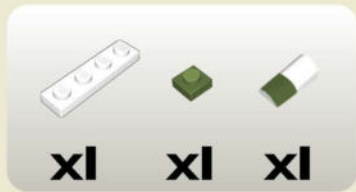
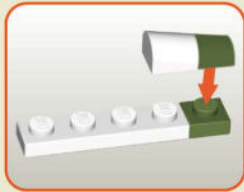
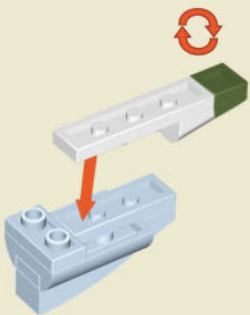

29

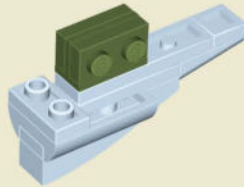

30

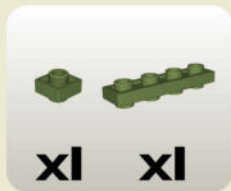
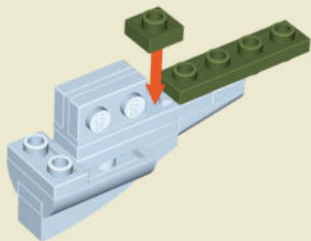

31

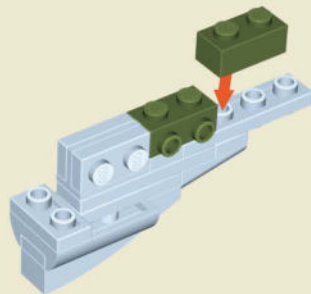

32

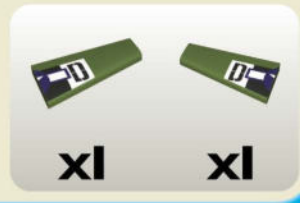
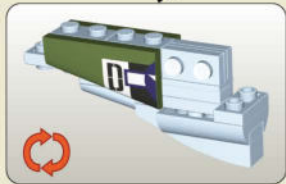
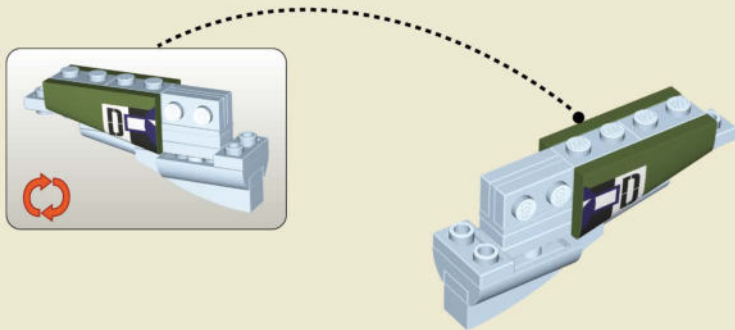

33

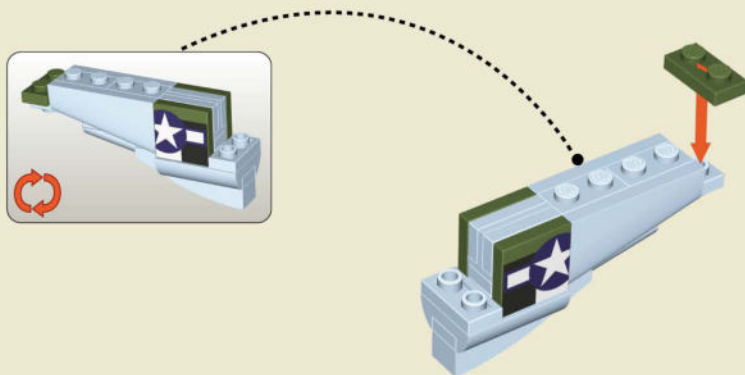

34

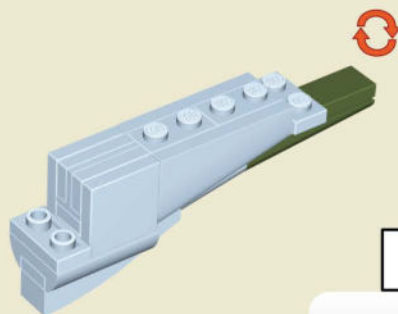

1:1

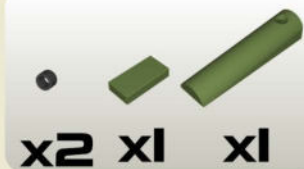

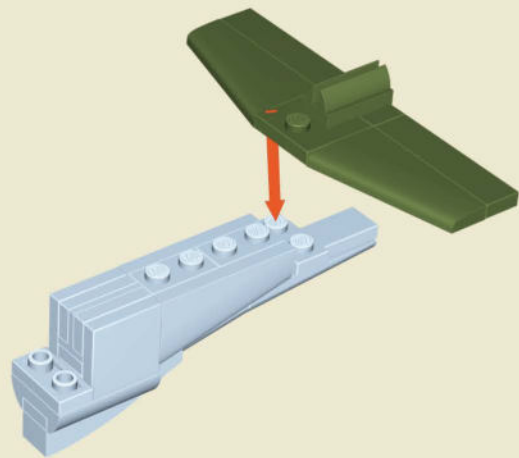
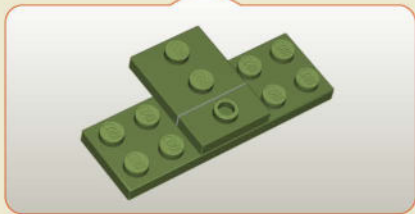
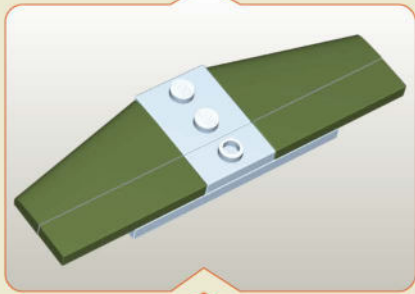
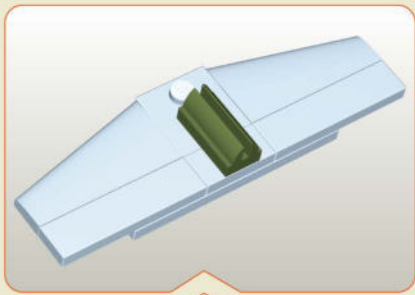

1:1

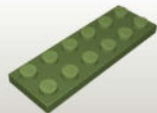

x1



x1



x1

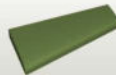

x1



x1



x2



x1



36

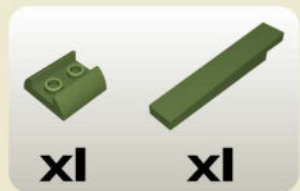
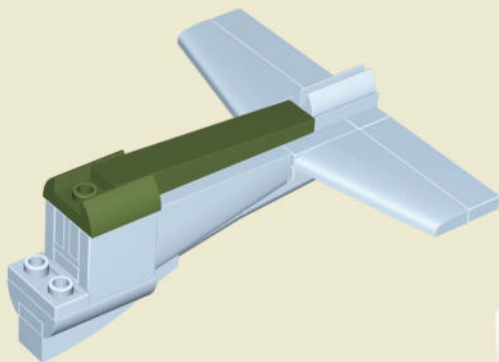
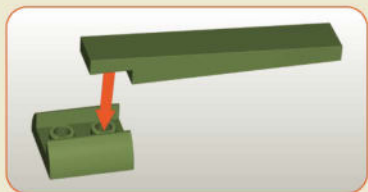

37

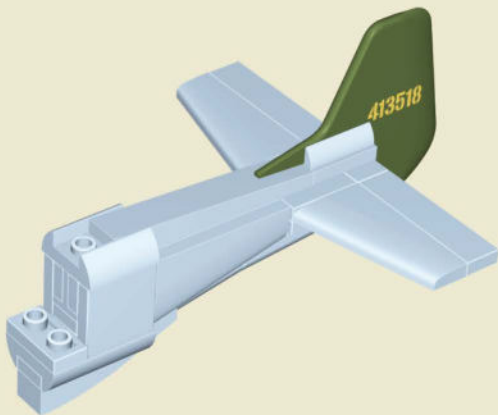

38



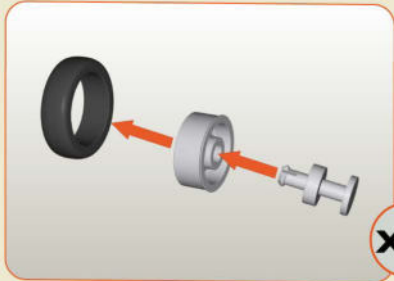

x2

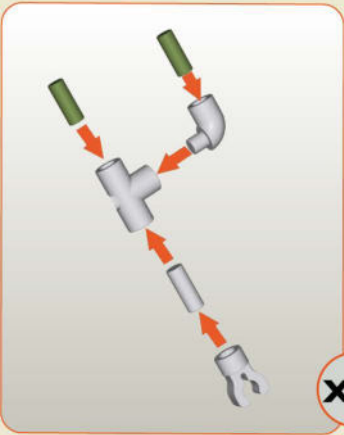
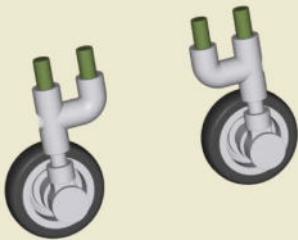

x2

-  x2
-  x2
-  x2
-  x2
-  x4
-  x2
-  x2
-  x2

40

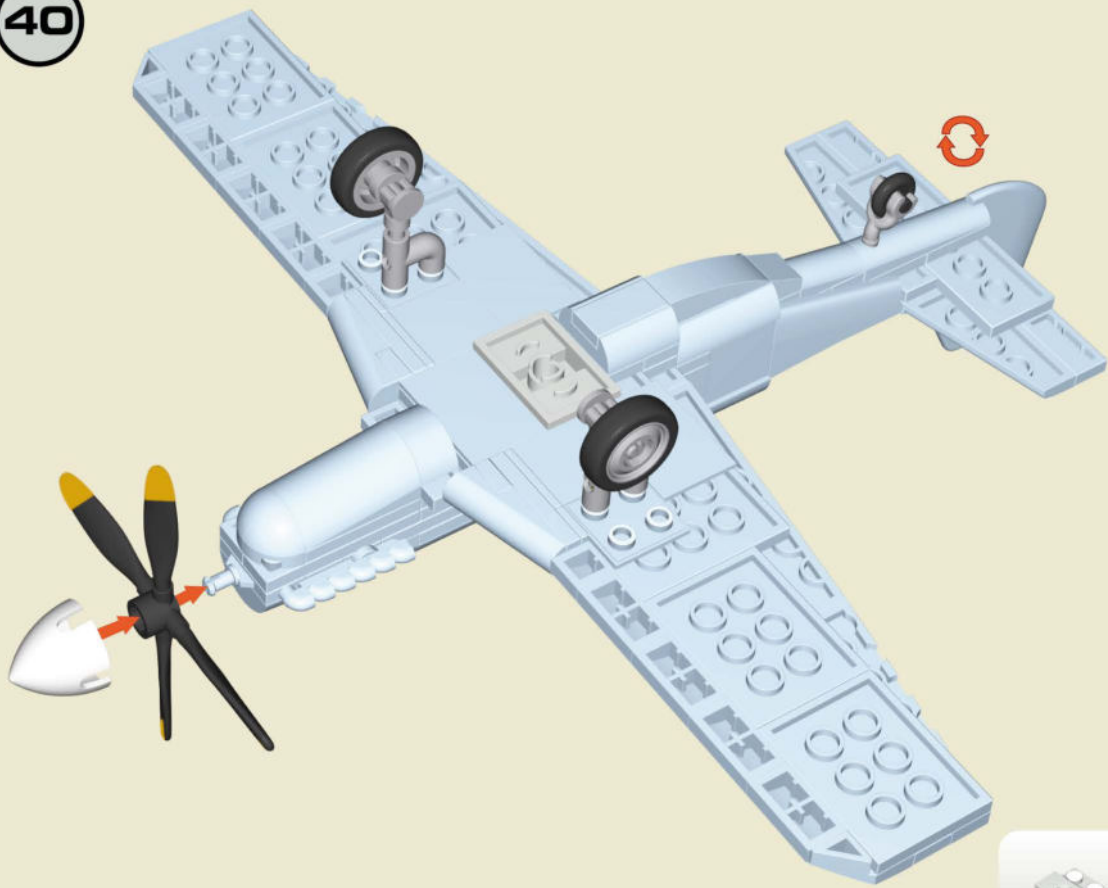

x1



x1



x1



x1



x1



x5  
44014



x1  
86093



x2  
147889



x2  
150425



x4  
92239



x2  
113932



x1  
95106



x1  
42927



x4  
42931



x1  
92647



x1  
161966



x1  
42909



x1  
92649



x2  
134976



x3  
45540



x1  
92882



x1  
137672



x1  
117265



x1  
42952



x1  
92881



x1  
143654



x1  
143657



x2  
128968



x2  
113534



x2  
98140



x1  
165317



x1  
160804



x1  
42957



x2  
42959



x7  
115502



x2  
157720



x1  
42972



x1  
165318



x1  
165319



x1  
42985



x2  
64202



x1  
139596



x1  
83478



x1  
130483



x1  
43100



x1  
77515



x8  
121919



x2  
122048



x2  
126912



x1  
141688



x1  
141689



x4  
43154



x1  
165323



x1  
136062



x3  
120917



x1  
165324



x1  
153302

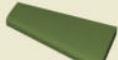

x1  
153309



x1  
165325



x2  
107858



x1  
43194



x1  
92791



x2  
108324

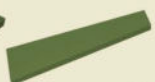

x1  
165329



x1  
163968

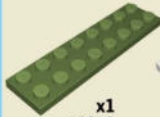

x1  
43212



x4  
92673



x2  
92674



x6  
93960



x2  
155883



x1  
140607



x1  
165320



x1  
165320



x1  
165321



x1  
165321



**Customer Service**

Kundenservice  
 Obsługa Klienta

**[www.cobi.eu/service](http://www.cobi.eu/service)**

**01-05860-150**

For  
 news and  
 special deals

Find us on:  
 [cobi.bricks](#)  
 [cobi.klocki](#)  
 [COBI SA](#)