

BOEING 737-8™



Produced under license. Boeing, 737 MAX, the distinctive Boeing logos, product markings and trade dress are trademarks of The Boeing Company.



26608

PAD PRINTED
NO STICKERS

Printed in EU



WARNING: CHOKING HAZARD-
Toy contains small parts.
Not for children under 3 years.

340 

BOEING 737-8™

SCALE 1:110

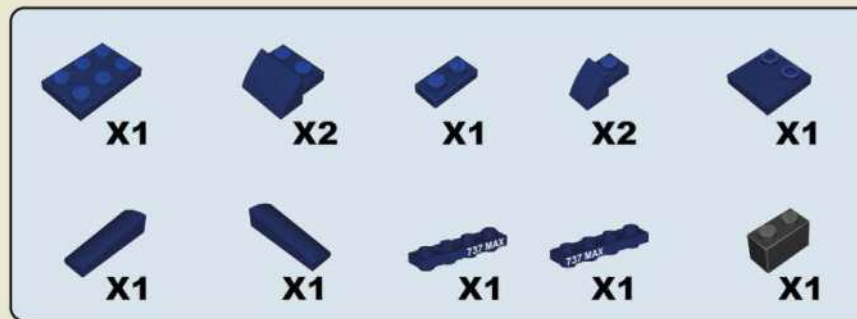
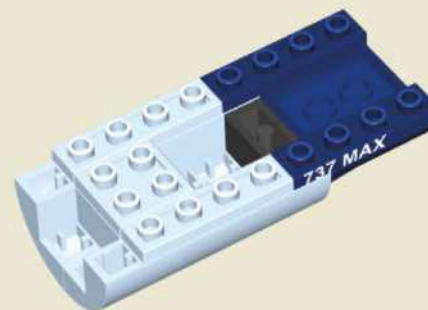
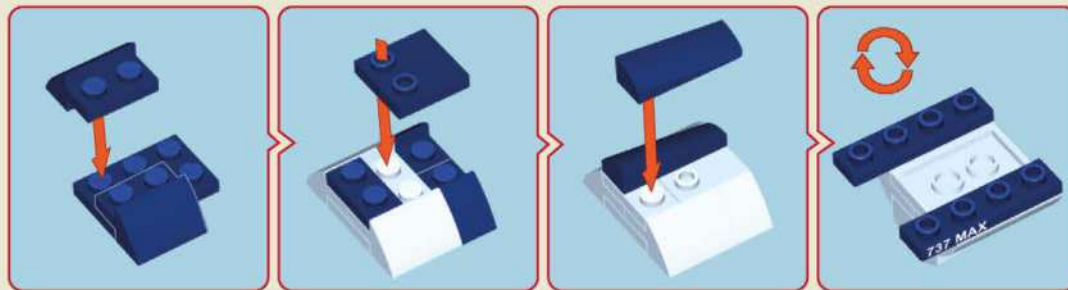
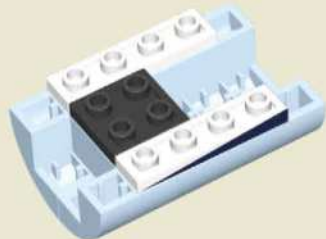
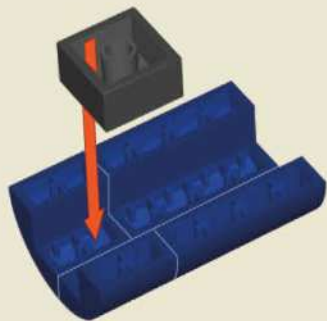

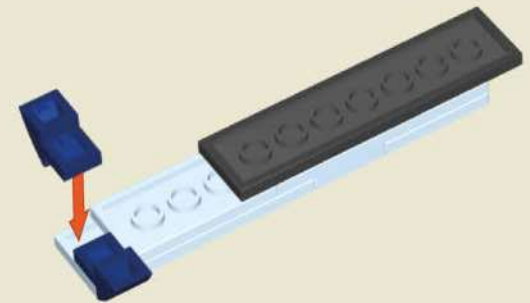
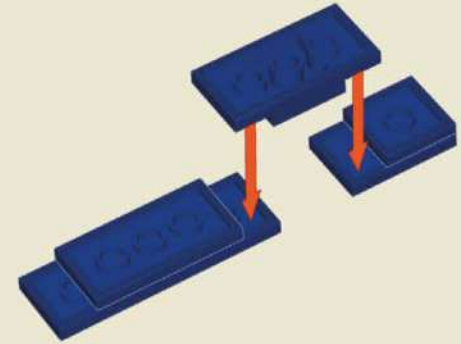
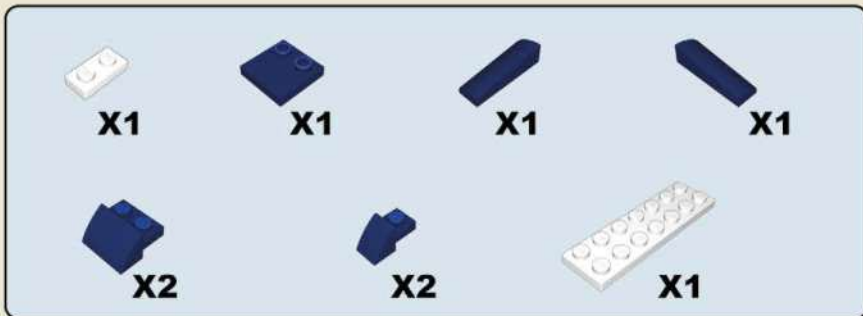
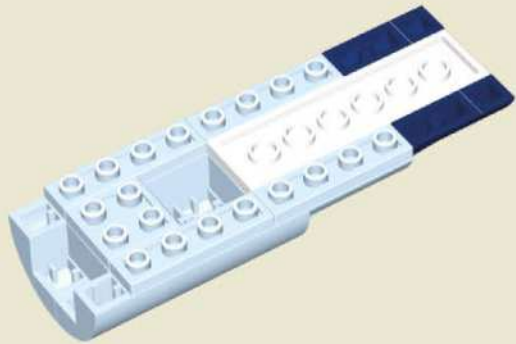
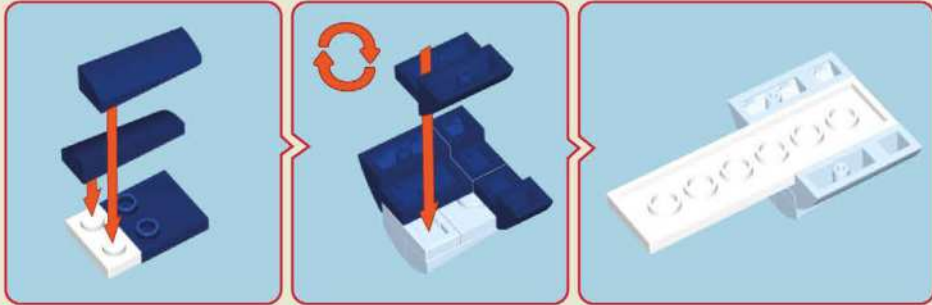

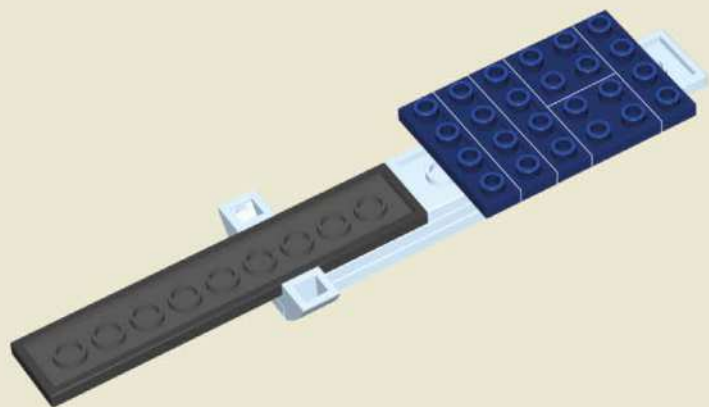

-  X1
-  X4
-  X2

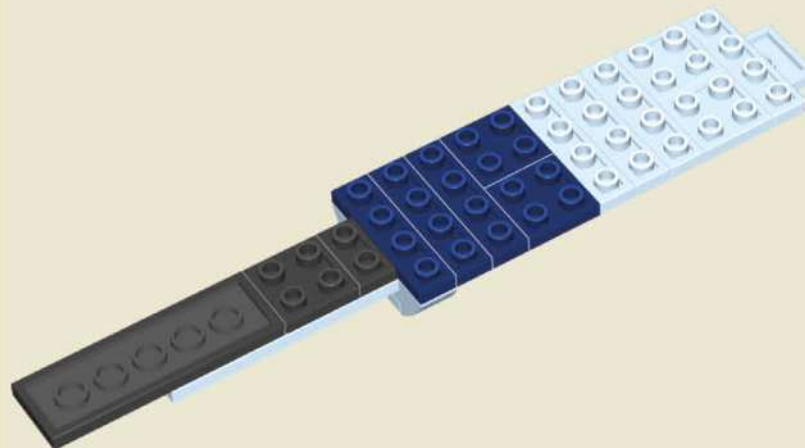

-  X2
-  X3
-  X1
-  X1
-  X1

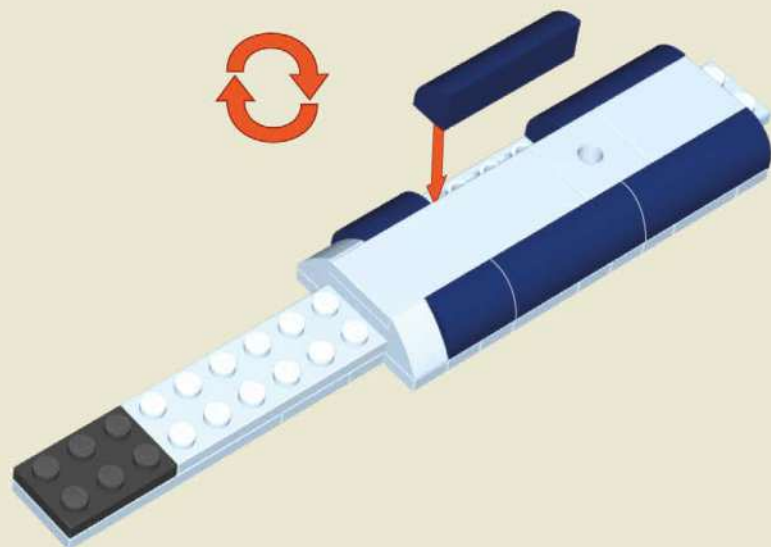

-  X4
-  X2
-  X1



-  X2
-  X2
-  X2

11

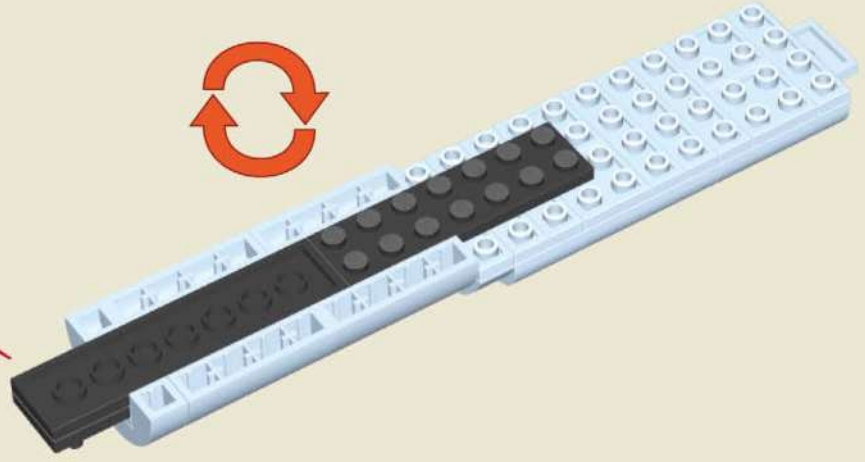
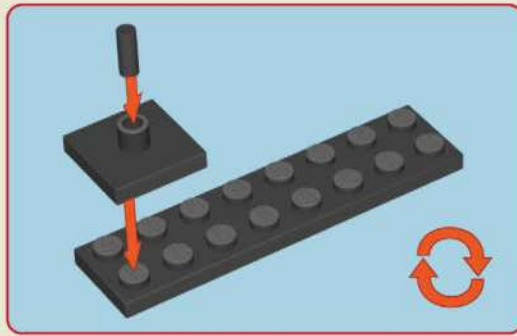



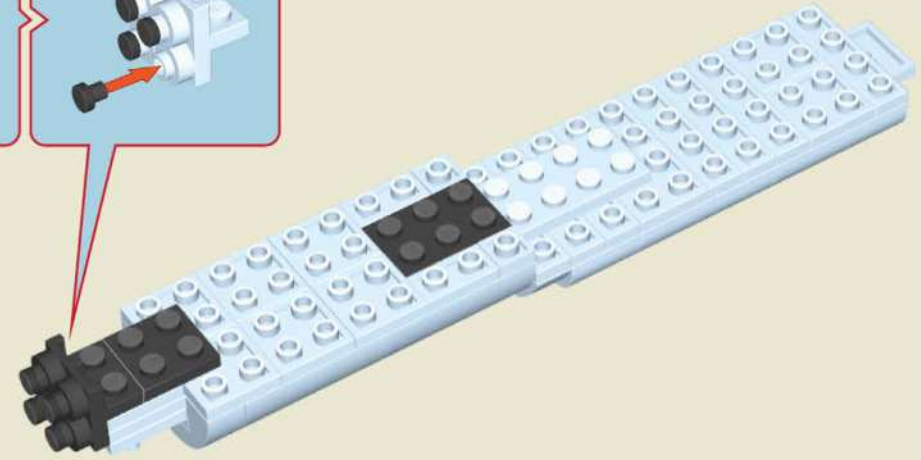
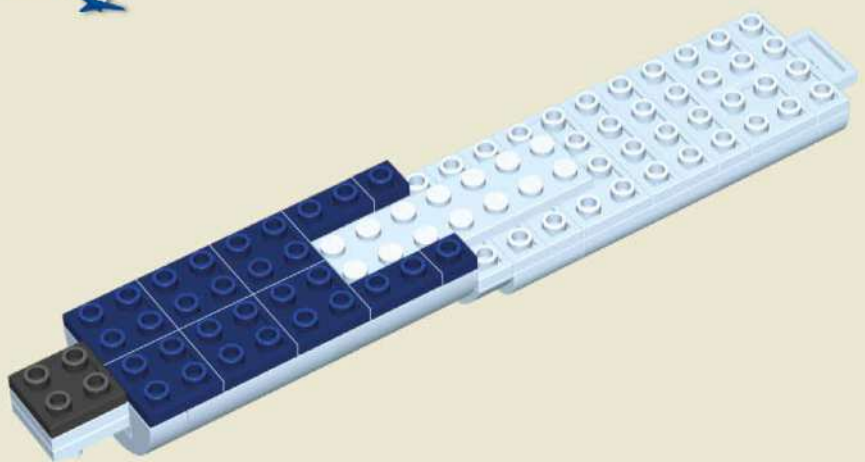

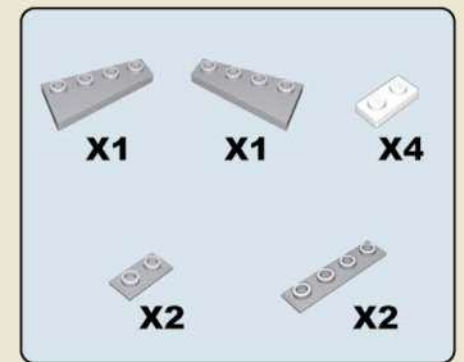
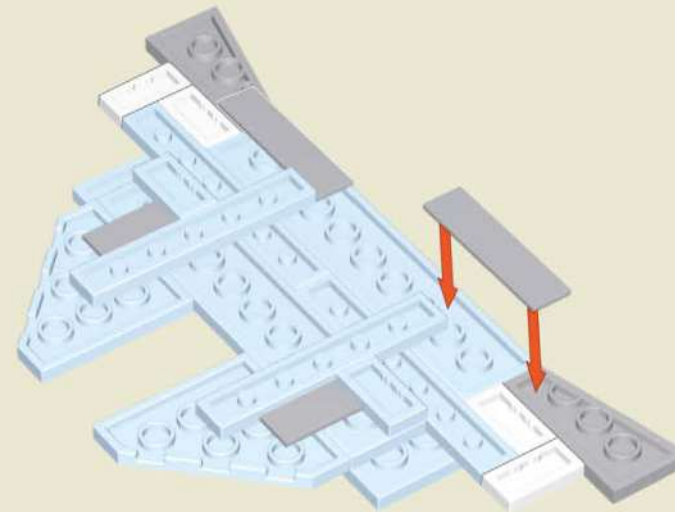
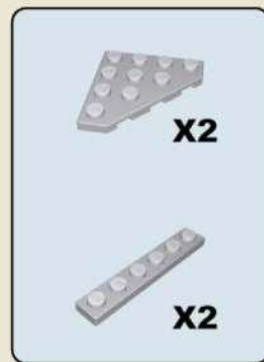
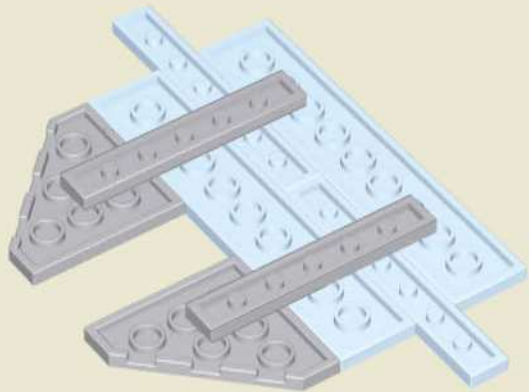
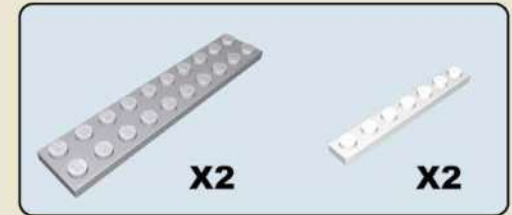
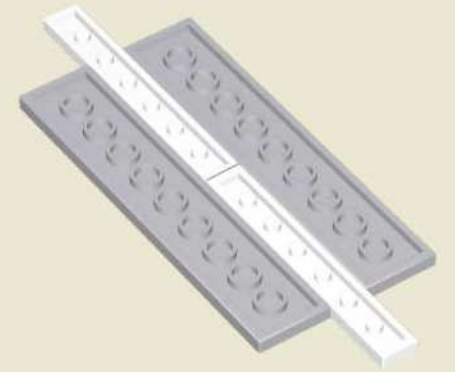
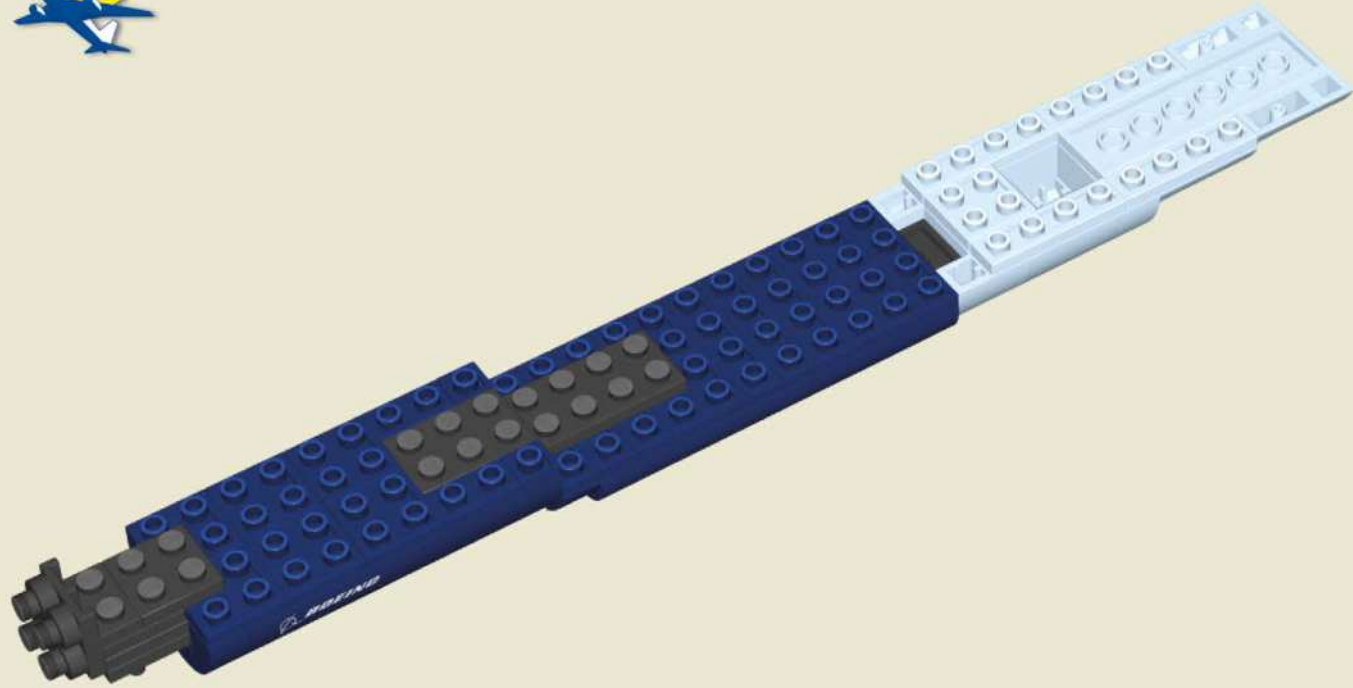

12

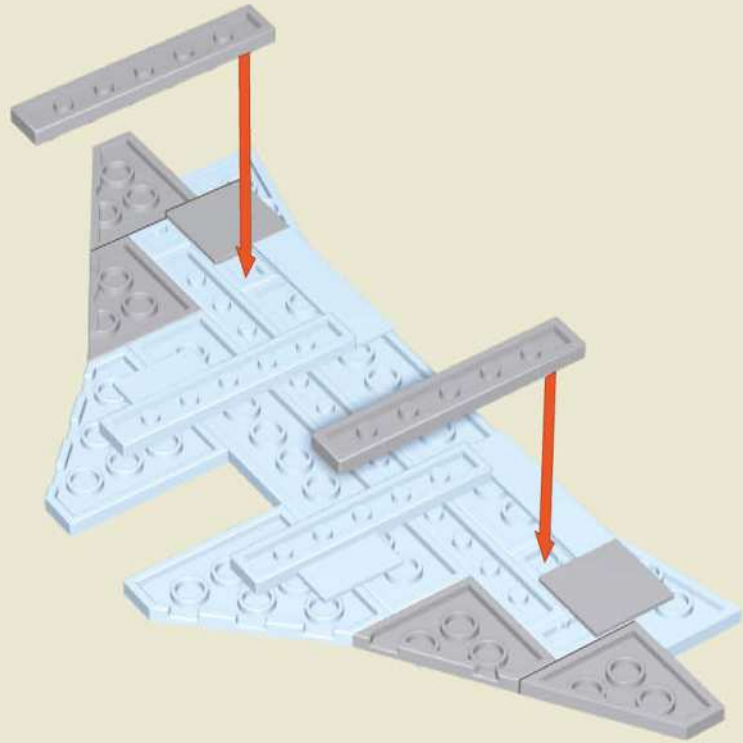

13





- | | | |
|---|---|---|
|  |  |  |
| X1 | X1 | X2 |
|  |  |  |
| X2 | X1 | X1 |

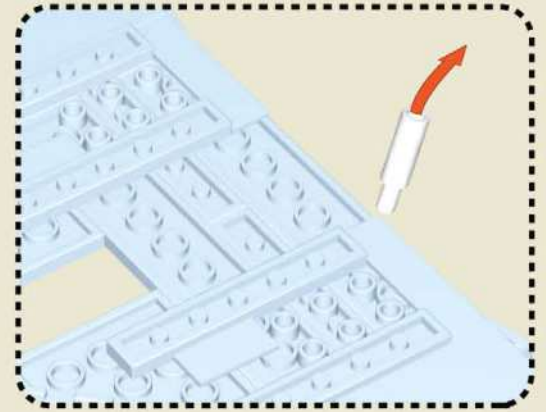
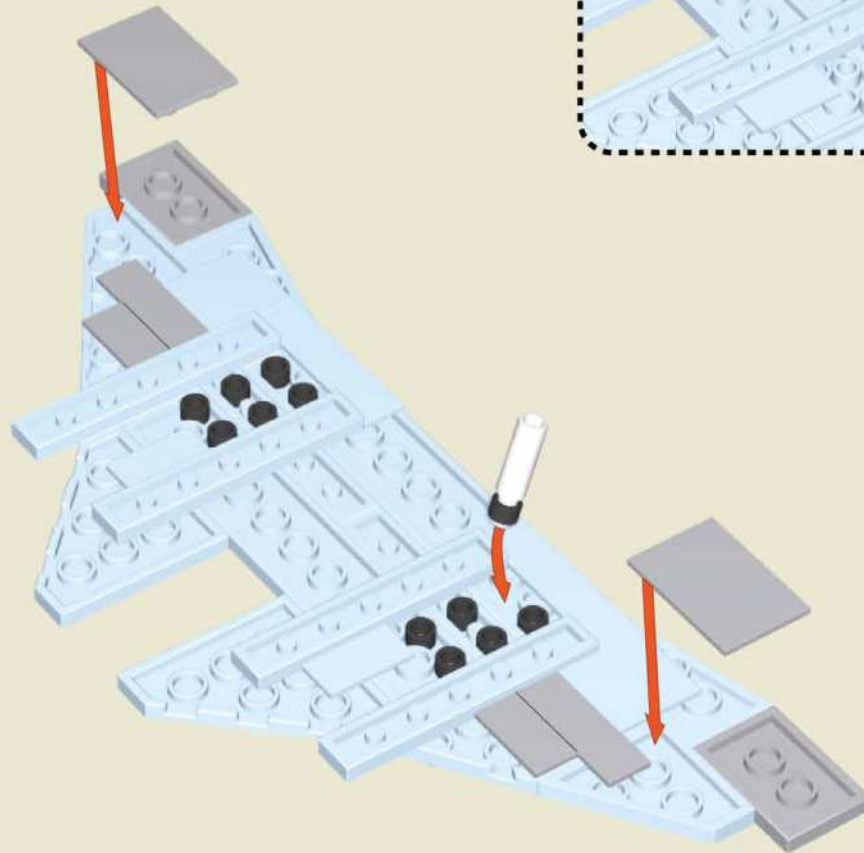

- | | | | | |
|---|---|---|---|---|
|  |  |  |  |  |
| X2 | X2 | X2 | X2 | X12 |

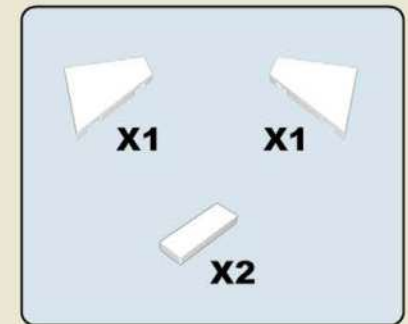
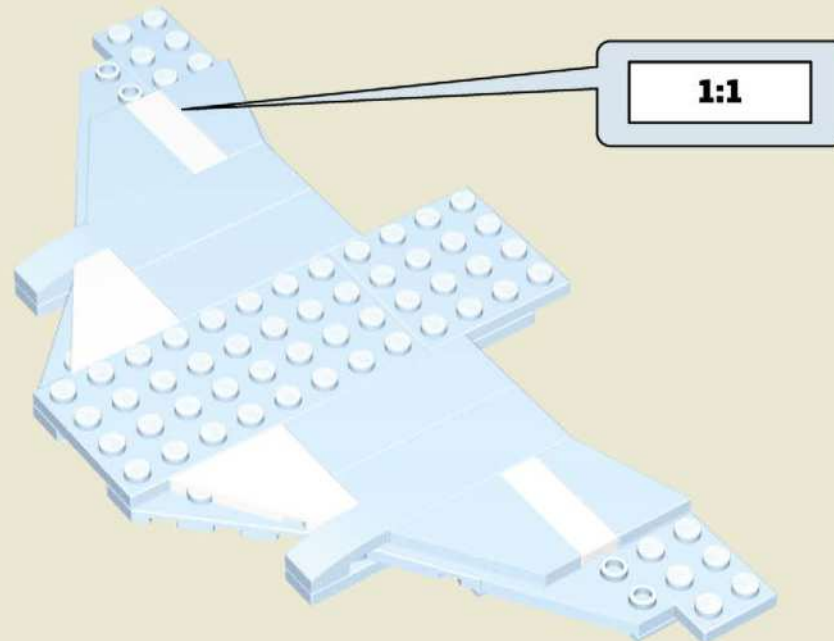
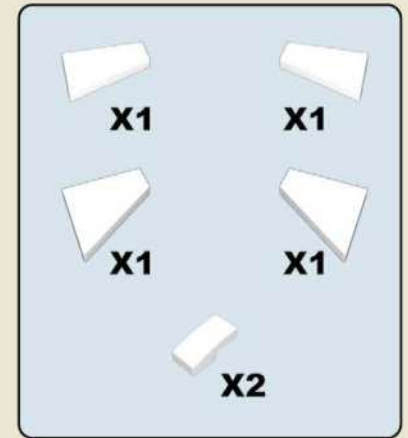
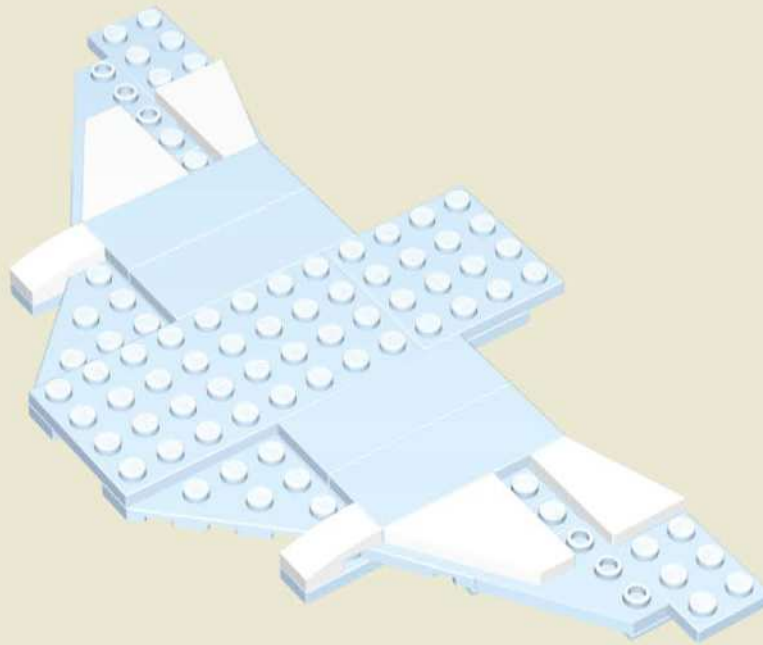
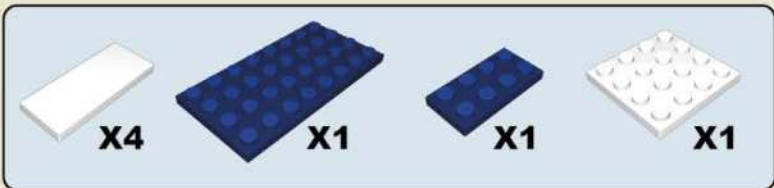
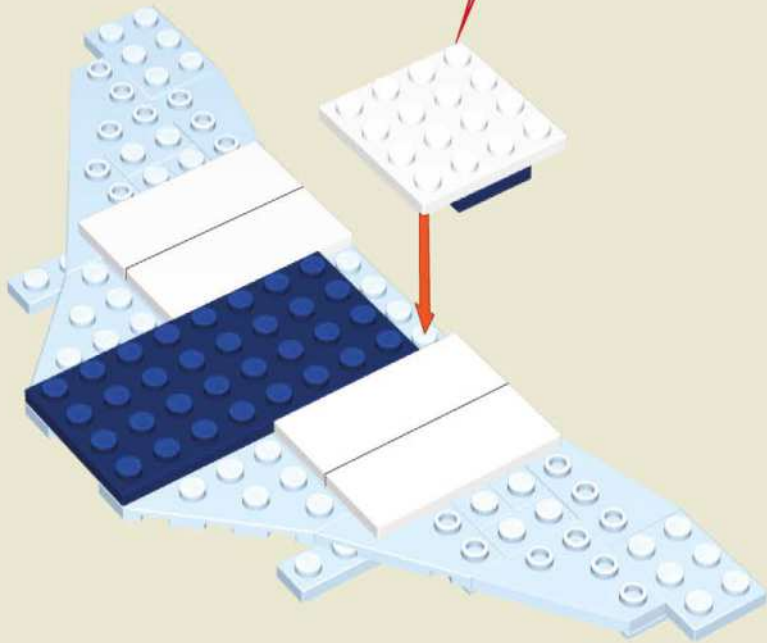
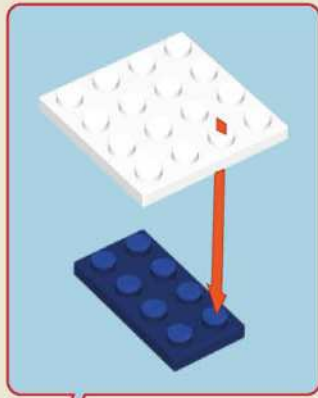

23

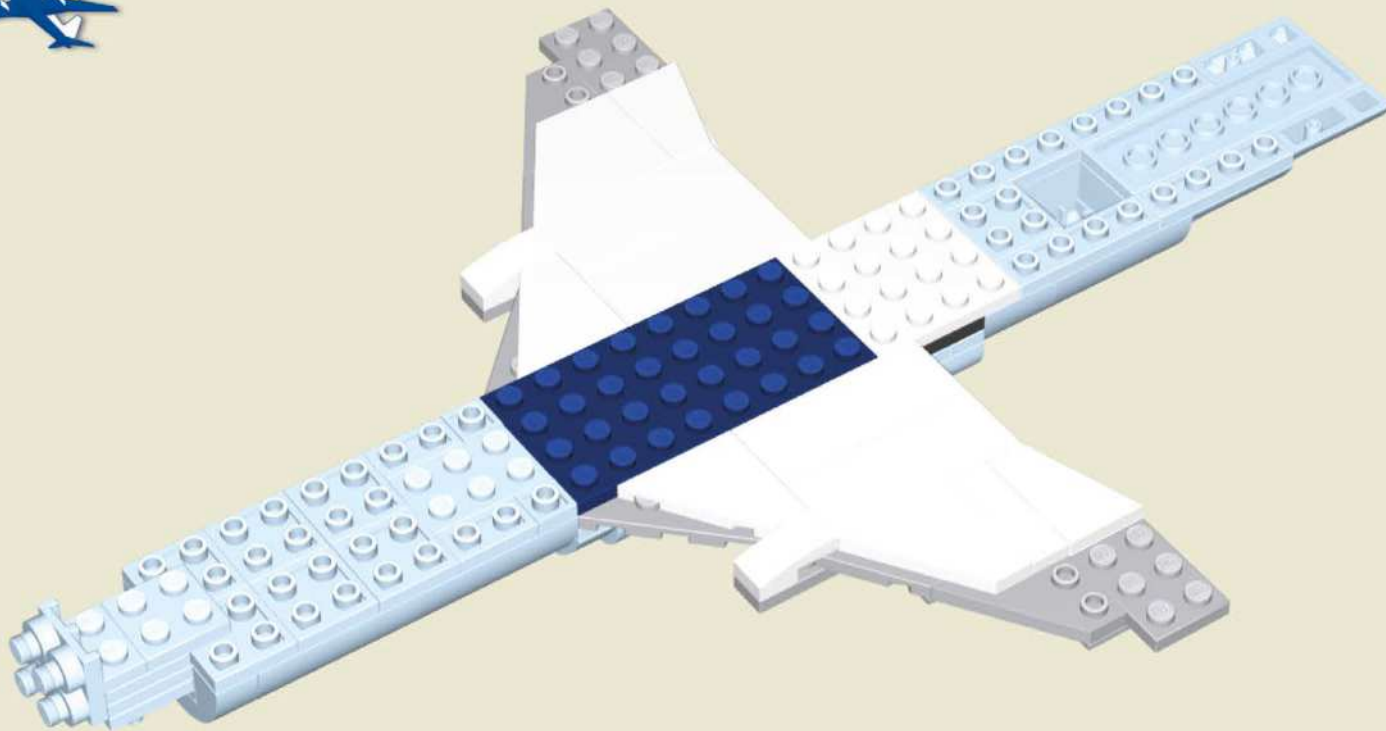

24

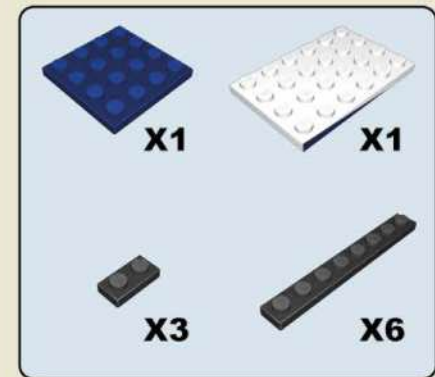
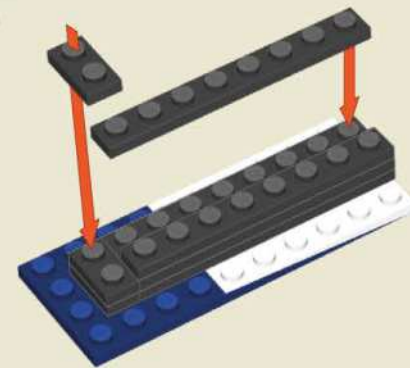

25

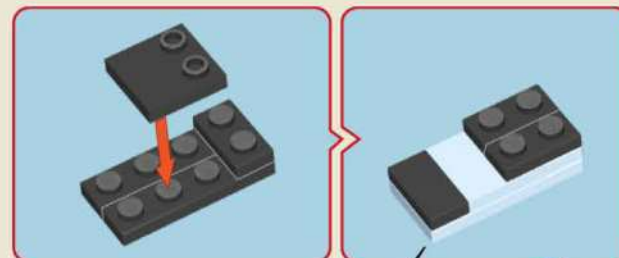
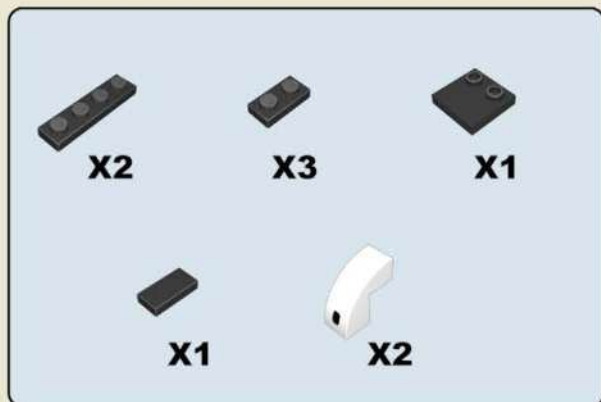

1:1

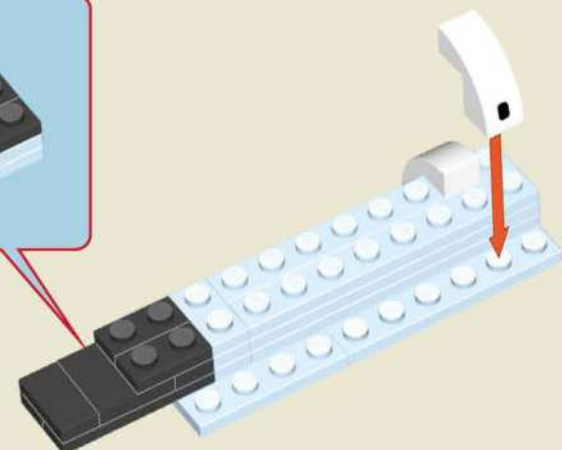

26

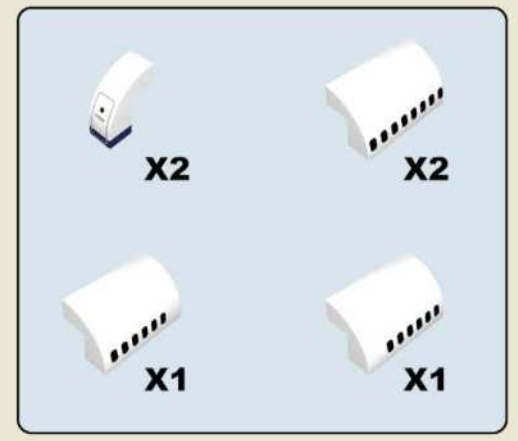
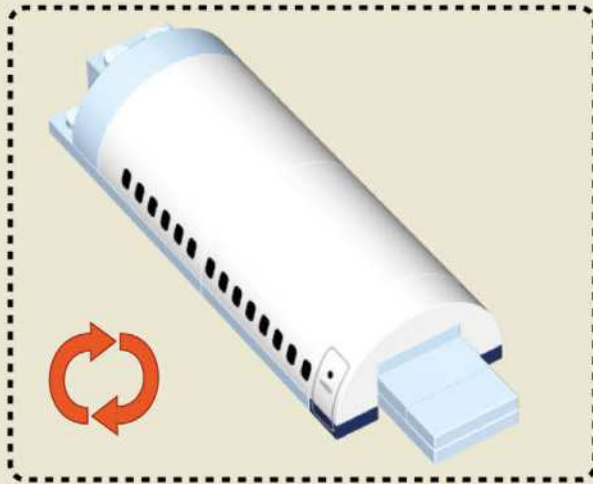
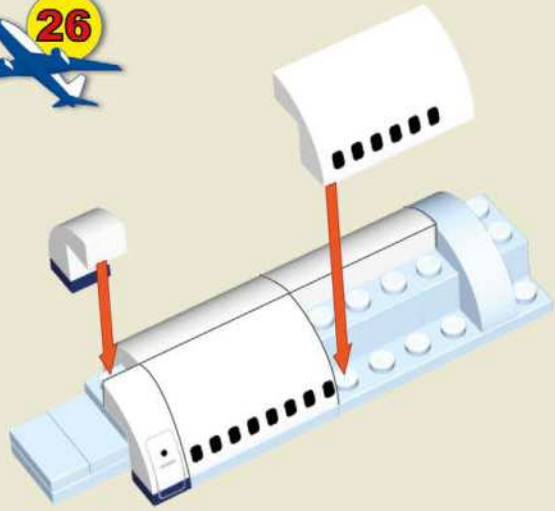

27

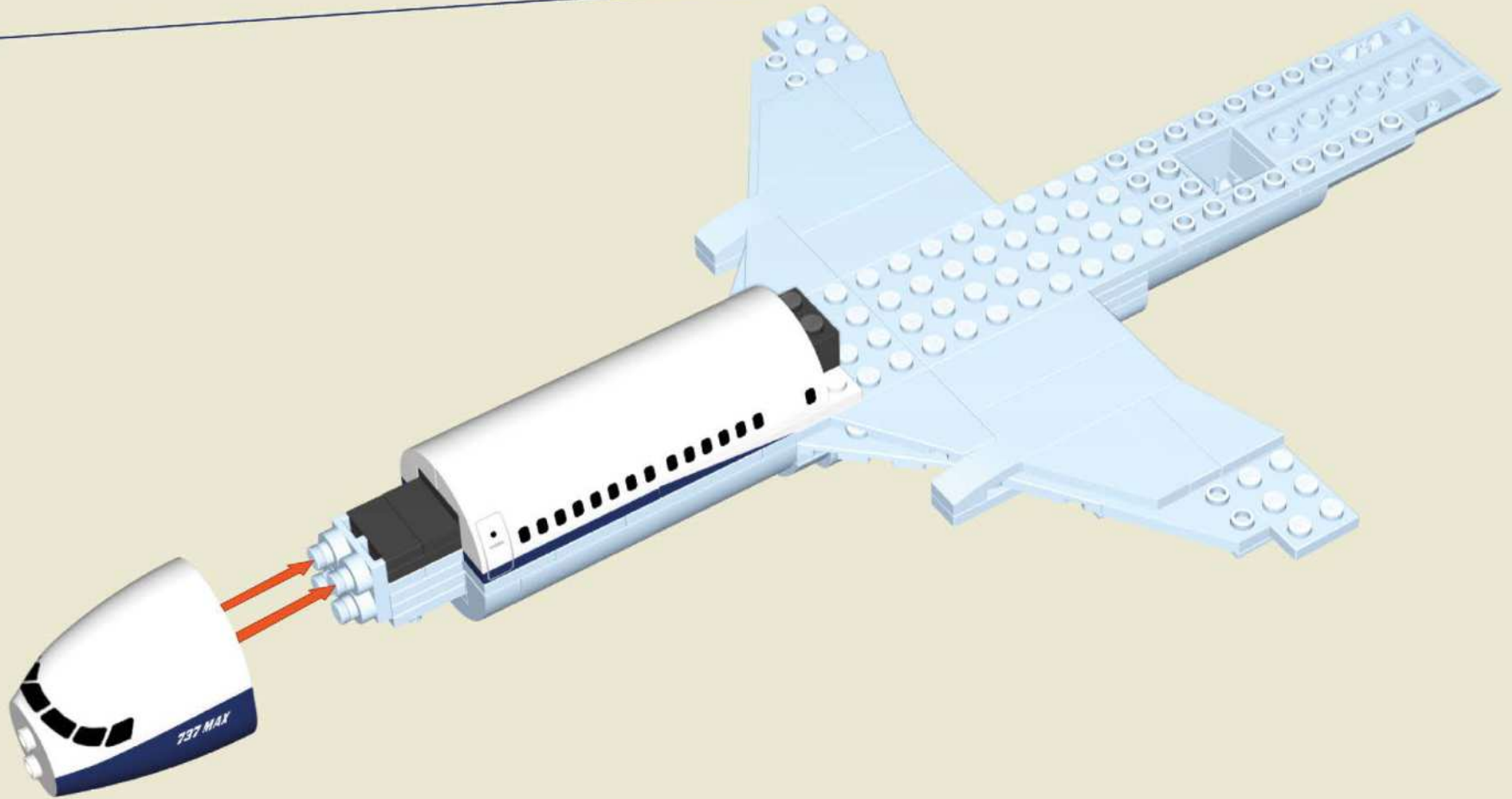

28

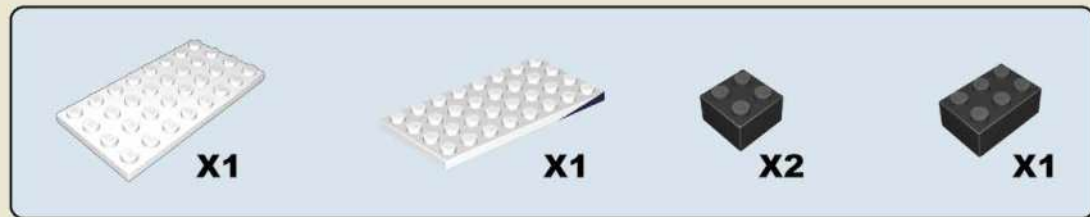
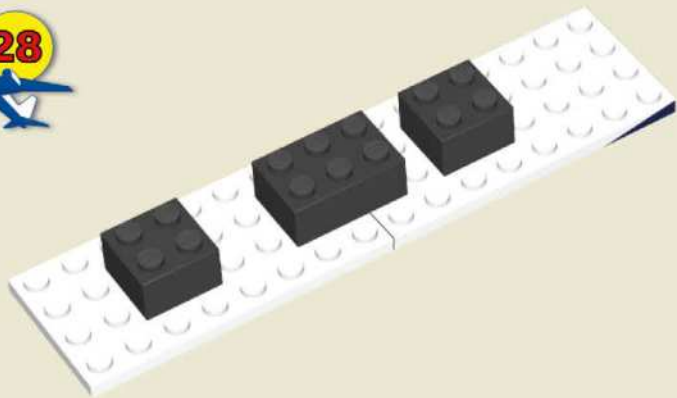

29

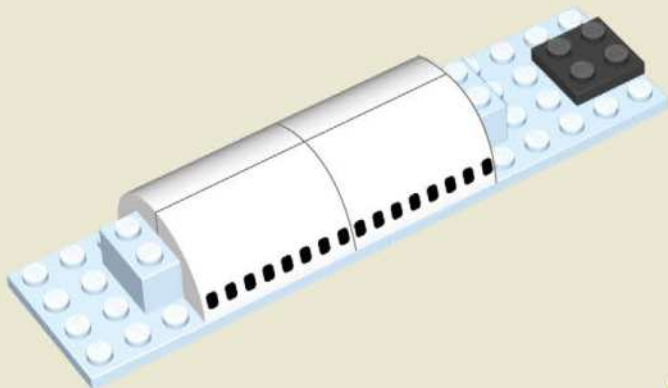

30



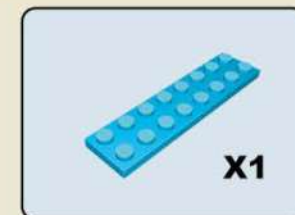
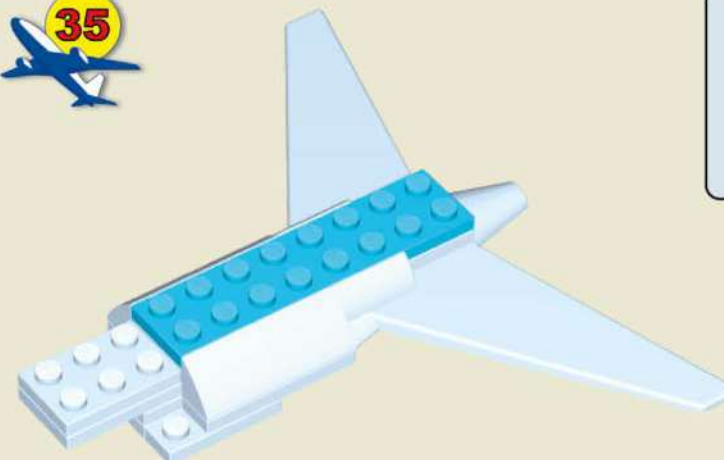
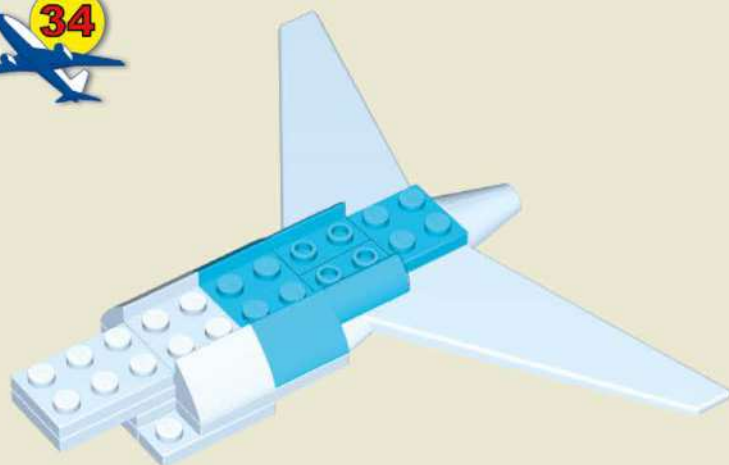
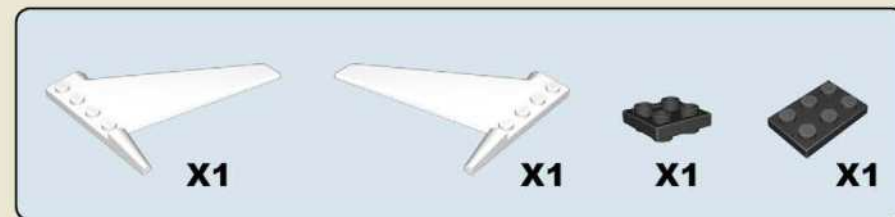
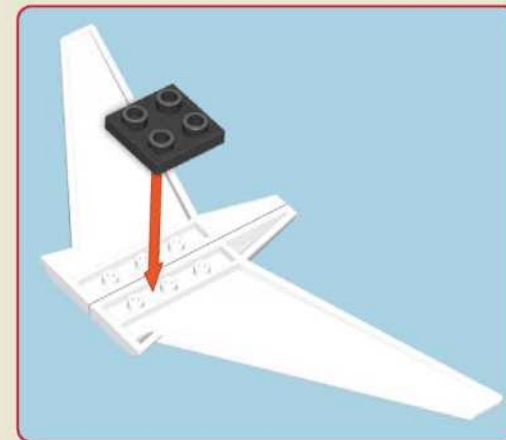
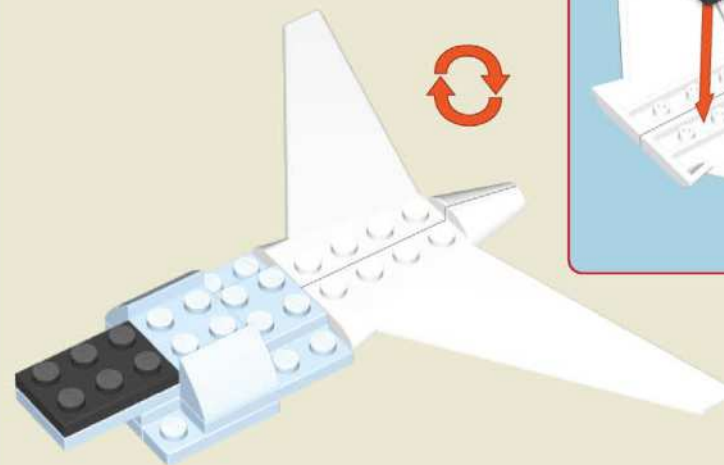
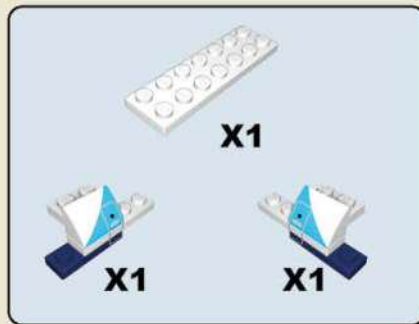
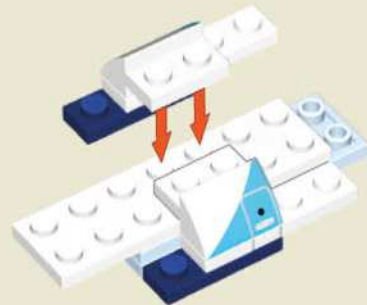
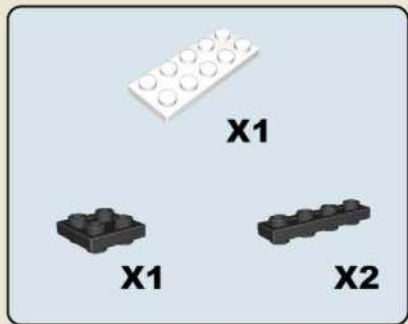
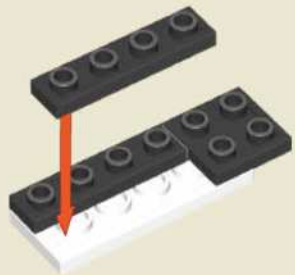



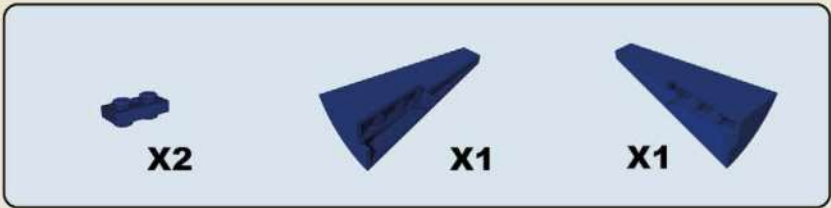

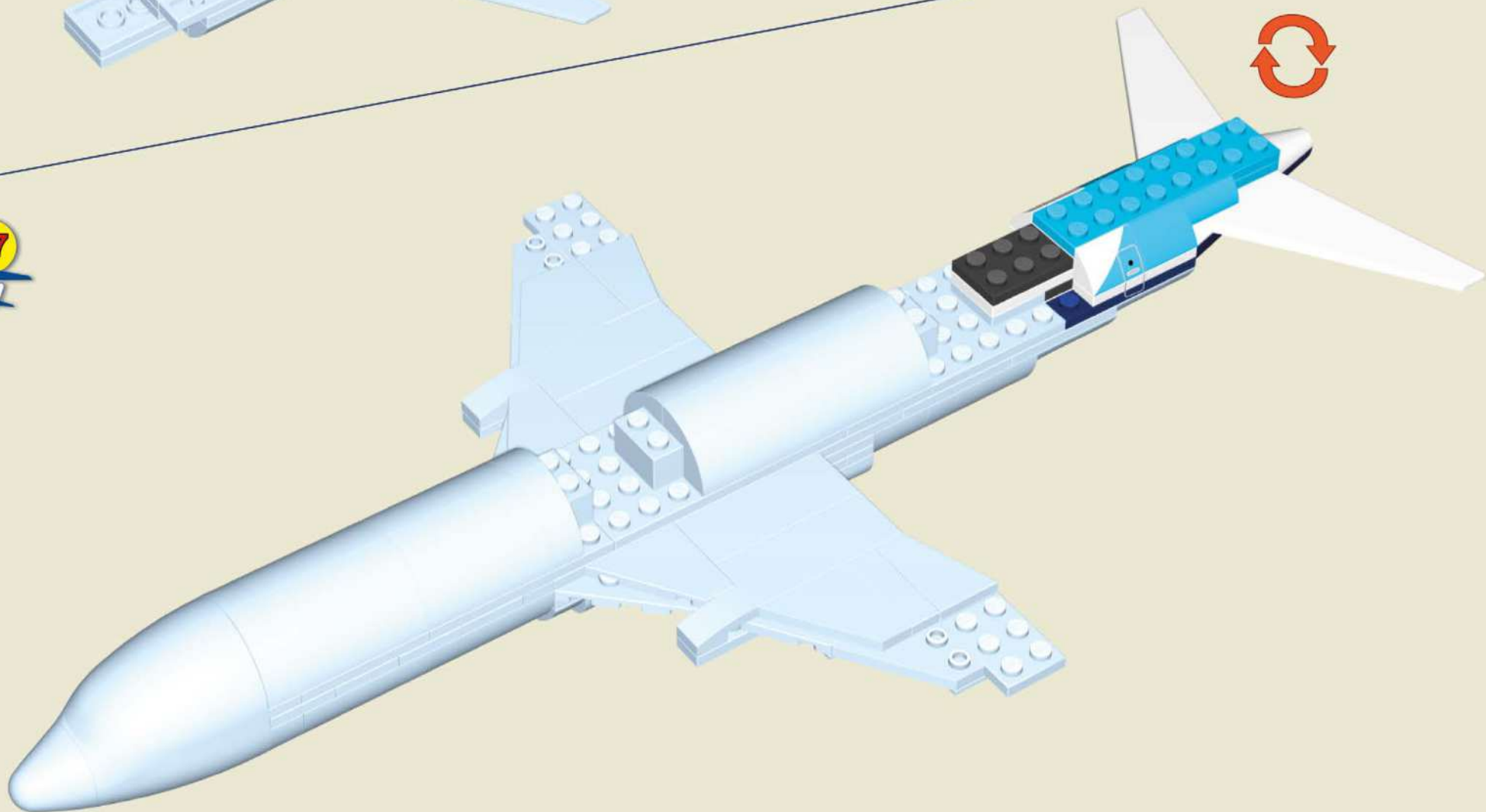

36

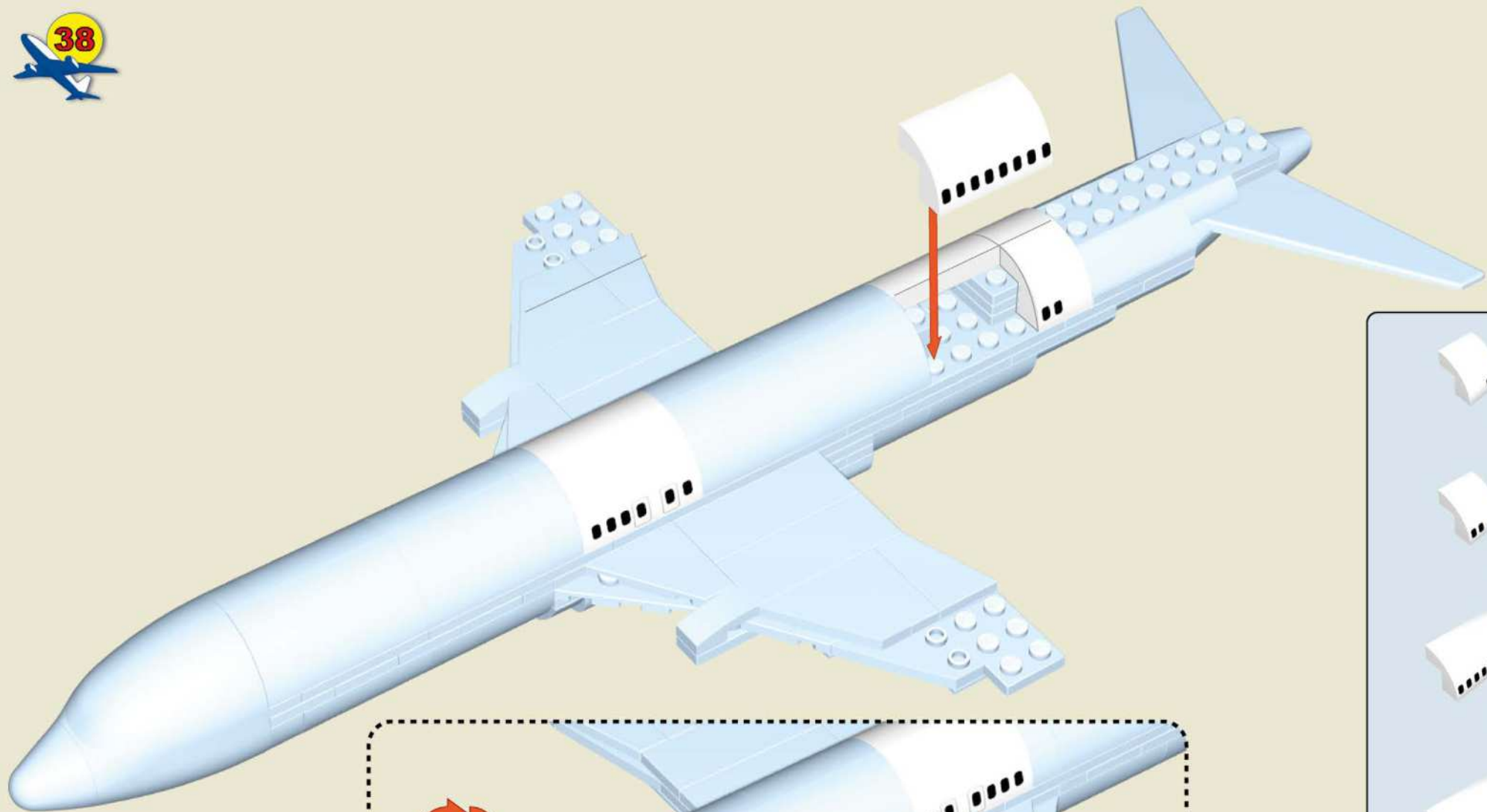

37





-  X1
-  X1
-  X2
-  X1
-  X1



X1



X1



X2



X4



X2

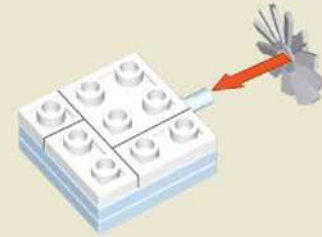

X2



X4



X2



X2



X2



X2



X2

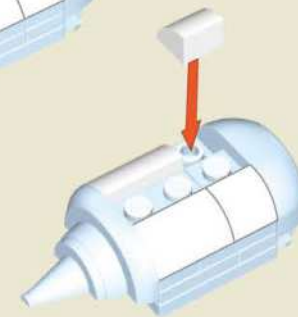
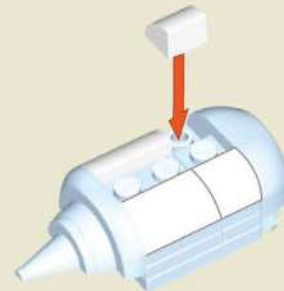

X4



X4

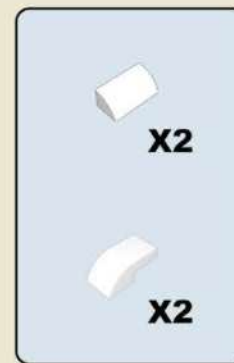
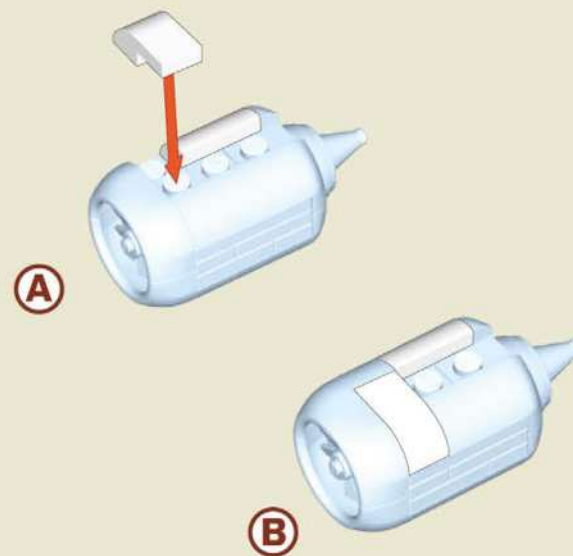
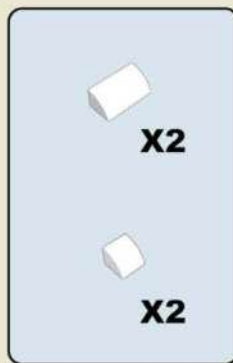
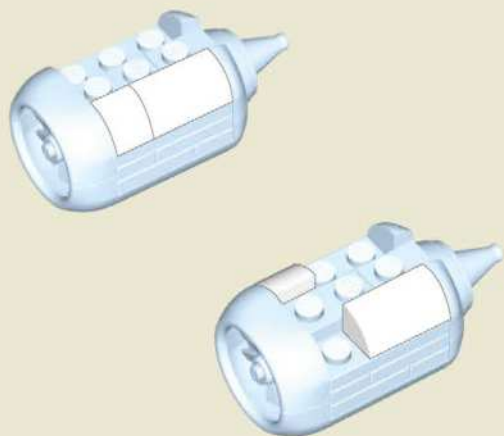
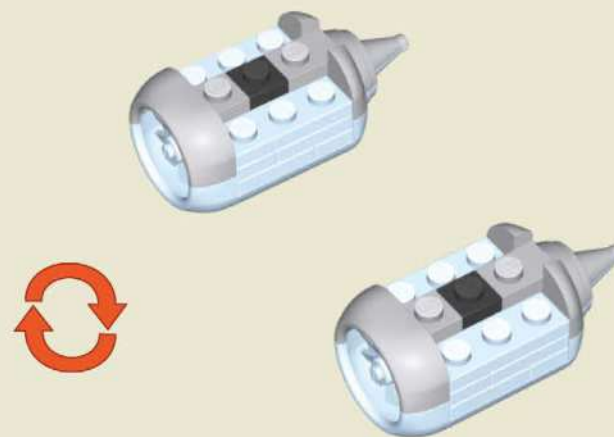
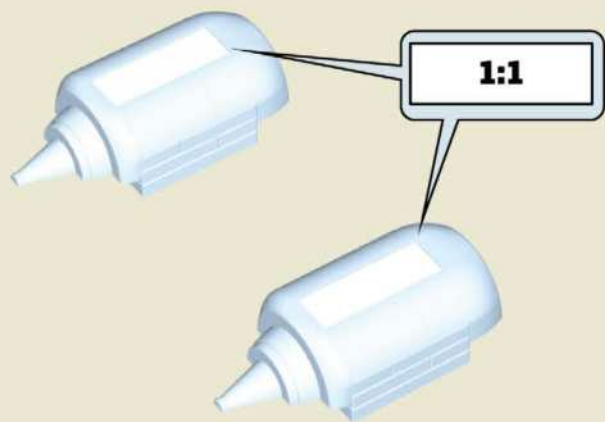

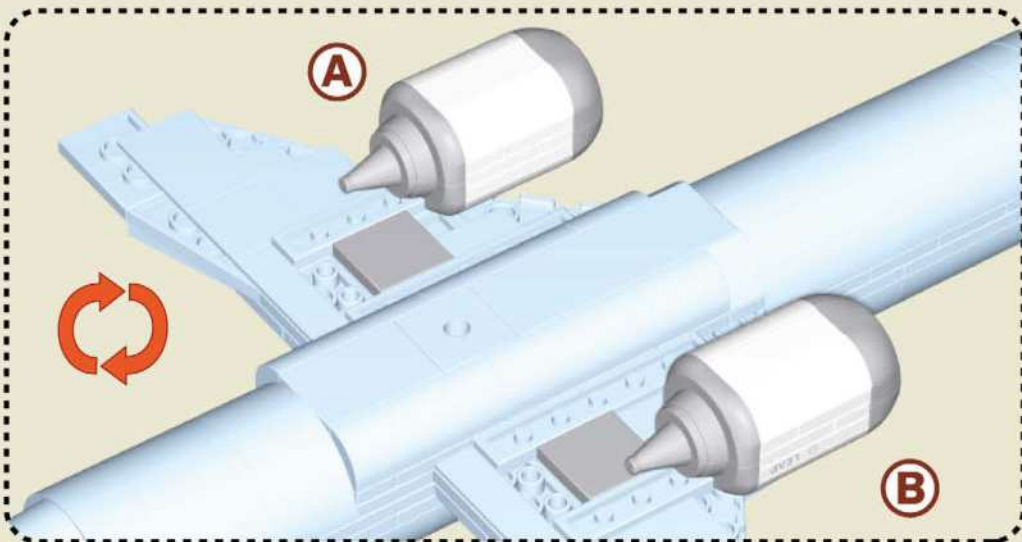
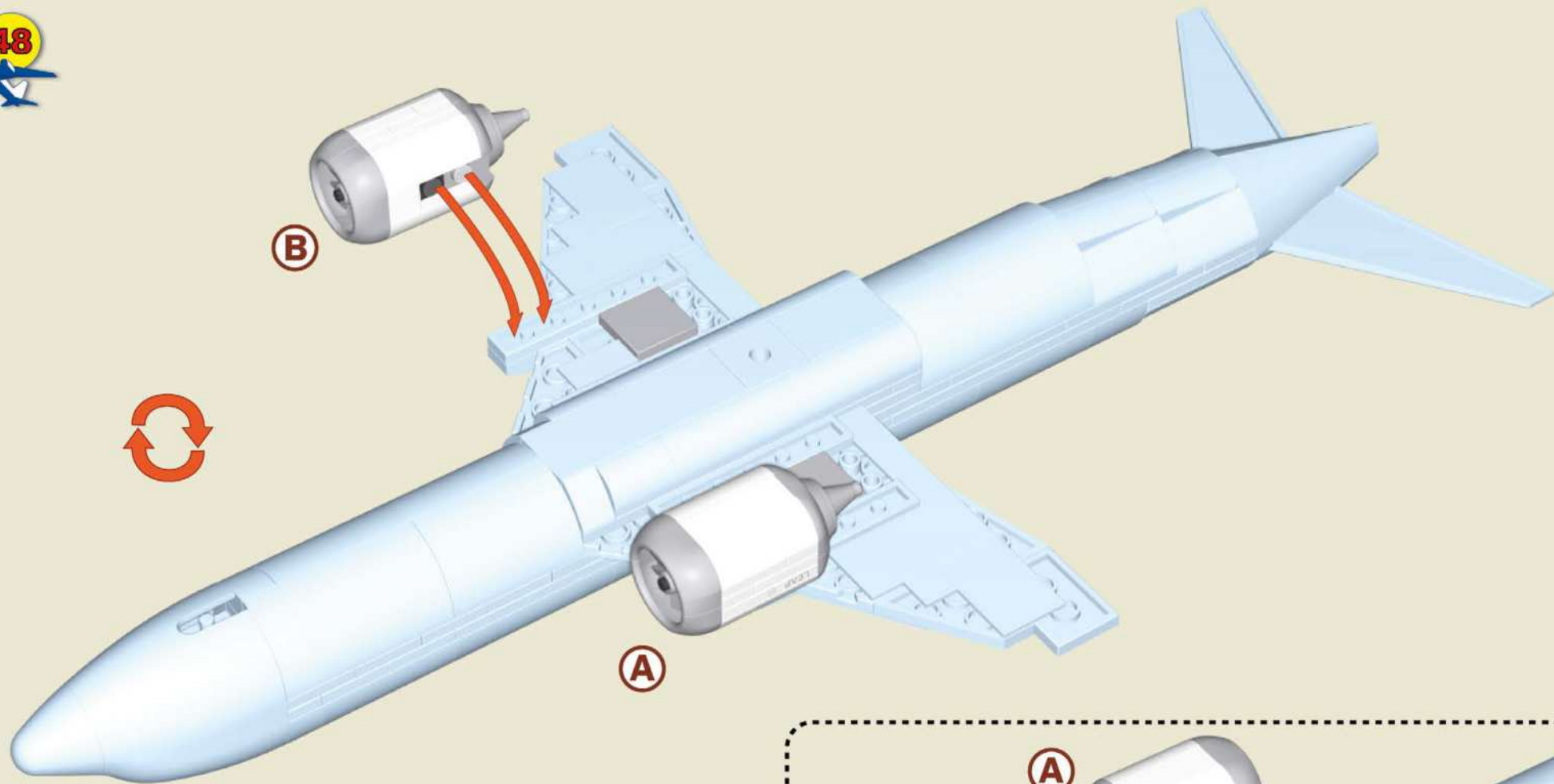

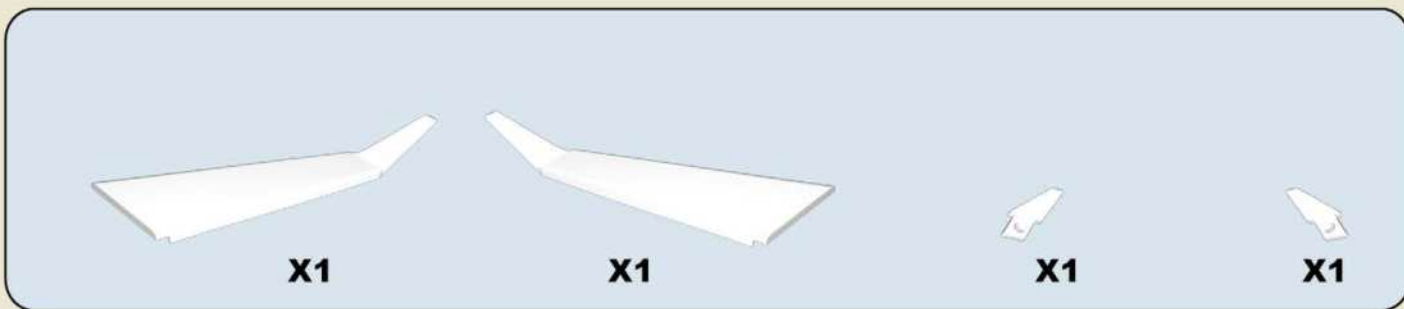
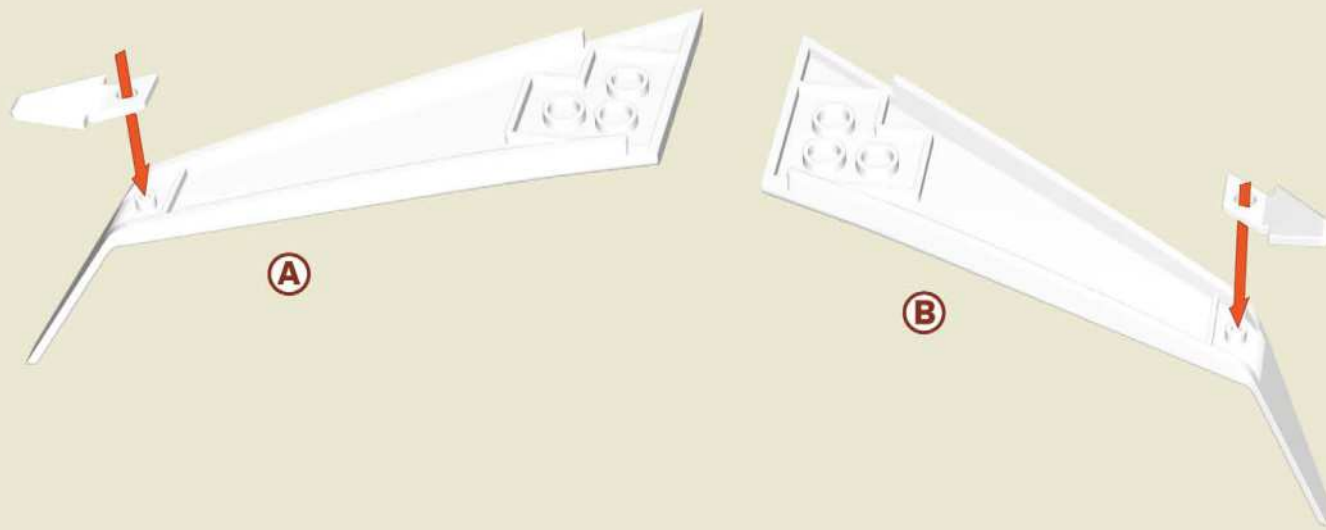

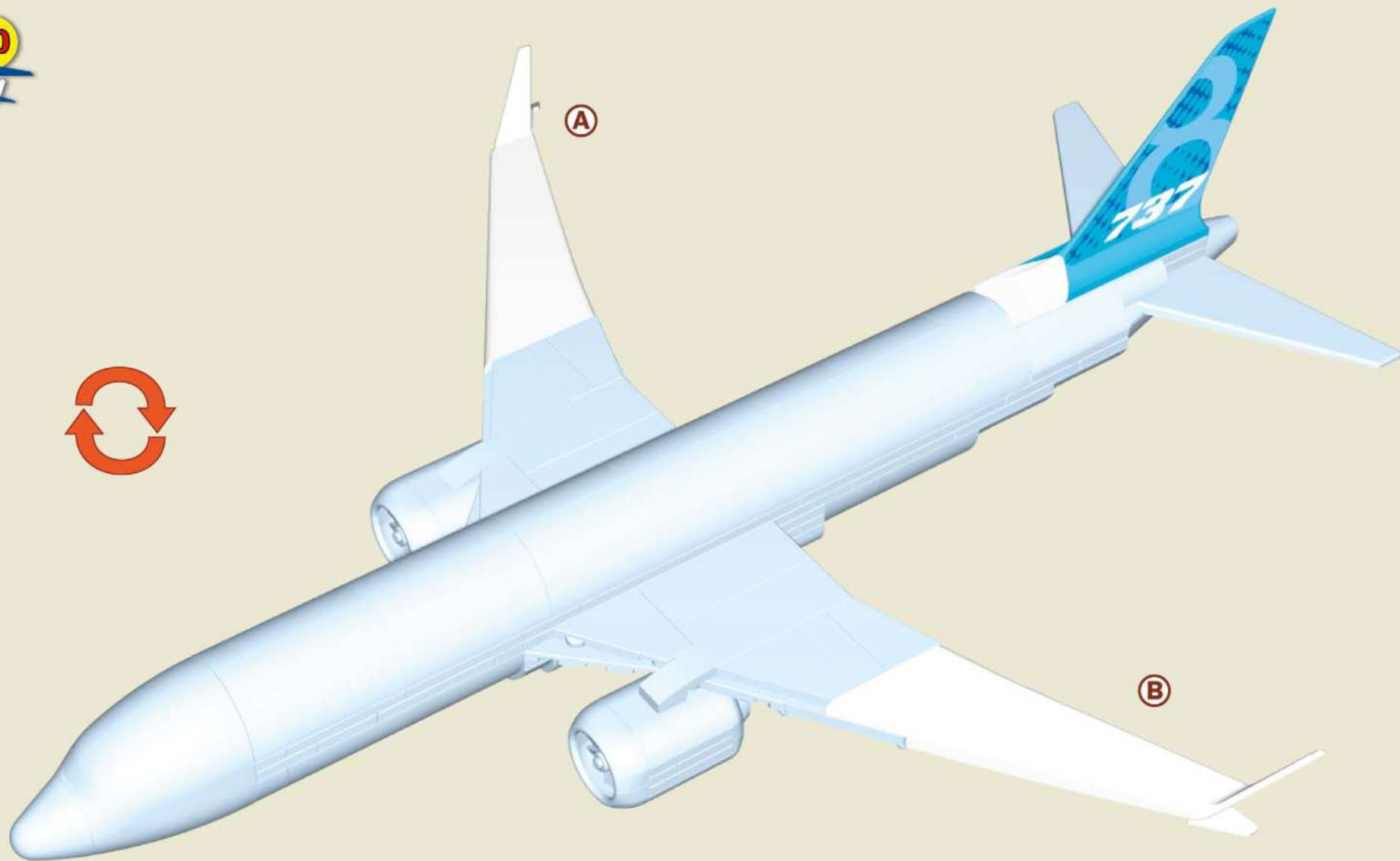

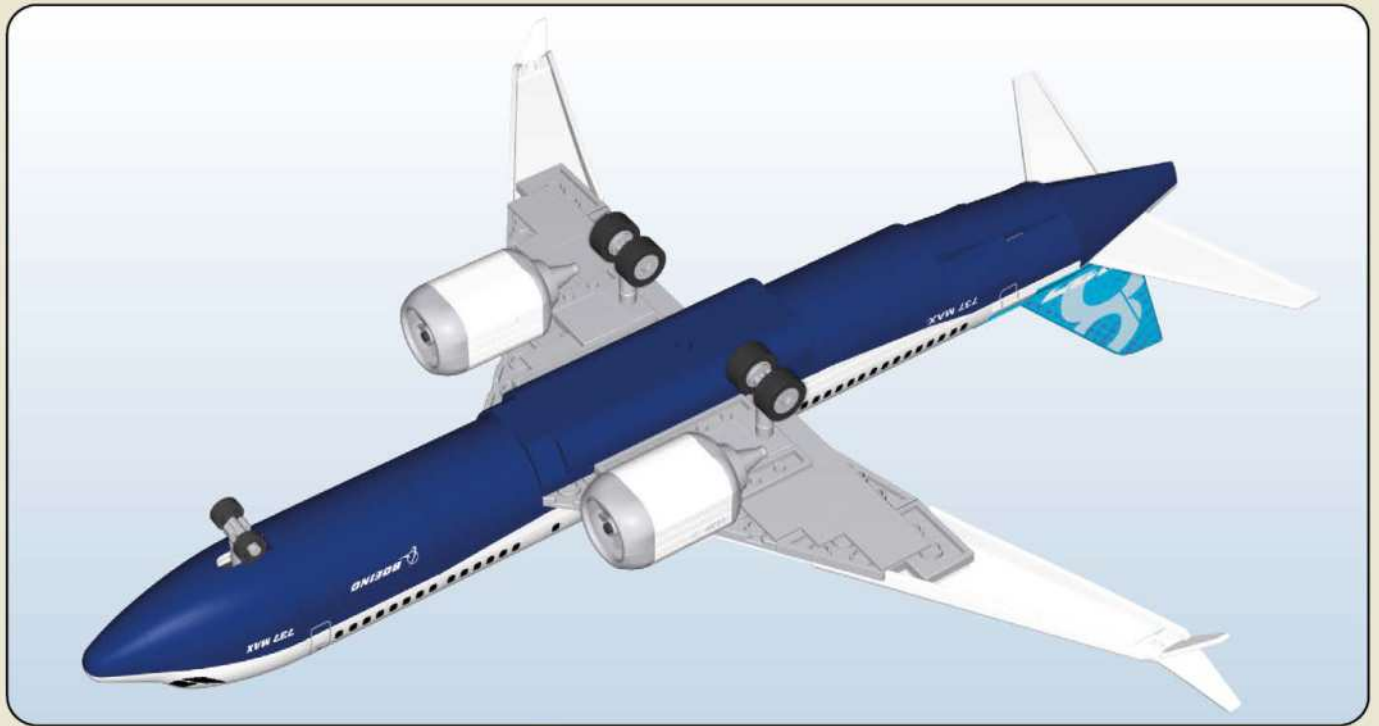

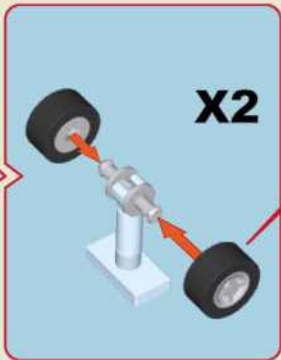
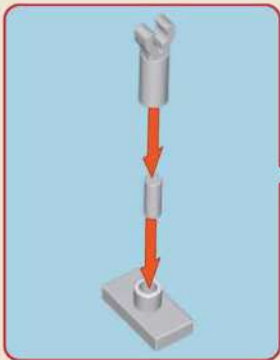

| | | | |
|-----------|-----------|-----------|-----------|
| | | | |
| X2 | X2 | X3 | X2 |
| | | | |
| X4 | X4 | X1 | X2 |

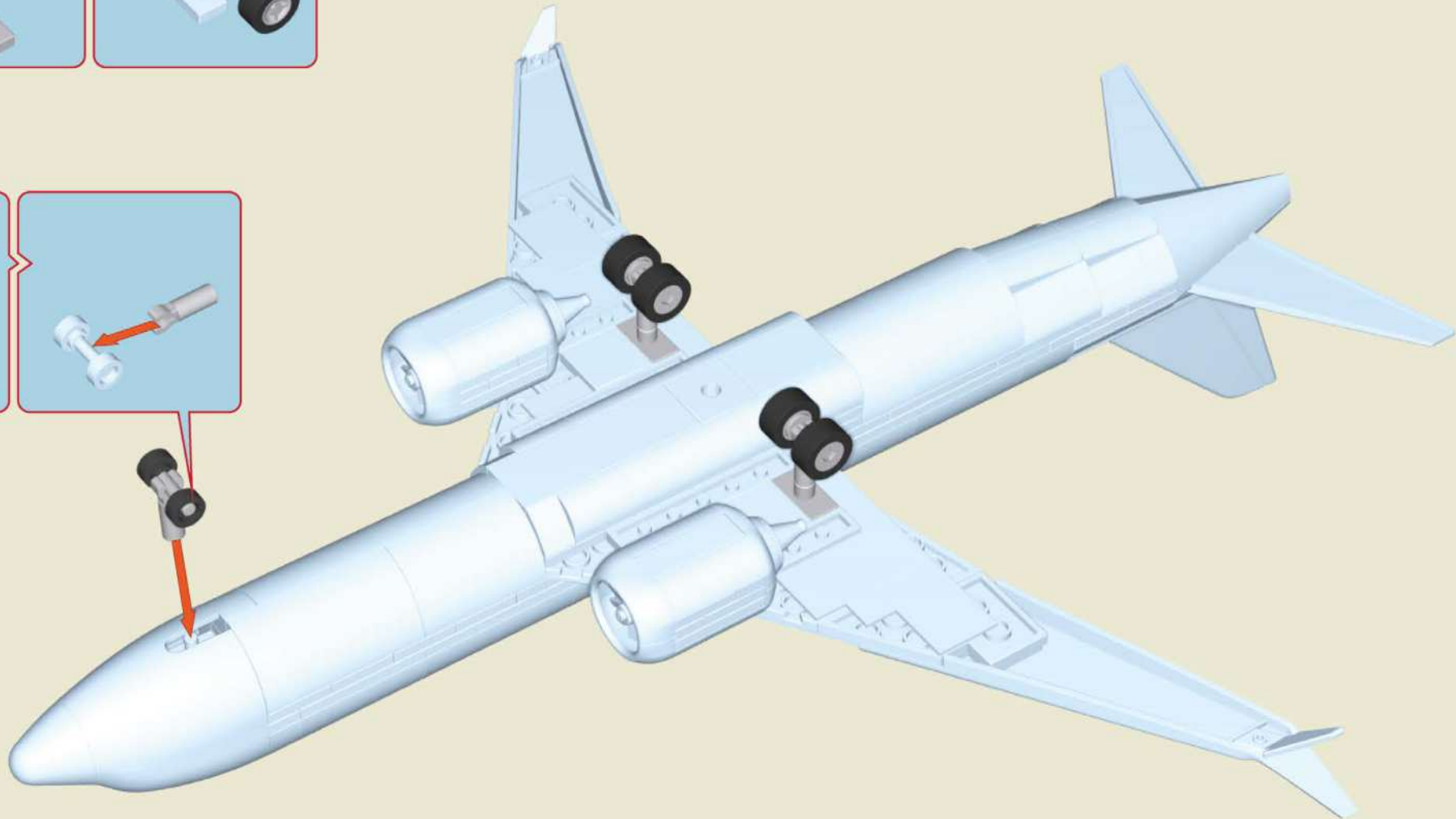
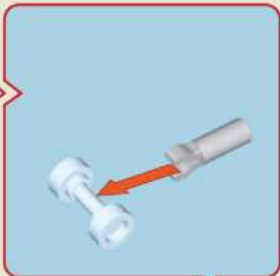
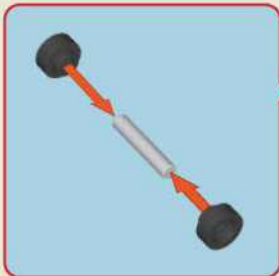

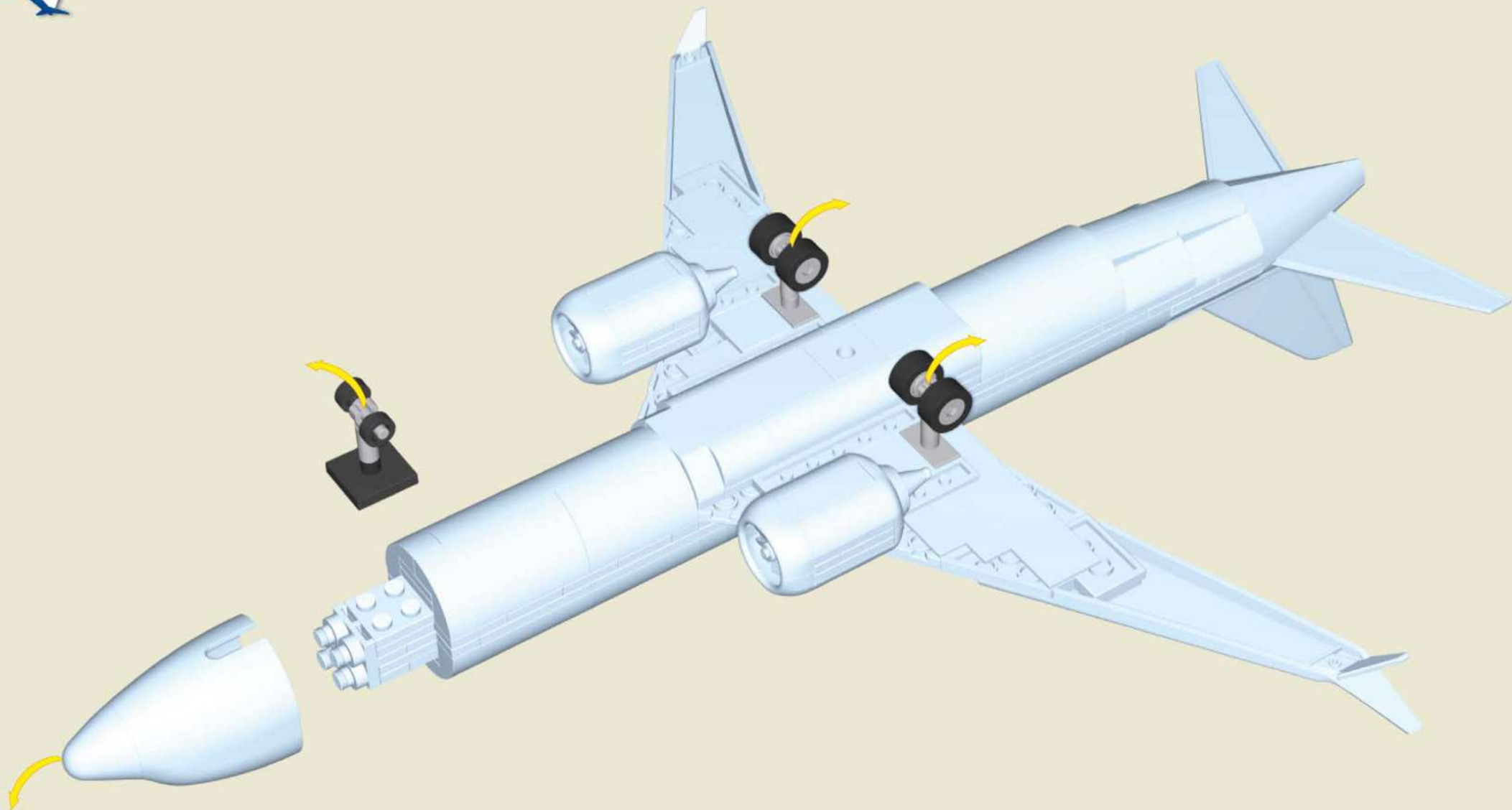

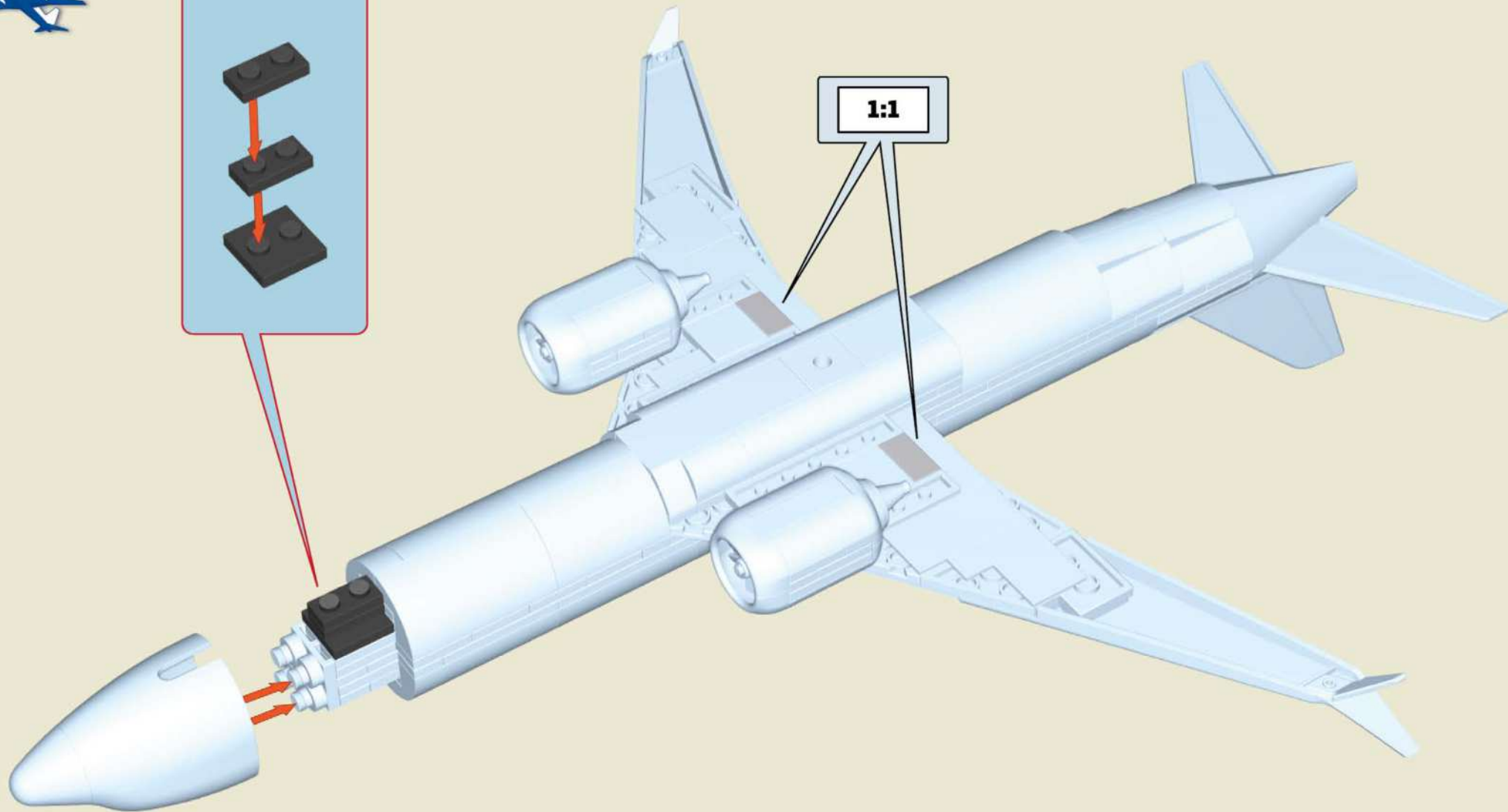
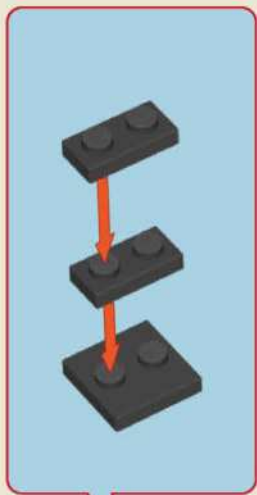

-  X1
-  X2
-  X2

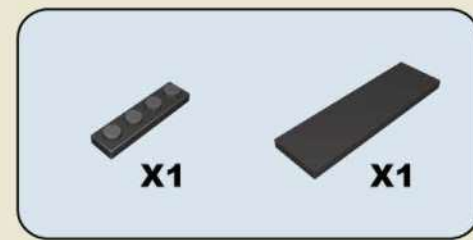
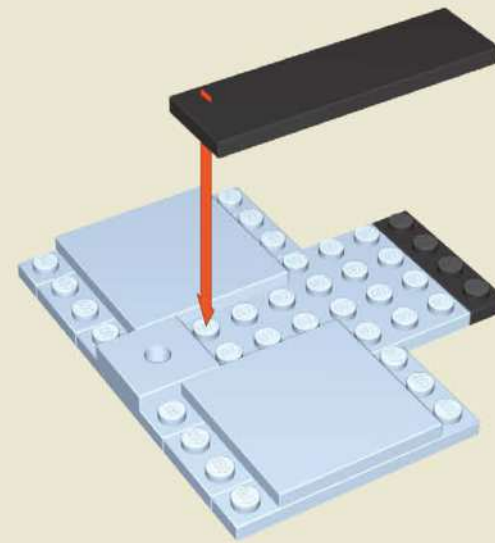
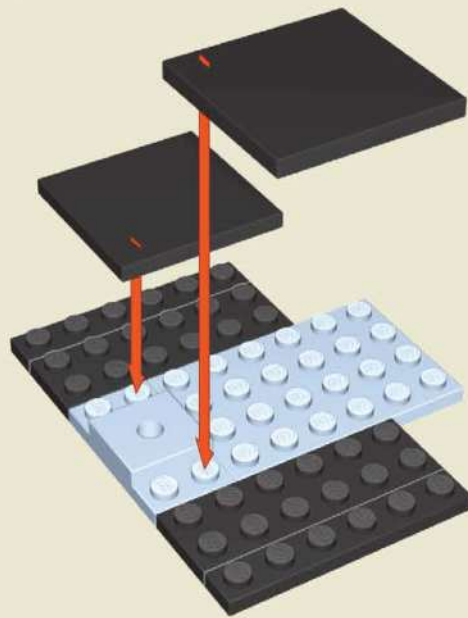
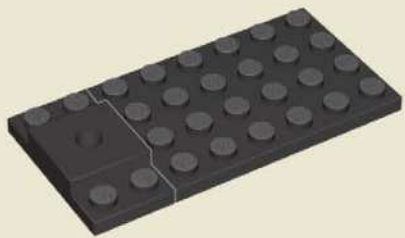

57

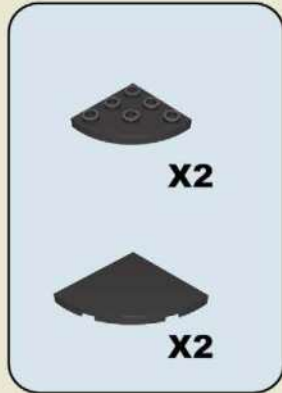
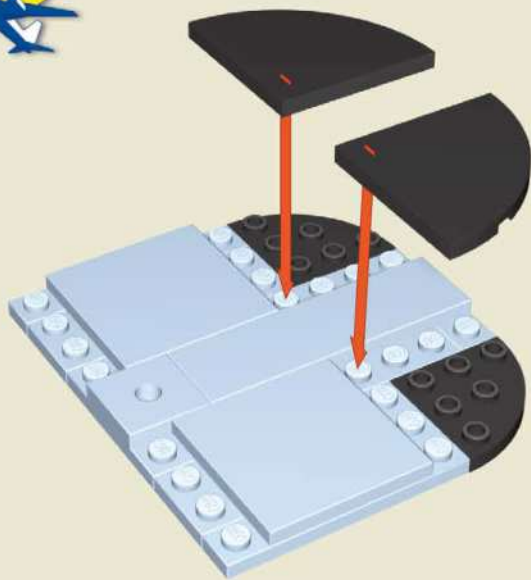

58

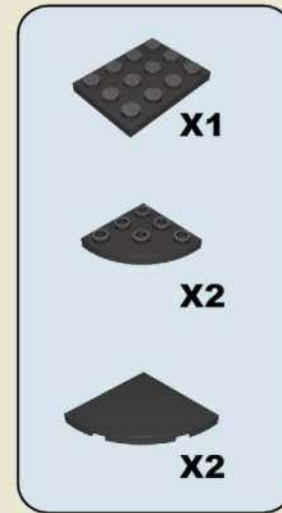
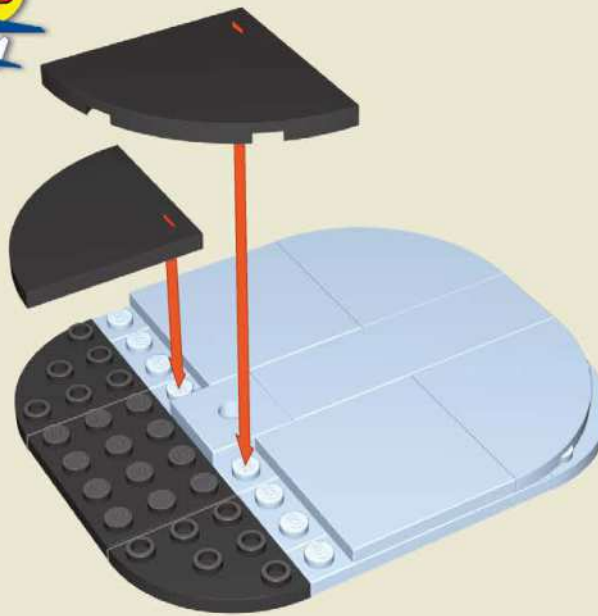

59

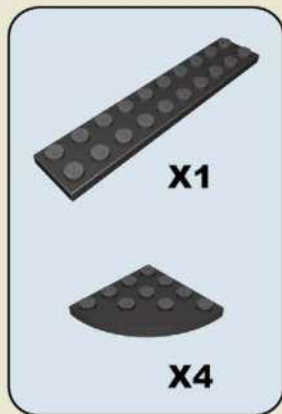
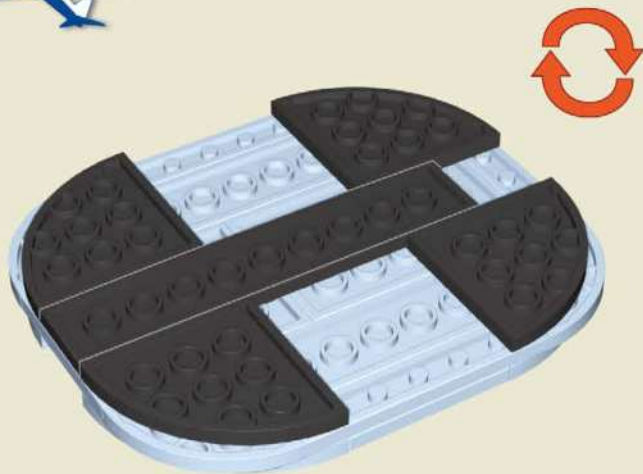

60

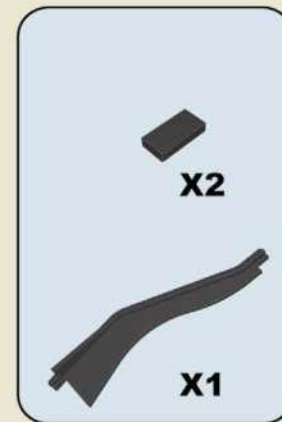

-  x2
-  x1
-  x1

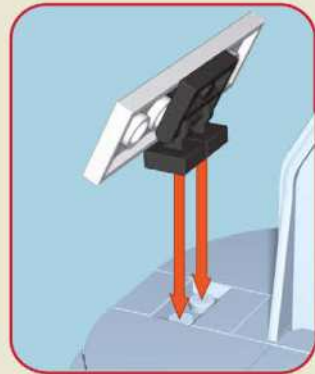
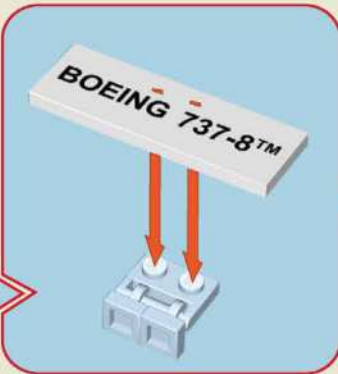
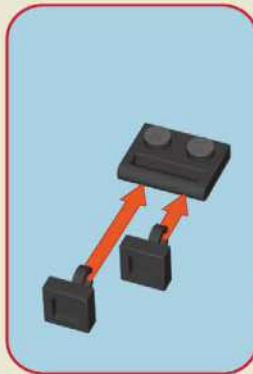

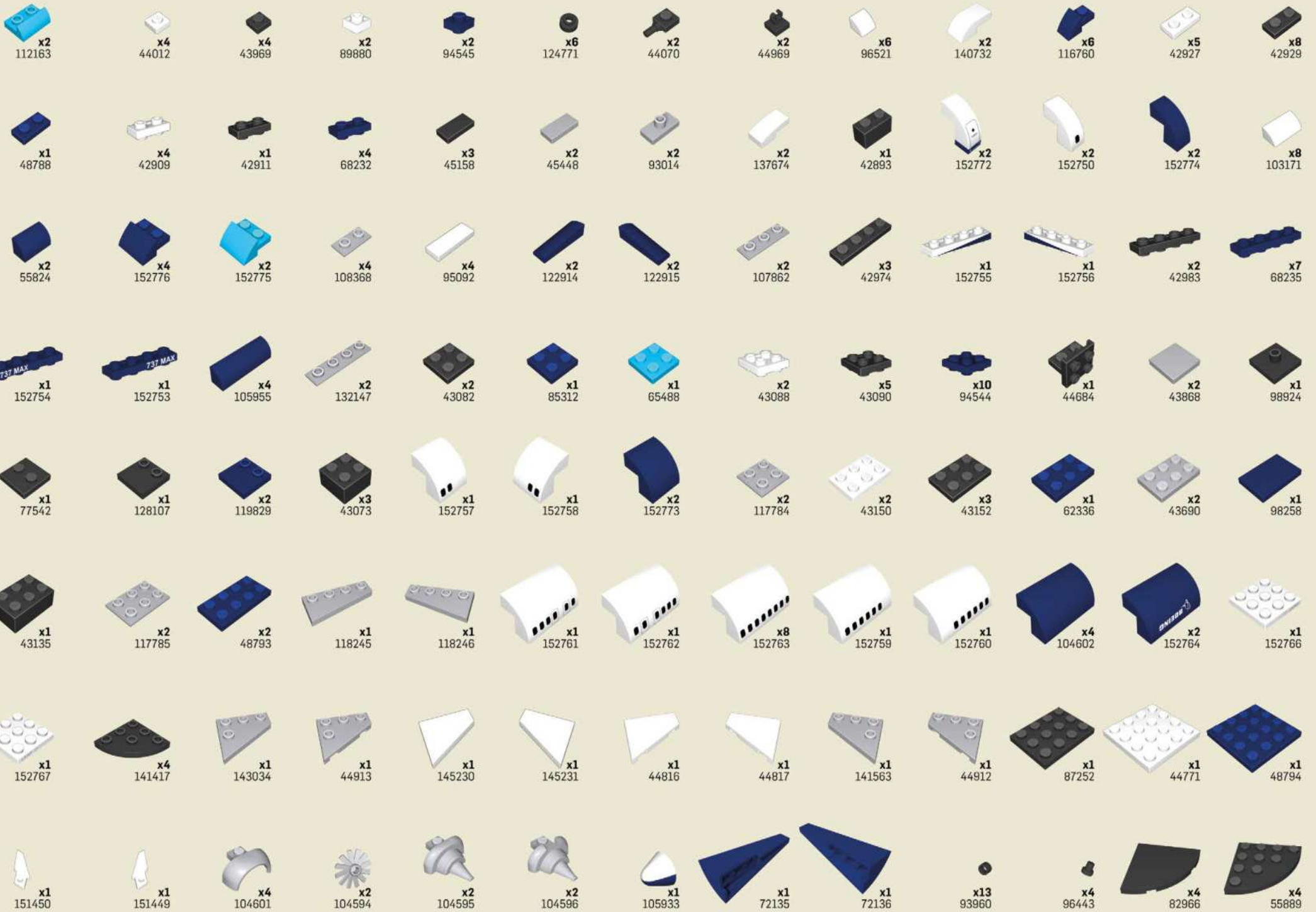



Customer Service
 Kundenservice
 Obsługa Klienta
www.cobi.eu/service

10-26608-338 □

For
news and
special deals

Find us on:
cobi.bricks
cobi.klocki
COBI SA