

HISTORICAL COLLECTION

WORLD WAR II



HAWKER HURRICANE MK. I

PLACE OF ORIGIN - UNITED KINGDOM
IN SERVICE - 1937 - 1944
ROLE - FIGHTER
CREW - 1
WINGSPAN - 12,19M (39'11")
LENGTH - 9,58M (31'5")
HEIGHT - 4,01M (13'2")
WEIGHT - 3020KG (6660LB)
ENGINE - ROLLS-ROYCE MERLIN MK II
RANGE - 840KM (521MI, 453NMI)
RATE OF CLIMB - 8,5M/S (1673FT/MIN)
MAXIMUM FLIGHT LEVEL - 9970M (32,710FT)
ARMAMENT - 8x 7.7MM (0.303") BROWNING MG
SPEED - 509KM/H (316MPH)



PAD PRINTED
NO STICKERS

5728

Printed in EU



UK
CA CE



WARNING: CHOKING HAZARD-
Toy contains small parts.
Not for children under 3 years.

382  1 

HAWKER HURRICANE MK.I

SCALE 1:32

1

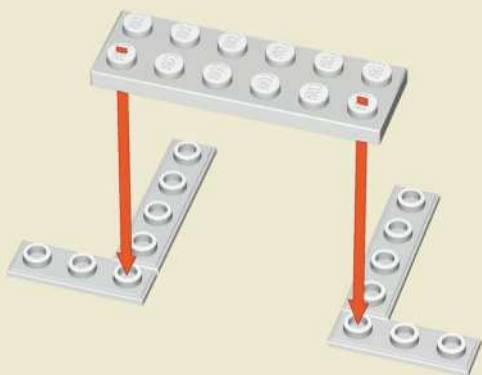

x2

x2

x1

2

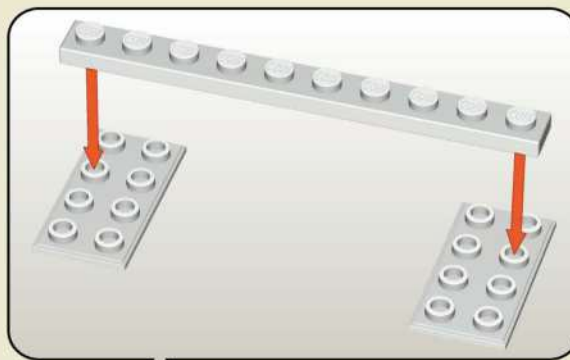

x1

x1

x2

3

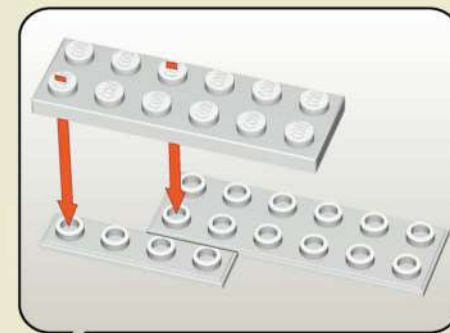
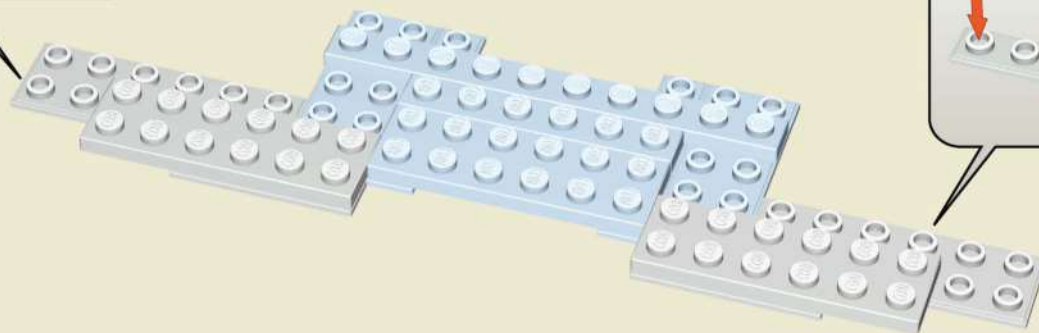
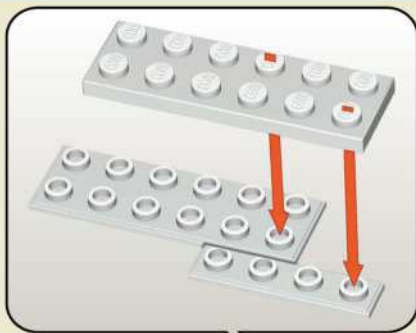

x2

x2

x2

4

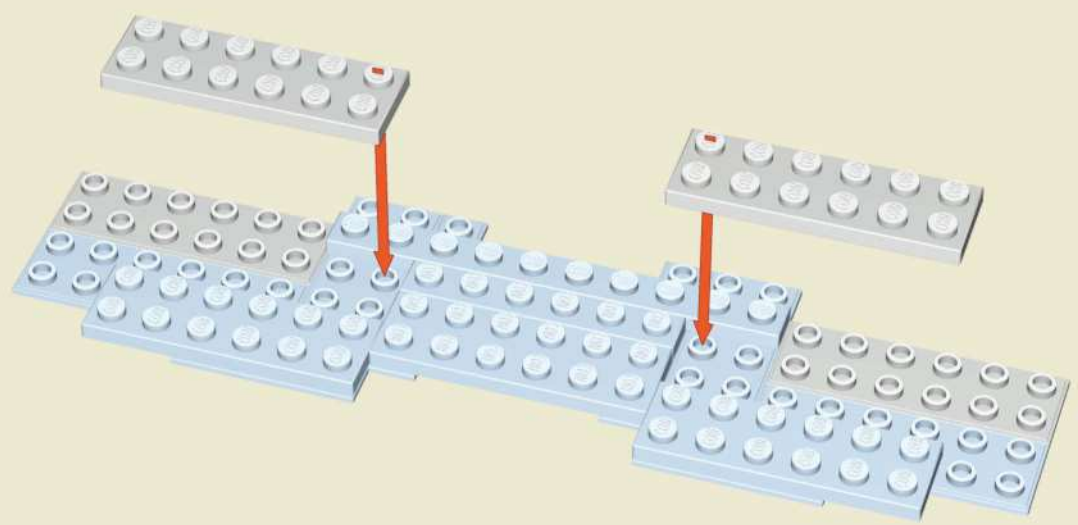

5

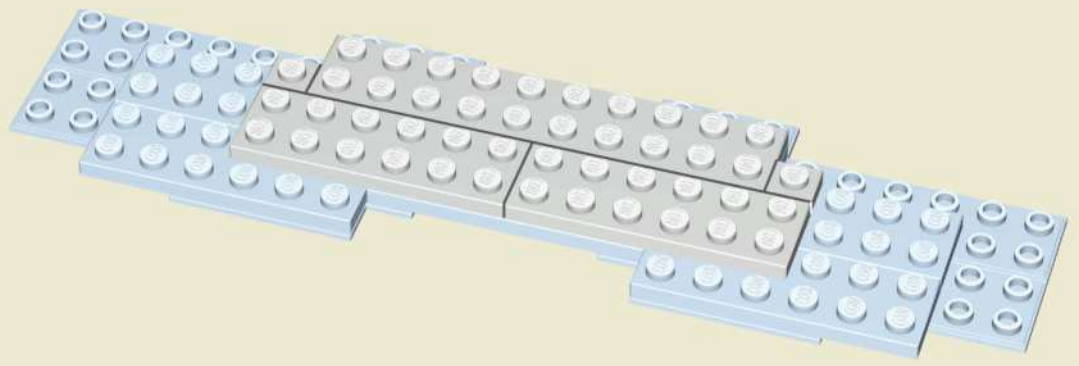

6

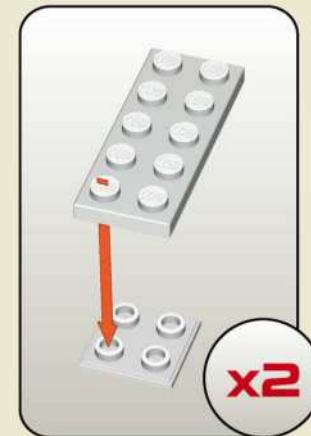
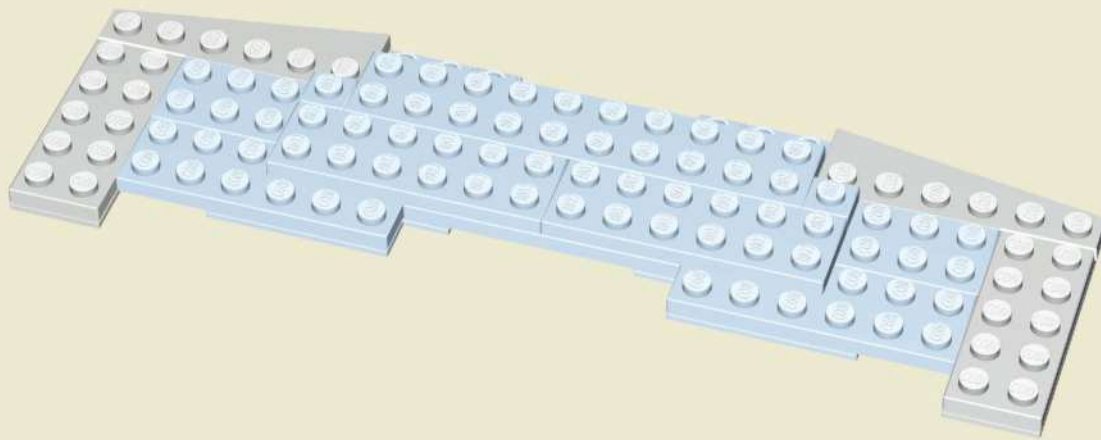

-  x1
-  x1
-  x2
-  x2



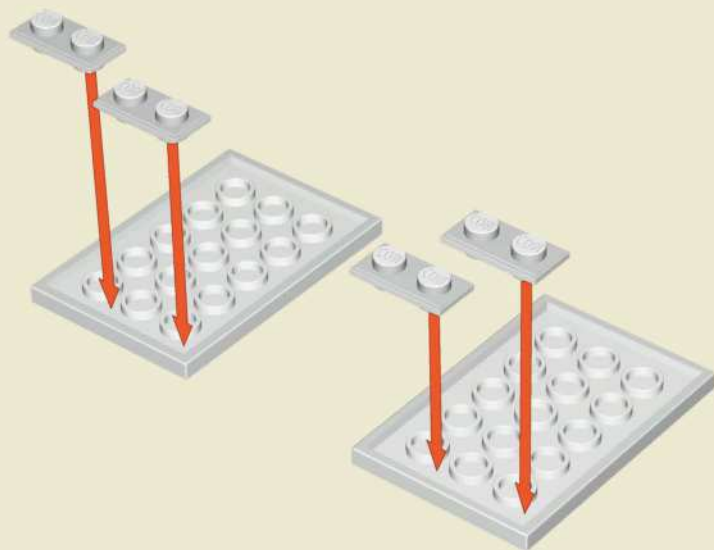

7

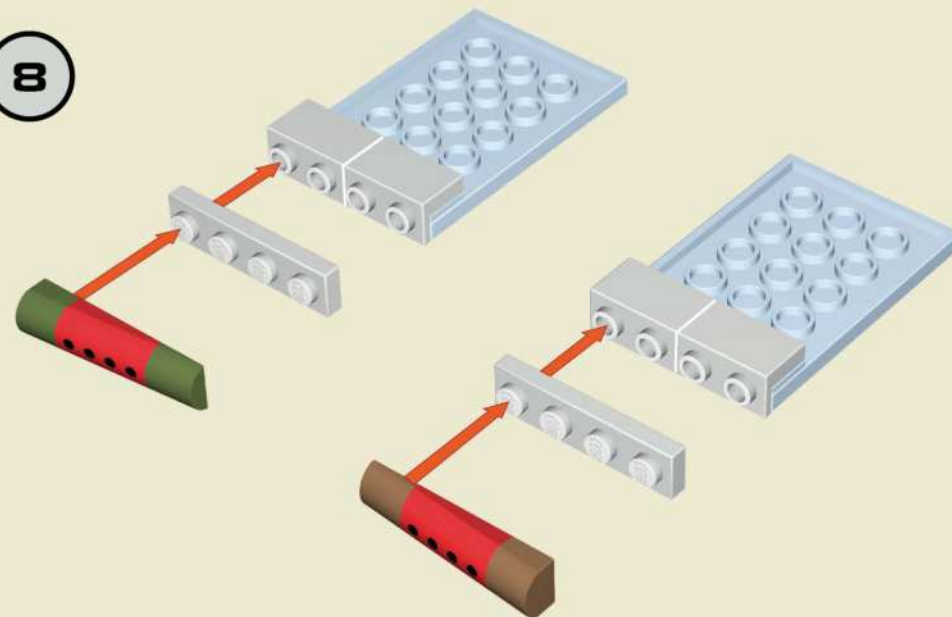

-  x2
-  x4





8

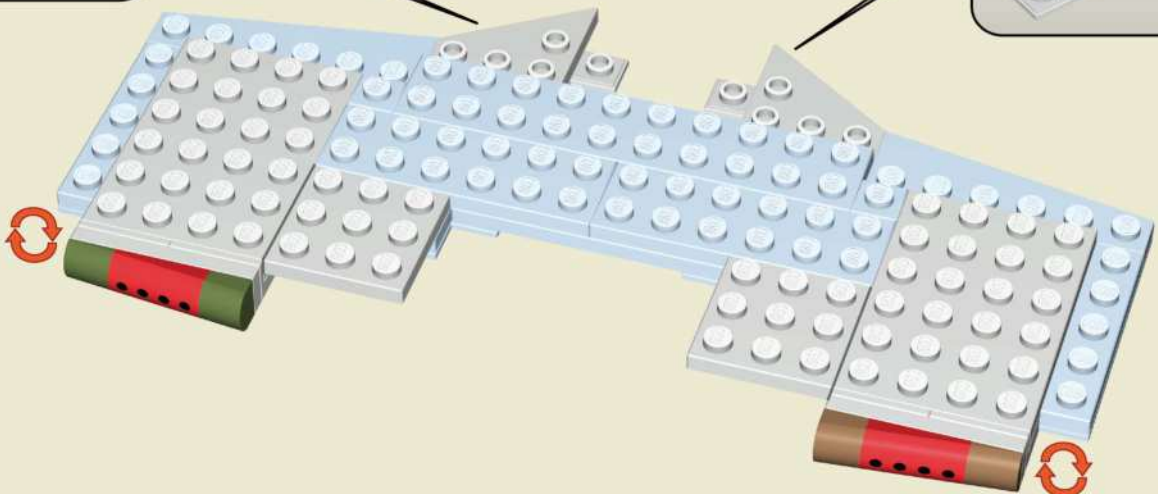
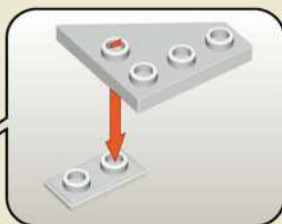
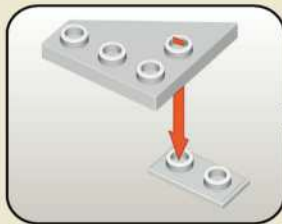

-  x4
-  x2
-  x1
-  x1







9

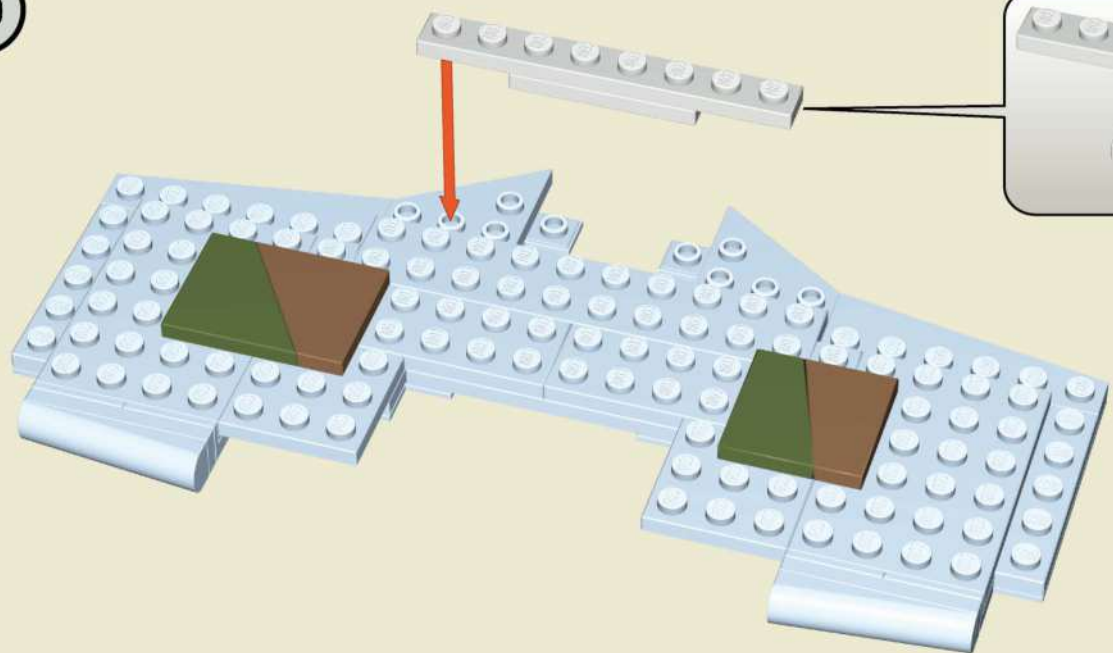

-  x2
-  x1
-  x1
-  x2

10



-  x1
-  x1
-  x1
-  x1
-  x1
-  x1

11

1:1

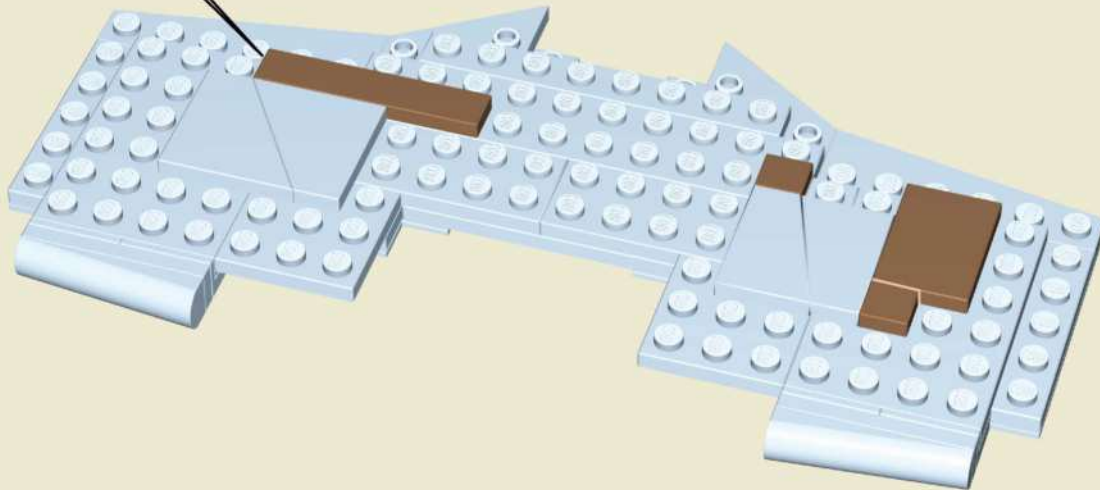

- x1
- x1
- x2

1:1

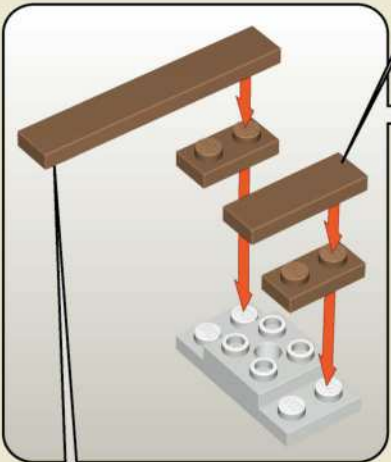

1:1

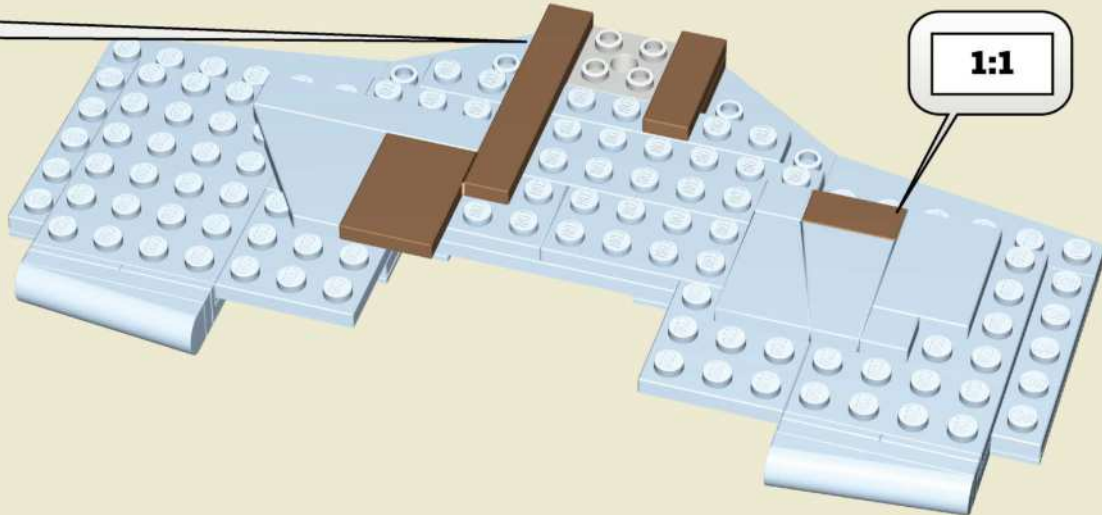

12

1:1

- x1
- x2
- x1
- x1
- x1
- x1

13

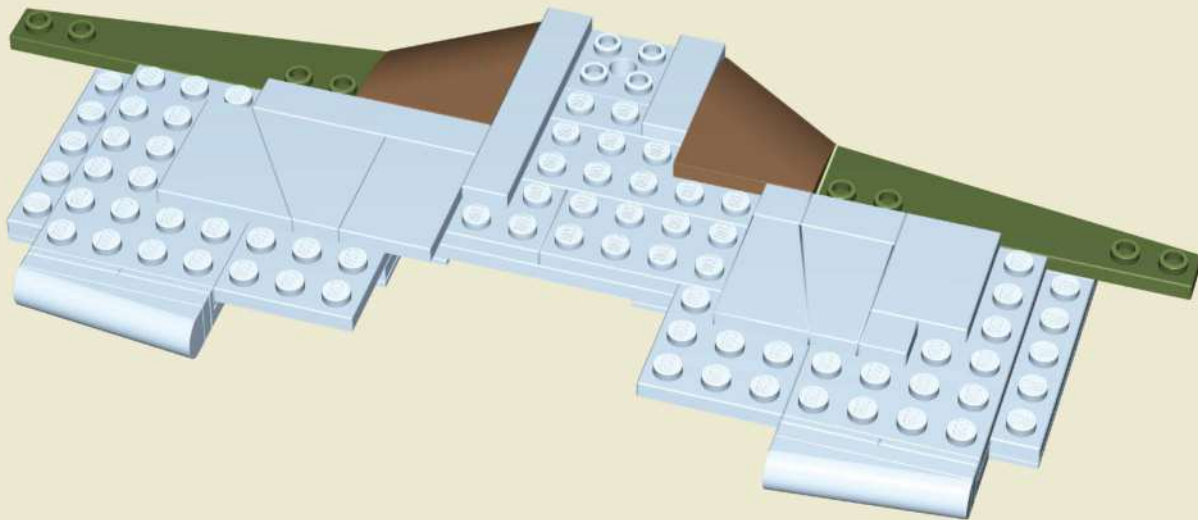

x1



x1



x1



x1

14

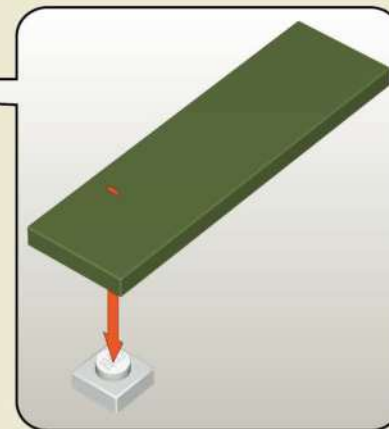
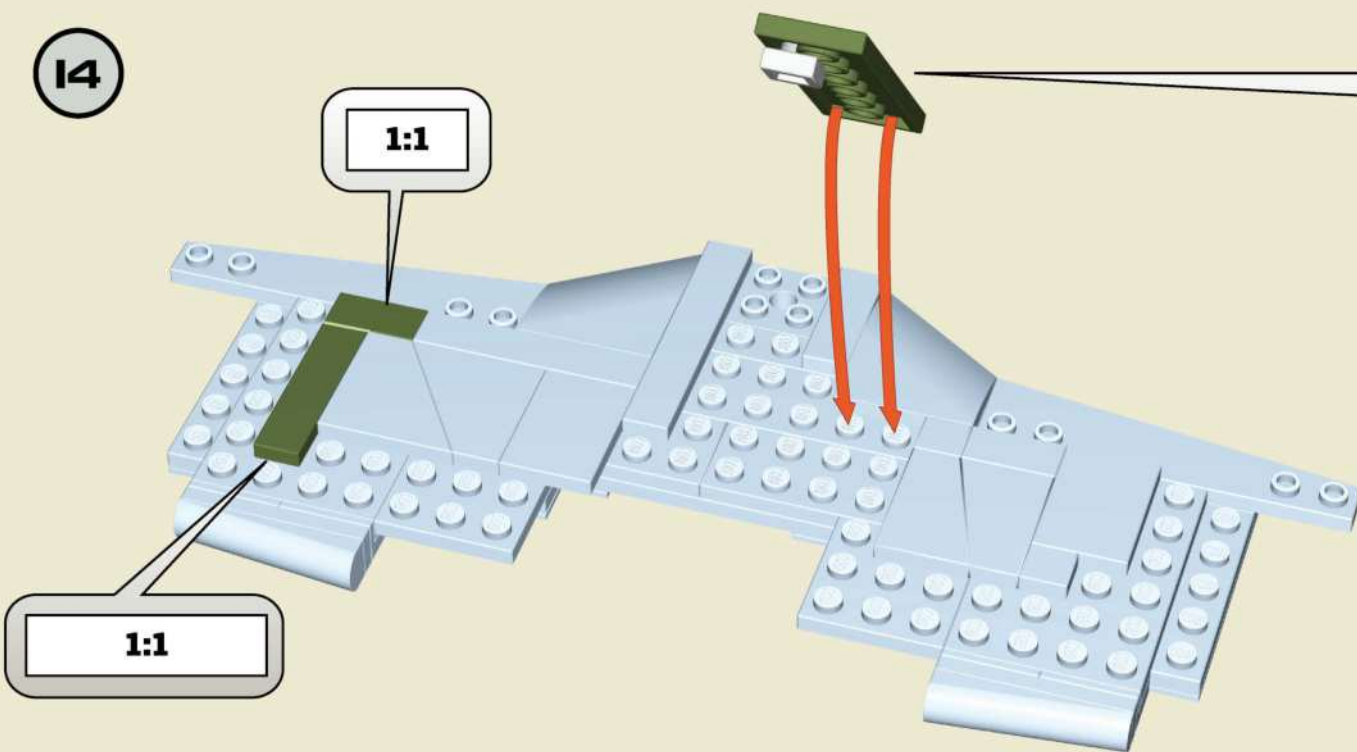

x1



x1



x1



x1

15

1:1

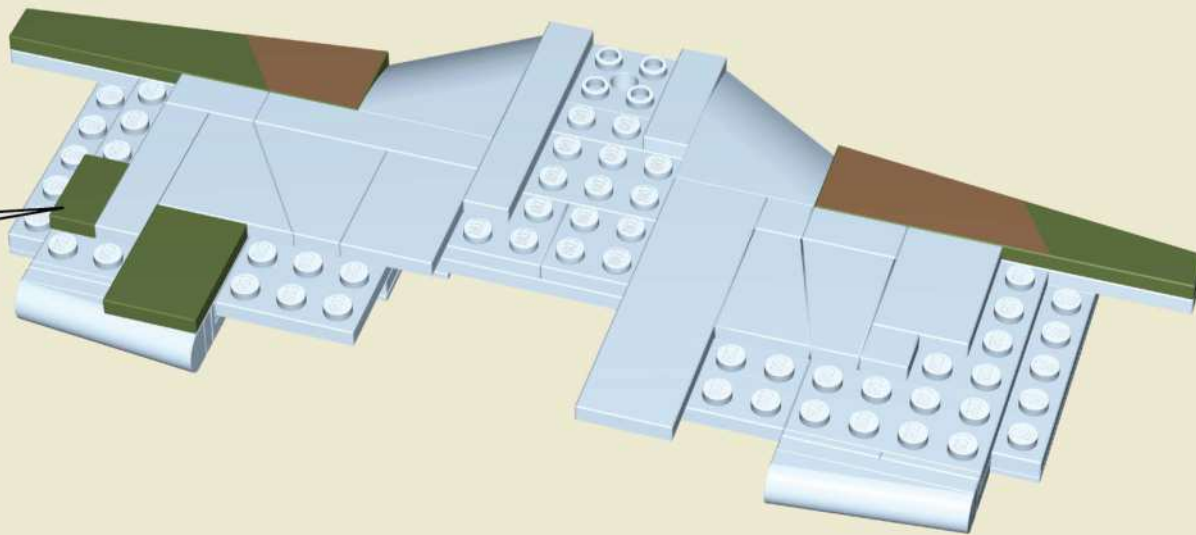



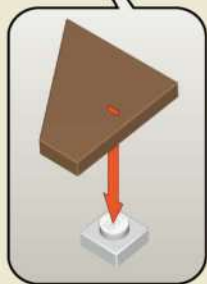
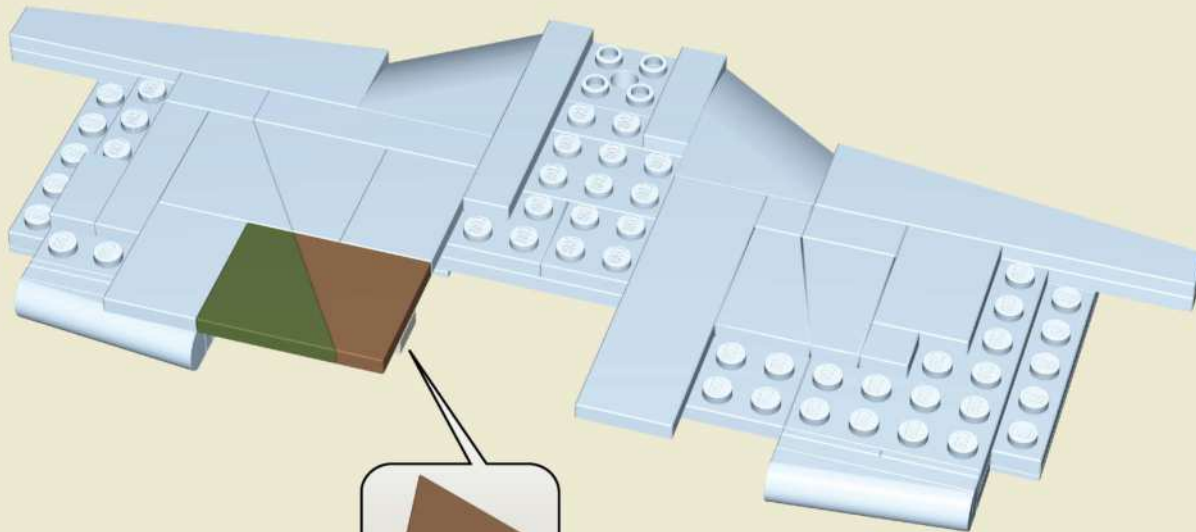

16

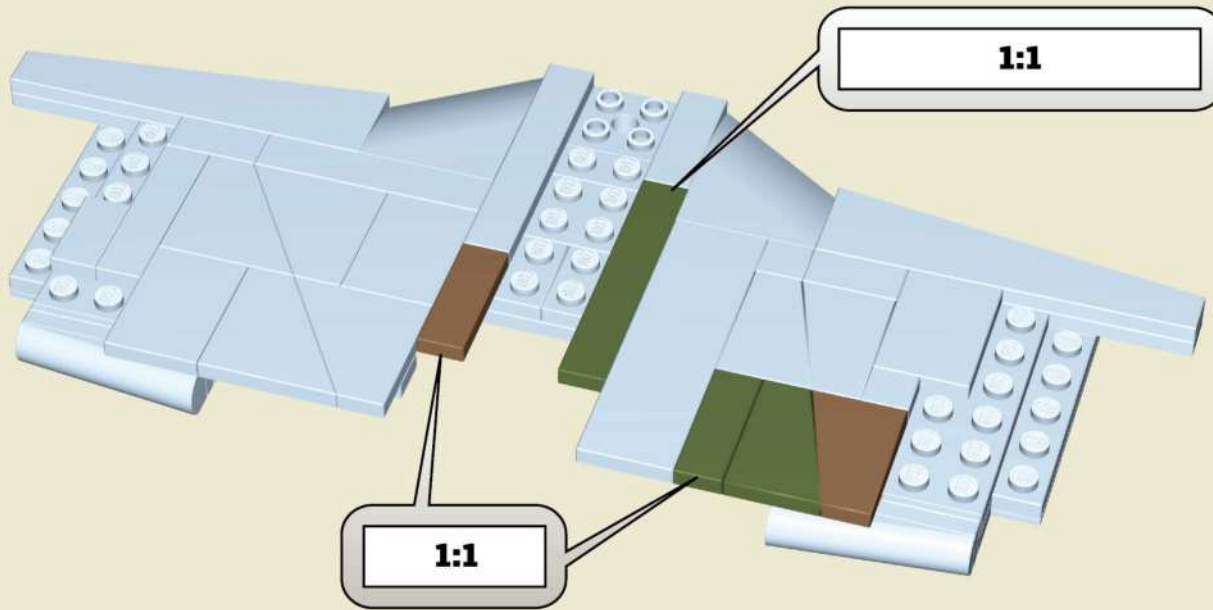

17



-  x1
-  x1
-  x1
-  x1
-  x1

18

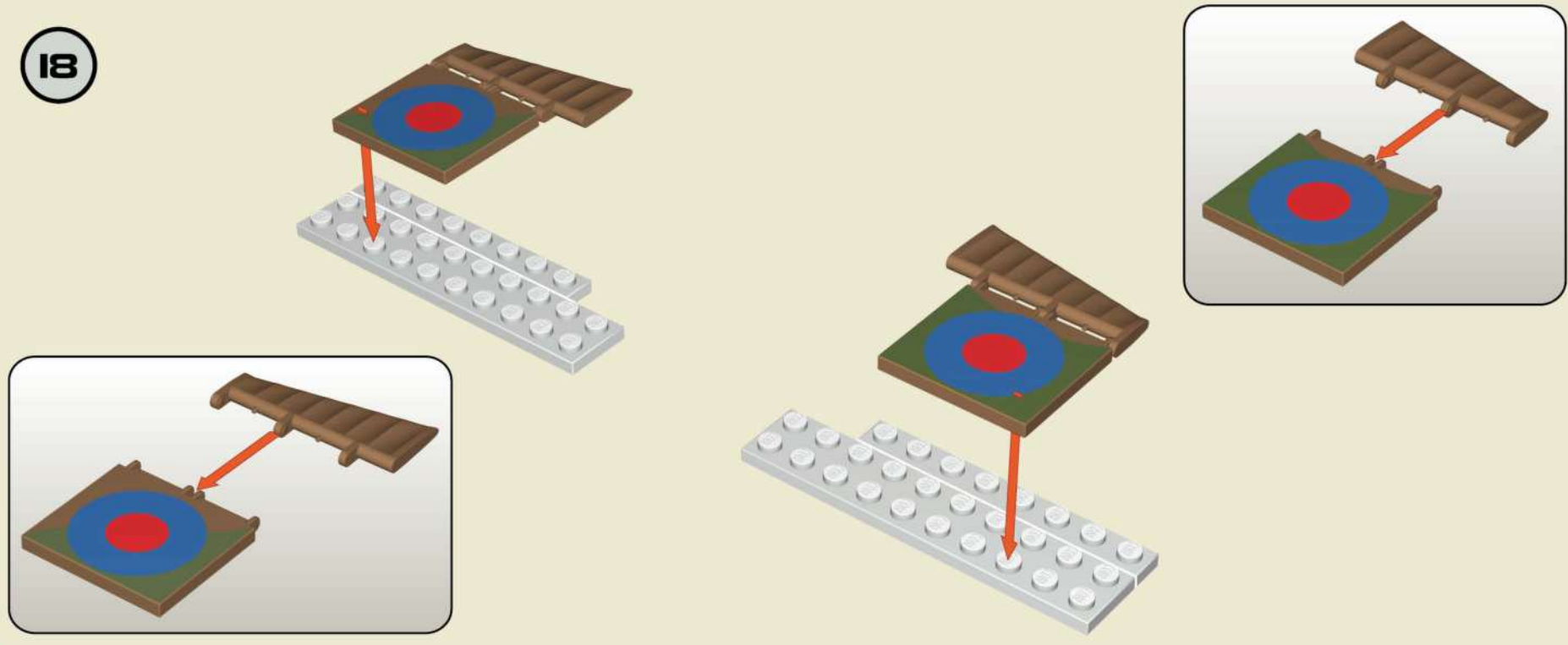

-  x2
-  x2
-  x2
-  x1
-  x1

19

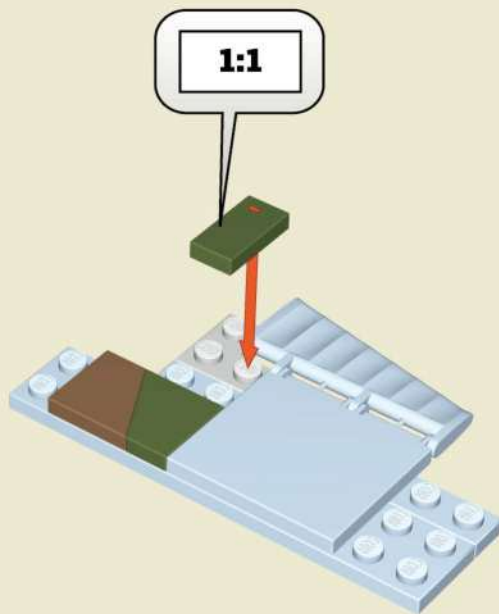
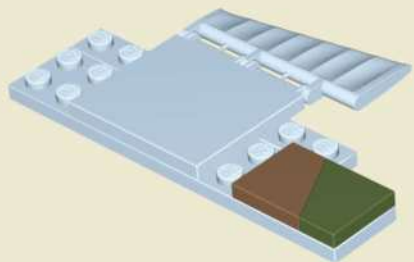

 x2

 x2

 x1

 x1

20

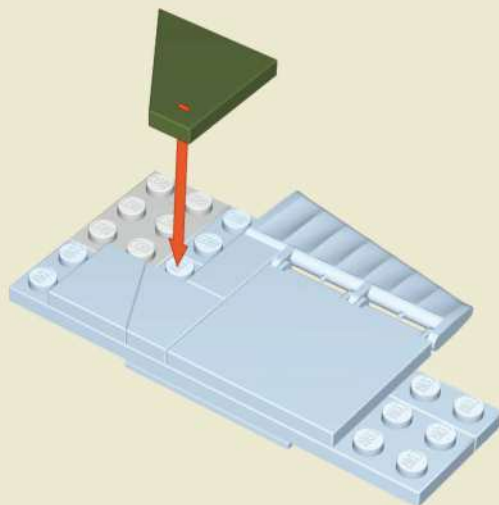
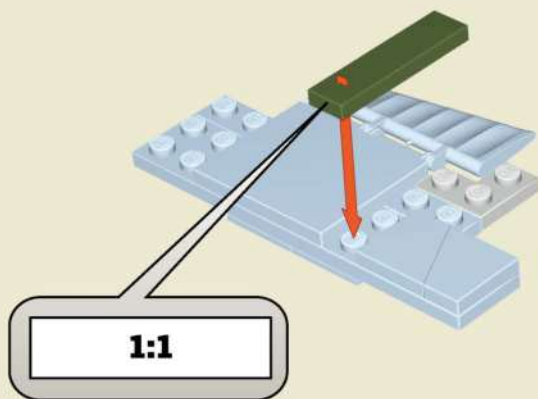

 x1

 x1

 x1

 x1

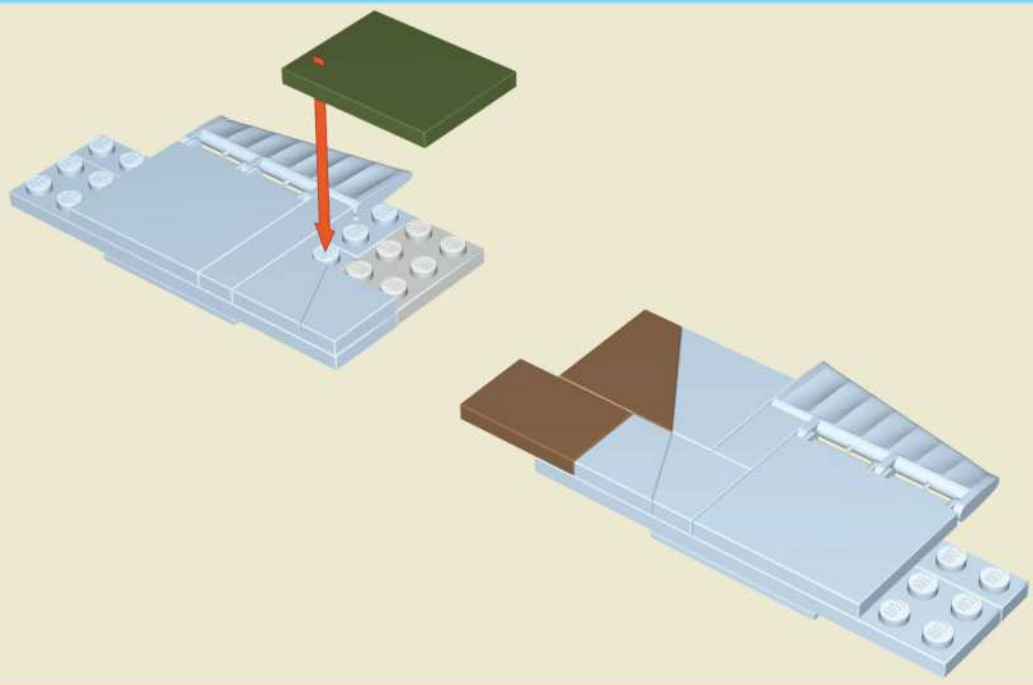

21

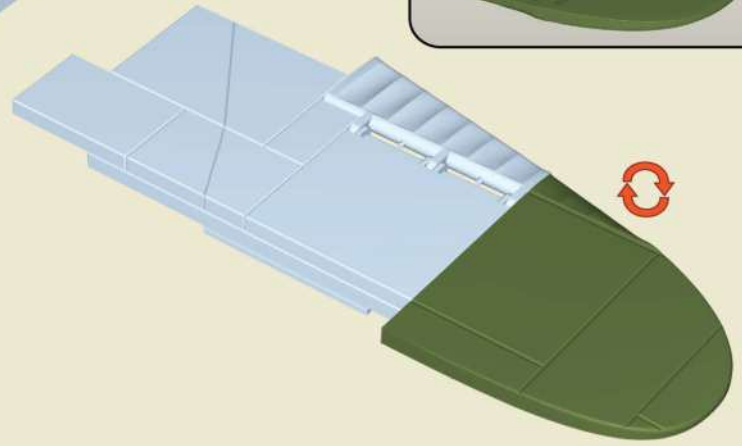
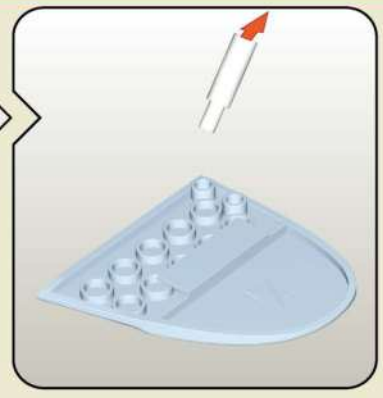
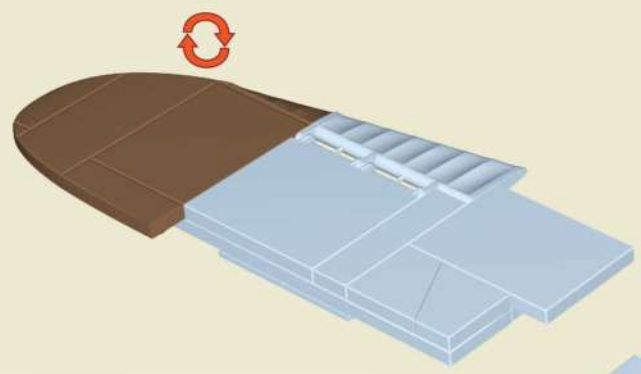

-  x1
-  x1
-  x1
-  x1

22

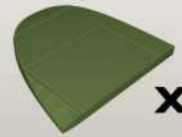

-  x1
-  x1
-  x2
-  x4

23

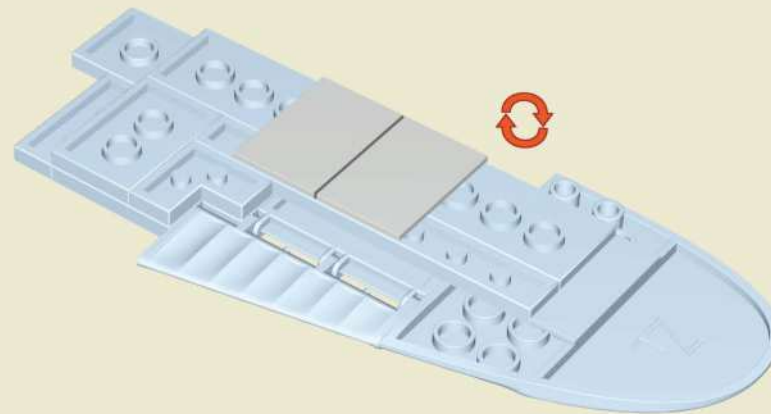
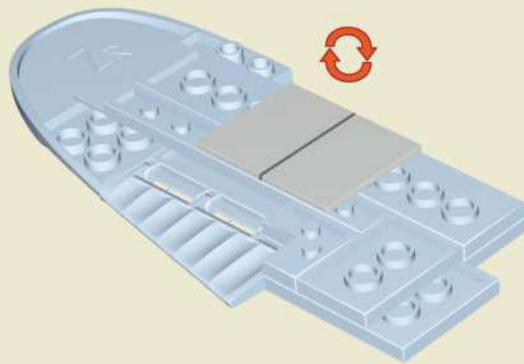

24

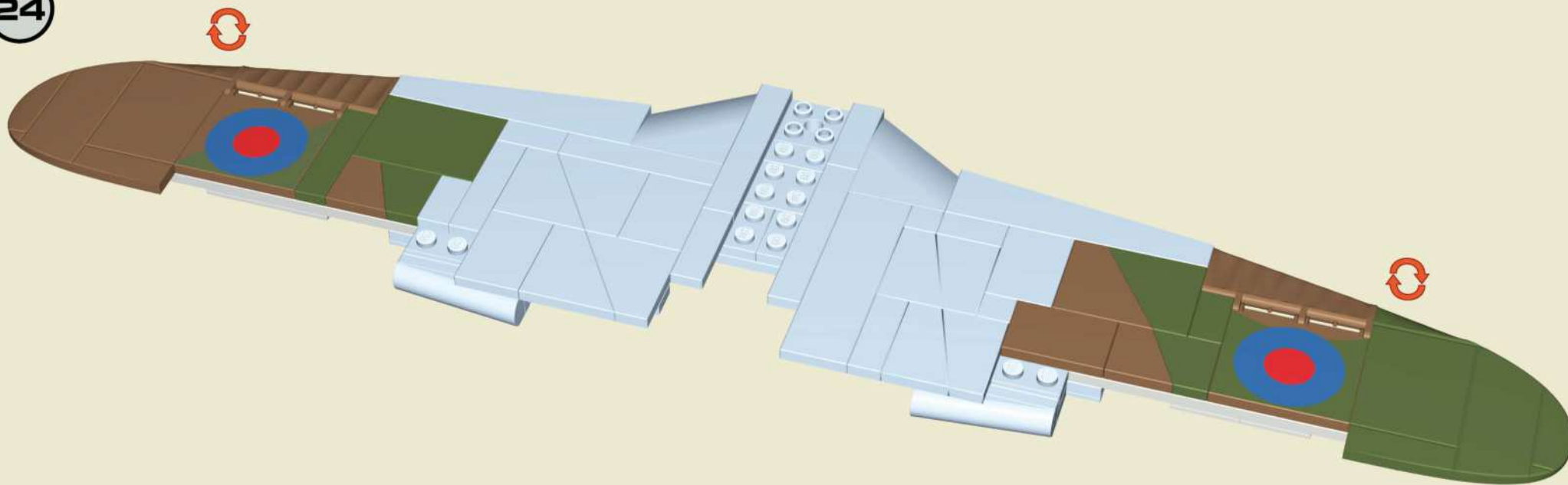

25

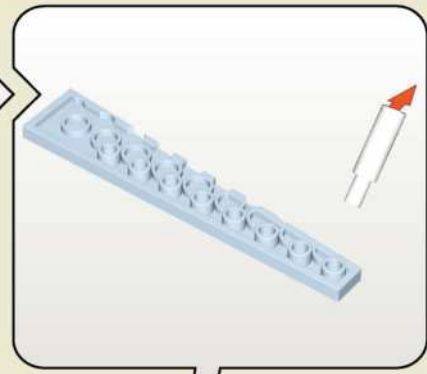
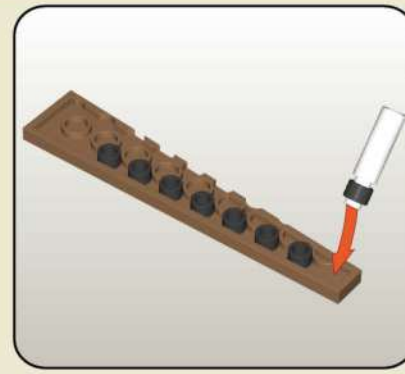
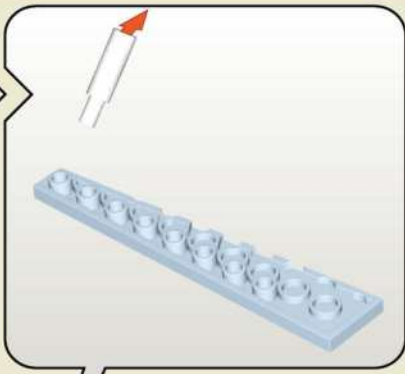
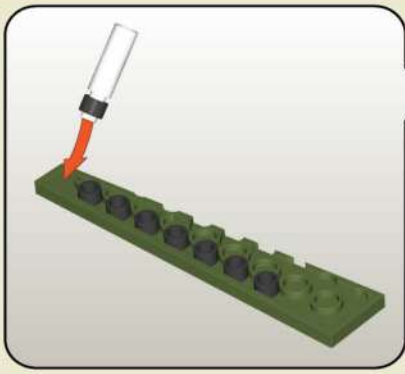

-  x1
-  x1
-  x16

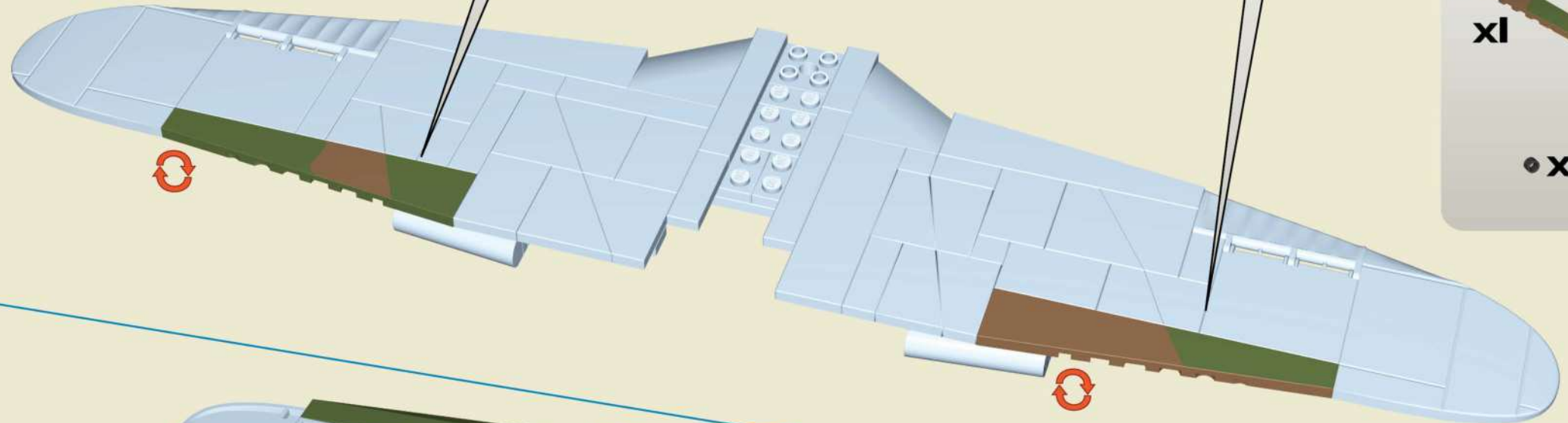

26

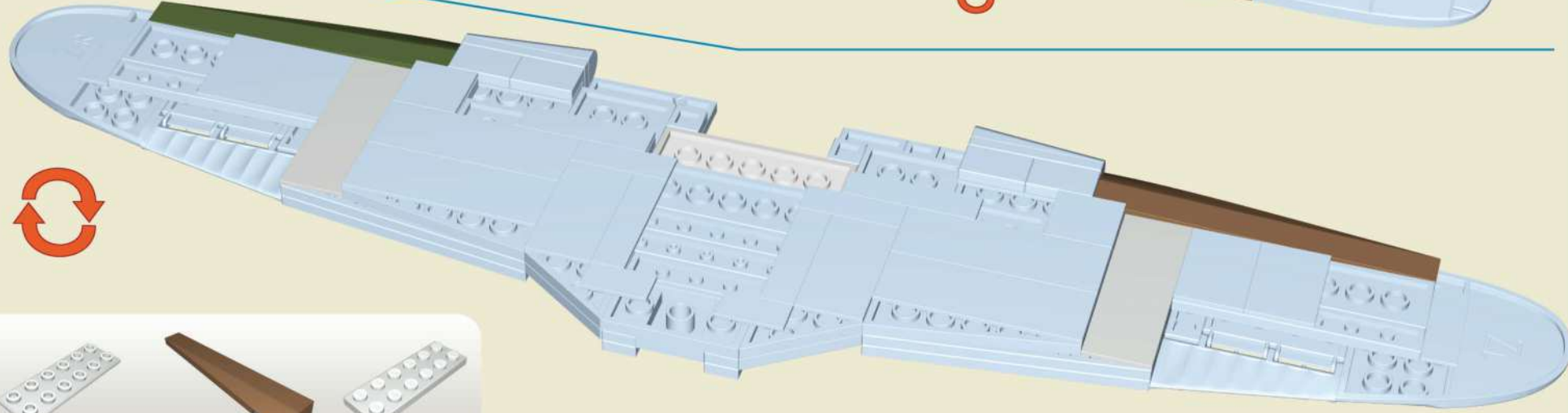

-  x1
-  x2
-  x1
-  x1

27

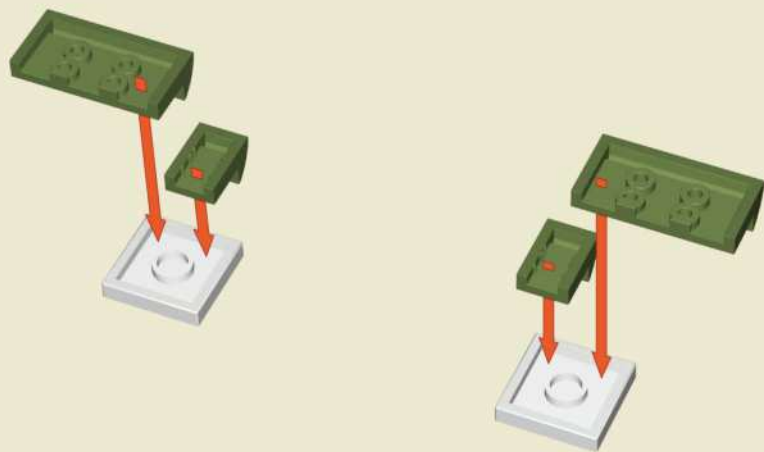

x2



x2



x2

28

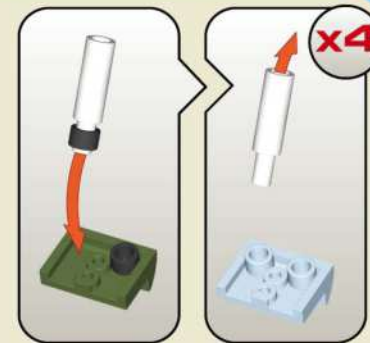
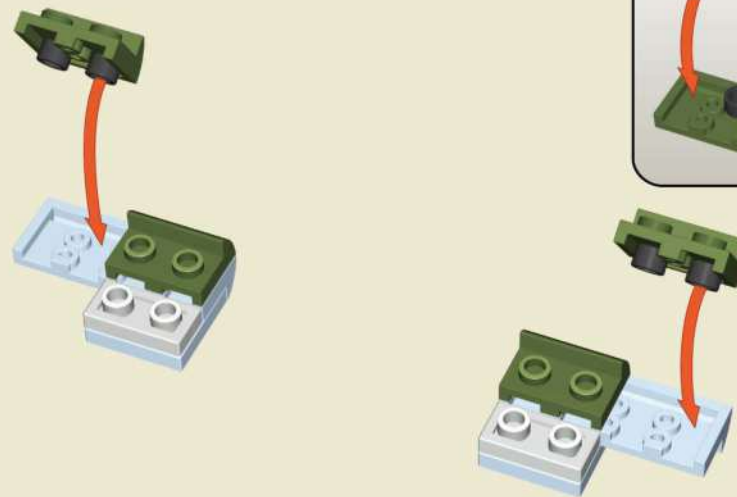

x4



x8



x2

29

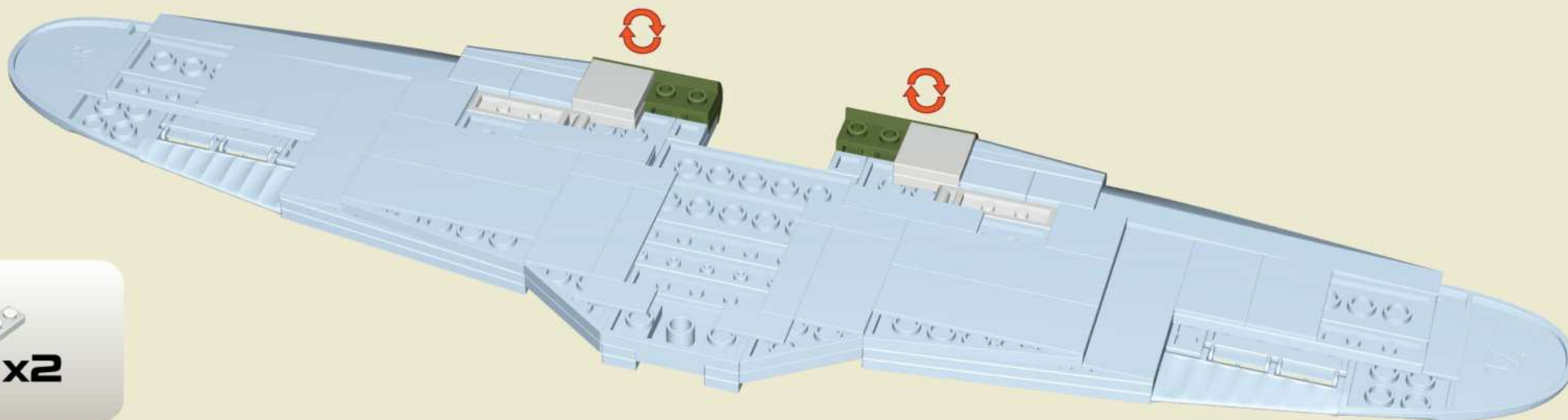

x2

30

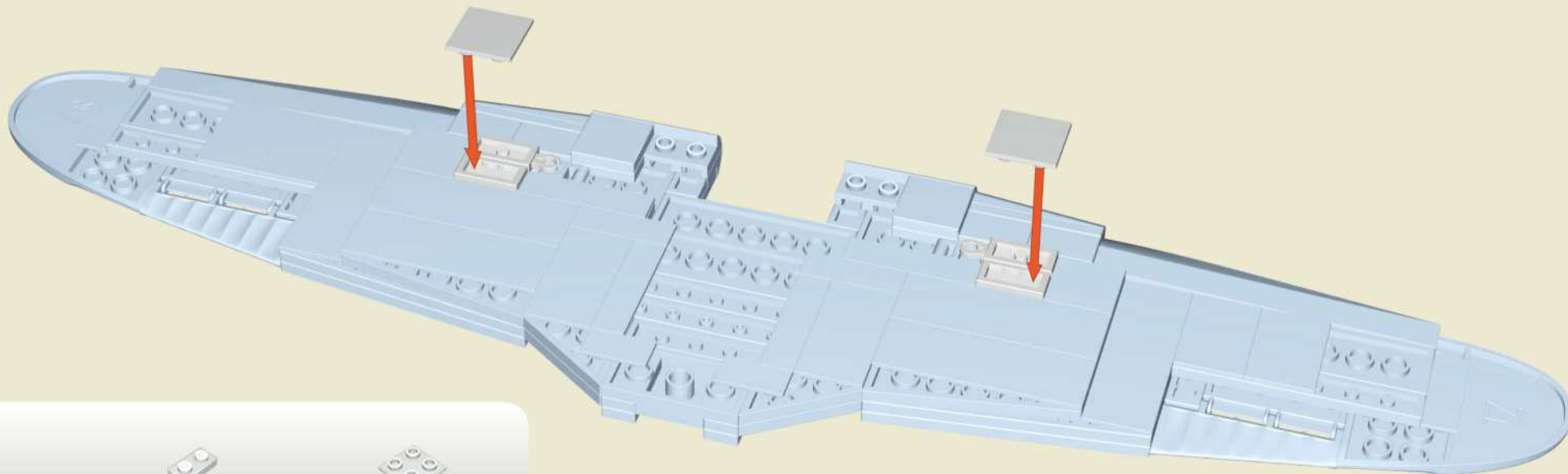

x2



x2



x2

31

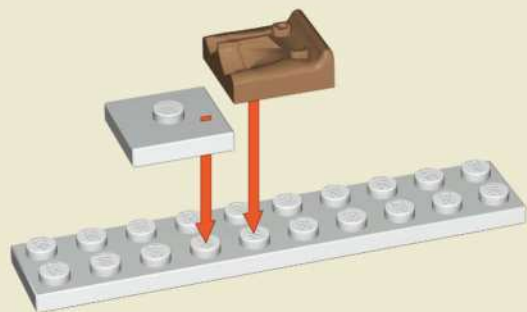

x1



x1



x1

32

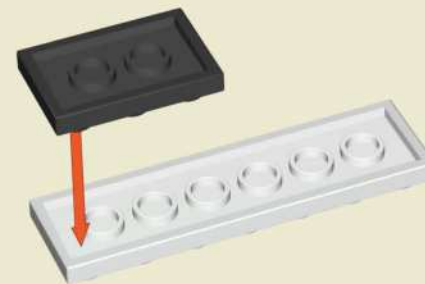

x1

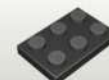

x1

33

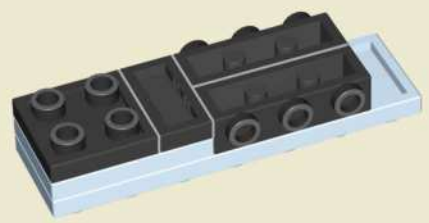

34

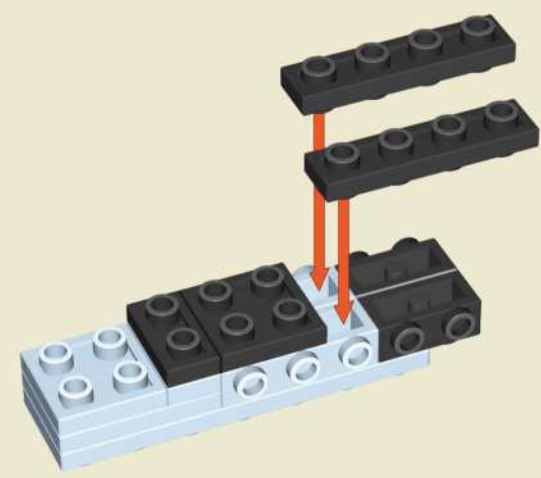

35

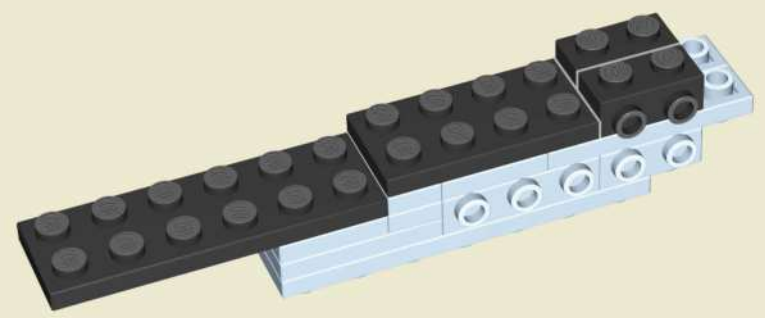

36

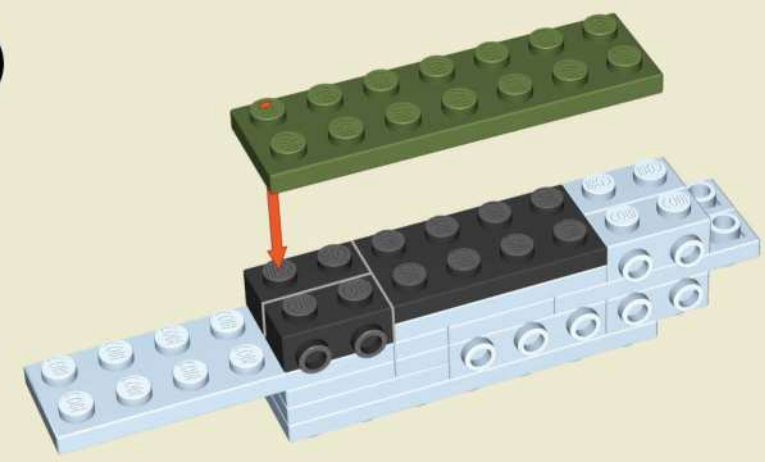

39

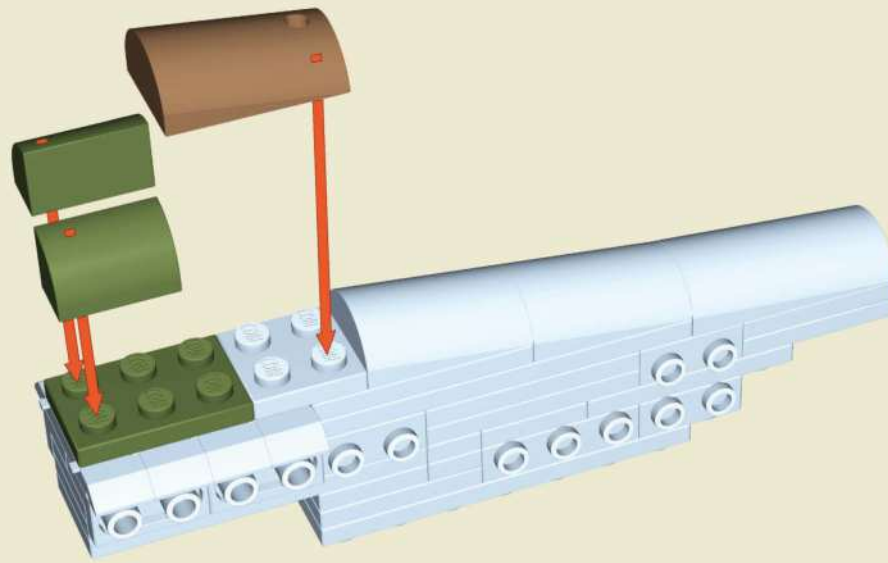

-  x1
-  x2
-  x1

40

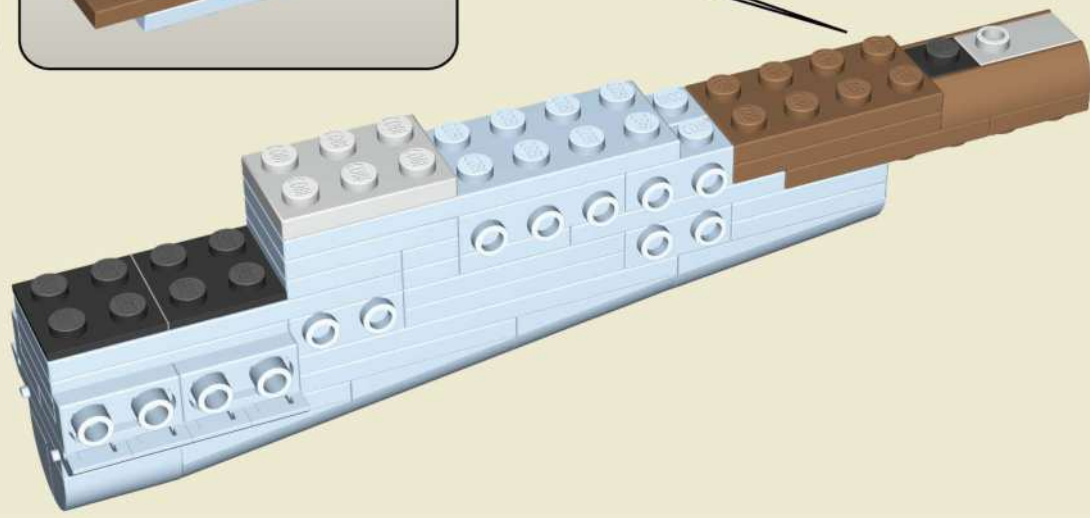
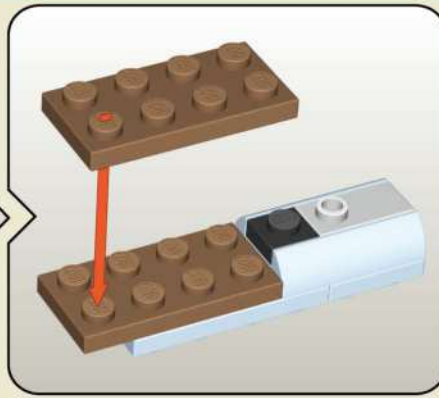

-  x2
-  x1
-  x2
-  x1
-  x1
-  x2
-  x1
-  x1

41

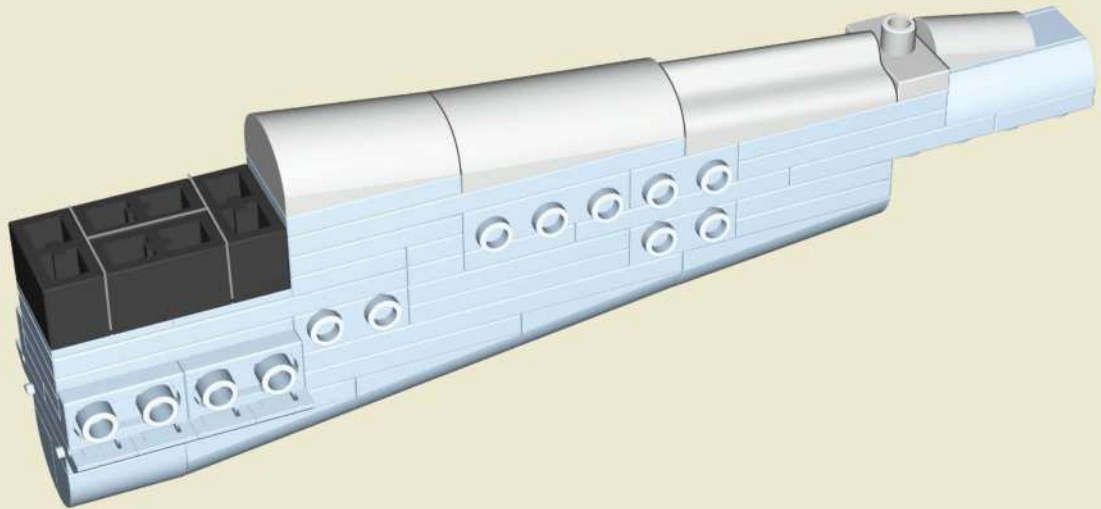

Black 1x4 brick x4

White 1x2 Technic axle x1

White 1x2 Technic axle x1

White 1x2 Technic axle x1

White 1x2 Technic axle with pin x1

White 1x2 Technic axle x1

42

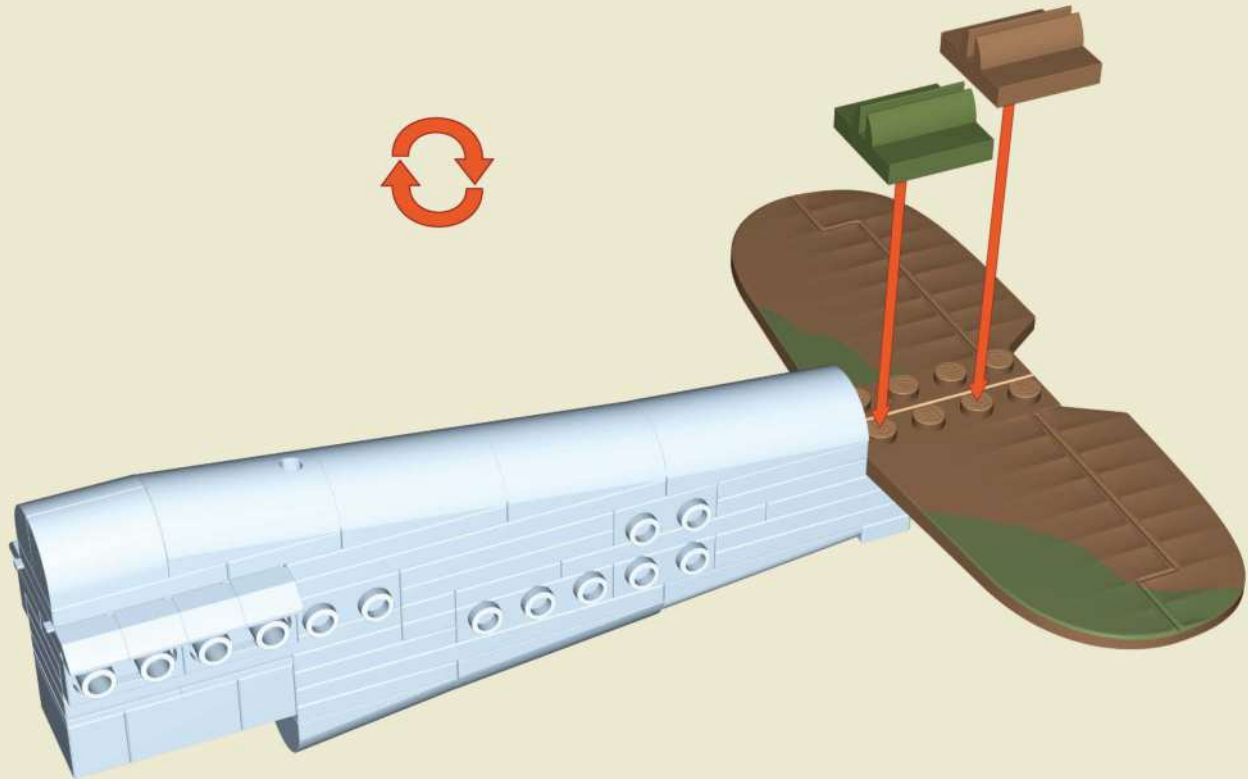

Brown 1x12 Technic plate with 4 holes x1

Brown 1x12 Technic plate with 4 holes x1

Green 1x2 Technic axle x1

Brown 1x2 Technic axle x1

43

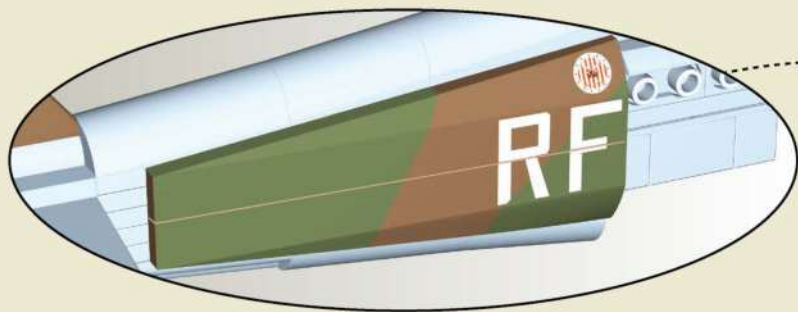

x1



x1



x1



x1



x1

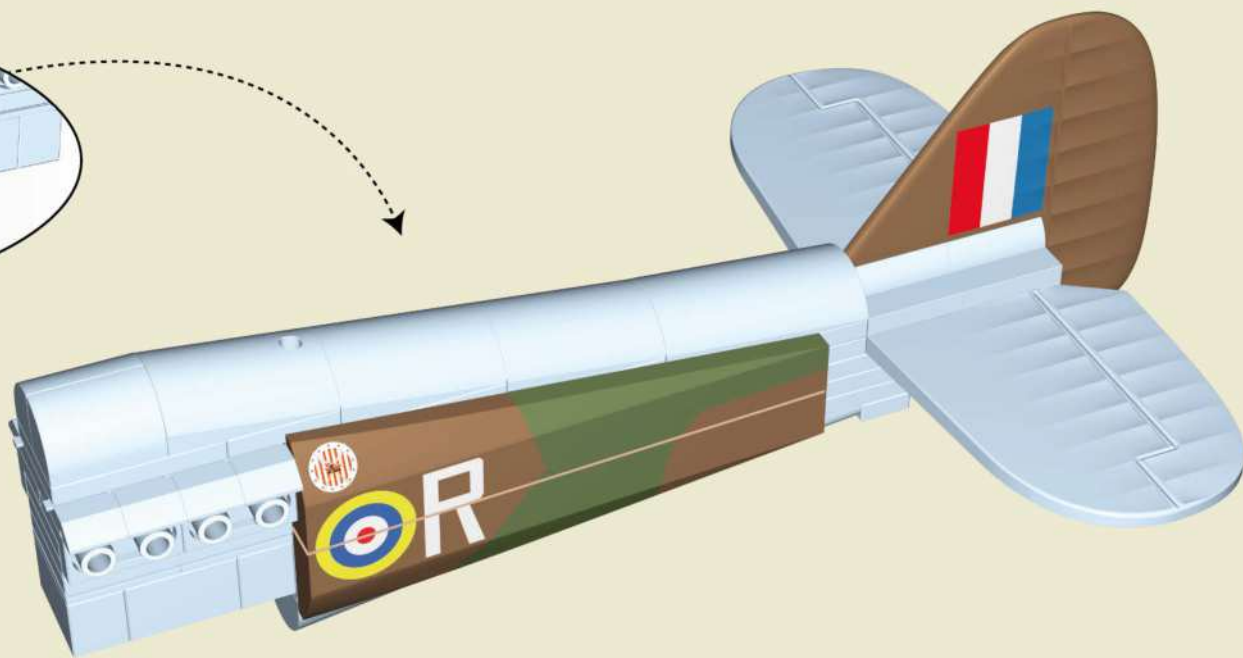

44



x1



x1

45

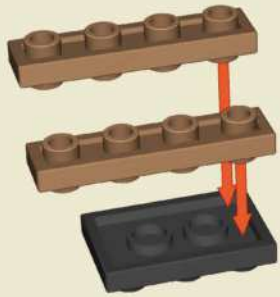

46



47

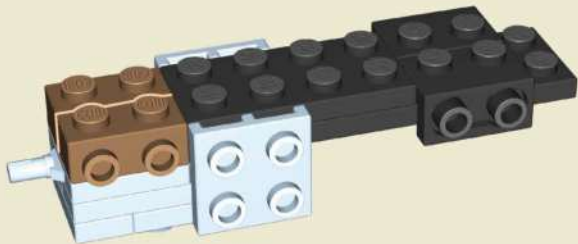
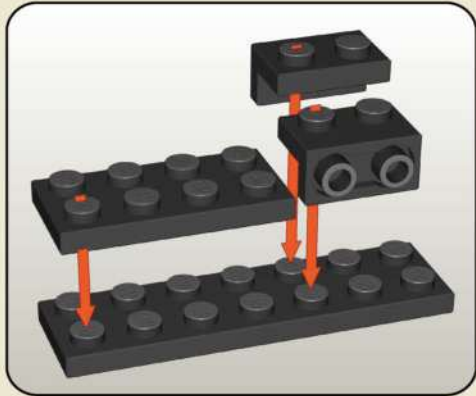

48

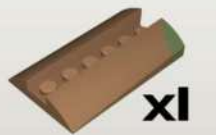
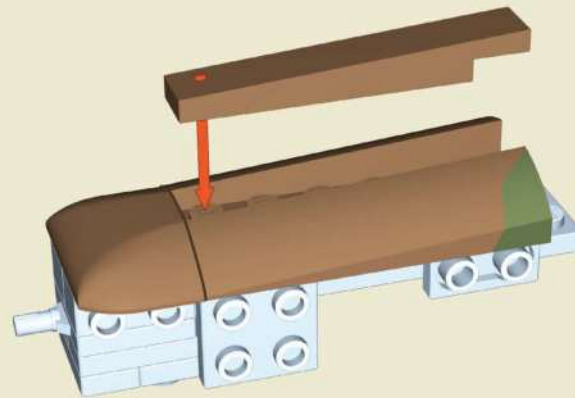

49

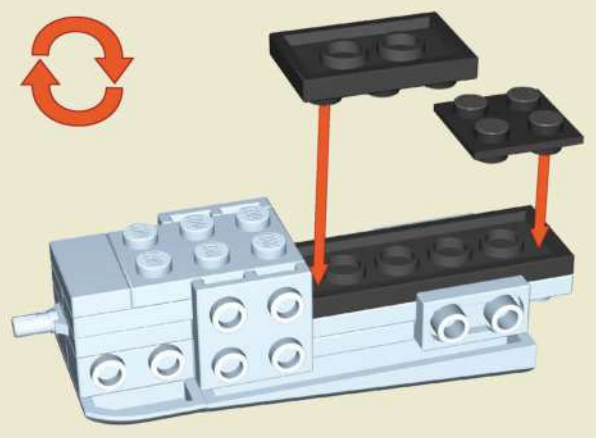

-  x1
-  x1
-  x1

50

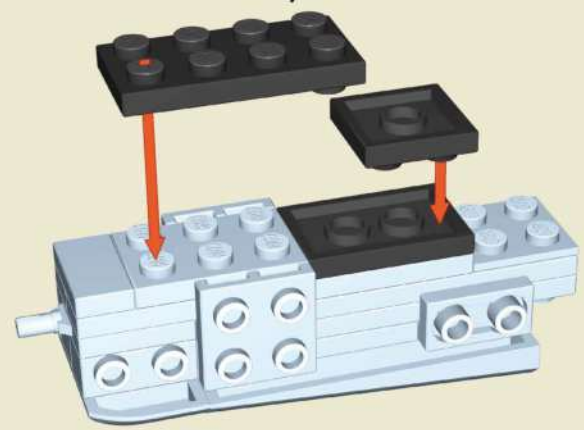
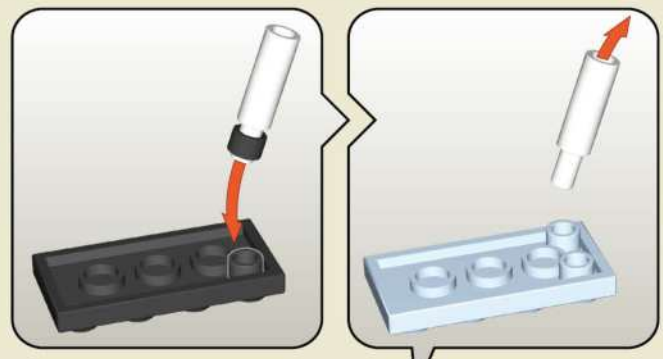

-  x1
-  x2
-  x1
-  x1

51

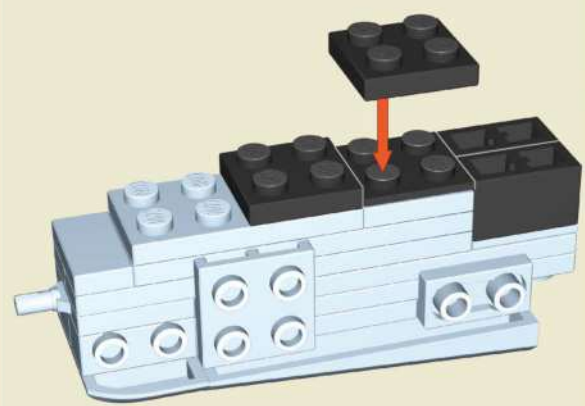

-  x2
-  x1
-  x2

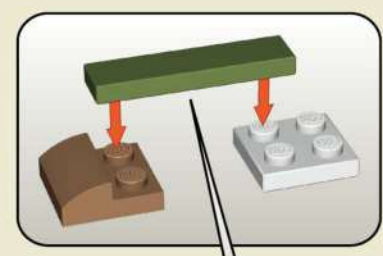
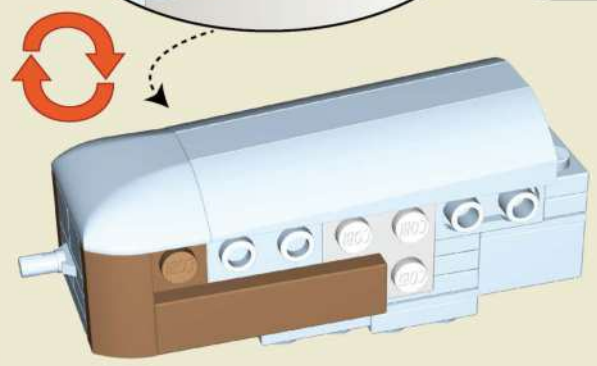
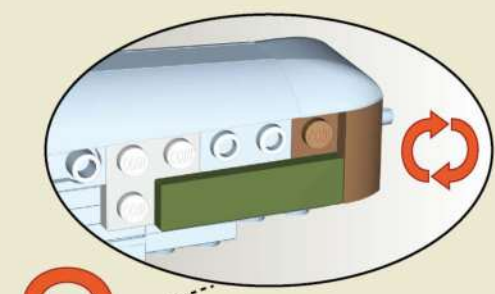

1:1

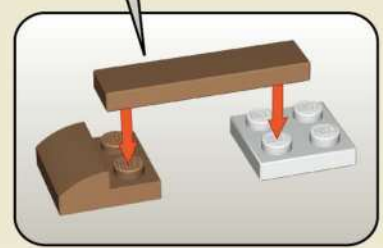

52

-  x2
-  x2
-  x1
-  x1

53

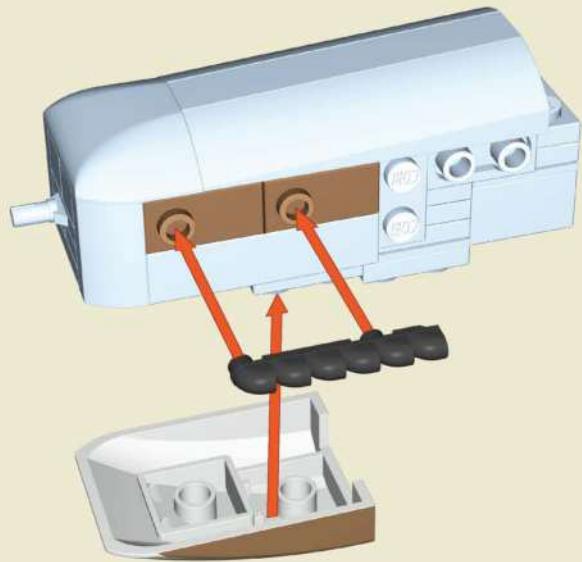

-  x2
-  x1
-  x1

54

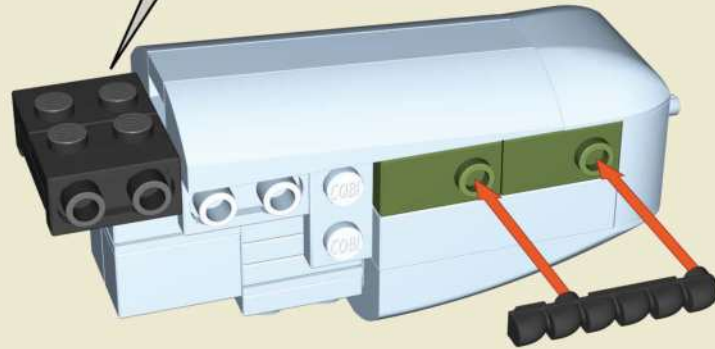
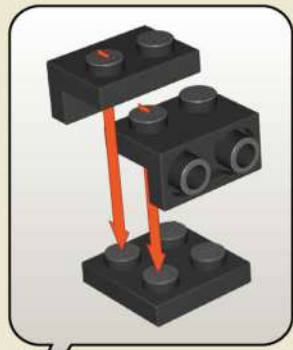

-  x1
-  x2
-  x2
-  x1

55

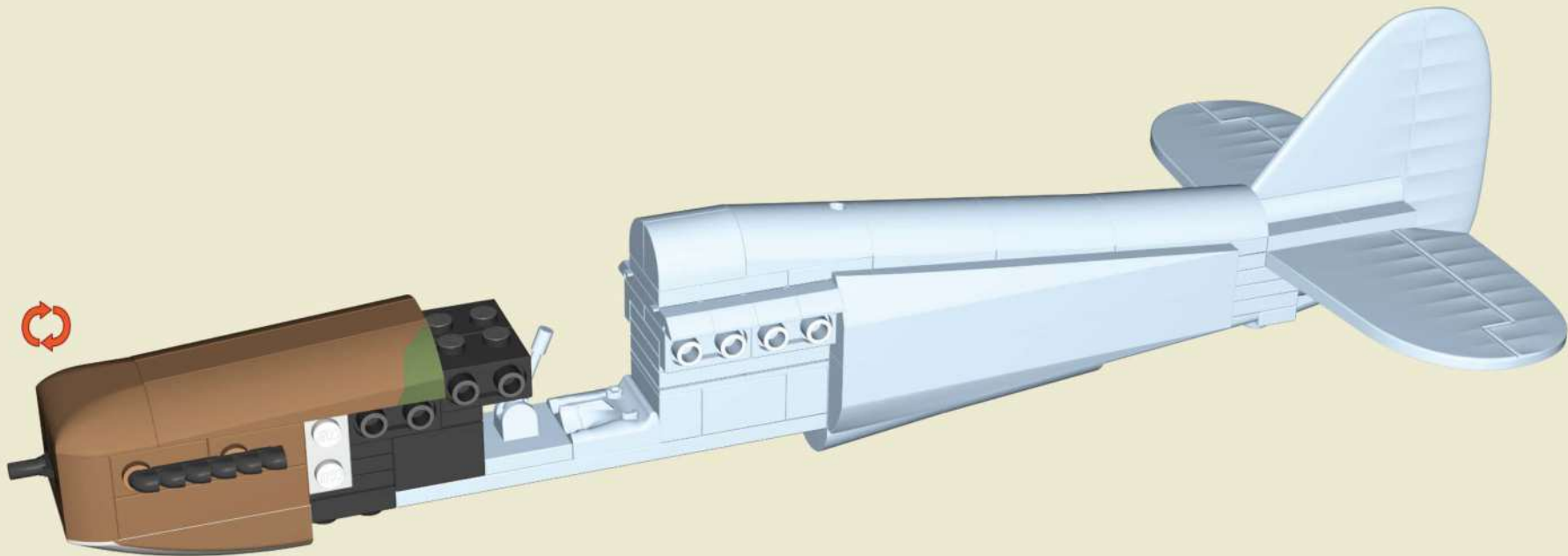

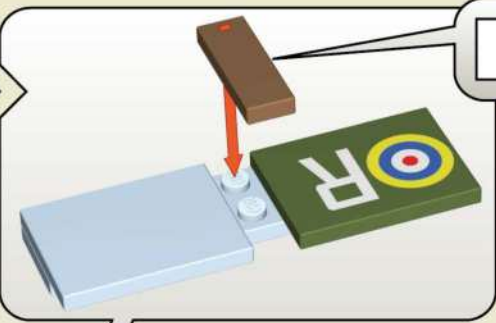
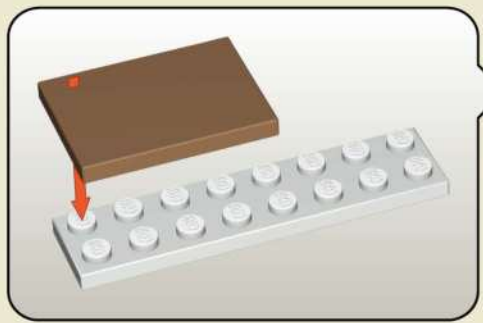

1:1

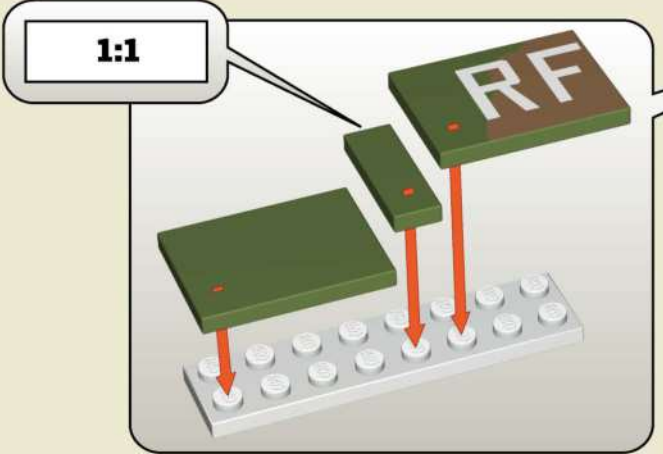
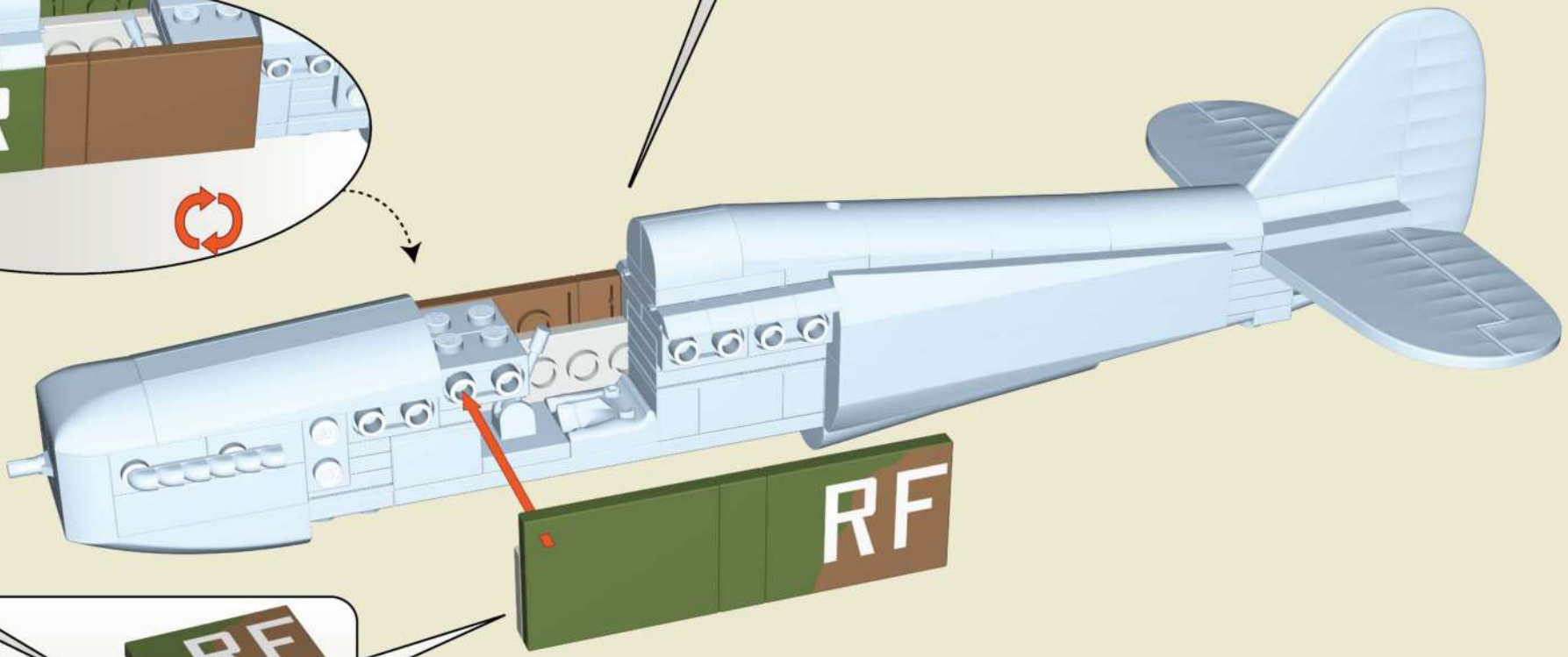

1:1

-  x2
-  x1
-  x1
-  x1
-  x1
-  x1
-  x1

57

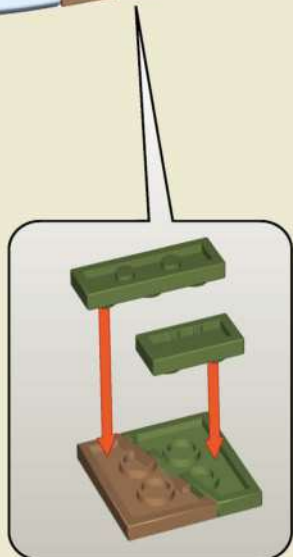
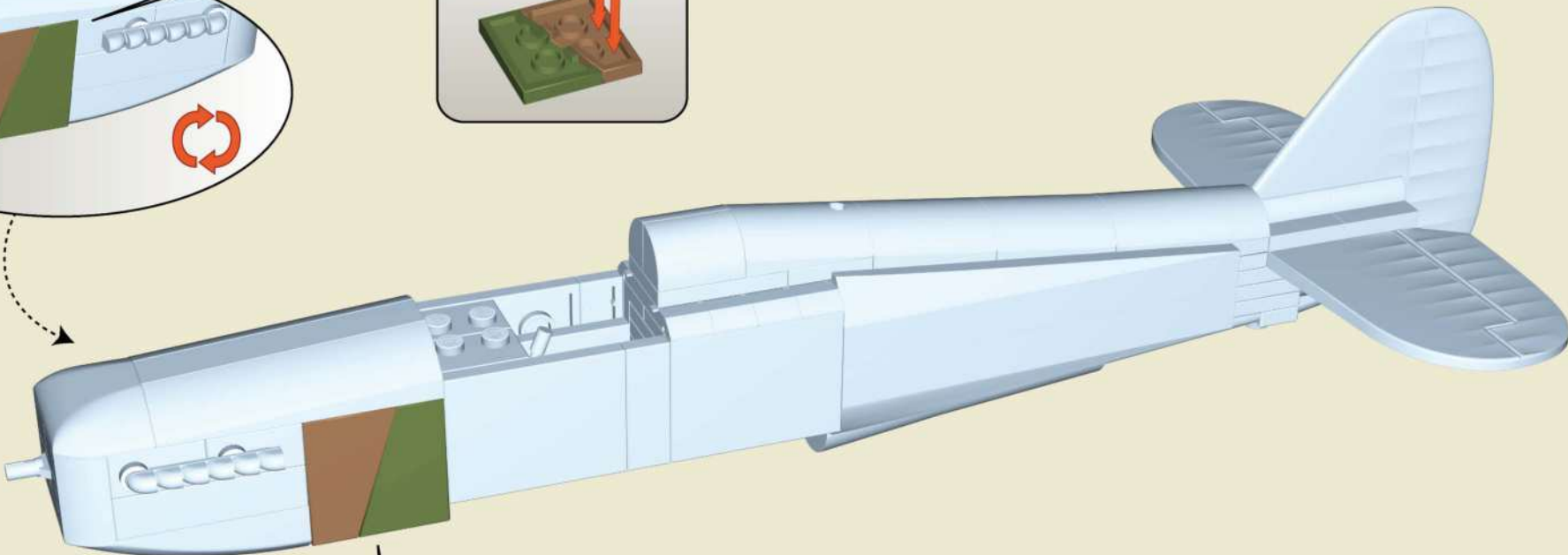
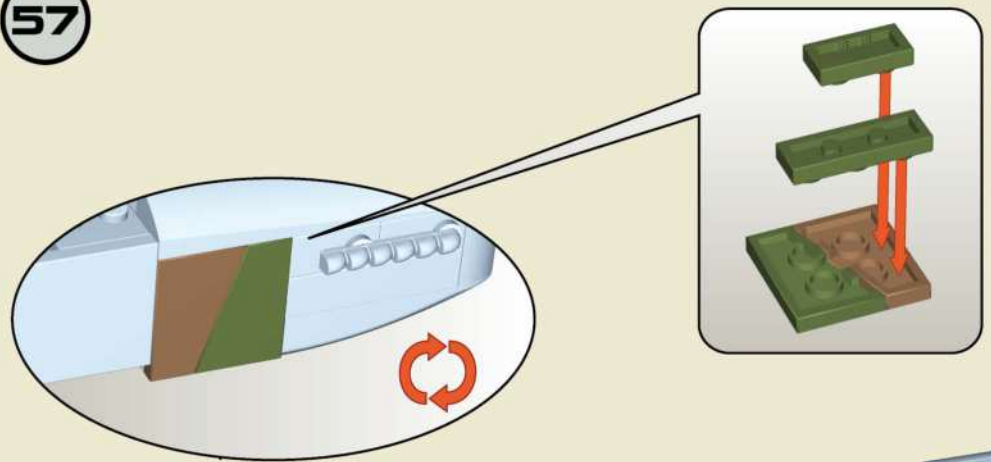

-  x2
-  x2
-  x2
-  x2

58

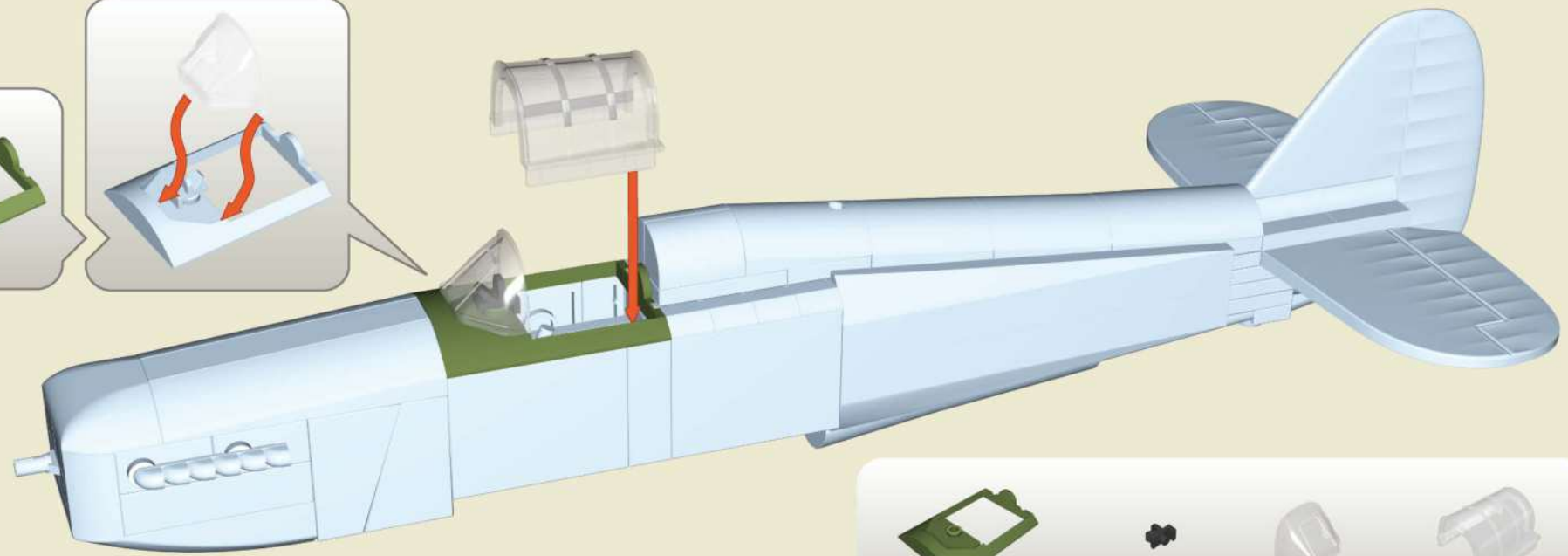
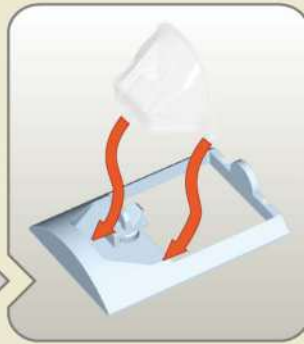
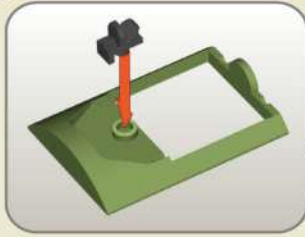

59



1:1

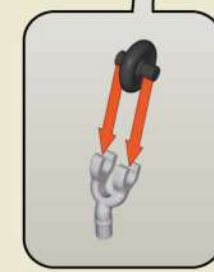
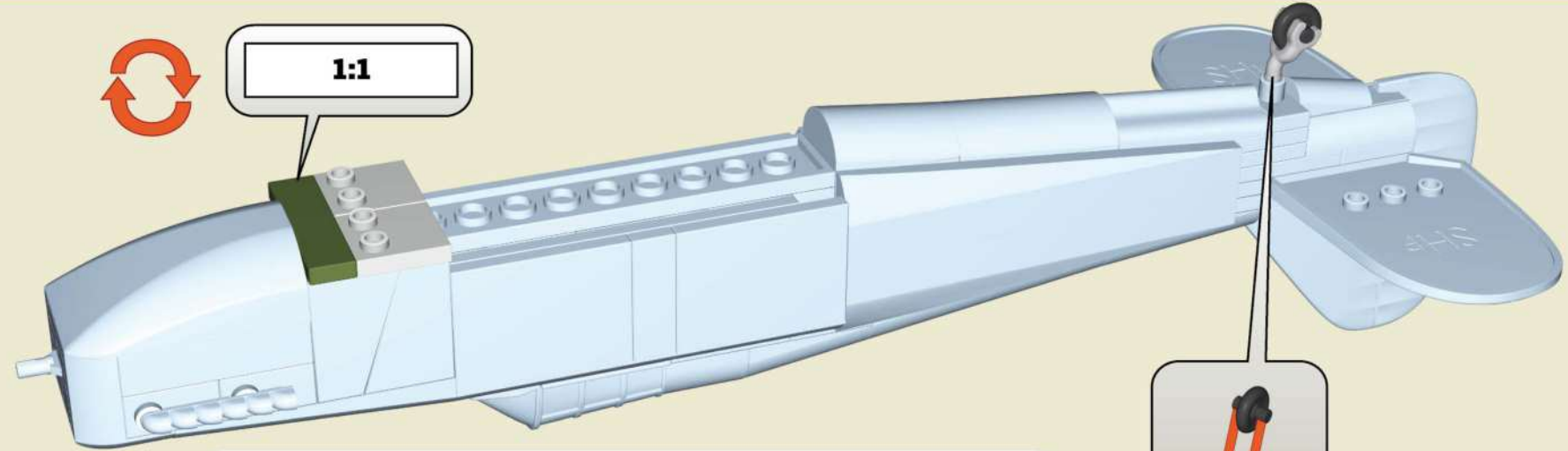

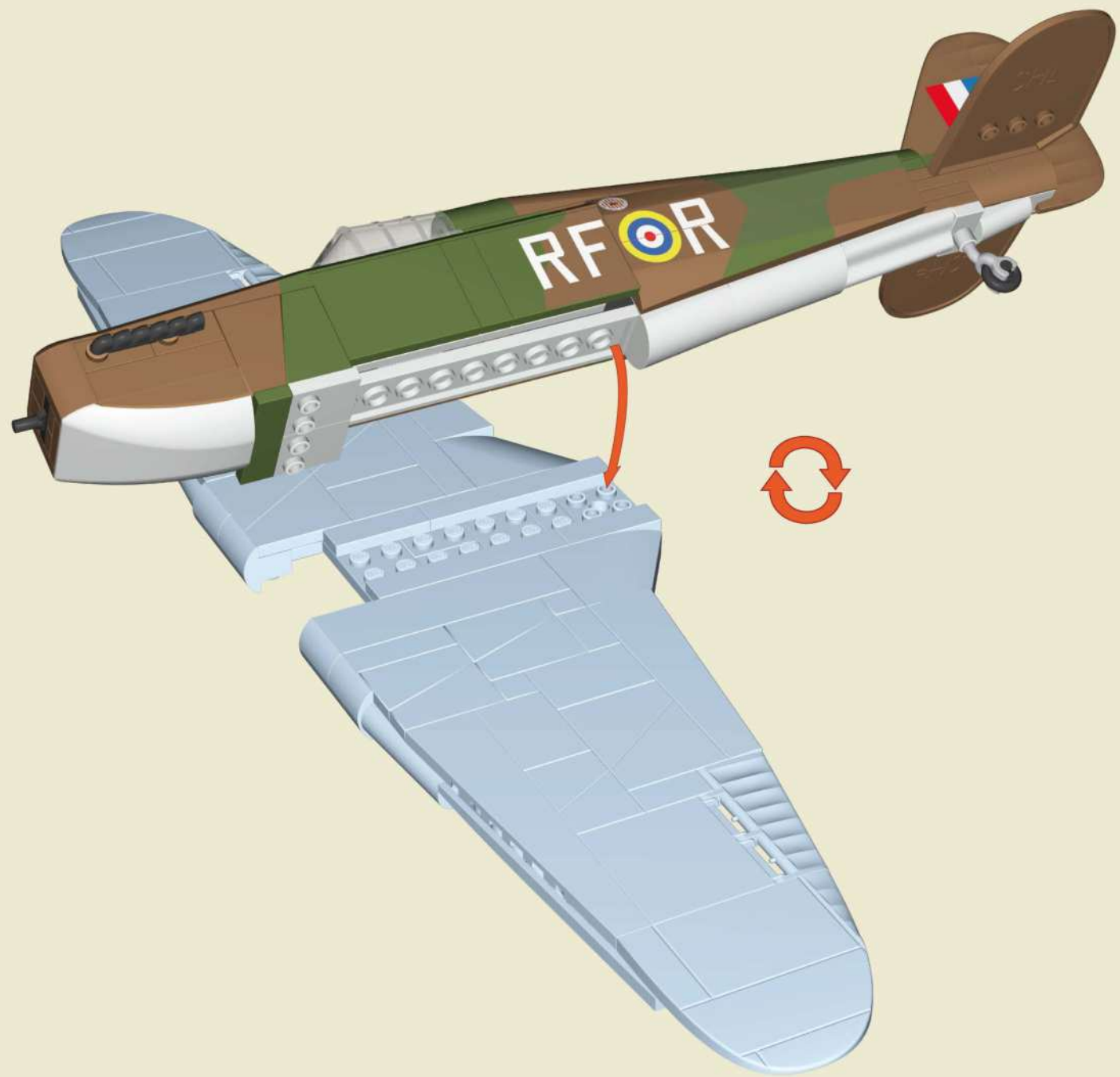

61

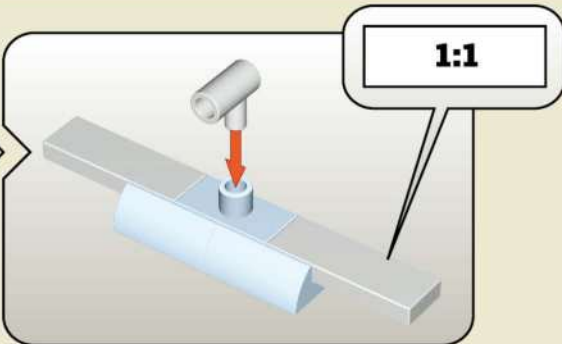
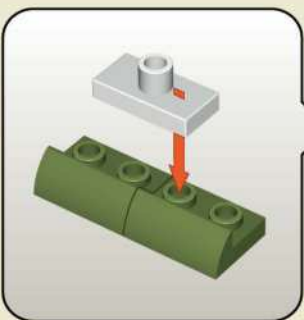

1:1

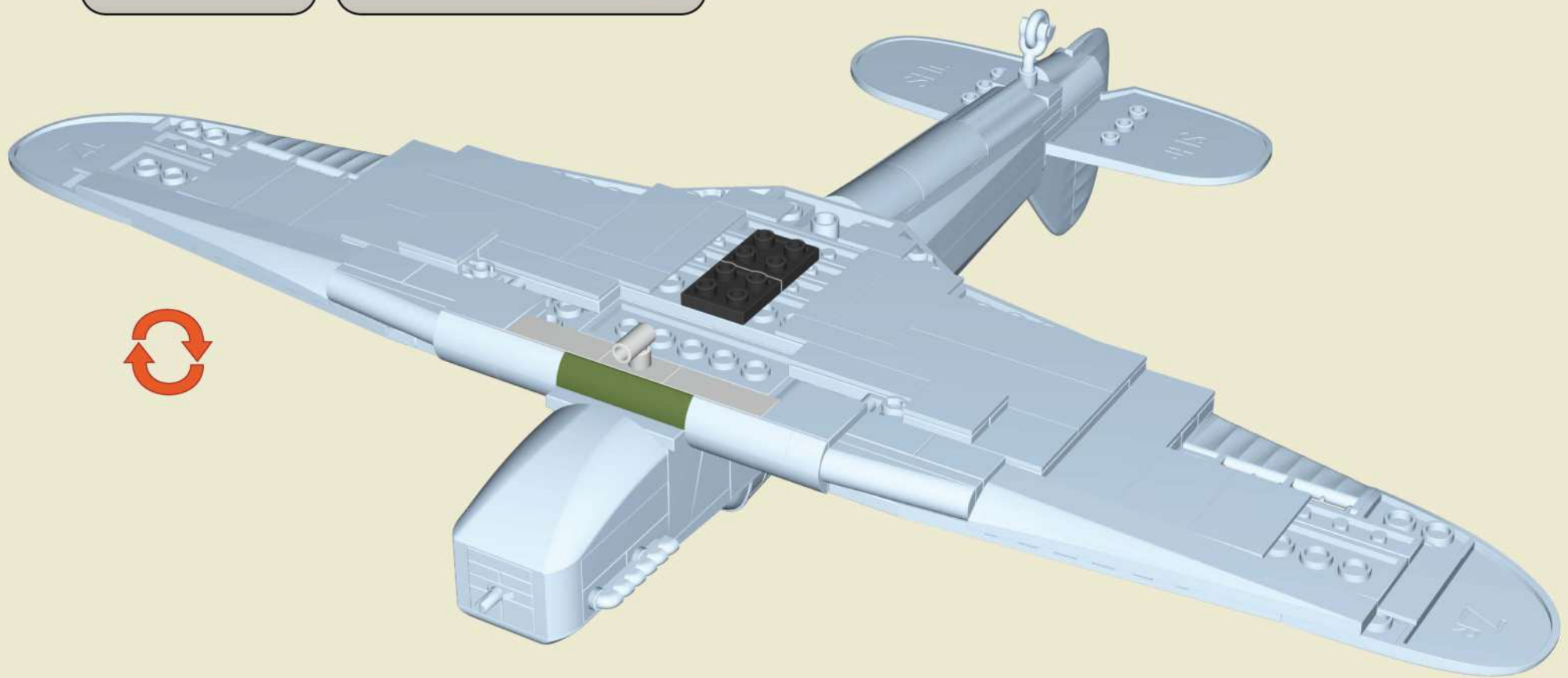

-  x2
-  x1
-  x2
-  x1
-  x2

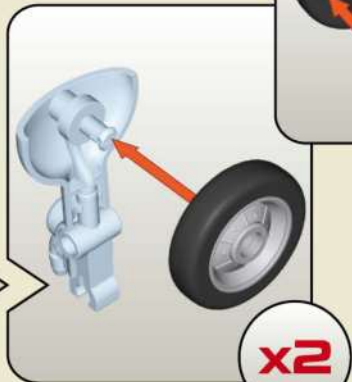
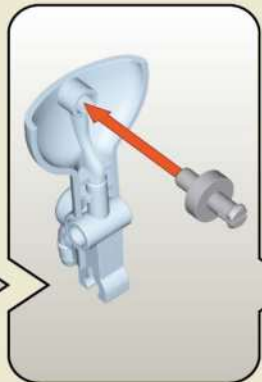
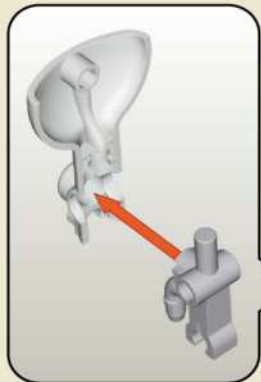
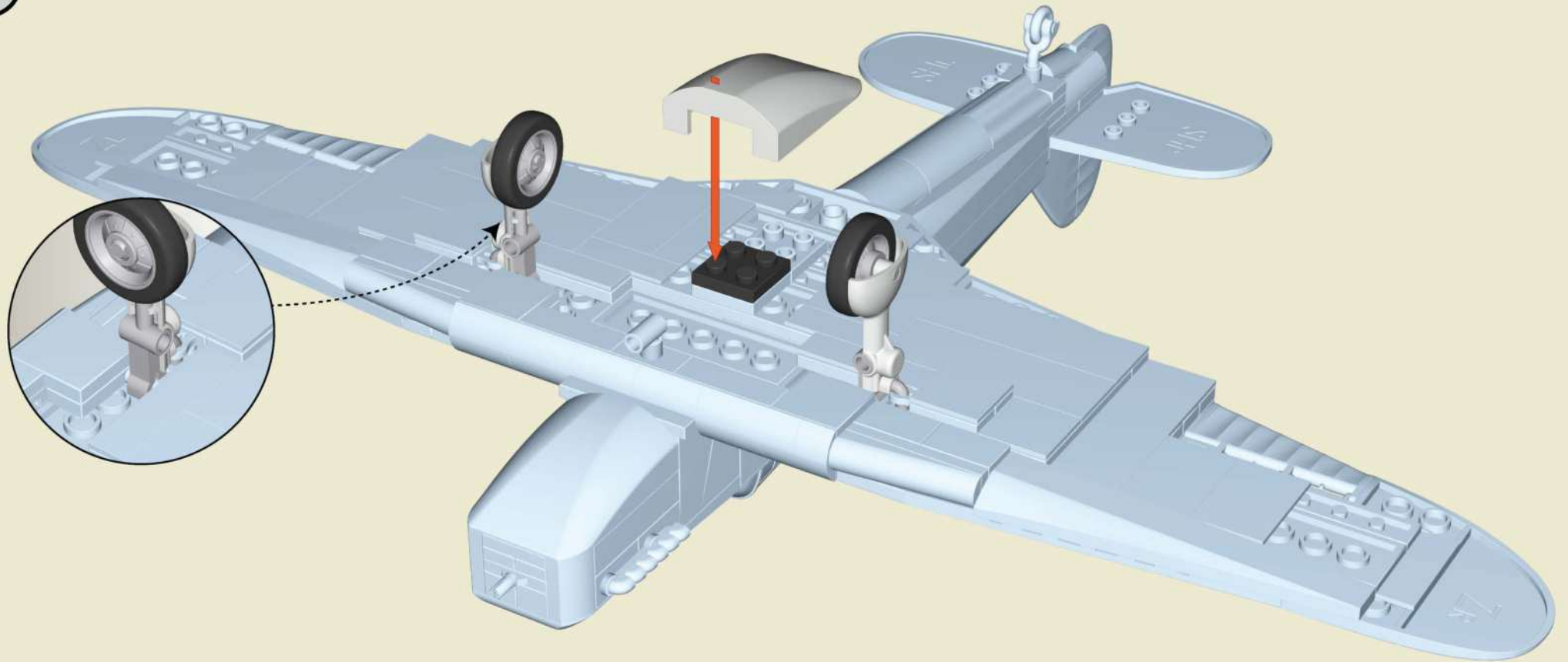

- | | | | | | | |
|---|---|---|---|---|---|---|
|  |  |  |  |  |  |  |
| x2 | x2 | x2 | x2 | x2 | x1 | x1 |

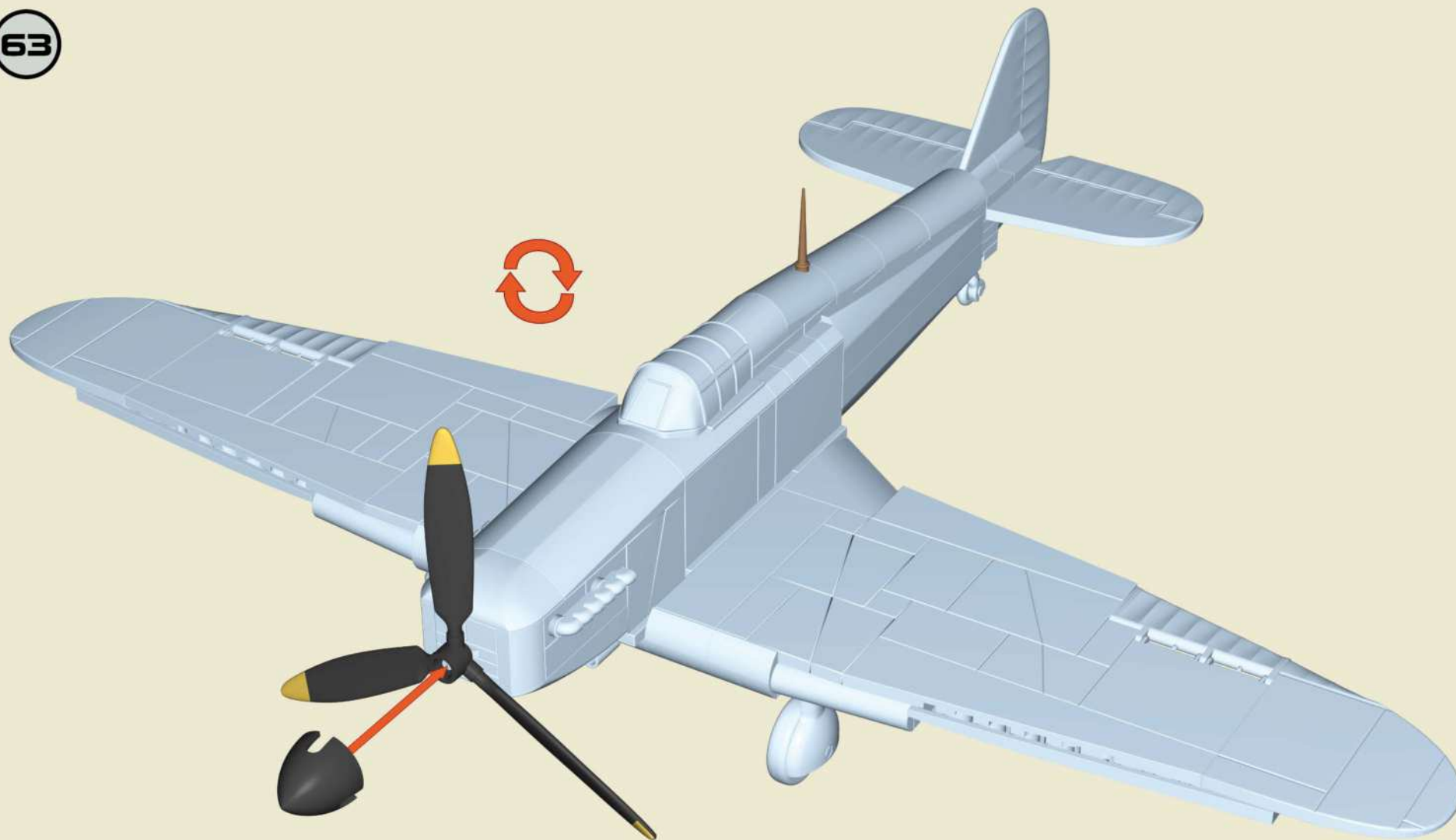

64

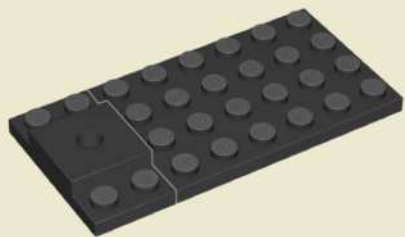

65

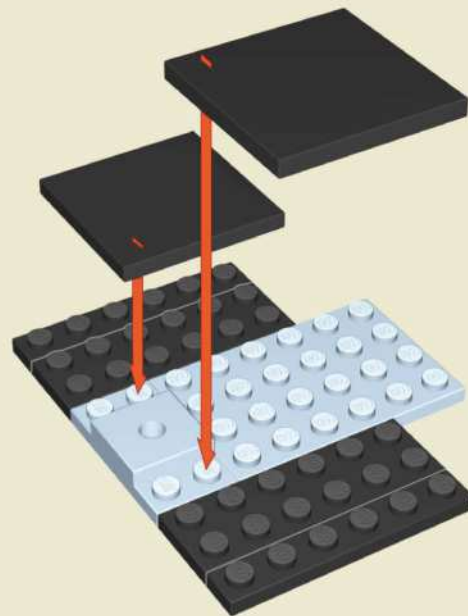

66

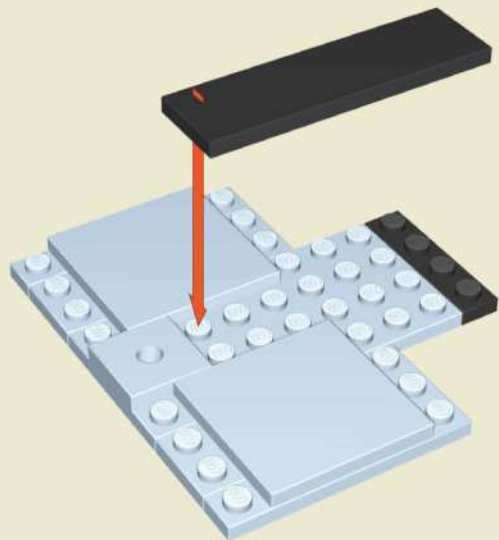

x1

x1

67

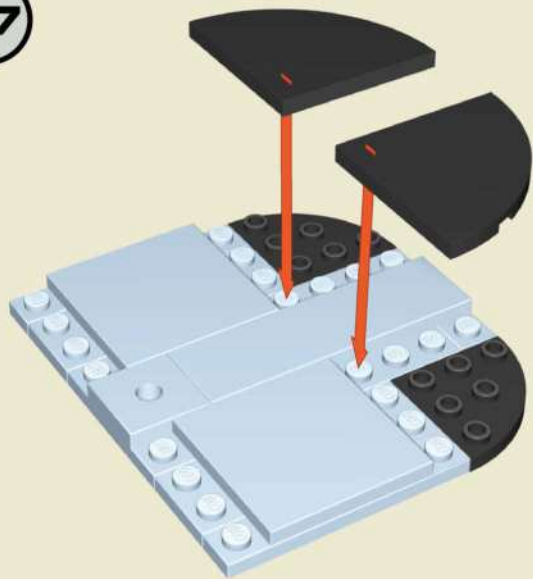

68

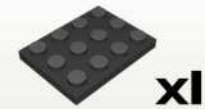
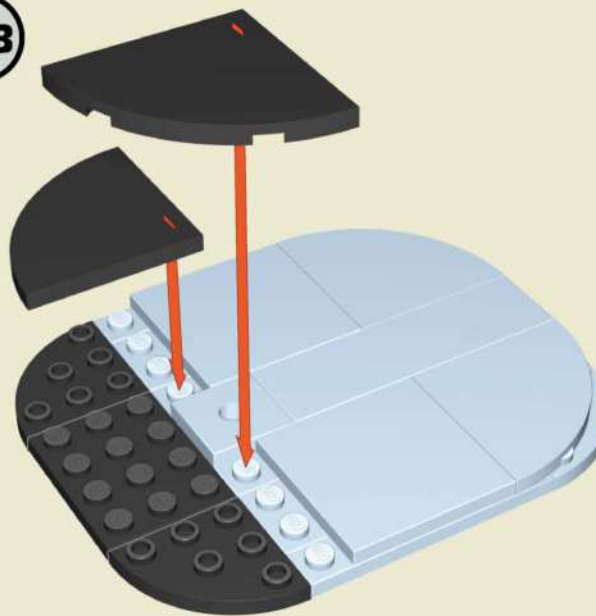

69

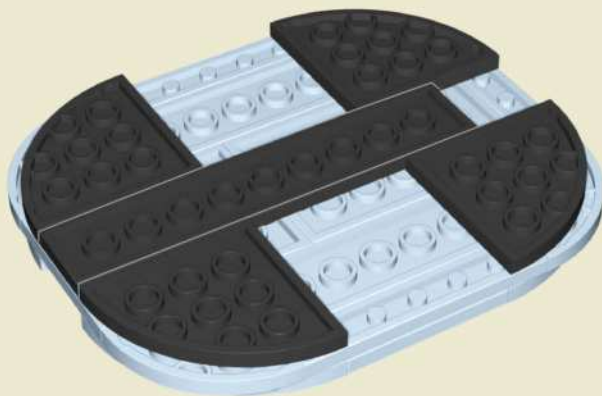

70



1:1

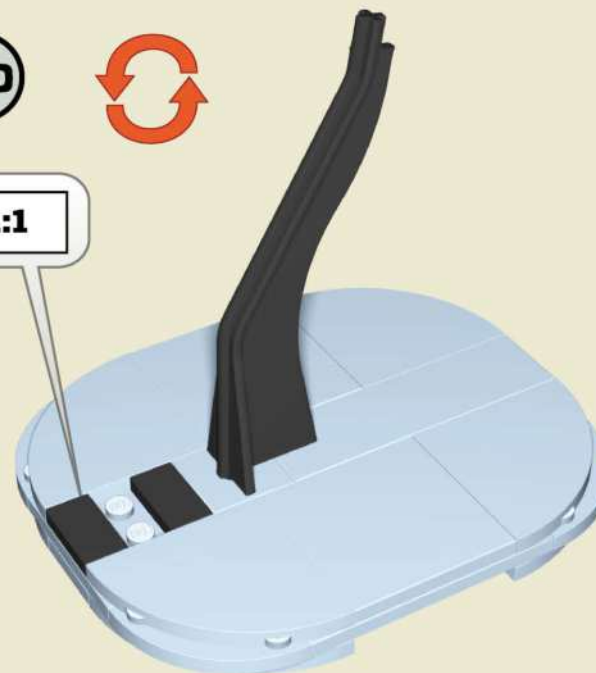

71

x2

x1

x1

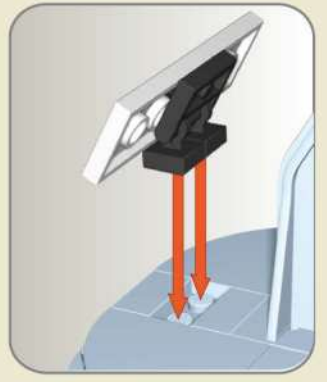
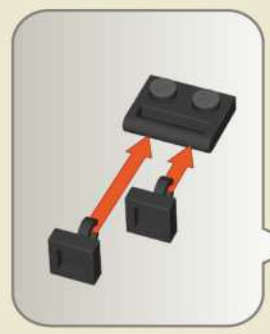
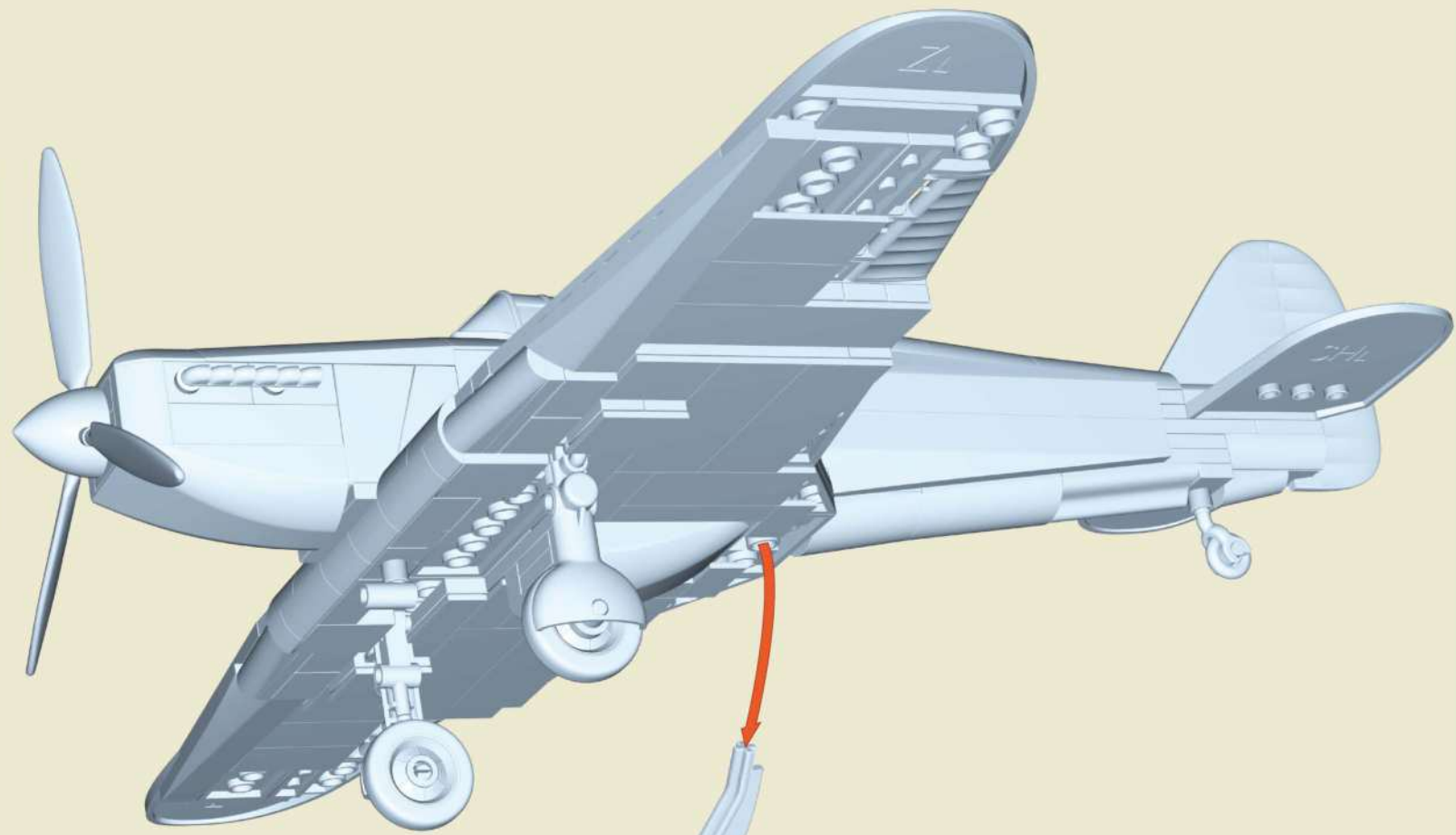
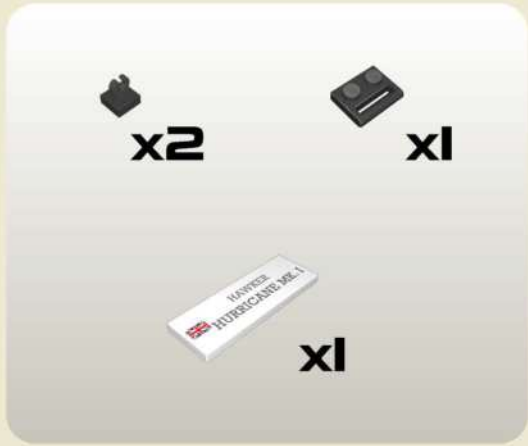

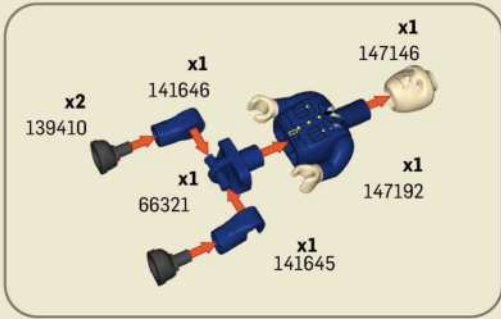

- | | | | | | | | | | | | |
|---------------------|---------------------|---------------------|---------------------|---------------------|---------------------|---------------------|---------------------|---------------------|---------------------|---------------------|---------------------|
| x2
141421 | x6
109389 | x2
110093 | x1
43969 | x4
92879 | x2
42879 | x2
44969 | x2
42928 | x1
42929 | | | |
| x2
42931 | x2
92647 | x1
42911 | x2
92649 | x3
92648 | x4
146281 | x8
106152 | x2
45159 | x2
45158 | | | |
| x3
45540 | x2
124779 | x2
111911 | x2
106342 | x1
118291 | x6
42903 | x2
124978 | x6
111184 | x2
44298 | | | |
| x1
140308 | x2
114622 | x4
138718 | x2
42959 | x3
95647 | x2
93457 | x2
100130 | x2
98979 | x4
120912 | x1
42974 | x3
92653 | x4
42982 |
| x2
42983 | x1
147510 | x3
135085 | x1
62197 | x4
64202 | x1
147428 | x1
147426 | x4
134795 | x1
86041 | x2
43015 | x1
92654 | x1
85499 |
| x1
83478 | x1
135051 | x3
92656 | x1
43081 | x5
43082 | x2
92658 | x1
43089 | x4
43090 | x2
44684 | x1
93861 | x1
92435 | x2
92884 |
| x2
92891 | x1
43107 | x2
84954 | x2
45303 | x2
45467 | x1
94078 | x2
131754 | x1
104131 | x4
122048 | x4
124624 | x1
43151 | x4
43152 |
| x2
43154 | x3
92663 | x3
89467 | x1
86989 | x1
147511 | x1
136062 | x1
135091 | x1
135056 | x4
120917 | x1
146867 | x3
43165 | x6
43166 |
| x1
92790 | x1
98983 | x1
147512 | x2
119721 | x1
109915 | x2
121337 | x3
43192 | x8
92670 | x1
121923 | x1
106337 | x1
106336 | x6
119722 |
| x1
112218 | x1
113555 | x1
118288 | x1
120212 | x1
108324 | x2
92672 | x1
100405 | x1
100403 | x1
147437 | x1
147438 | x2
118290 | x4
141417 |



x1
146837

x3
44838

x3
44756

x1
146838

x1
87252

x1
93866

x2
90270

x1
147439

x1
147441

x1
147442

x1
147513

x1
147514

x2
44630

x1
79696

x2
92674

x1
147509

x1
147451

x30
93960

x1
144075

x4
82966

x4
55889

x1
43290

x1
140607

x1
92810

x1
140608

x2
60889

x1
122004

x1
147445

x1
147446

x1
92685

x2
121340

x1
93732

x1
98304

x2
93733

x1
92692

x1
92693

x1
92694

x1
93296

x1
97531

x2
92679

x2
132609

x2
108112

x1
58332

x1
43491

x1
107031

x1
140336

x1
147447

x1
147449

x1
147450

x2
44300

x2
44292

x2
44299

x2
44291

x2
92678

x1
43627

x2
92702

x1
43634

x1
92703

x1
147436

x1
147436

x1
147433

x1
147433

x1
92646

x1
43228

x4
92657

x1
147429

x1
147430

x1
147434

x1
147435

x1
147440



HISTORICAL COLLECTION



MIG-15 NATO "FAGOT"
★ 2416



MITSUBISHI A6M2 "ZERO-SEN"
☀ 5729



LIM-5 POLISH AIR FORCE 1959
🇵🇱 5824



Produced under license from Boeing. Boeing and the P-51 Mustang are trademarks of The Boeing Company.



P-51D MUSTANG™
★ 5719



For news and special deals

WWW.COBI.EU

00-05728-371

Find us on:

