

# HISTORICAL COLLECTION

## WORLD WAR II



Produced under license.  
Boeing, Douglas, the distinctive  
Boeing logos, product markings  
and trade dress are trademarks of  
The Boeing Company.

**DOUGLAS™ C-47 SKYTRAIN (DAKOTA)**  
 IN SERVICE - 1941-50s  
 PLACE OF ORIGIN - UNITED STATES  
 ROLE - MILITARY TRANSPORT AIRCRAFT  
 WINGSPAN - 29,1m (95' 6")  
 LENGTH - 19,4m (63' 9")  
 HEIGHT - 5,2m (17')  
 EMPTY WEIGHT - 8226kg (18,135Lb)  
 ENGINE - 2x PRATT & WHITNEY R-1830-90C,  
 1200HP (985kW)  
 RANGE - 2575km (1,600mi)  
 RATE OF CLIMB - 5,3m/s (1,043ft/min)  
 MAXIMUM SPEED - 360km/h (224MPH)  
 MAXIMUM FLIGHT LEVEL - 8045m (26,400ft)  
 CREW - 3



5743

Printed in EU



**WARNING: CHOKING HAZARD-**  
 Toy contains small parts.  
 Not for children under 3 years.

896 2

**DOUGLAS™ C-47 SKYTRAIN (DAKOTA)**

SCALE 1:48

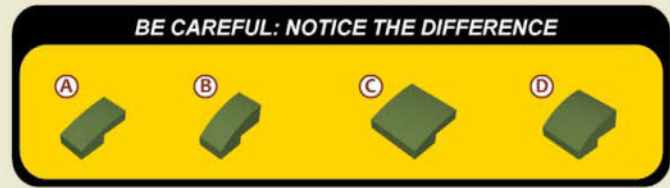

1

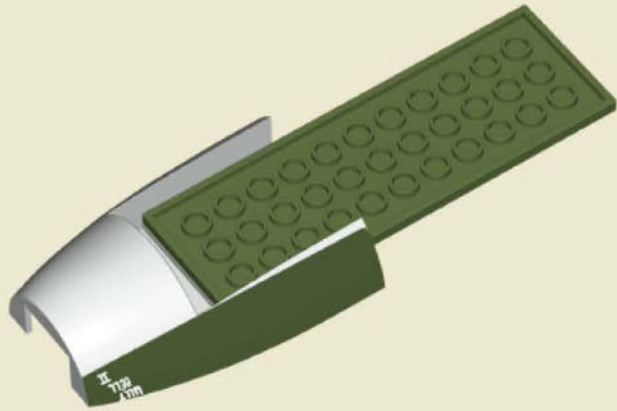

2



3

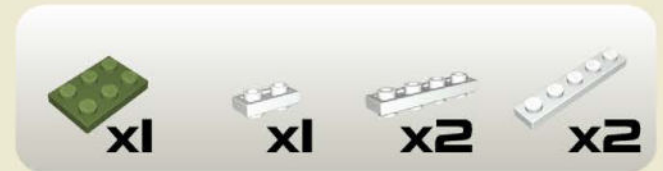
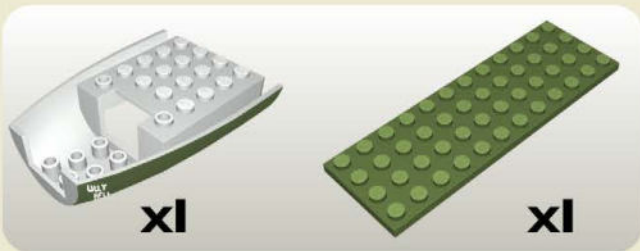
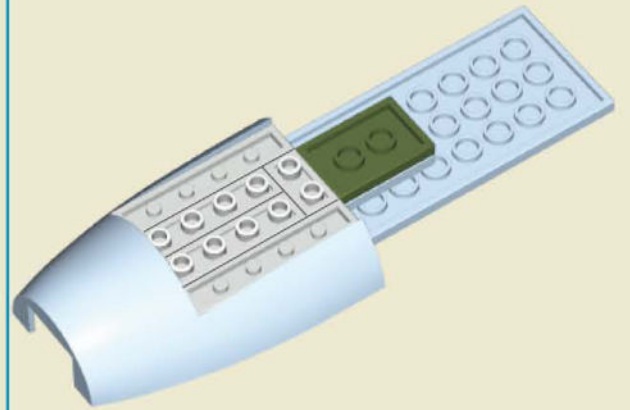

4

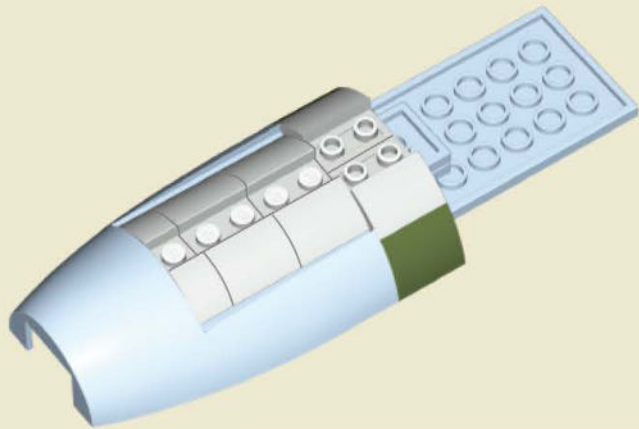

5

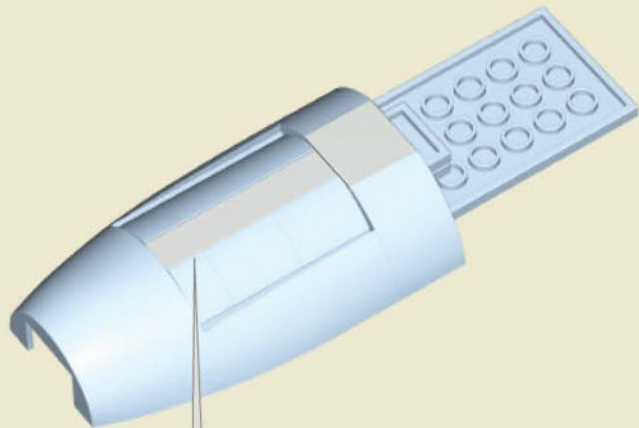

1:1



6

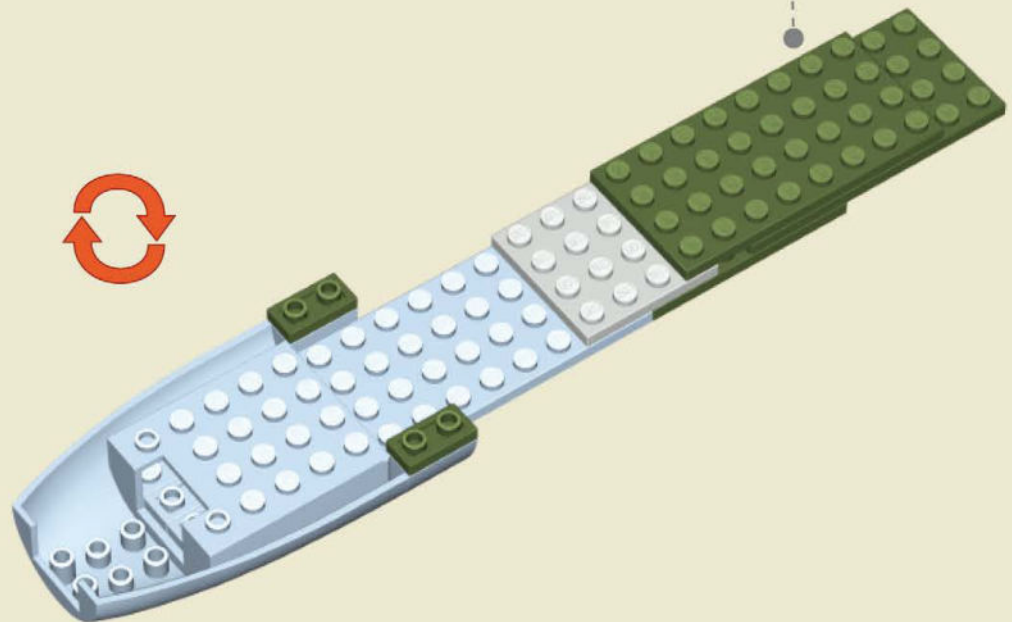
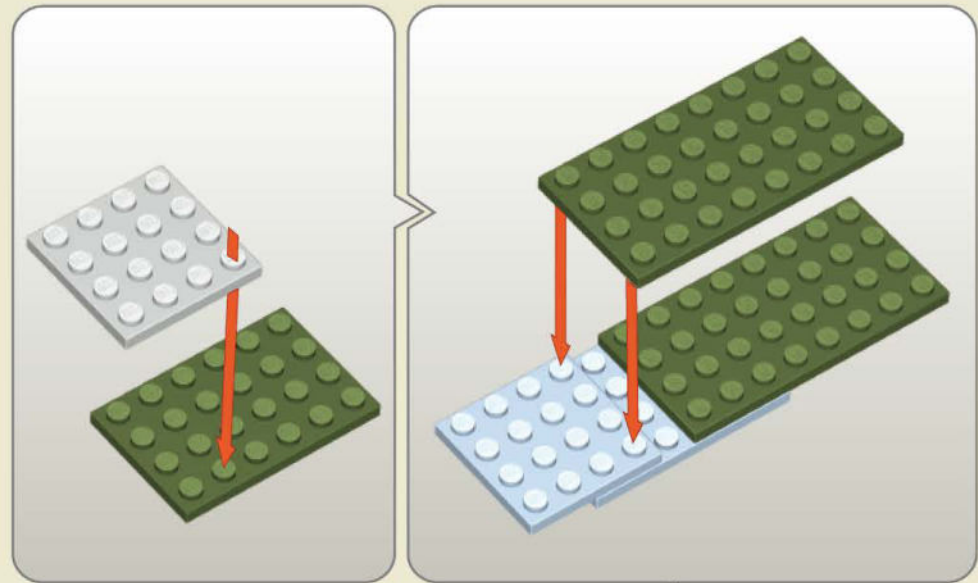

7

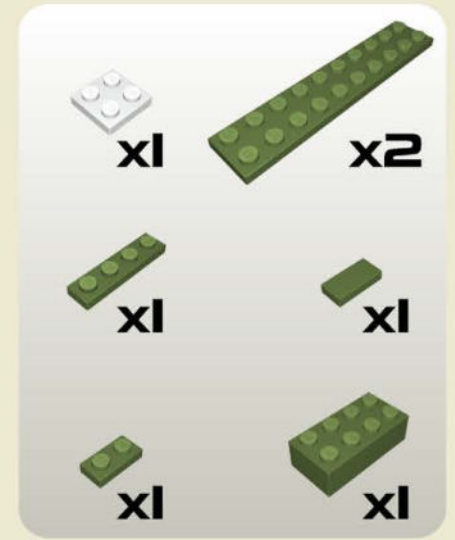
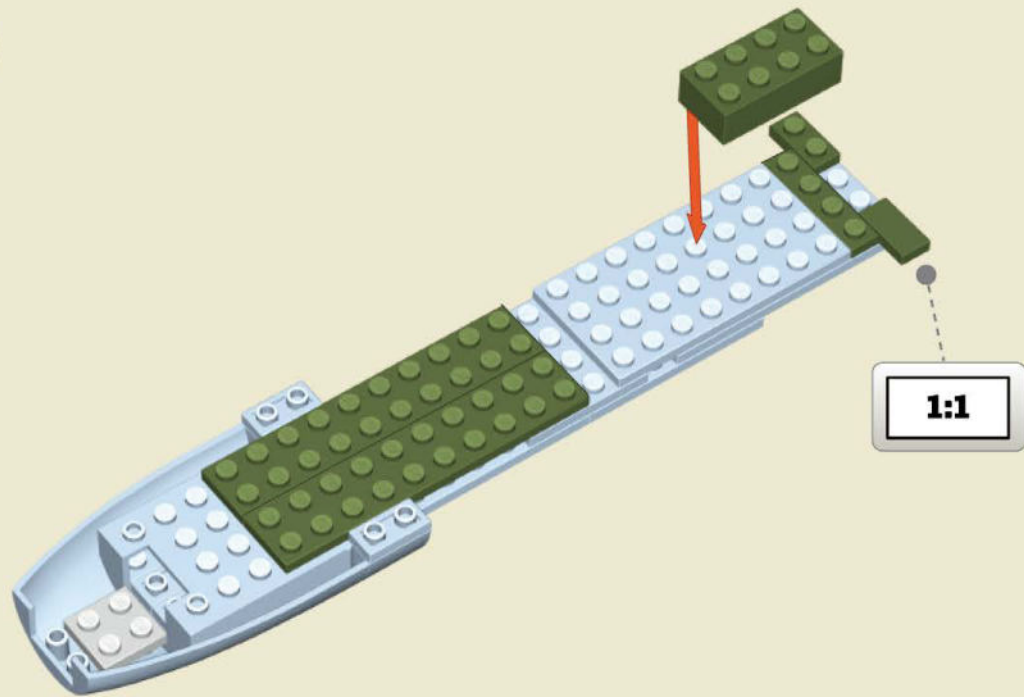

8

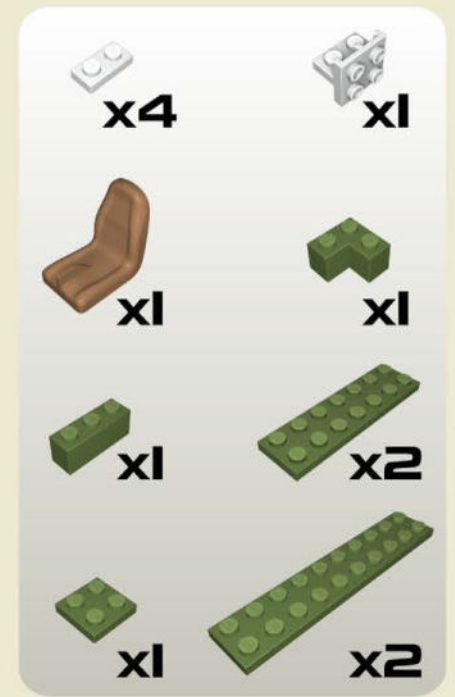
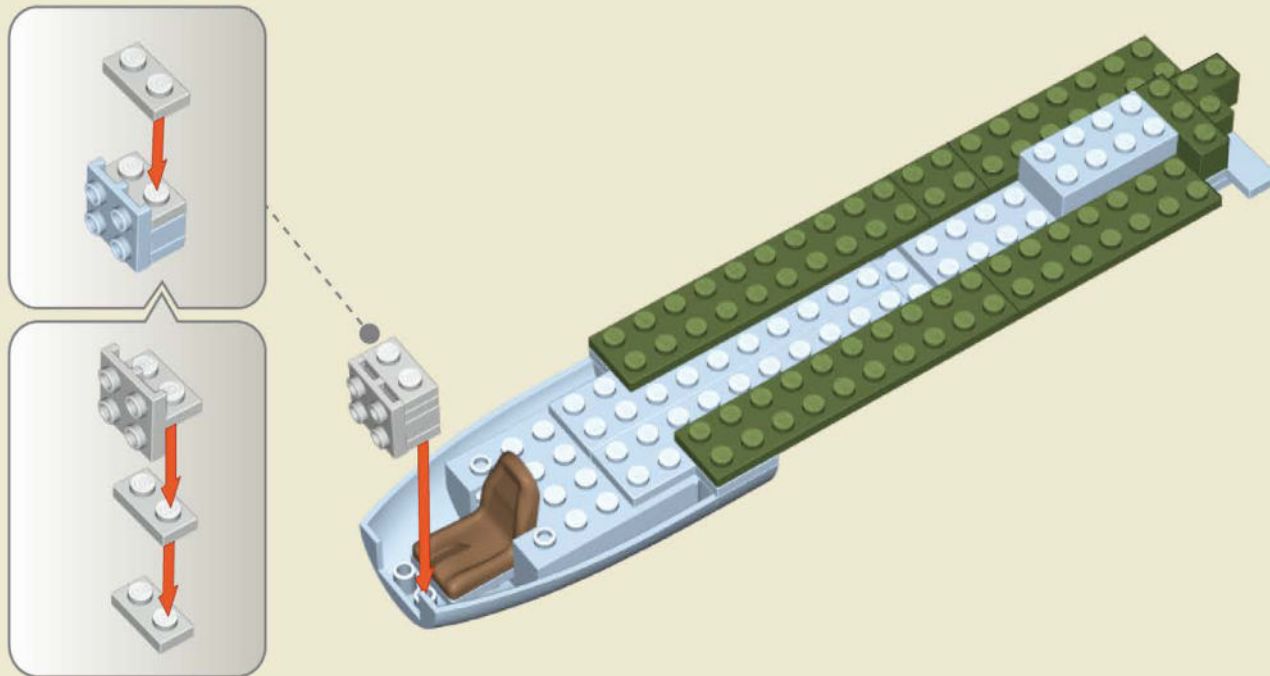

9

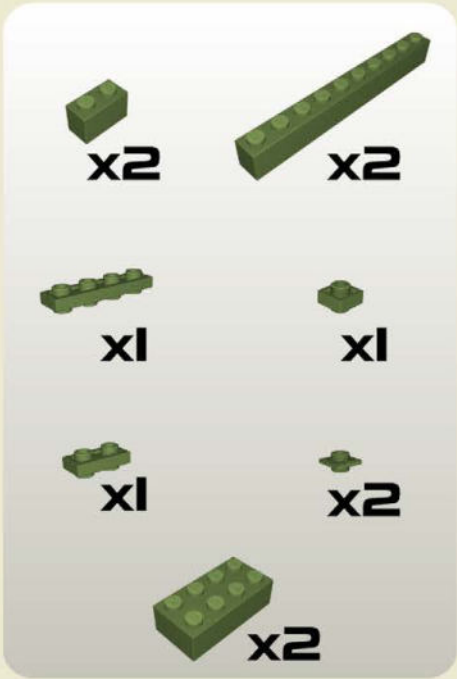
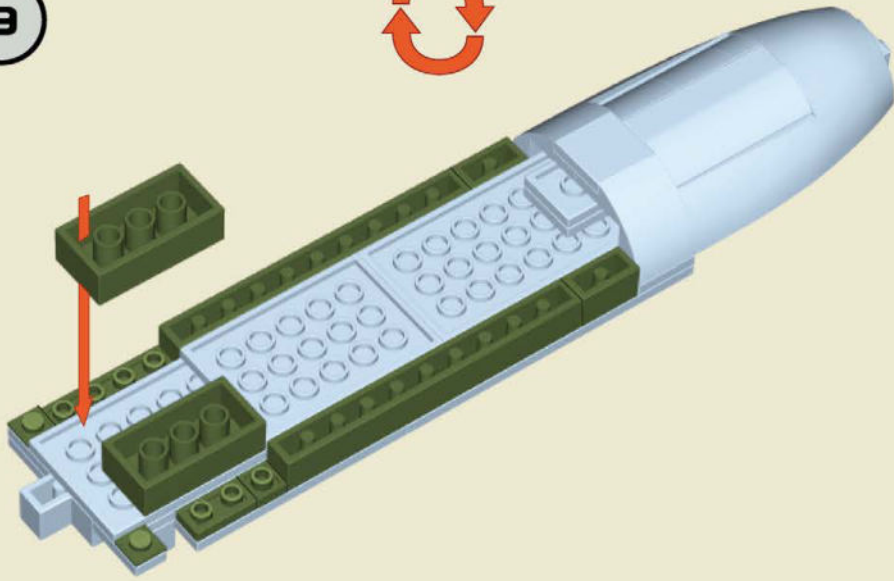

10

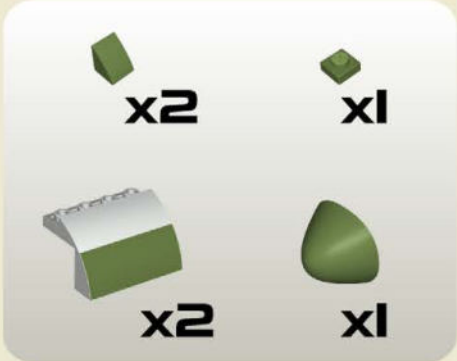
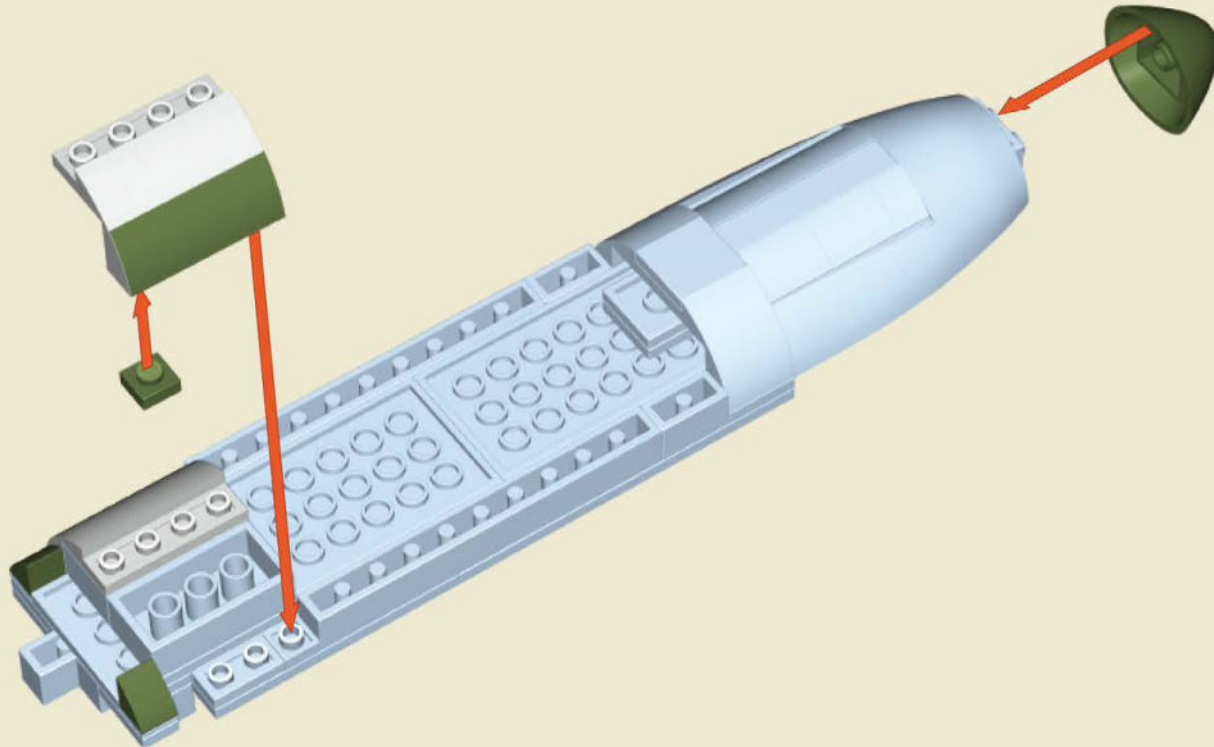

11

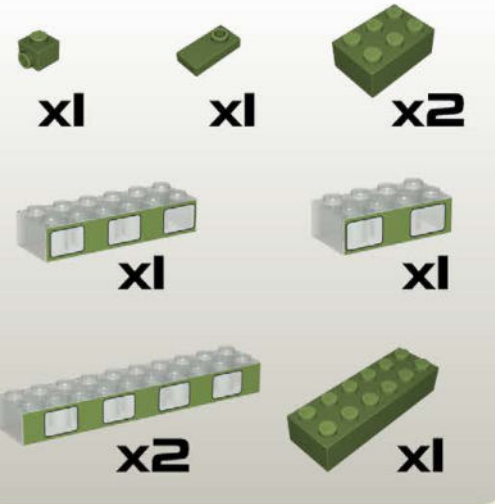
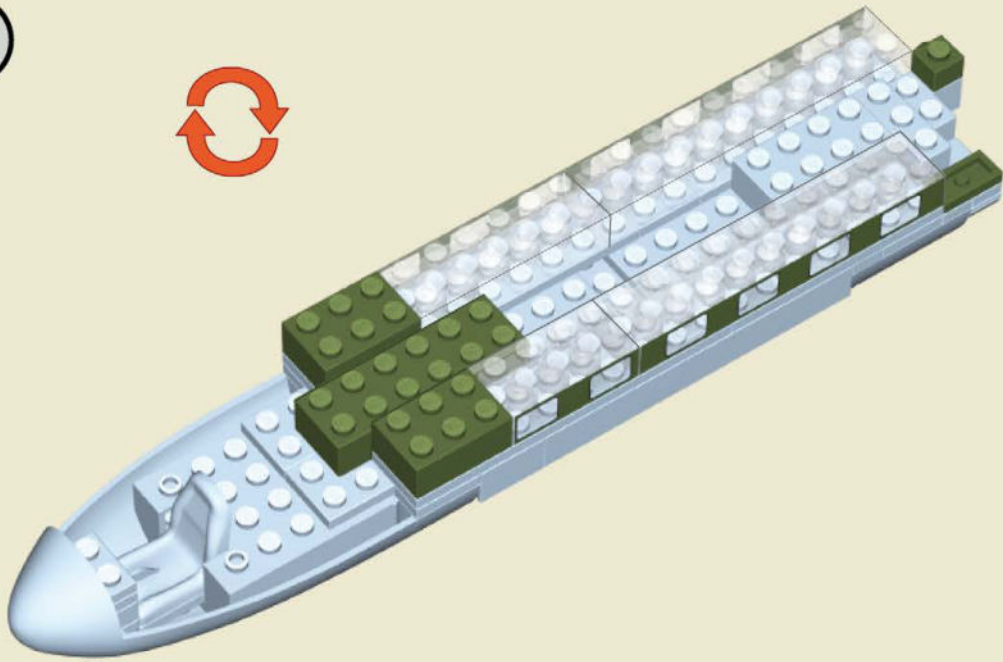

12

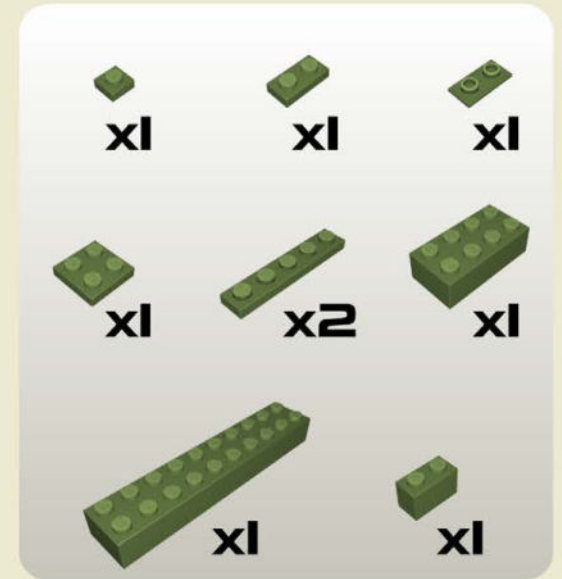
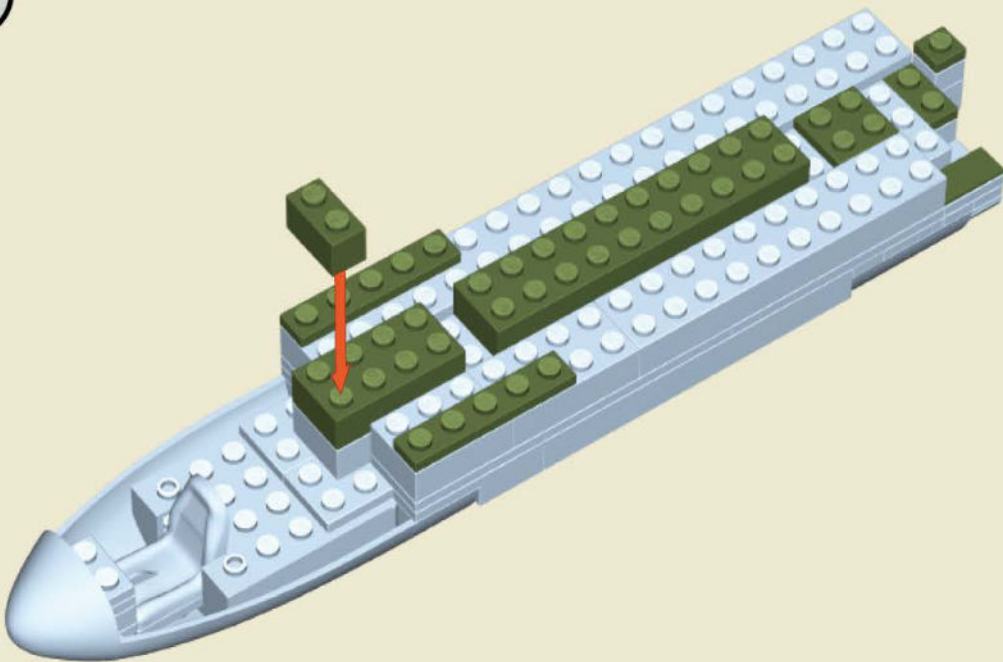

13

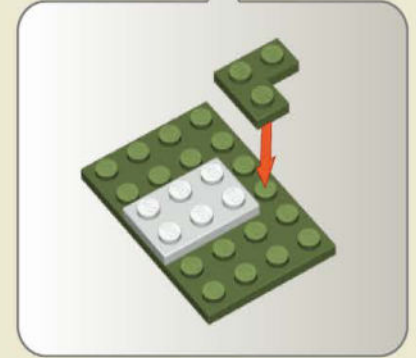
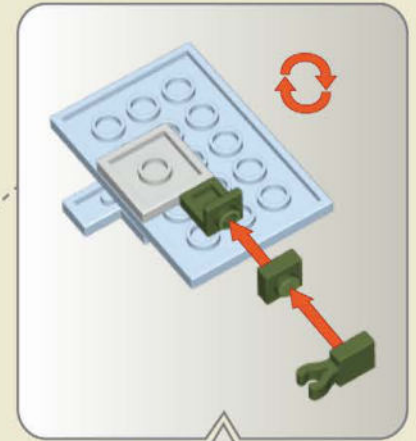
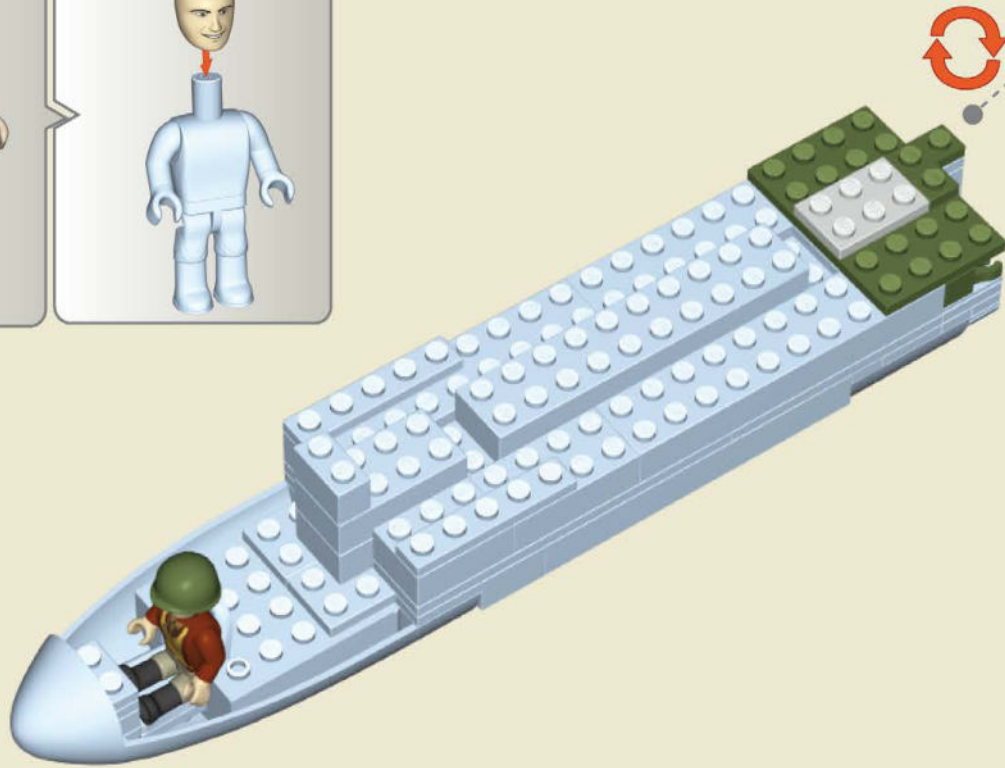

- x1
- x1
- x1
- x2
- x1
- x1
- x1
- x1
- x1
- x1
- x1
- x1
- x1
- x1

14

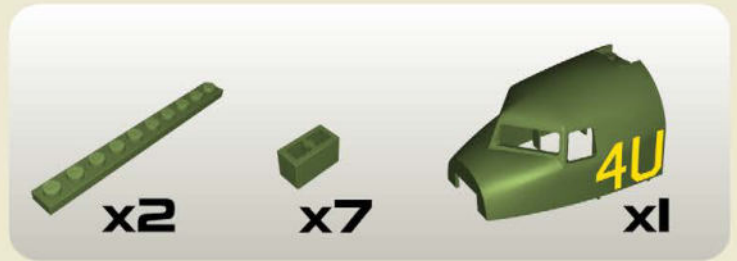
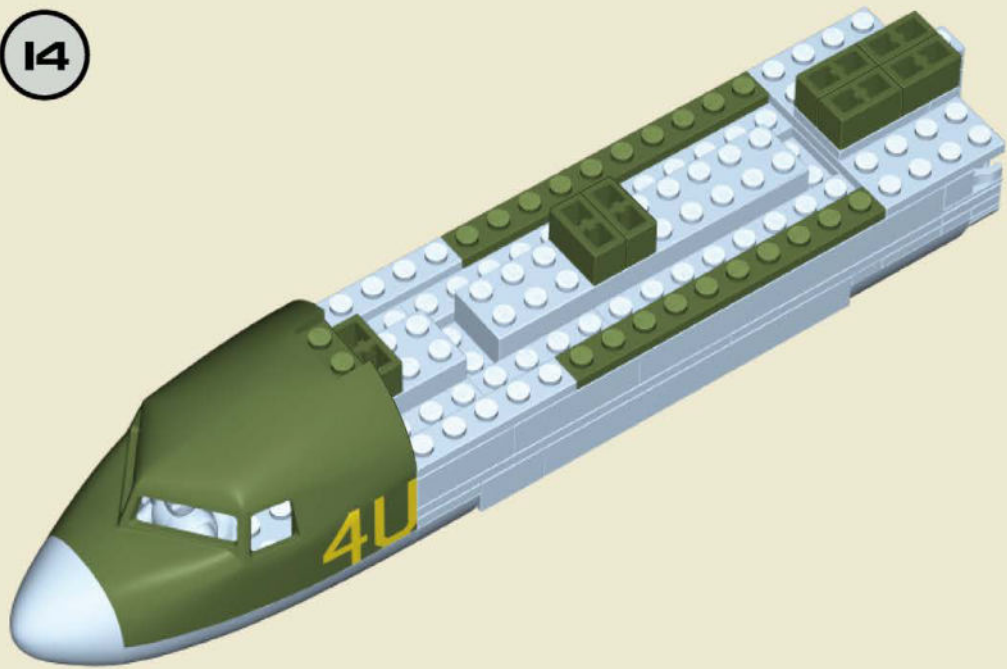

15

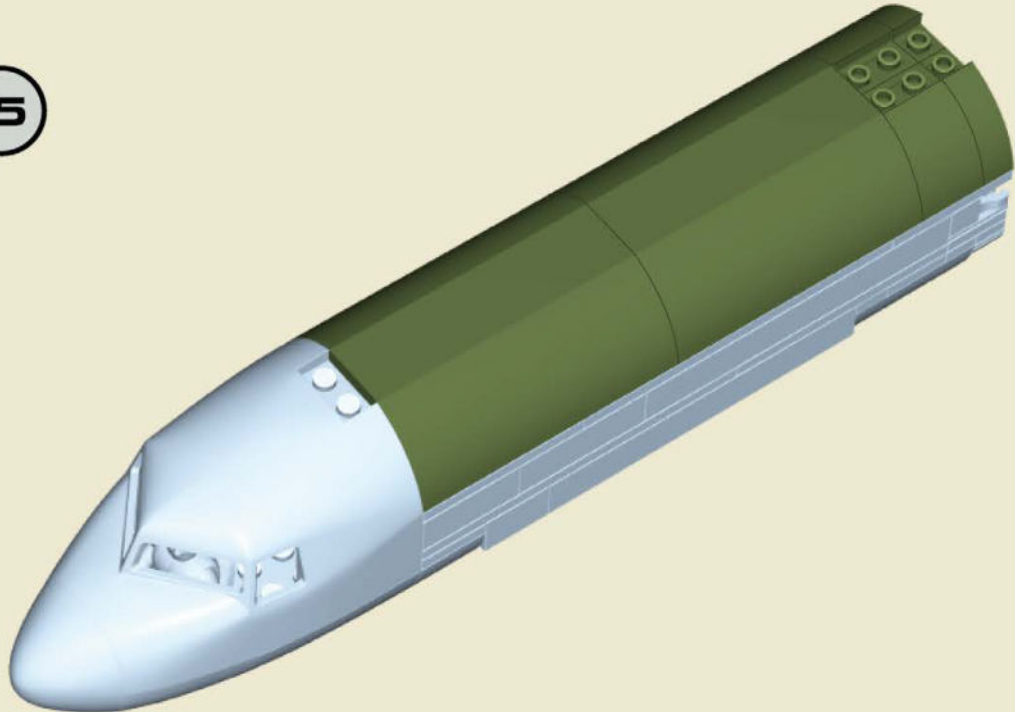



16

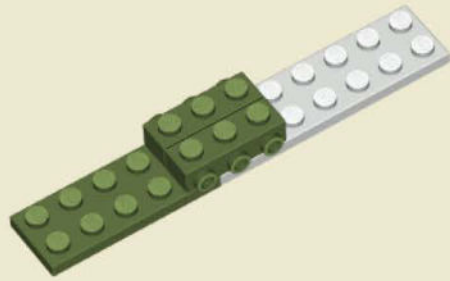

17

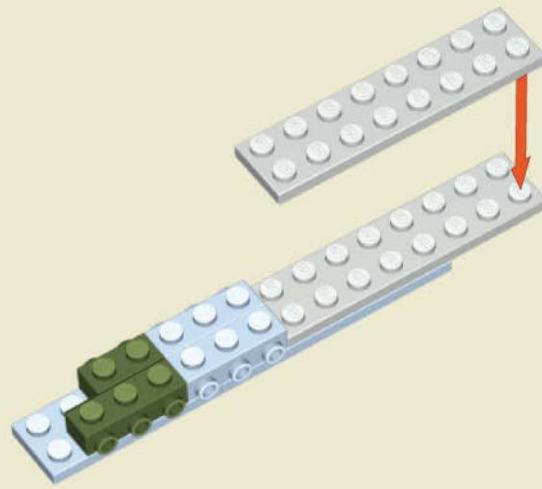

18

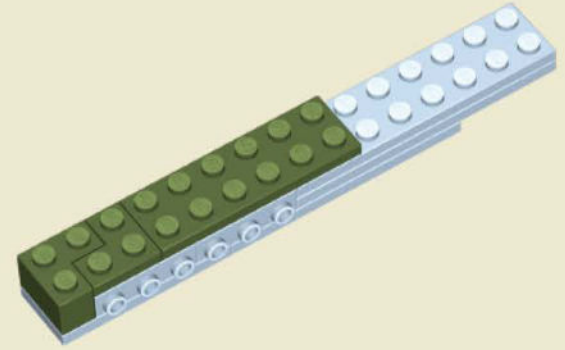

19

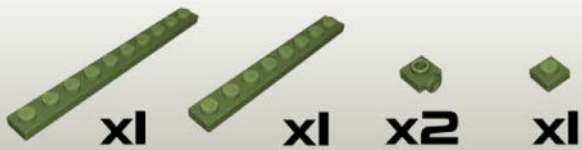
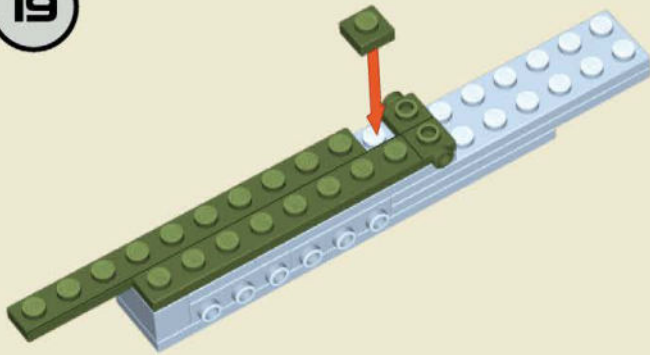

20

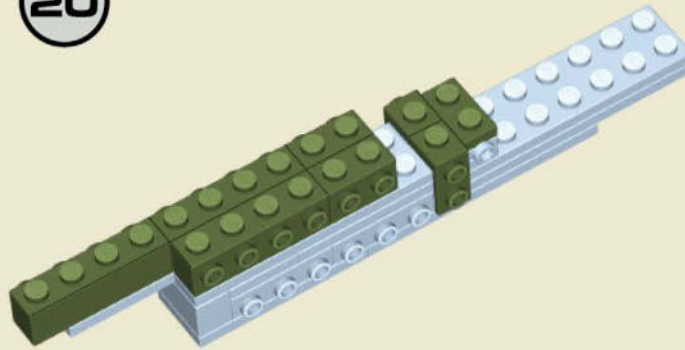

21

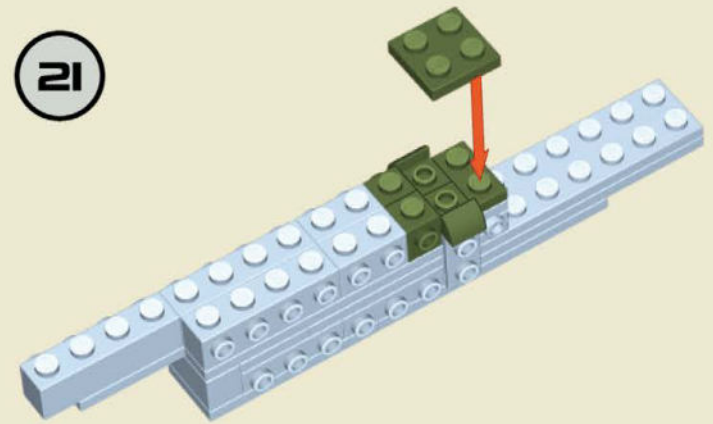

22

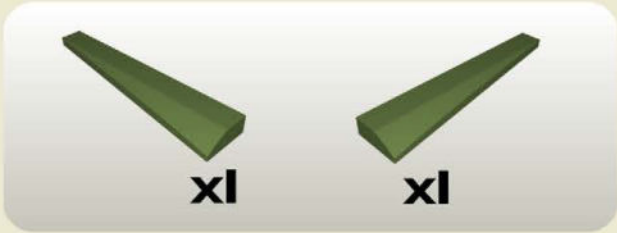
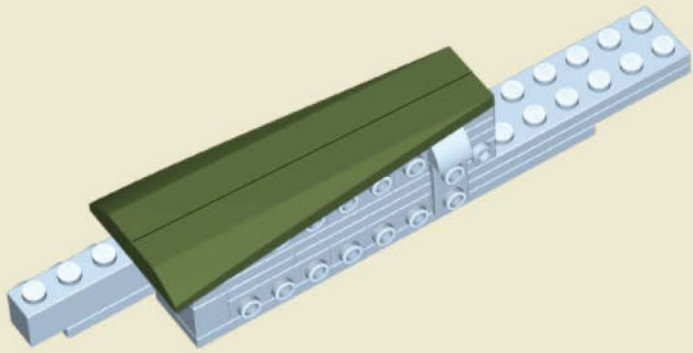

23

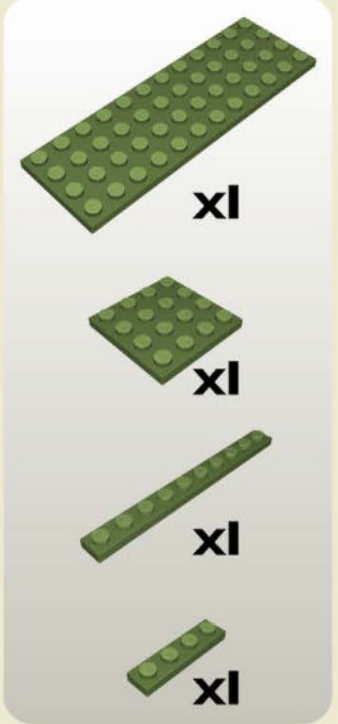
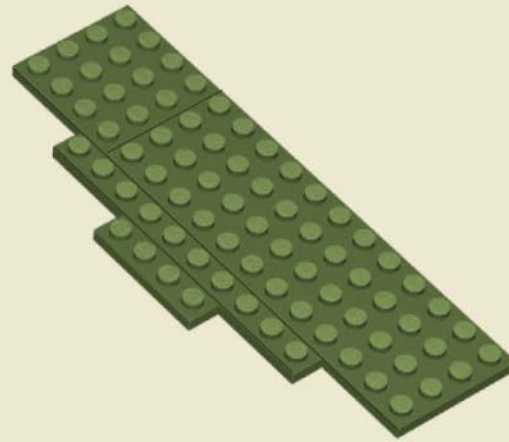

24

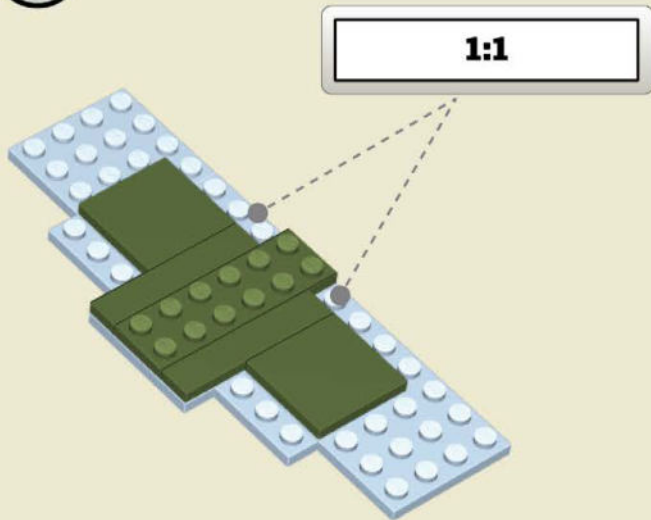

25

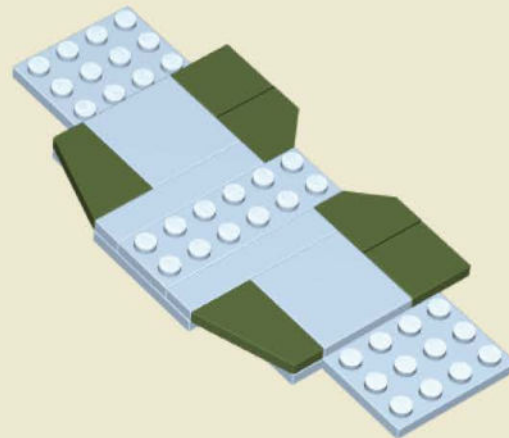

26



27

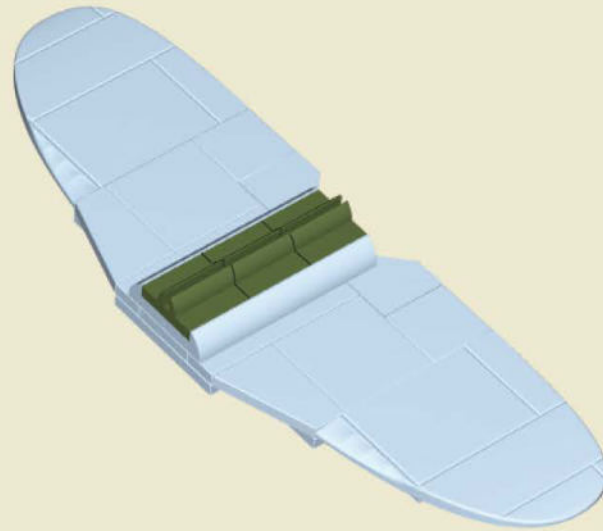

28

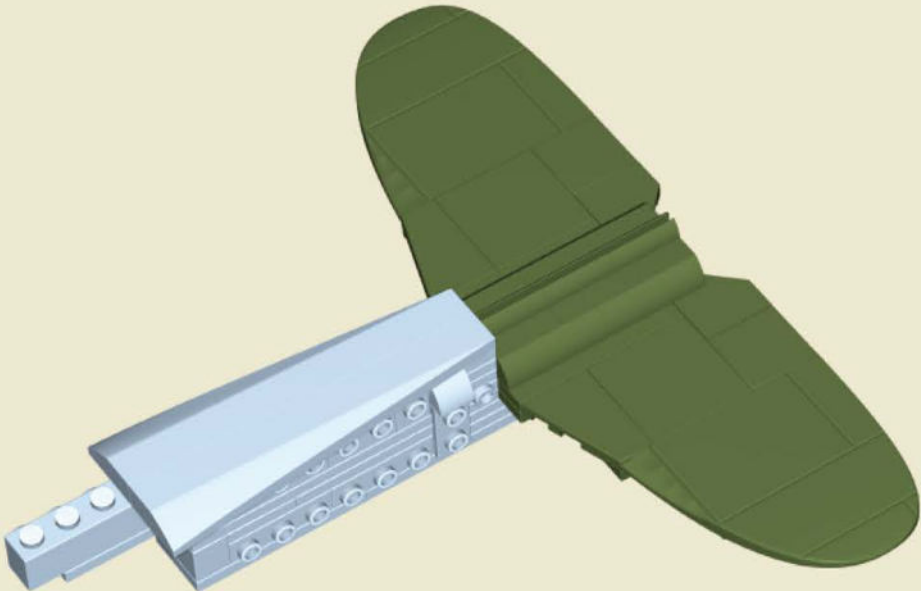

29

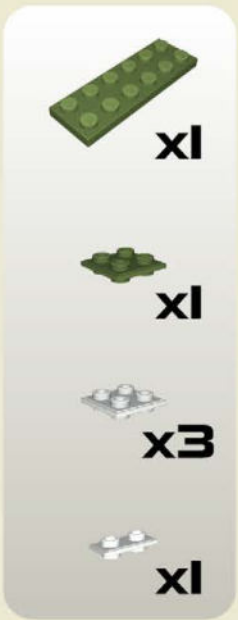
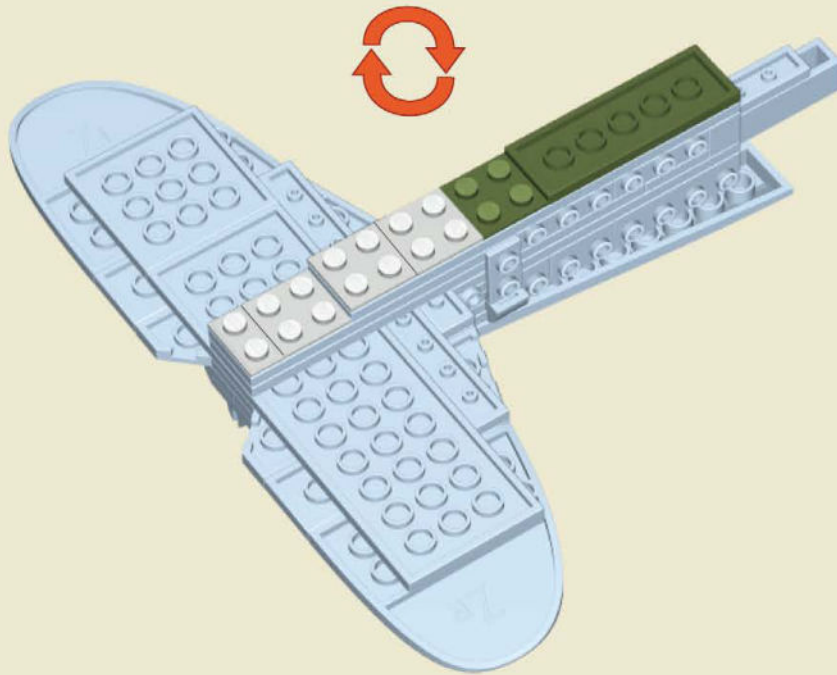

30

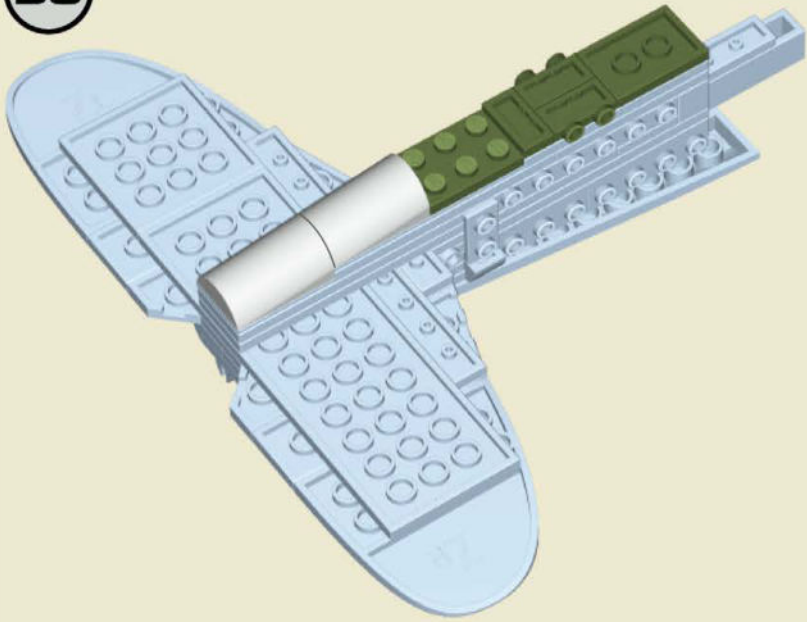

x2



x2



x1



x2

31

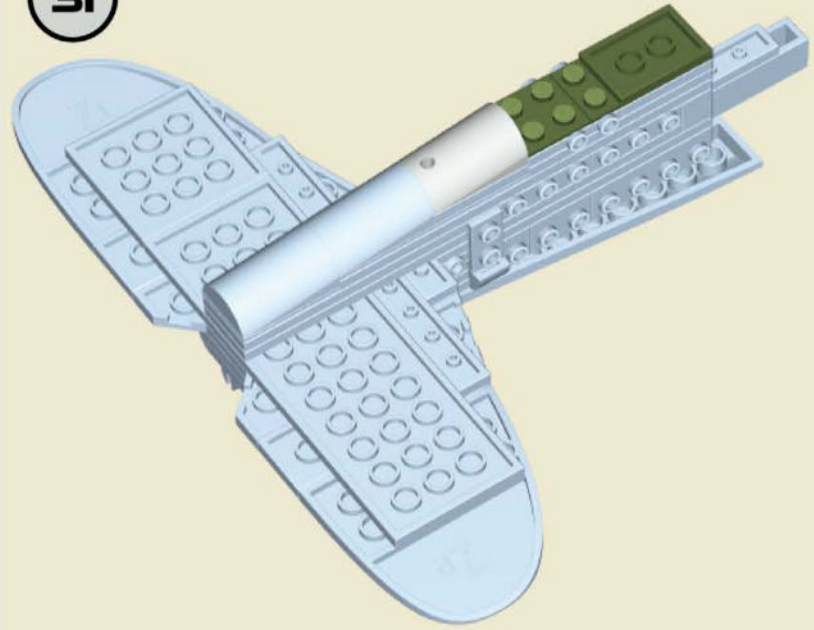

x1



x1



x1



x1

32

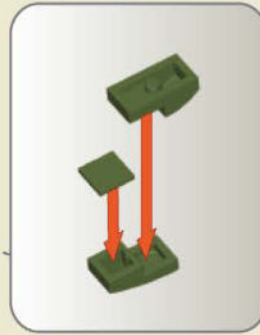
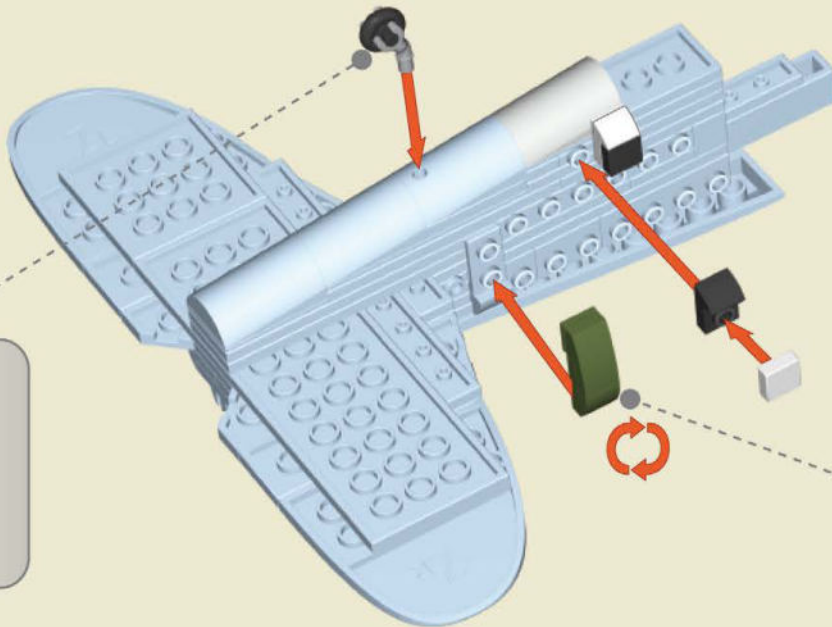

x1



x1



x1



x1



x1



x1



x1



x1



x1



x1

33

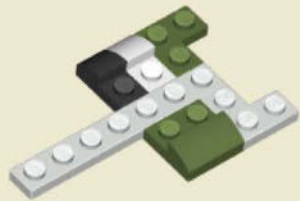

34

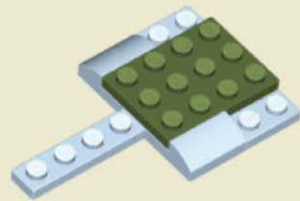

35

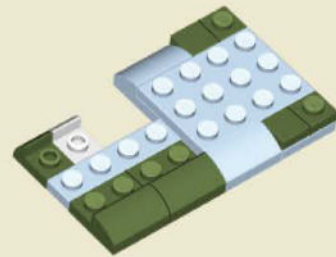

36

1:1

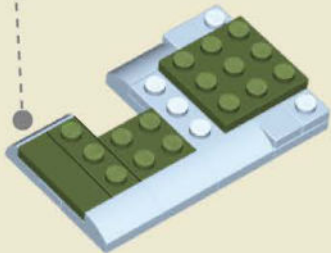

37

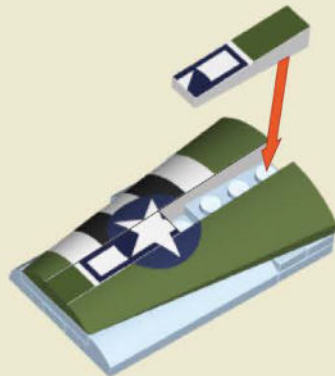

38

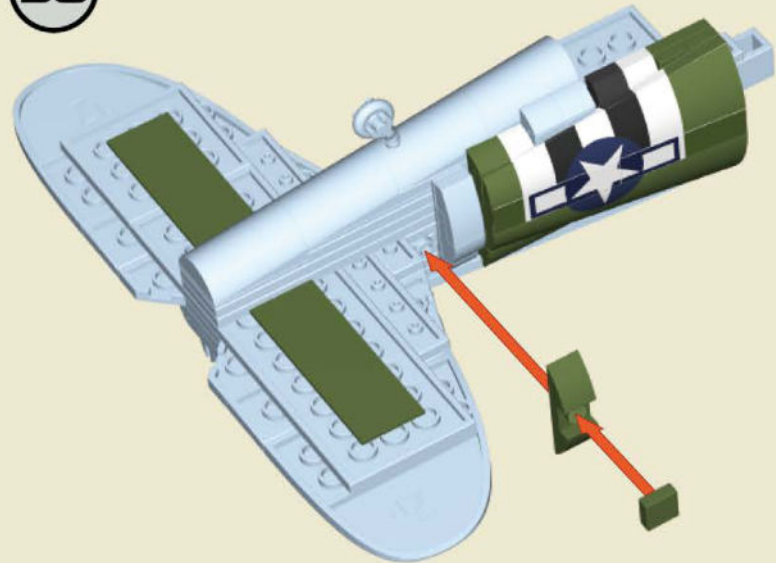

39

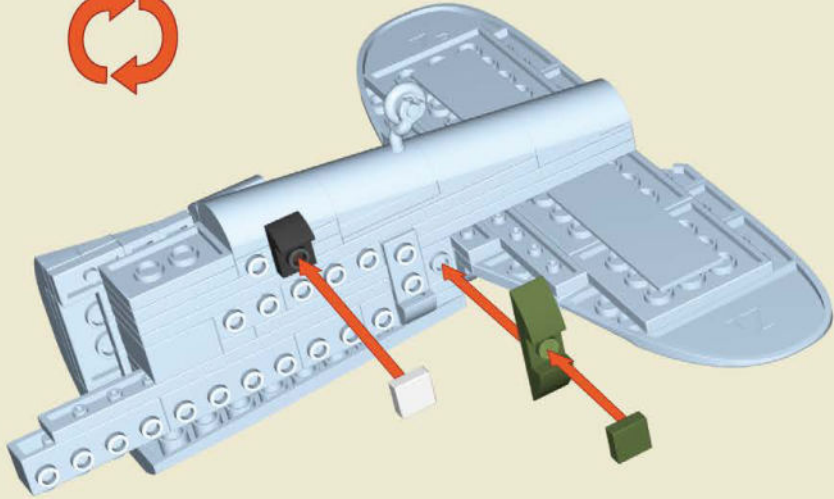

40

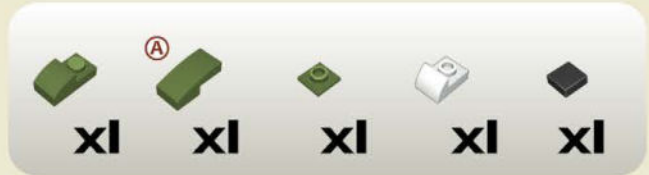
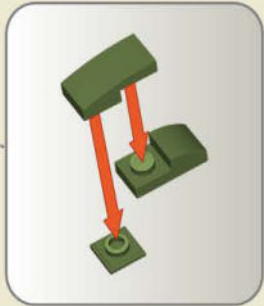
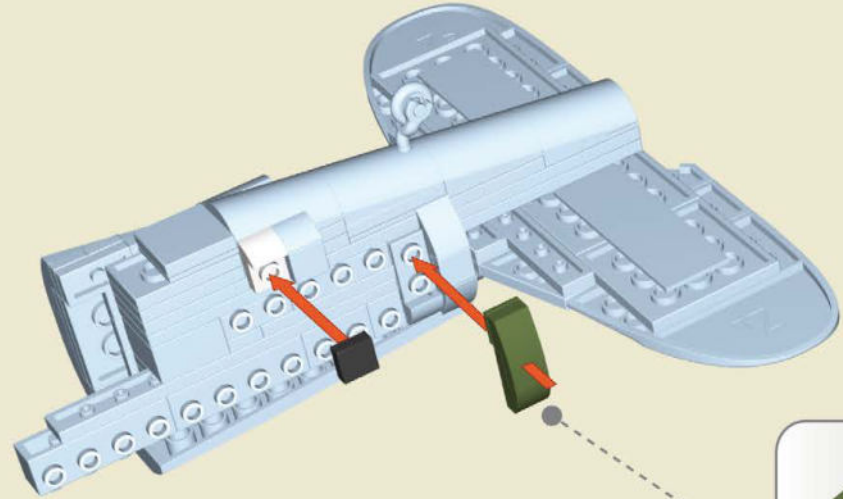

41

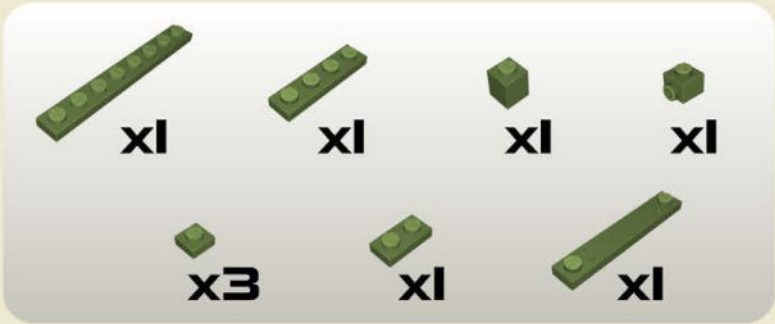
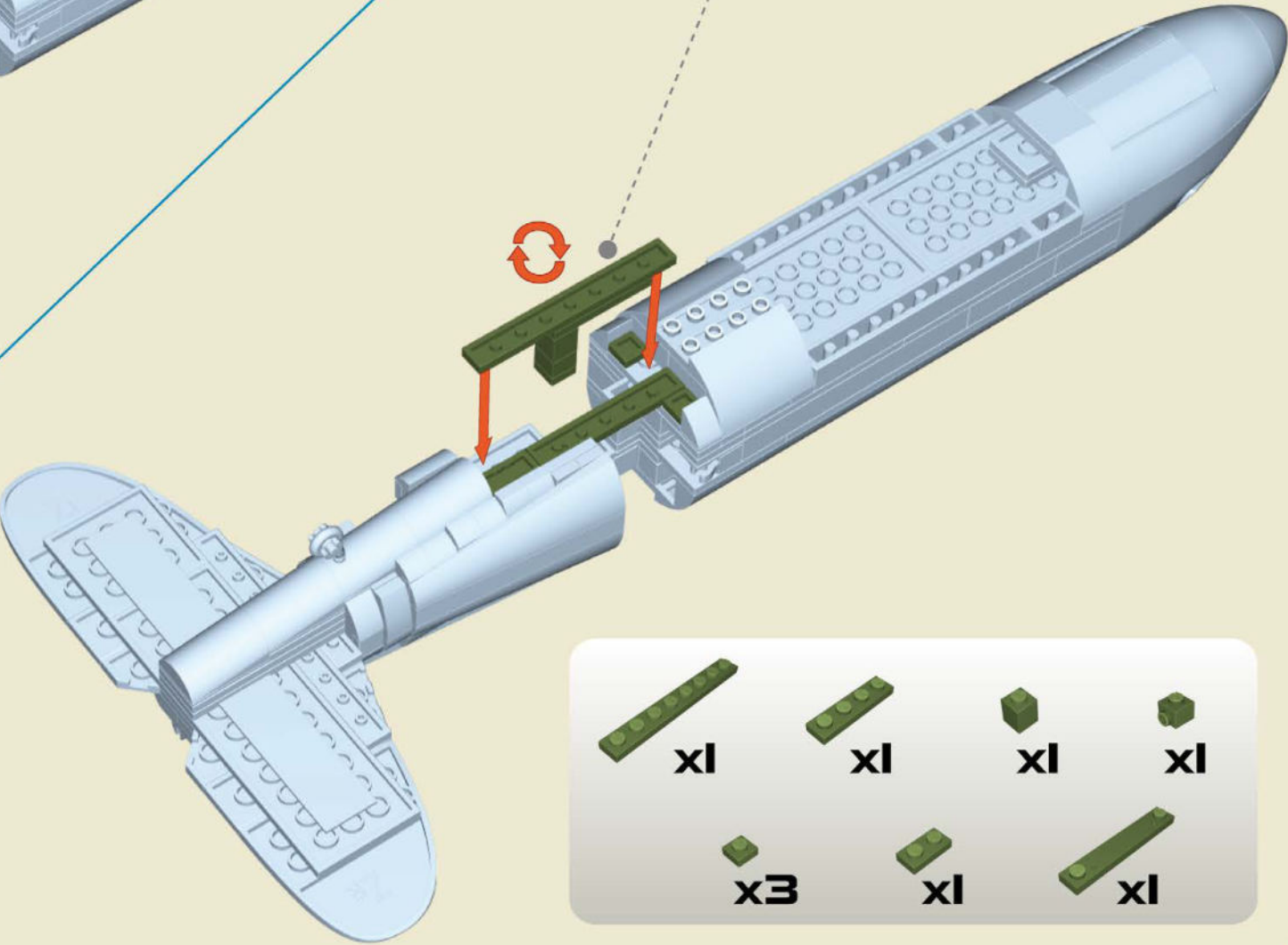
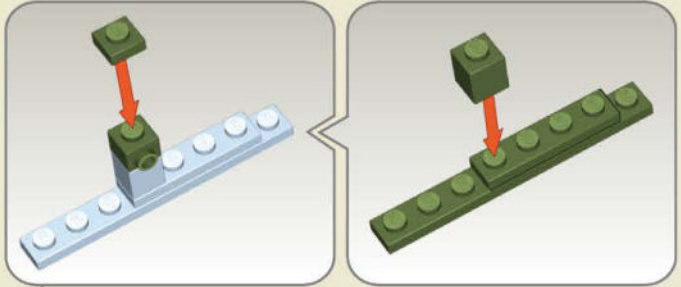
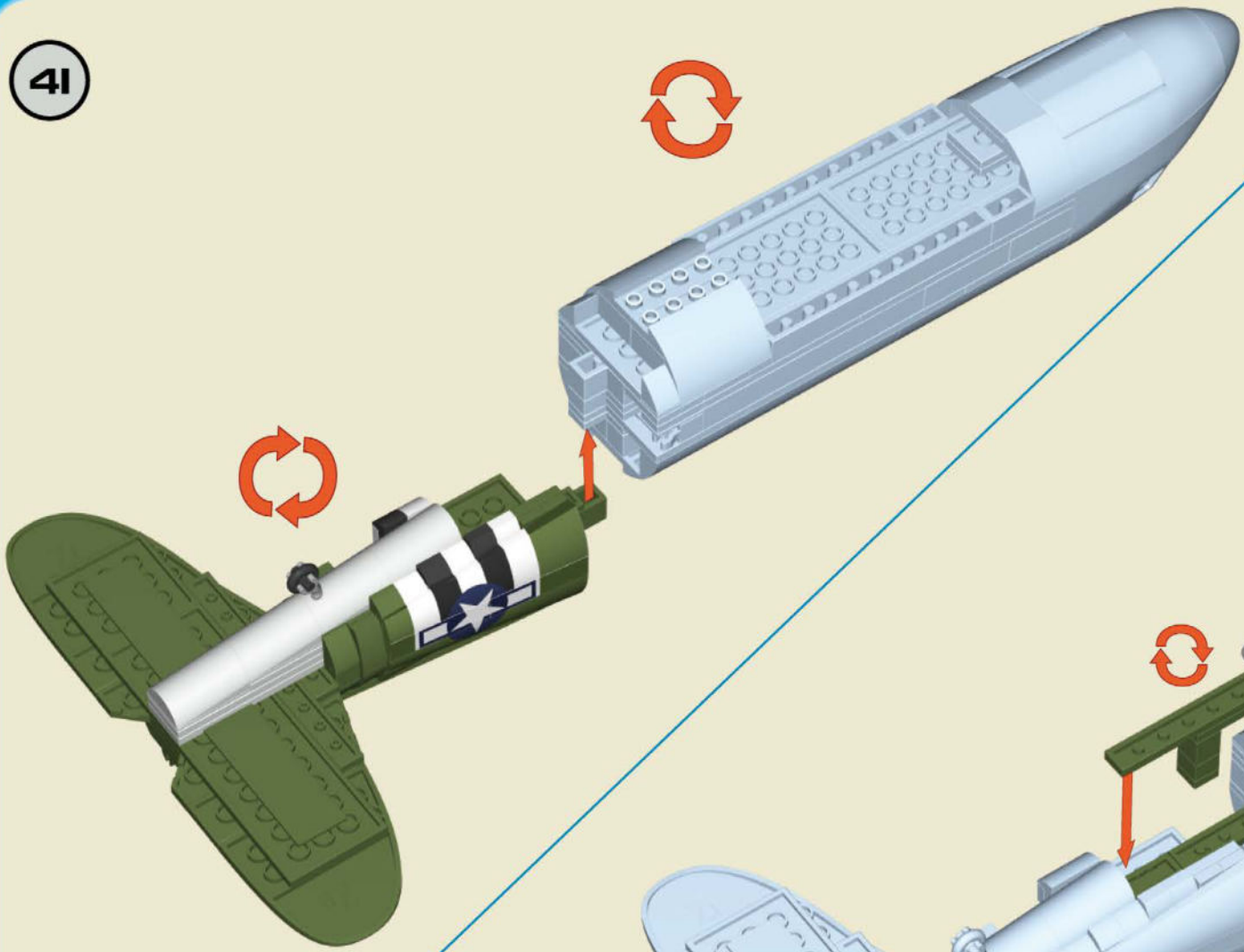



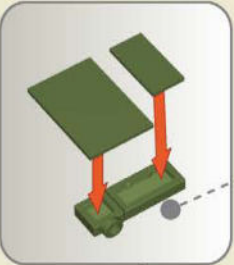
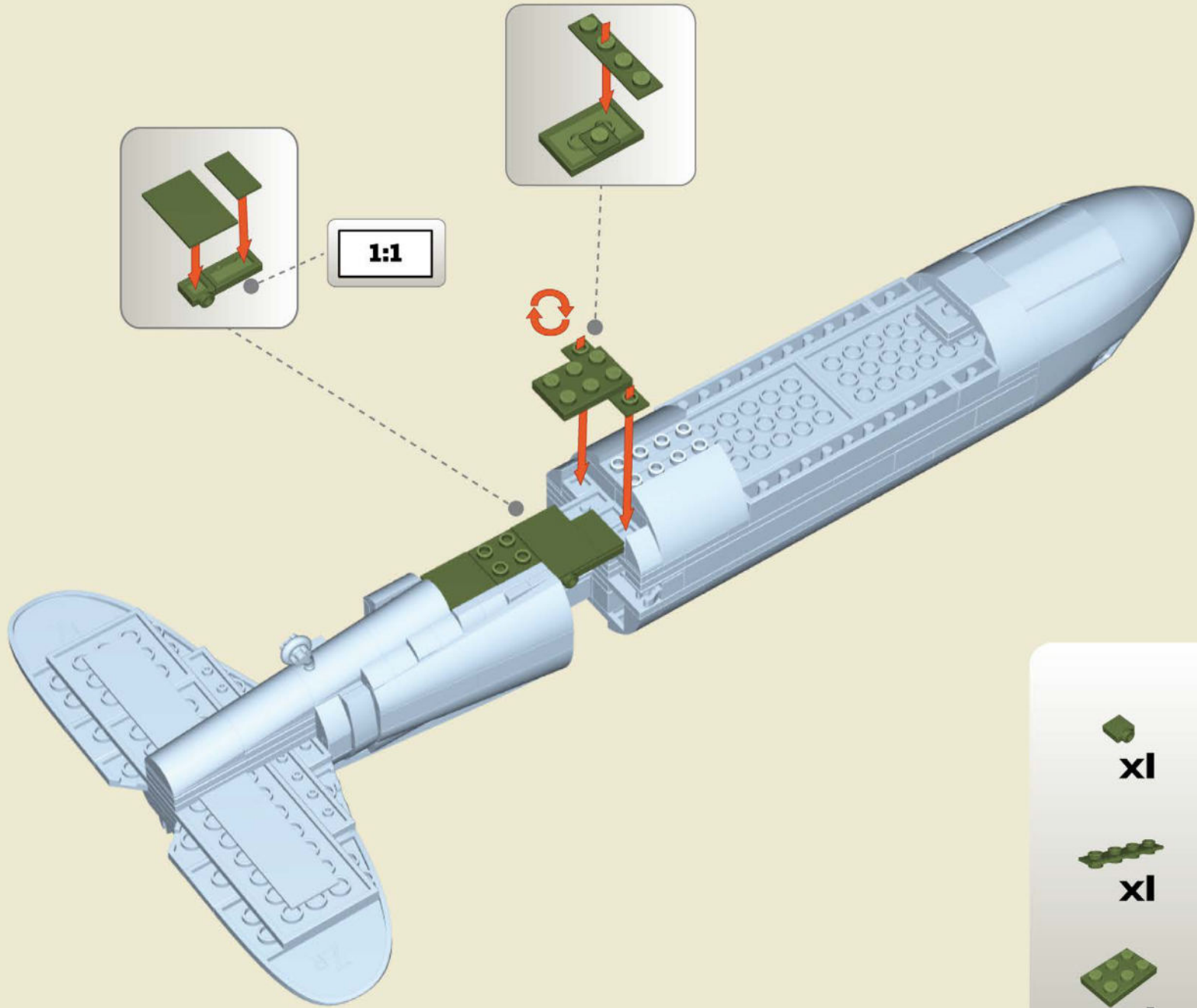



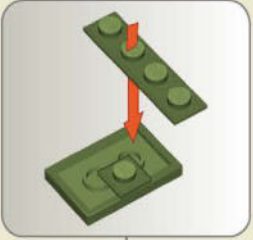

42



1:1



- |   |   |   |
|---|---|---|
| <br>x1 | <br>x1 | <br>x1 |
| <br>x1 | <br>x1 | <br>x1 |
| <br>x1 | <br>x1 | <br>x1 |



44

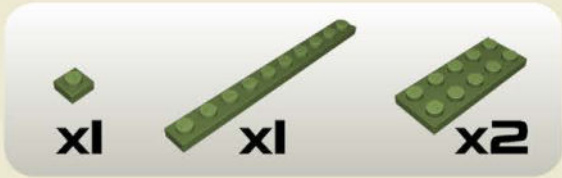
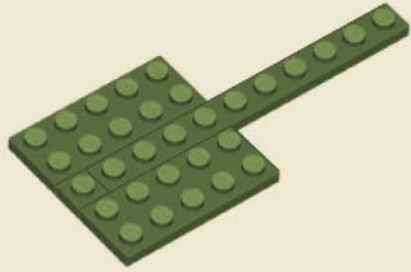

45

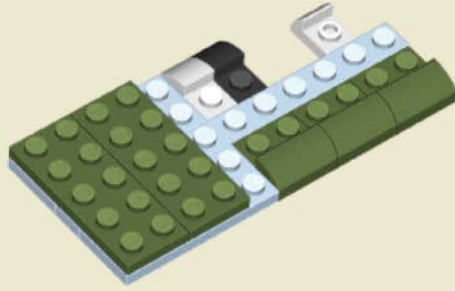

46

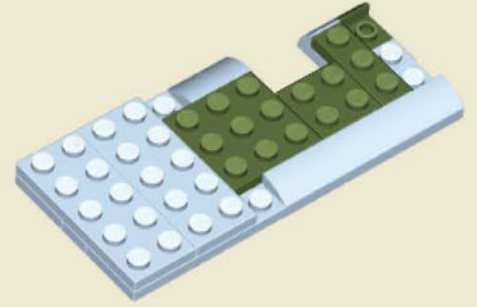

47

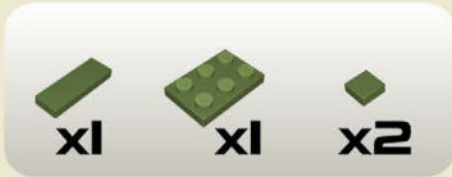
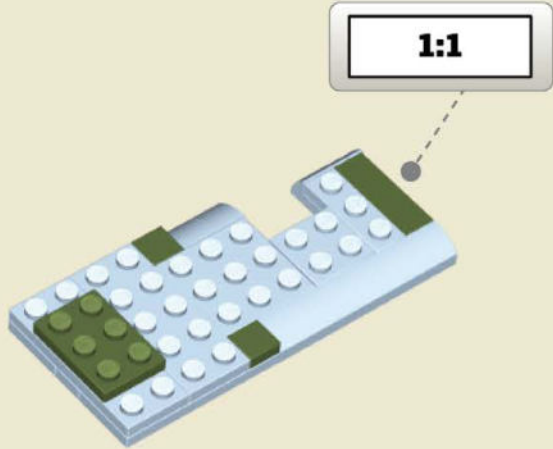

48

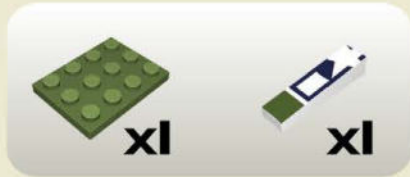
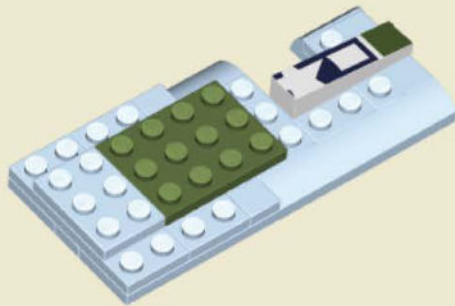

49

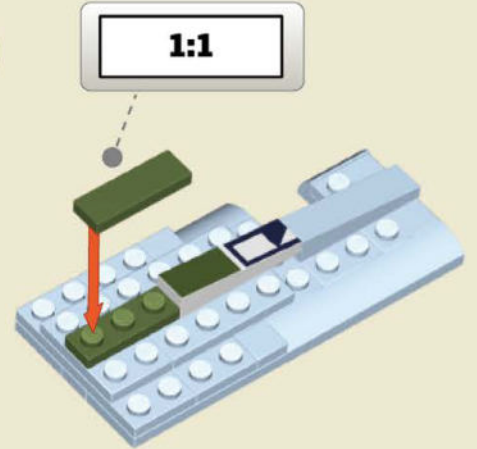

50

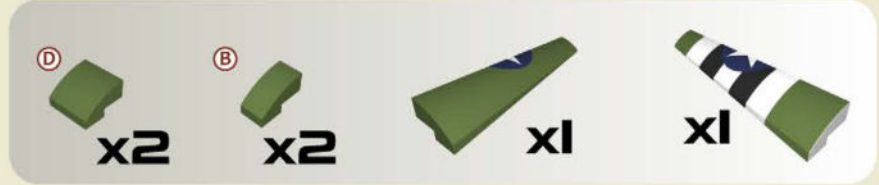
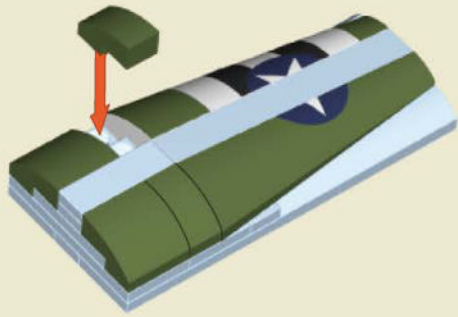

51

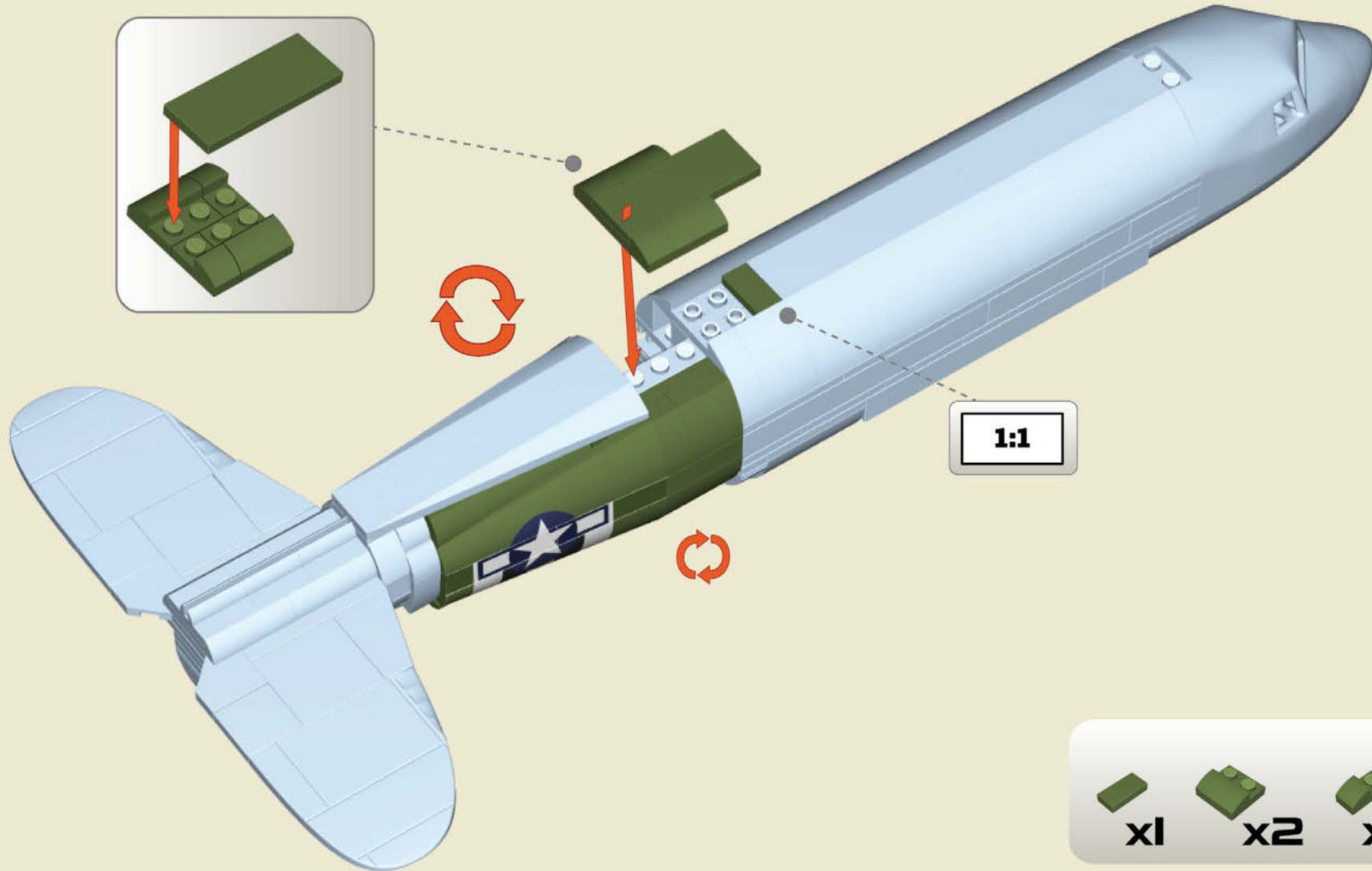
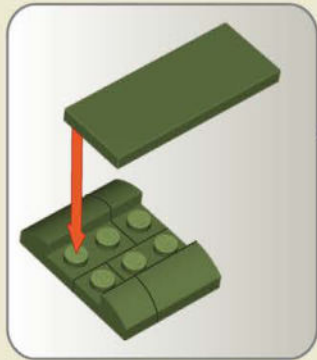

-  x1
-  x2
-  x1
-  x1
-  x2
-  x2
-  x1
-  x1

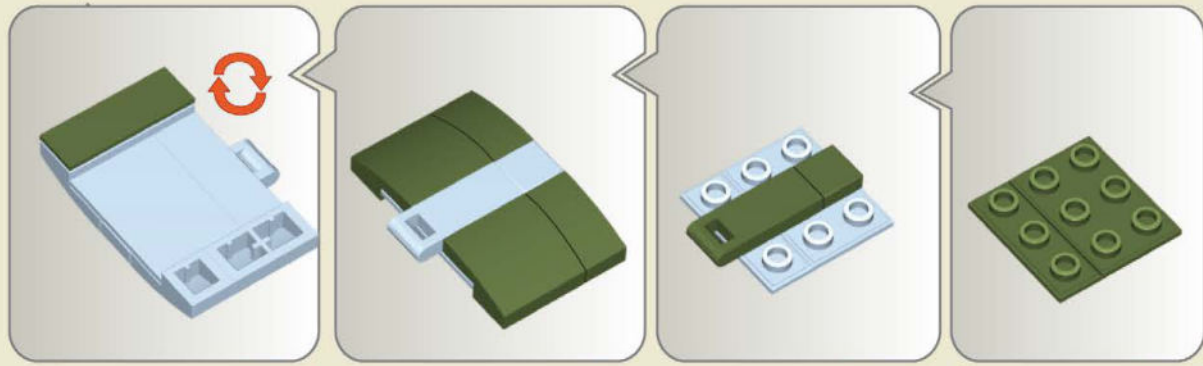
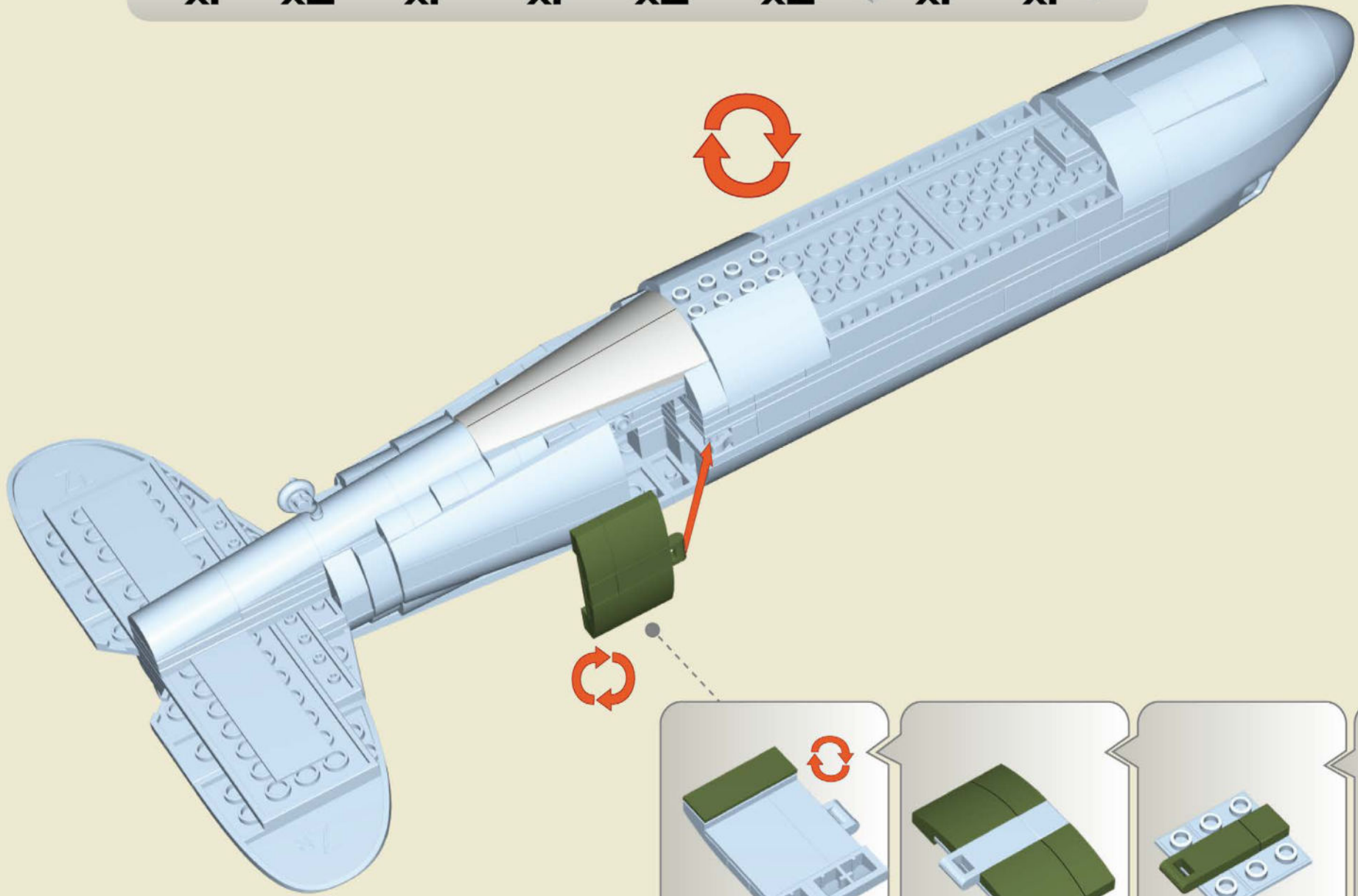



53

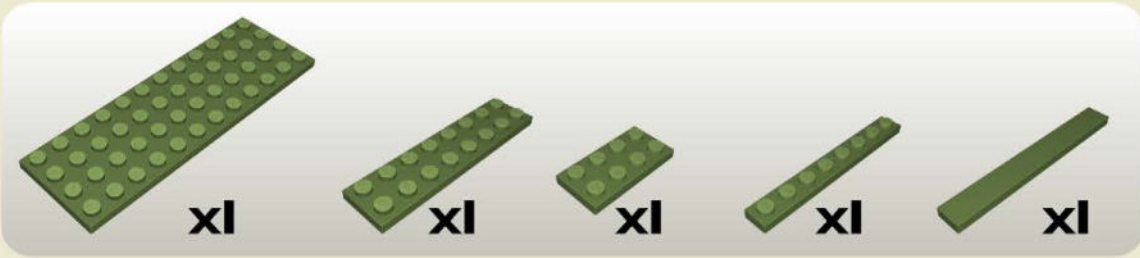

1:1

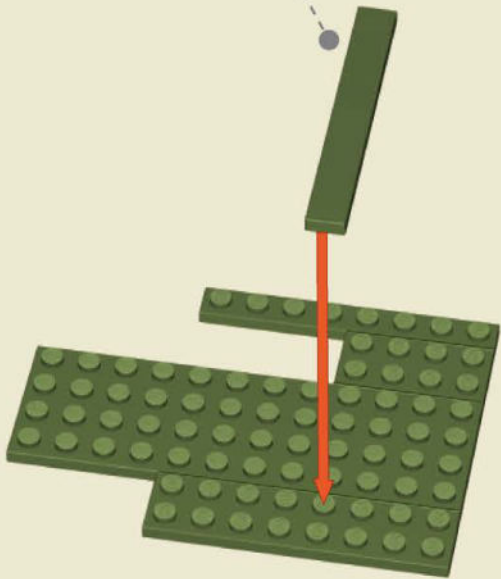

54

1:1

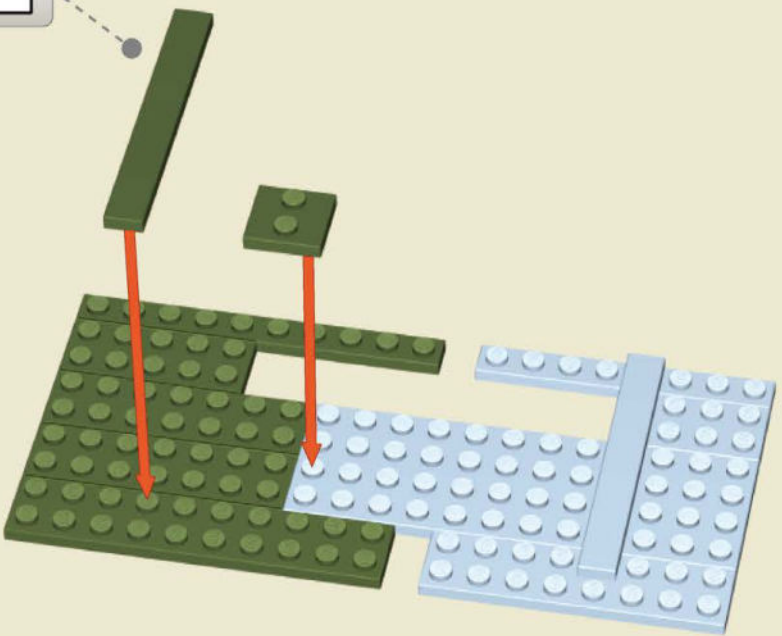
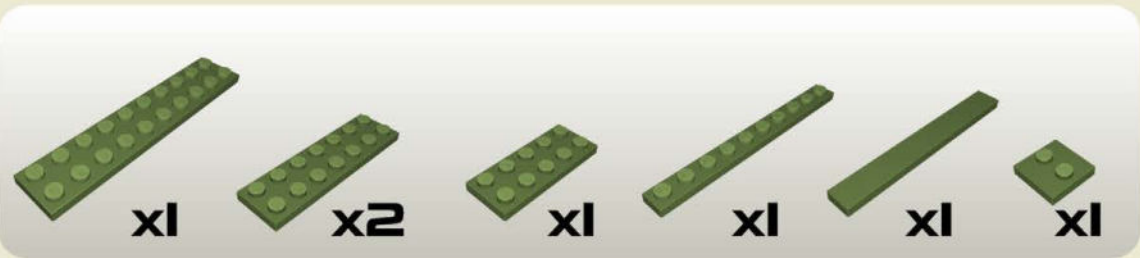

55

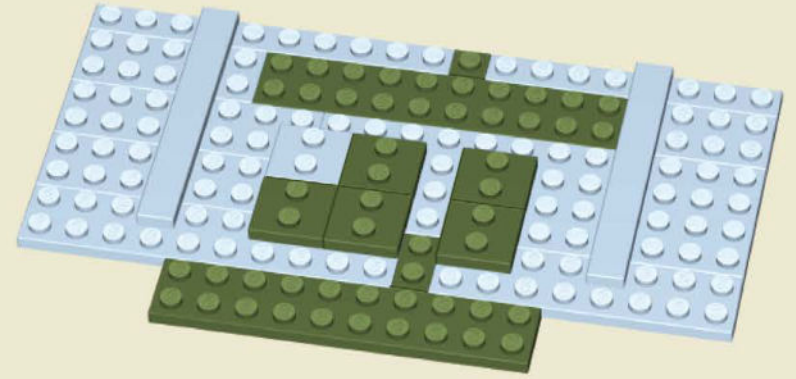
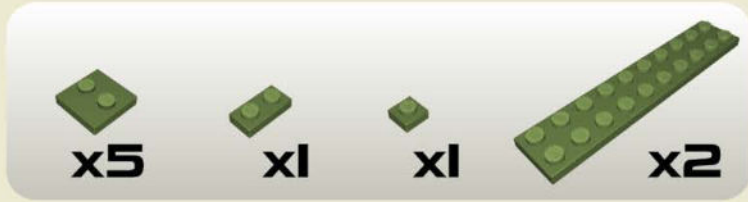

56

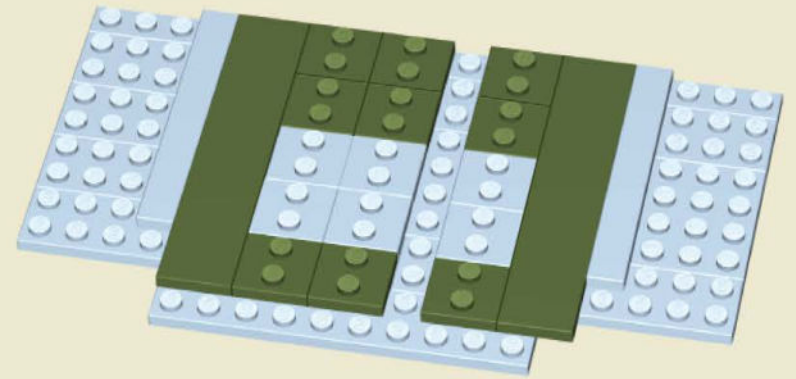
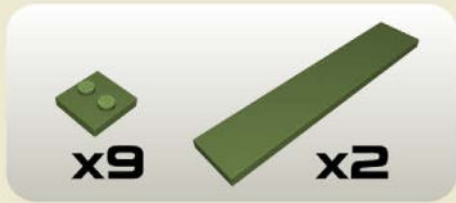

57

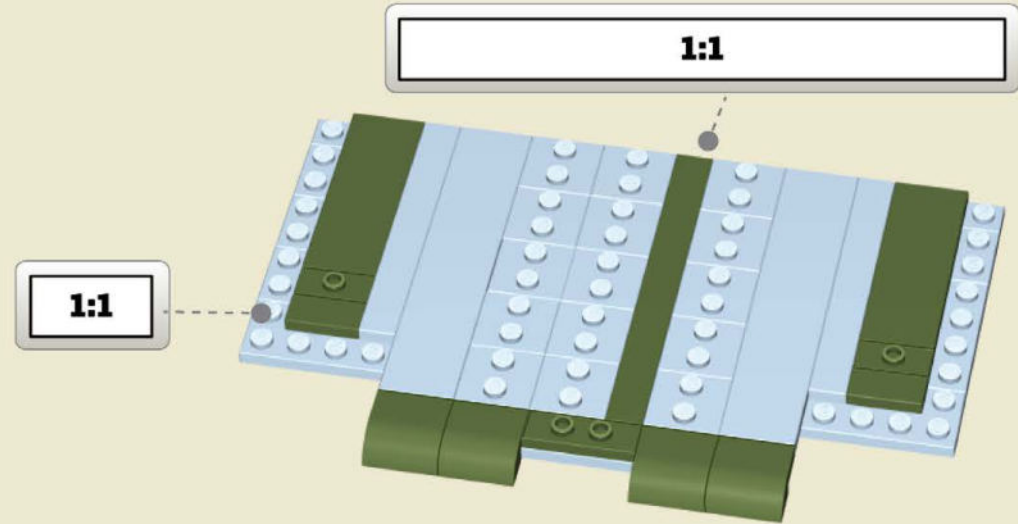

58

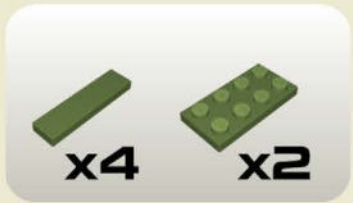

1:1

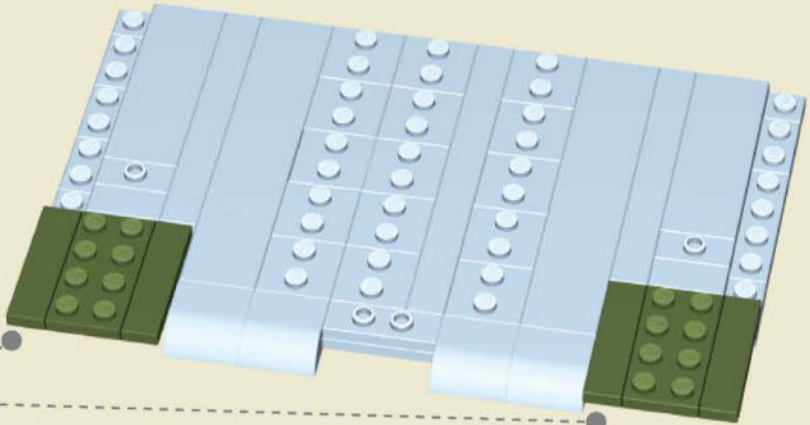

59

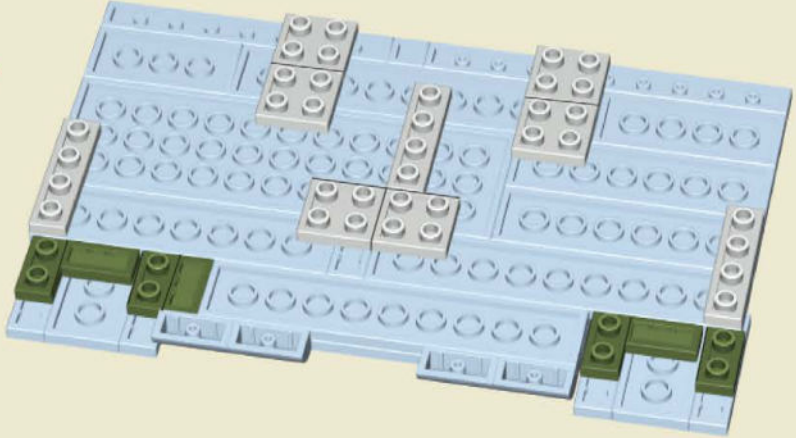

60

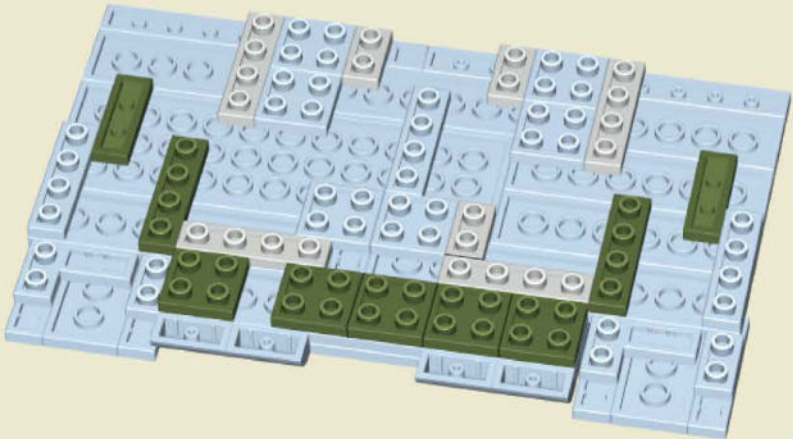
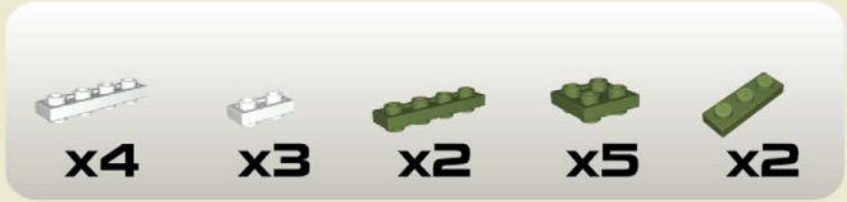

61

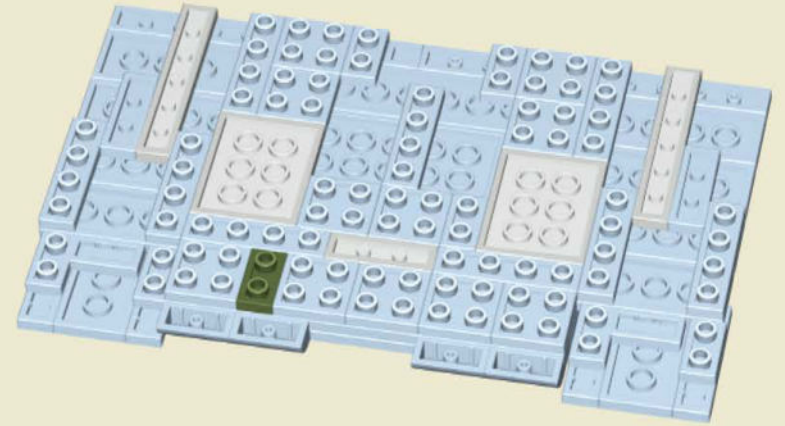

62

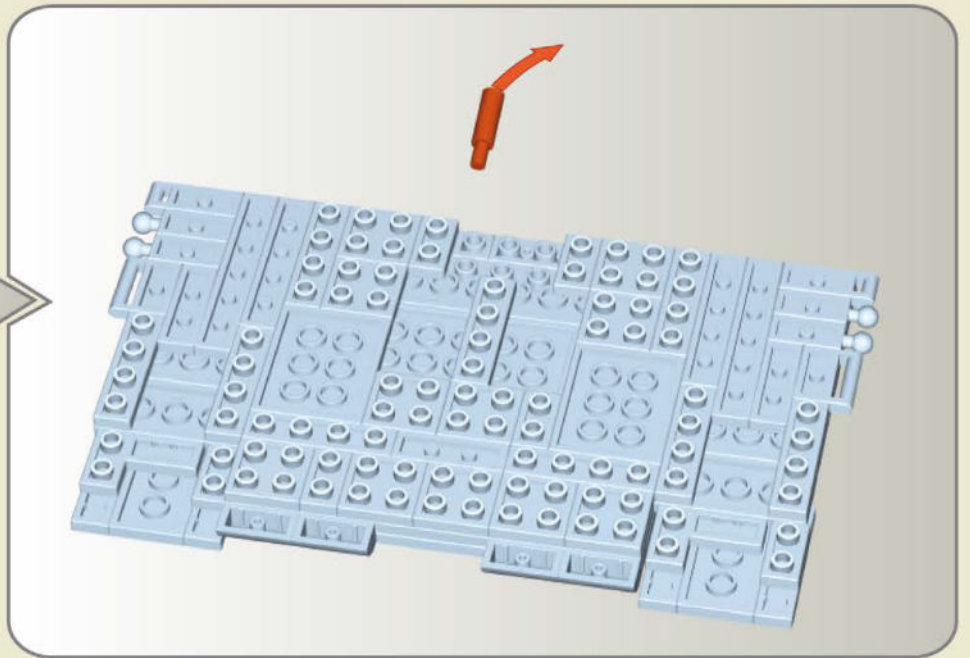
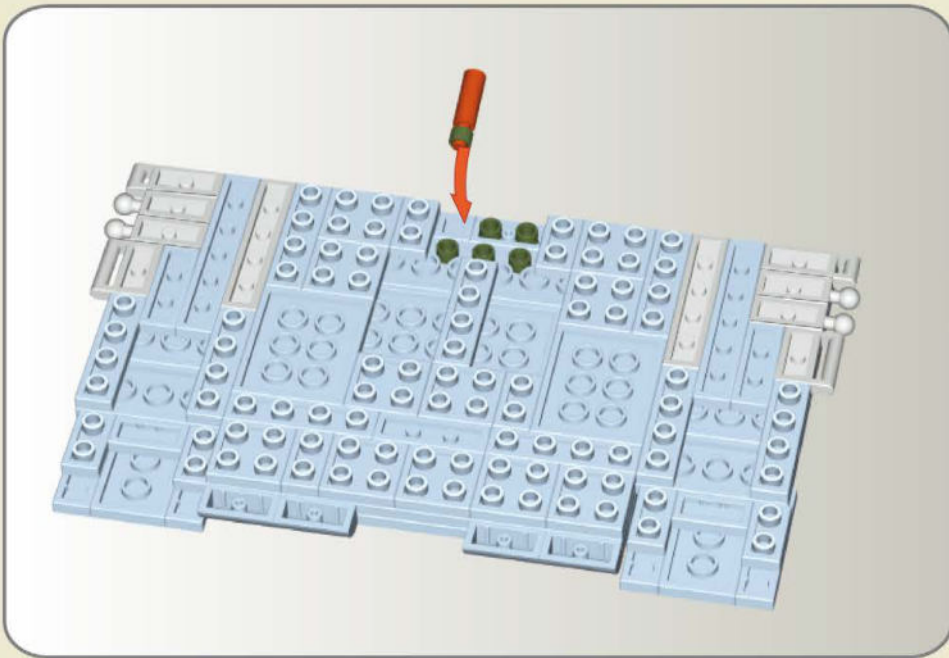

63

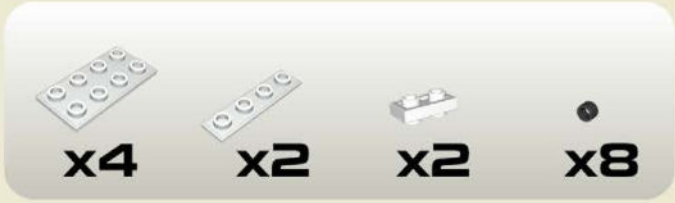
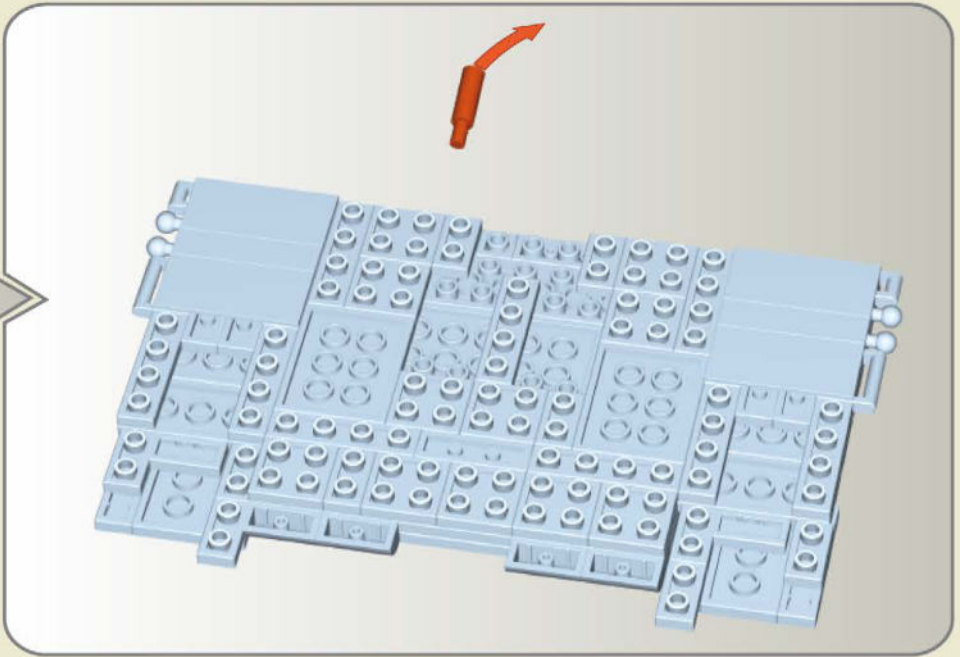
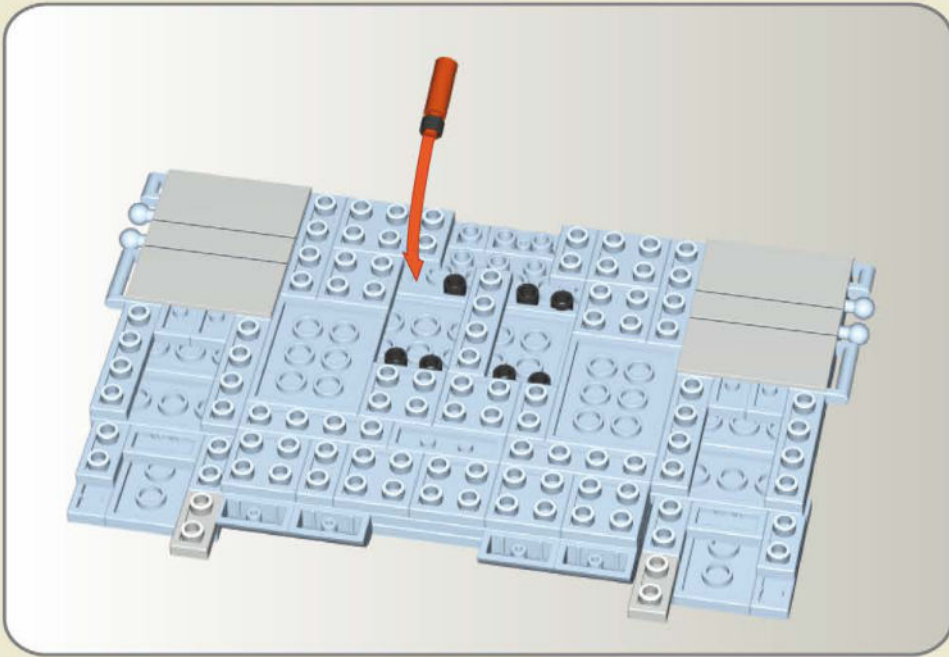

64

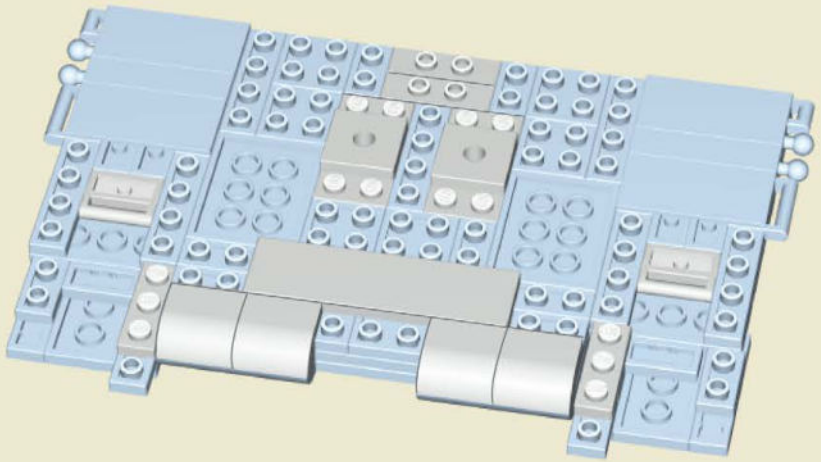



65

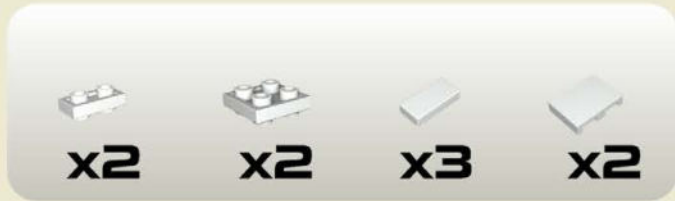
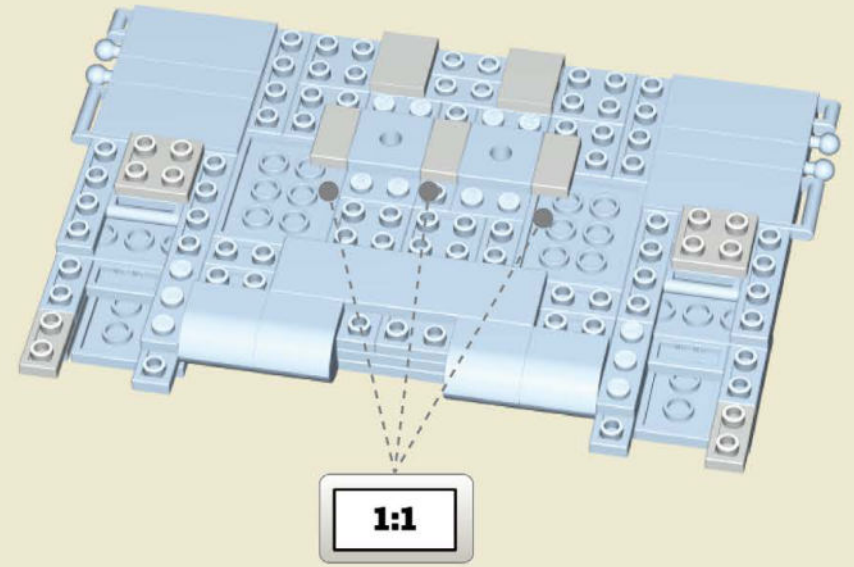

66

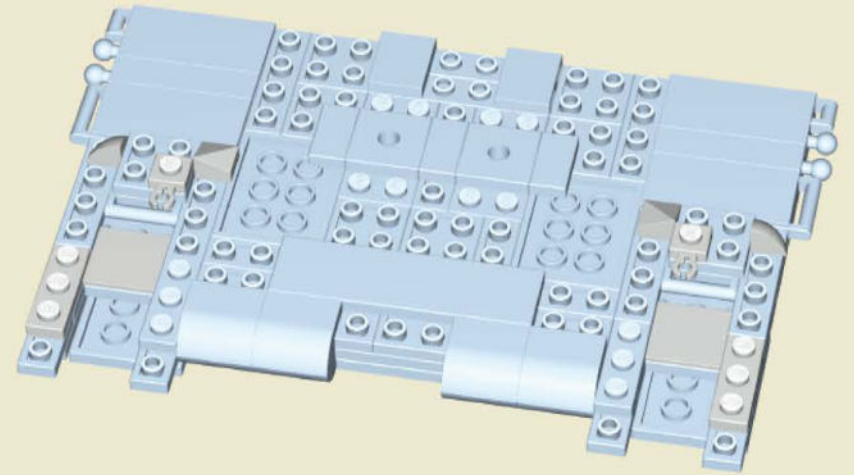

67

1:1

1:1

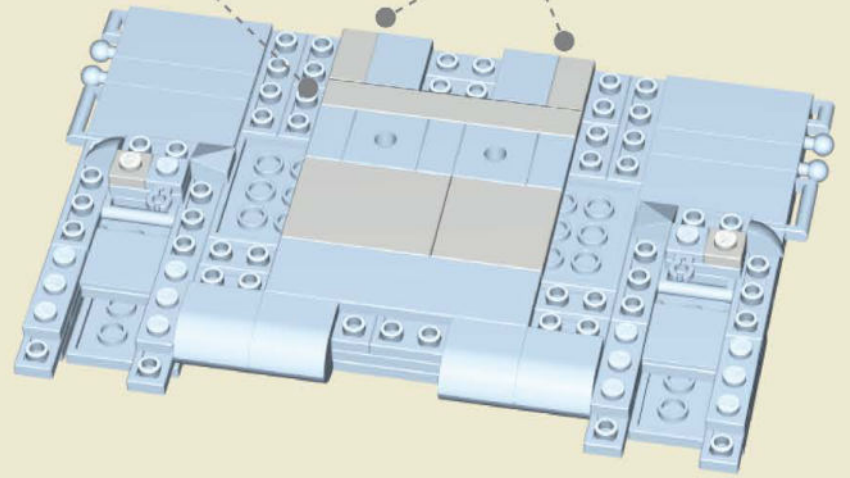

68

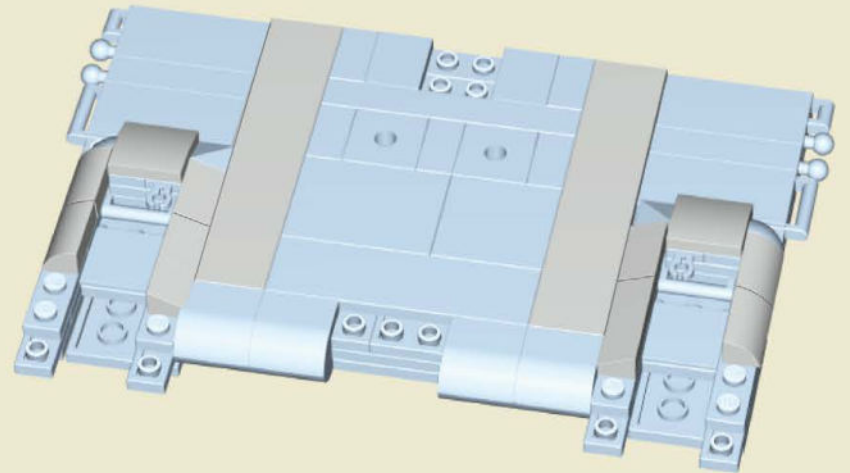

69

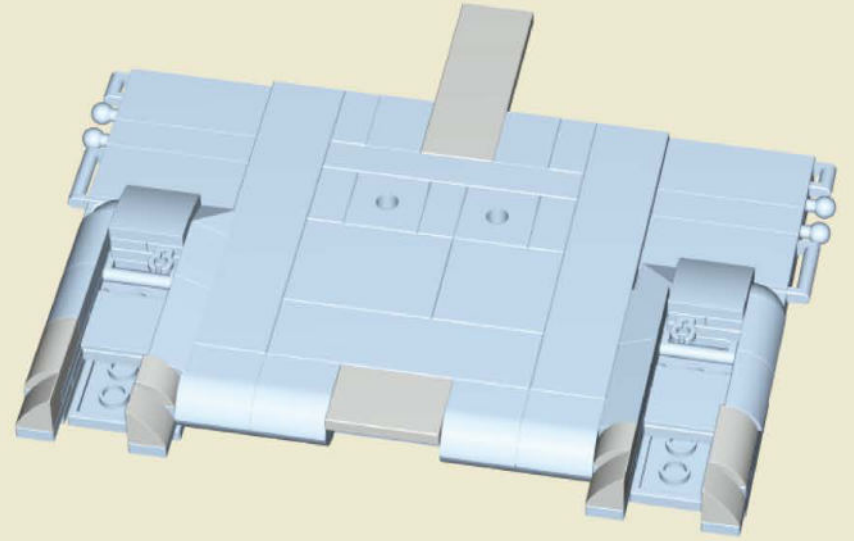

70

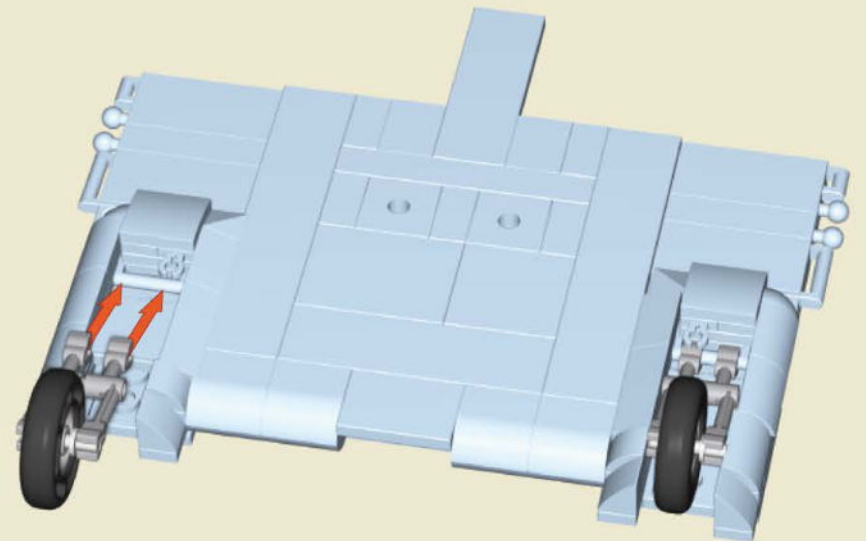
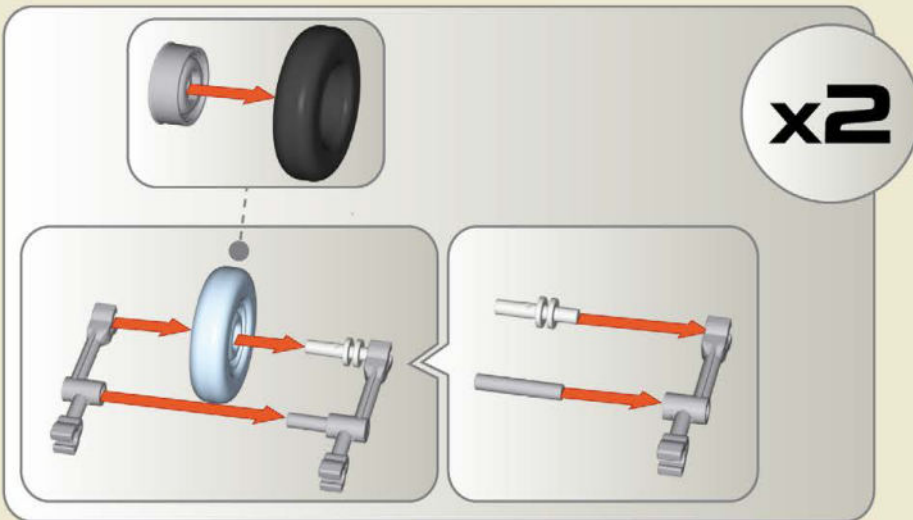

71

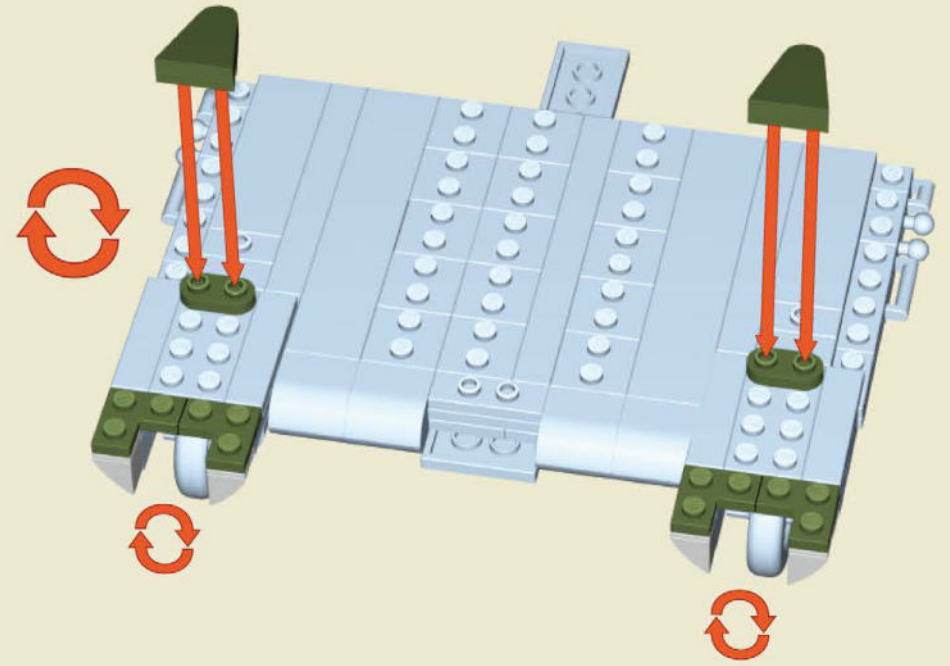
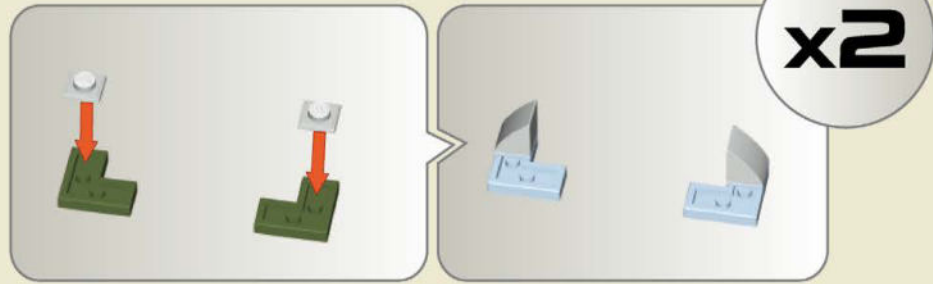

72

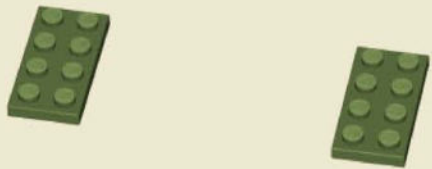

73

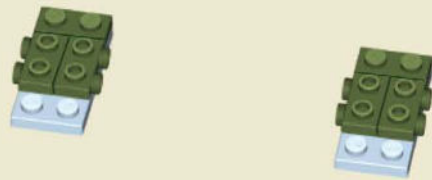

74

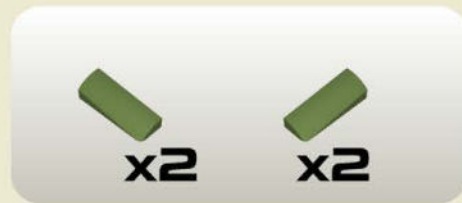

75

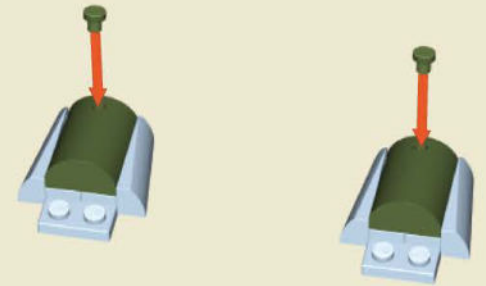

76

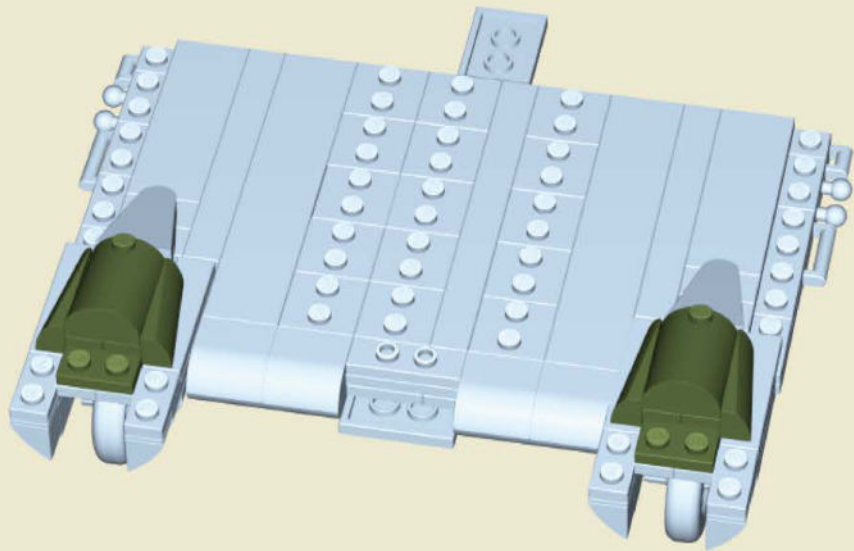

77

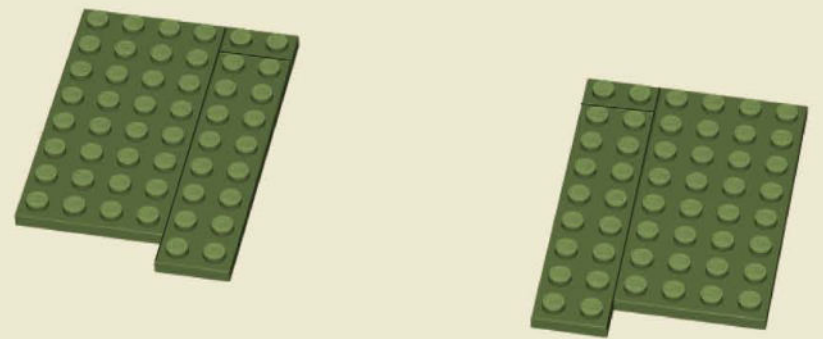

78

1:1

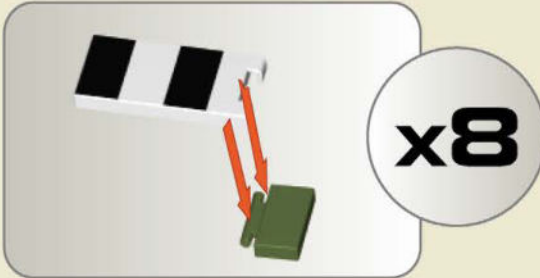
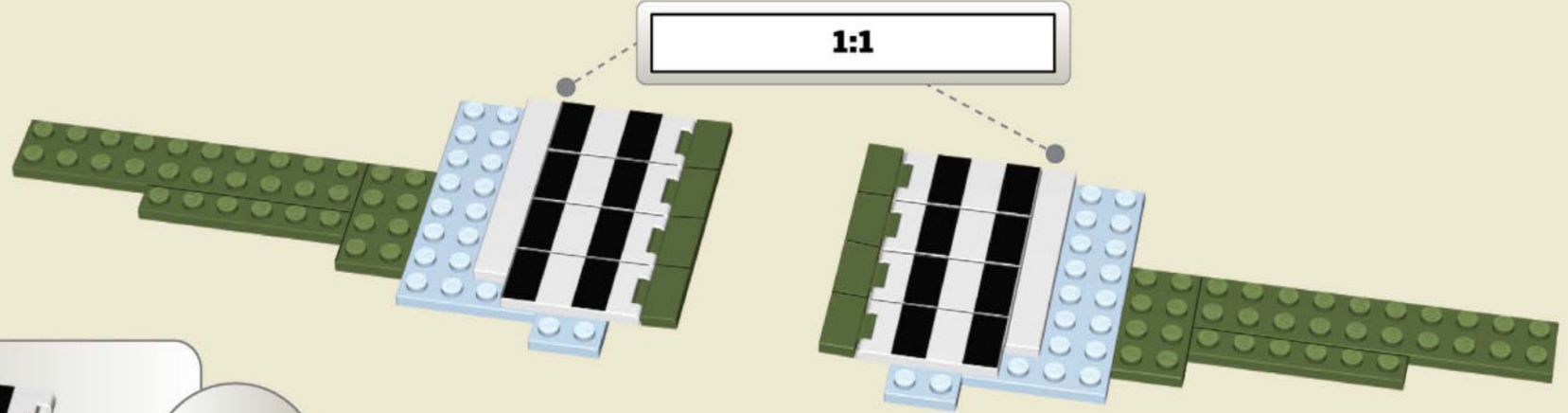

x8



79

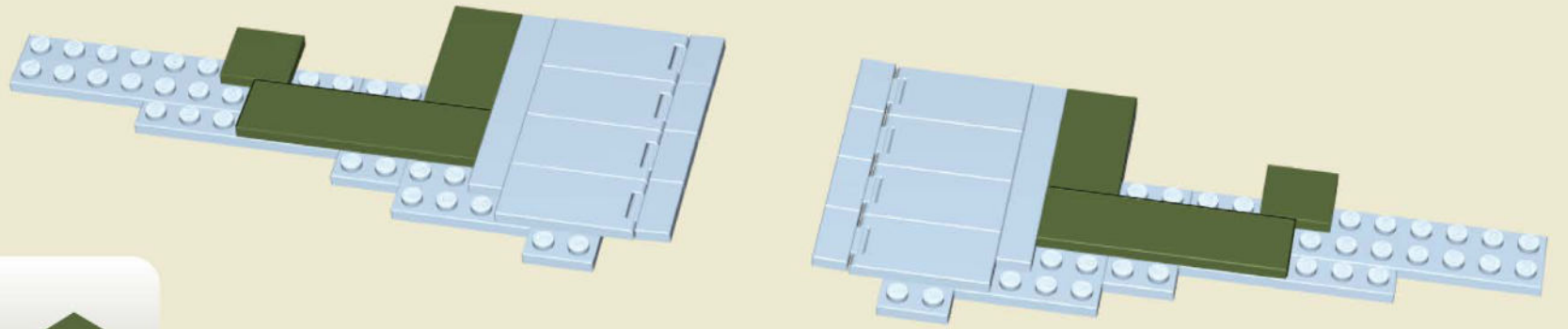

80

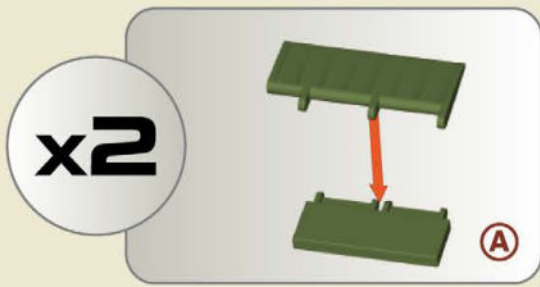

x2

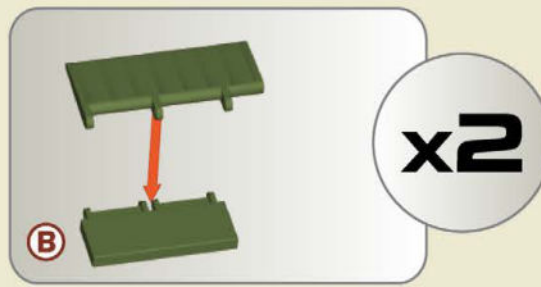

x2

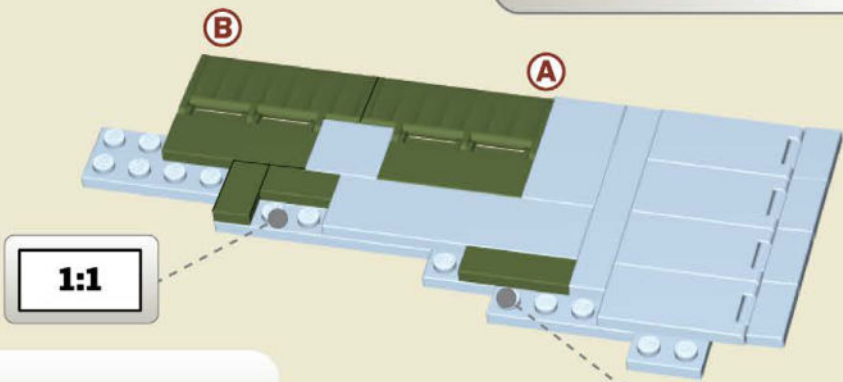

1:1

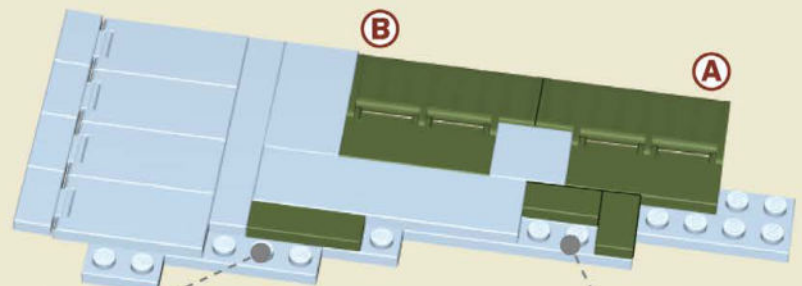

1:1

1:1



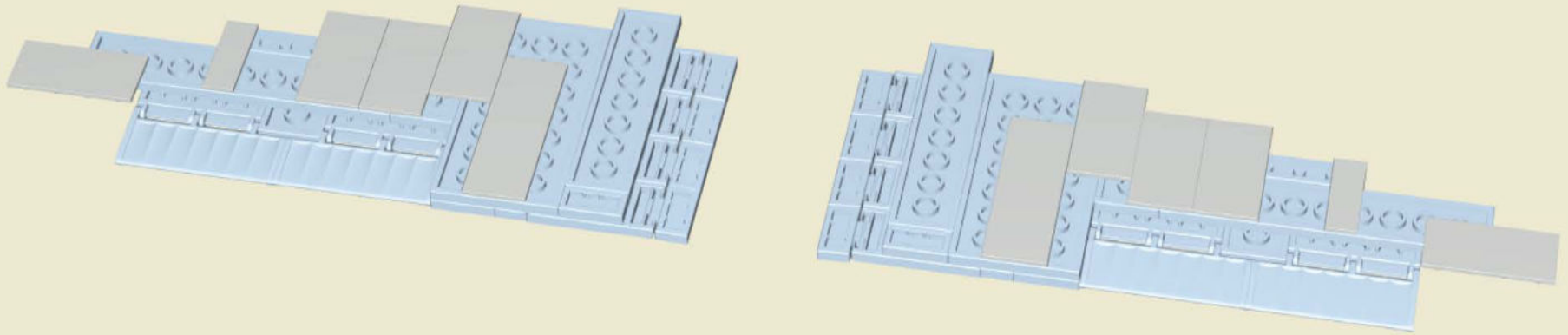

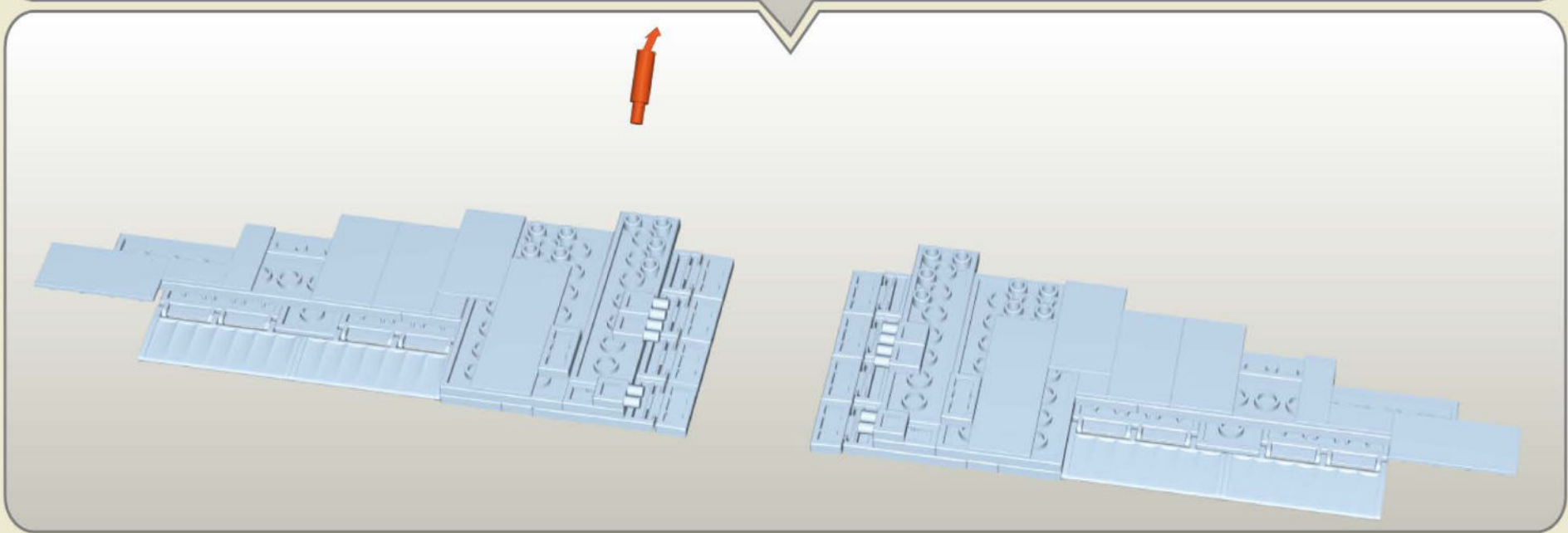
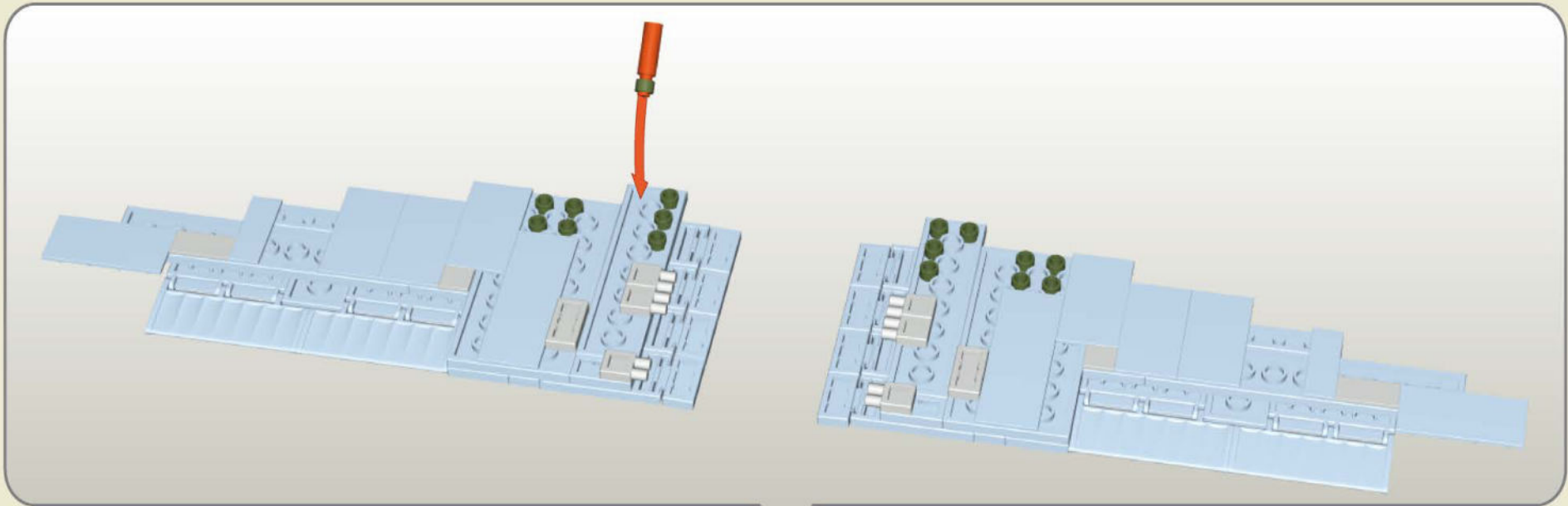

-  x2
-  x2
-  x2
-  x6
-  x16



83

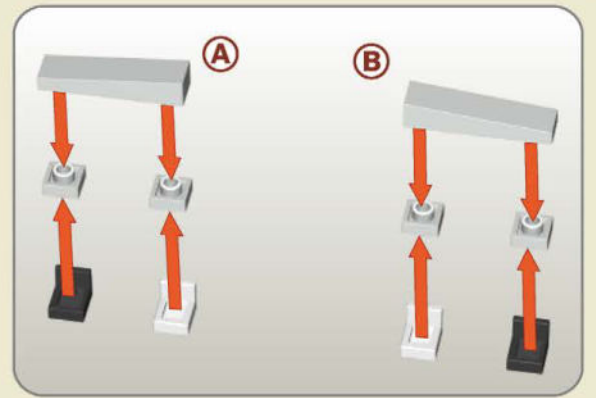
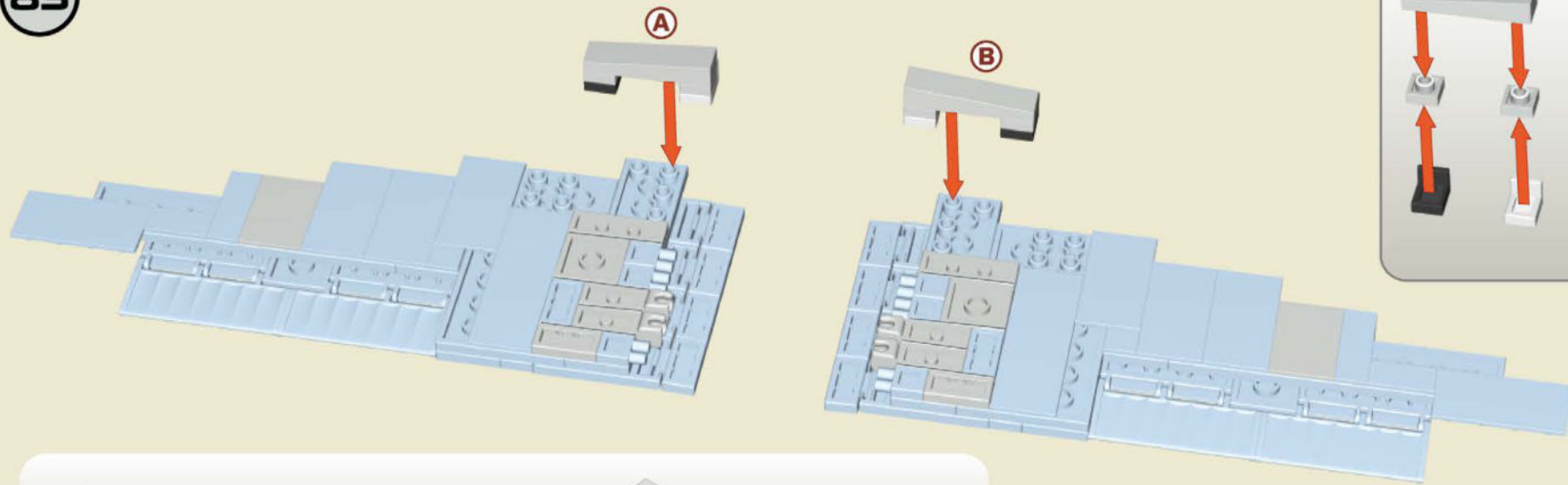

84

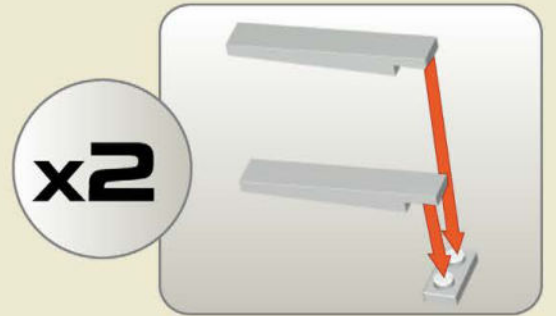
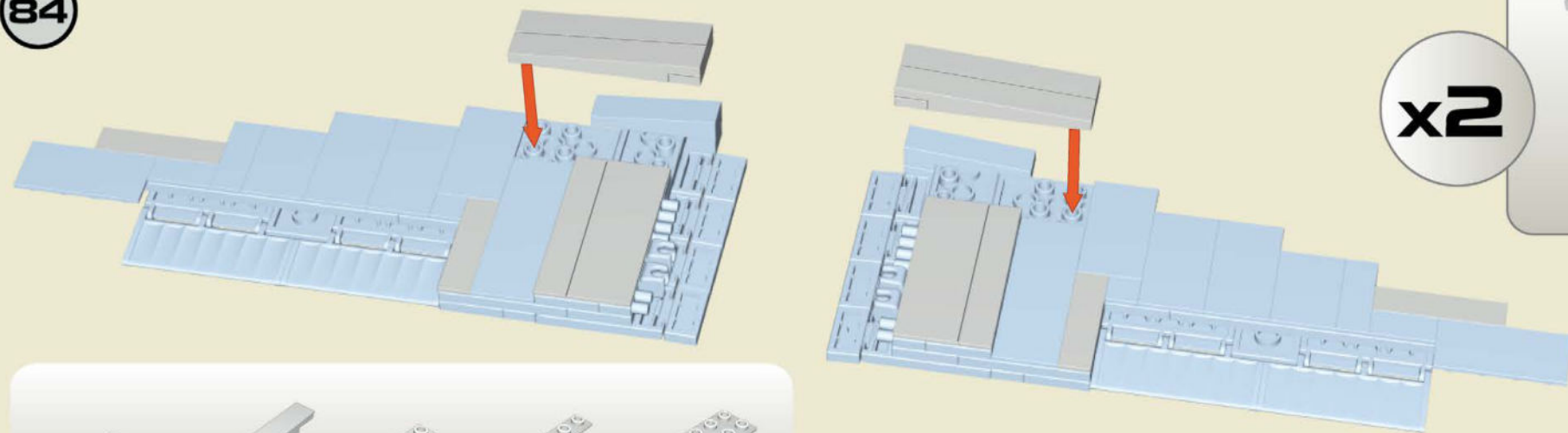

85

BE CAREFUL: NOTICE THE DIFFERENCE

A



B

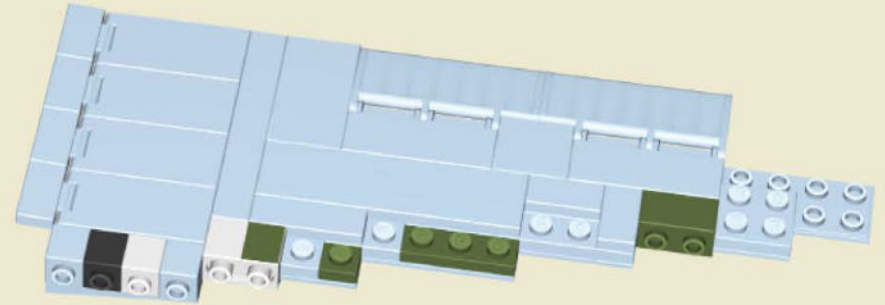

-  x2
-  x2
-  x2
-  x1
-  x1
-  x2
-  x2

86

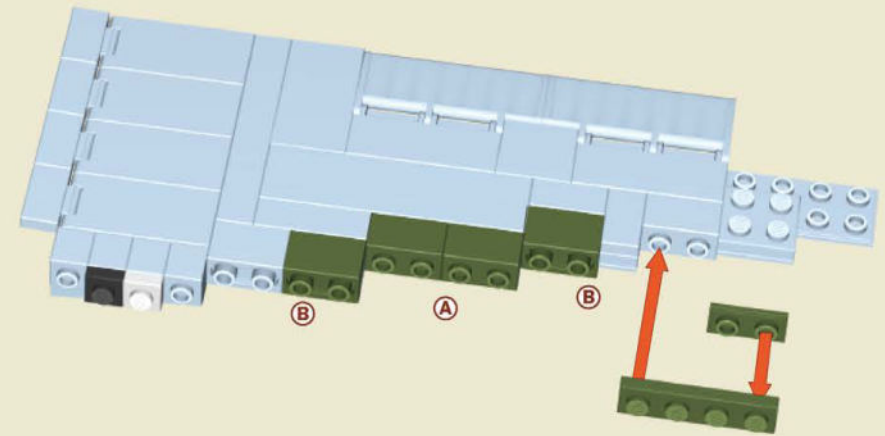
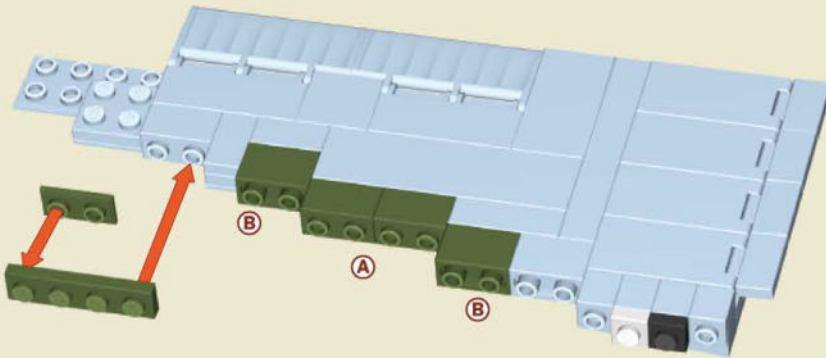

-  x4
-  x4
-  x2
-  x2
-  x2
-  x2

87

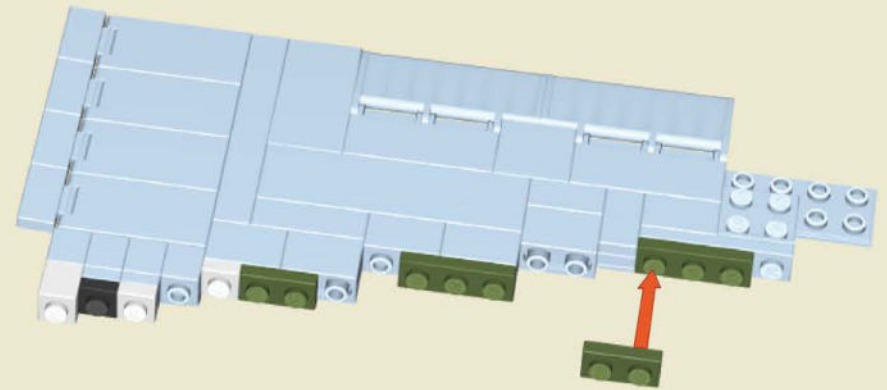

 x4  
  x4  
  x4  
  x2  
  x2

88

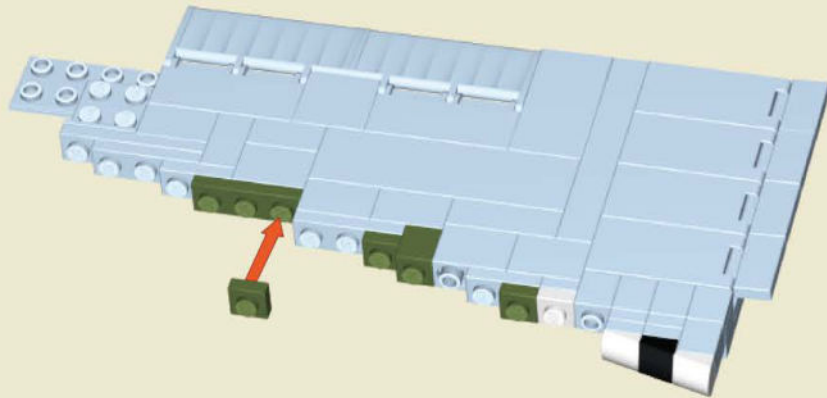

 x2  
  x6  
  x2  
  x2  
  x2

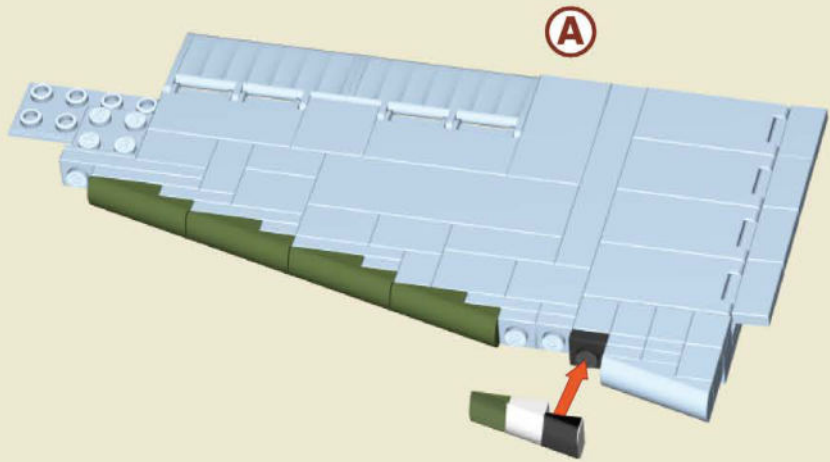

A

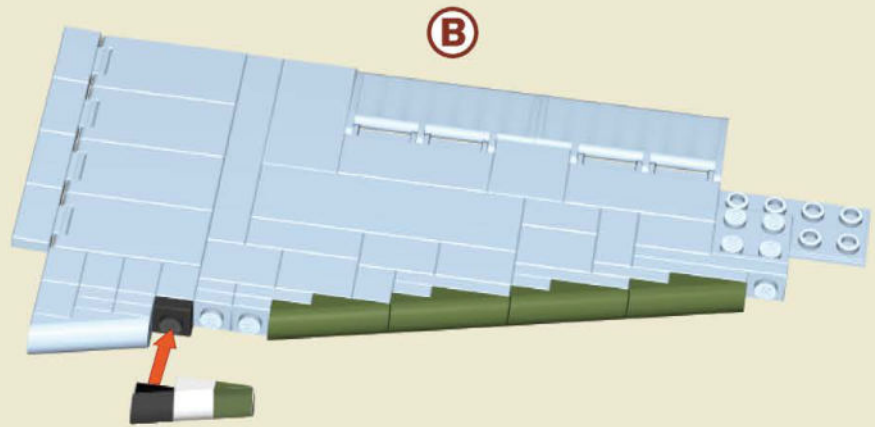

B

x2 x2 x8

The parts list at the bottom of the page includes three items: a black diamond-shaped Technic pin (x2), a black and white Technic pin (x2), and a green Technic axle (x8).

90

B

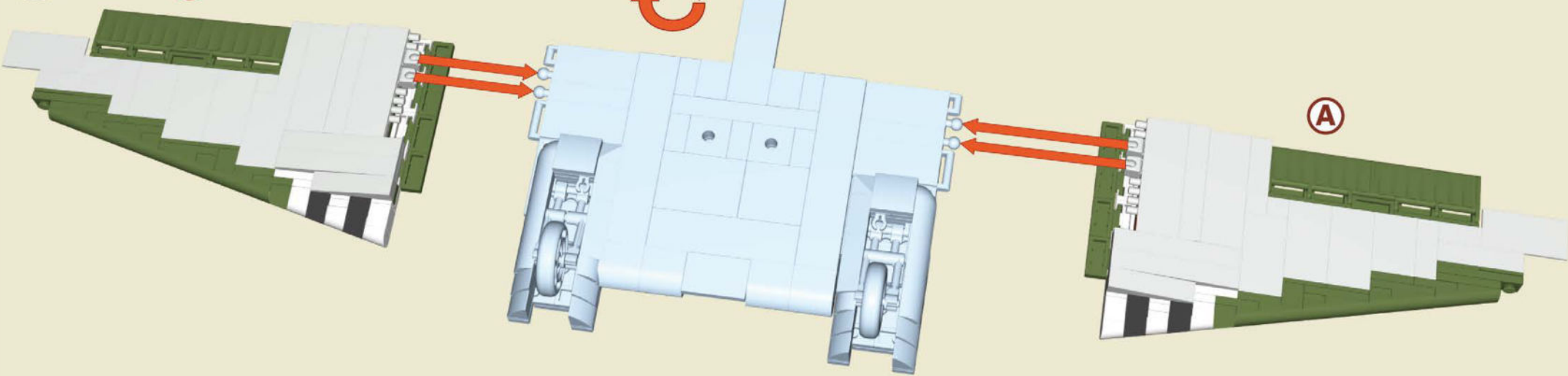

A

91

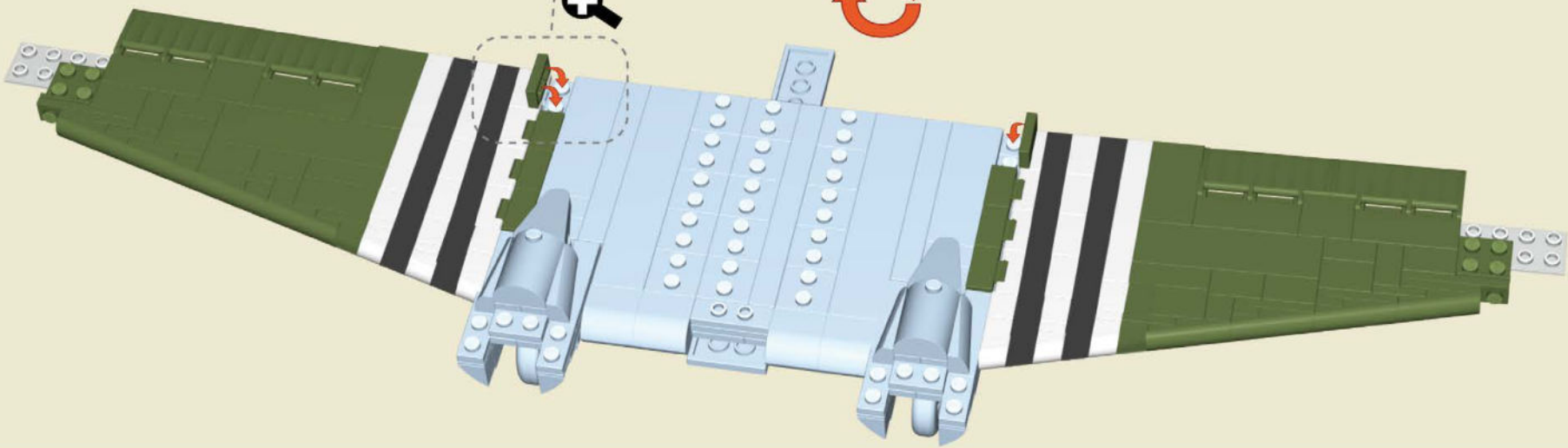
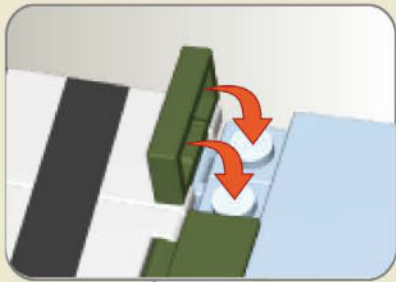

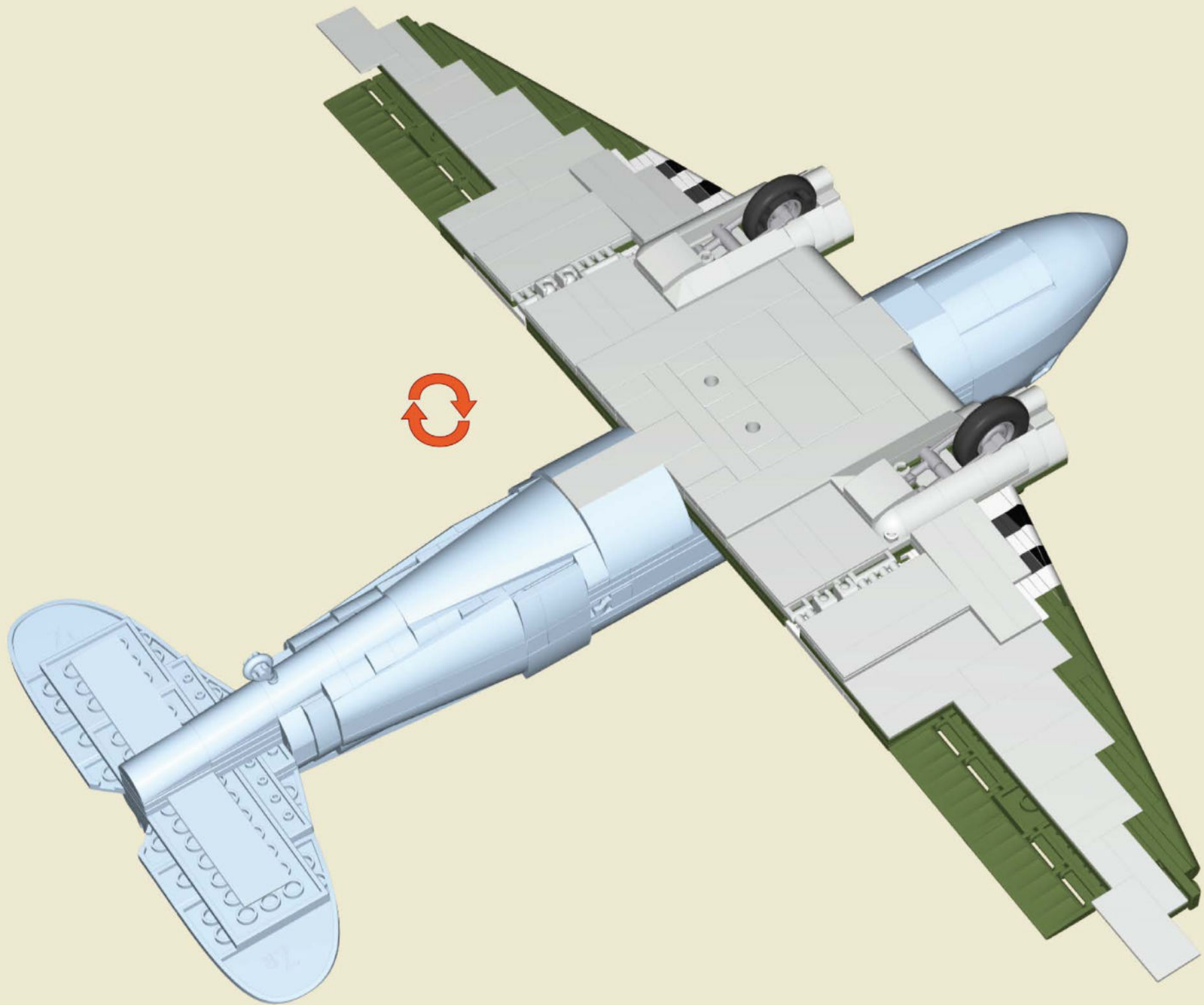



93



94

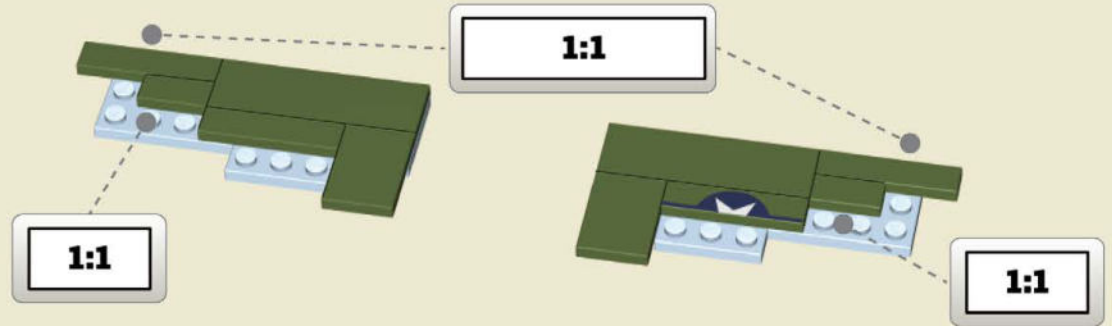

95

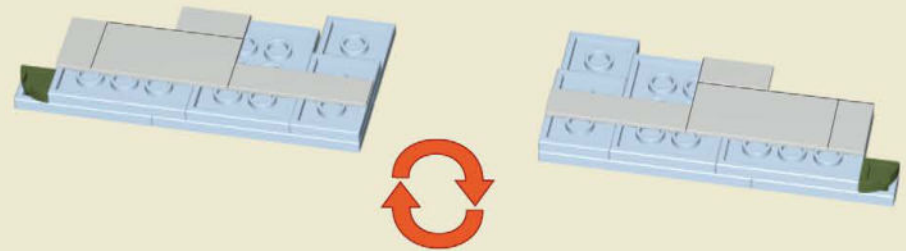
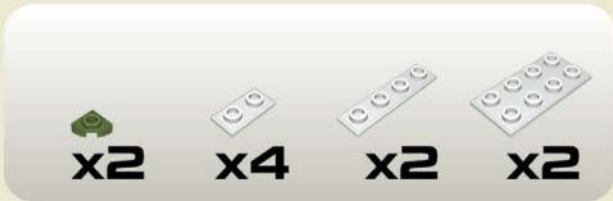

96

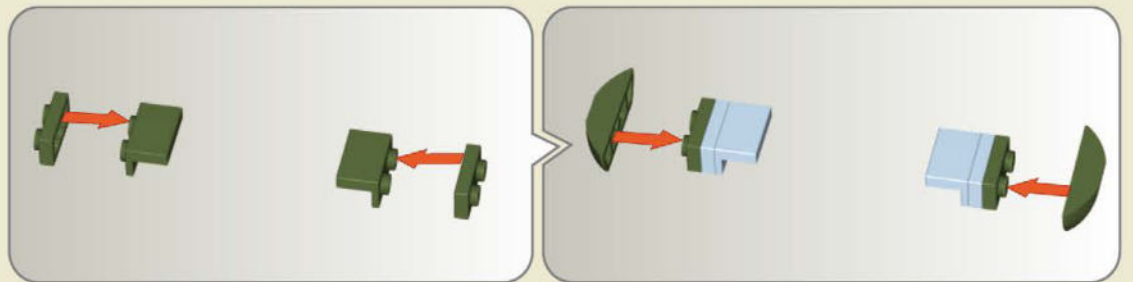
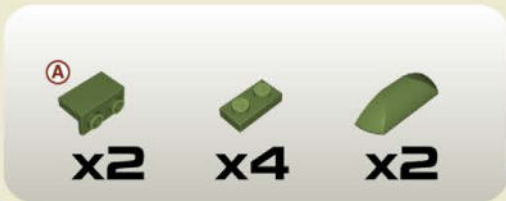

97

-  x2
-  x1
-  x1
-  x2

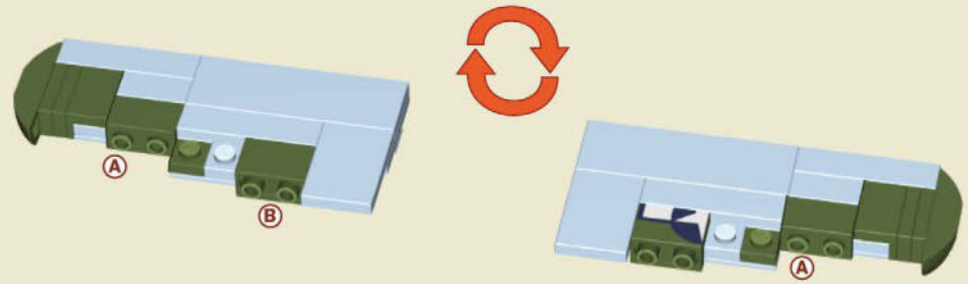

98

-  x2
-  x2
-  x2
-  x2

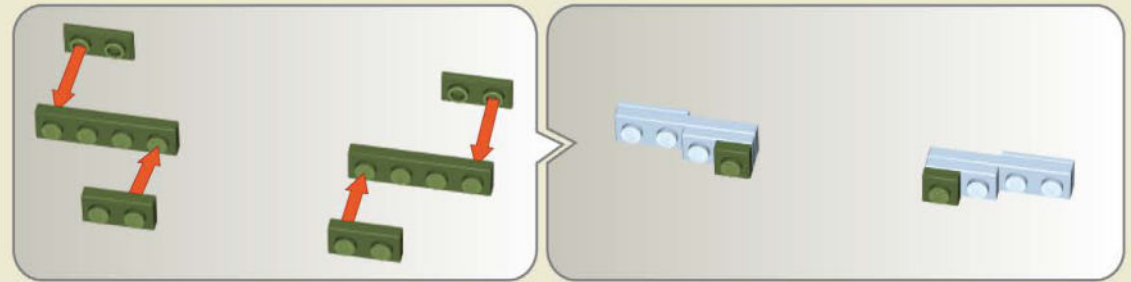

99

-  x2
-  x1
-  x1

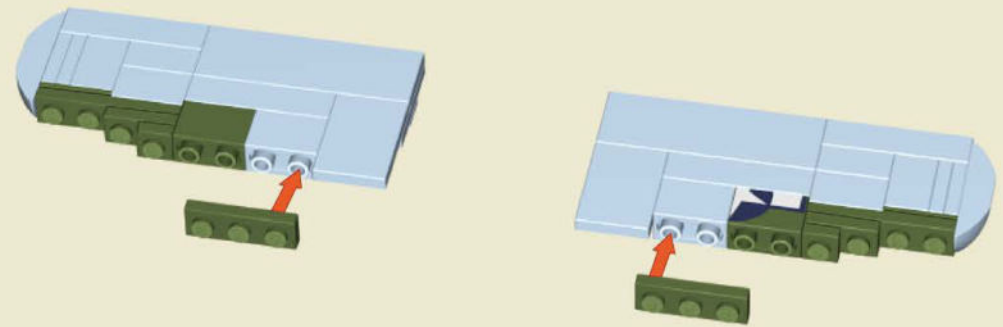

100

-  x2
-  x4





101

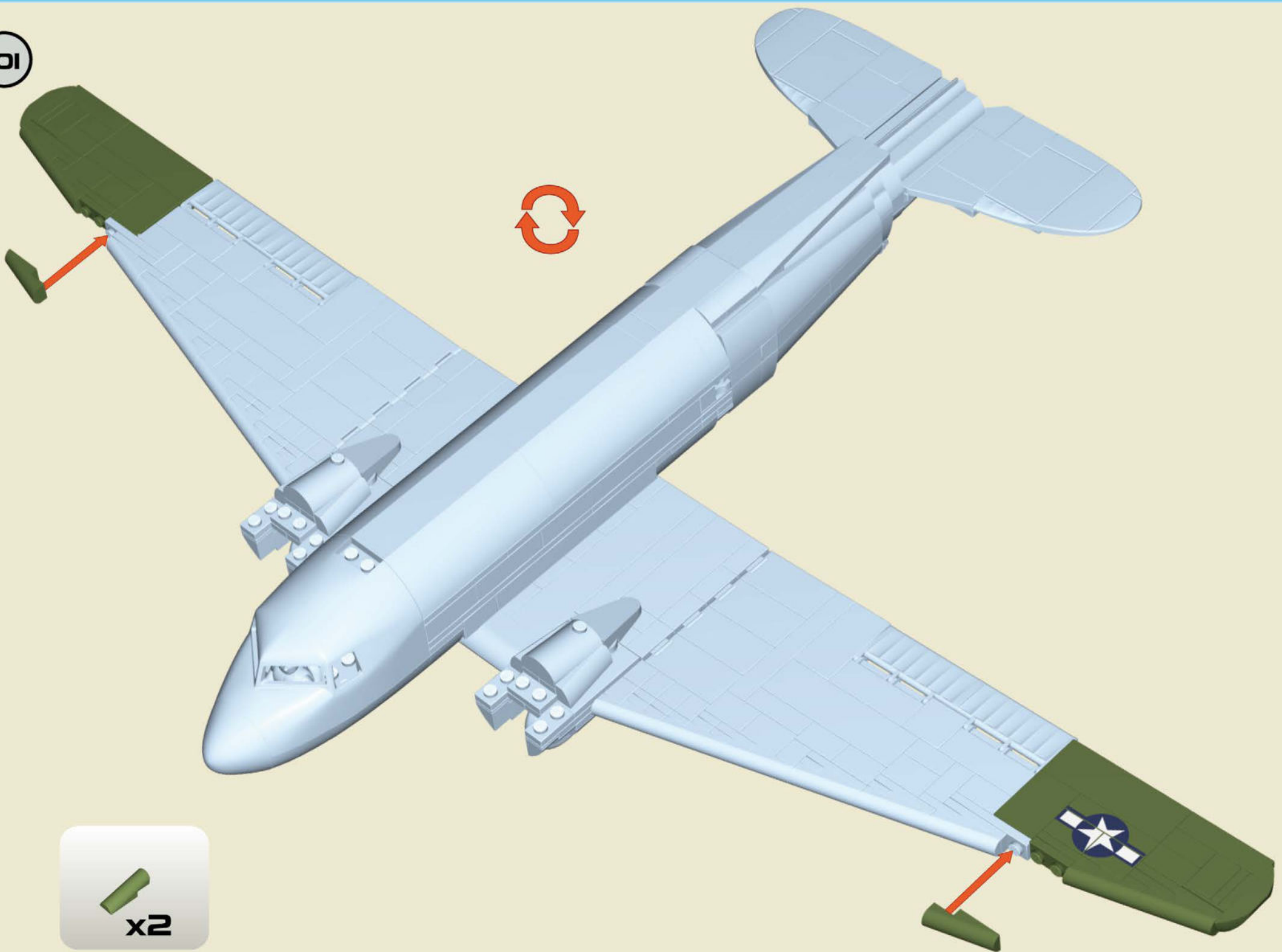

102

(102) = (108) x2

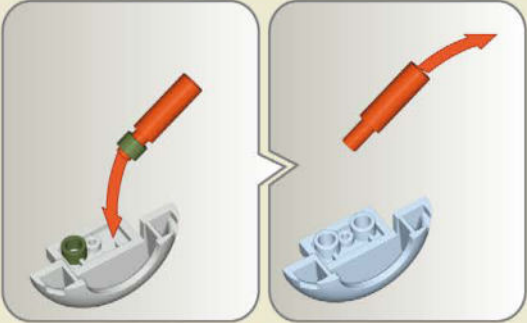

103

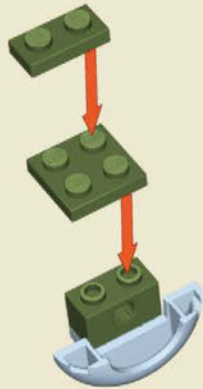

105

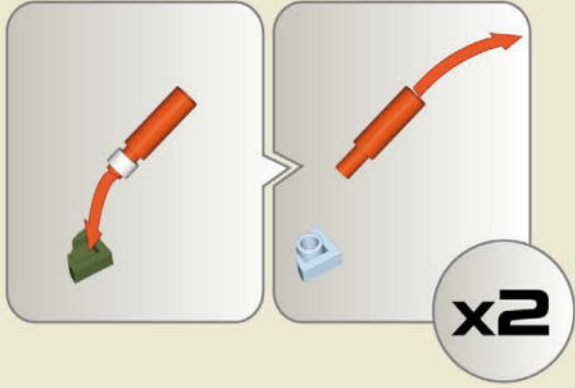

x2

104

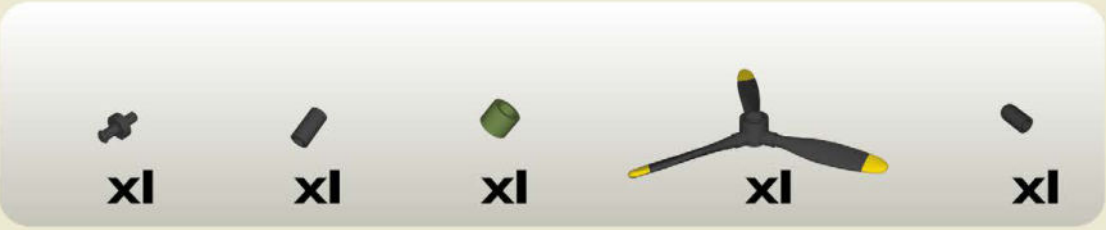
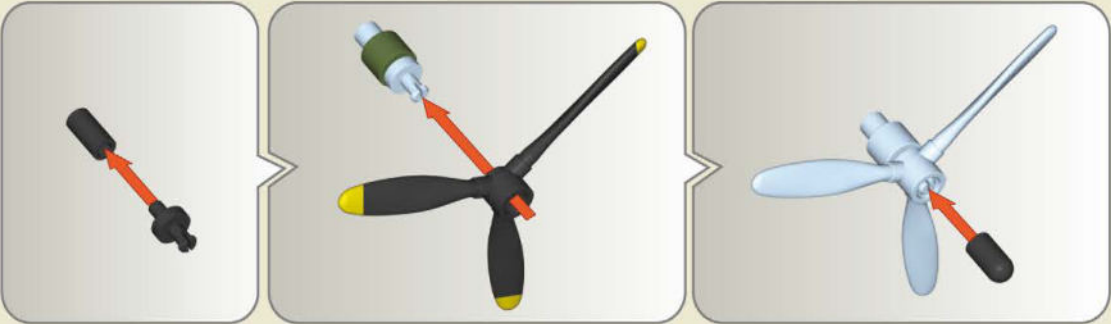

106

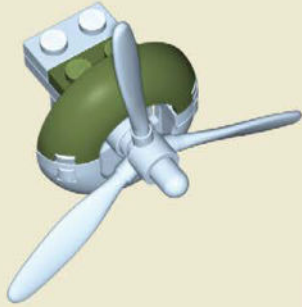

107

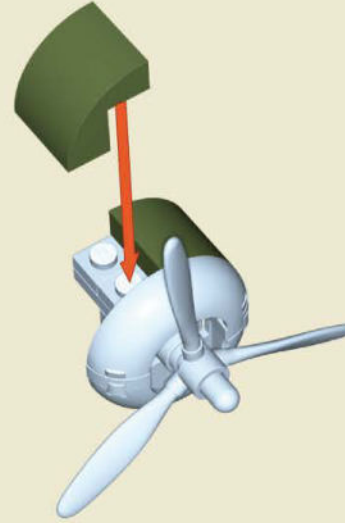

108

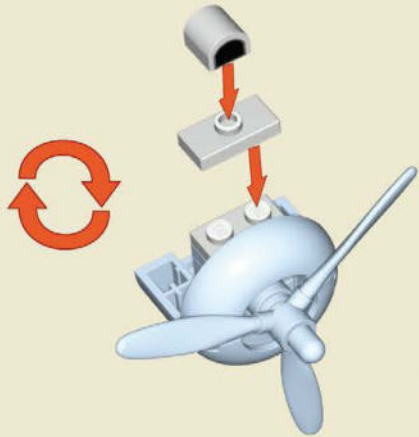

109

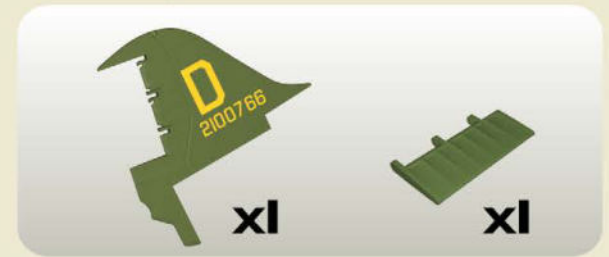
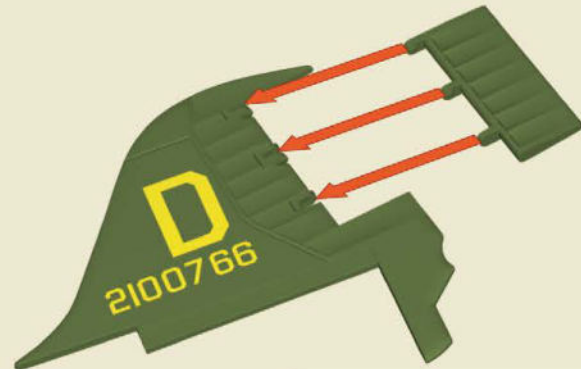

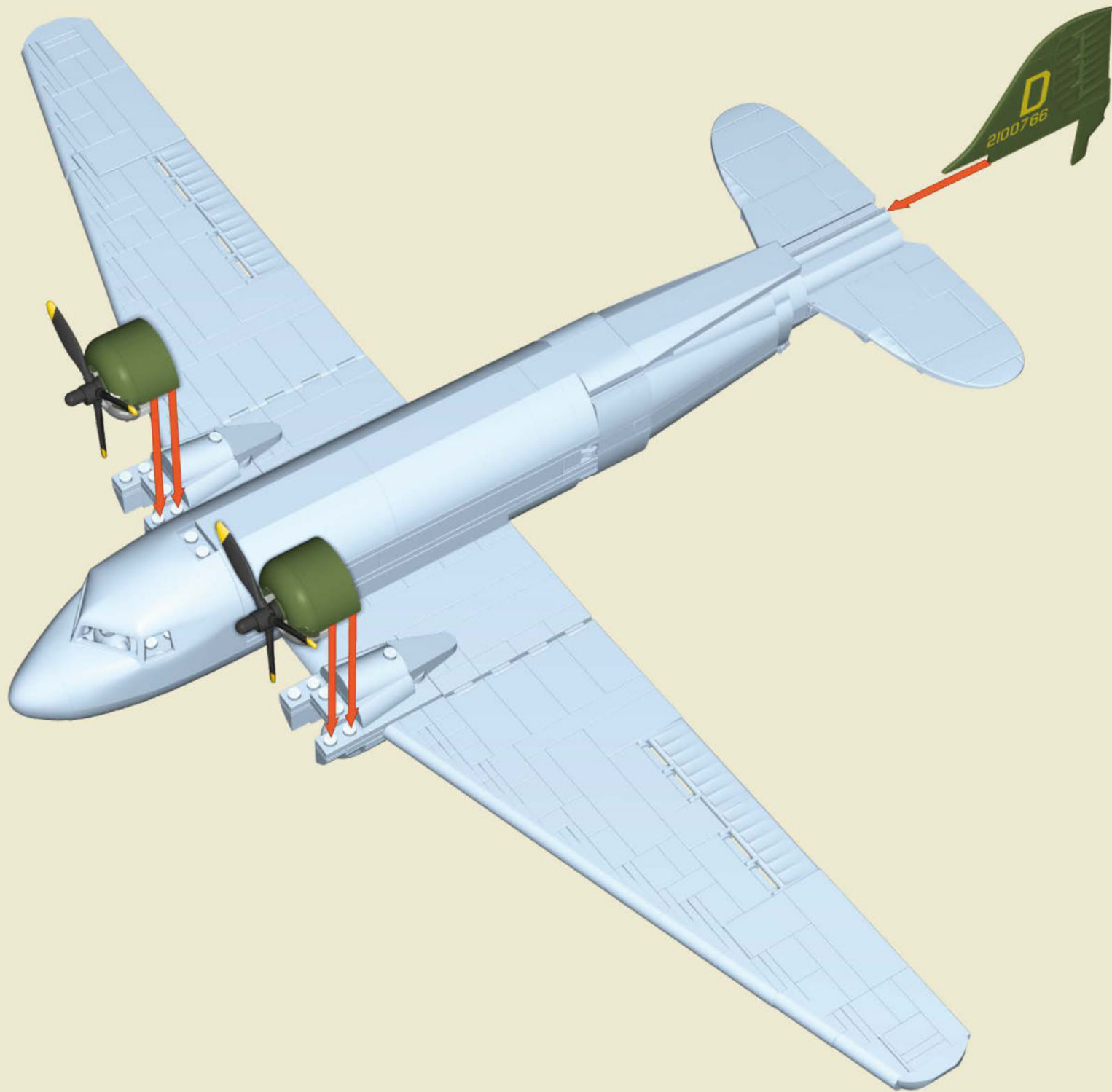



x1





x1



x2

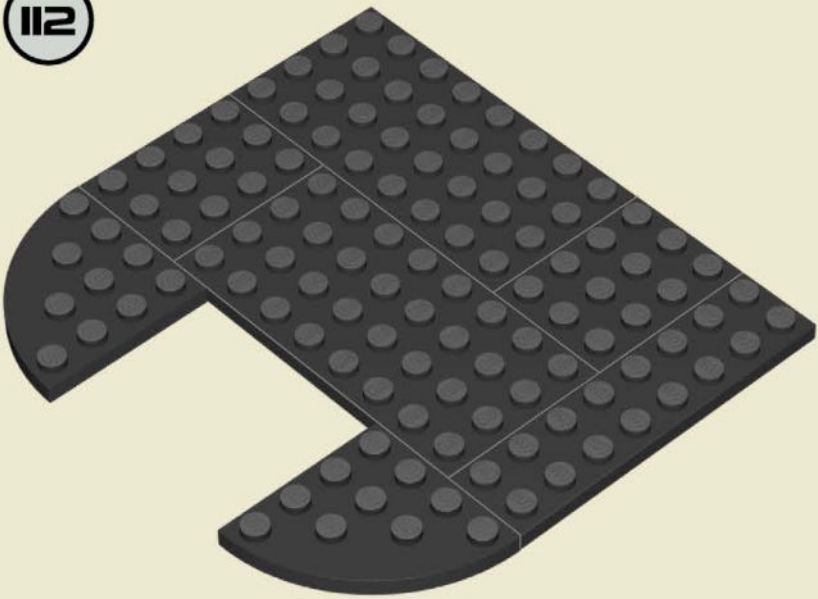





112

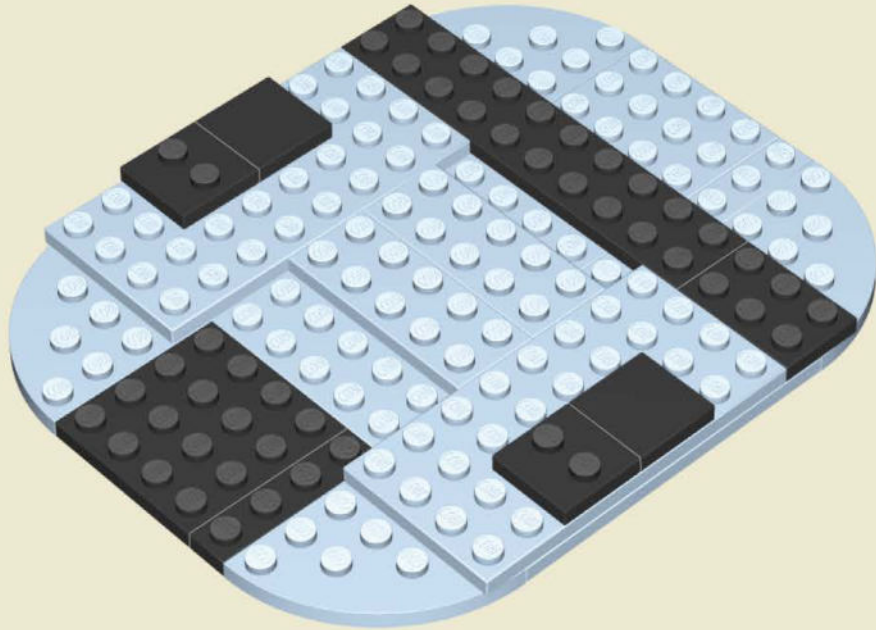

-  x2
-  x2
-  x1
-  x2

114



-  x1
-  x1
-  x2
-  x2
-  x1
-  x1

113

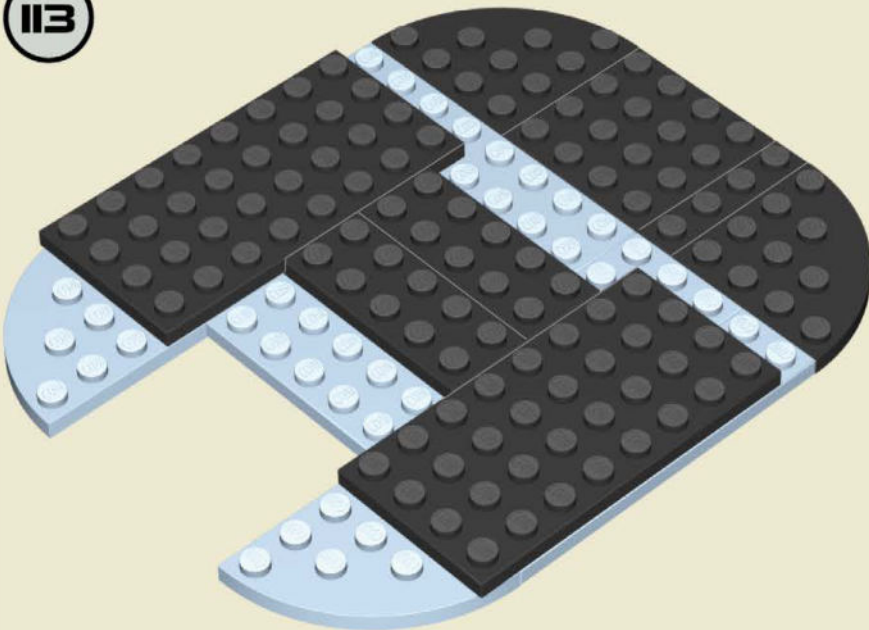



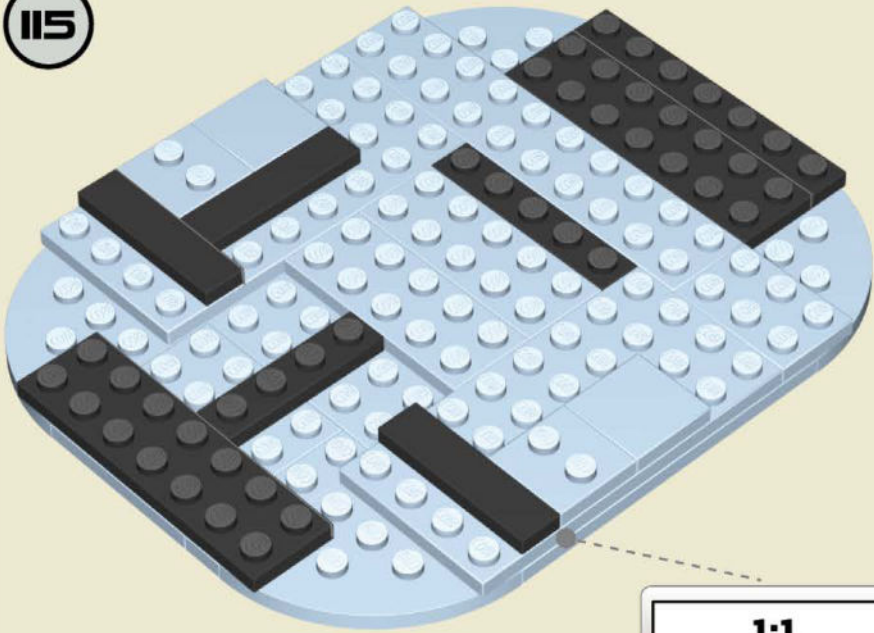

-  x2
-  x2
-  x2
-  x1
-  x1

115



1:1

-  x2
-  x1
-  x3
-  x1
-  x1

117

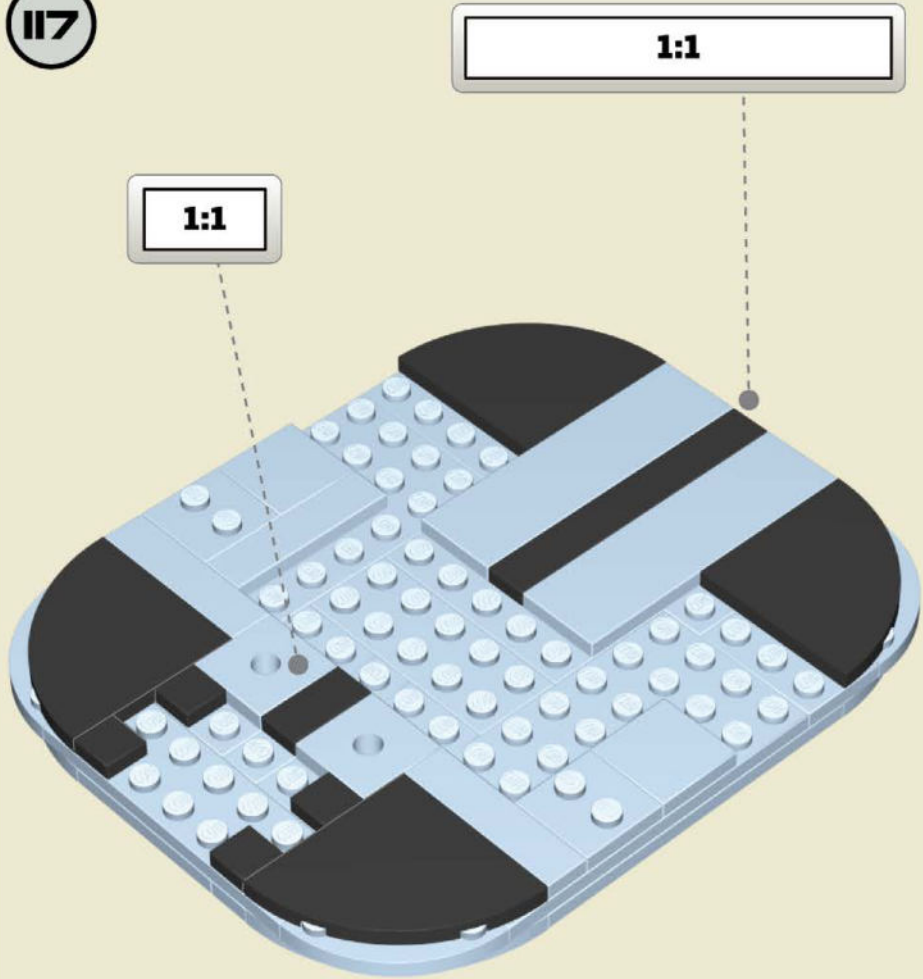



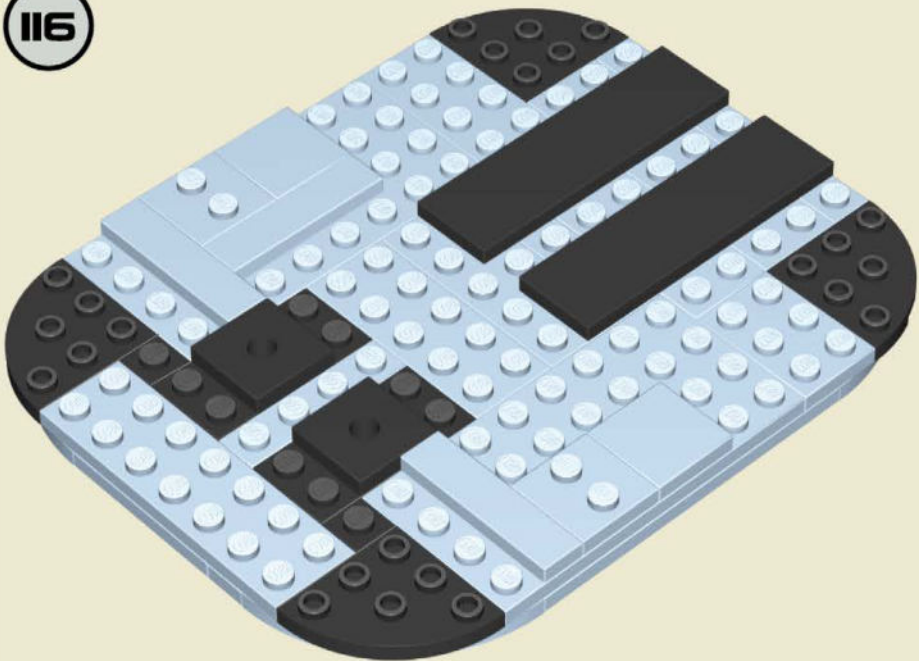

1:1

1:1

116



-  x4
-  x2
-  x2
-  x2

-  x4
-  x1
-  x1
-  x4

118

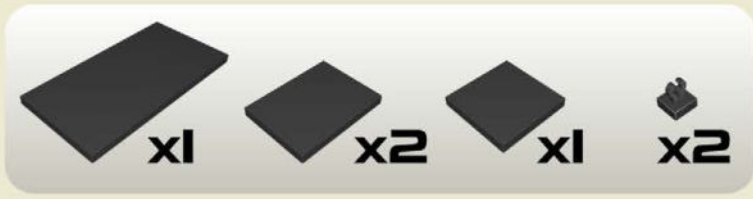
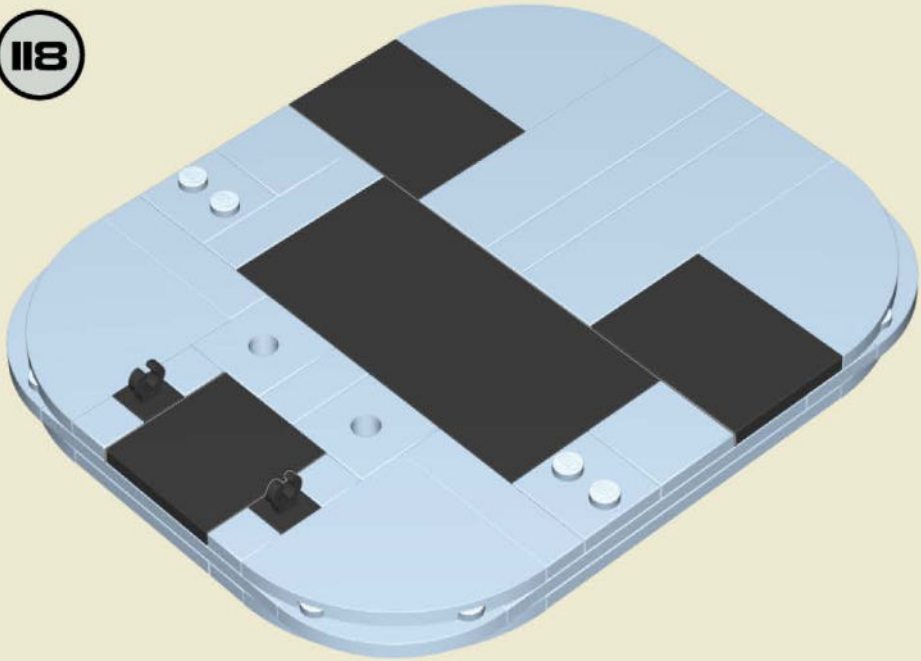

119

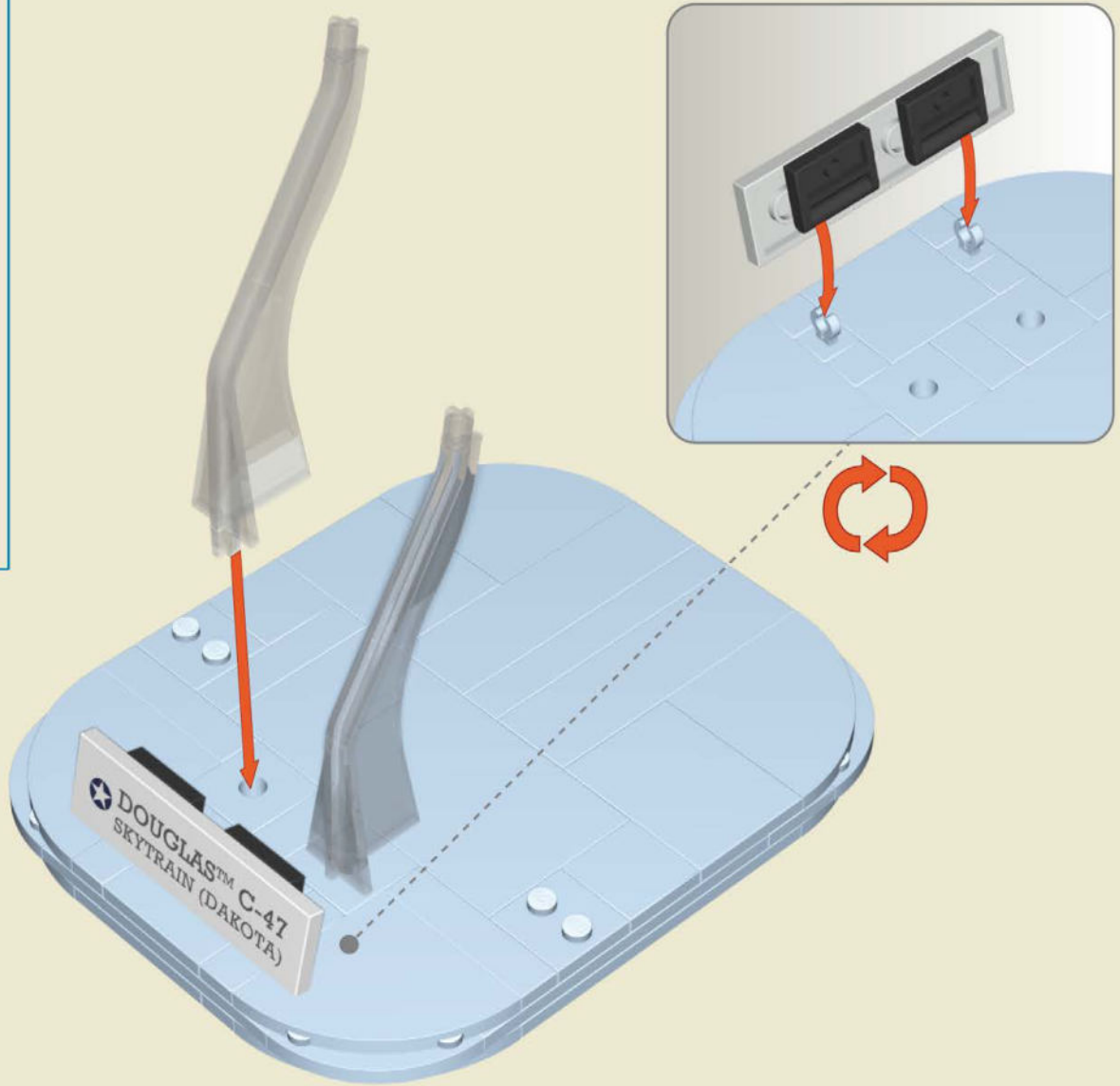
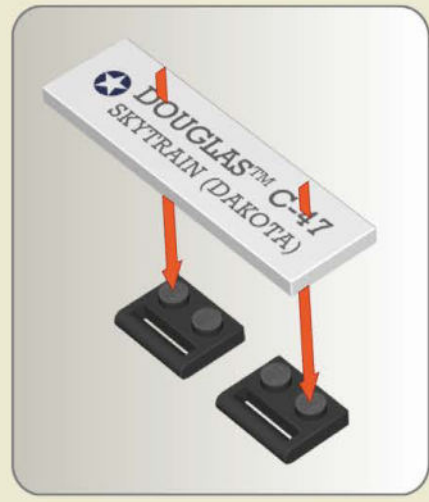



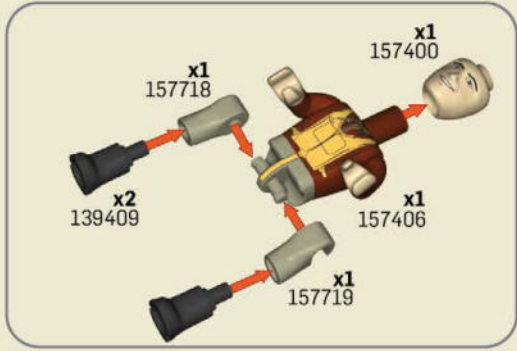
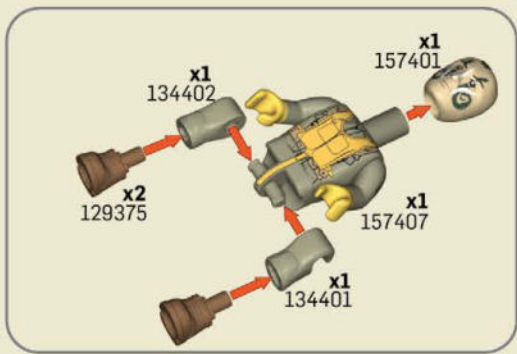

- |  |  |  |
|--|--|--|
|  x4<br>153755   |  x2<br>138083   |  x4<br>141421   |
|  x2<br>157709   |  x4<br>110093   |  x4<br>122319   |
|  x8<br>44012  |  x8<br>43969  |  x23<br>44014 |
|  x2<br>92879  |  x6<br>157710 |  x1<br>86093  |
|  x4<br>114598 |  x6<br>134796 |  x4<br>93346  |
|  x1<br>132985 |  x1<br>105092 |  x4<br>150741 |
|  x1<br>81752  |  x1<br>122286 |  x1<br>110280 |

x4 150114	x2 105094	x2 42878	x6 42880	x7 42882	x2 150425	x1 151431	x2 44969	x2 157711	x2 42859	x3 42863	x2 157610	x2 111576
x2 72799	x2 104859	x2 138722	x2 157712	x8 157713	x2 134797	x2 134797	x3 128527	x4 138721	x28 42931	x12 92647	x8 42913	x8 92649
x10 134976	x1 157612	x1 157613	x6 142143	x2 115866	x1 45158	x11 45540	x5 92882	x2 107342	x2 107604	x4 104428	x4 146280	x6 132329
x1 92369	x4 146290	x2 42952	x2 92881	x1 106342	x8 83632	x4 143521	x4 144247	x4 128968	x3 42895	x7 42905	x1 113534	x2 73246
x6 99036	x2 136052	x2 99325	x6 111481	x6 114622	x1 132618	x1 138718	x2 113942	x15 42959	x7 92652	x5 93457	x1 115502	x2 118292
x1 44877	x3 99234	x2 120910	x2 120907	x2 99330	x2 157622	x2 157625	x2 157626	x14 157720	x2 109733	x2 120912	x3 42974	x7 42976
x3 42985	x9 93279	x3 61577	x7 64202	x2 108698	x1 146277	x3 71717	x2 110415	x8 134795	x1 148707	x1 64212	x2 67985	x4 92887
x2 85566	x1 92896	x2 43017	x2 92654	x1 66613	x4 131770	x2 134794	x7 43084	x4 92658	x5 43092	x8 92662	x1 105815	x3 92435
x7 43100	x1 92884	x2 43112	x4 43114	x1 92891	x8 80920	x2 118379	x2 77542	x15 77515	x2 121919	x2 138460	x4 112985	x2 43057
x2 124564	x1 117451	x2 122048	x3 121252	x3 126912	x1 43152	x9 43154	x1 92663	x2 86989	x1 93445	x8 157628	x2 43137	x3 135091
x2 153829	x1 135092	x2 117835	x2 120917	x7 43168	x2 43174	x2 104719	x1 157630	x4 48199	x14 119721	x2 109915	x6 107858	x1 113535
x3 43194	x4 81744	x1 92904	x1 157631	x1 43184	x2 124602	x4 119722	x2 109913	x4 141417	x1 119493	x2 108326	x1 120795	x2 87252





# HISTORICAL COLLECTION



FOCKE-WULF FW 190 A-3  
+ 5741



FOCKE-WULF FW 190 A5  
+ 5722



PZL P.11c  
+ 5742



P-47 THUNDERBOLT™  
★ 5737

**NORTHROP GRUMMAN**

For news and special deals

Find us on:  
f cobr.bricks  
i cobr.klocki  
y COBI SA

WWW.COBIBRICKS.COM

01-05743-884