

**ARMED
FORCES**



LOCKHEED MARTIN 



 LOCKHEED® C-130J®
"SUPER HERCULES"

**PAD PRINTED
NO STICKERS**

Printed in EU

5838



**UK
CA**

CE



 **WARNING: CHOKING HAZARD-**
Toy contains small parts.
Not for children under 3 years.

641  **2** 

LOCKHEED® C-130J® "SUPER HERCULES"

SCALE 1:61



1

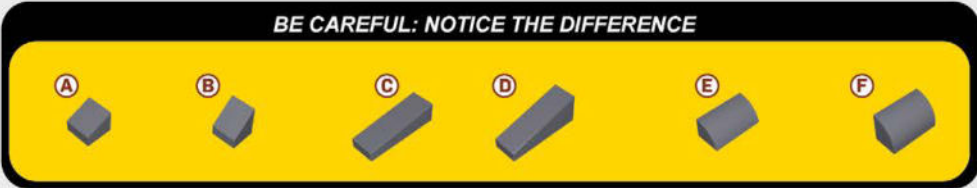

BE CAREFUL: NOTICE THE DIFFERENCE

A

B

C

D

E

F

2

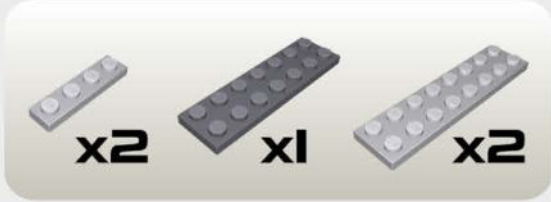
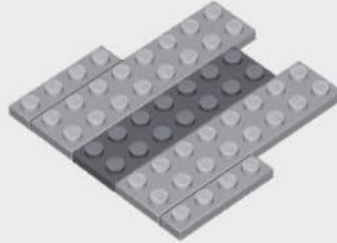

x2

x1

x2

I

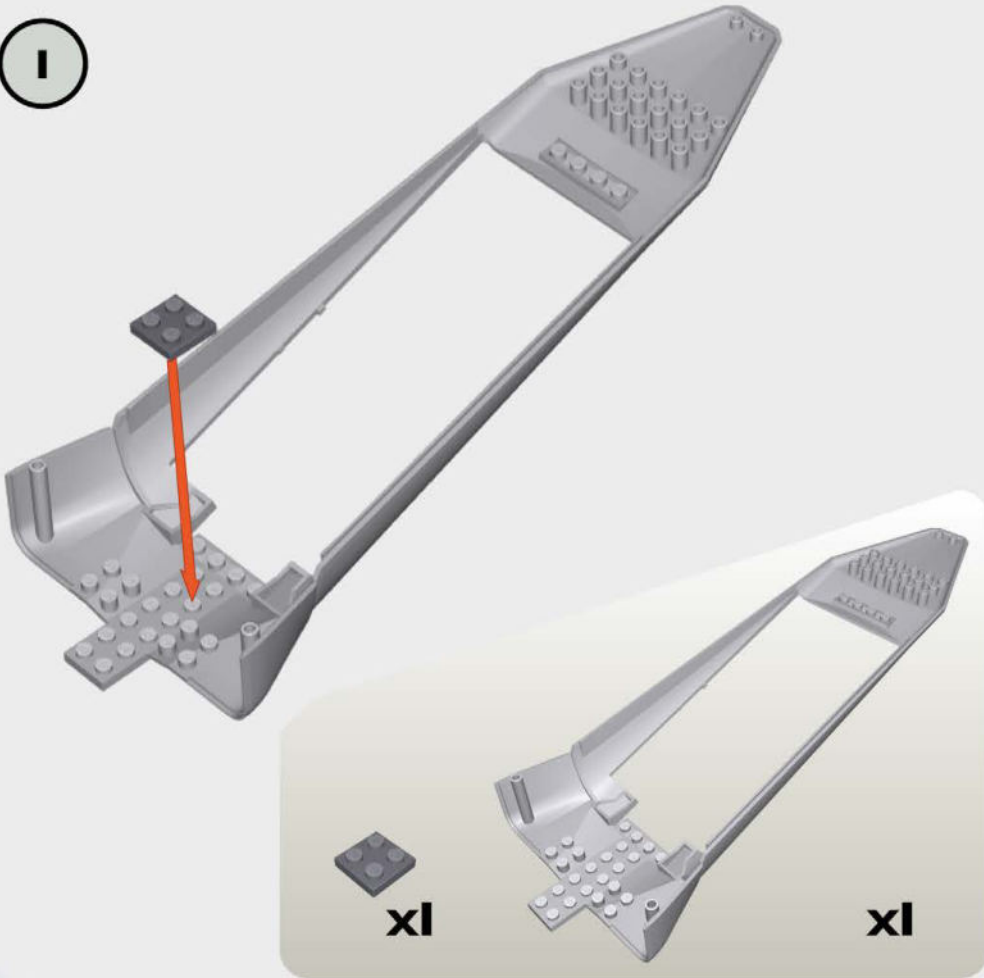

x1

x1

3

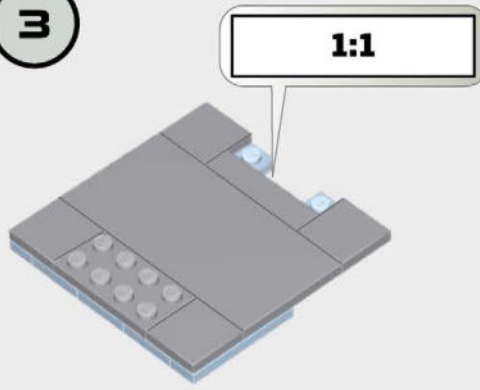

1:1

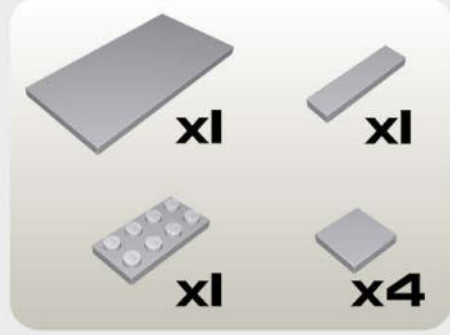

x1

x1

x1

x4

4

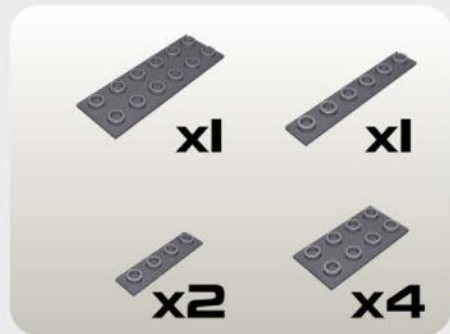
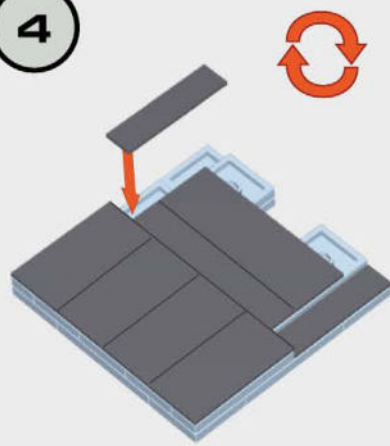

x1

x1

x2

x4

5

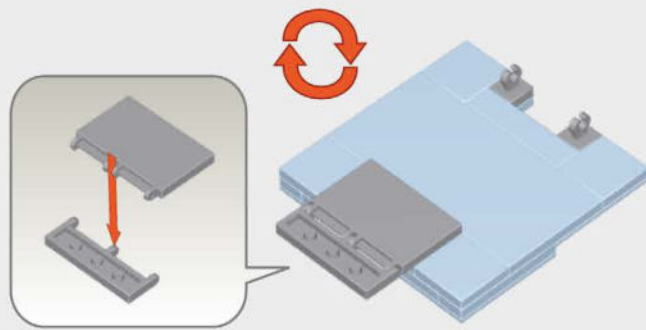

6

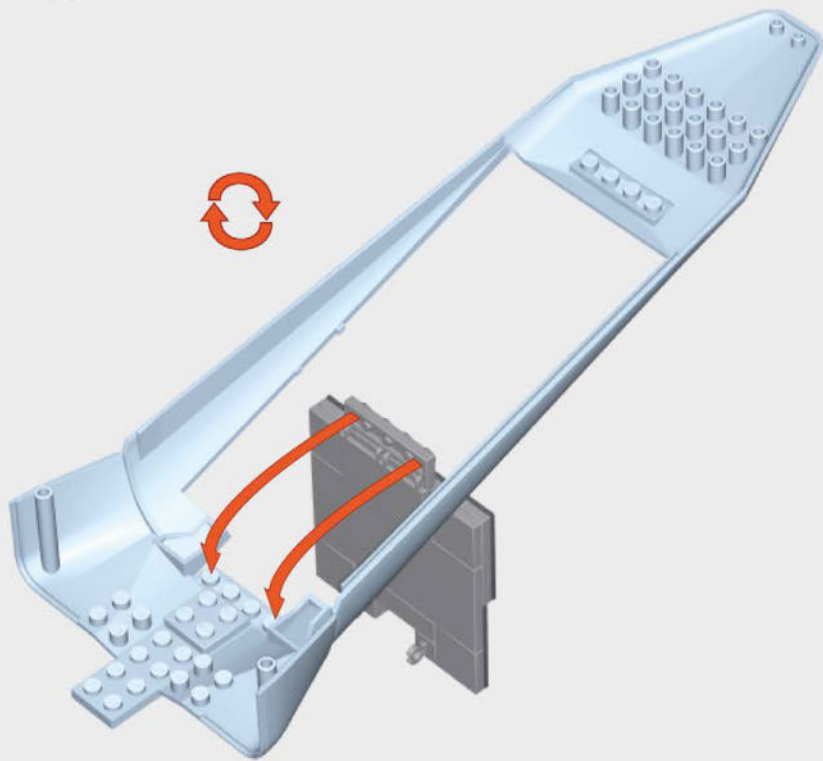

7

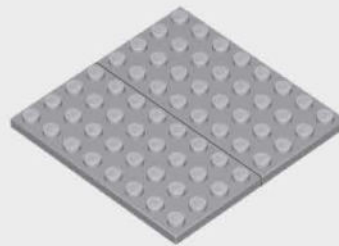

8

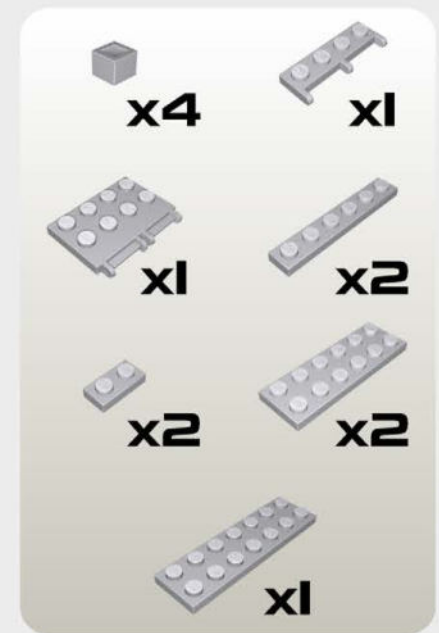
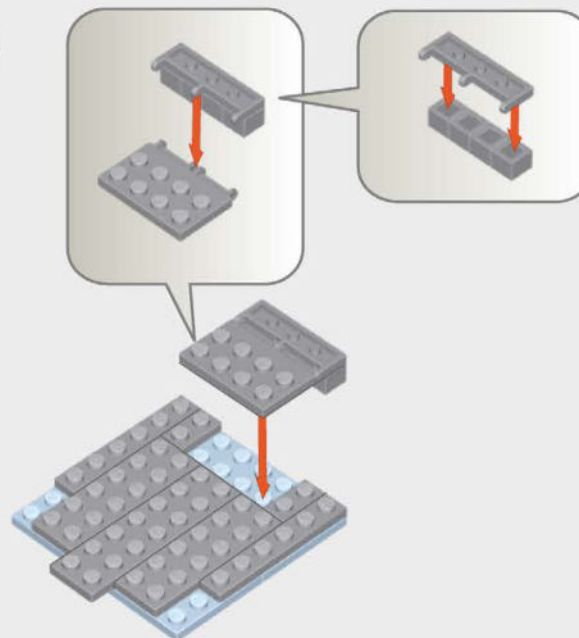

9

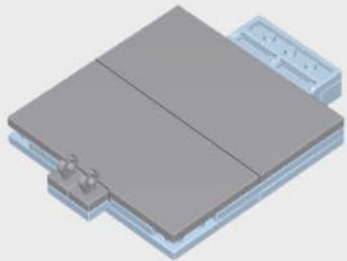

11

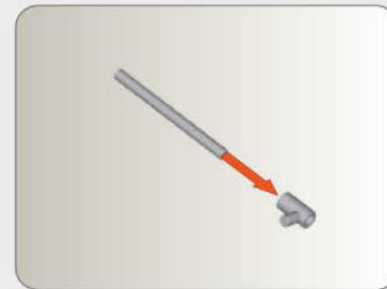

10

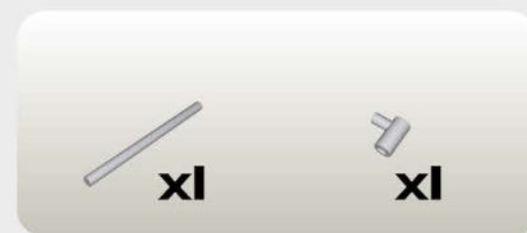
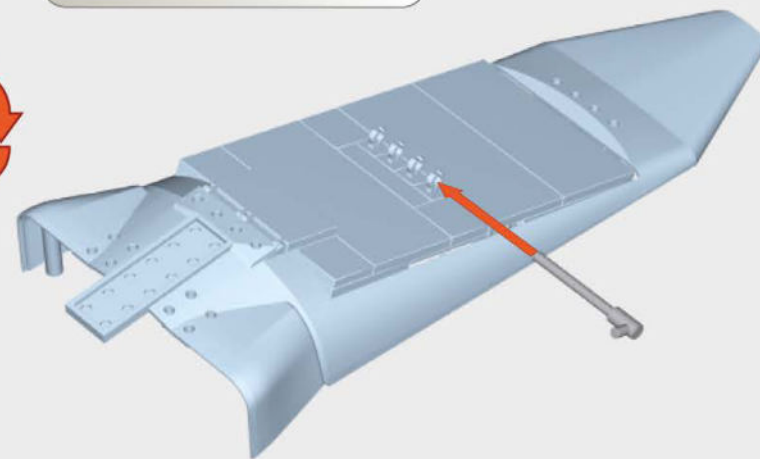
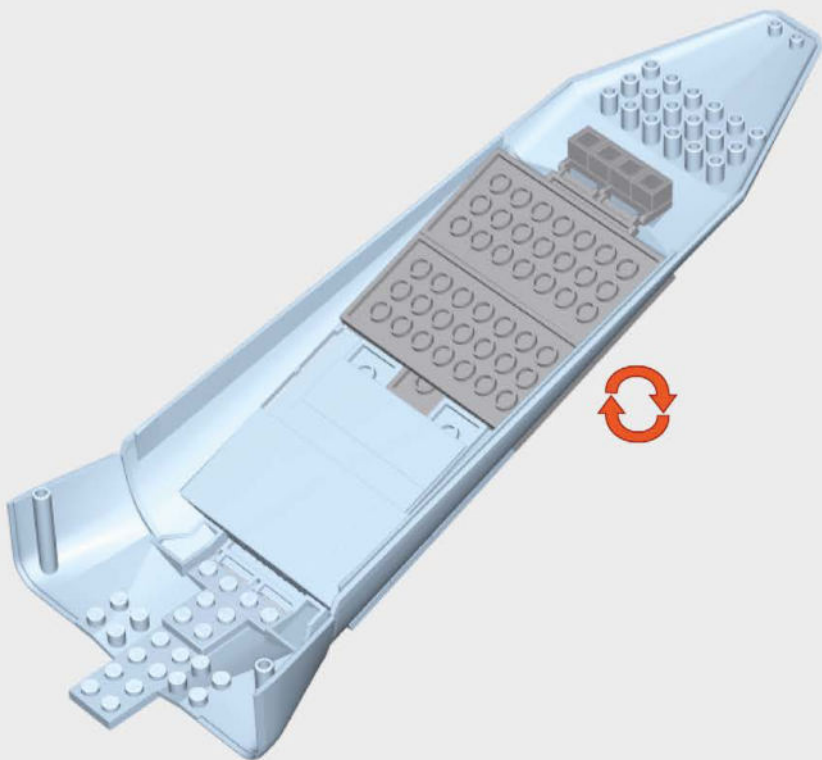

12

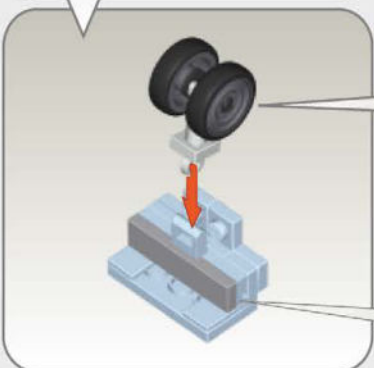
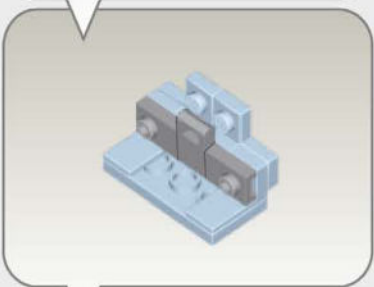
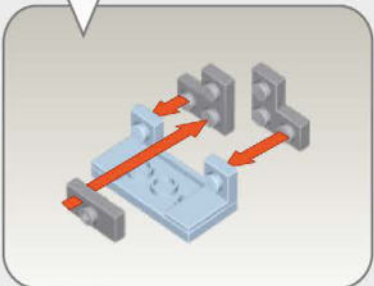
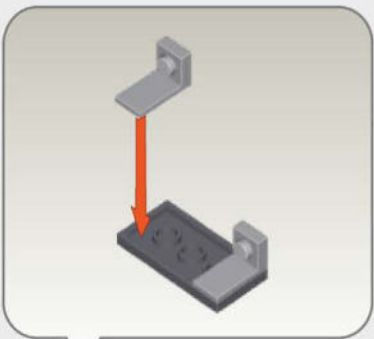

x1



x2



x2



x1



x2



x1



x1



x1



x1



x1



x1



x2



x2

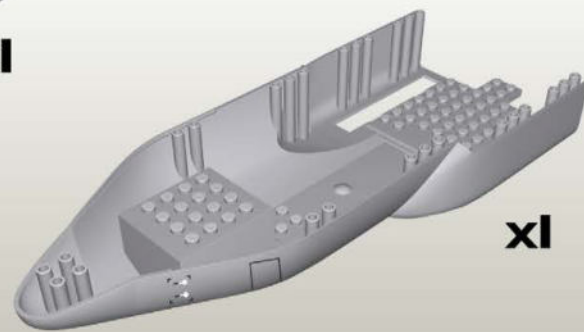

x1



x2

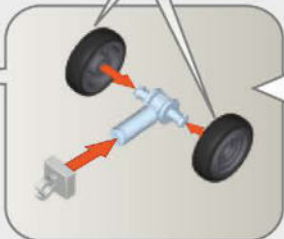

1:1

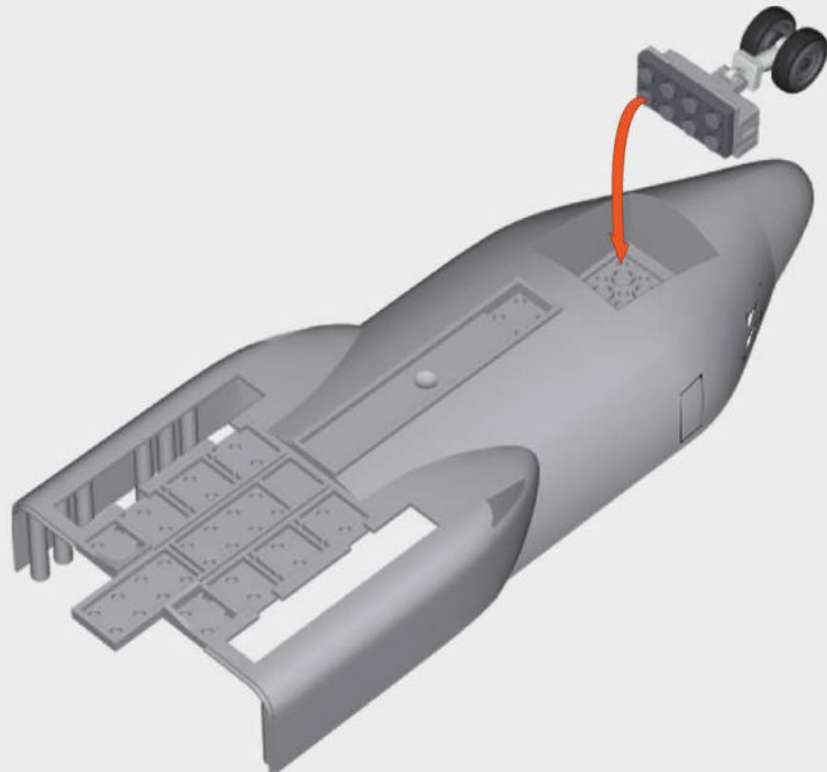

x1

13

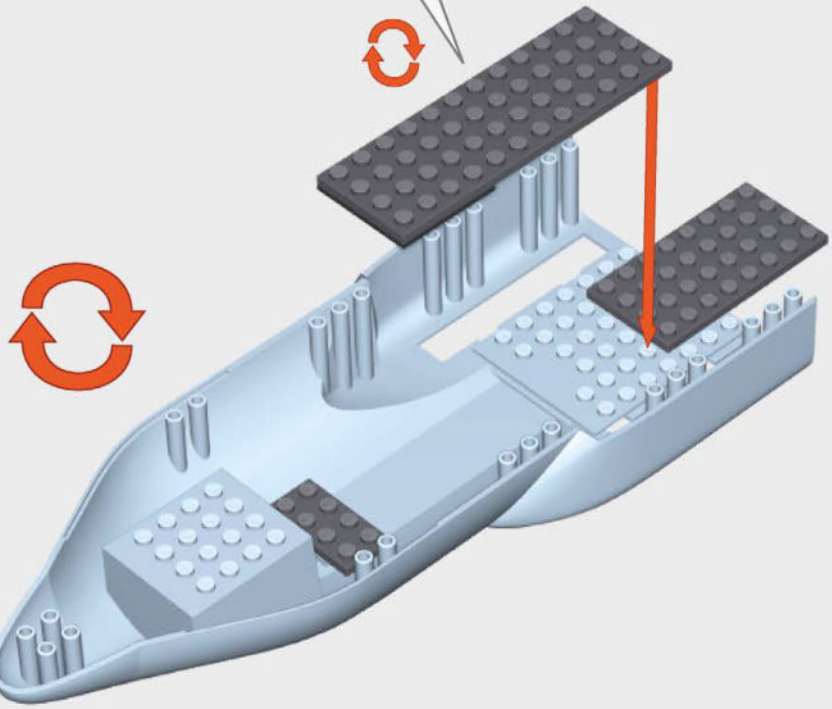
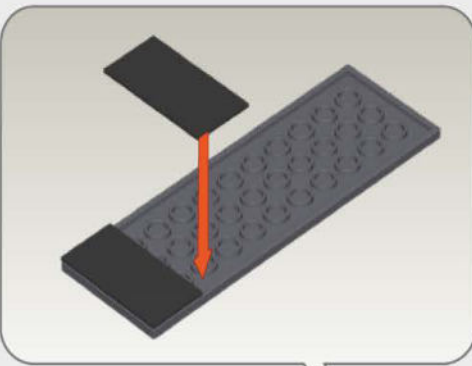

14

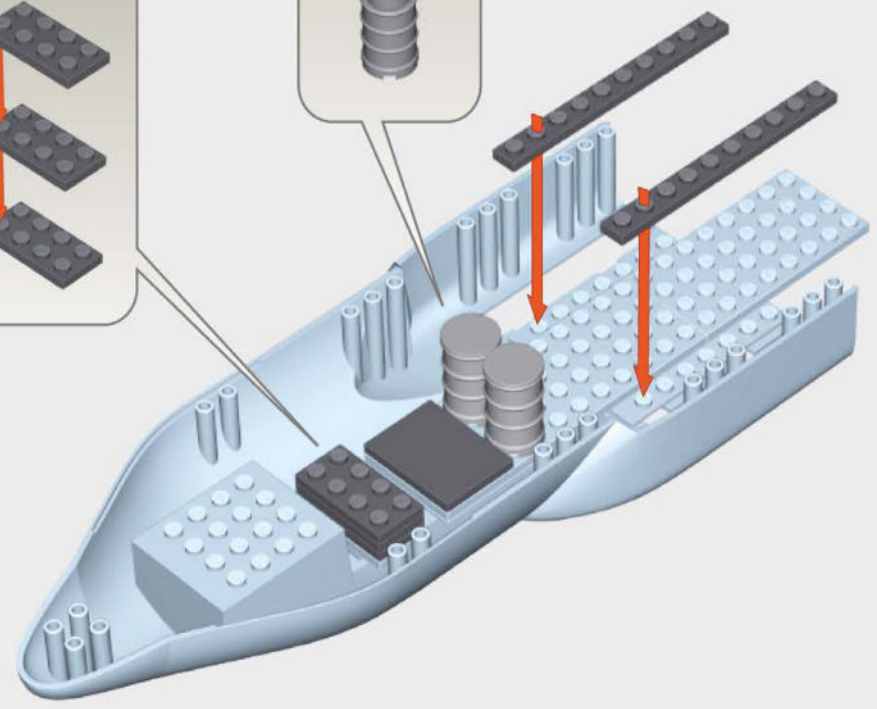
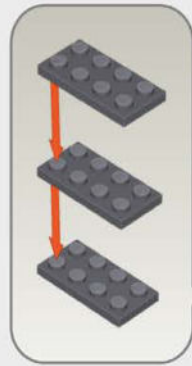
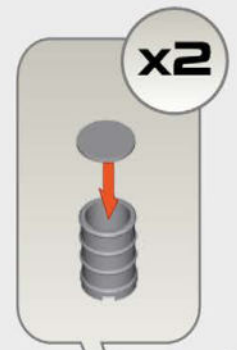

15

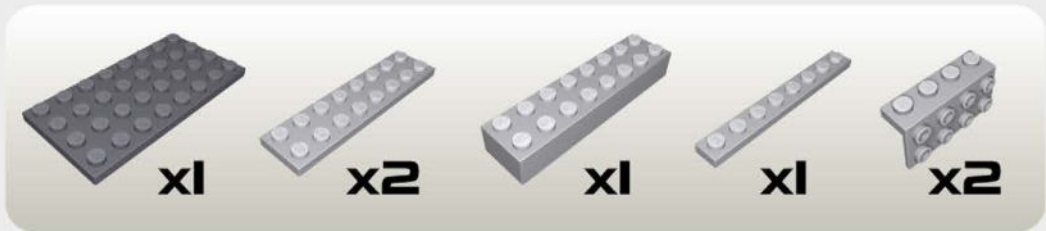
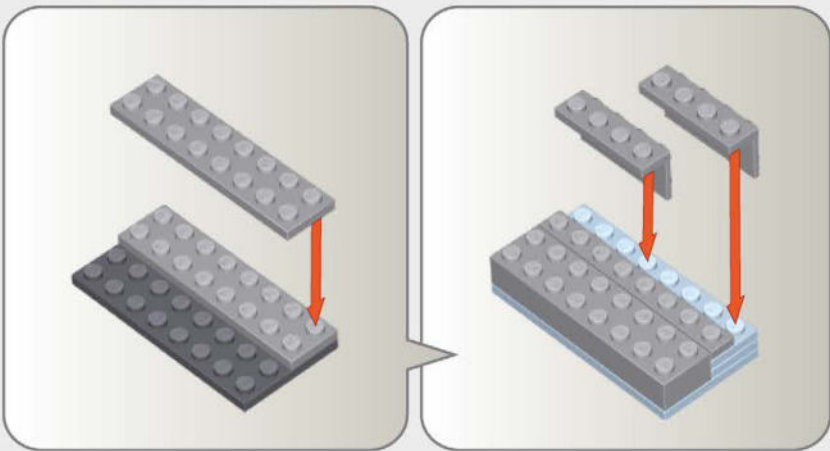

16

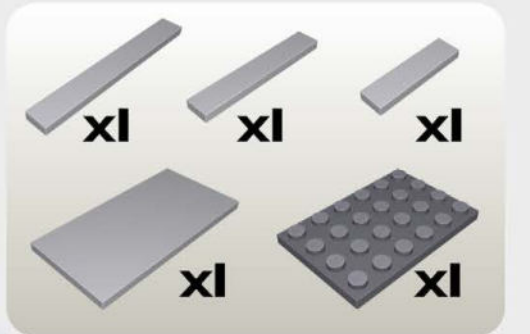
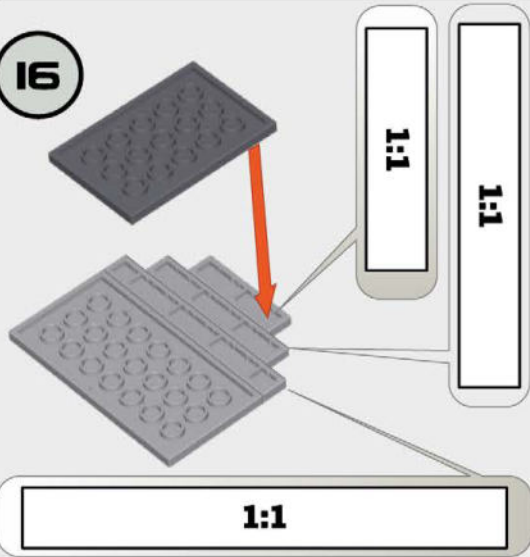

17

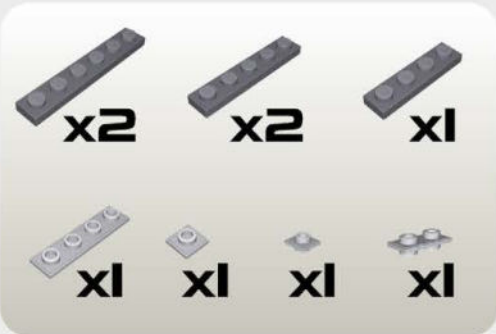
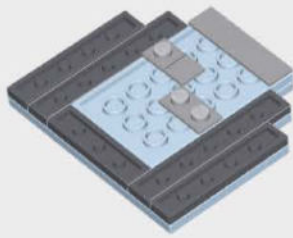

18

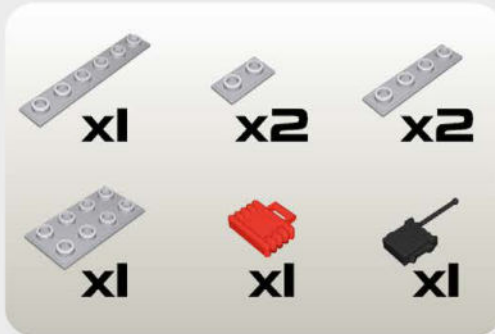
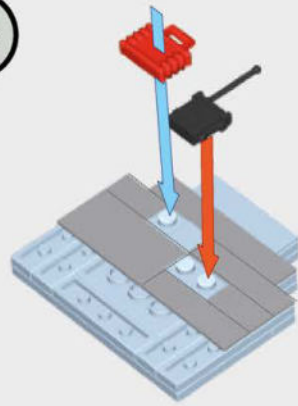

19

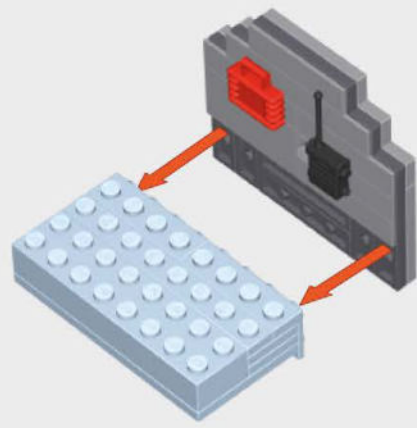

20

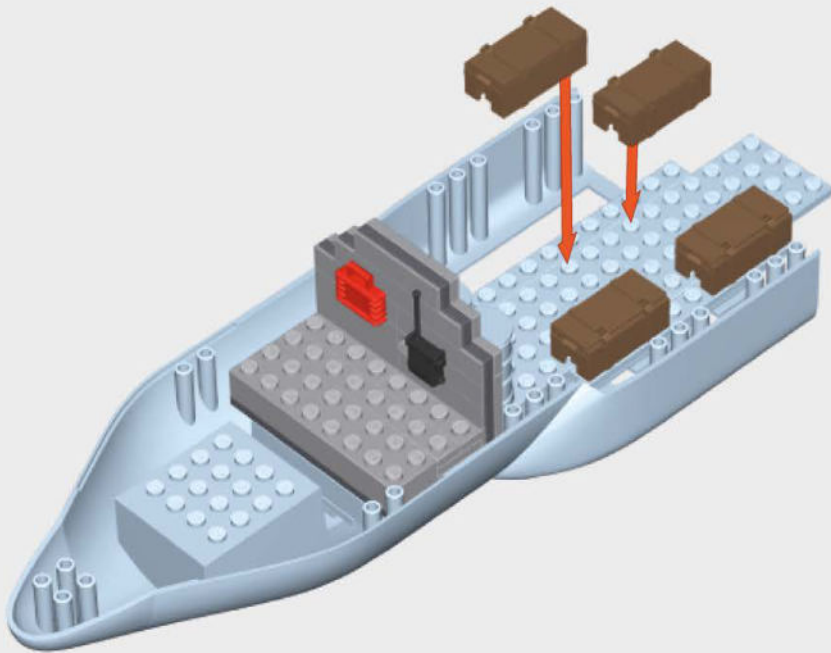
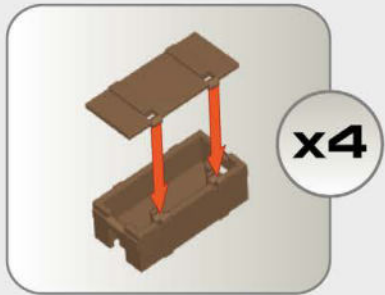

21

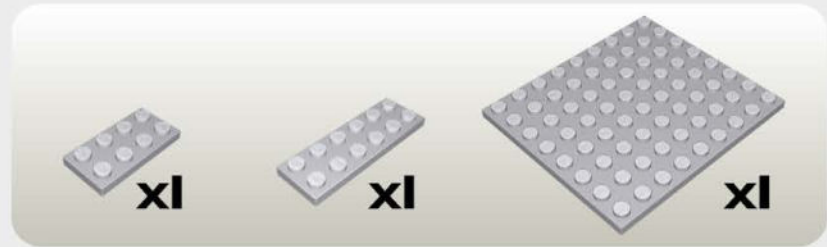
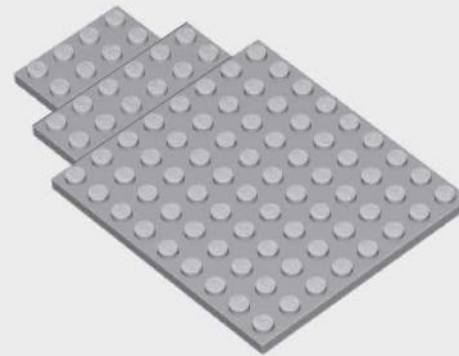

22

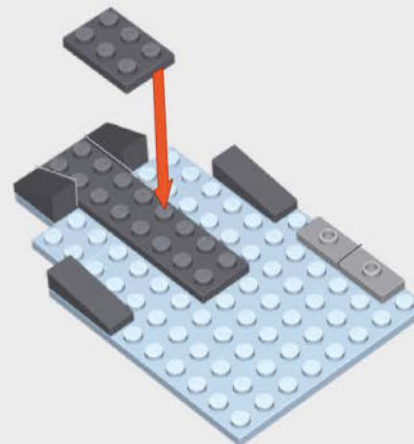

23



24

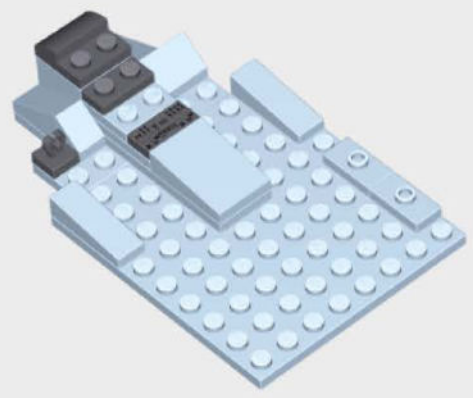

25

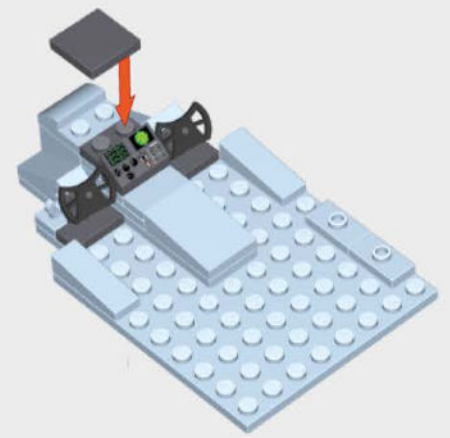

26

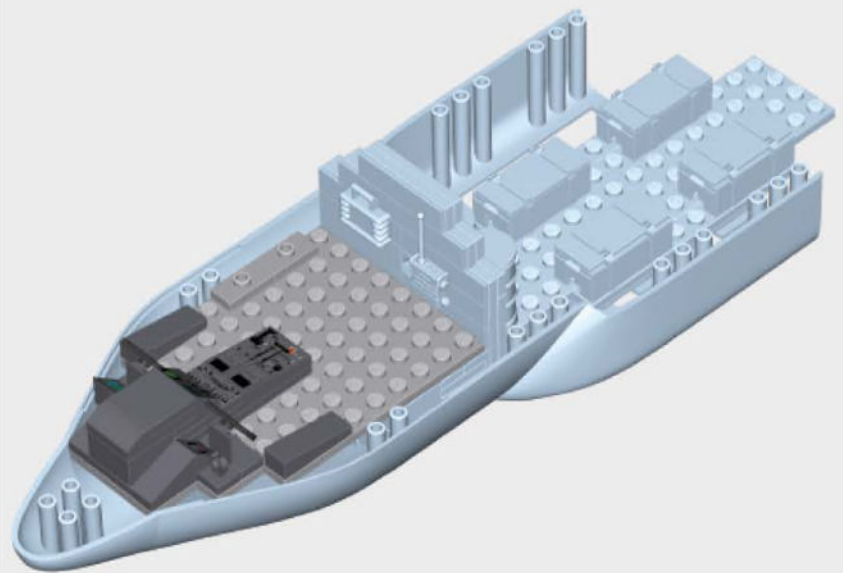



-  x1
-  x3
-  x1
-  x1
-  x1

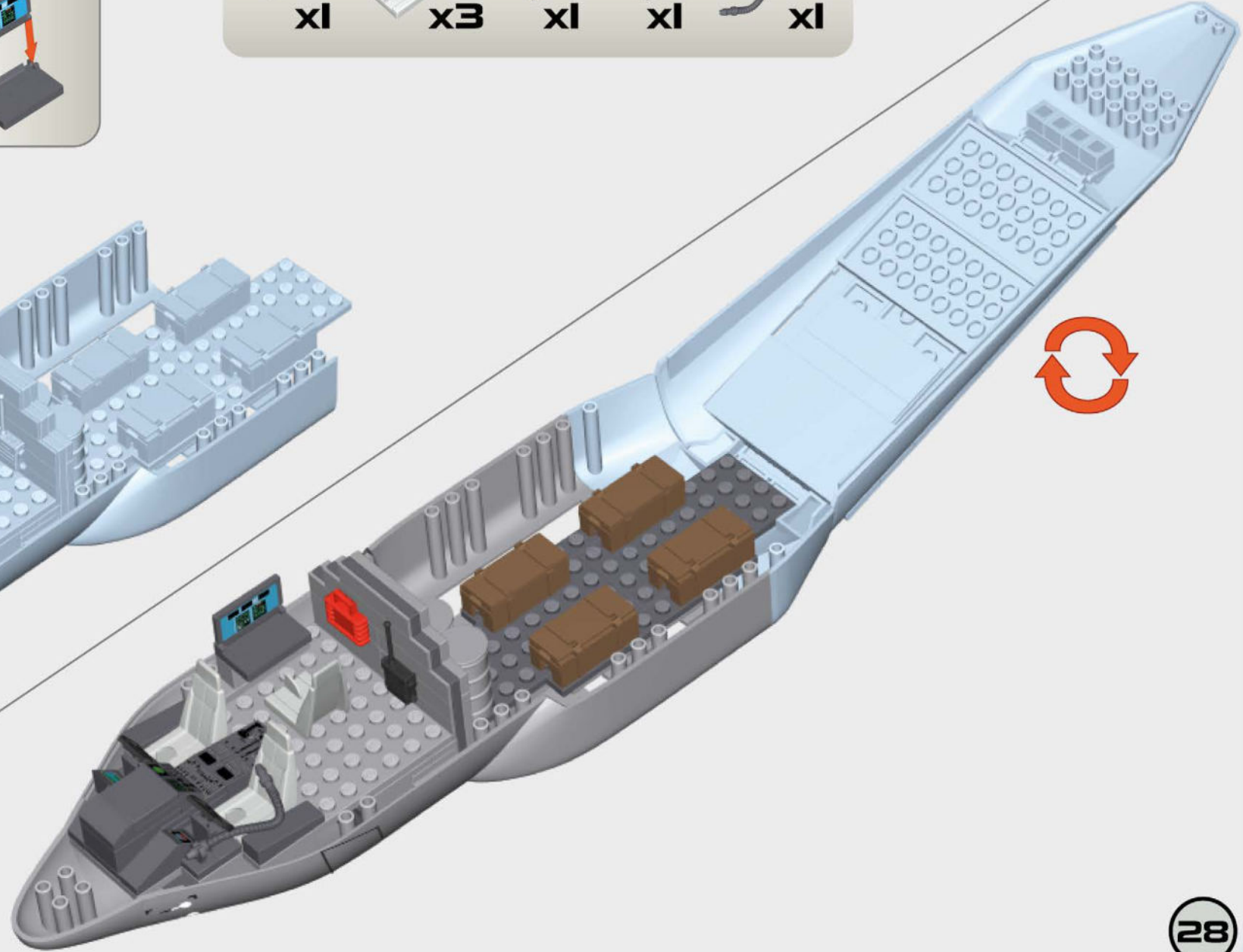
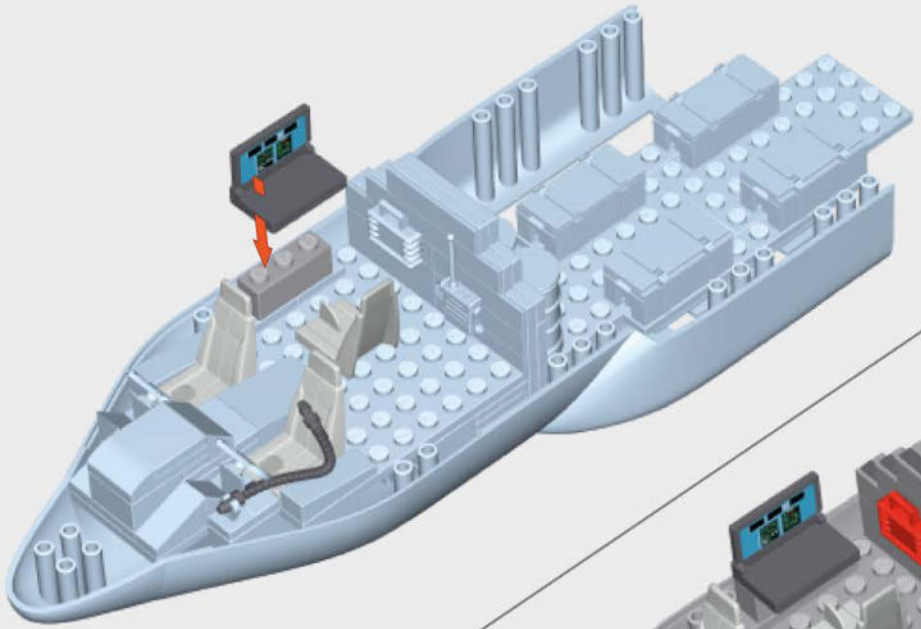

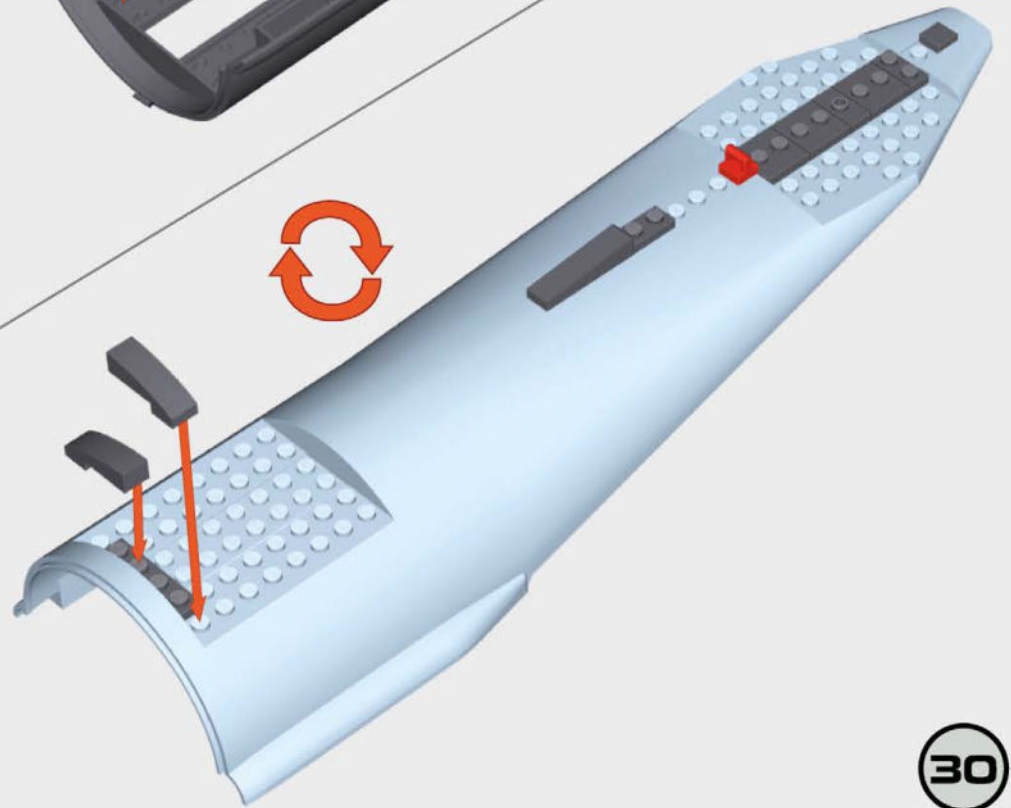
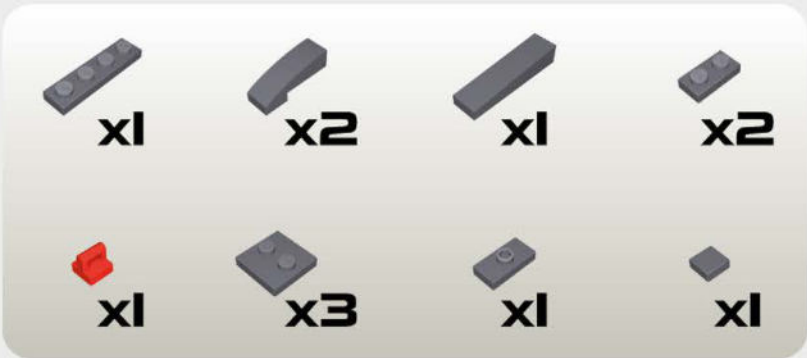
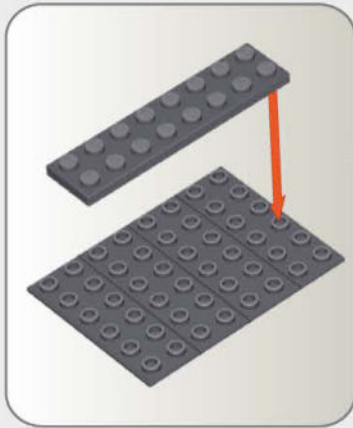
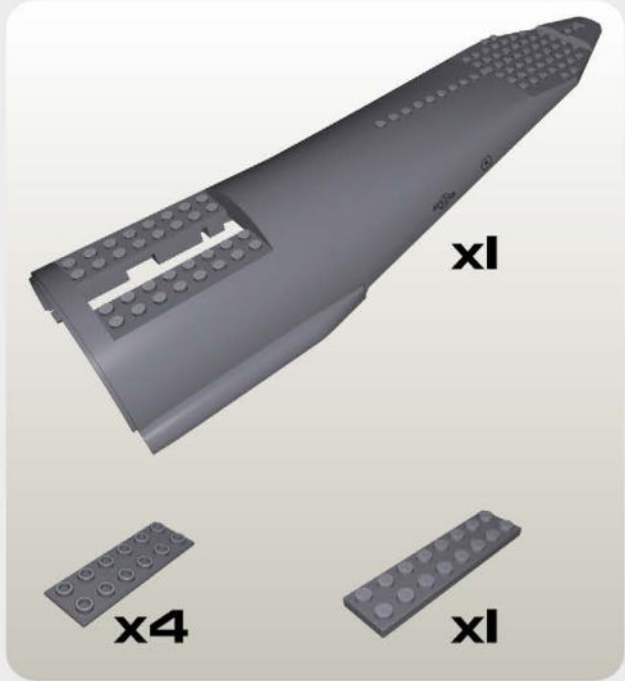

31

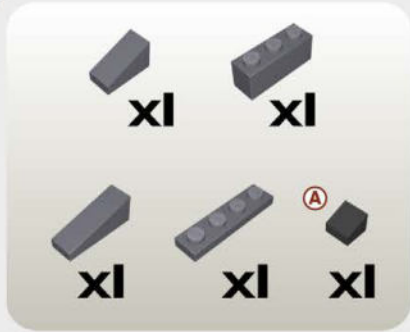
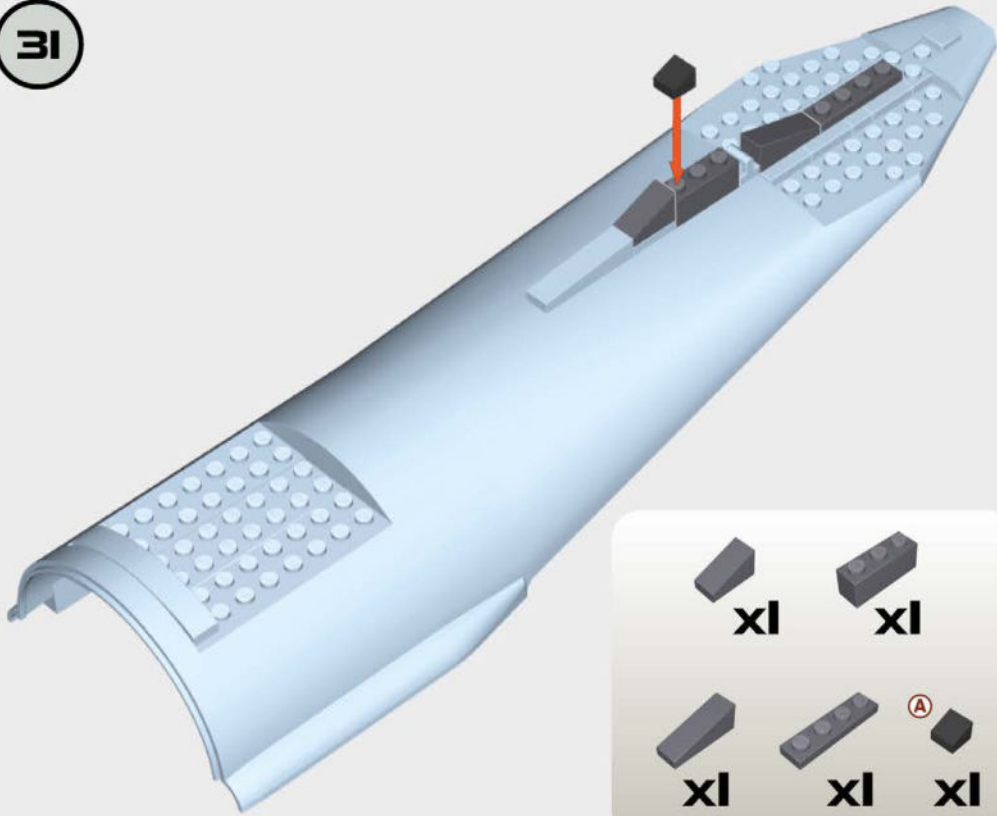

32

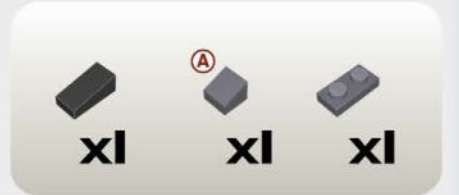

33

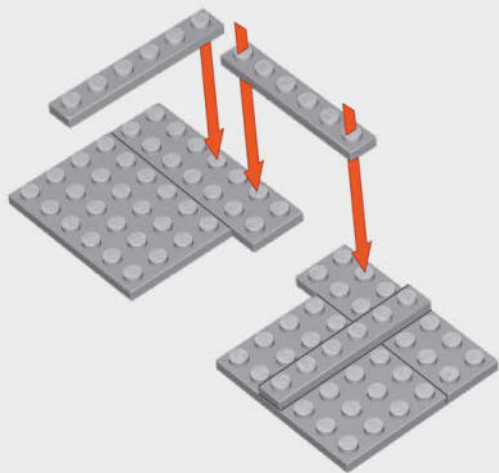

34

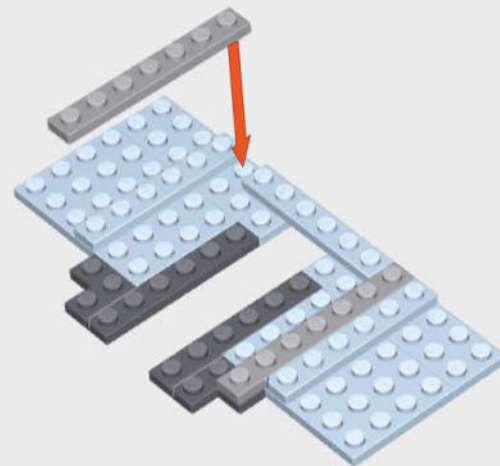

35

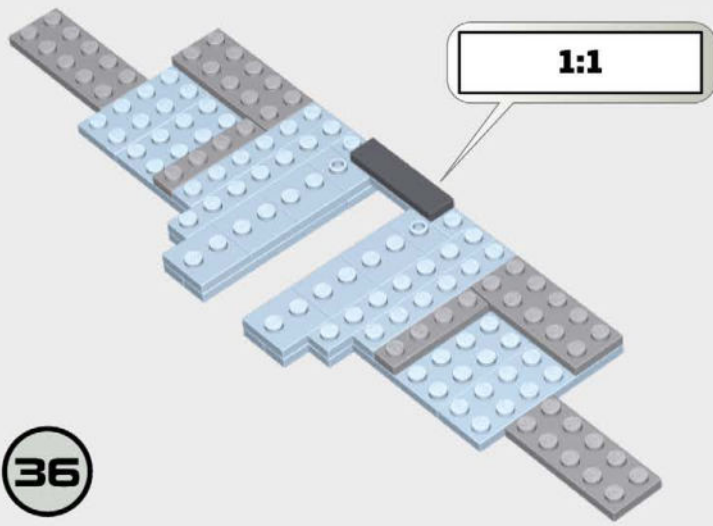
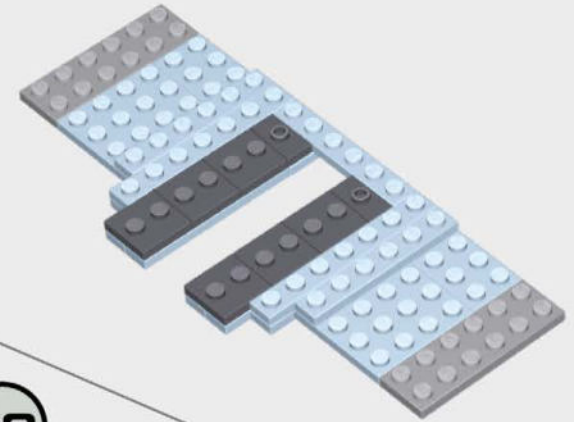

36

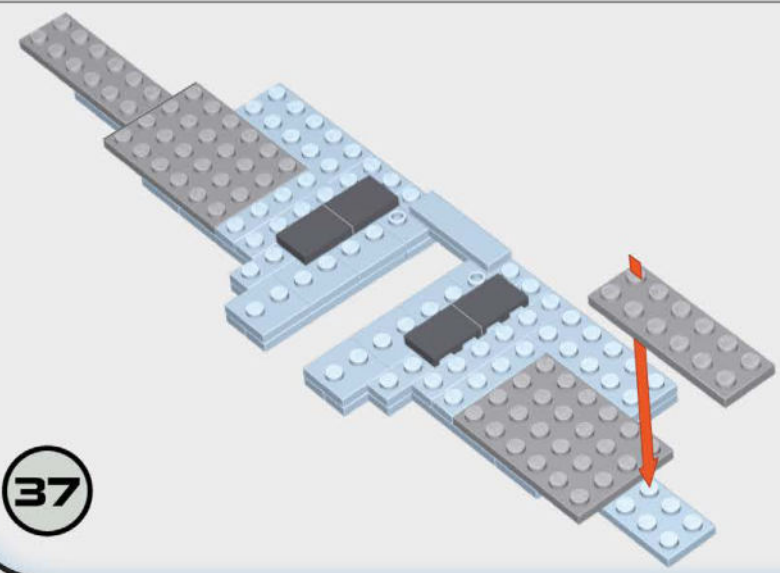

37



38

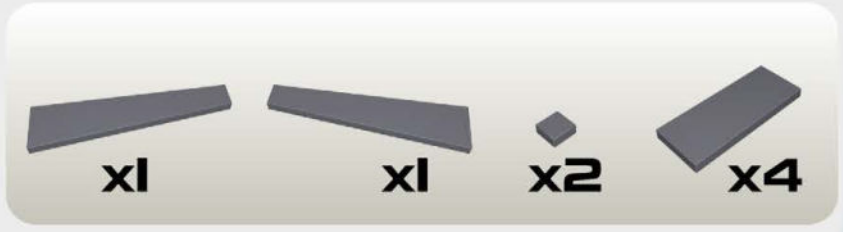
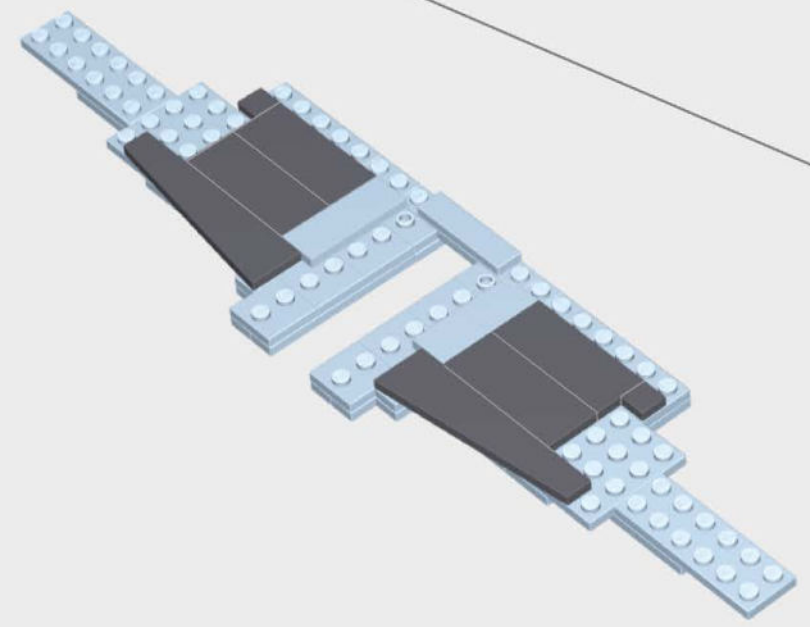



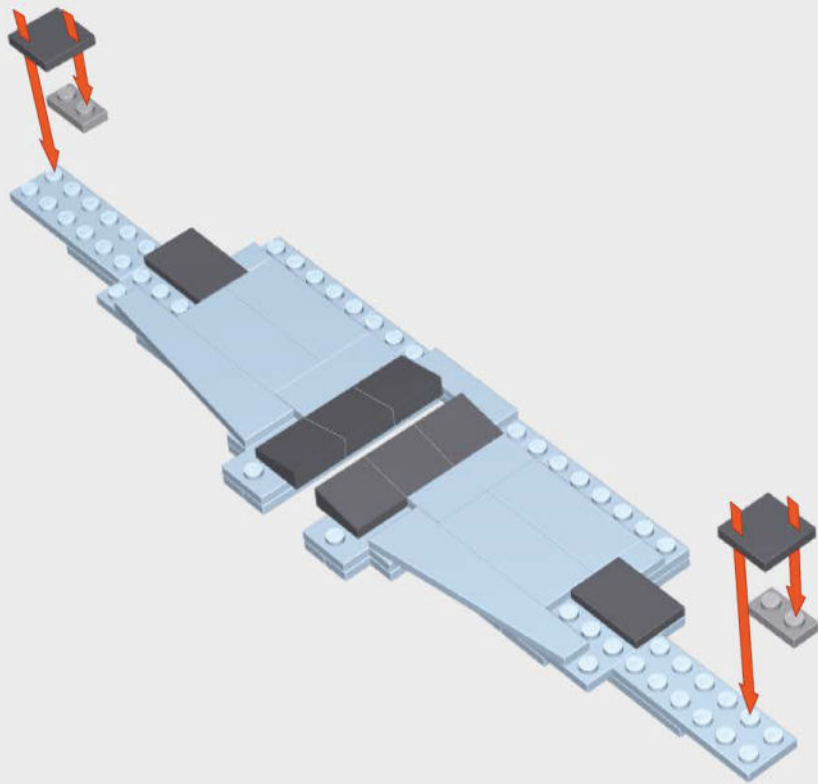

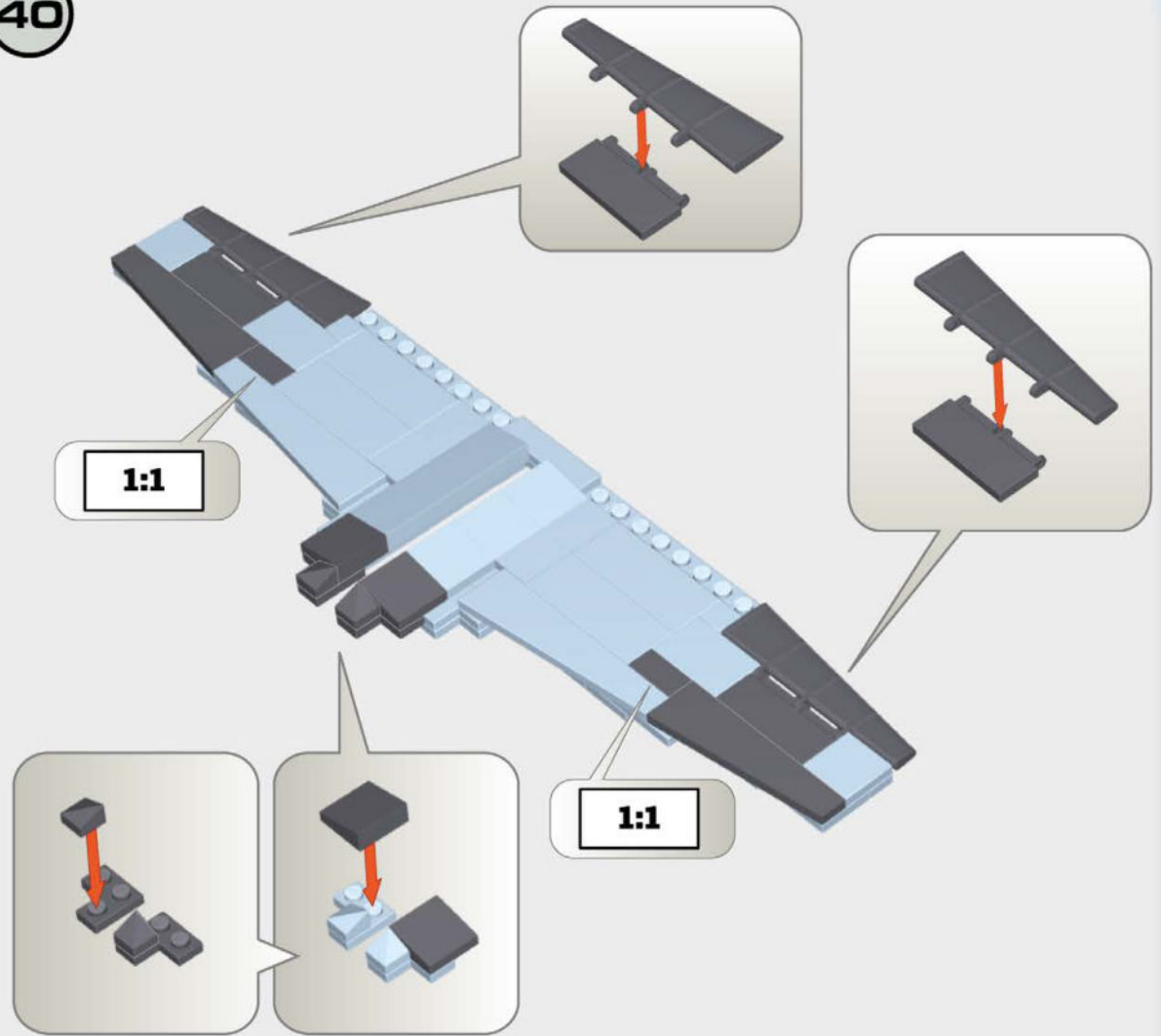

39



40



- 
x6
- 
x2
- 
x2
- 
x2

- 
x2
- 
x1
- 
x1
- 
x2
- 
x2
- 
x2
- 
x2
- 
x2

41

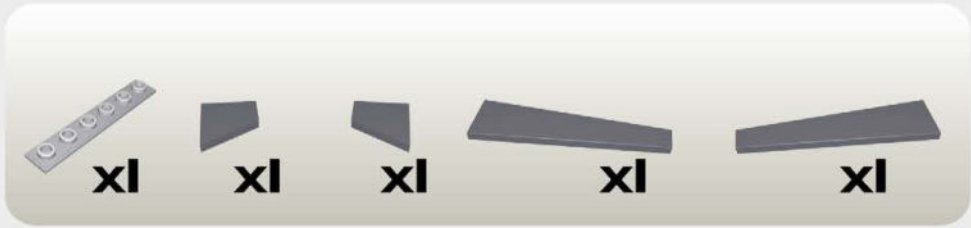
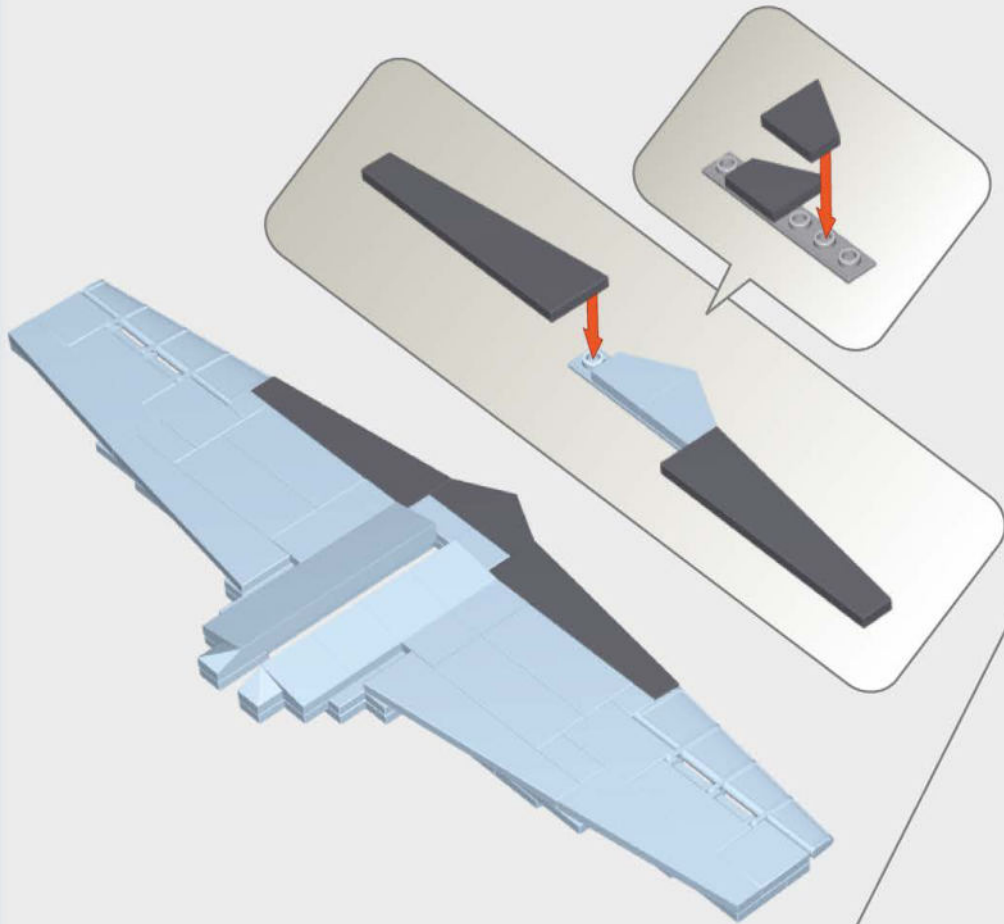



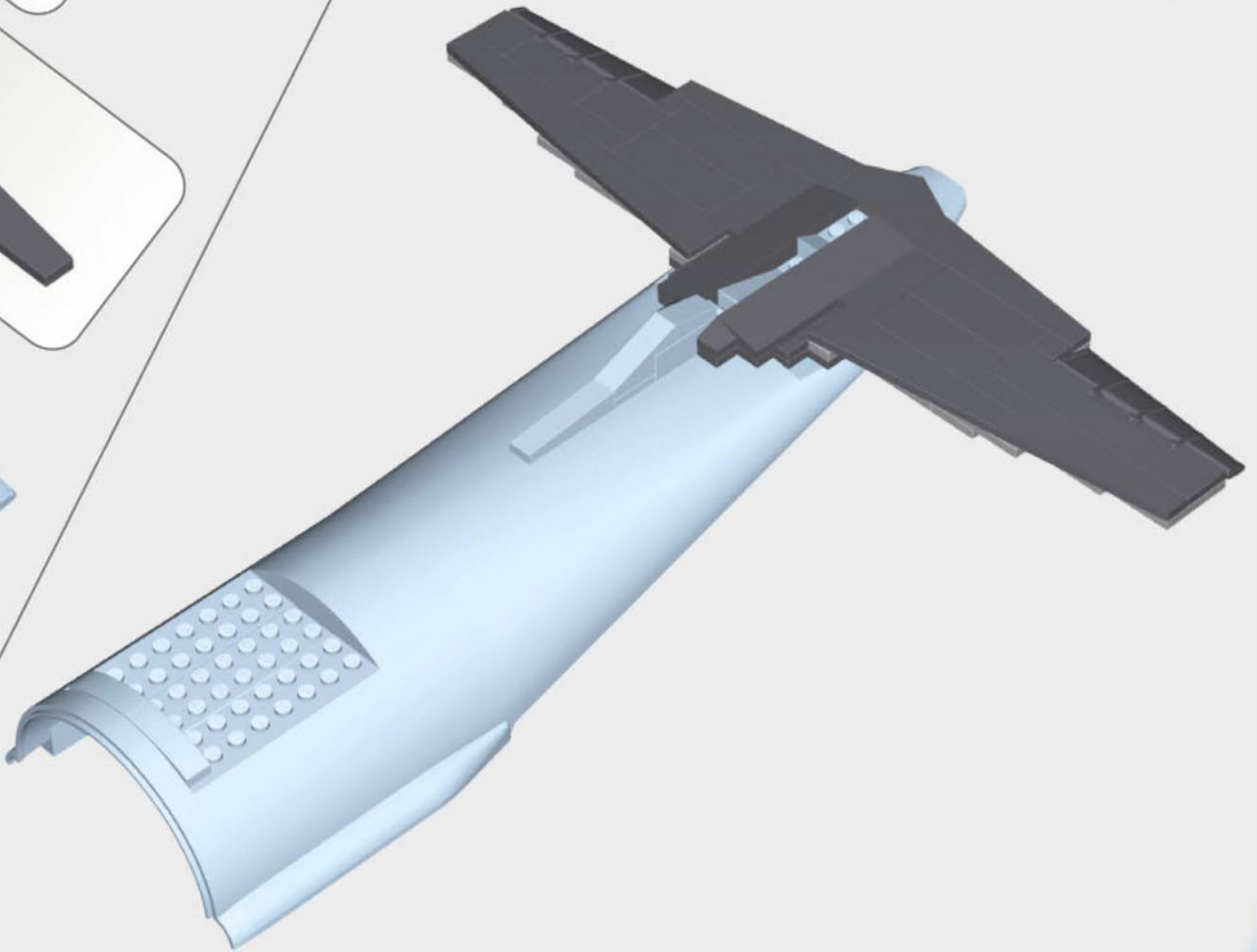

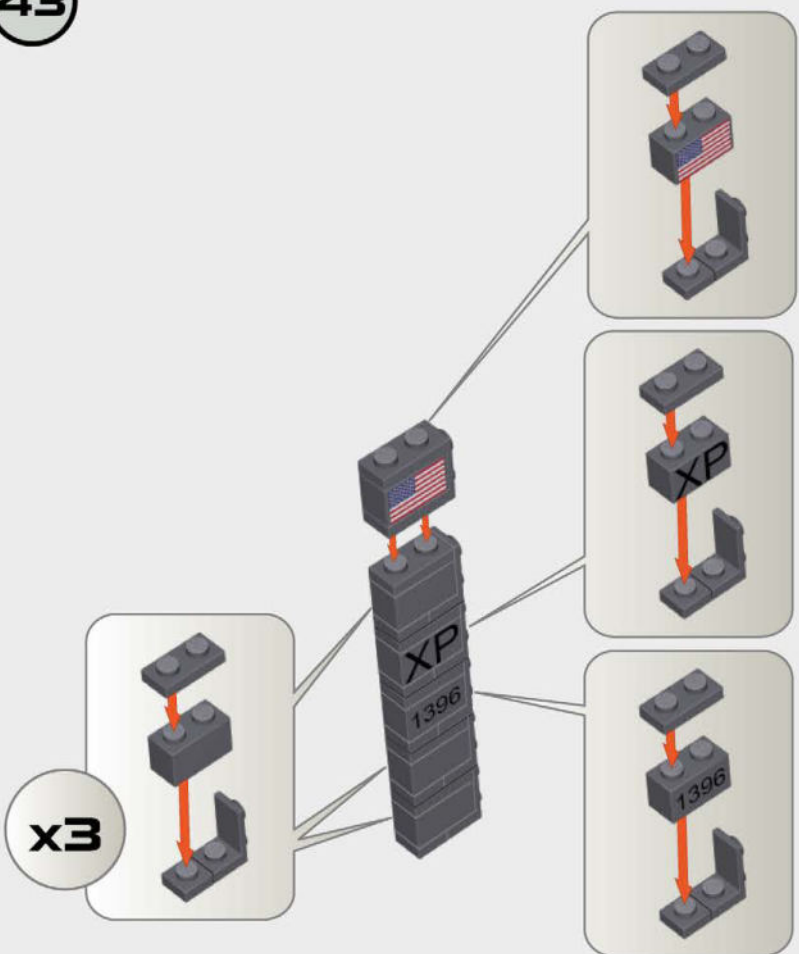

42



43







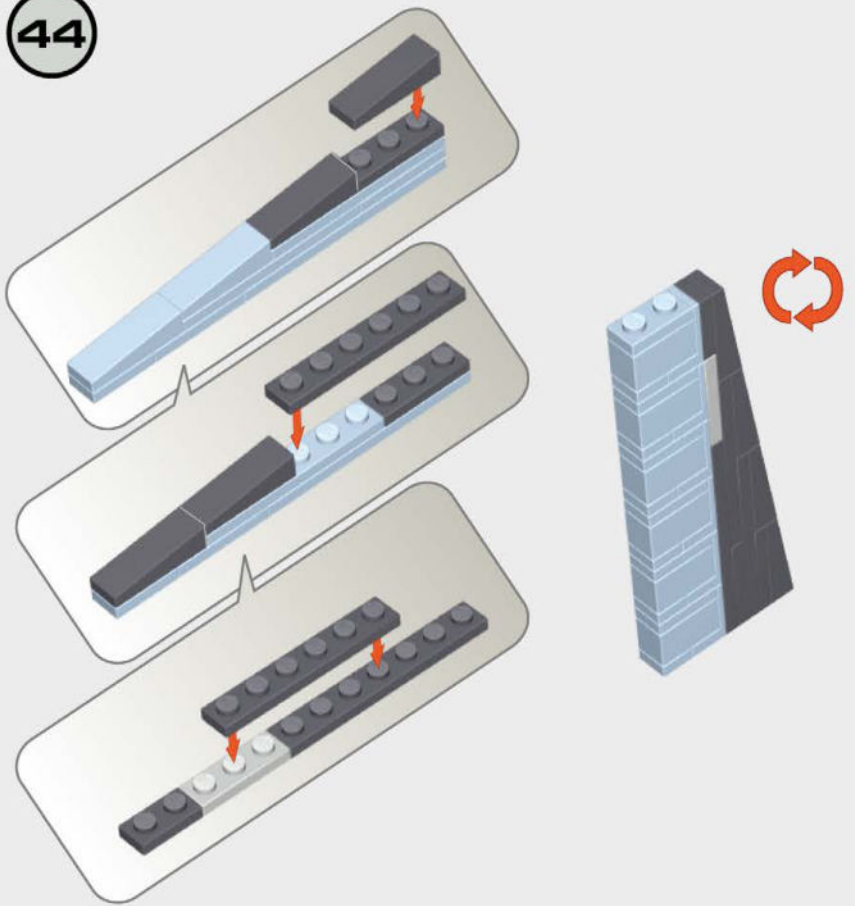

x3

-  x6
-  x6
-  x3
-  x1
-  x1
-  x1
-  x6





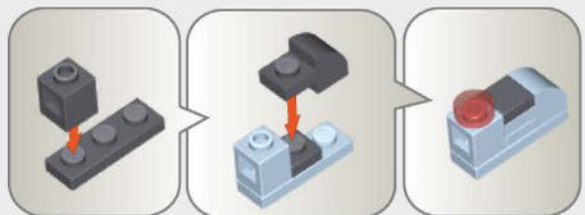

44



-  x1
-  x1
-  x1
-  x2
-  x2
-  x4



45

-  x1
-  x1
-  x1
-  x1
-  x1
-  x1
-  x1

46

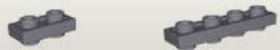

x2

x2

47

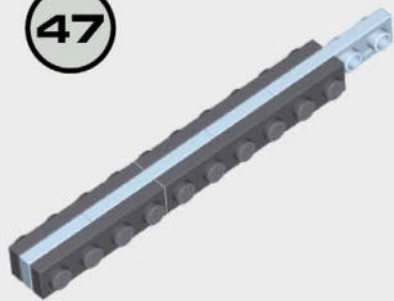

x2

x2

48

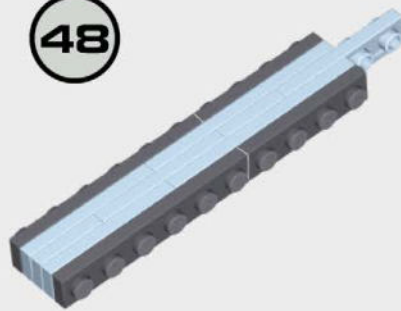

x2

x2

49

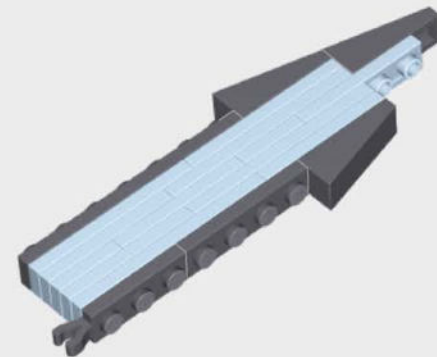

x3

x1

x1

x1

50

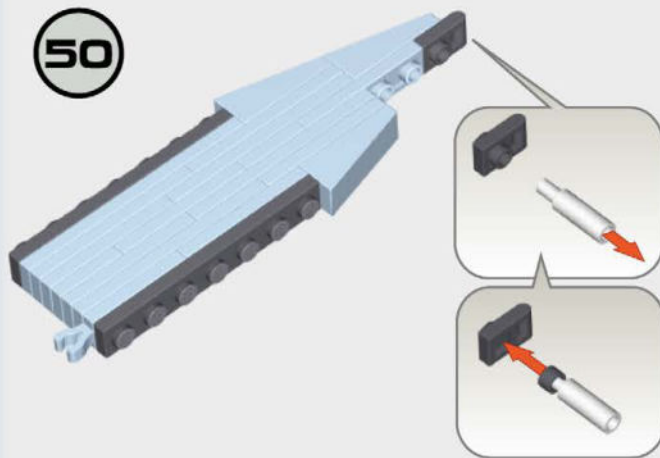

x2

x1

x1

51

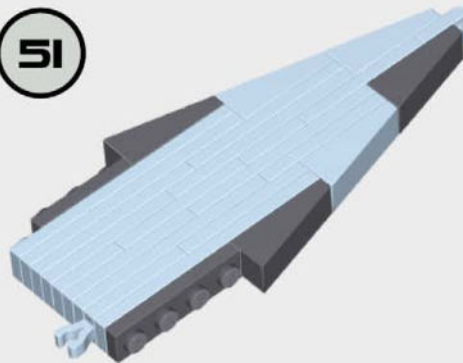

x1

x1

x3

52

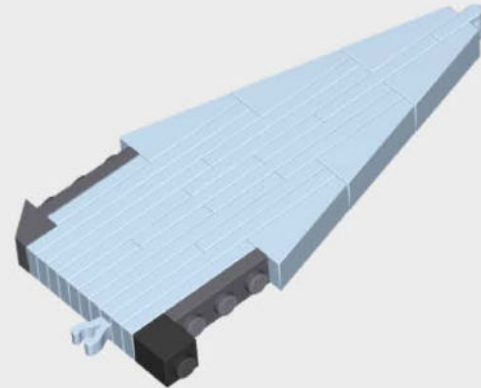

x2

x1

x1

53

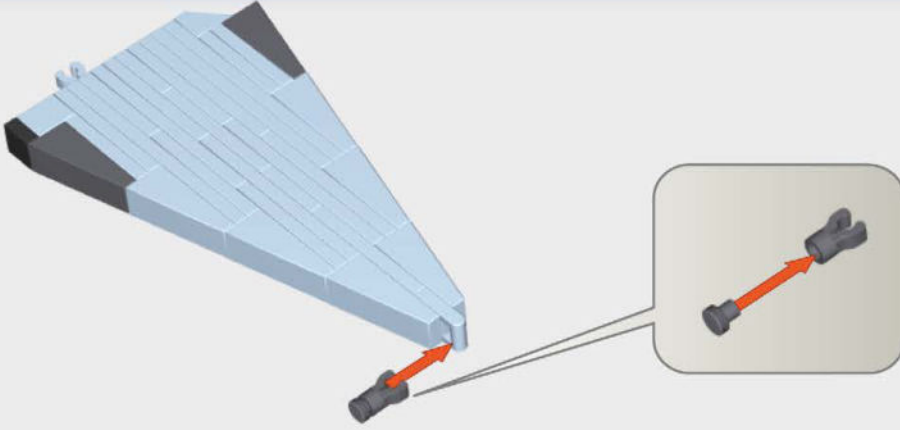

x1	x1	x2	x1

54



55

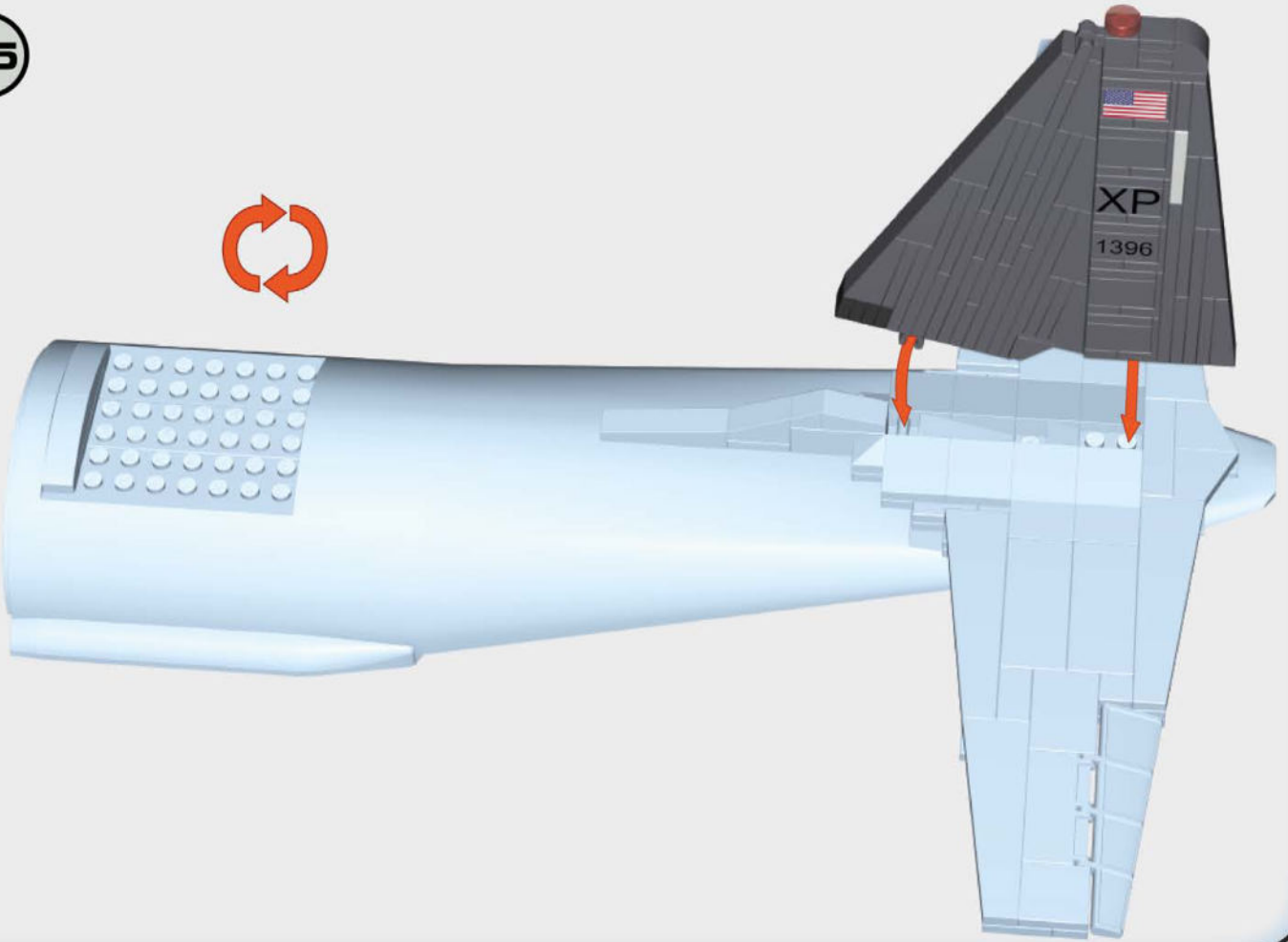

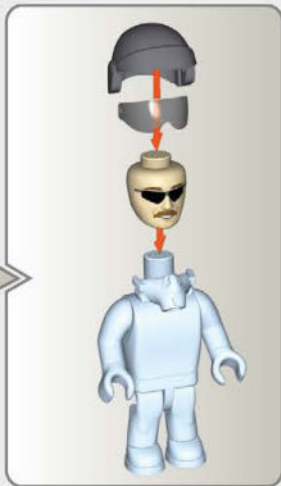
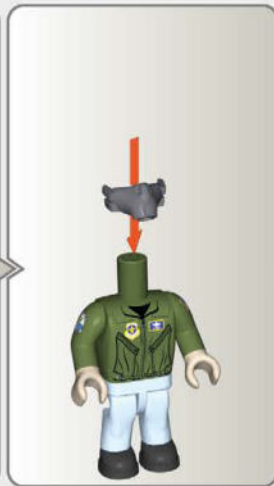
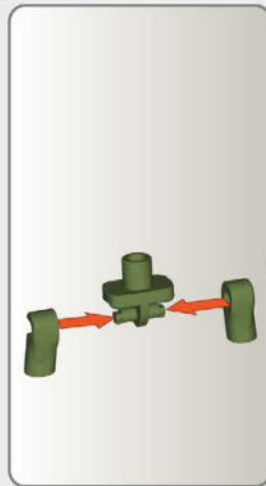
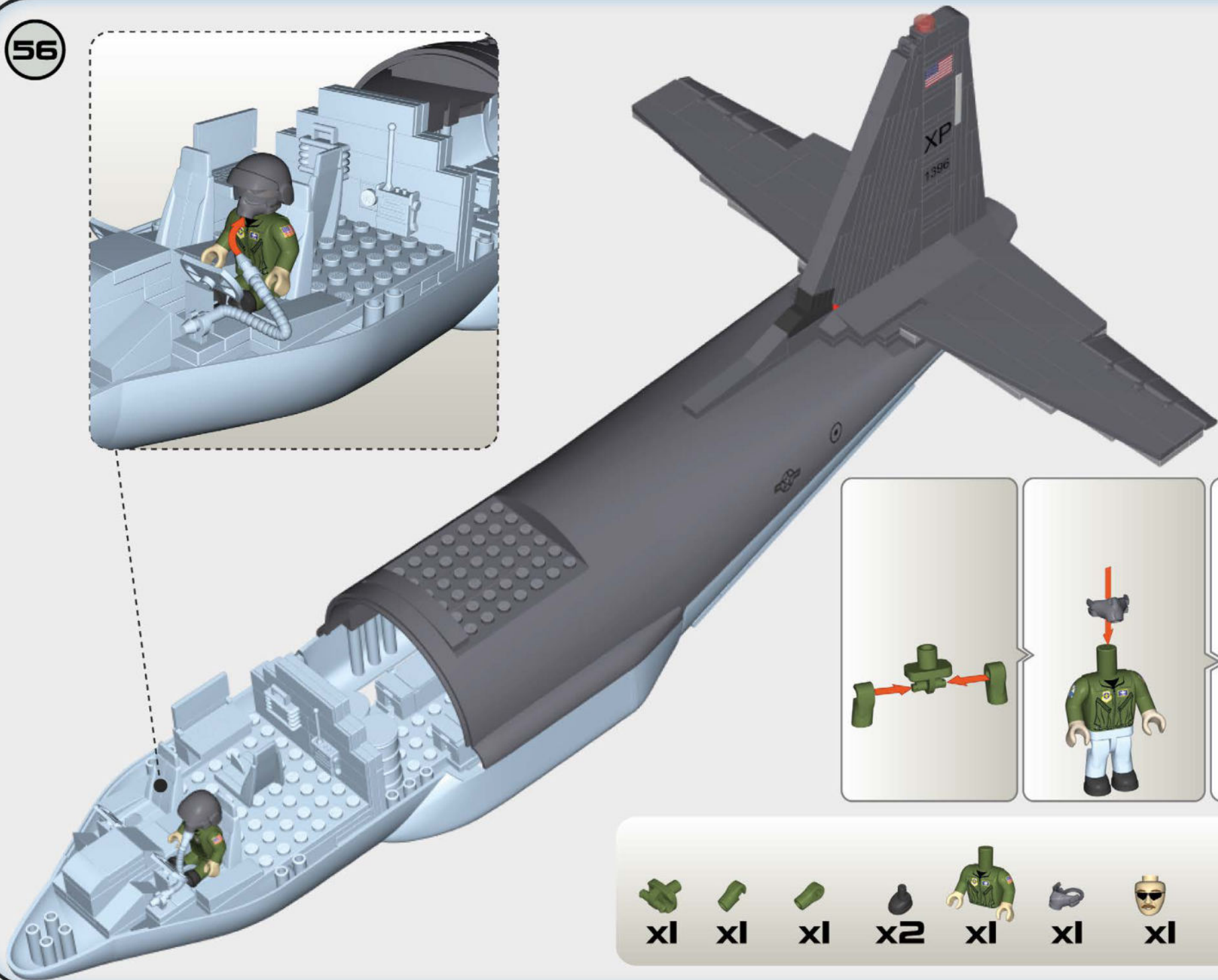
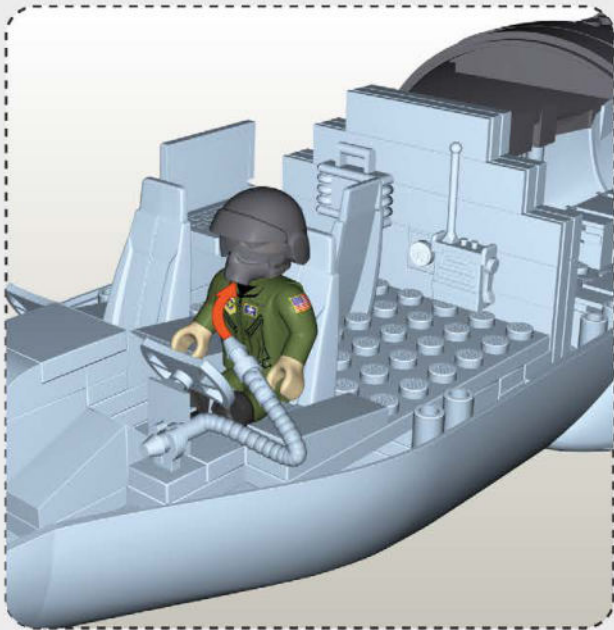

- 
x1
- 
x1
- 
x1
- 
x2
- 
x1
- 
x1
- 
x1
- 
x1
- 
x1

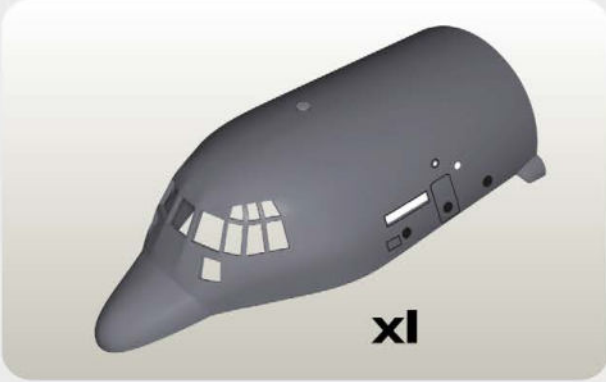

xi



58

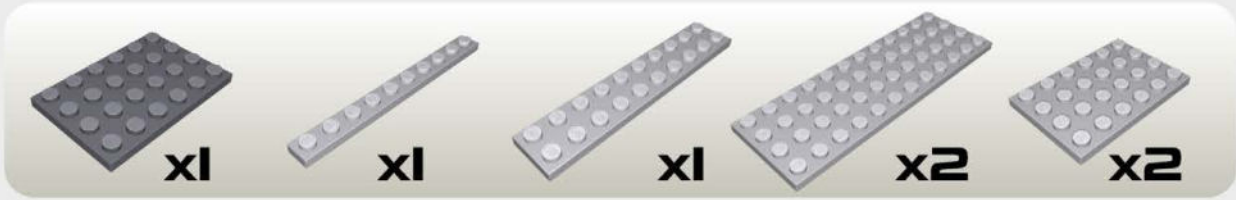
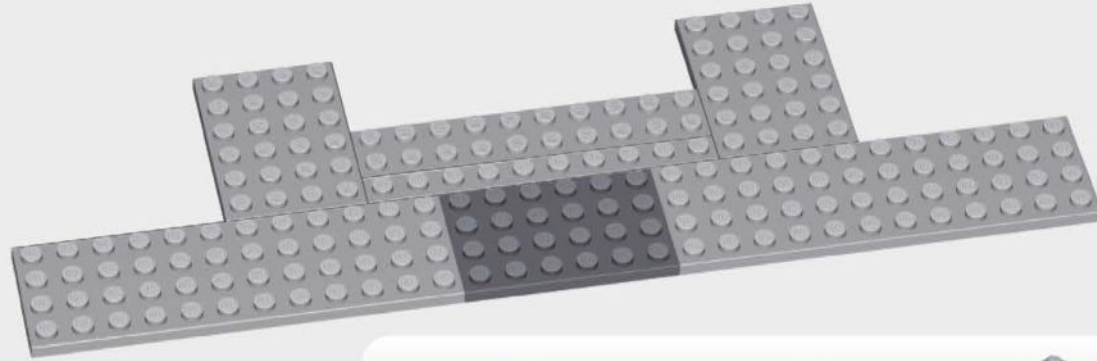

59

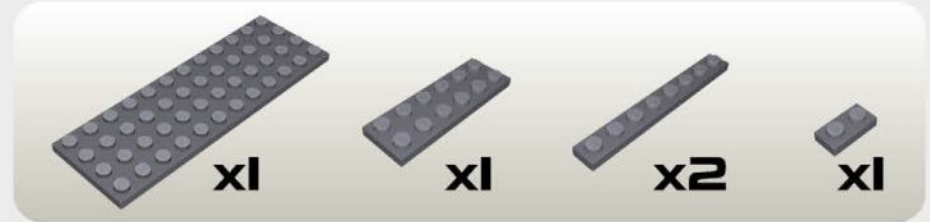
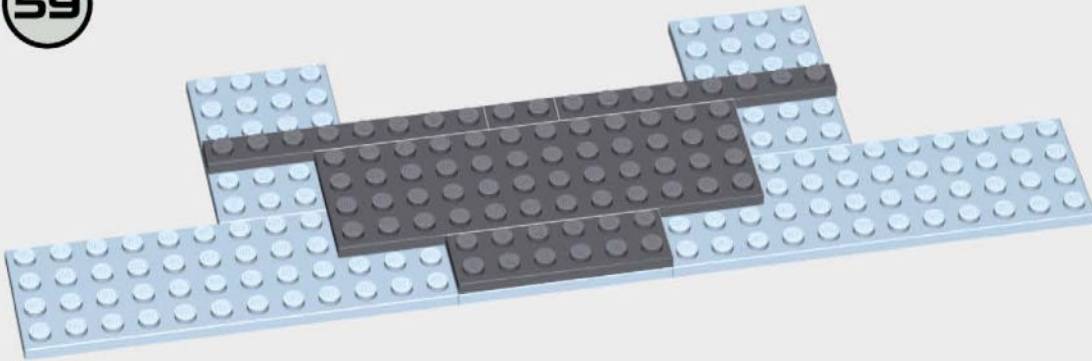

60

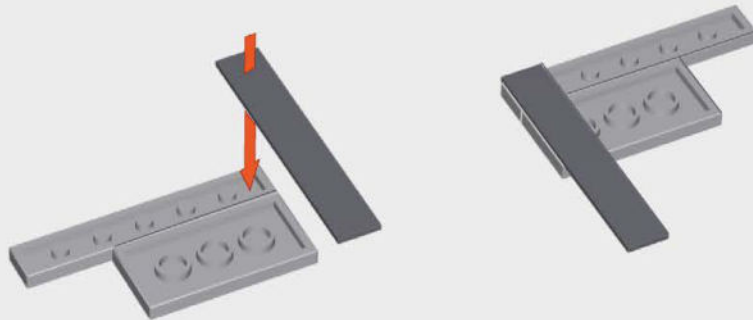

61

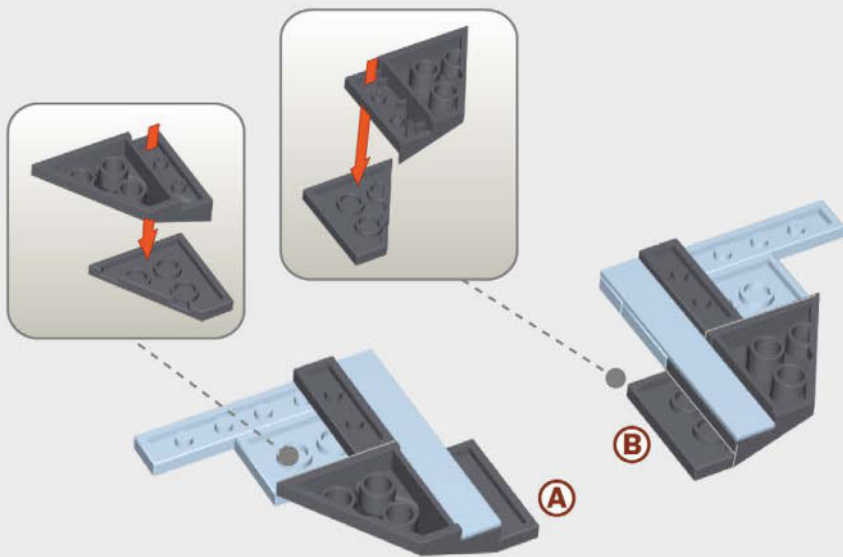

62

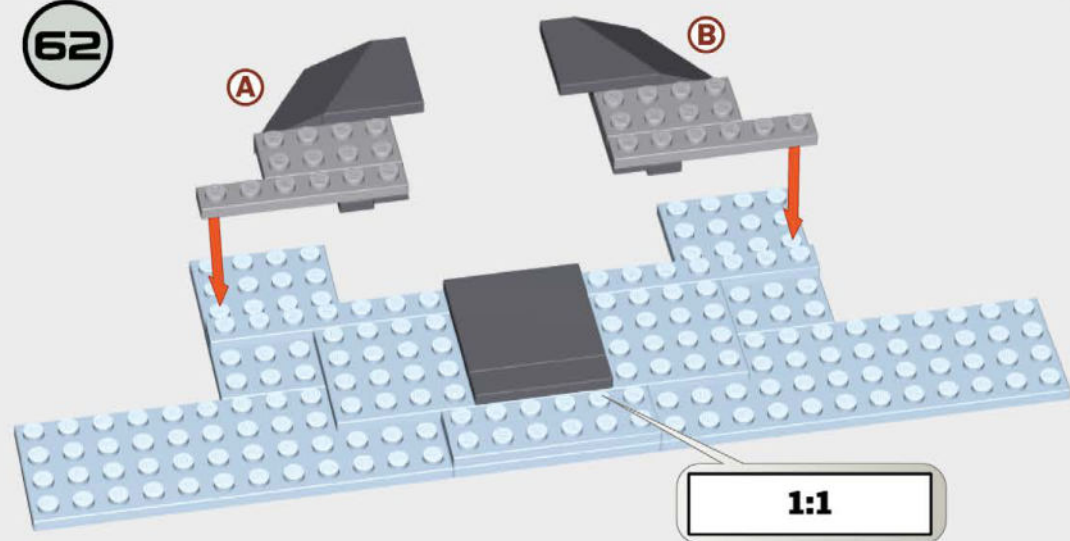

1:1



63

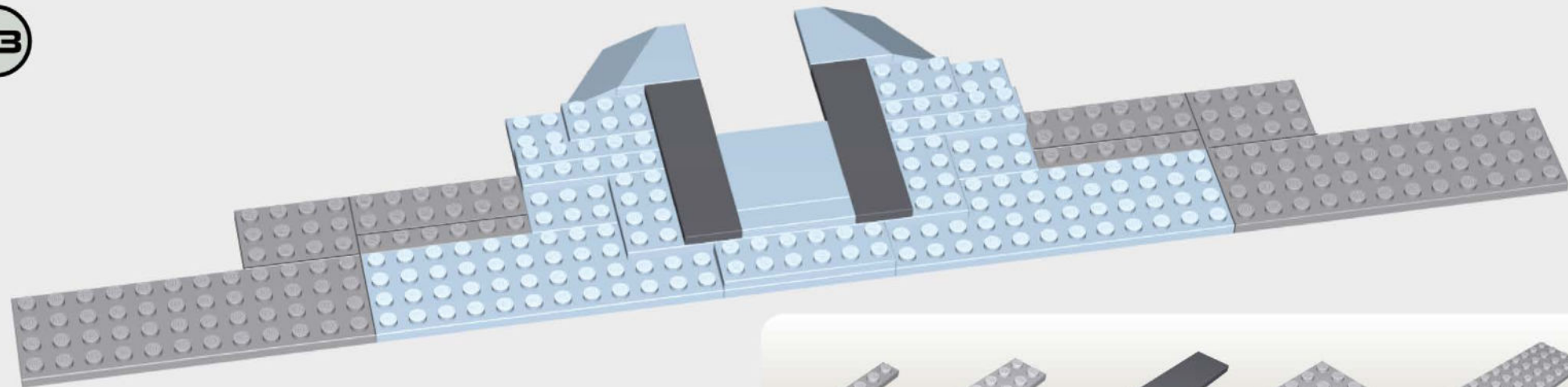

64

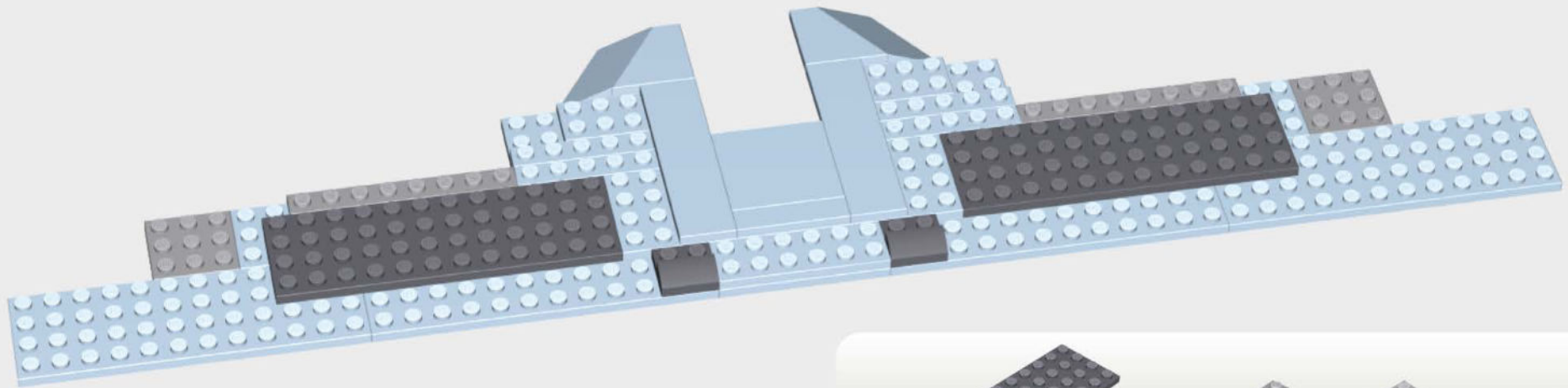

65

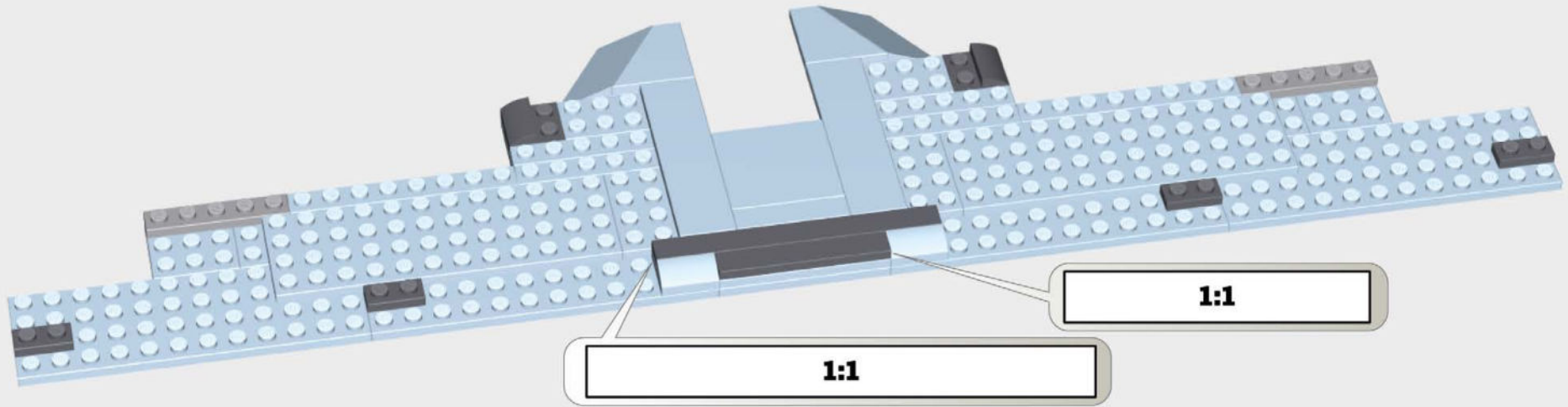

66

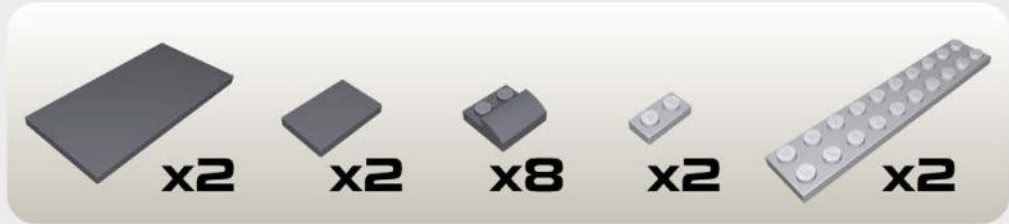
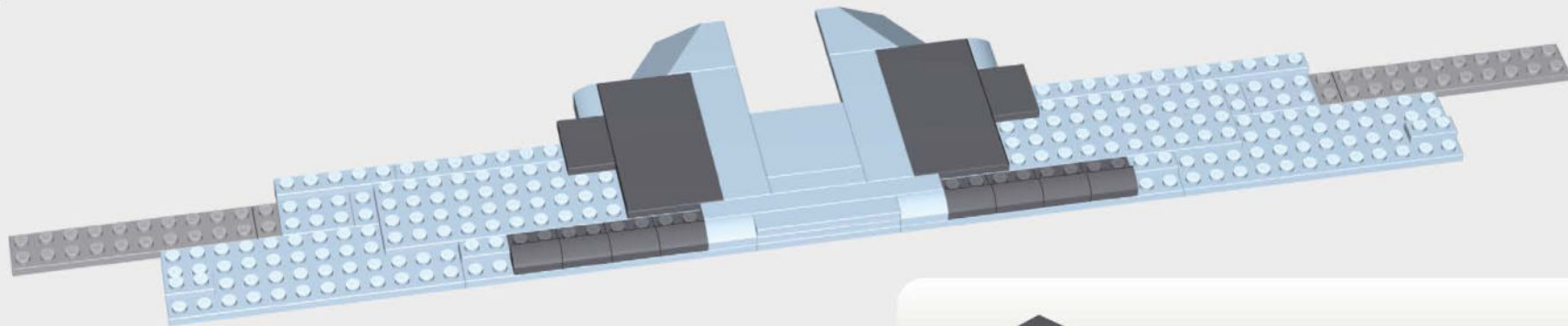



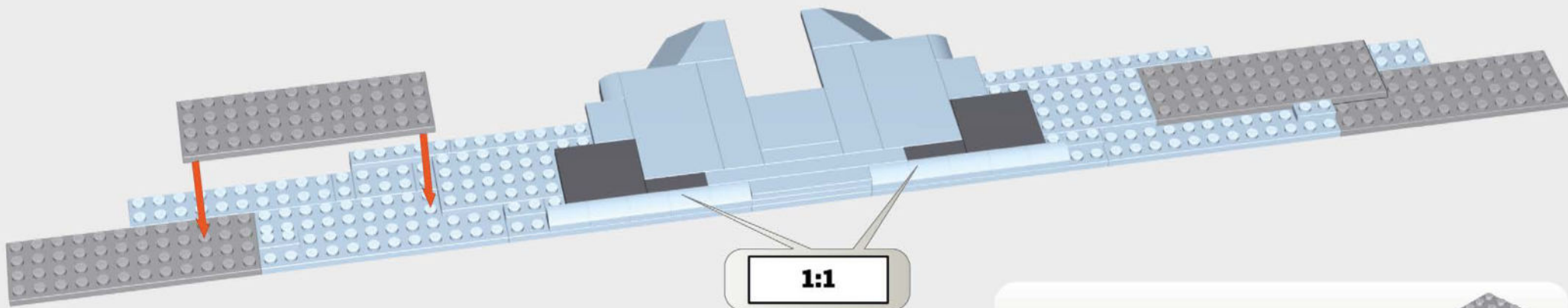

67

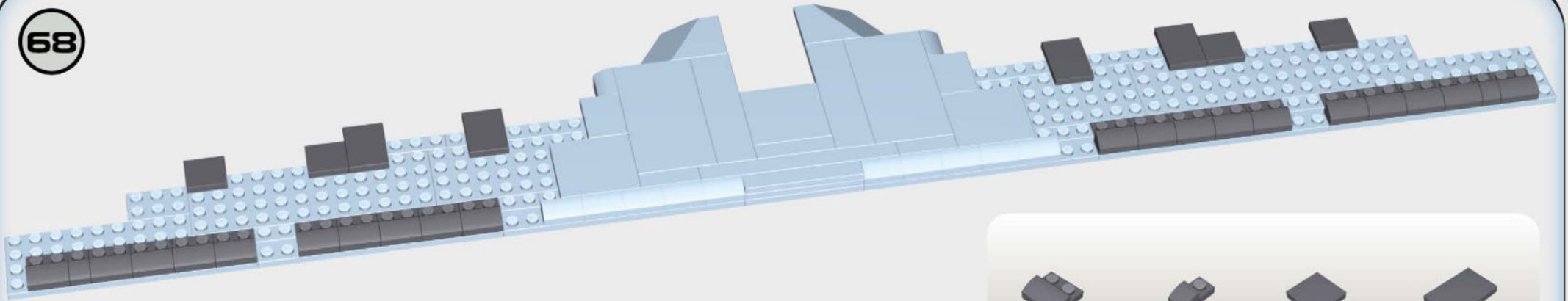







68

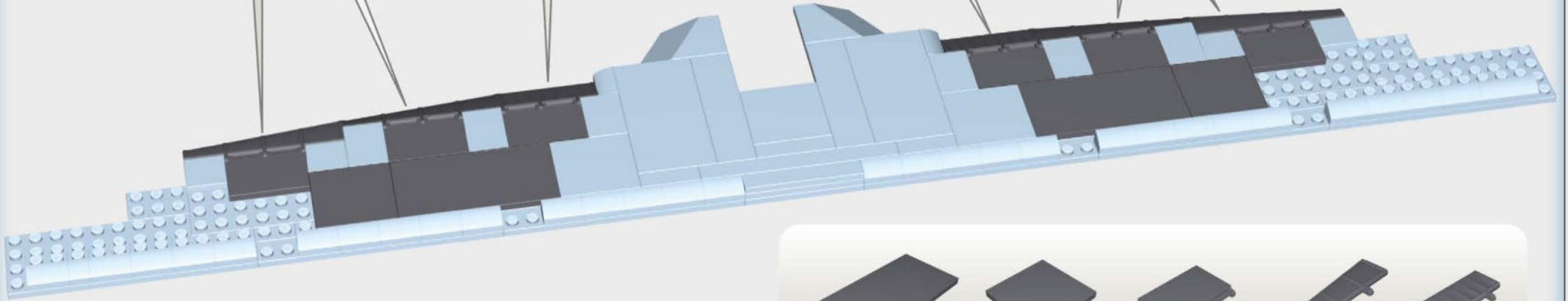

 **x20**
  **x2**
  **x4**
  **x4**

69



 **x2**
  **x2**
  **x6**
  **x4**
  **x2**

70

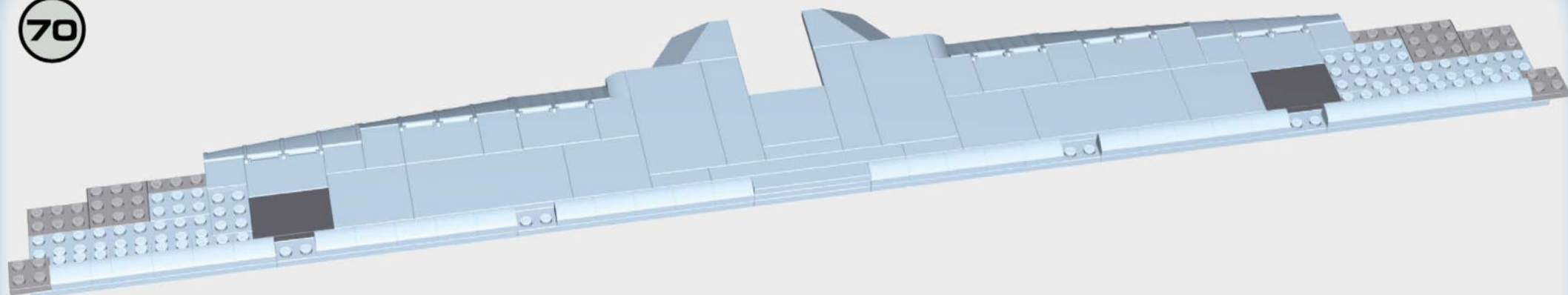

x2



x2



x2



x2



x2

71

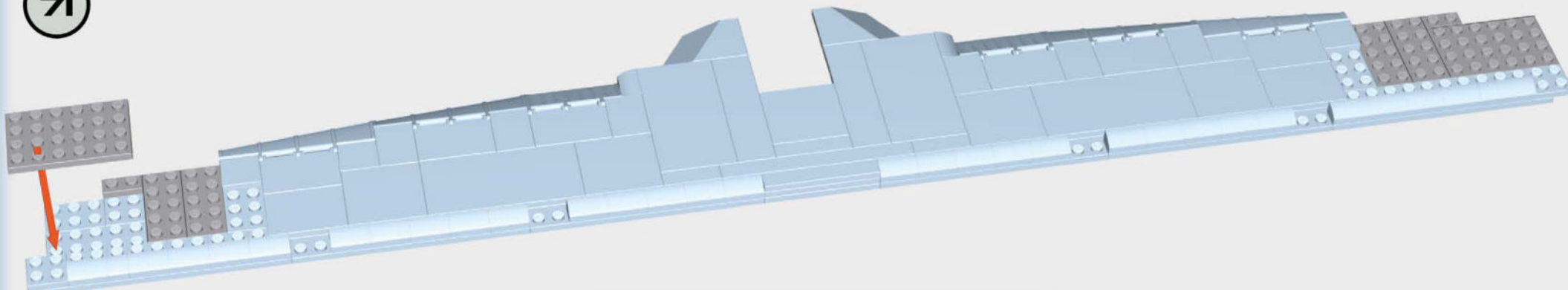

x4



x2



x2

72

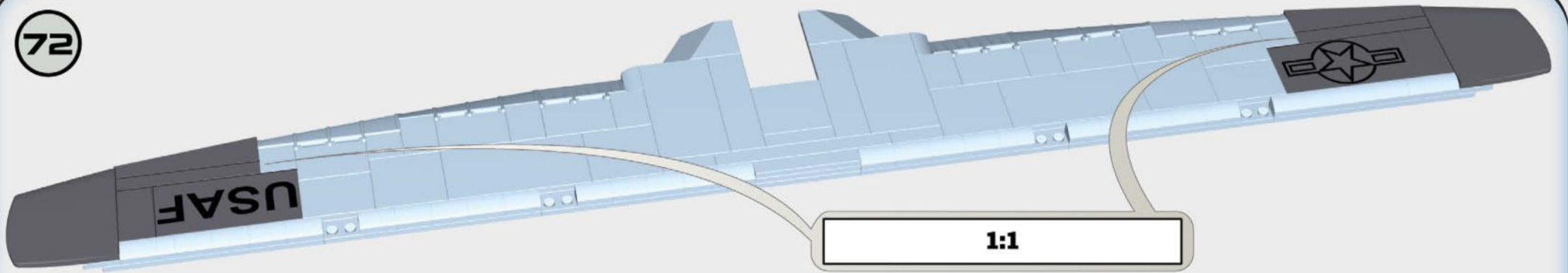

1:1



73 = 75
x4

73

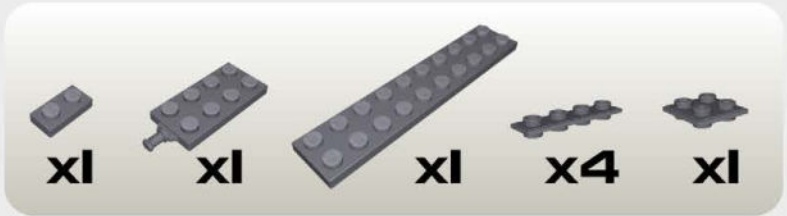
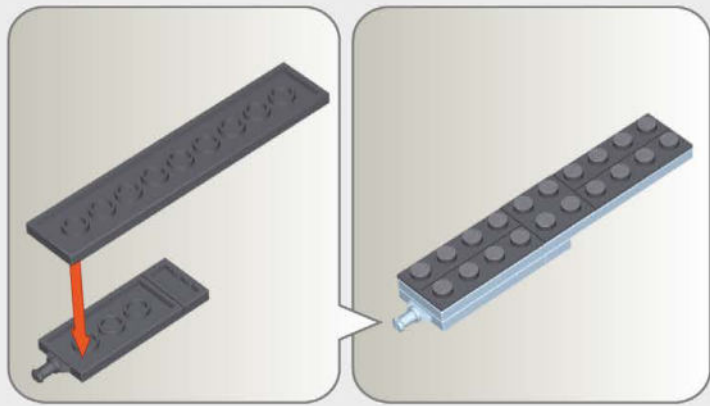

74

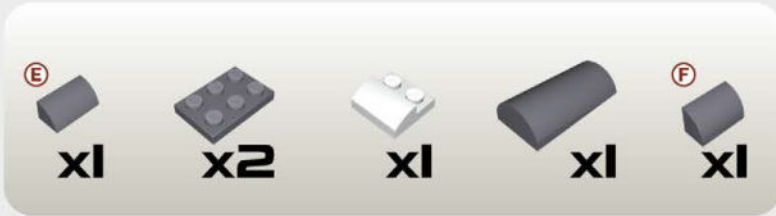
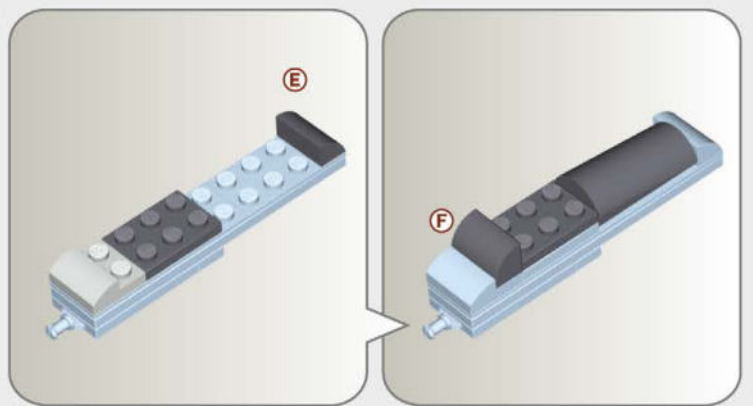

75

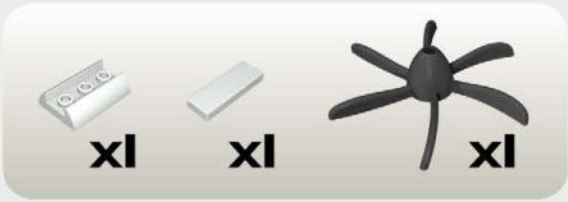
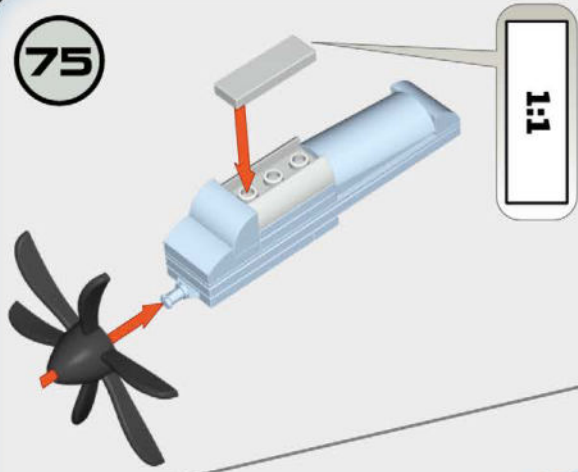

76

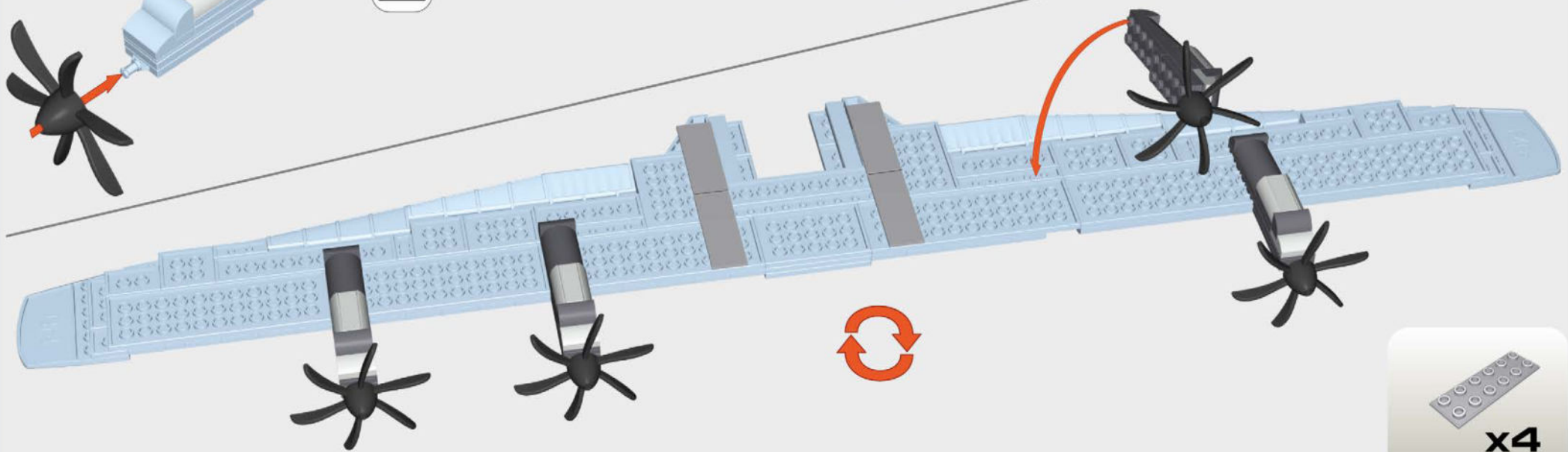

77

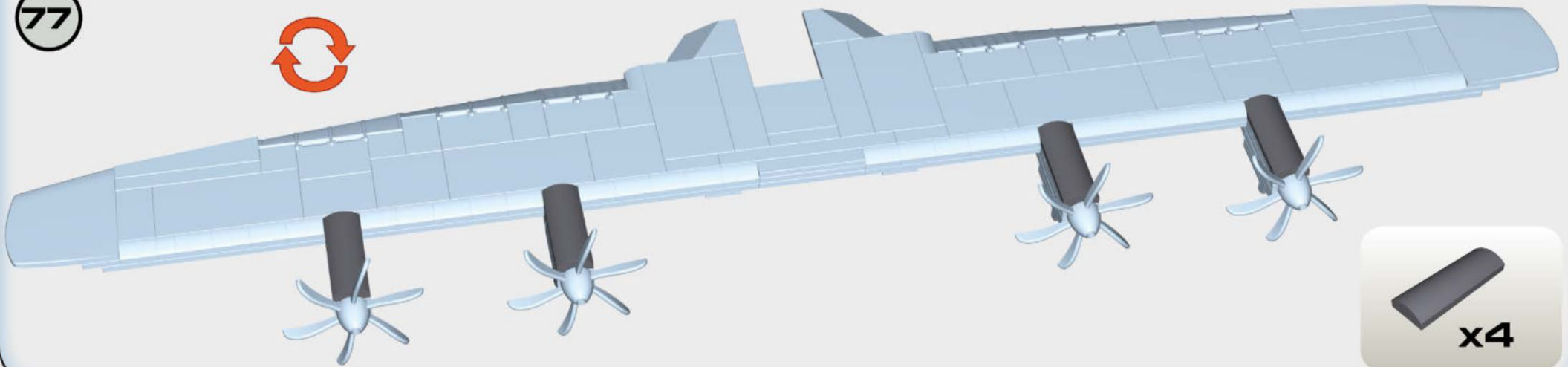

78

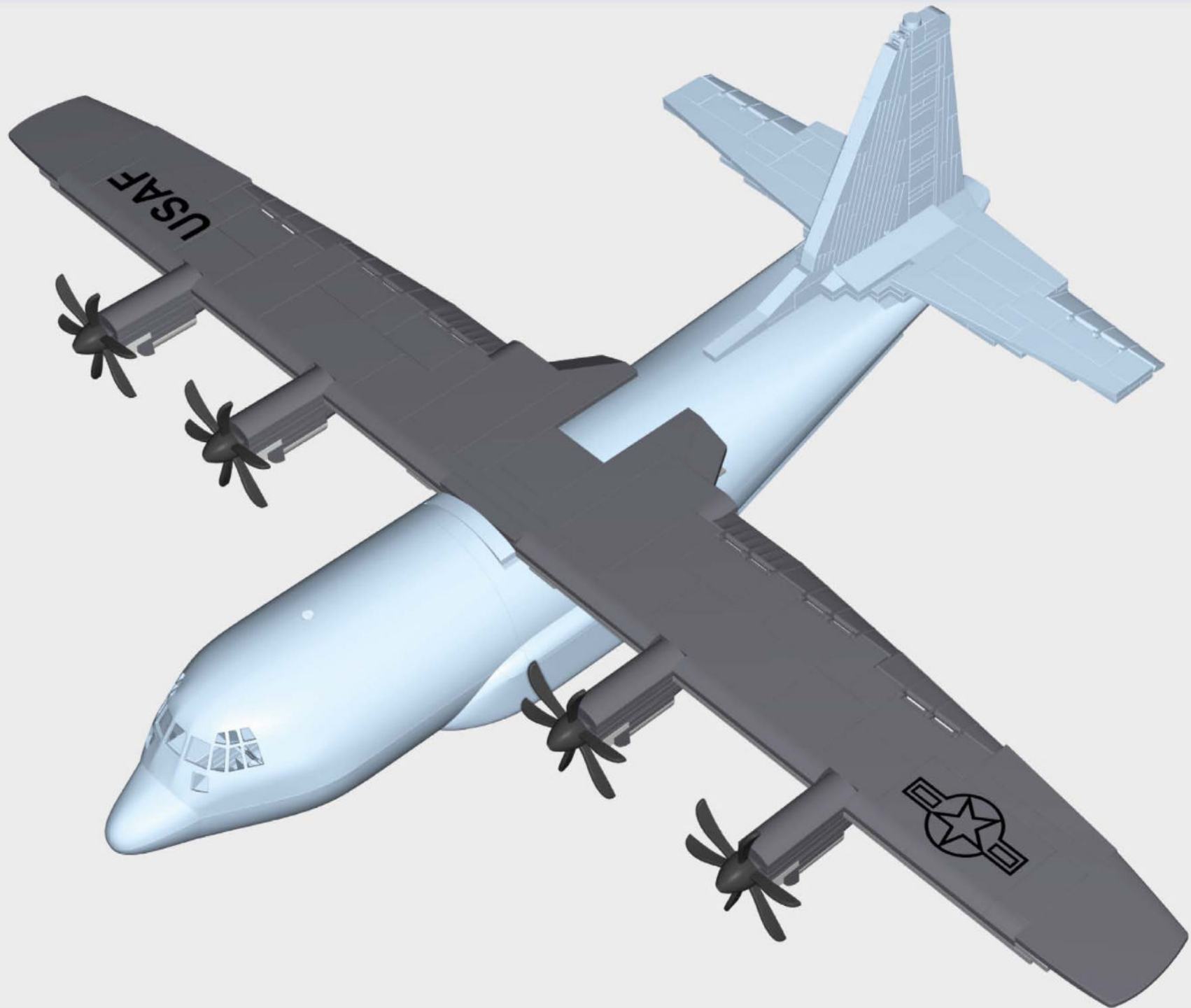

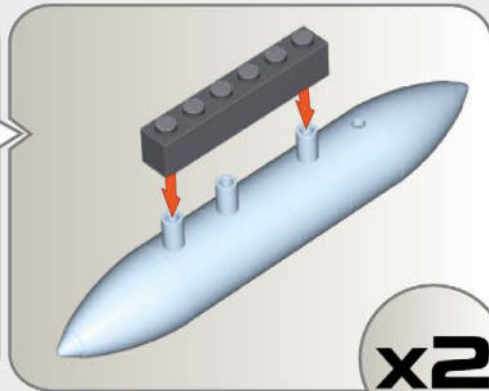
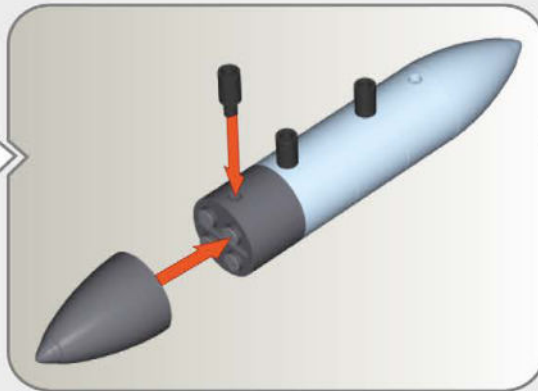
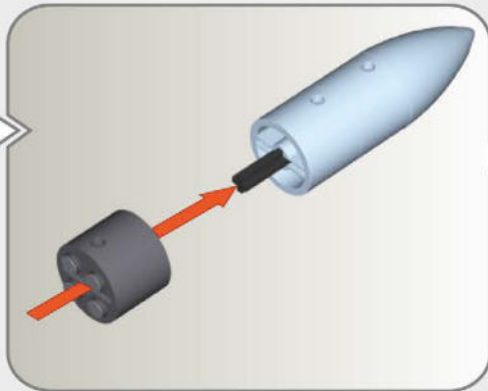
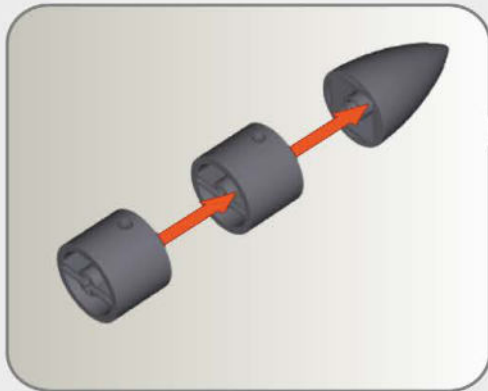

x2



80

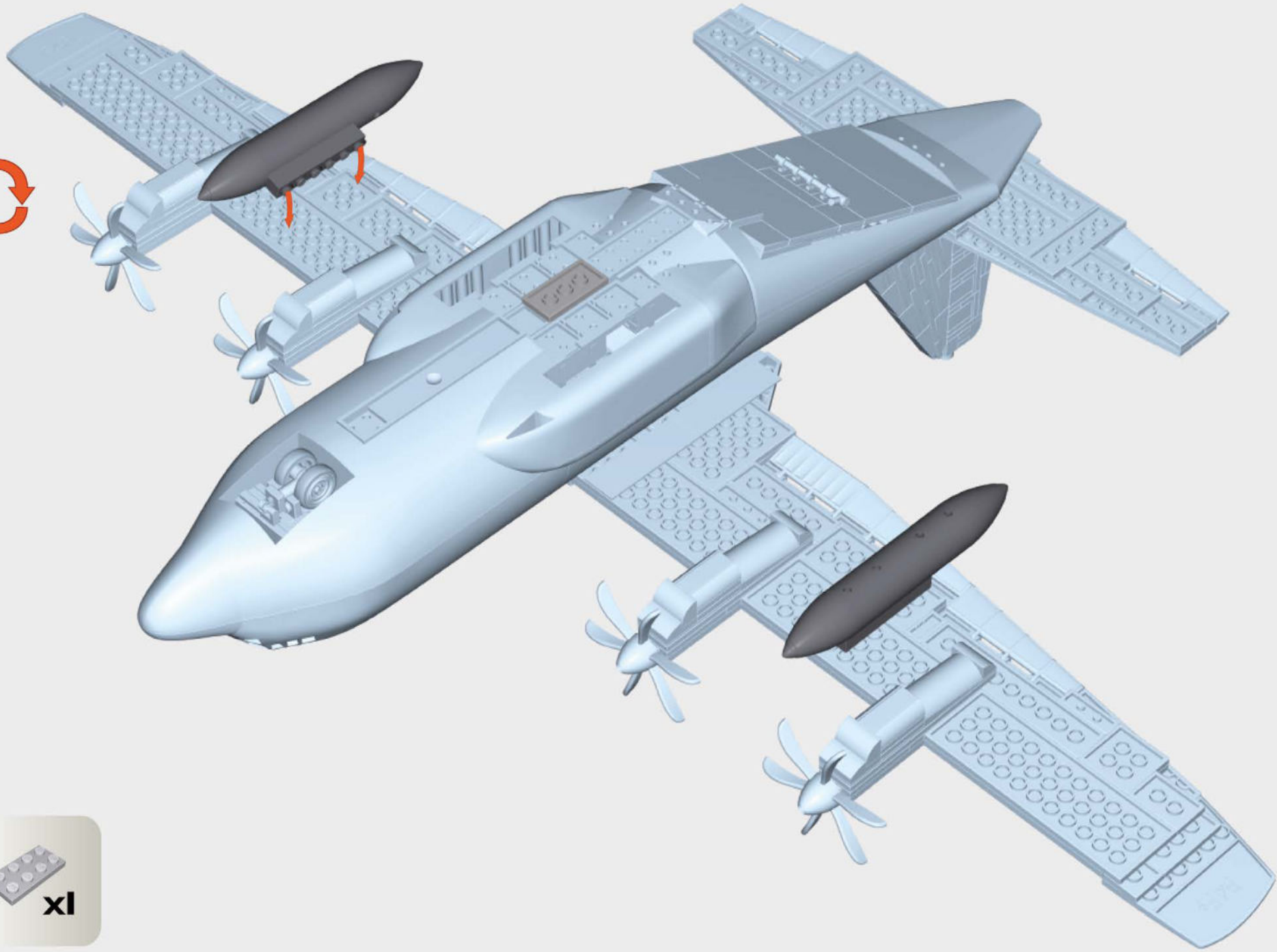

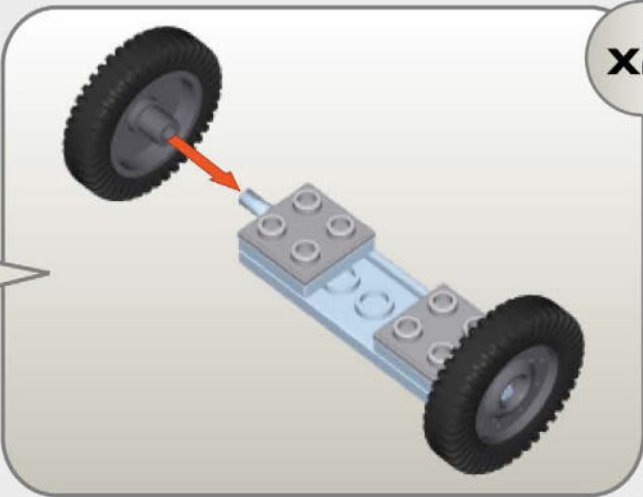
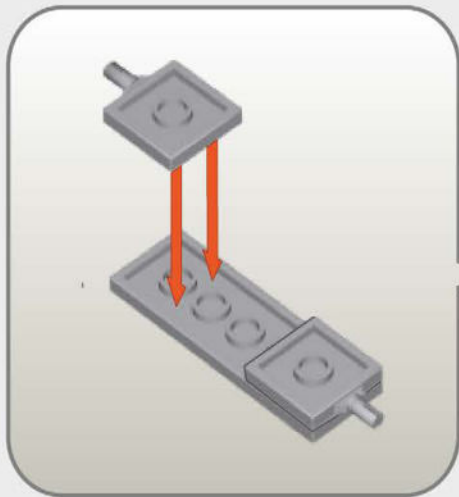

x2



x4



x2



x4



x4







x4



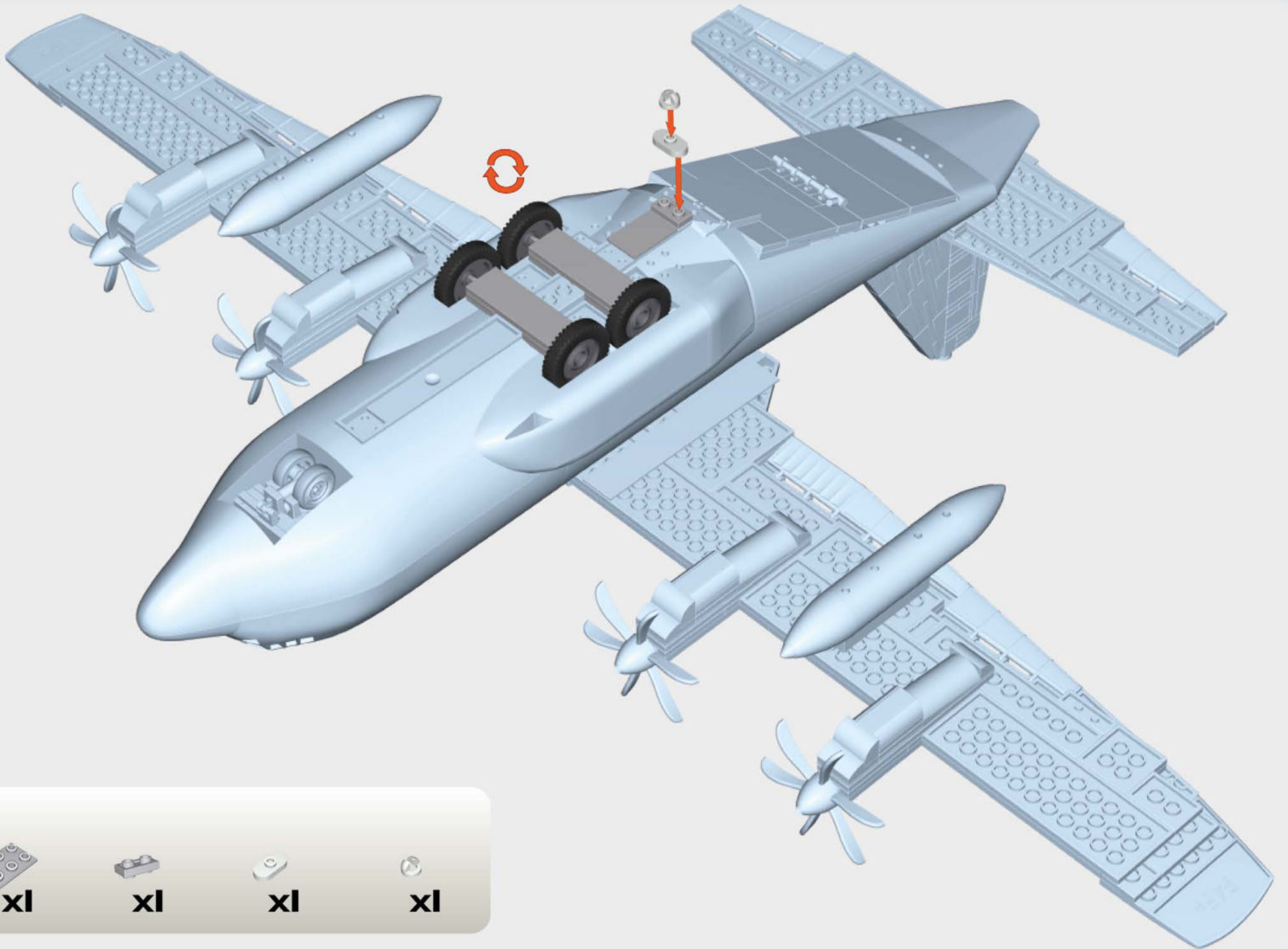





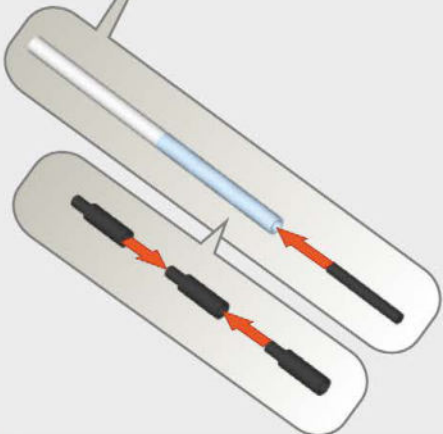
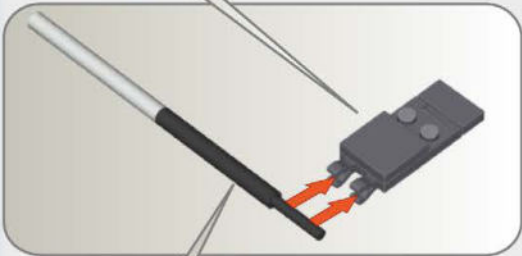
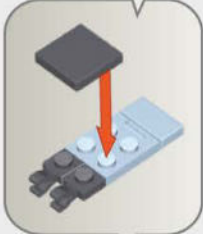

x4

82



-  **x1**
-  **x1**
-  **x1**
-  **x1**



-  x1
-  x1
-  x2
-  x1
-  x3
-  x1
-  x1

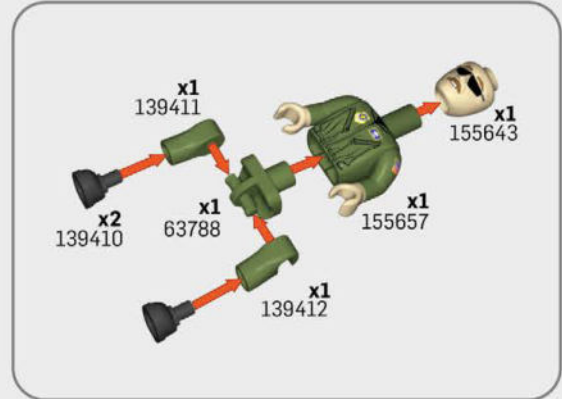
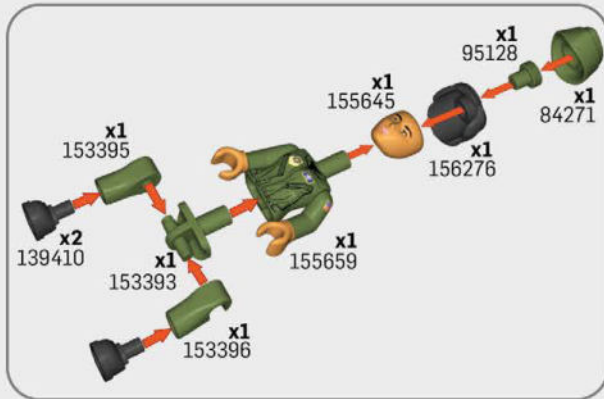
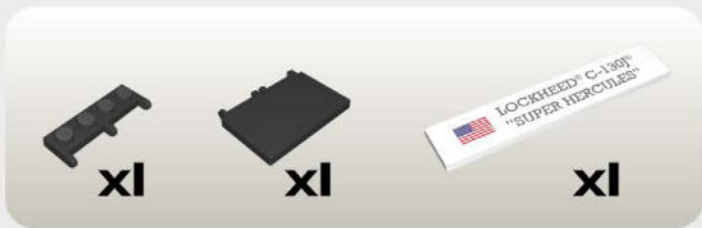
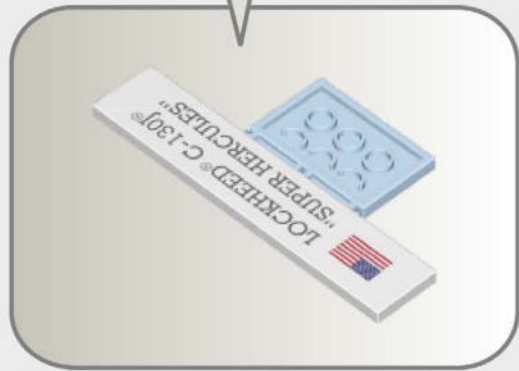
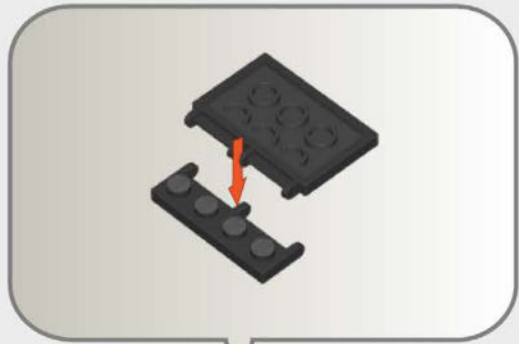

x4 155729	x2 133318	x7 54631	x2 77422	x6 143576	x2 150744	x1 42880
x4 52994	x1 98822	x1 137666	x1 53330	x1 94448	x4 45501	x4 97658
x2 155730	x1 42861	x1 105327	x1 95106	x1 85912	x1 57535	x1 155661
x1 132144	x1 132145	x1 111084	x2 155877	x20 51554	x8 43671	x2 57219
x1 43922	x1 155733	x1 155669	x2 51590	x2 110376	x3 51591	x3 43673
x1 127064	x3 51589	x1 155666	x1 155667	x1 155668	x4 112151	x4 57129

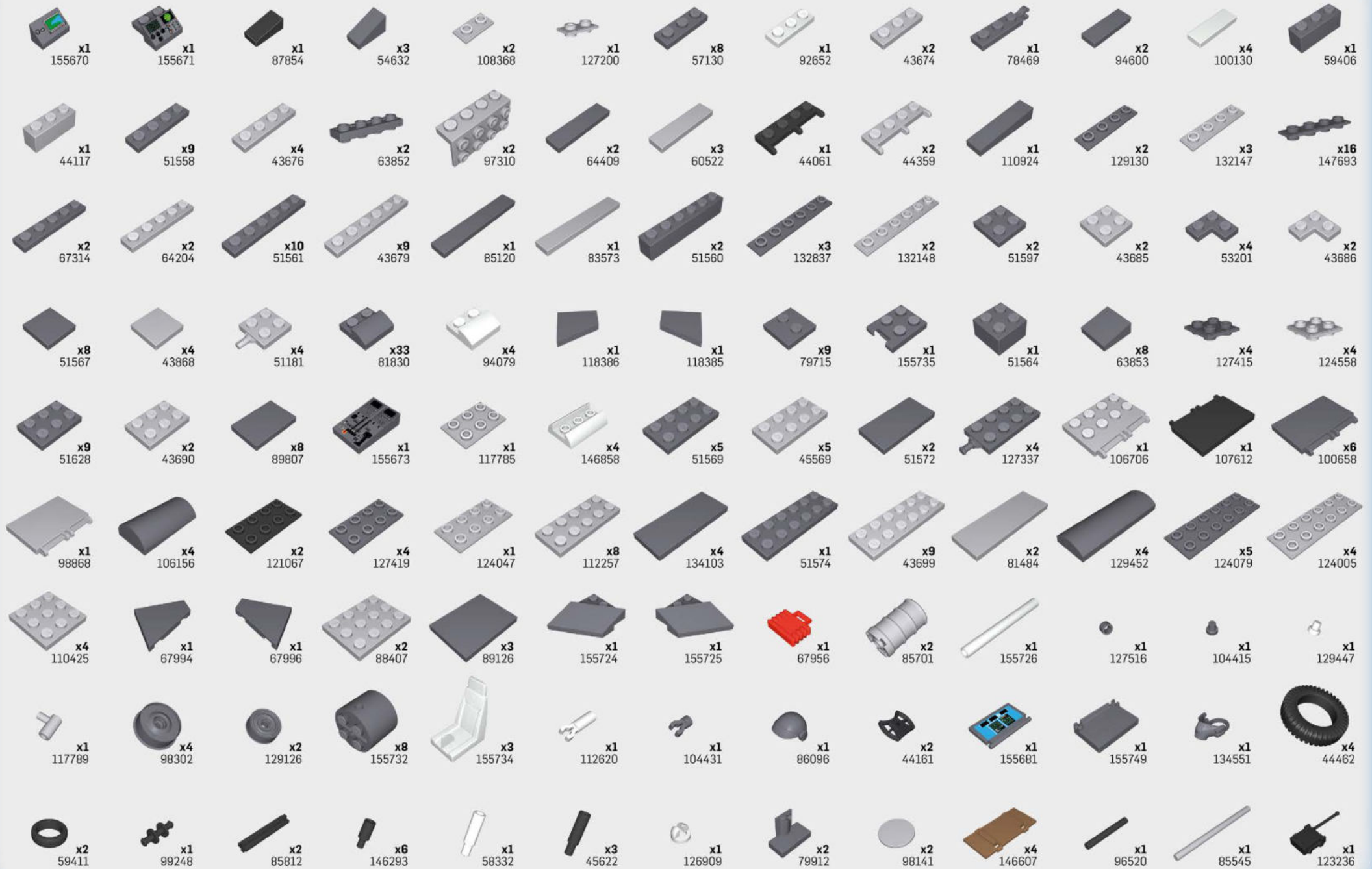

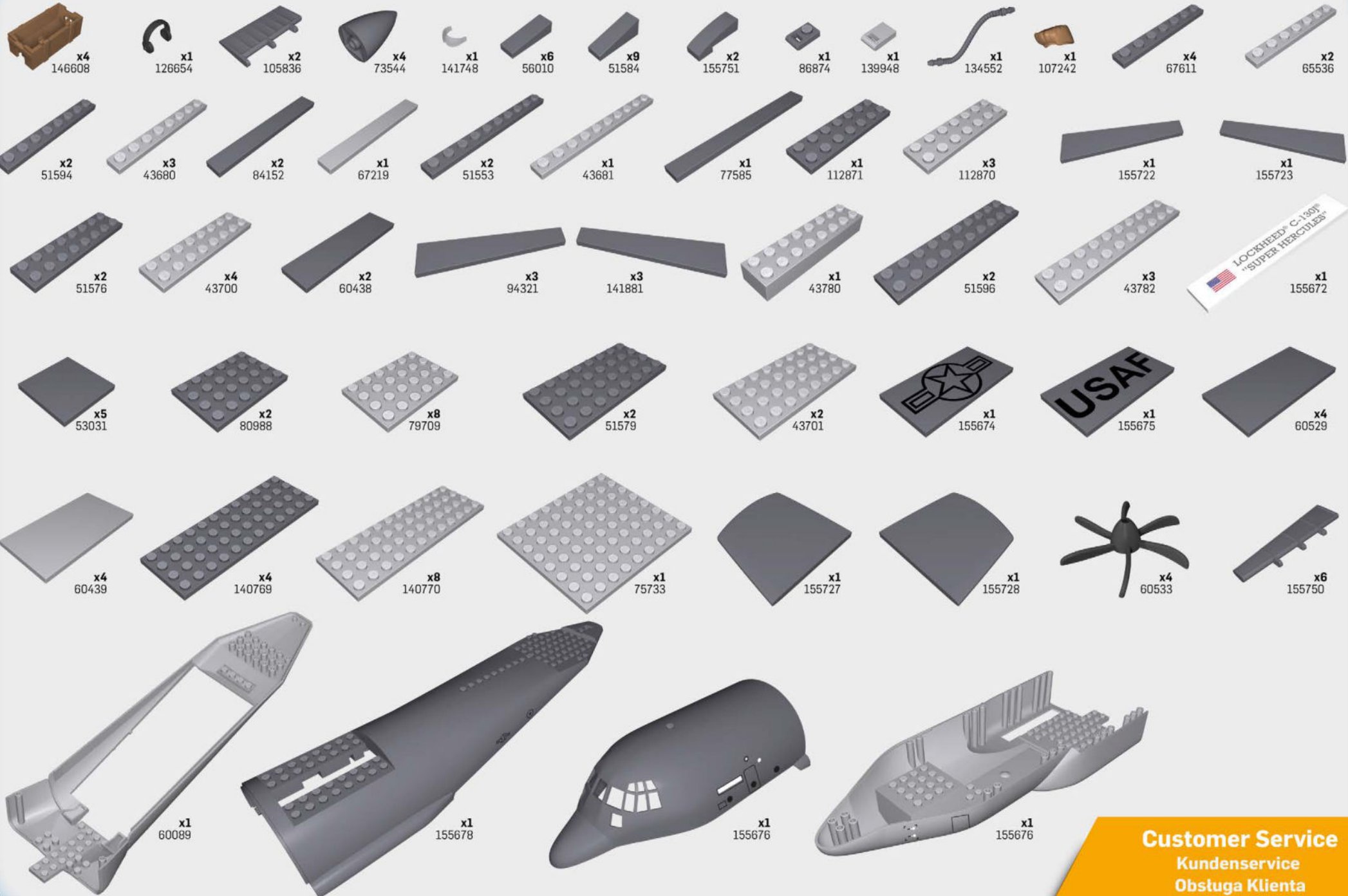

Customer Service
 Kundenservice
 Obsługa Klienta
www.cobi.eu/service



HISTORICAL COLLECTION



FOCKE-WULF FW 190 A-3
+ 5741



FOCKE-WULF FW 190 A5
+ 5722



PZL P.11c
+ 5742



P-47 THUNDERBOLT™
⊕ 5737

NORTHROP GRUMMAN



**DASSAULT
AVIATION**



**ALPHA JET
5842**



**F-35®A LIGHTNING II®
5832**

LOCKHEED MARTIN 

LOCKHEED MARTIN®, F-35®A Lightning II®, associated emblems and logos, and body designs of vehicles are either registered trademarks or trademarks of Lockheed Martin Corporation in the USA and/or other jurisdictions, used under license by COBI.



**F-35®A LIGHTNING II®
5831**

LOCKHEED MARTIN 

LOCKHEED MARTIN®, F-35®B Lightning II®, associated emblems and logos, and body designs of vehicles are either registered trademarks or trademarks of Lockheed Martin Corporation in the USA and/or other jurisdictions, used under license by COBI.



**HERCULES® C-130® HERCULES®
5839**

LOCKHEED MARTIN 

LOCKHEED MARTIN®, C-130® HERCULES®, associated emblems and logos, and body designs of vehicles are either registered trademarks or trademarks of Lockheed Martin Corporation in the USA and/or other jurisdictions, used under license by COBI.



**F-35®B LIGHTNING II®
5830**



NORTHROP GRUMMAN

A-10 THUNDERBOLT II™ WARTHOG®
5837



BELL™ BOEING™ V-22 OSPREY™
5836



LOCKHEED MARTIN

LOCKHEED MARTIN®, F-35®B Lightning II®, associated emblems and logos, and body designs of vehicles are either registered trademarks or trademarks of Lockheed Martin Corporation in the USA and/or other jurisdictions, used under license by COBI.



F-35® B LIGHTNING II®
5829



BELL™ BOEING™ V-22 OSPREY™
„FIRST FLIGHT EDITION“
5835



Produced under license. V-22 Osprey is a trademark jointly owned by Boeing and Textron Innovations Inc., and all the distinctive logos, product markings and trade dress are trademarks of Textron Innovations Inc. and The Boeing Company.

For news and special deals

WWW.COBIBRICKS.COM

17-05838-628

Find us on:



cobi.bricks
cobi.klocki

COBI SA