

HISTORICAL COLLECTION

WORLD WAR II



CROMWELL MK.IV
 IN BRITISH SERVICE - 1944 - 1950s
 PLACE OF ORIGIN - UNITED KINGDOM
 TYPE - CRUISER TANK
 WEIGHT - 28t (61,729LB)
 ARMOUR - 76mm (3") MAXIMUM
 ENGINE - ROLLS-ROYCE METEOR
 V12 PETROL 600HP (441KW)
 ARMAMENT - 1x ORDNANCE QF 75mm (2.95")
 2x 7,92mm (.312") BESA MG
 SPEED - 64KM/H (40MPH)
 RANGE - 270KM (170MI)
 CREW - 5



2269

PAD PRINTED
NO STICKERS

Printed in EU



WARNING: CHOKING HAZARD-
 Toy contains small parts.
 Not for children under 3 years.

544  1 

CROMWELL MK. IV

SCALE 1:35



1

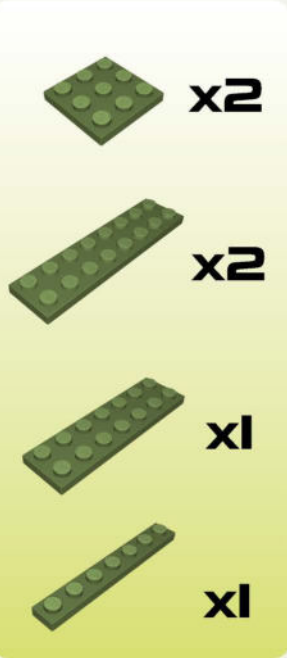
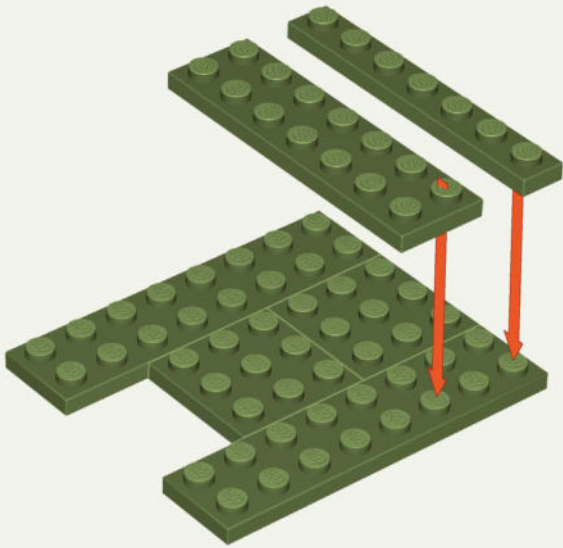

2

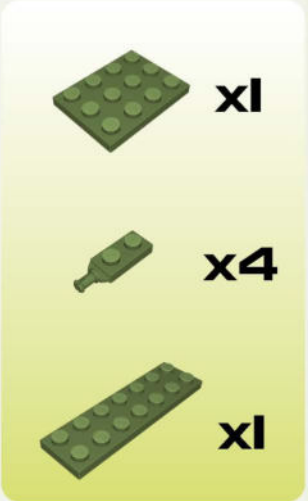
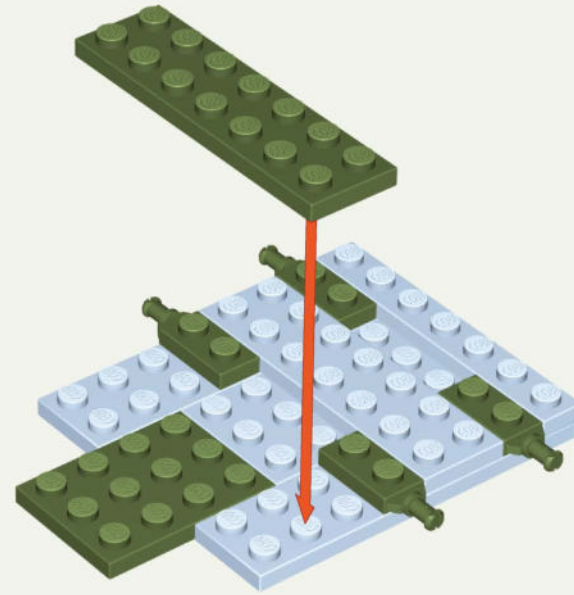

3

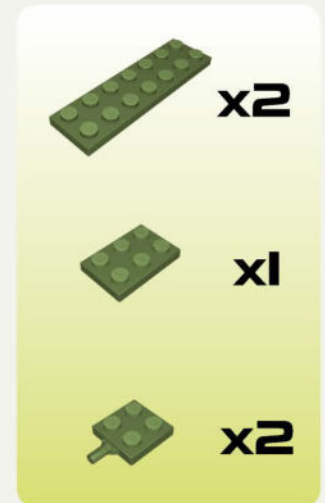
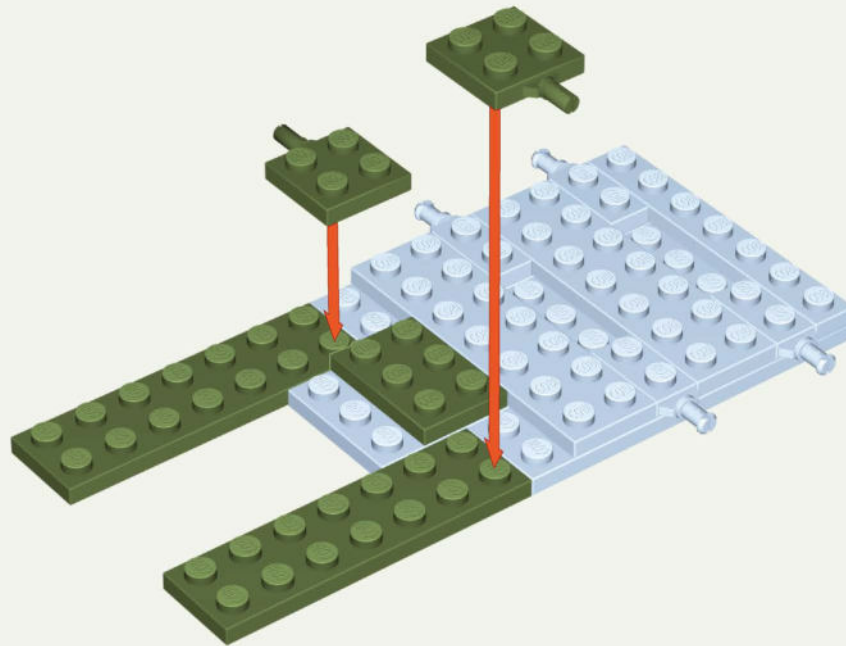

BE CAREFUL: NOTICE THE DIFFERENCE

A



B



4

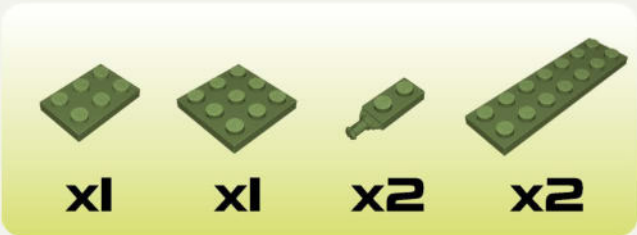
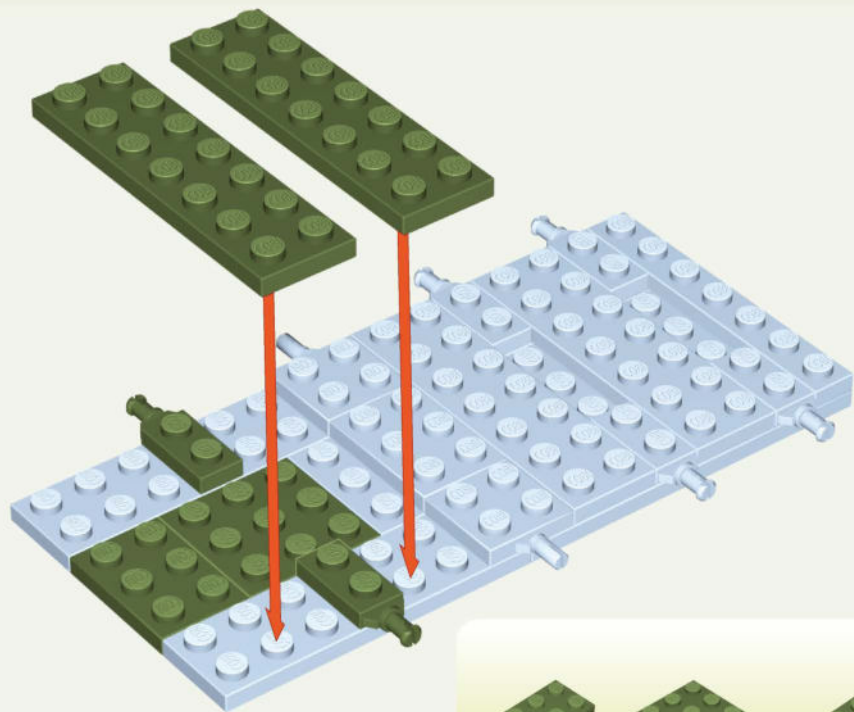

5

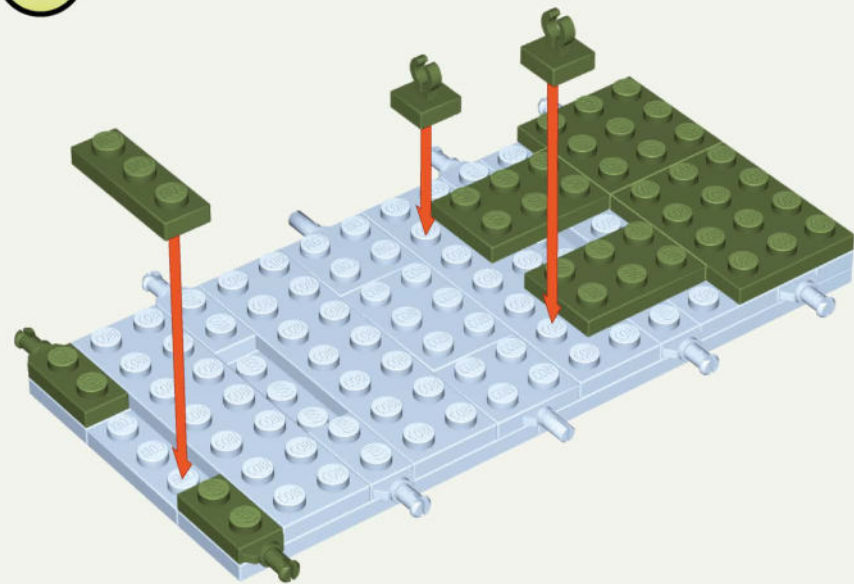

6

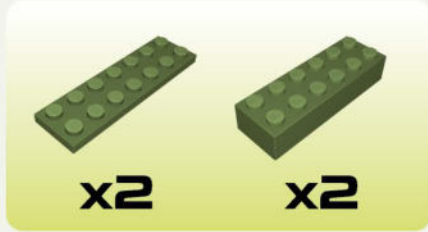
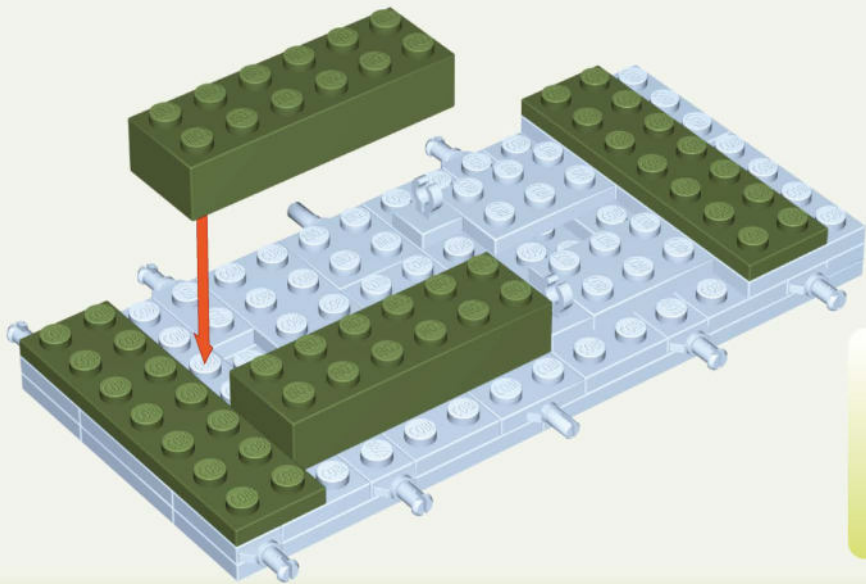

7

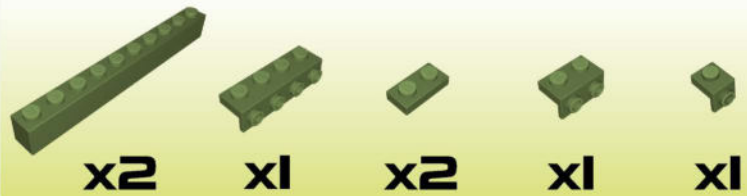
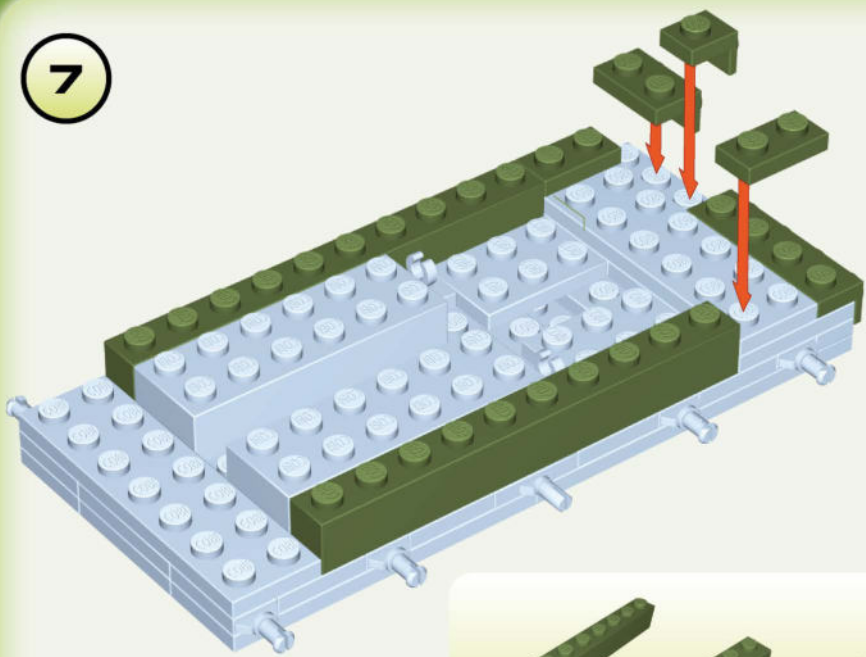

8

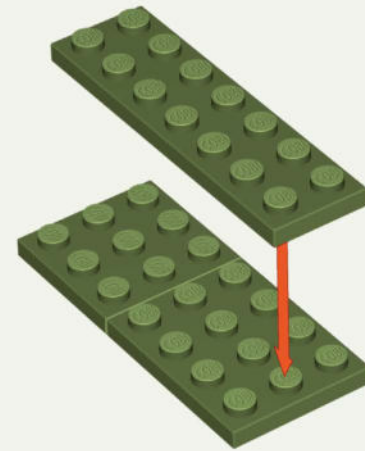

9

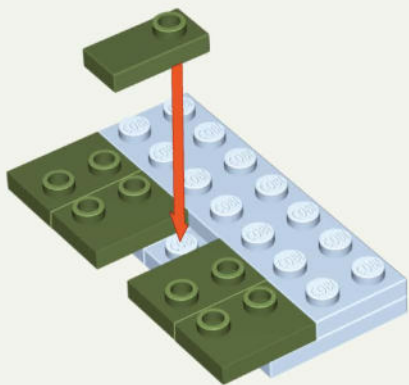

10

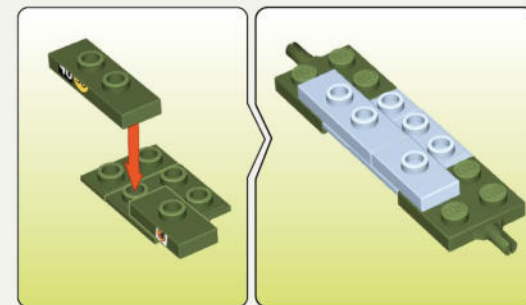
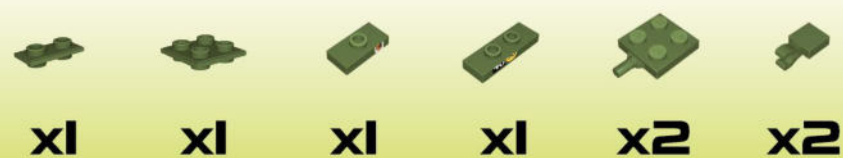
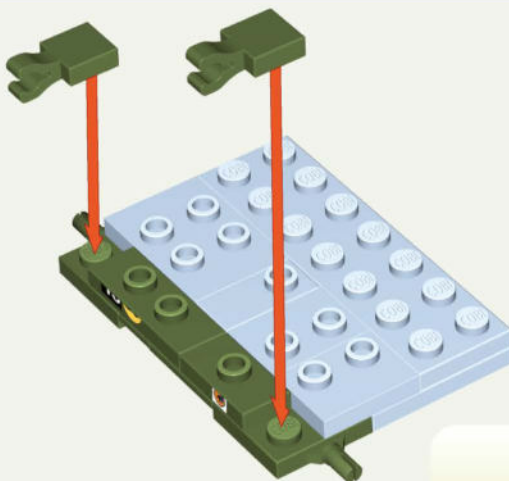

11

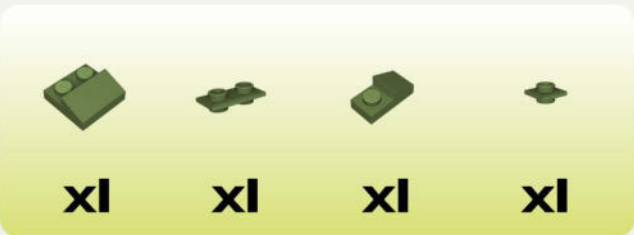
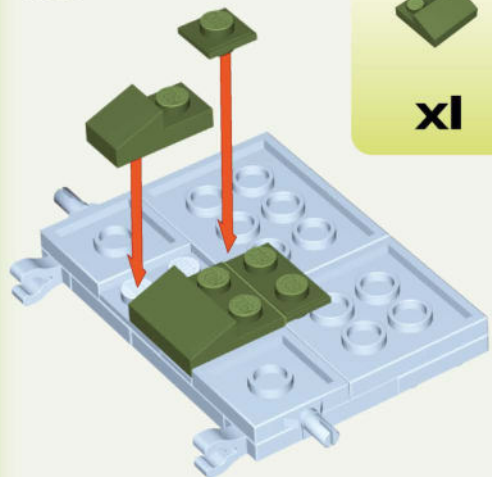

12

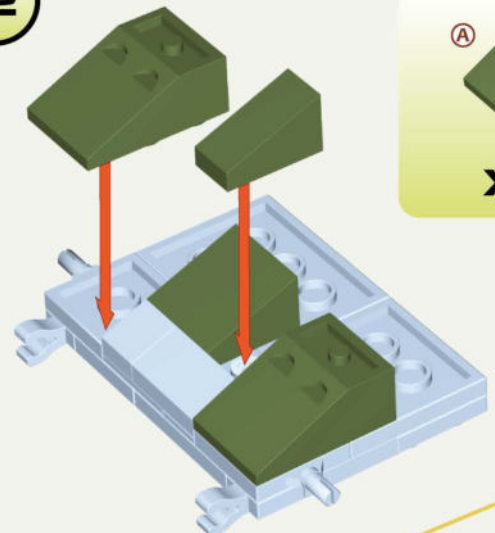

13

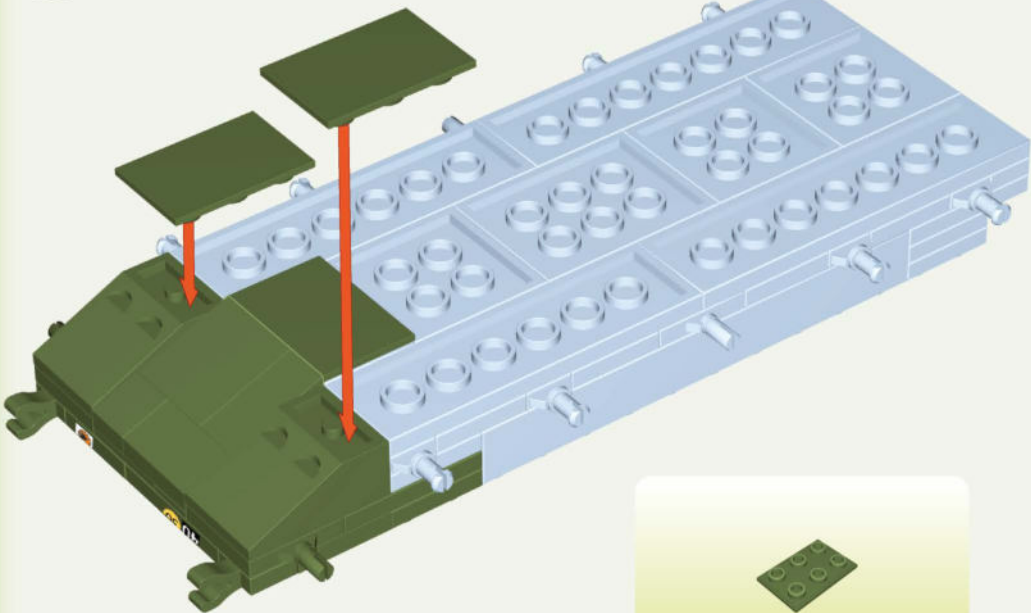



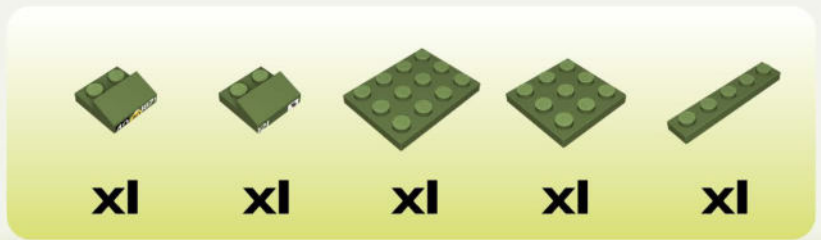
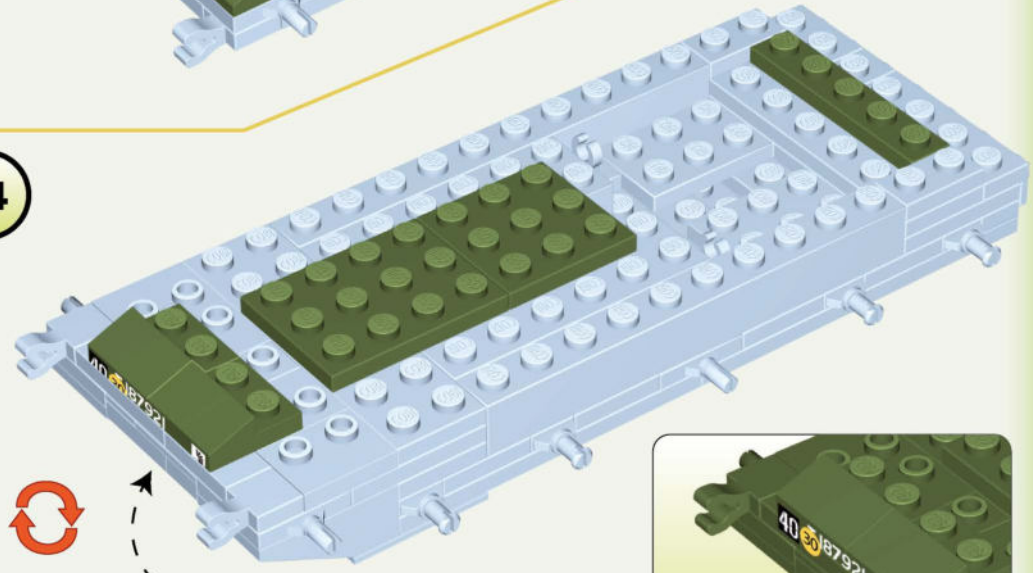

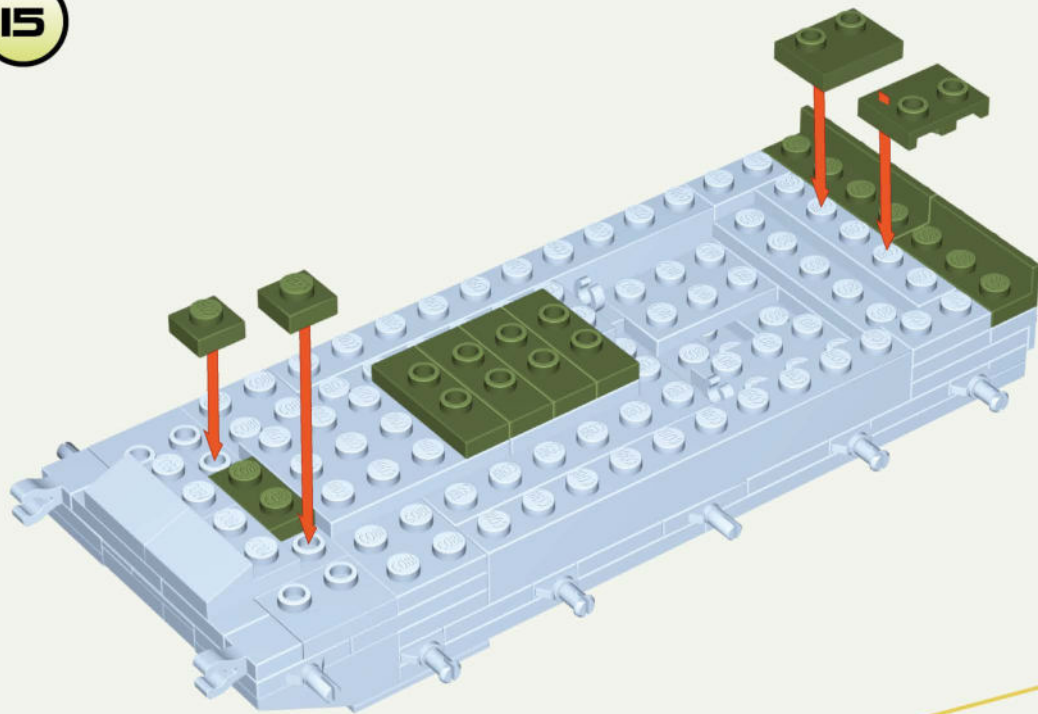

14







15



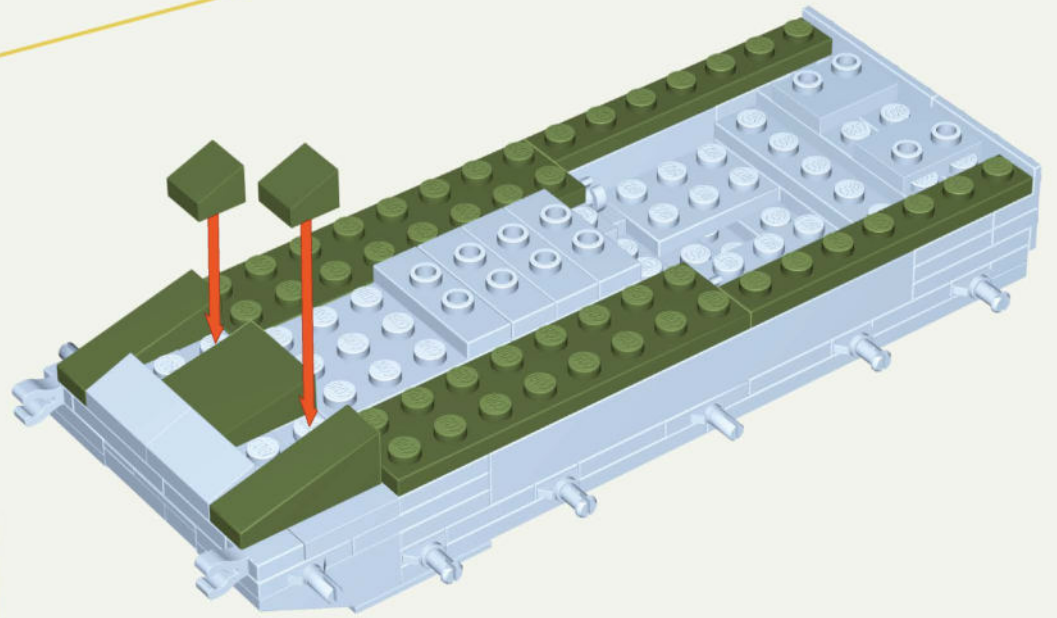



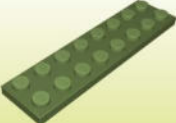

					
x1	x1	x4	x1	x2	x2

16



				
x1	x2	x2	x2	x2

17

			
x1	x2	x2	
			
x2	x2	x2	x1

1:1



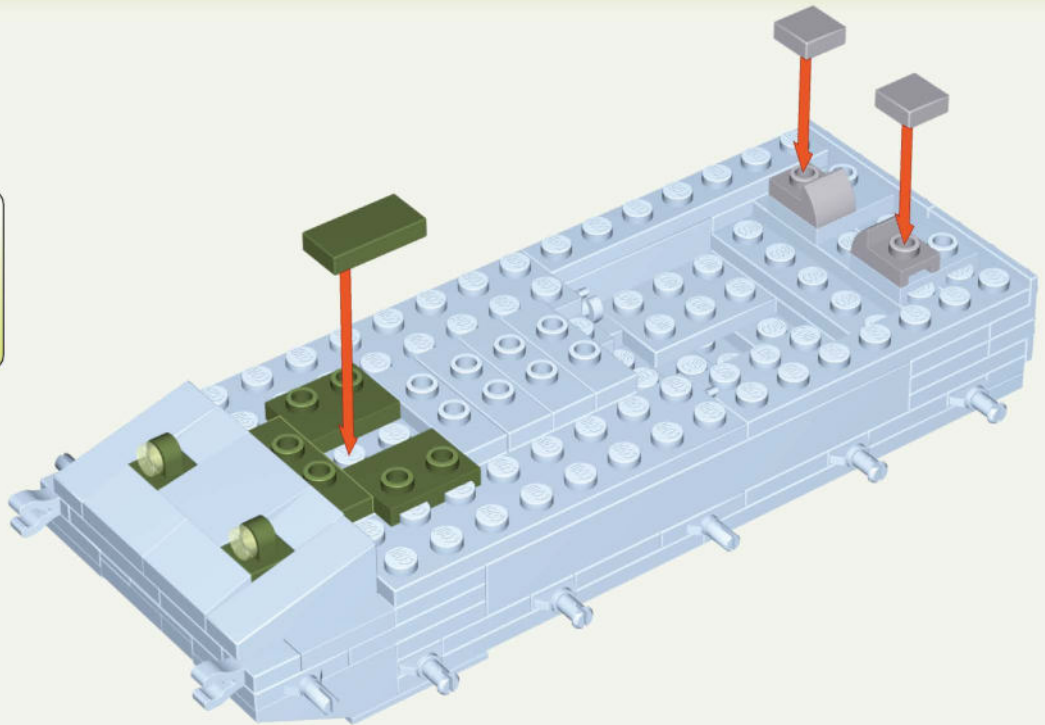

x2



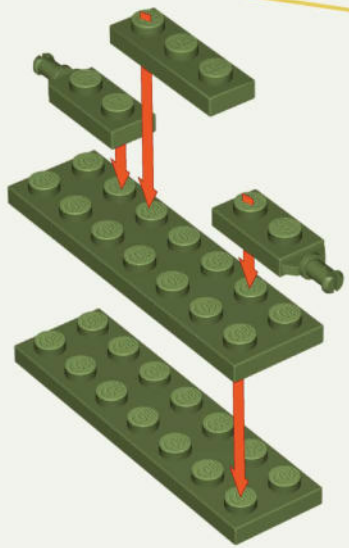



18

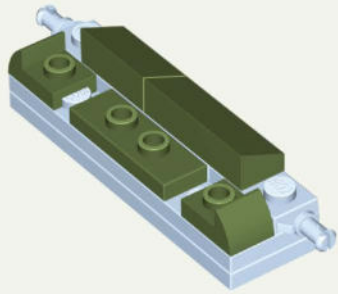

		
x2	x2	x1



19

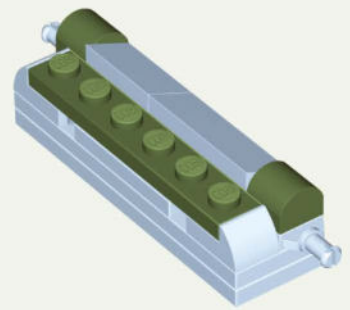

			
x1	x1	x2	x1

20



	
x2	x1

21

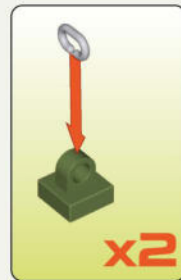
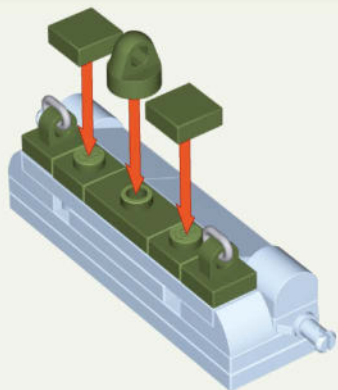

- | | | |
|-----------|-----------|-----------|
| | | |
| x1 | x2 | x2 |
| | | |
| x2 | x1 | x2 |

22



23

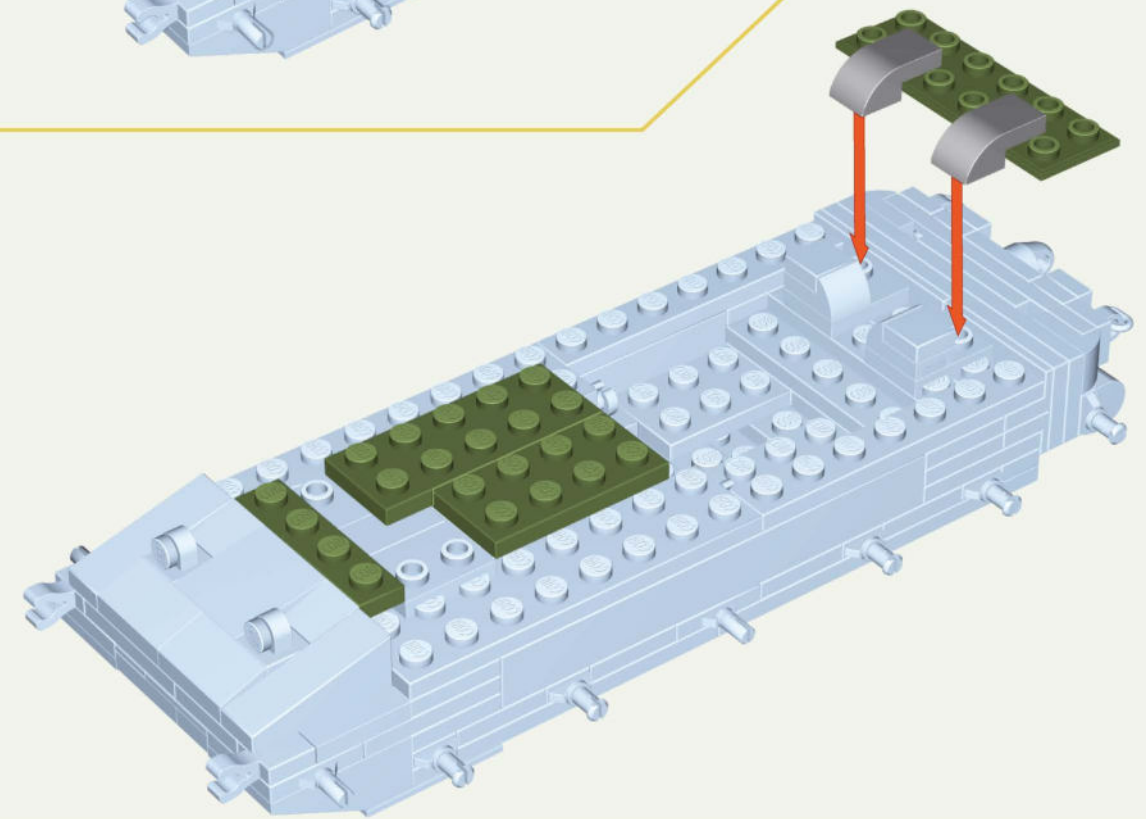

- | | | |
|-----------|-----------|-----------|
| | | |
| x1 | x1 | x1 |
| | | |
| x2 | x1 | |

24

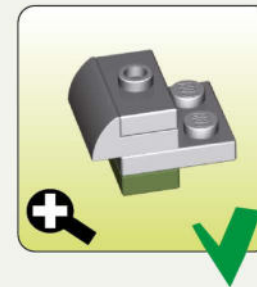
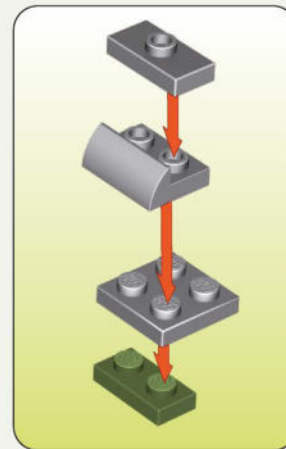
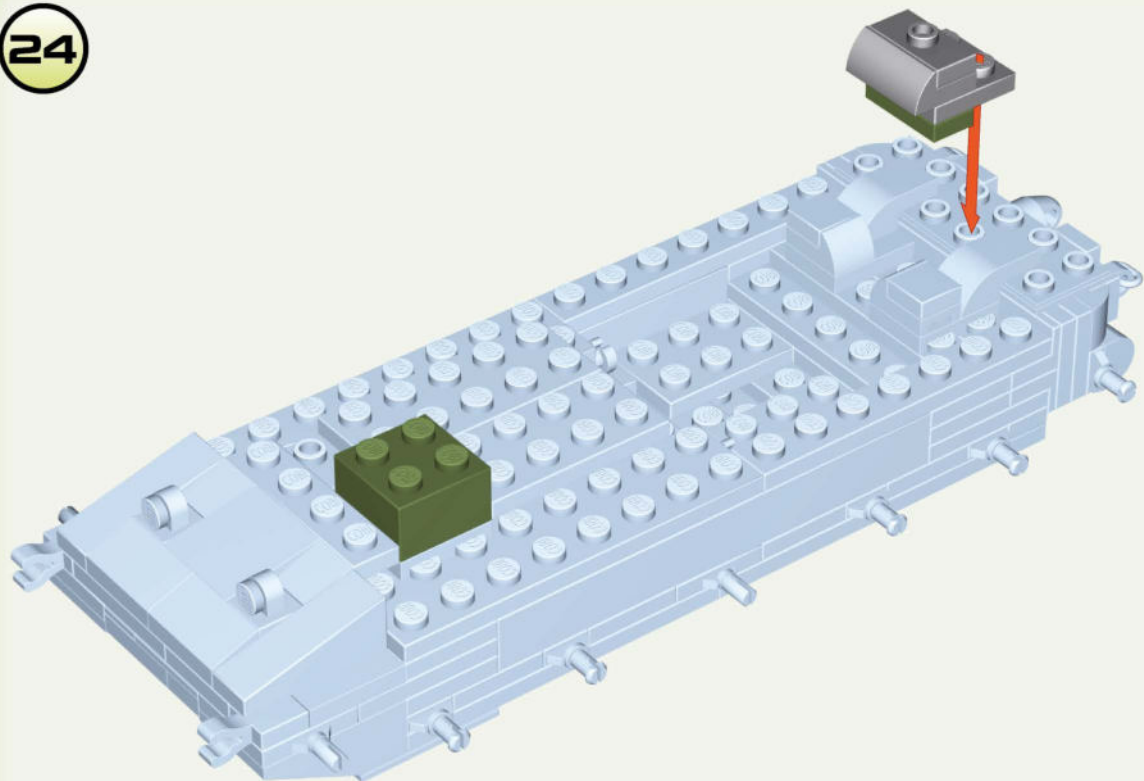

x1



x1



x1



x1



x1

25

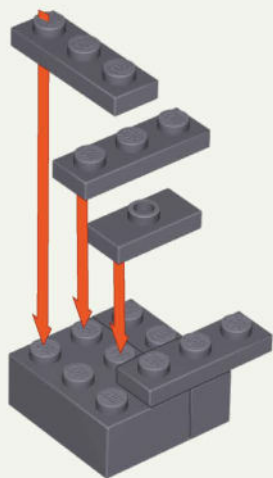

x1



x1



x3



x1

26

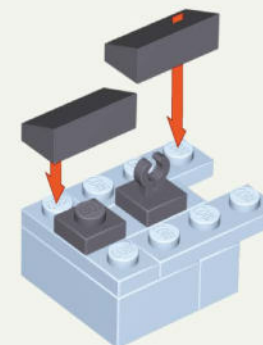

x1



x1



x2

27

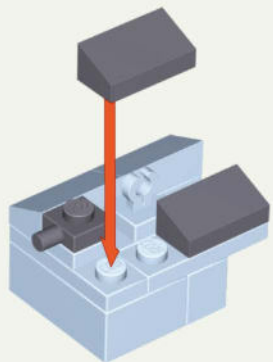

x1



x2

28

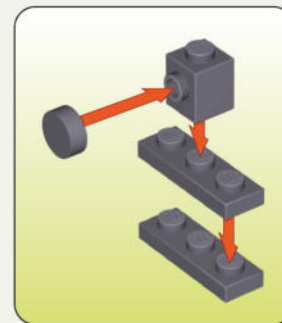
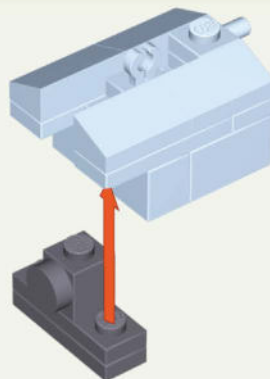

x2



x1



x1

29



x2

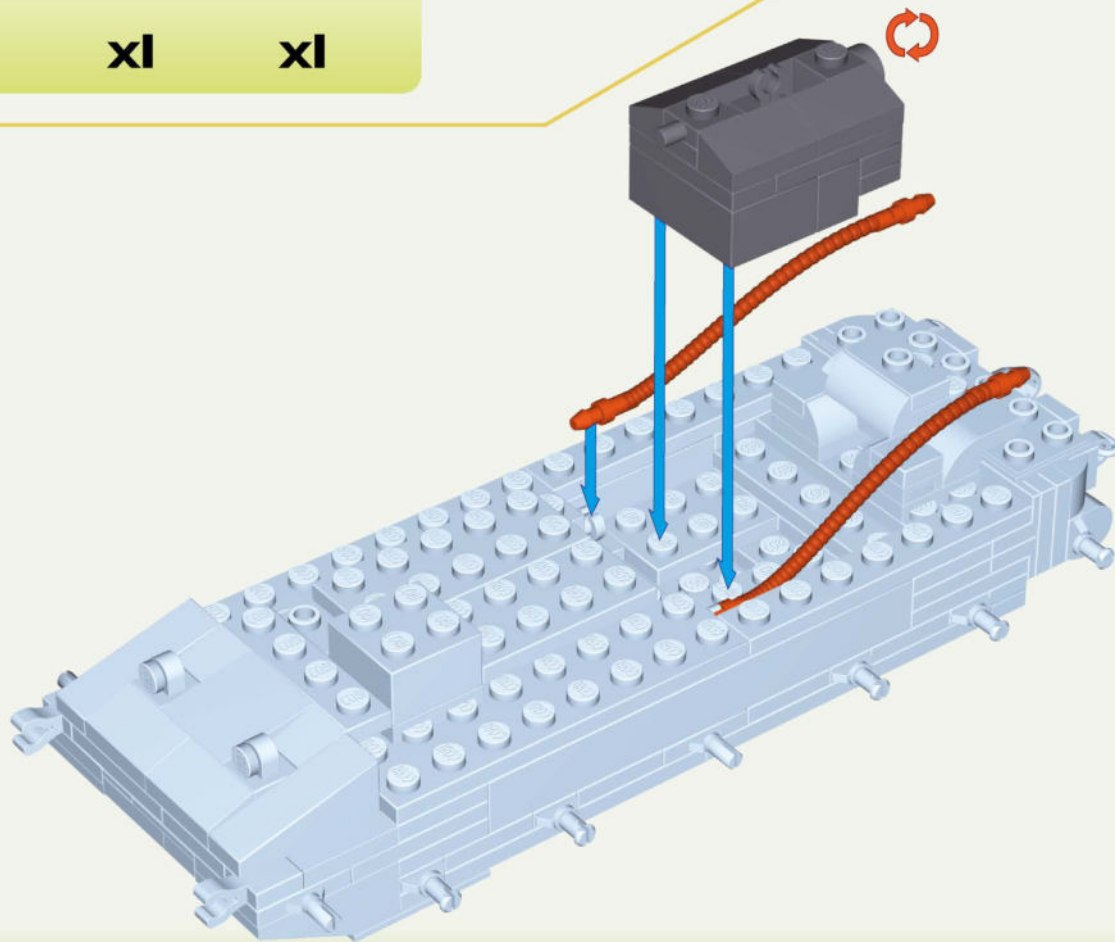



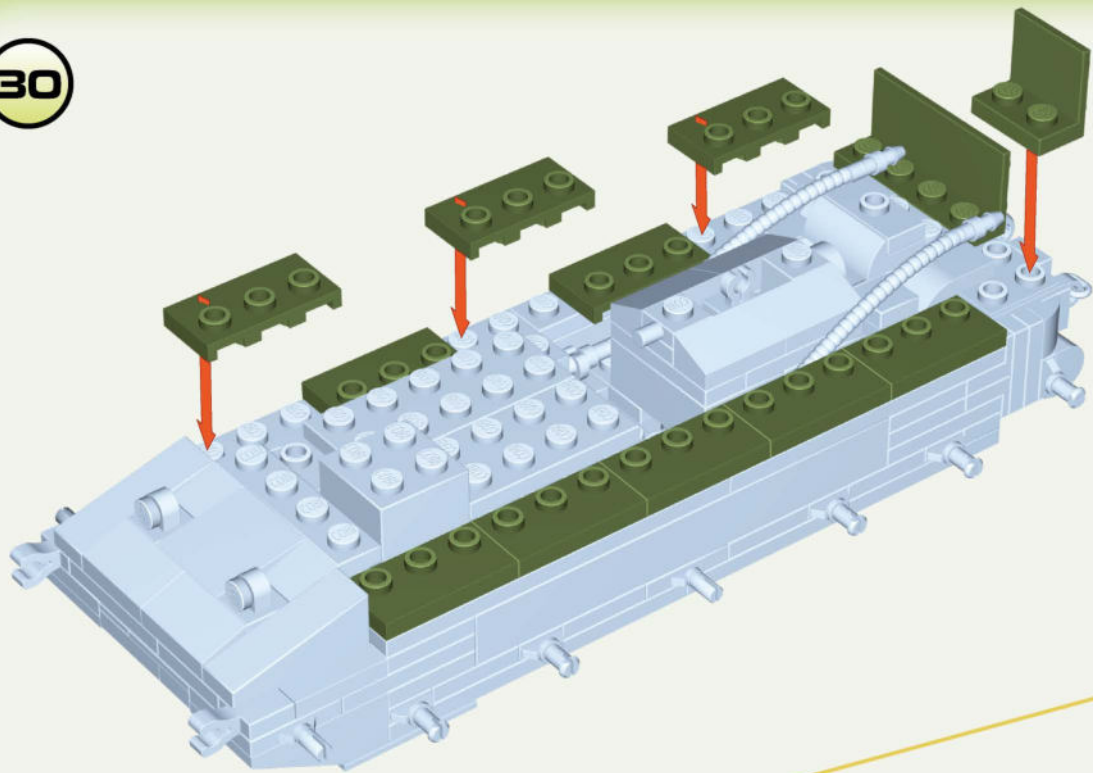

30

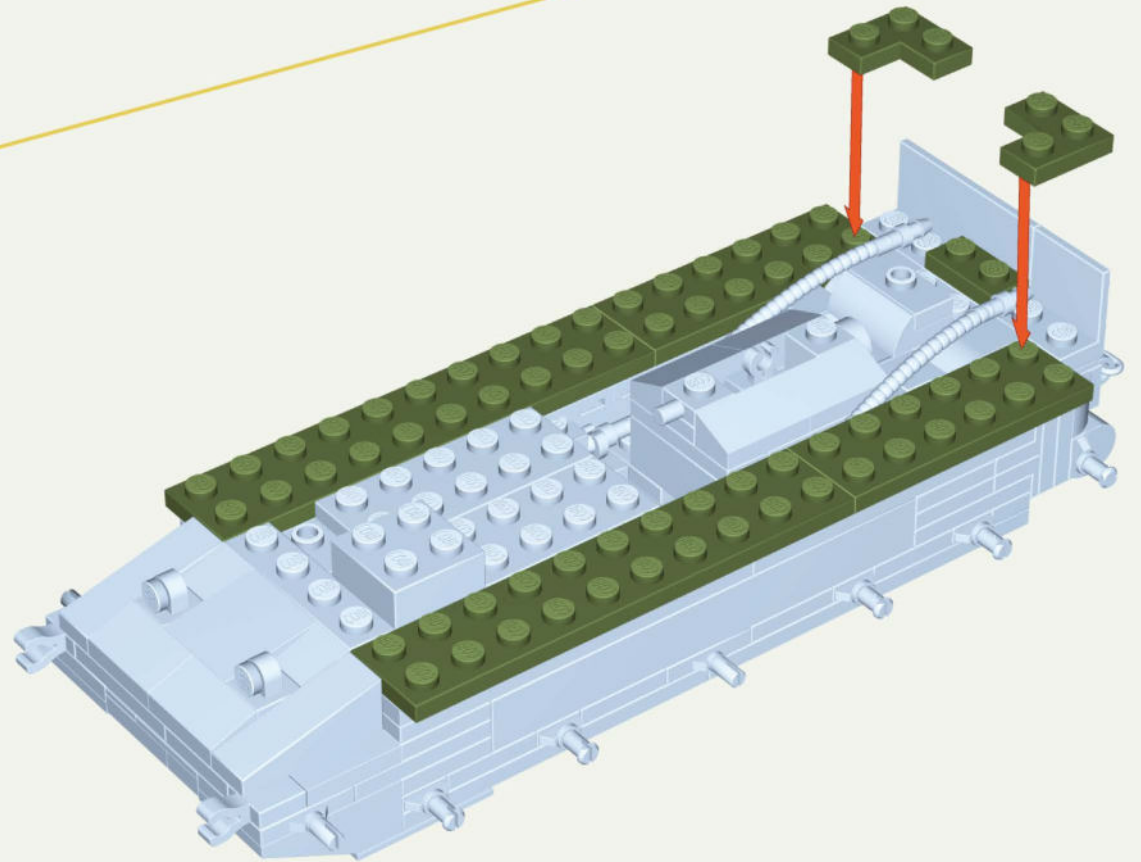

 **x1**
 **x10**
 **x1**

31



 **x2**
 **x2**
 **x1**
 **x2**

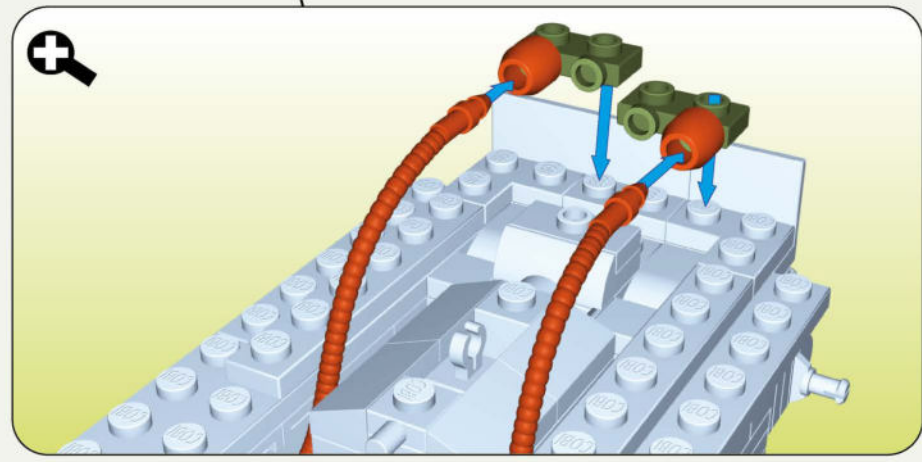
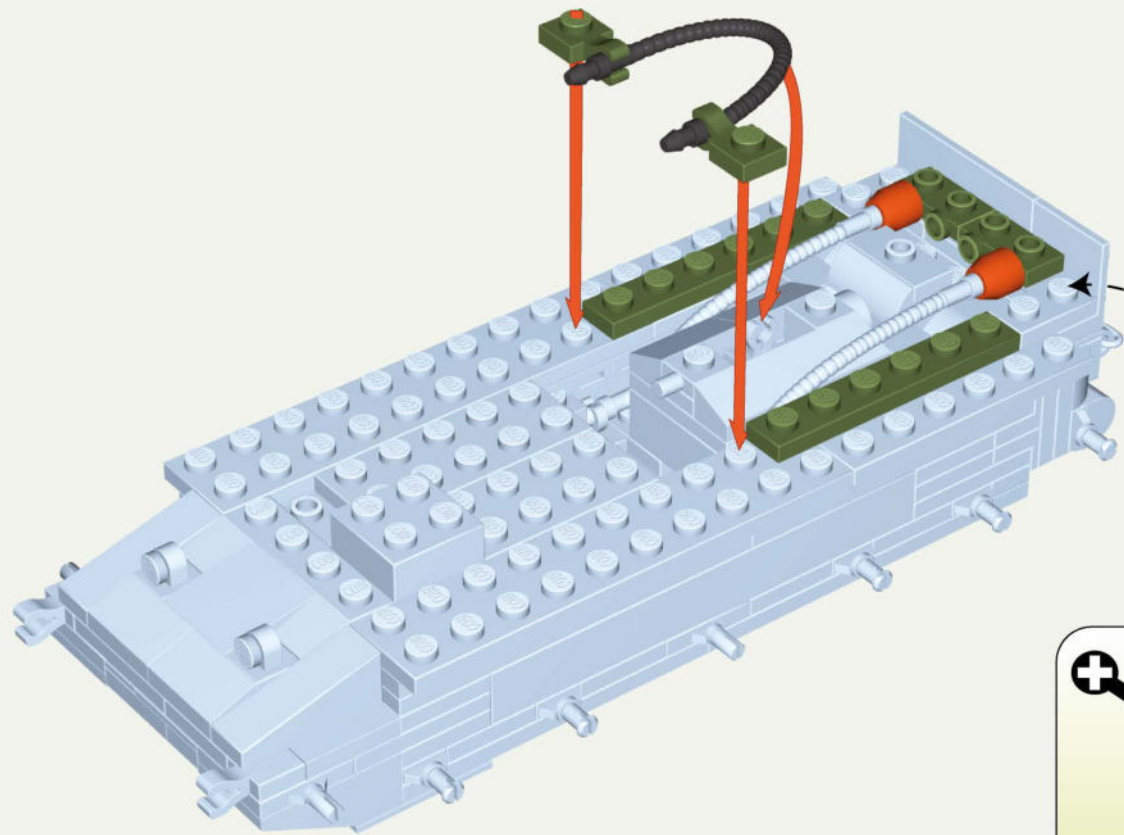

-  x2
-  x2
-  x2
-  x2
-  x1

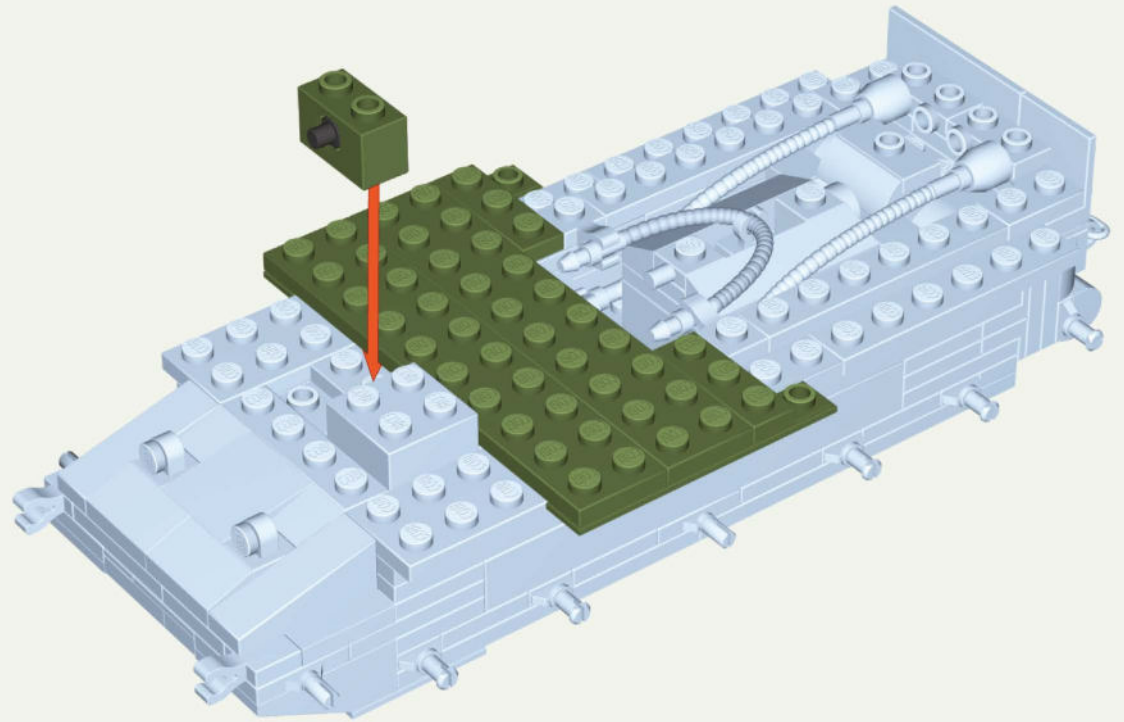
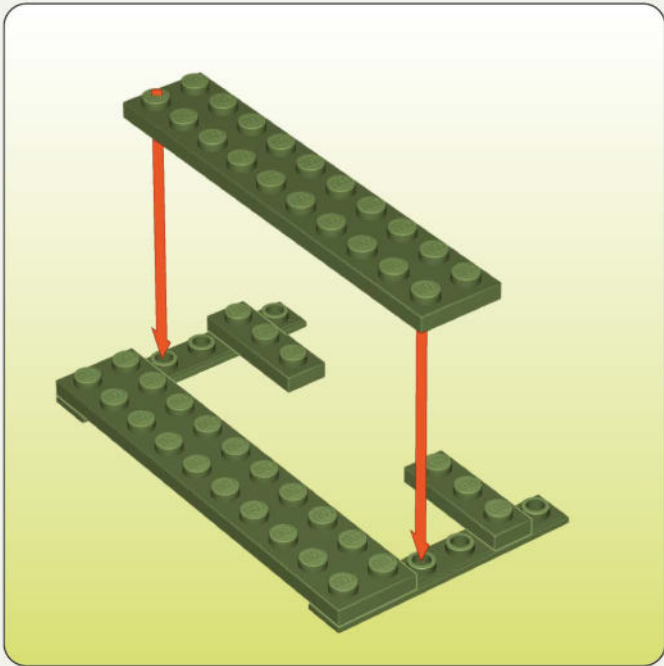
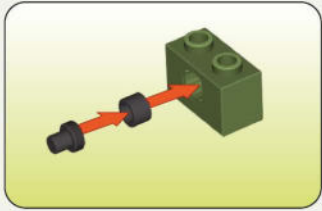

x2



x2

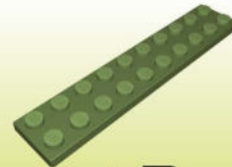

x2



x1



x1



x1

34

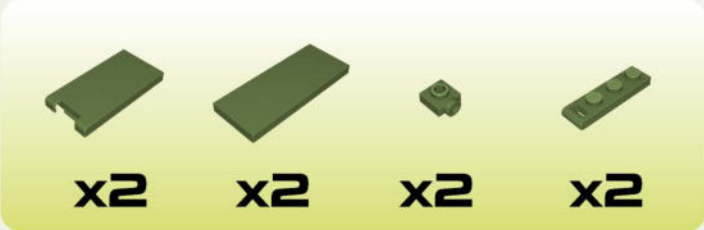
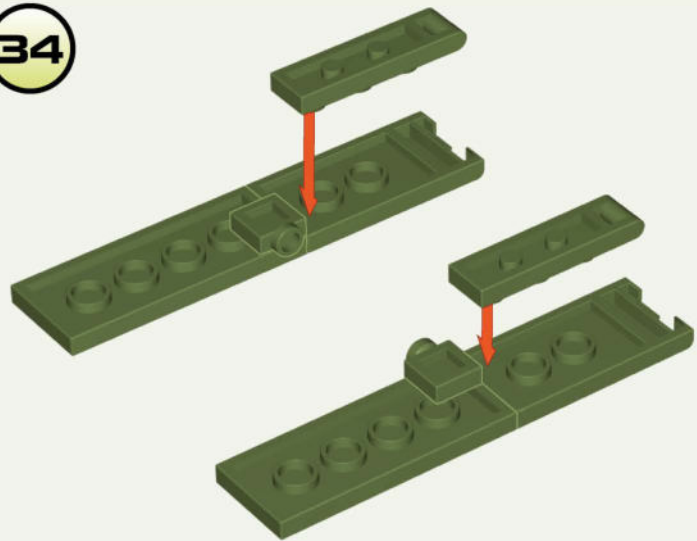

35

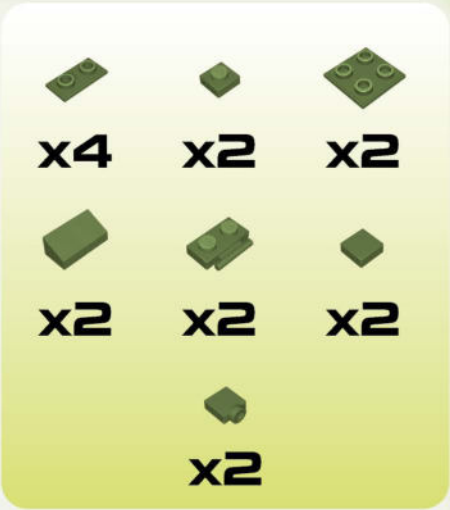
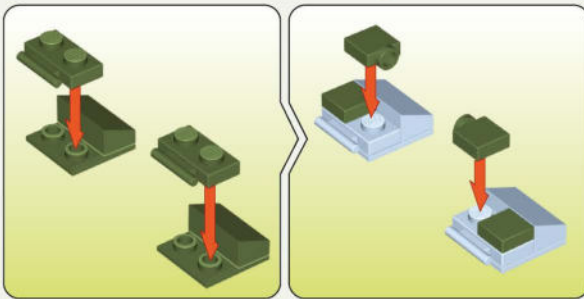
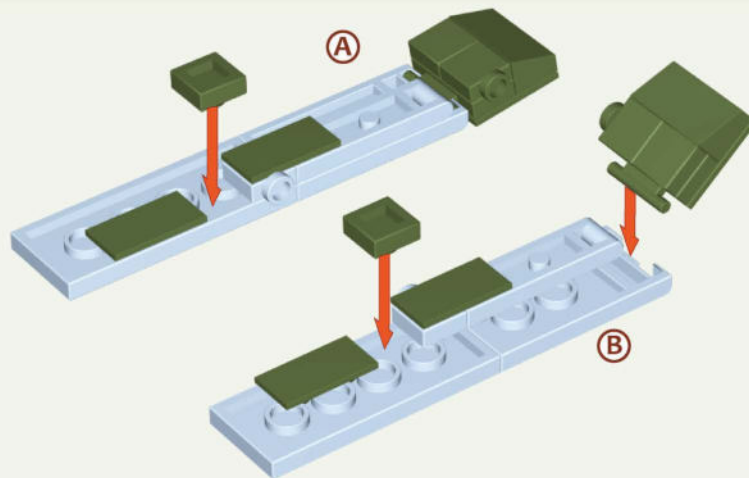



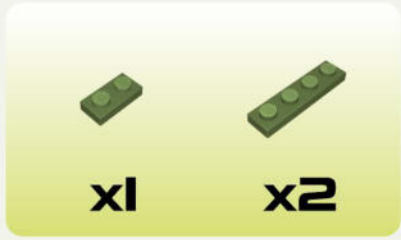

36

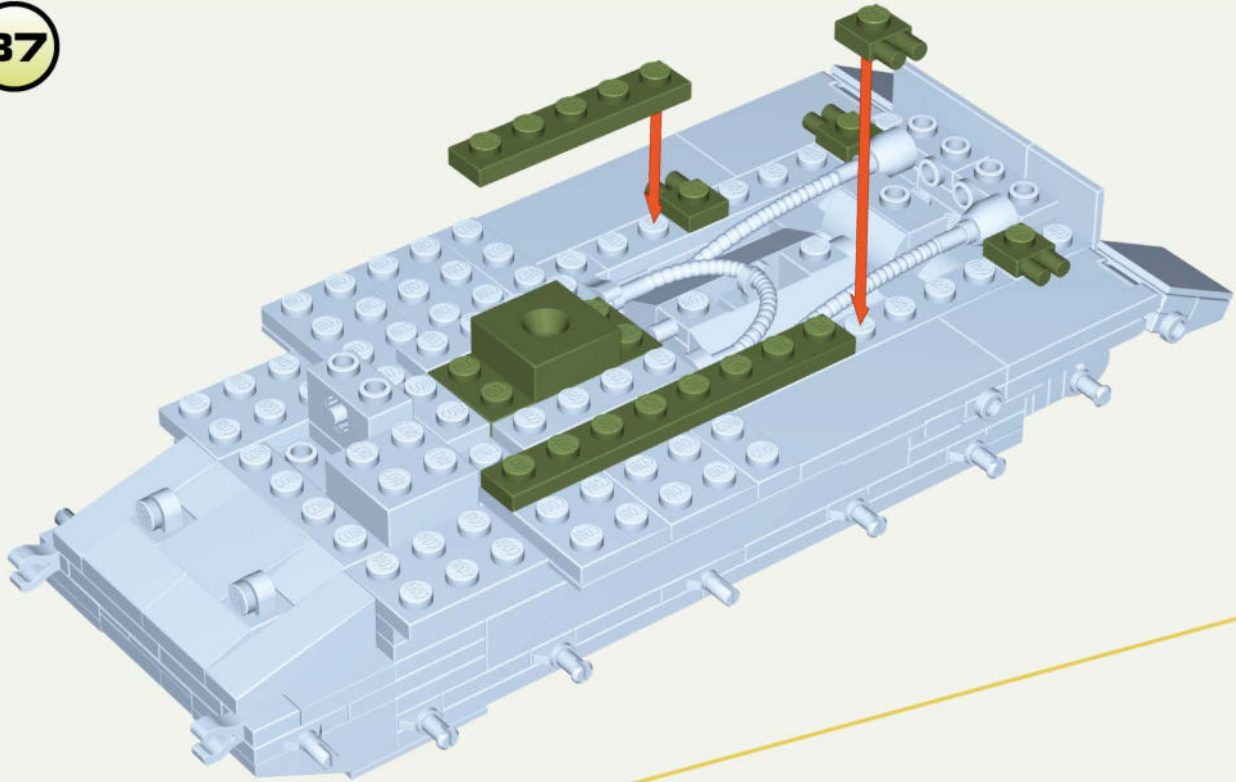







37

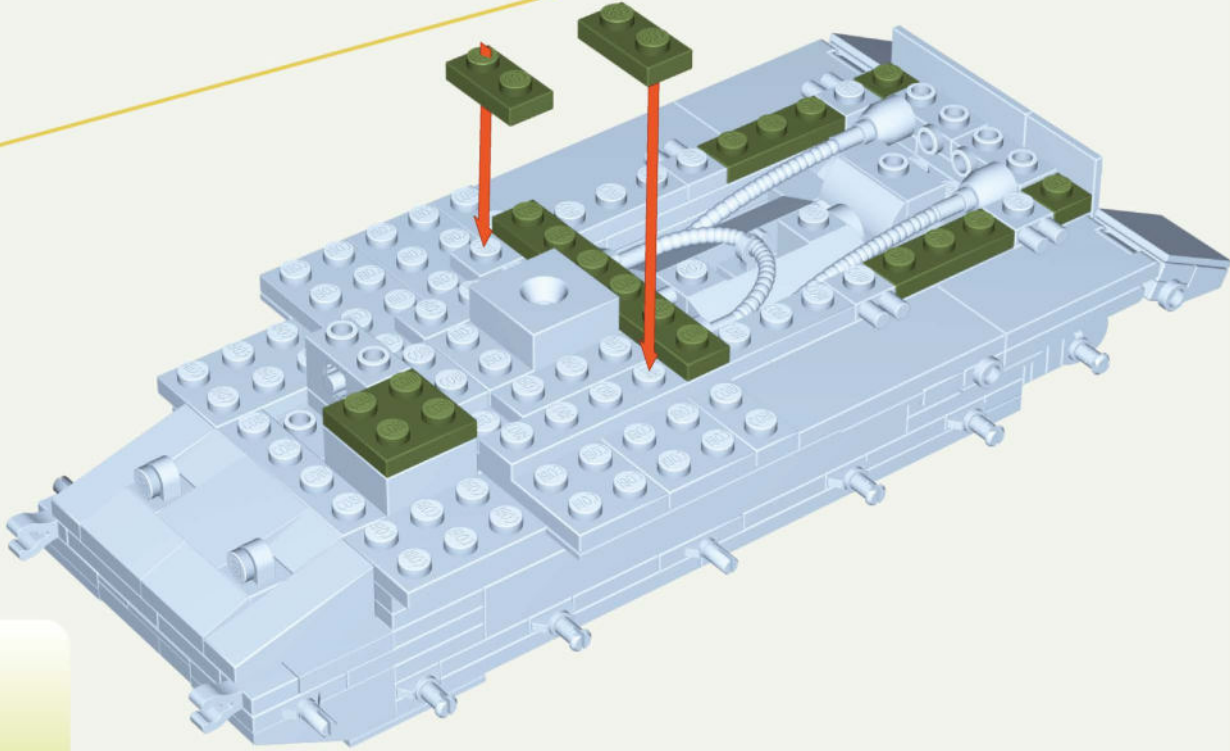







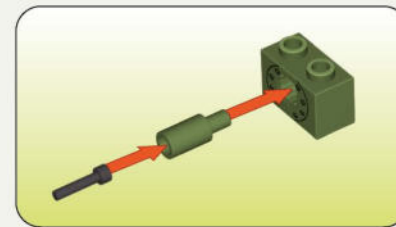
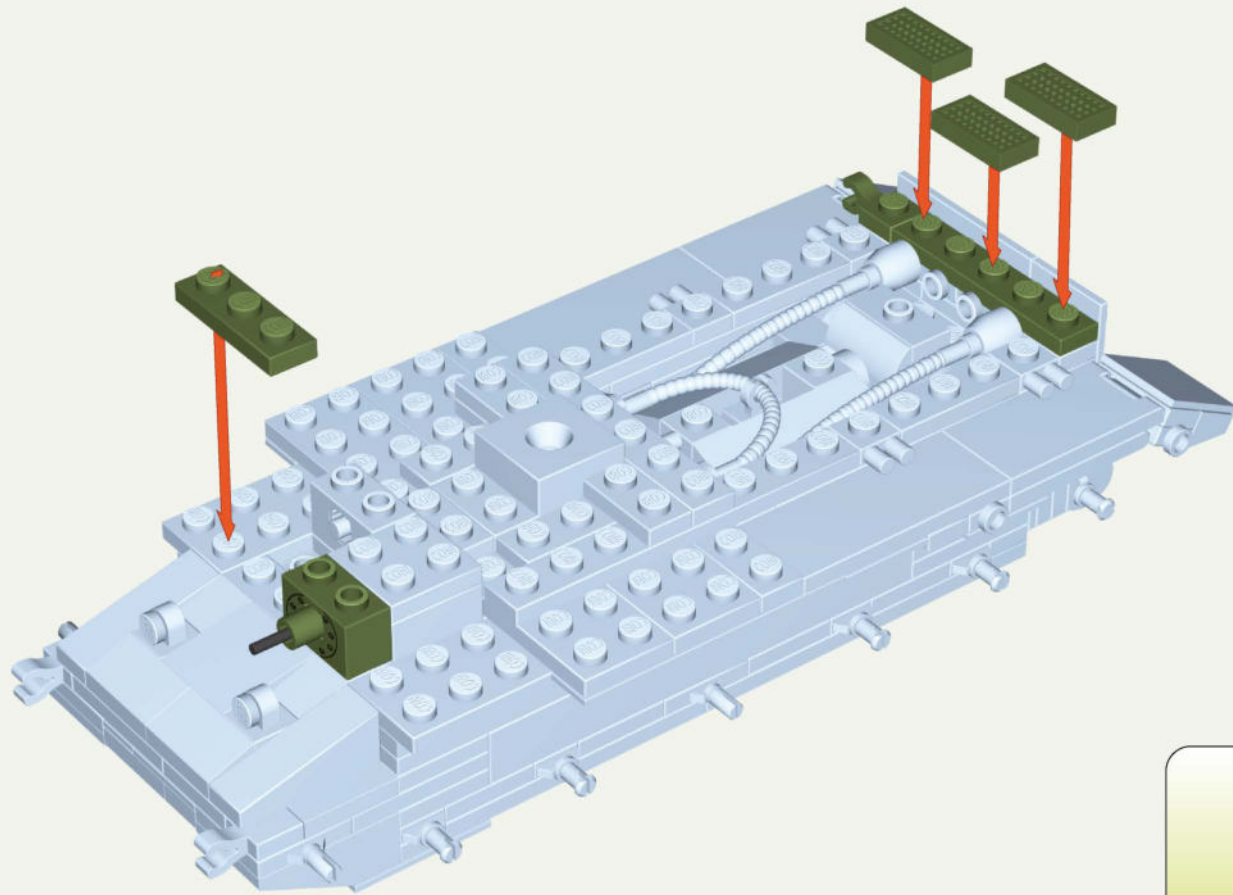

 **x1**
 **x1**
 **x4**
 **x1**

38



 **x2**
 **x2**
 **x1**
 **x1**
 **x2**



- | | | | |
|---|---|---|---|
|  |  |  |  |
| x1 | x1 | x1 | x1 |
| |  |  |  |
| | x1 | x1 | x3 |



40

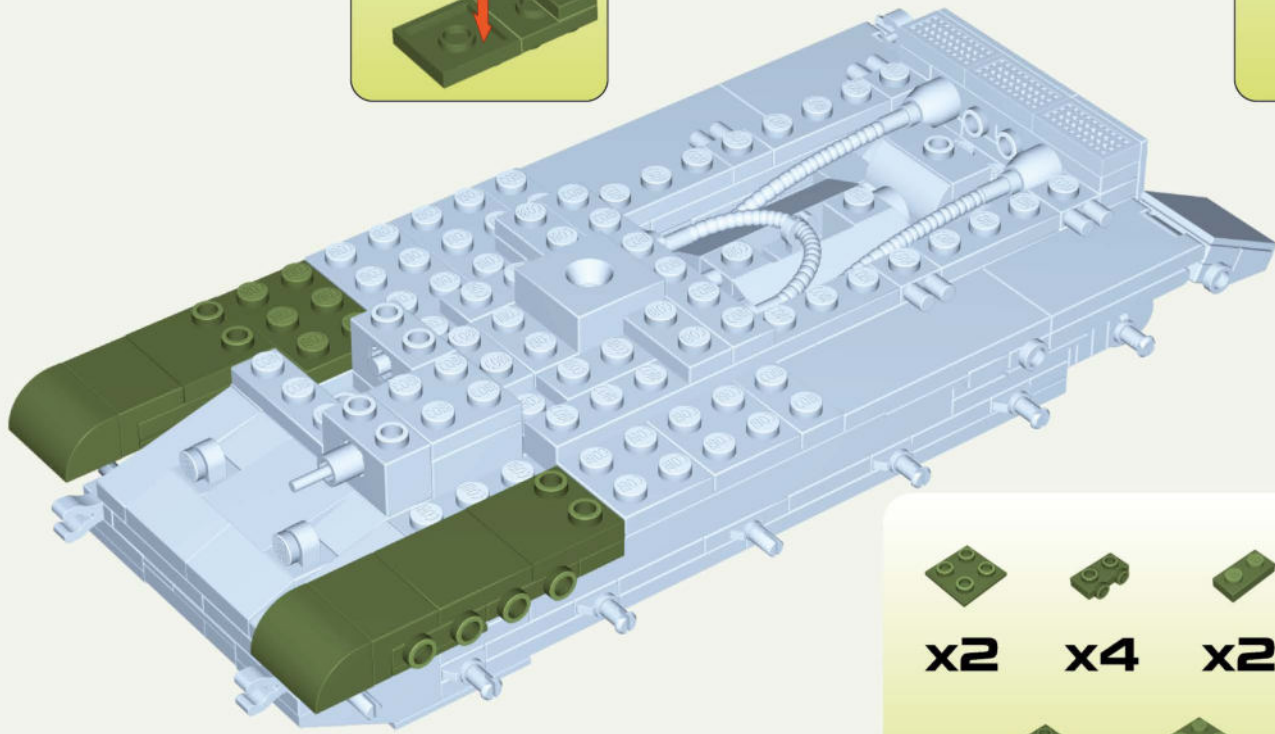
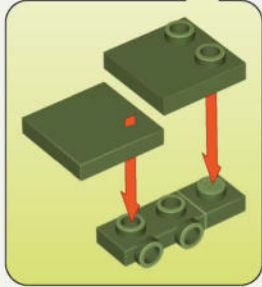
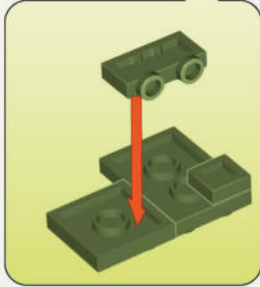
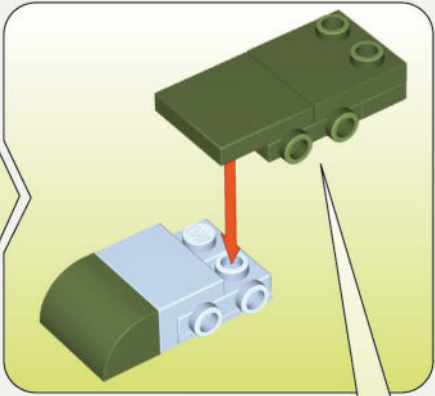
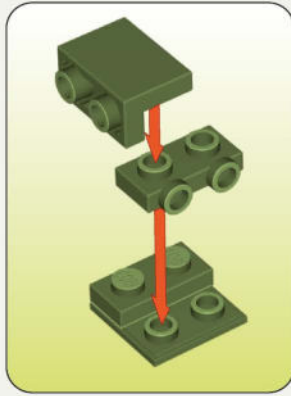
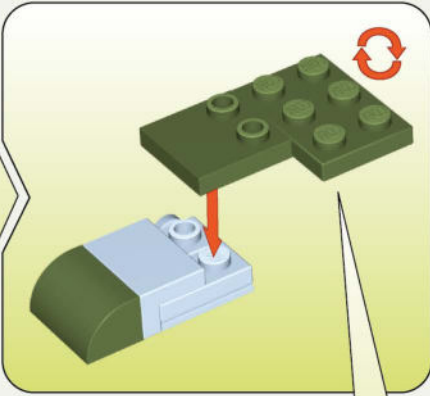
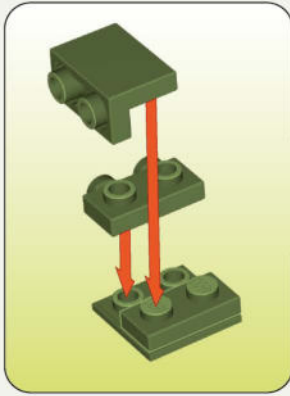

BE CAREFUL: NOTICE THE DIFFERENCE

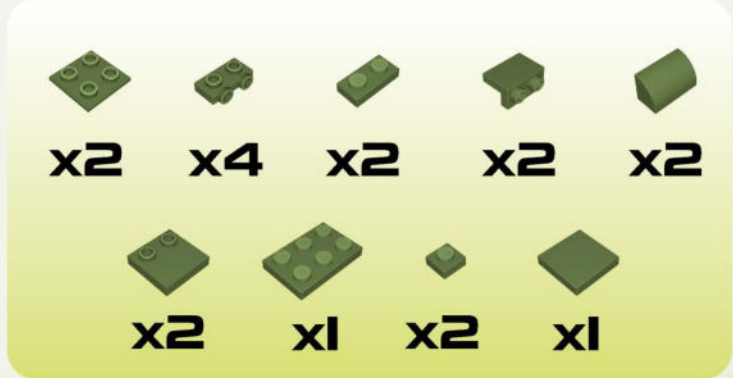
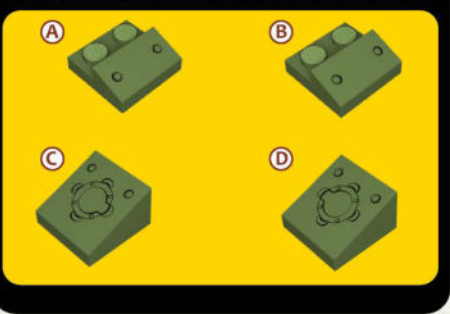

41

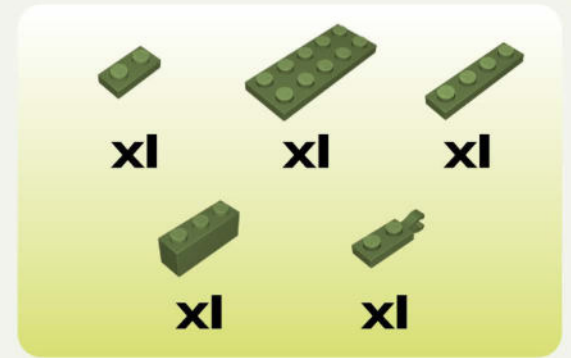
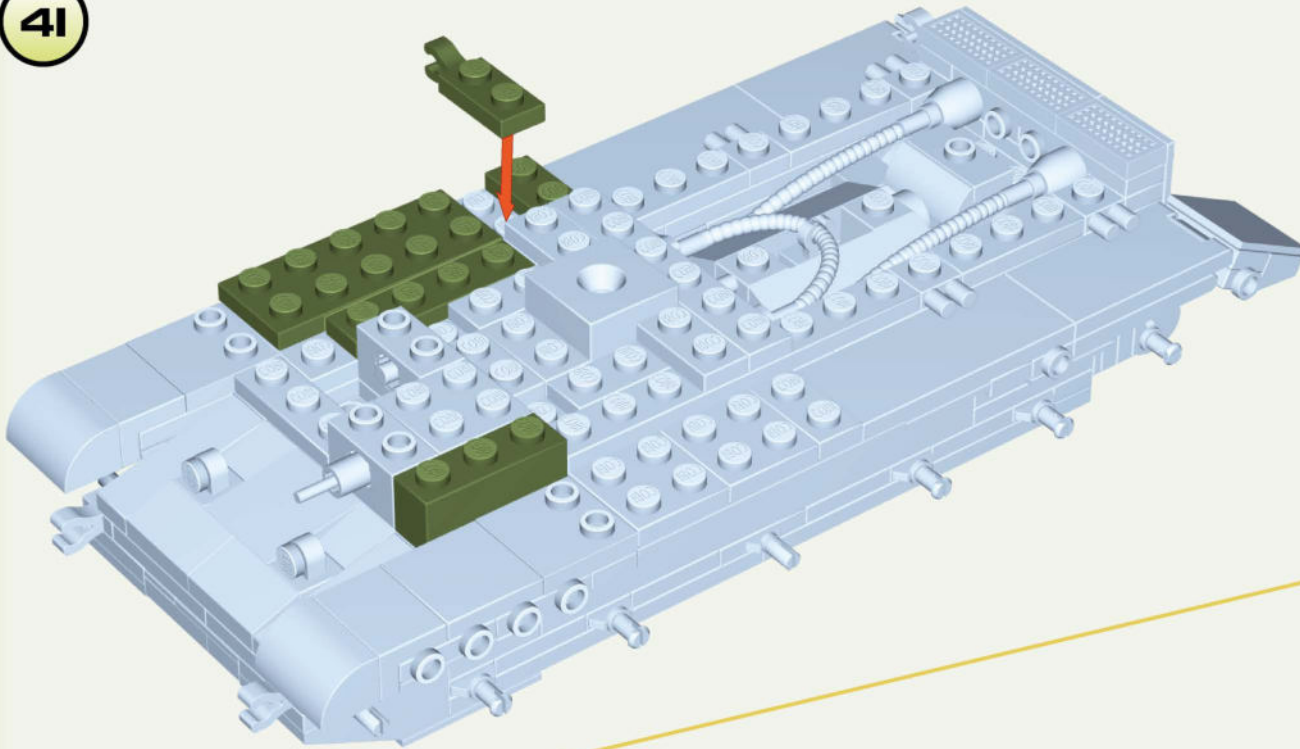

42

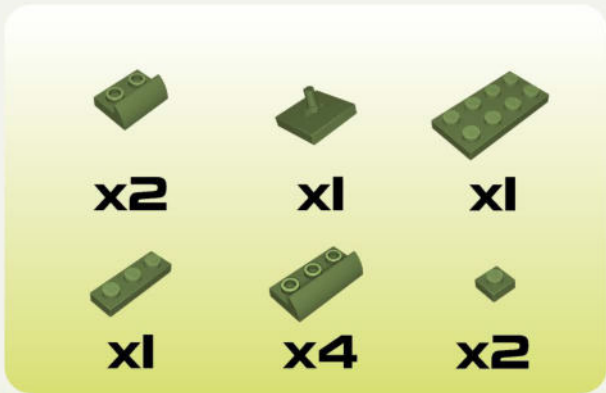
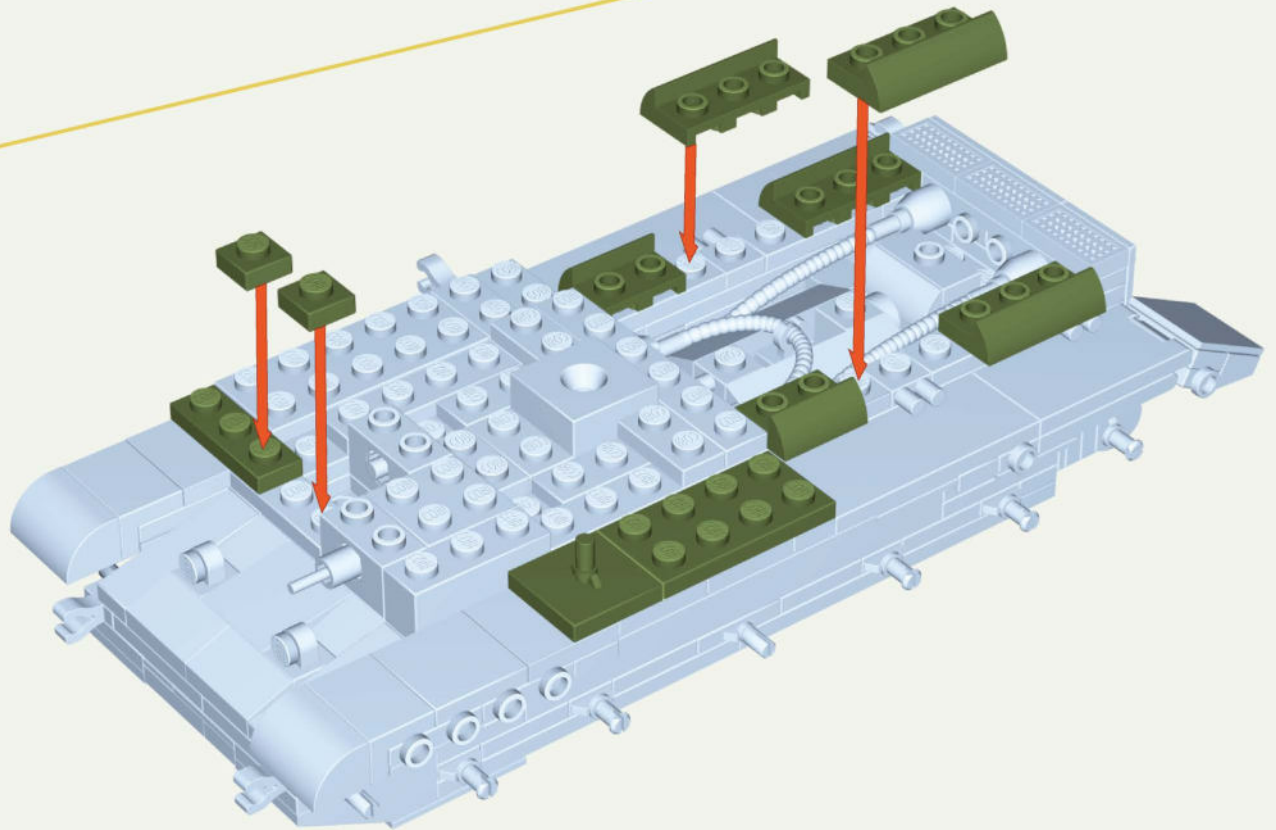

43

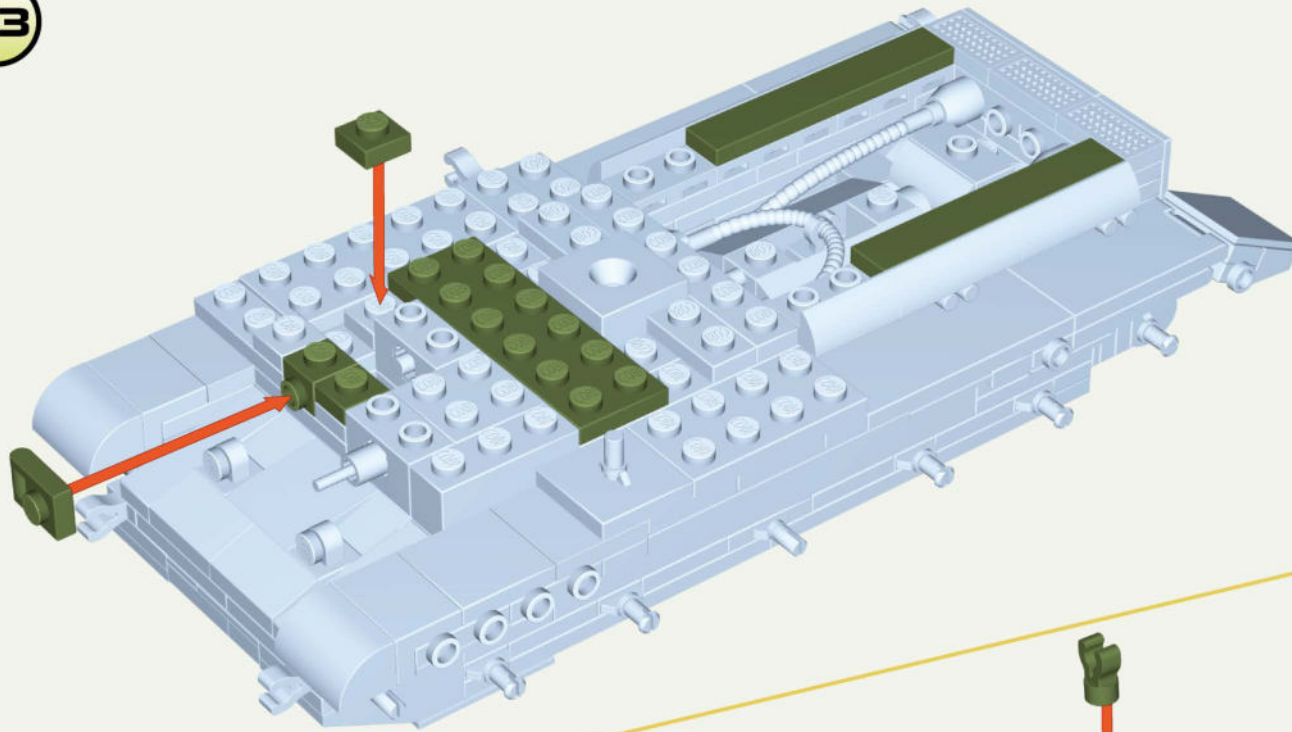

1:1

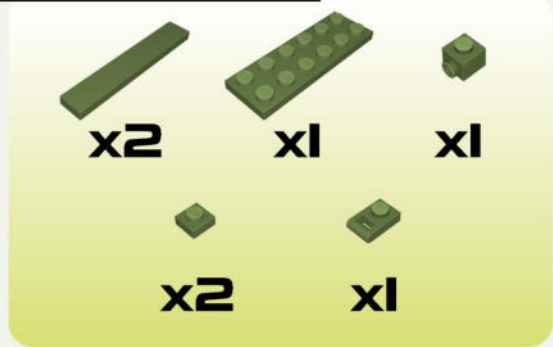

44

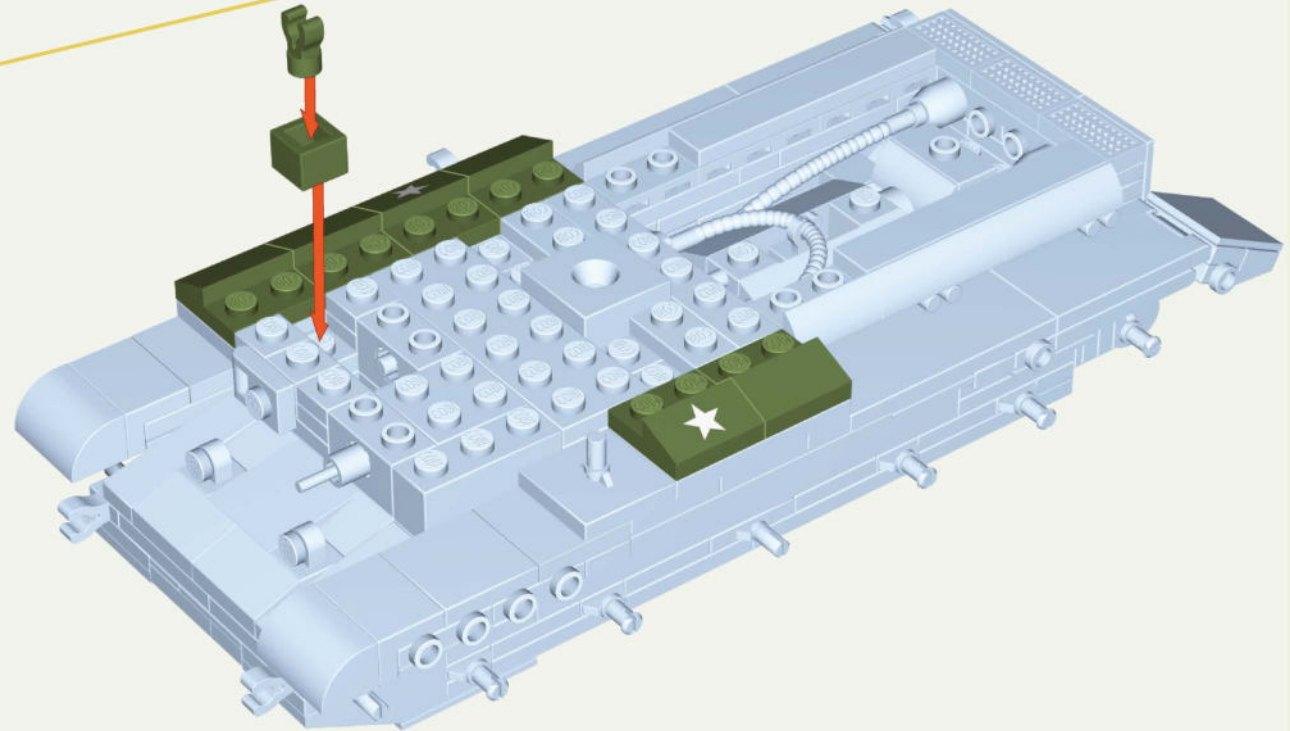

45

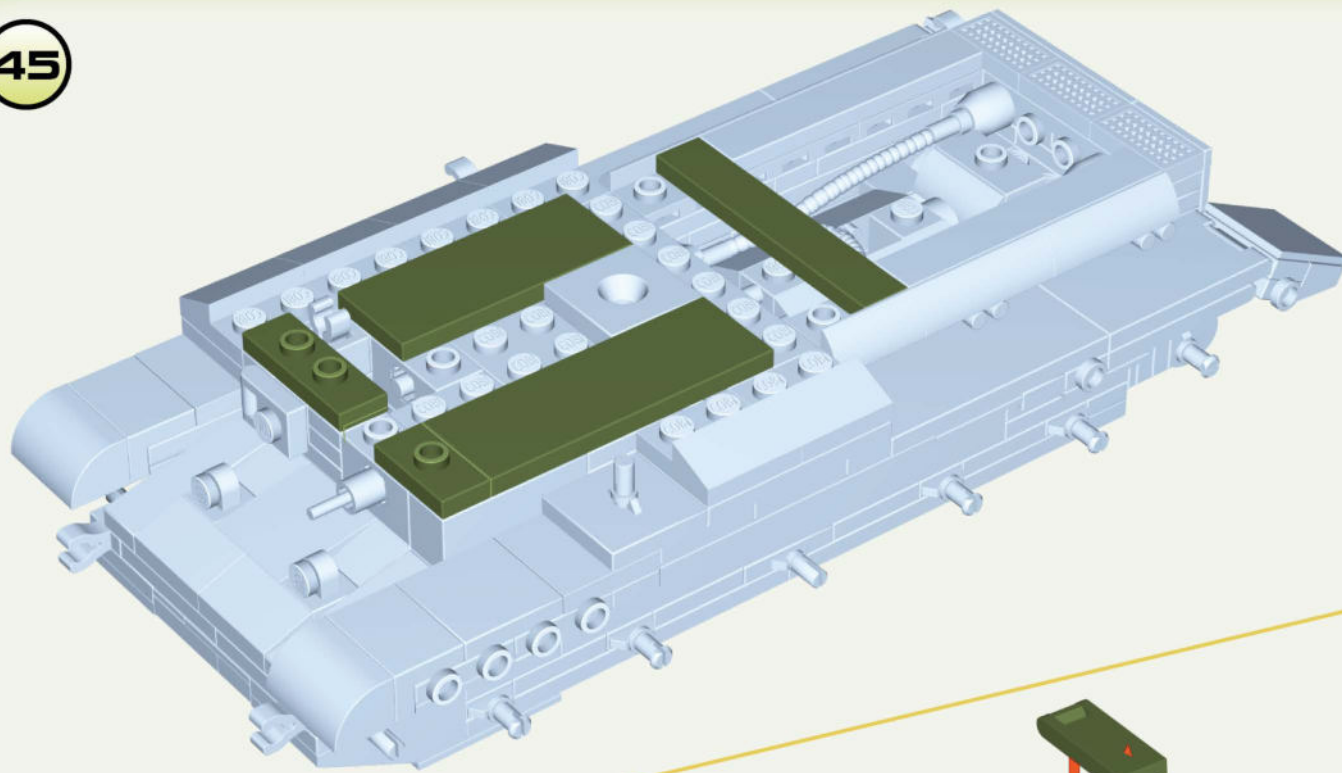

1:1

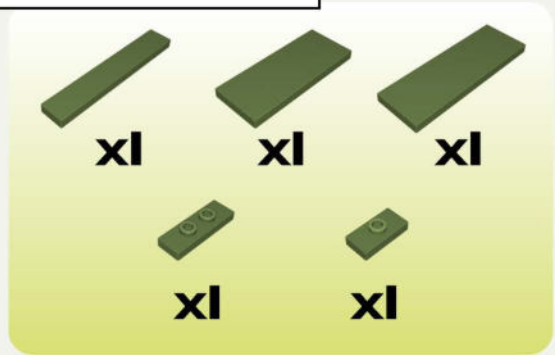

46

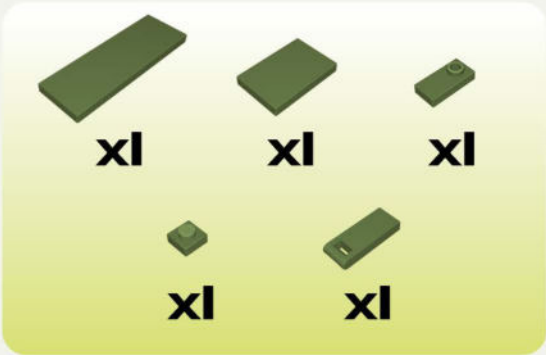
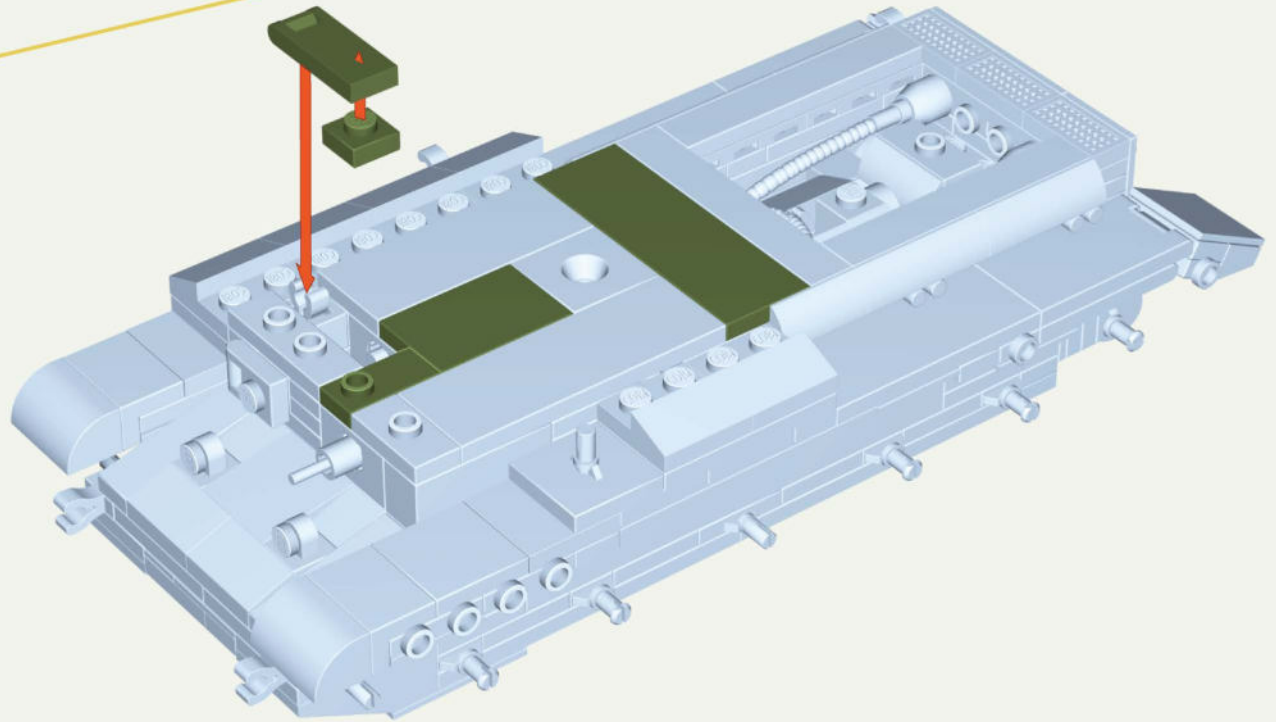

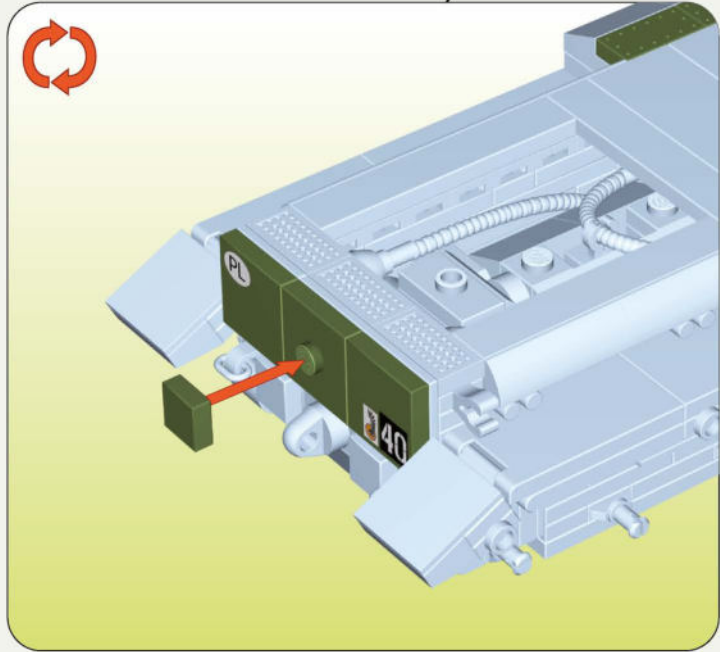
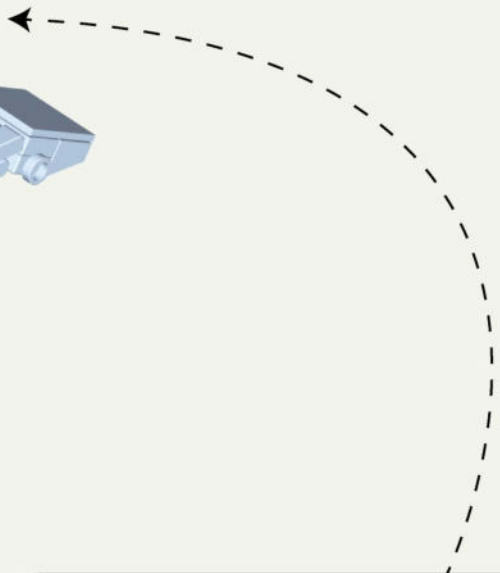
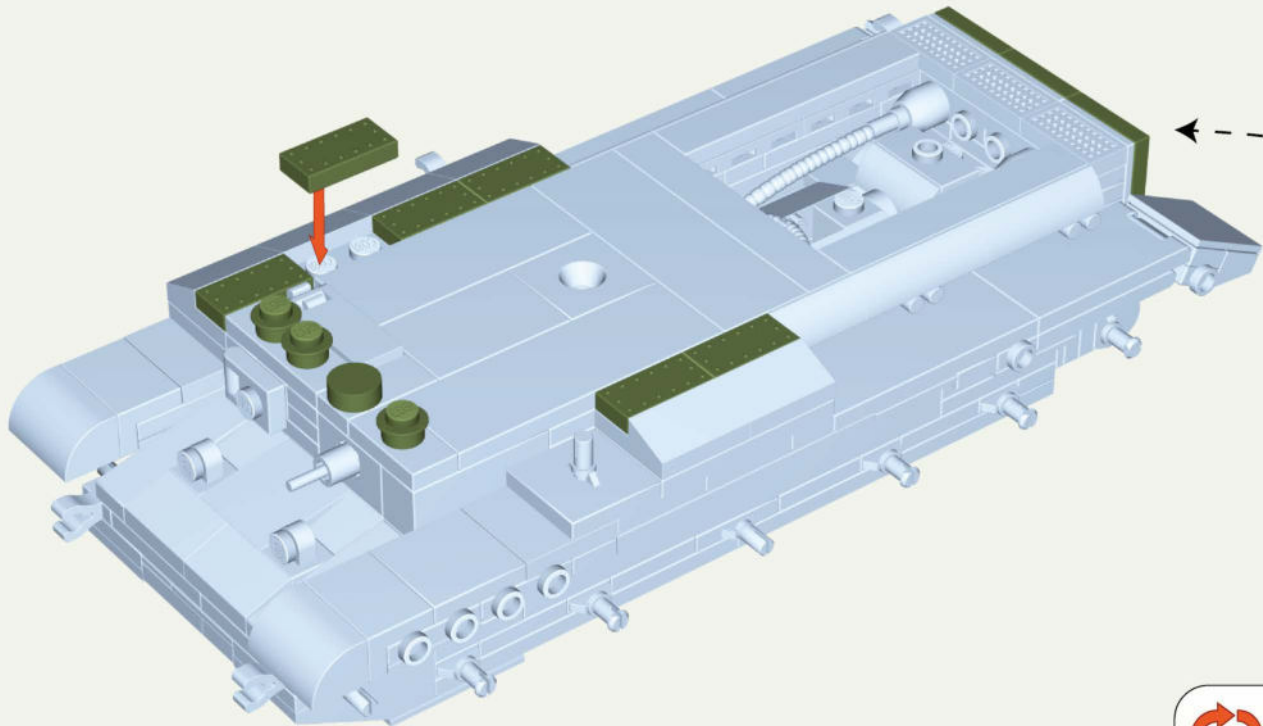

-  x3
-  x1
-  x1
-  x1
-  x1
-  x1
-  x6

48

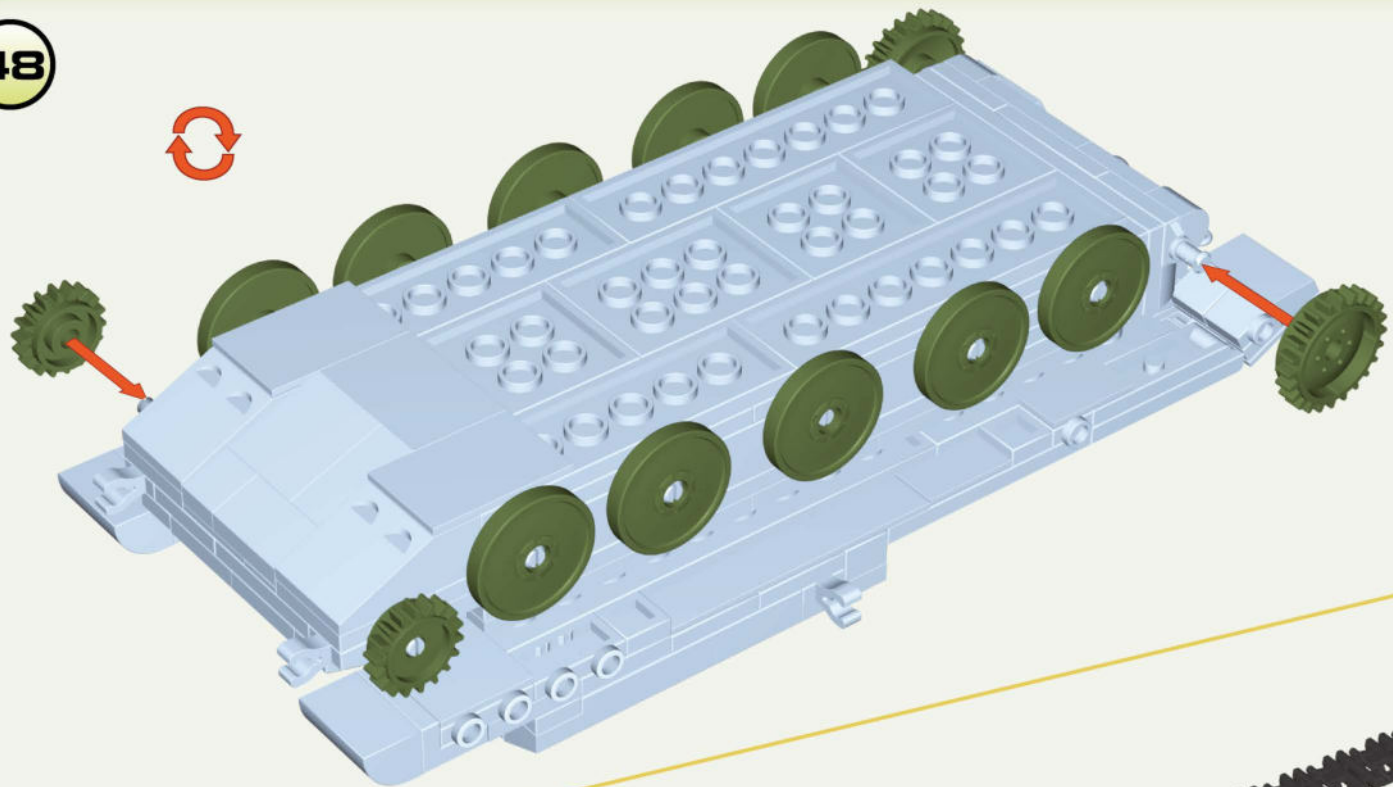

x10	x2	x2

49

x2

x43

x86

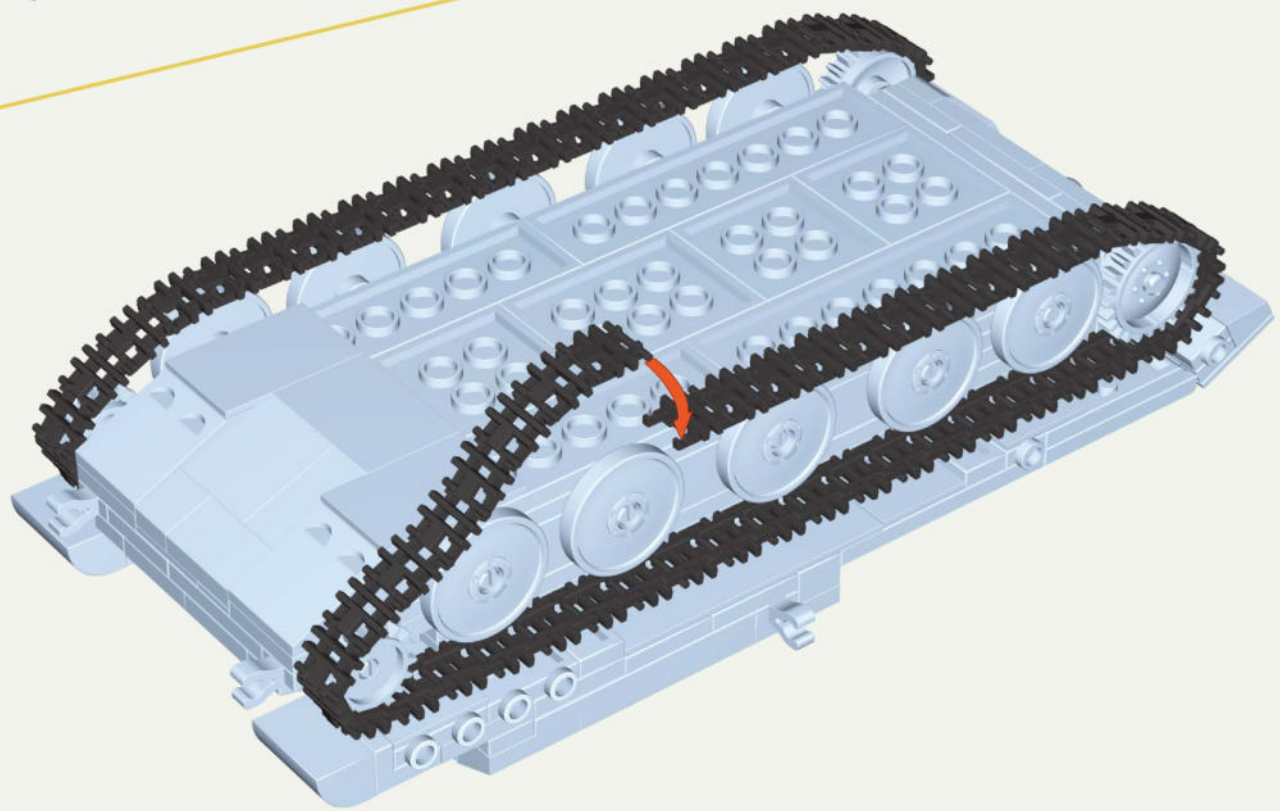

50

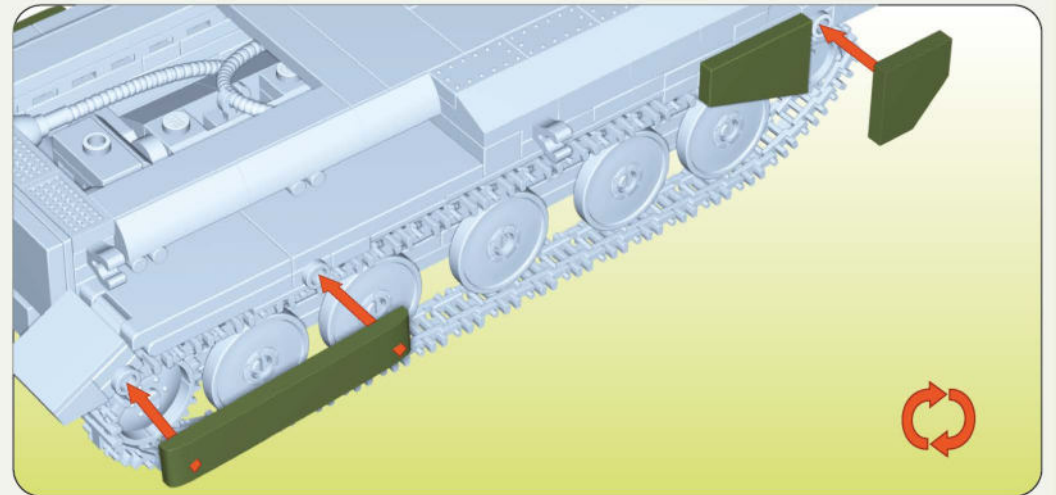
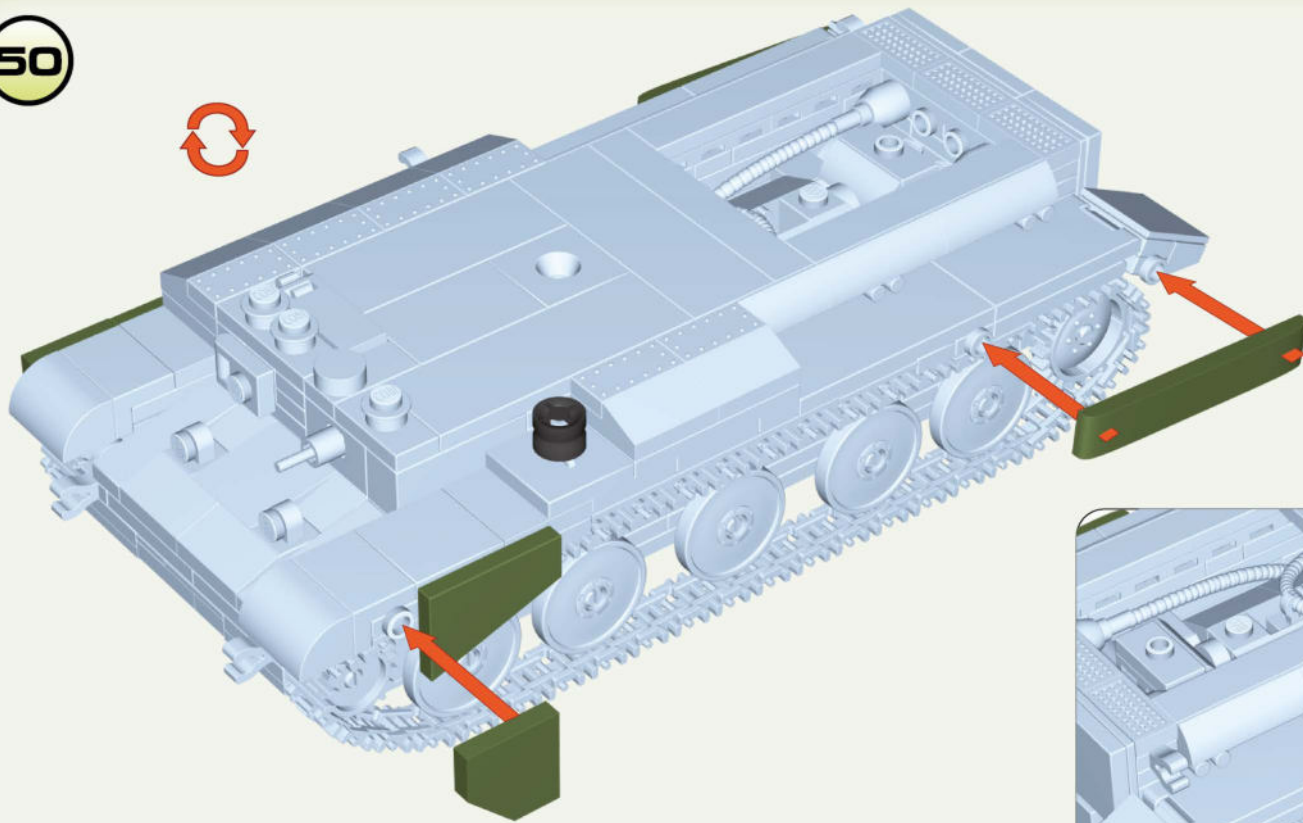

Parts list for step 50:

- Black axle: x1
- Long green Technic beam: x2
- Green Technic wedge (left): x1
- Green Technic wedge (right): x1
- Green Technic wedge (top): x2

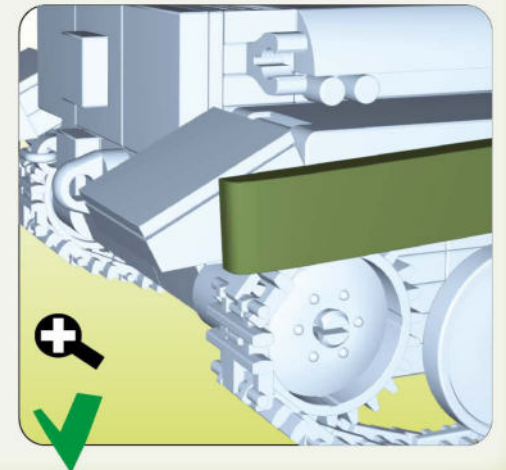
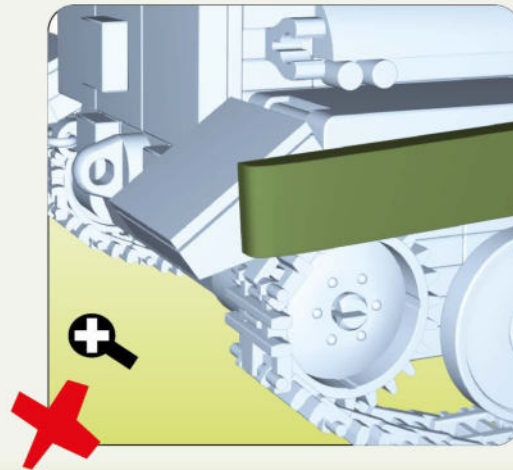

52

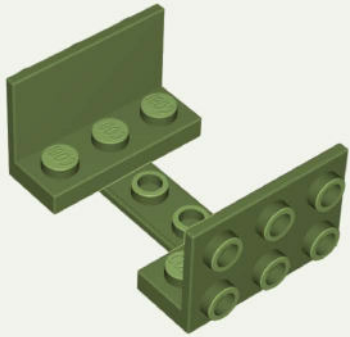

x1



x2

53

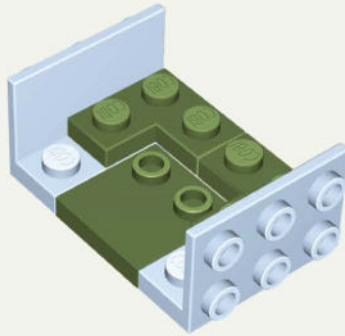

x1



x2

54

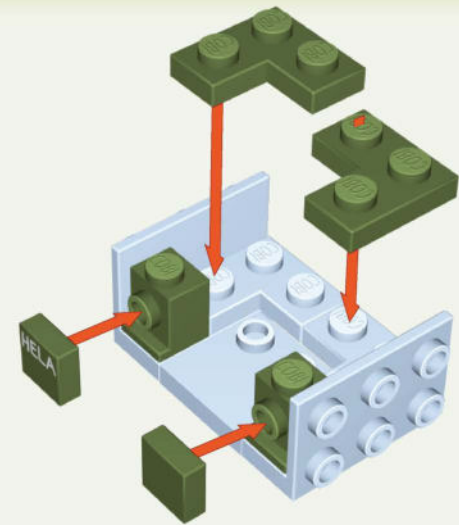

x2



x1



x1



x2

55

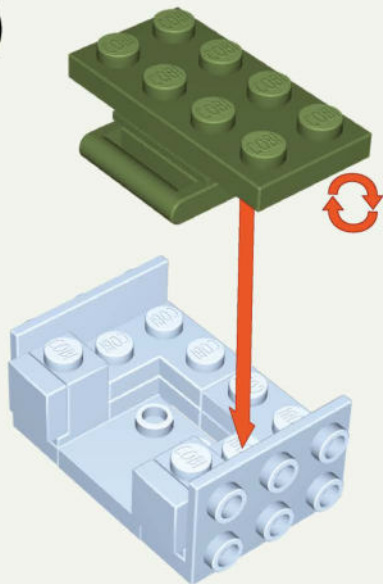

x1



x1



x1

56

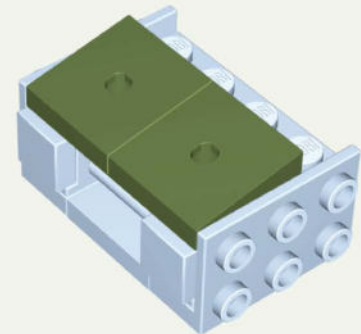

x2

57

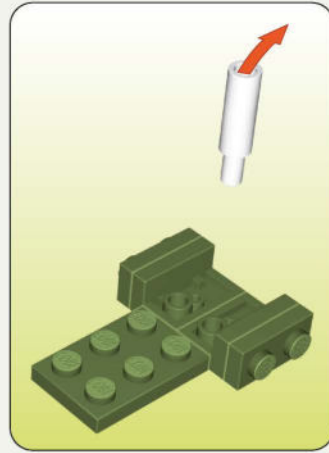
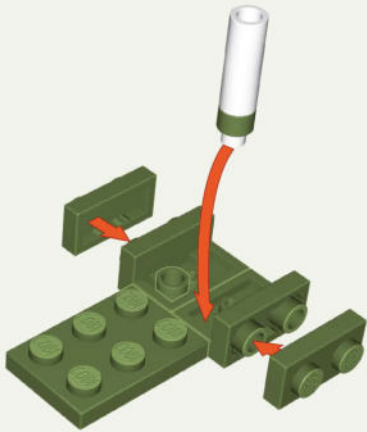

x1



x2



x2



x2

58

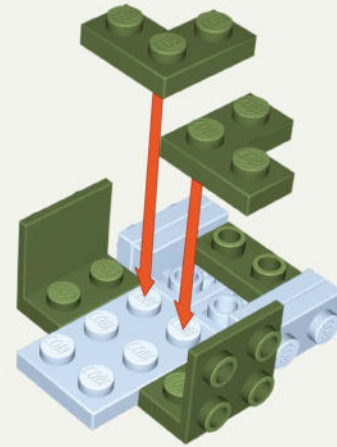

x2



x1



x2

59

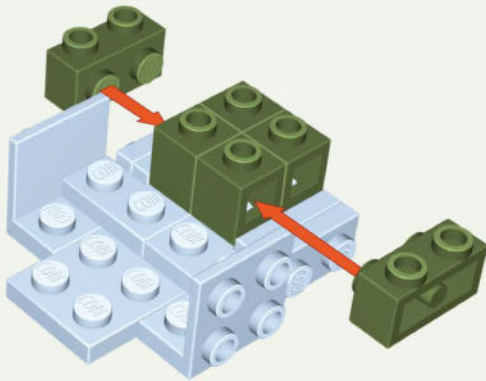

x4



x2

60

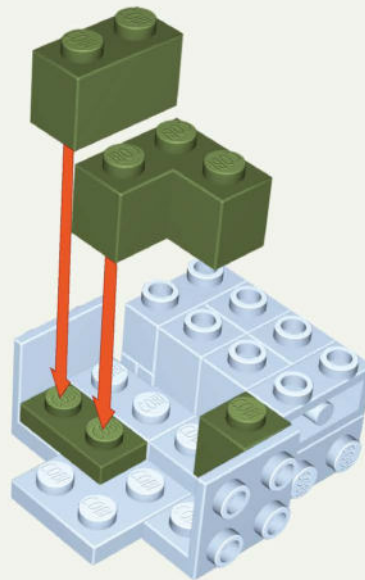

x1



x1



x1



x1

61

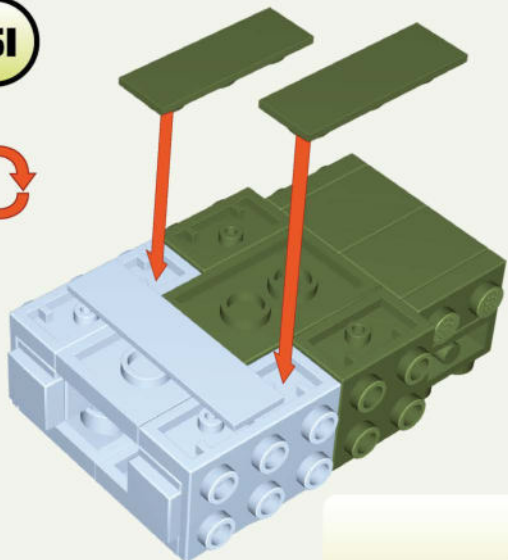

x2

62

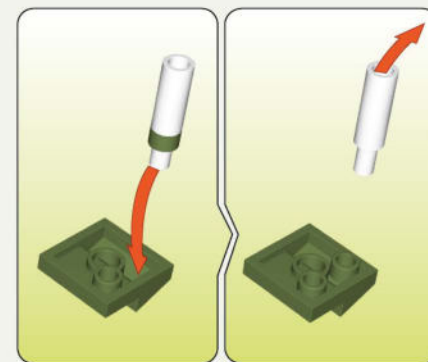
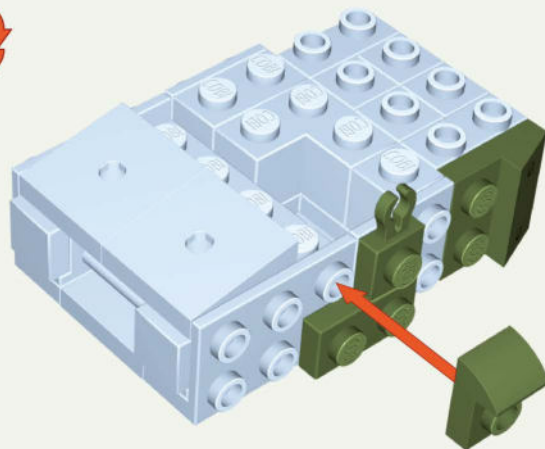

63

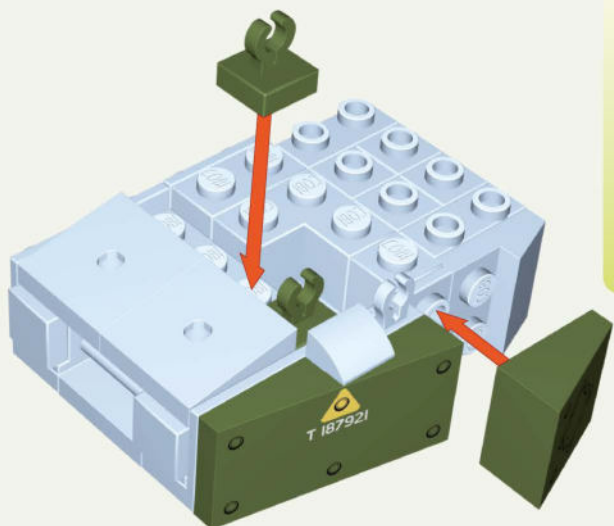

x1



x1



x2

64

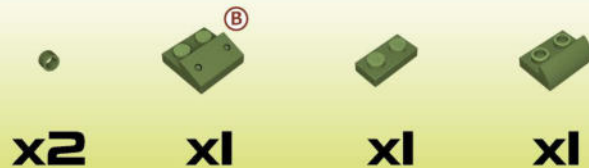
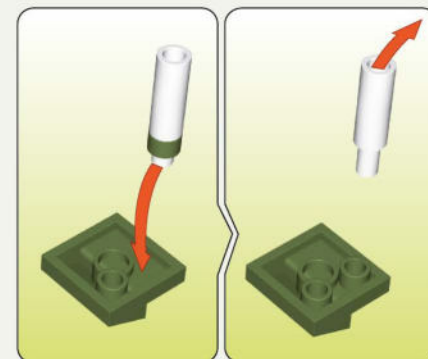
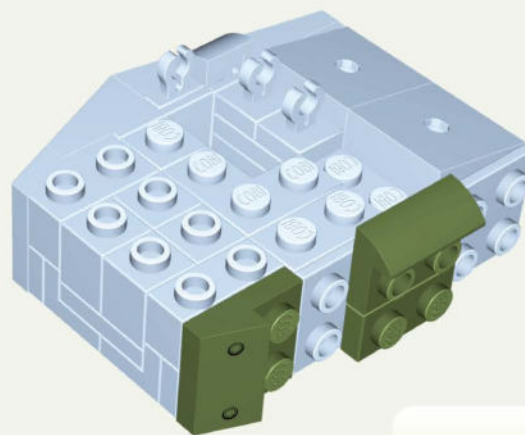

65

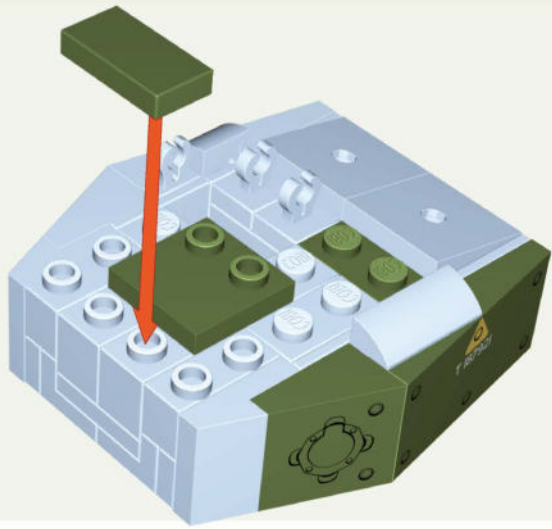

1:1



x1



x1



x1



x1



x1

66

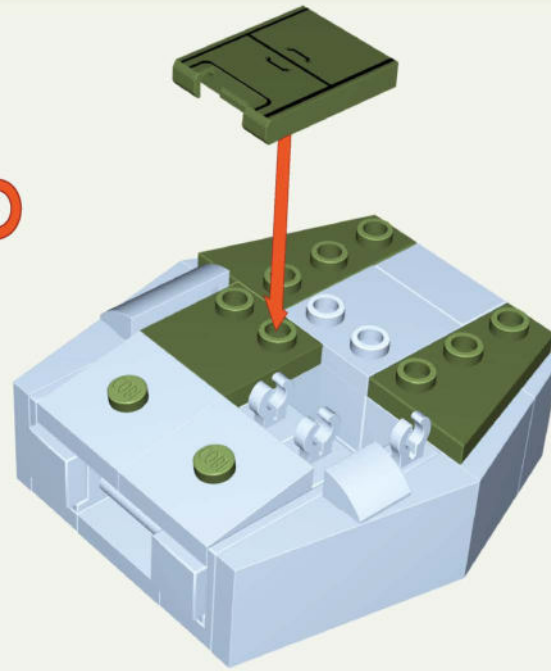

x1



x1



x2



x1



x1

67

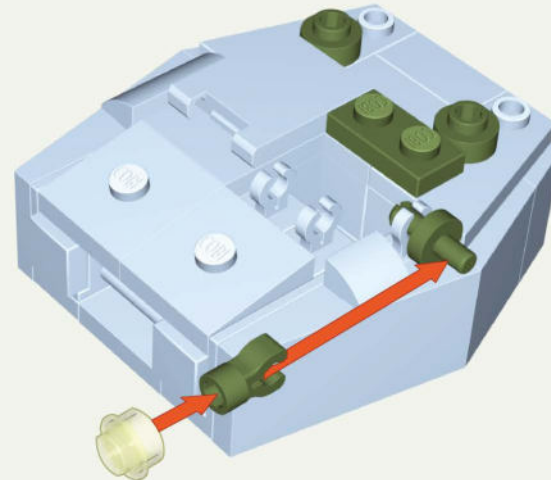

x2



x1



x1



x1



x1

68

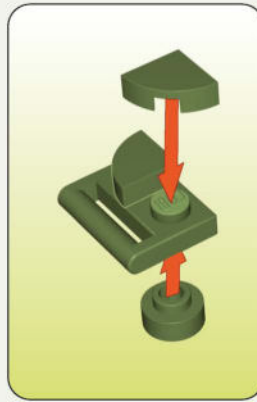
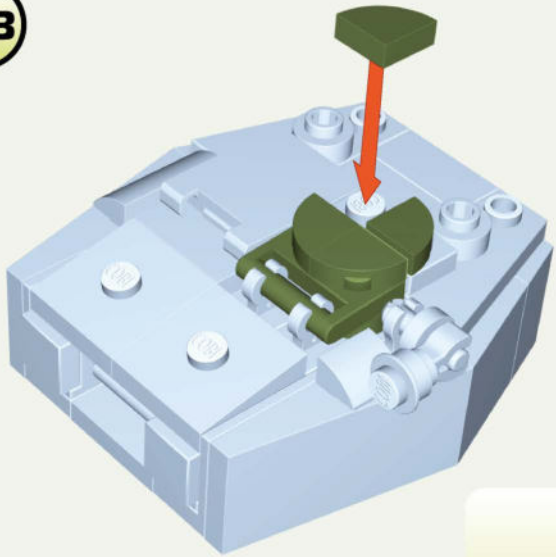



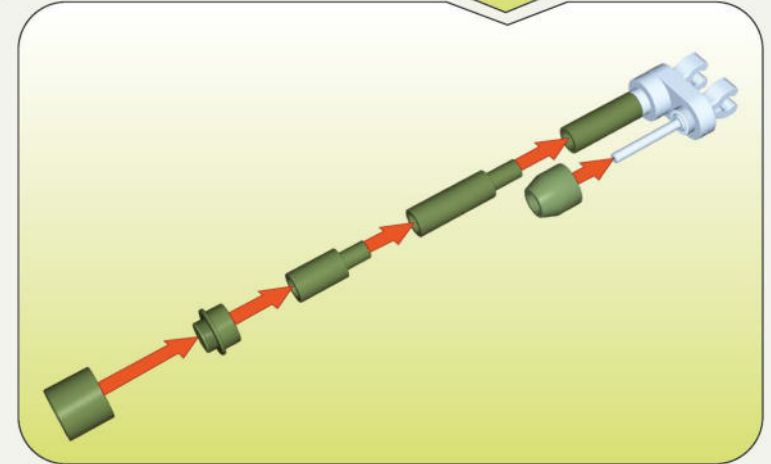
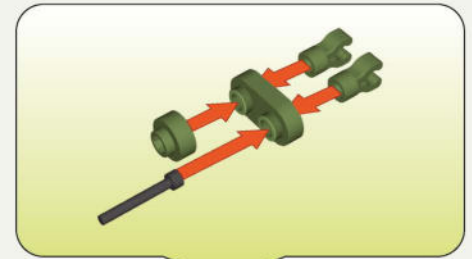



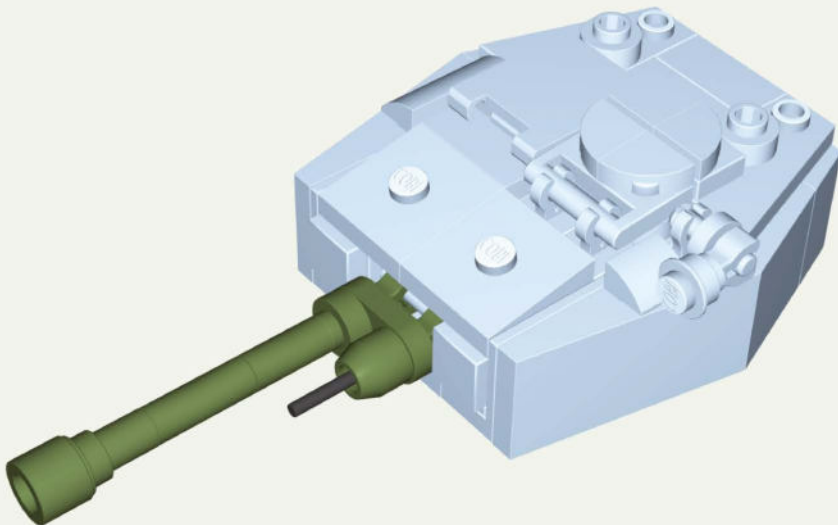

- 
x1
- 
x1
- 
x4



69



- 
x2
- 
x1
- 
x1
- 
x1
- 
x1
- 
x2
- 
x1
- 
x1
- 
x1

70

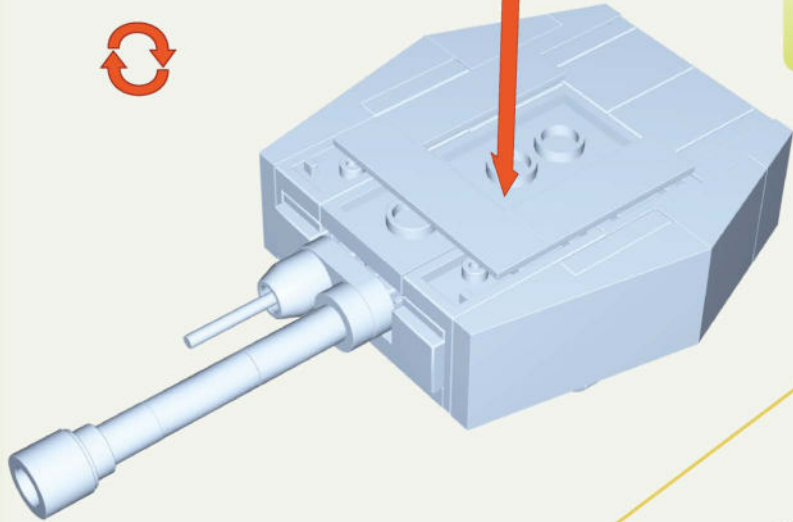

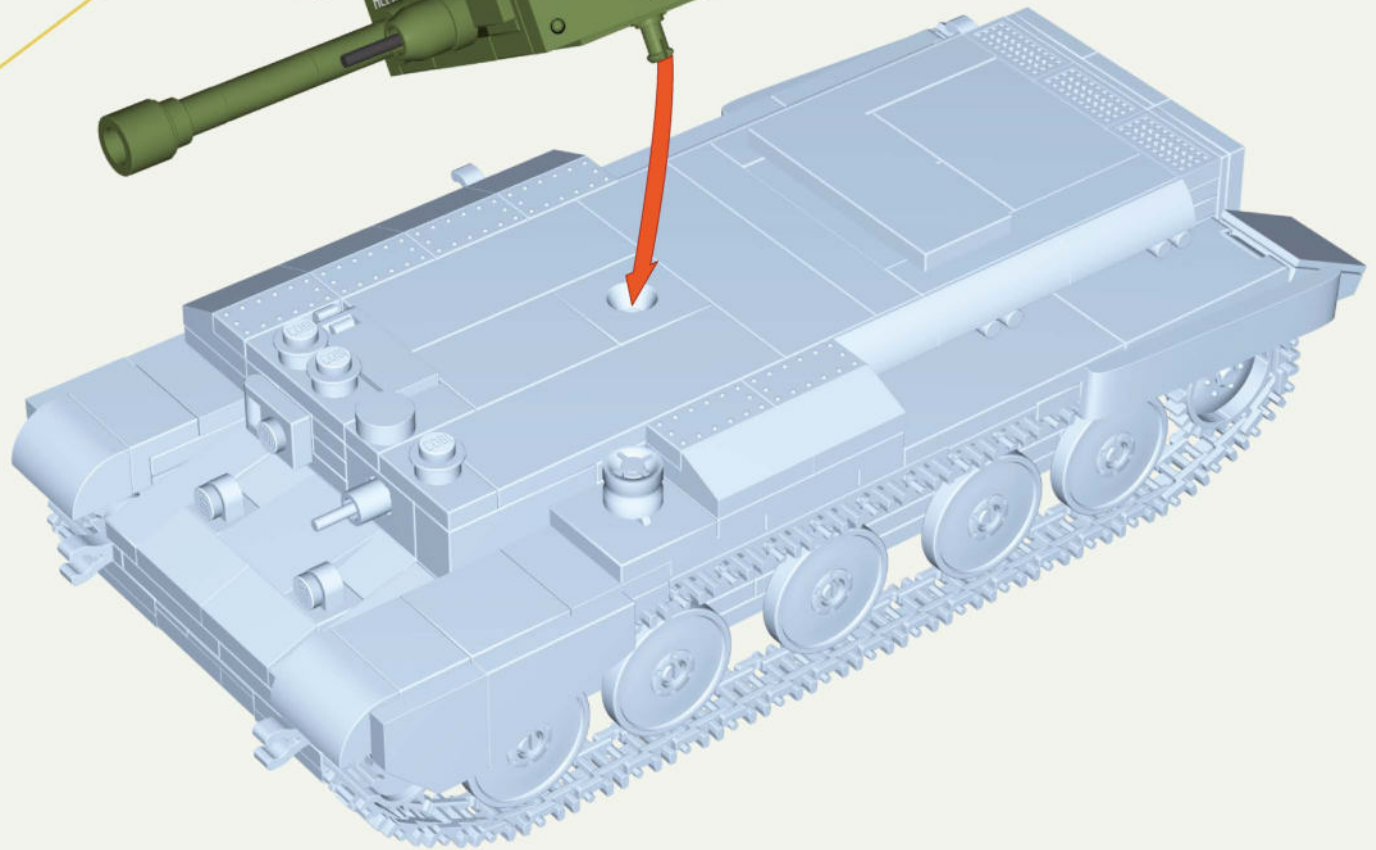

71

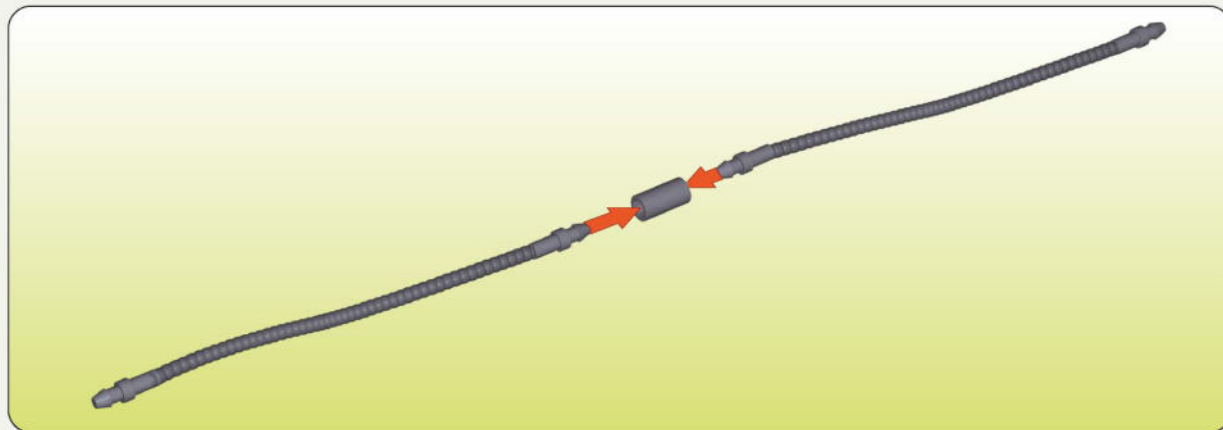
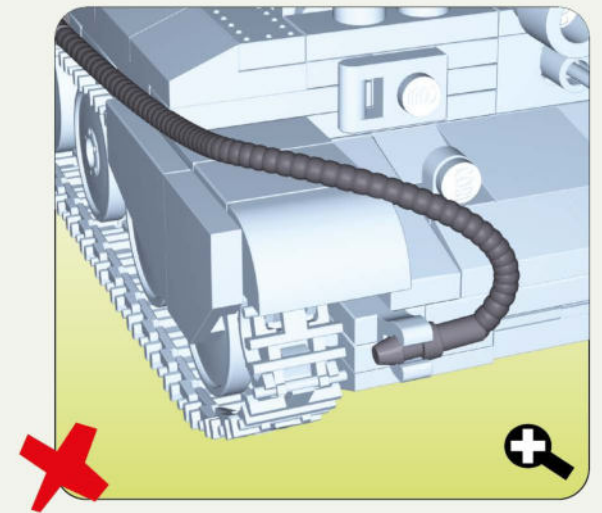
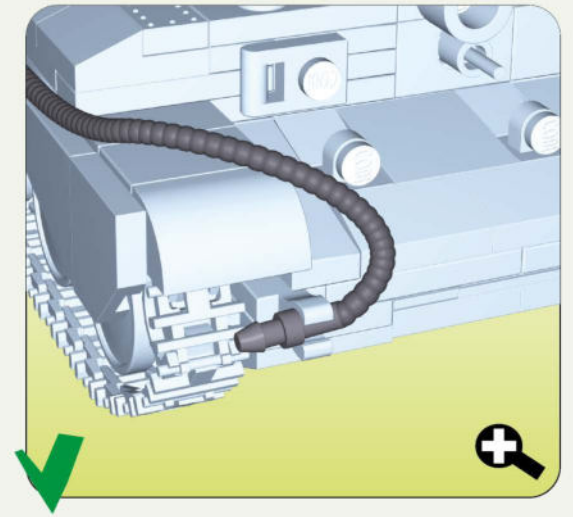
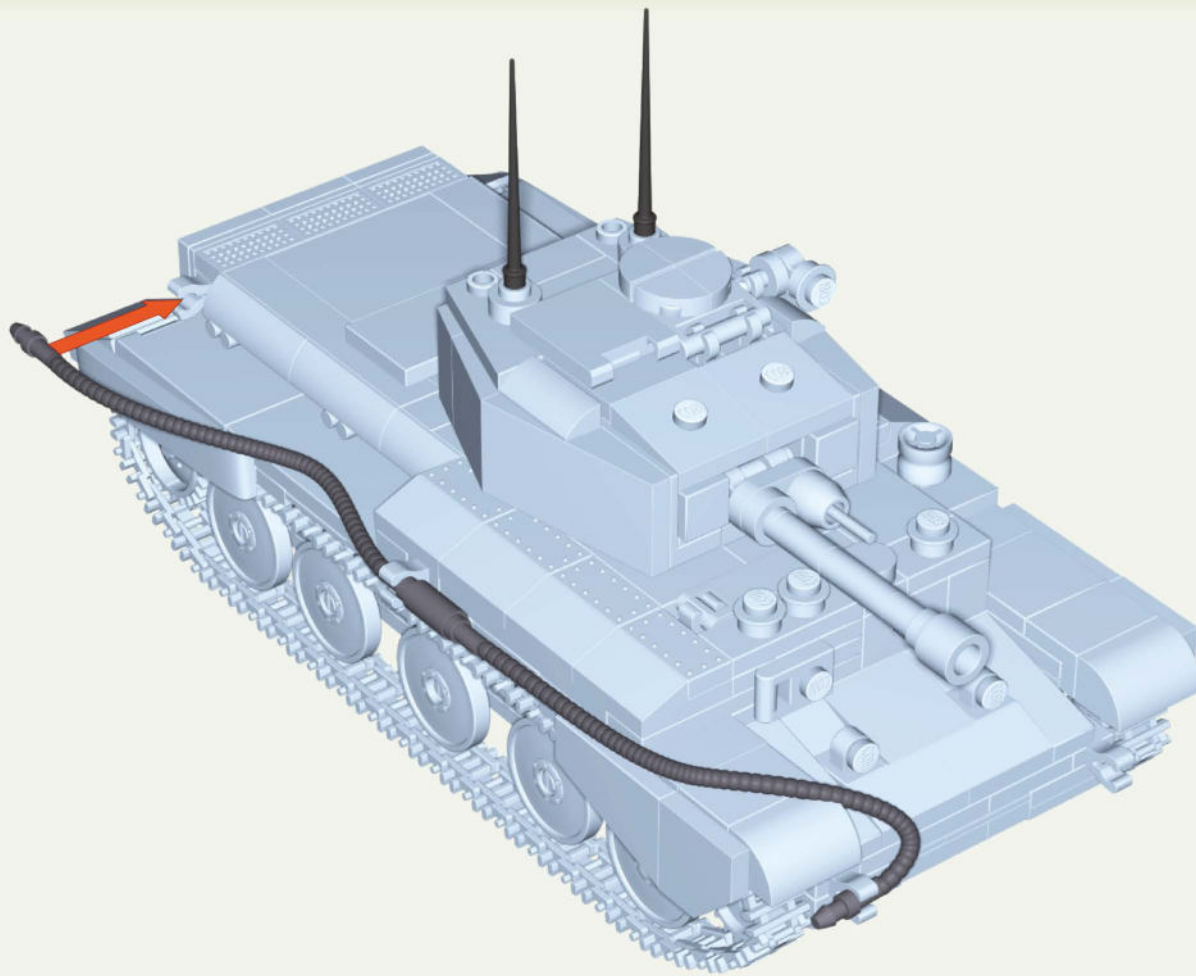

72



-  x2
-  x1
-  x2

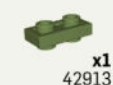
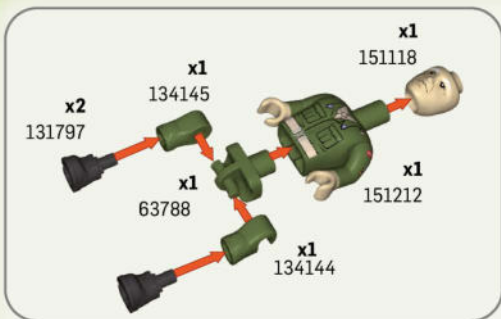





COMPANY OF HEROES 3

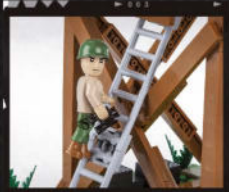

US AIR SUPPORT CENTER

★ 3042



GERMAN FIGHTING POSITION

⊕ 3043



HISTORICAL COLLECTION



PANZER III Ausf. J
+ 2562



M4A3 SHERMAN
+ 2570



PANZER II AUSF. A
SCALE 1:48
+ 2718



CHURCHILL MK. IV
SCALE 1:48
+ 2717

2269

CROWWELL
MK. IV



TABLE POINT

1.		22 cm	11.		4
2.		10 cm	12.		3
3.		-5 cm	13.		1
4.		-5 cm	14.		2
5.		+10 cm	15.		-
6.		3-6	16.		-
7.		5-6	17.		1
8.		9	18.		5
9.		2+	19.		80
10.		8	20.		Available 1944



2269



Sd. Kfz 9/1 „FAMO”

+ 2281



H.M.C M8 SCOTT

★ 2279



Sd.Kfz.7 HALF-TRACK

+ 2275

WWW.COBIGAMES.COM

CROMWELL MK.IV



SHERMAN IC FIREFLY HYBRID

🇵🇱 2276

WWW.COBI.EU

01-02269-533

For news and special deals

Find us on:

