

Maserati MC20



MASERATI

OFFICIAL LICENSED PRODUCT



24335

Maserati logo and model designations are registered trademarks or exclusive propriety of Maserati S.p.A. Under license of Maserati S.p.A. All rights reserved.

PAD PRINTED
NO STICKERS

Printed in EU



WARNING: CHOKING HAZARD-
Toy contains small parts.
Not for children under 3 years.

2269

Maserati MC20

SCALE 1:12



+



+



BE CAREFUL: NOTICE THE DIFFERENCE

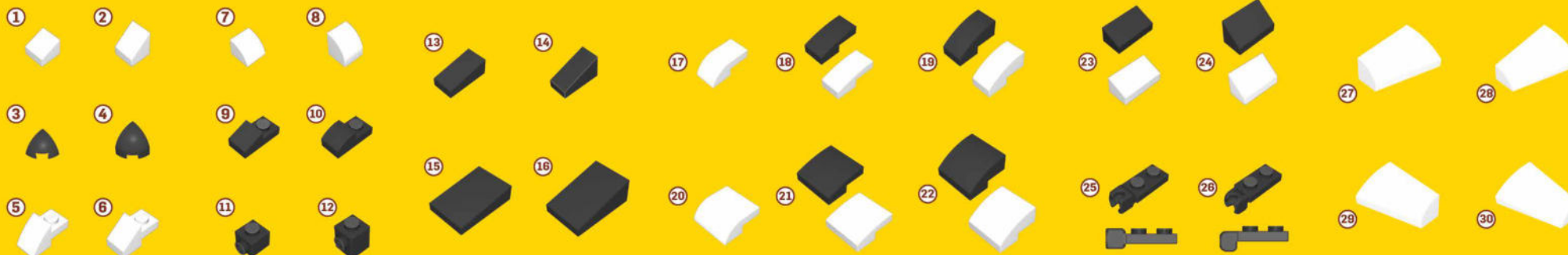

UWAGA: RÓŻNE KLOCKI



1

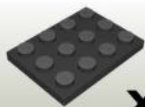
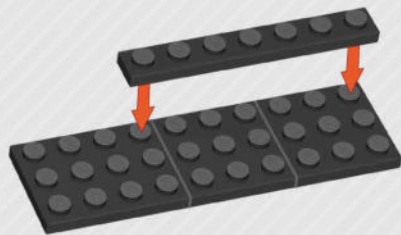

x1

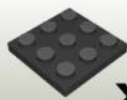

x2



x1

2



x1



x1

3

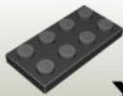

x1



x1



x1

4

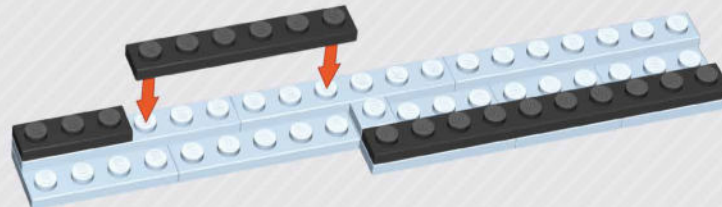

x1

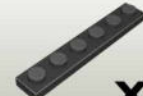

x1



x1

5



6

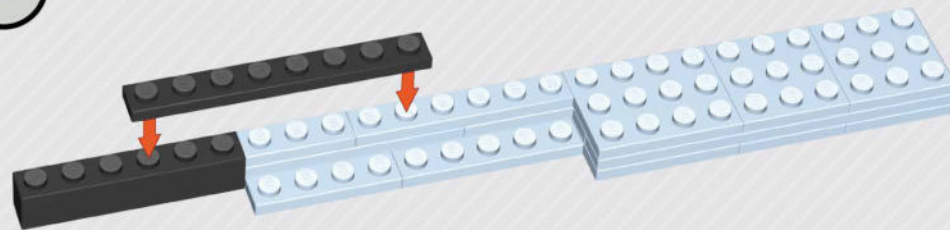

7



8

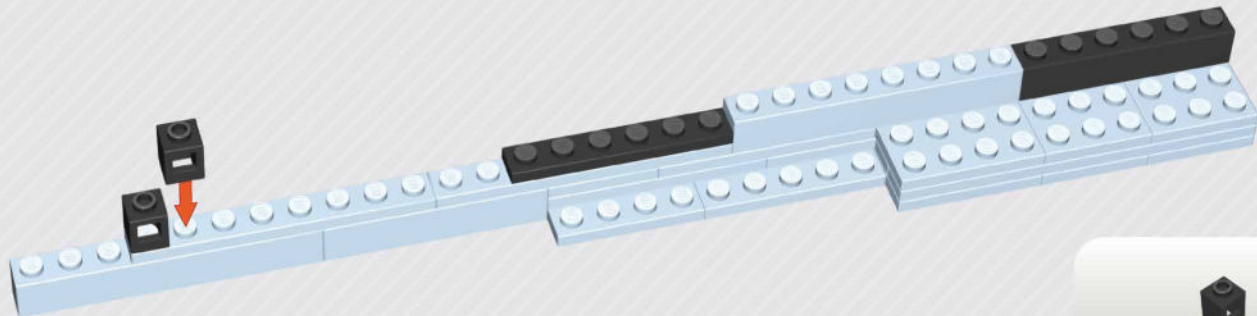

9

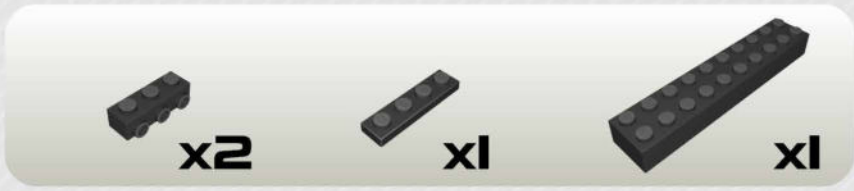
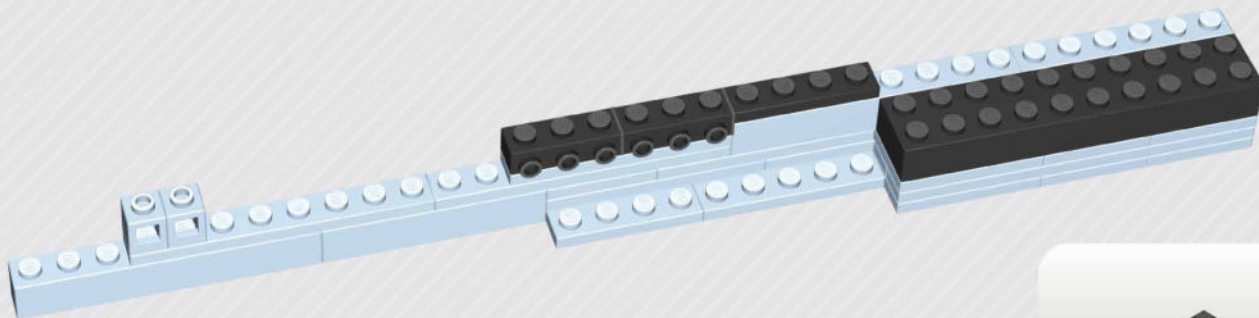

10



11



15

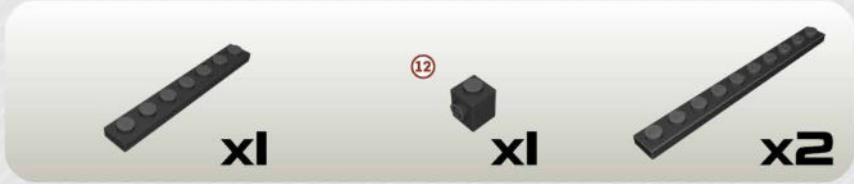

16

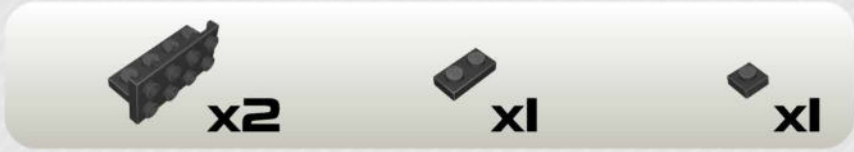
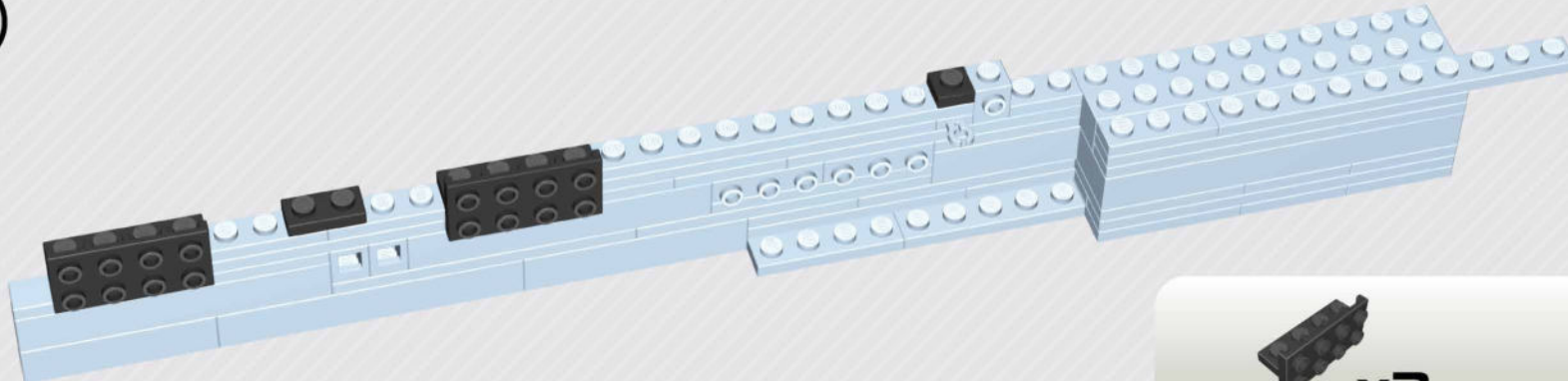

17

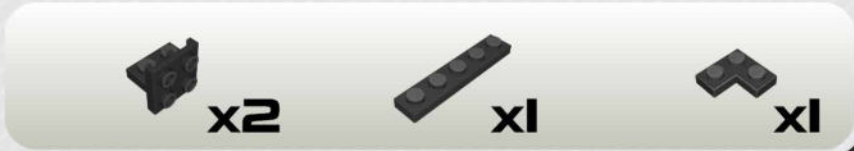
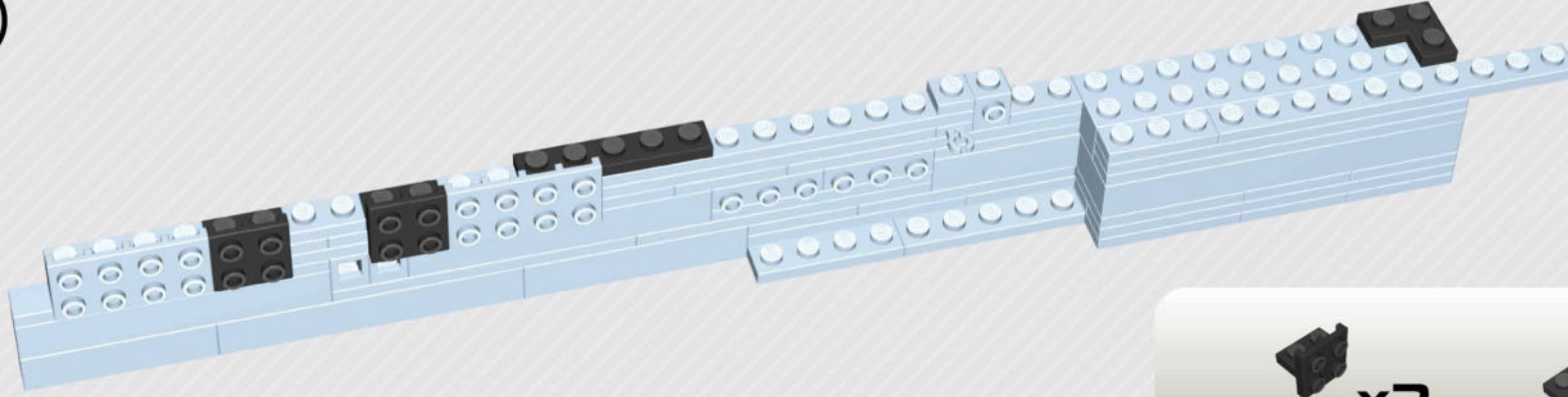

18

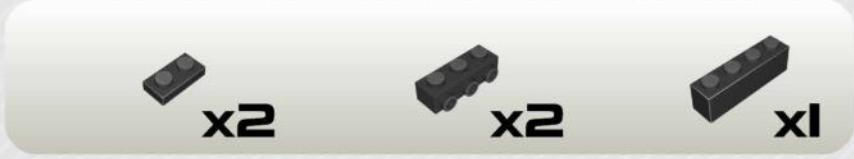
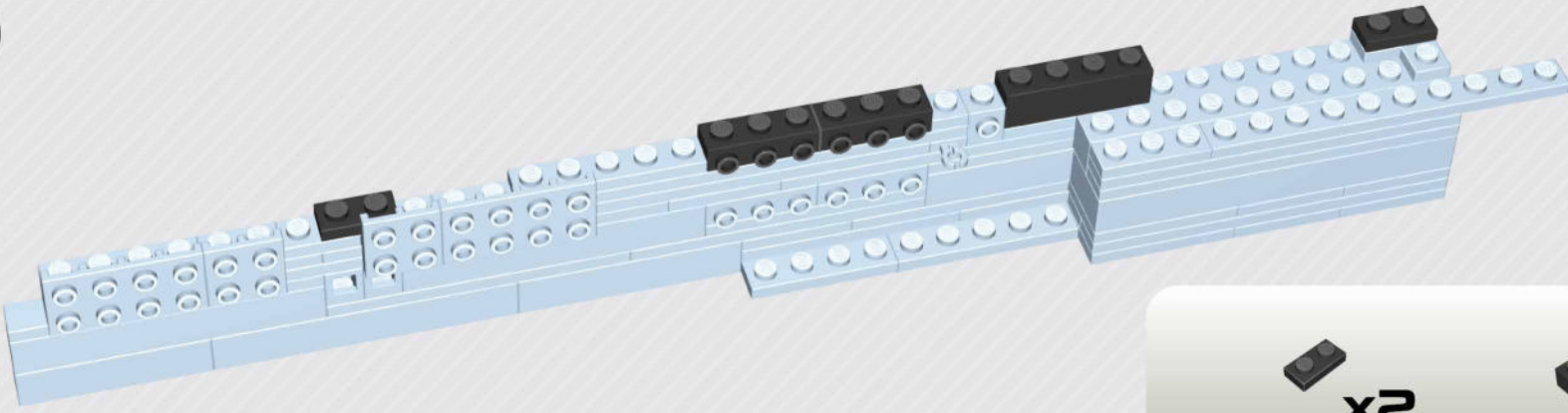

19

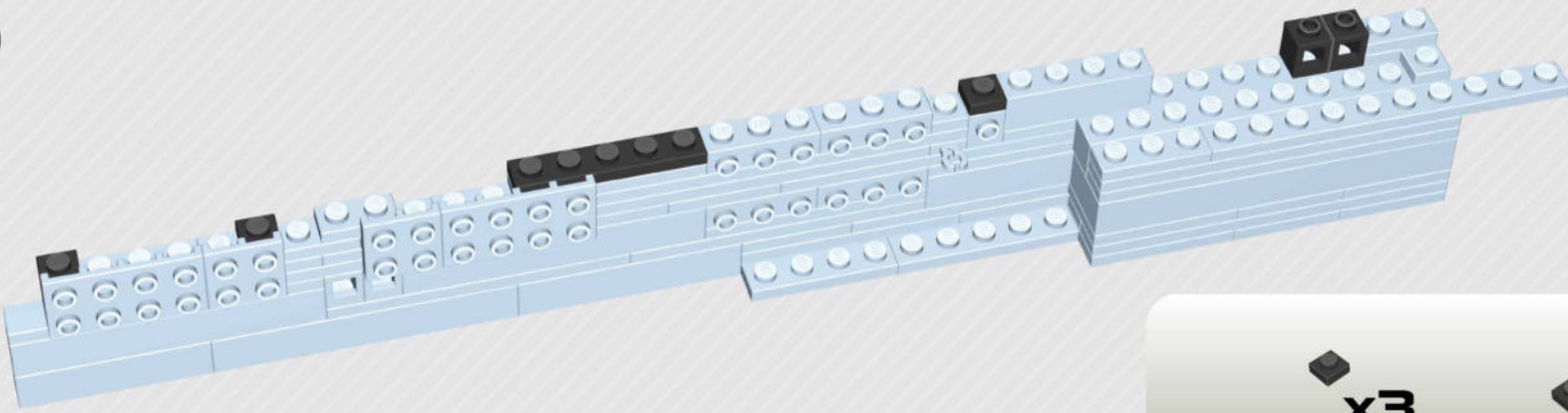

20

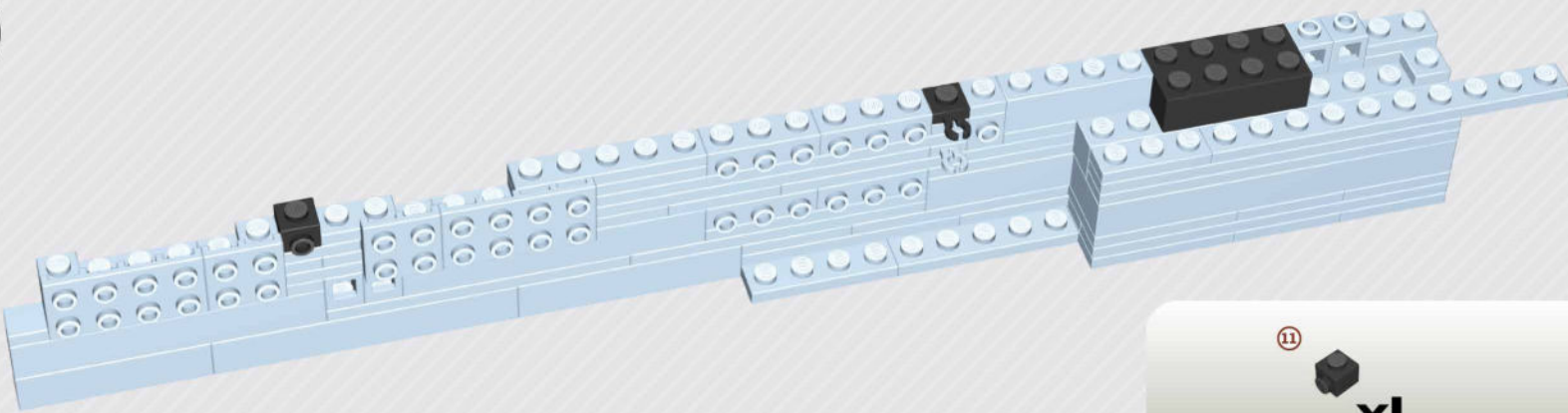

21

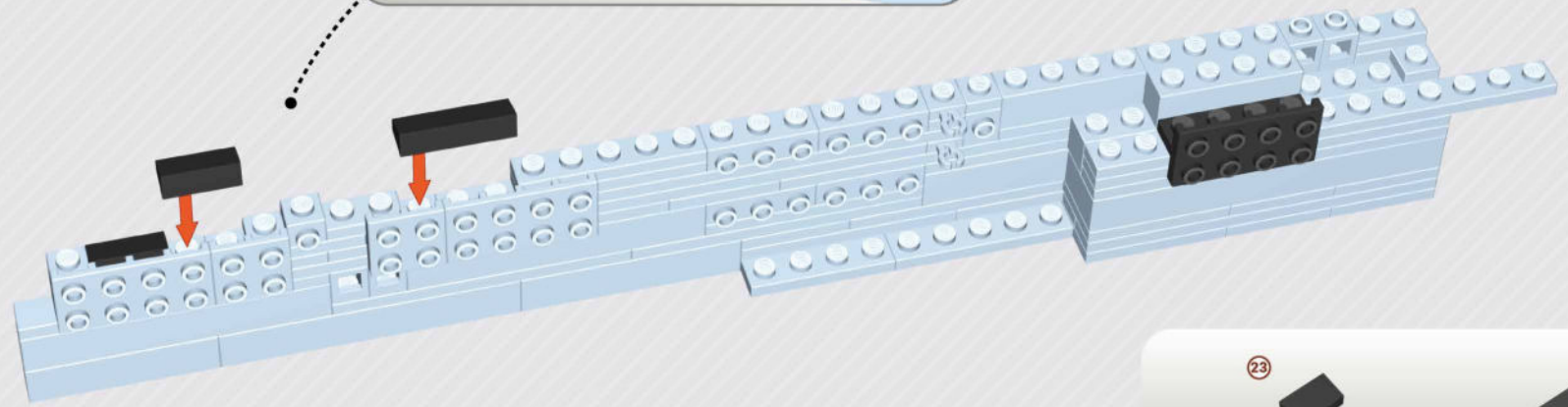
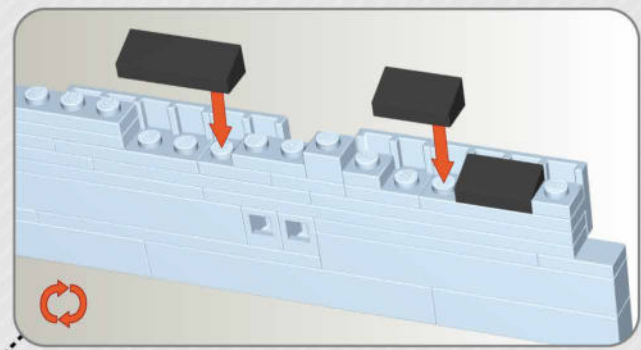

 **x2**
  **x1**
  **x1**

22

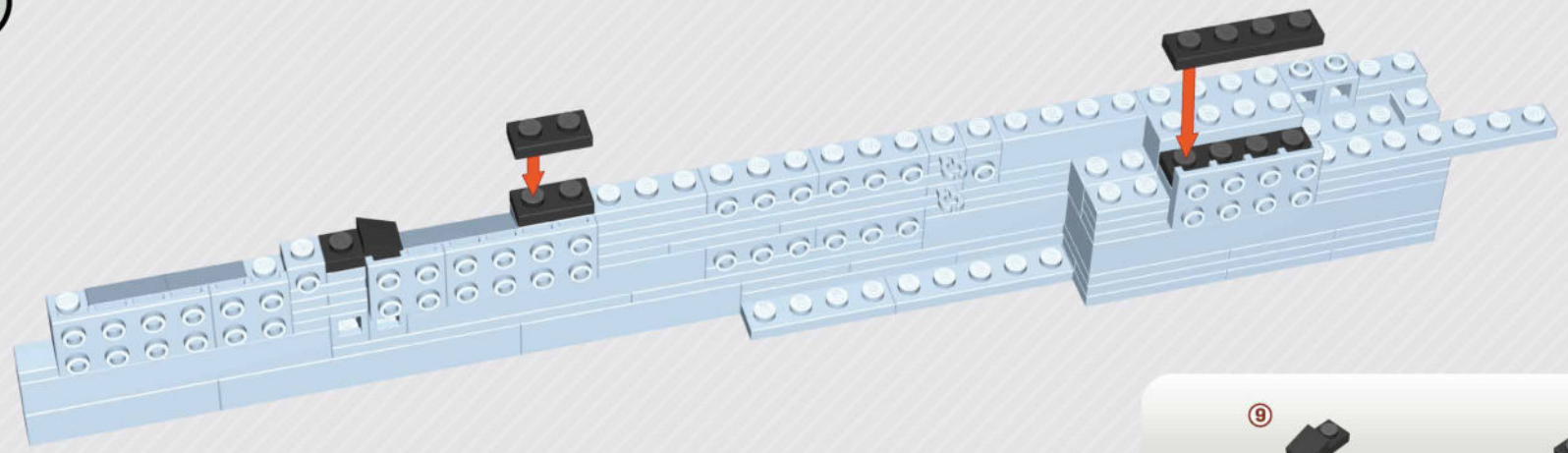

 **x1**
  **x2**
  **x2**

23

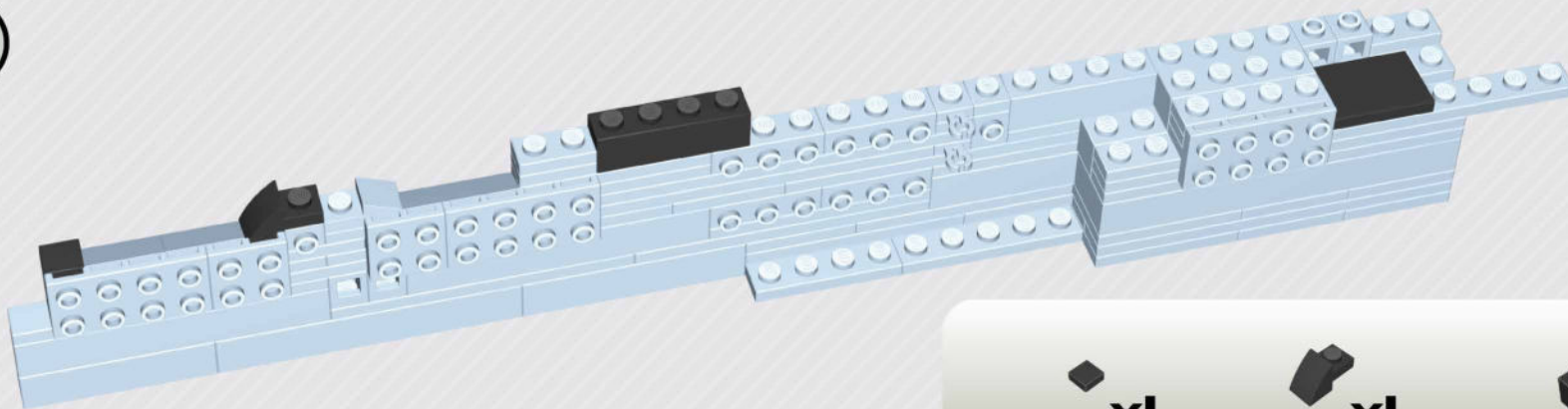

x1



x1

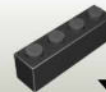

x1

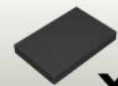

x1

24

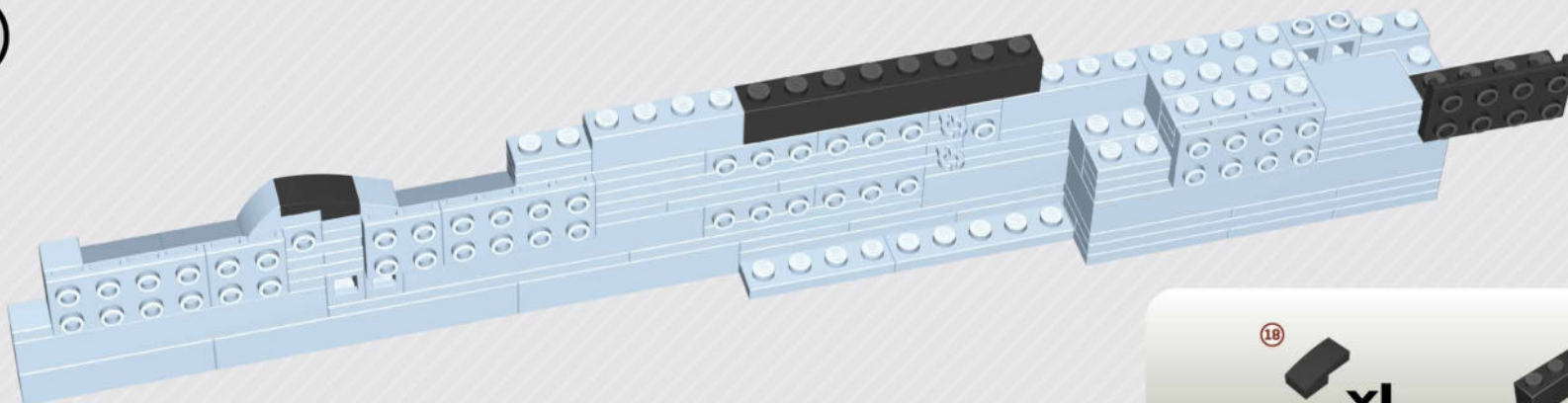

18



x1

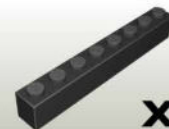

x1

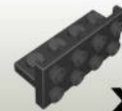

x1

25

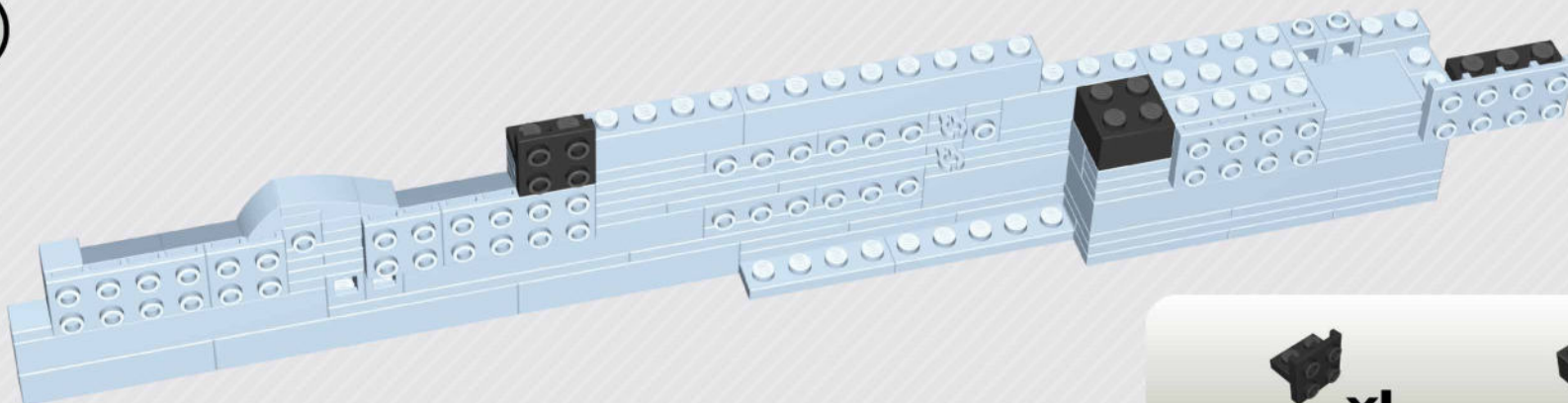

x1



x1



x1

26

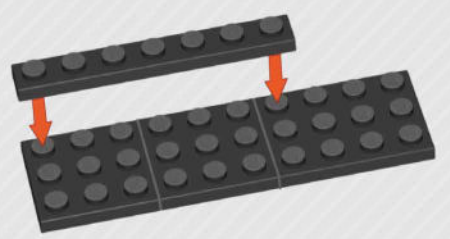

27

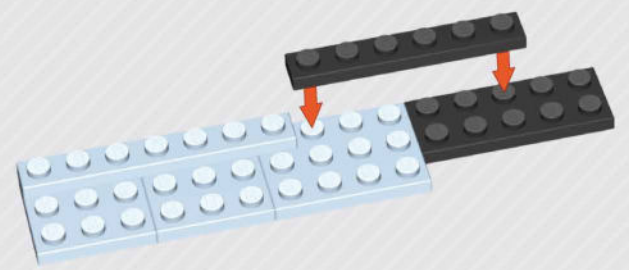

28

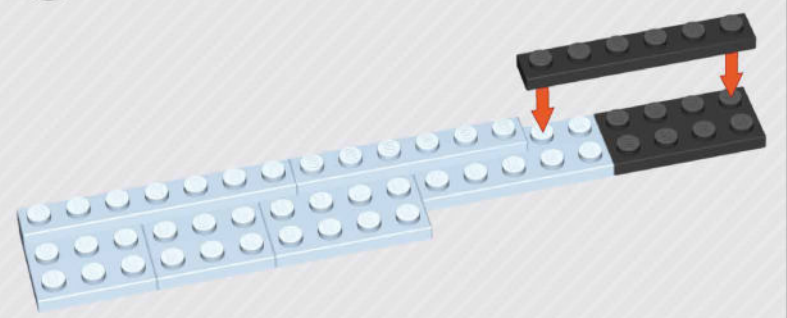

29

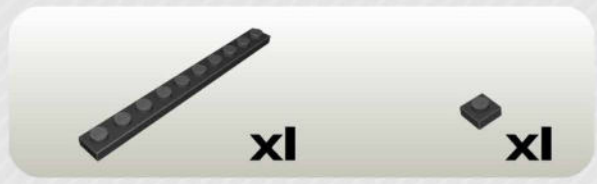

30

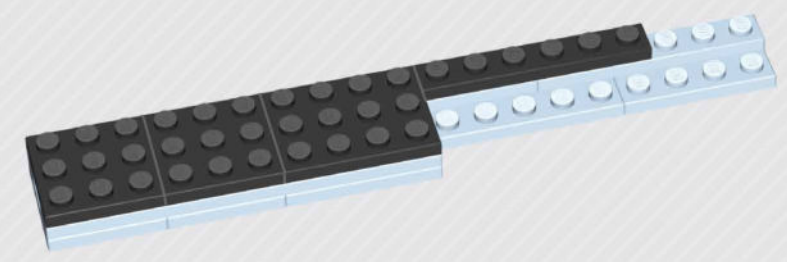

31

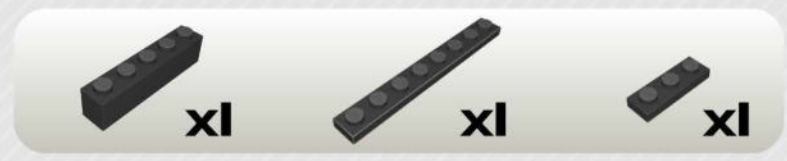
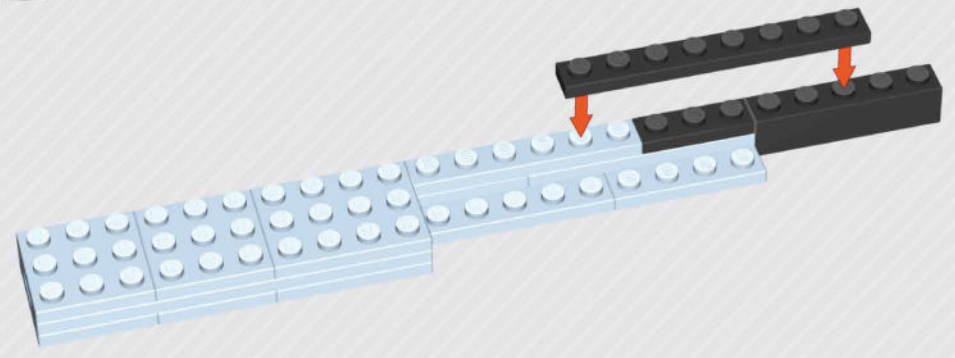

32

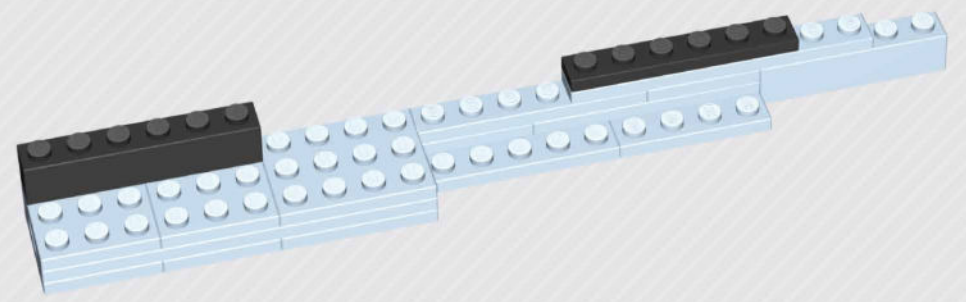

33

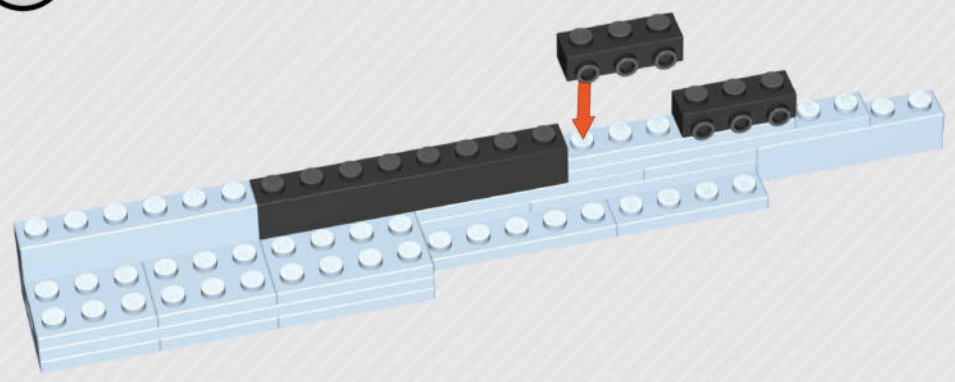

34

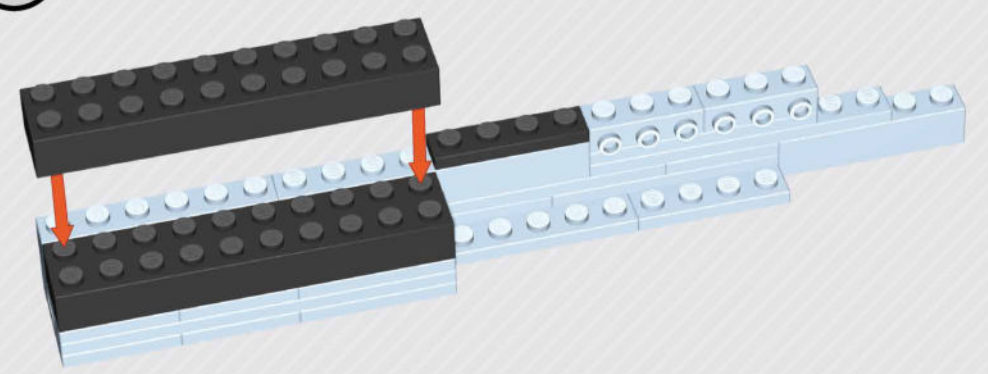

35

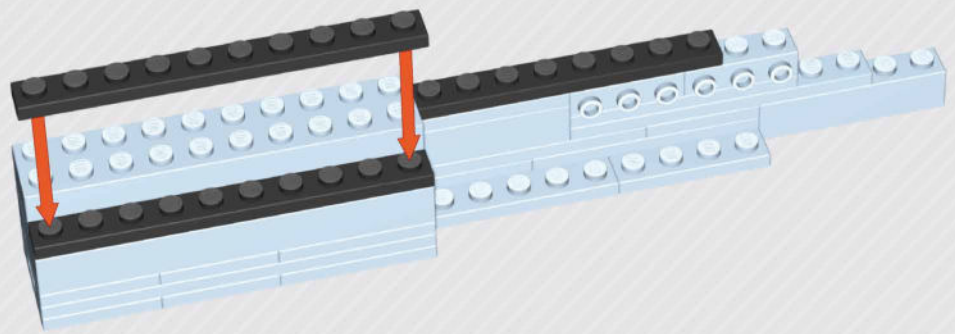

36

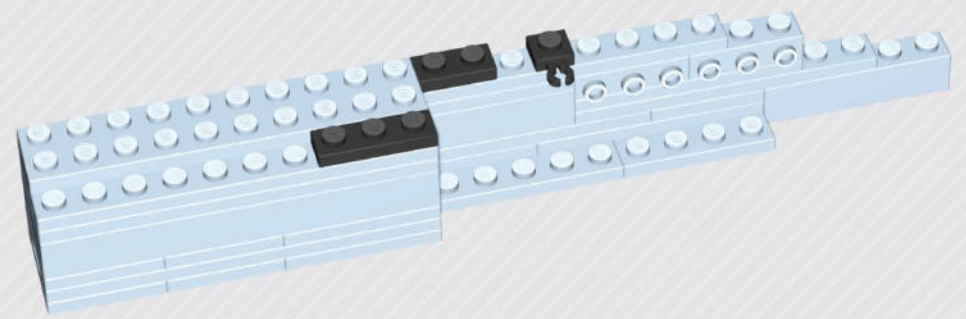

37



38

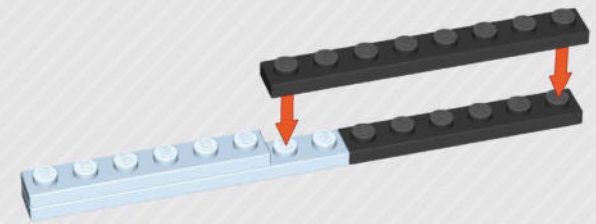

39



40

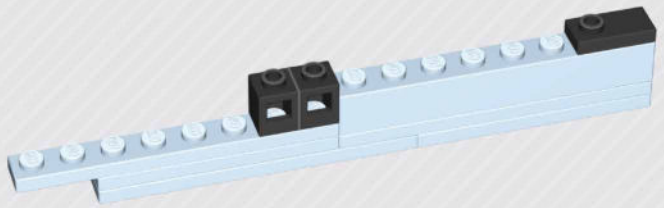

41

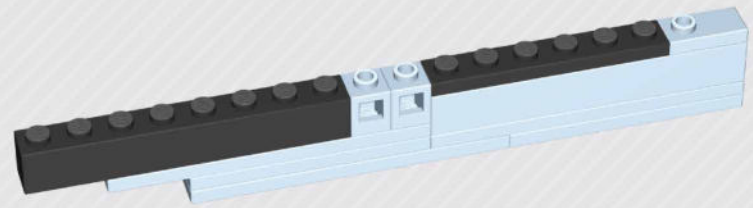

42

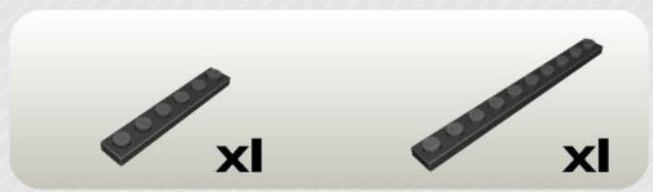
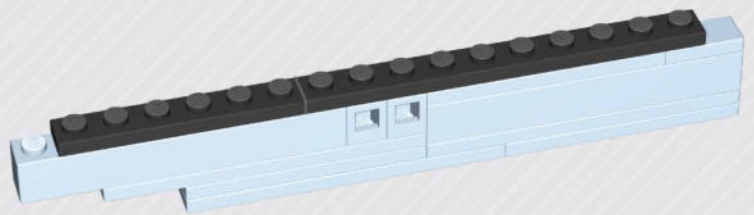

43

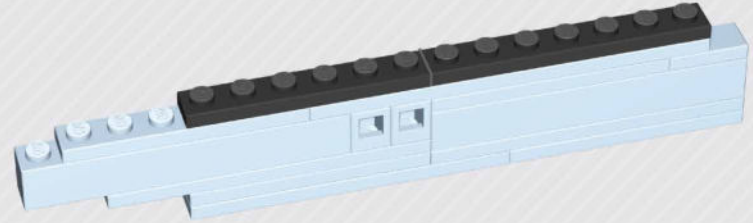

44

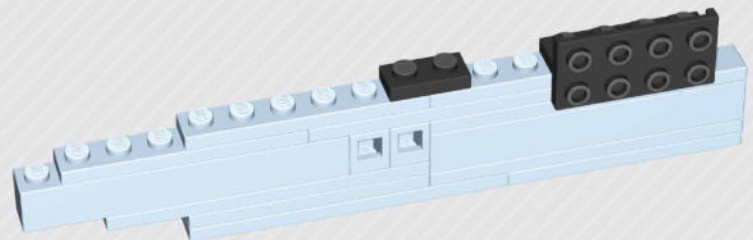

45

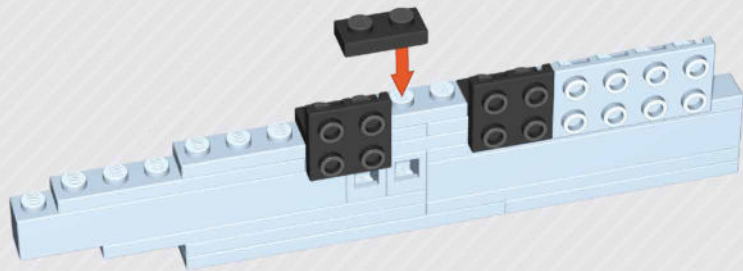

x2



x1

46

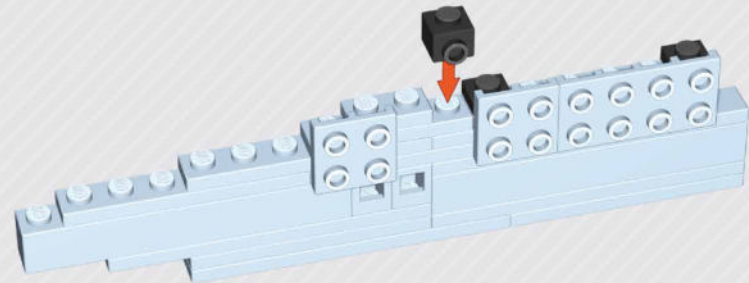

11



x1



x2

47

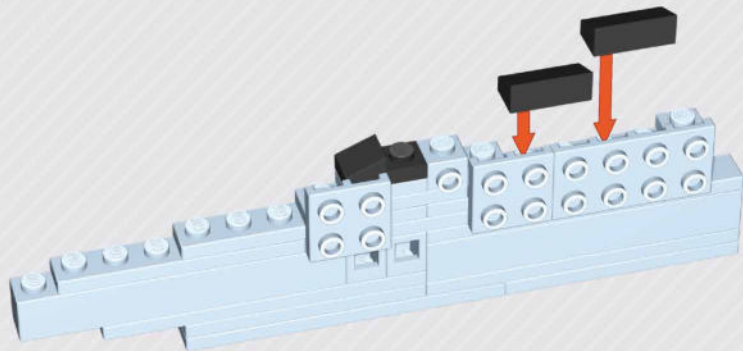

9



x1

23



x2

48

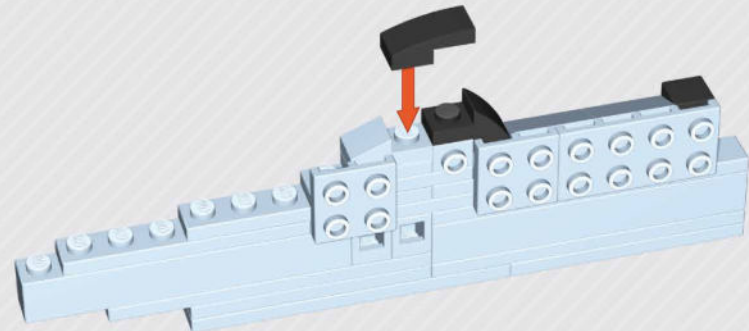

18



x1



x1



x1

49

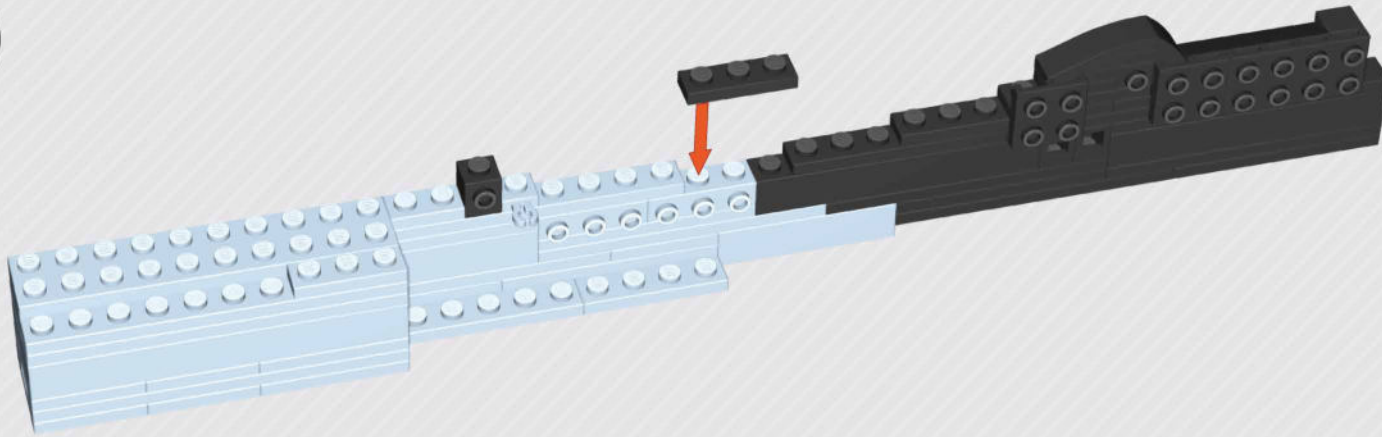

12



x1



x1

50

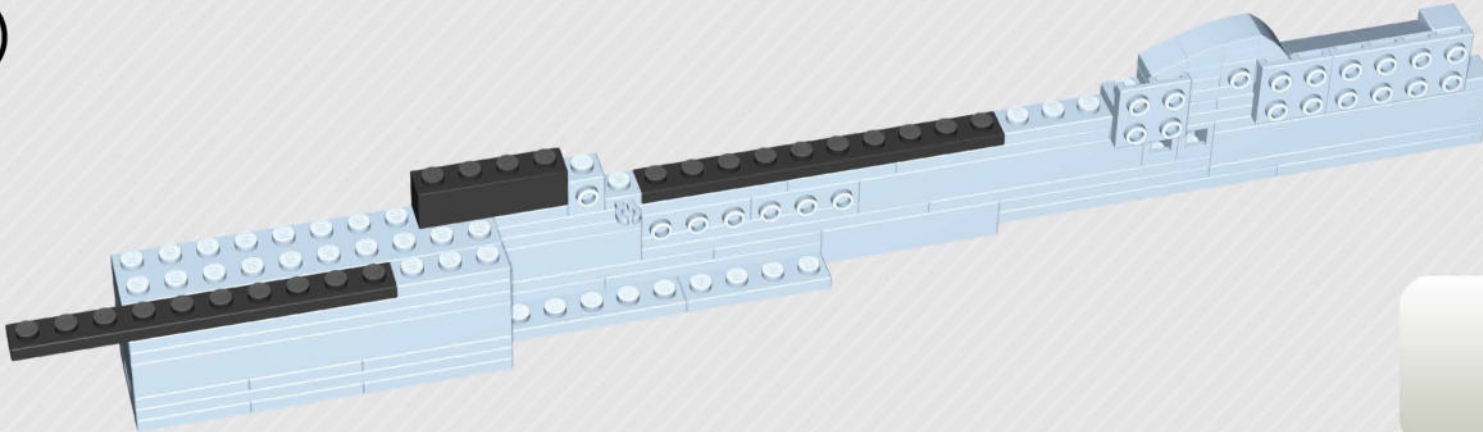

x2



x1

51

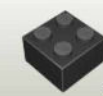
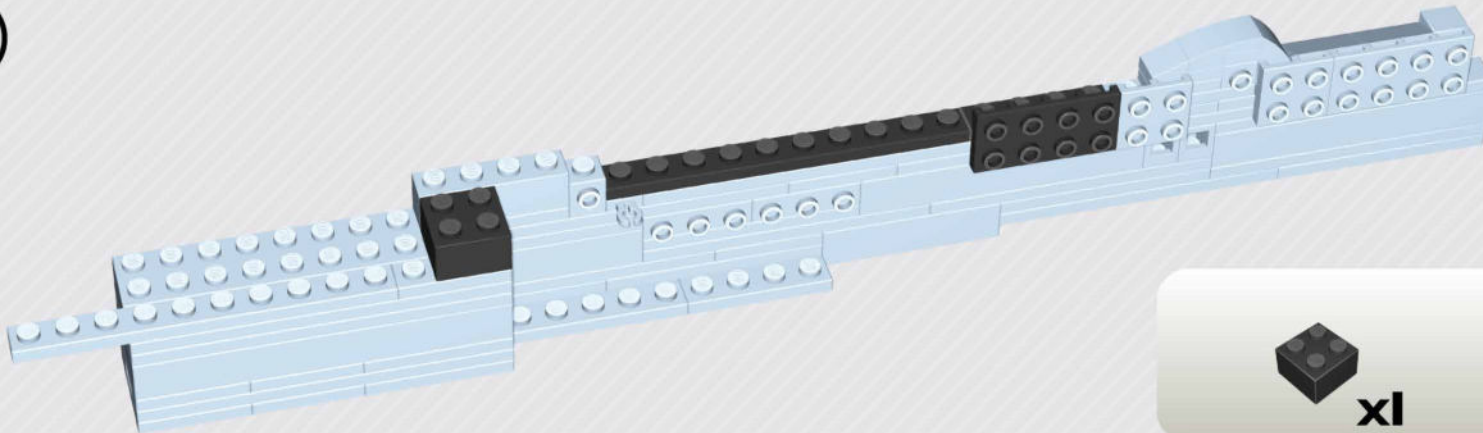

x1



x1

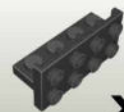

x1

52

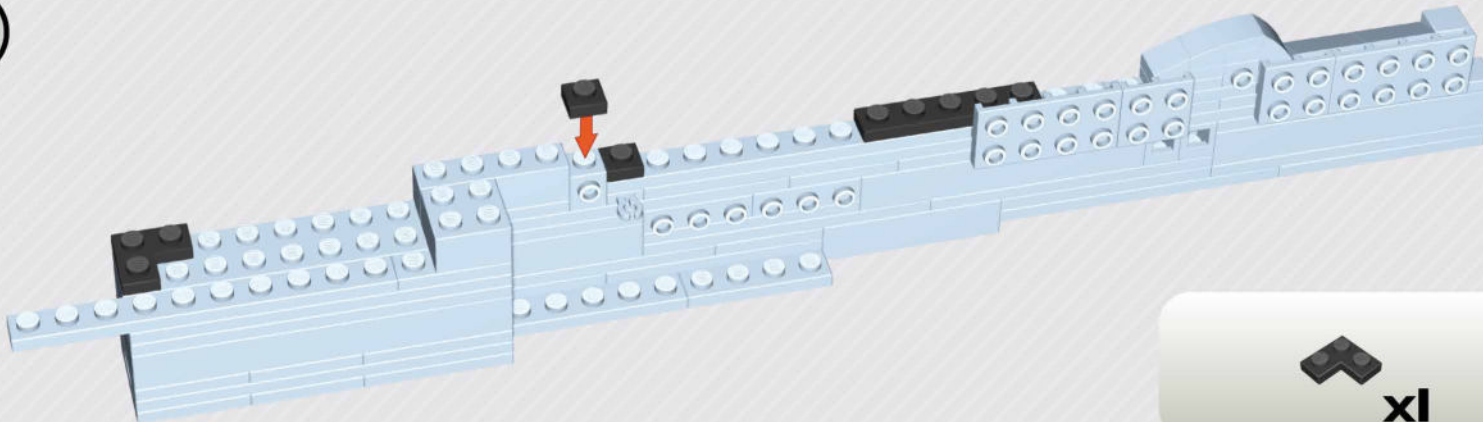

x1



x2



x1

53

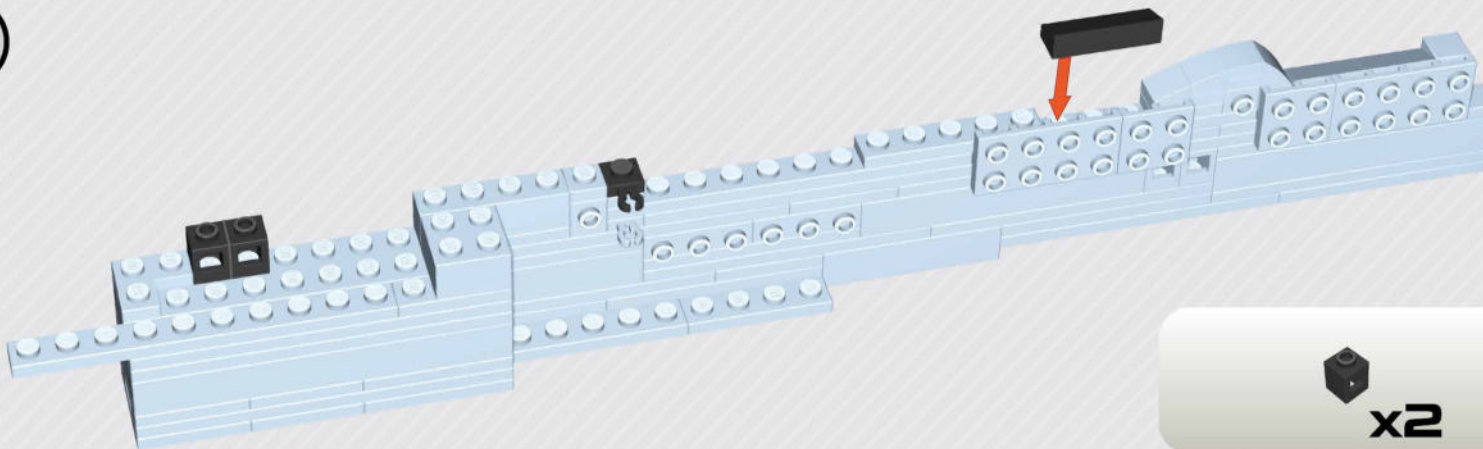

x2



x1



x1

54

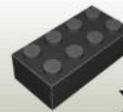
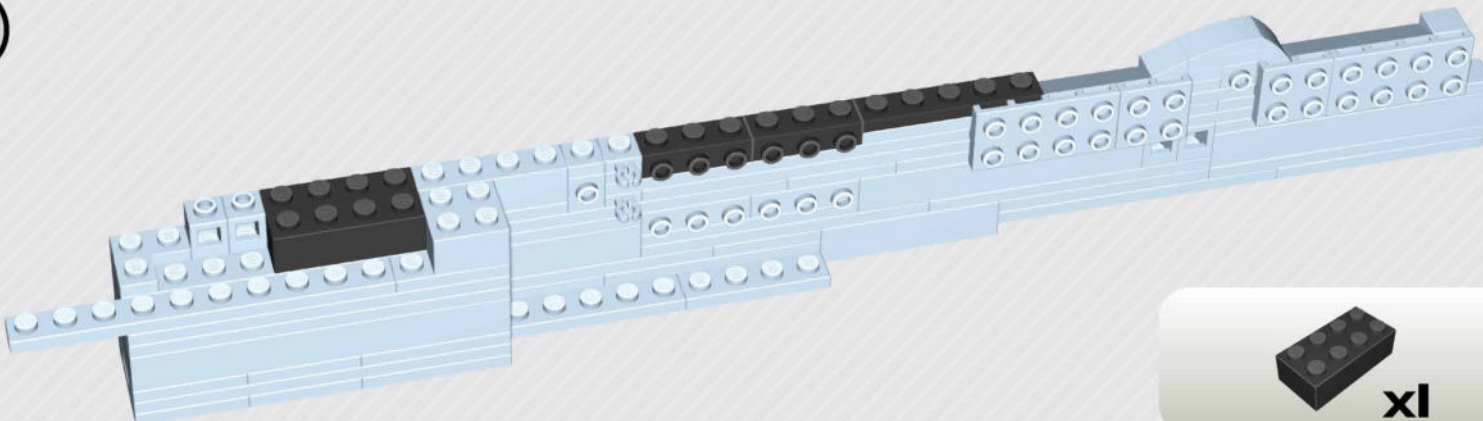

x1



x2



x1

55

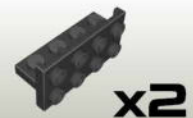
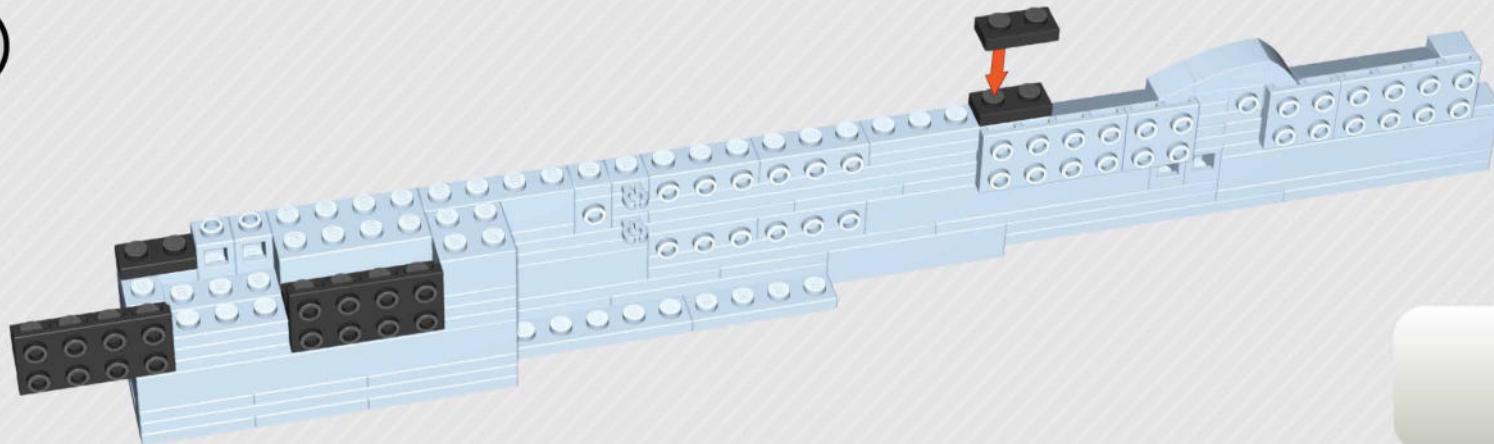

56



57

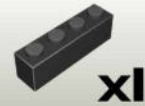
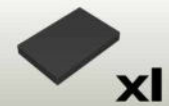
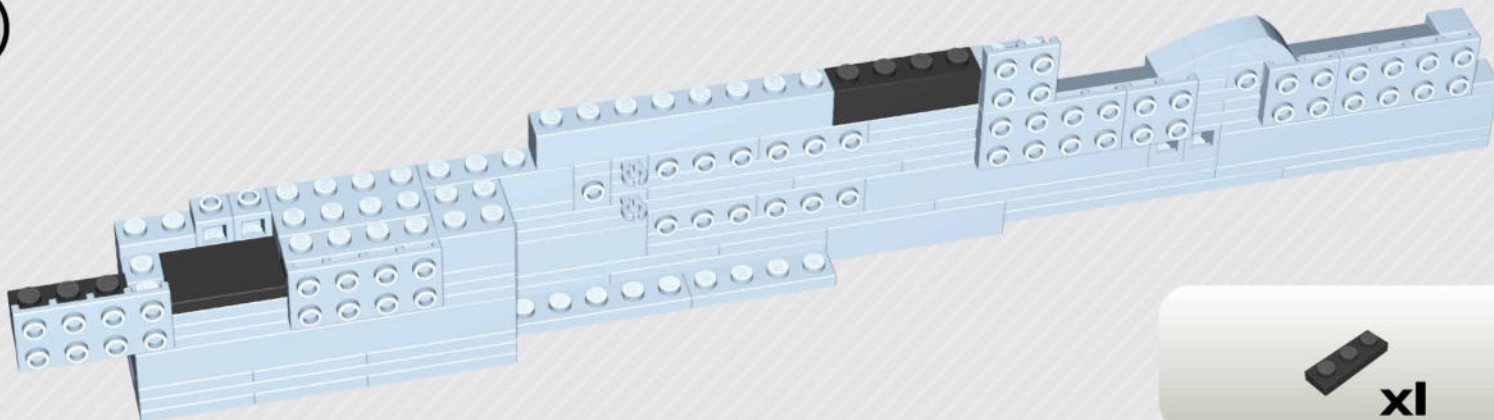

58

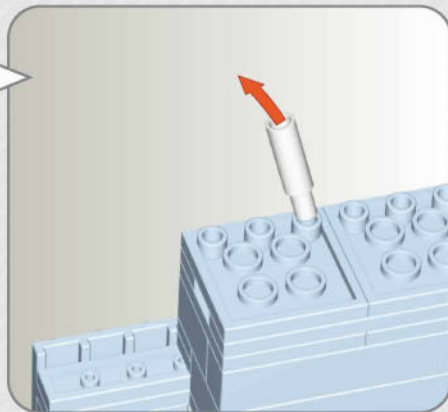
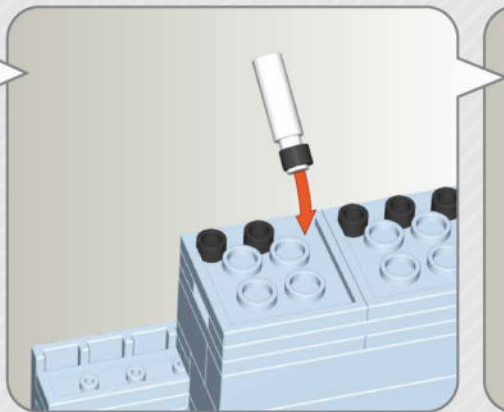

x10  x4 

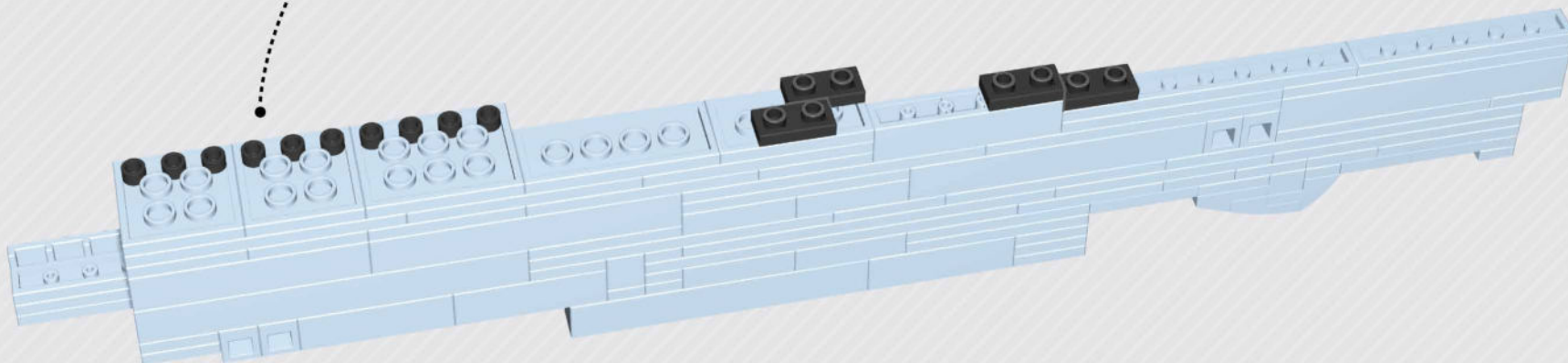

59

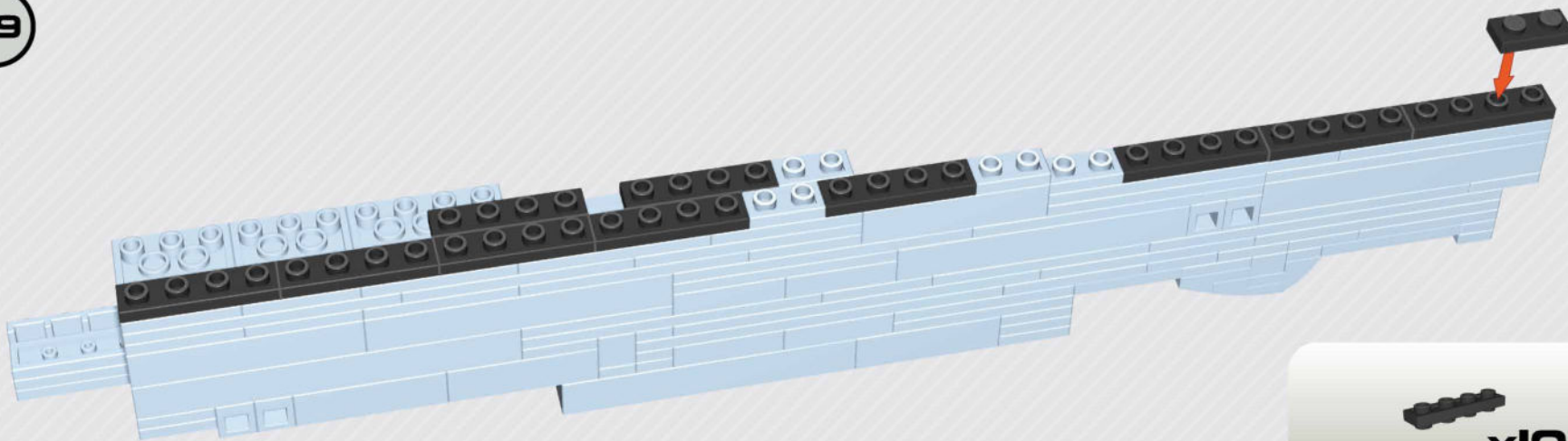

x10  x1 

60

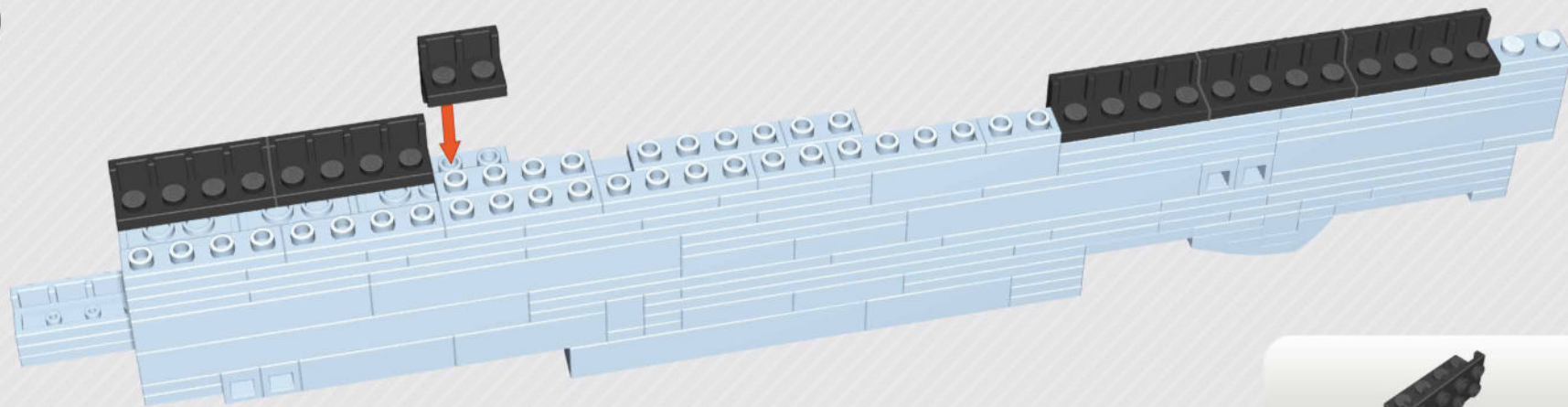

61

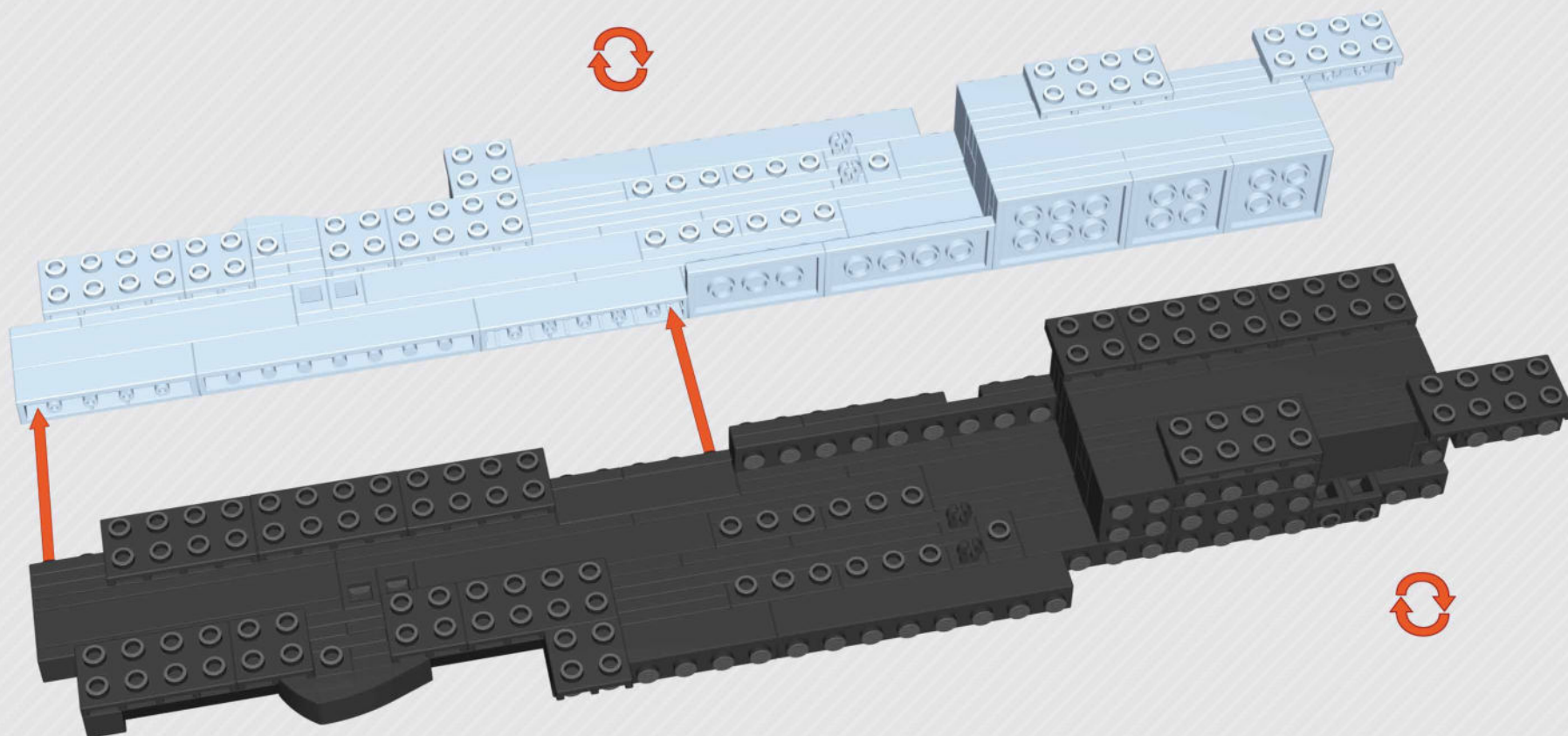

62

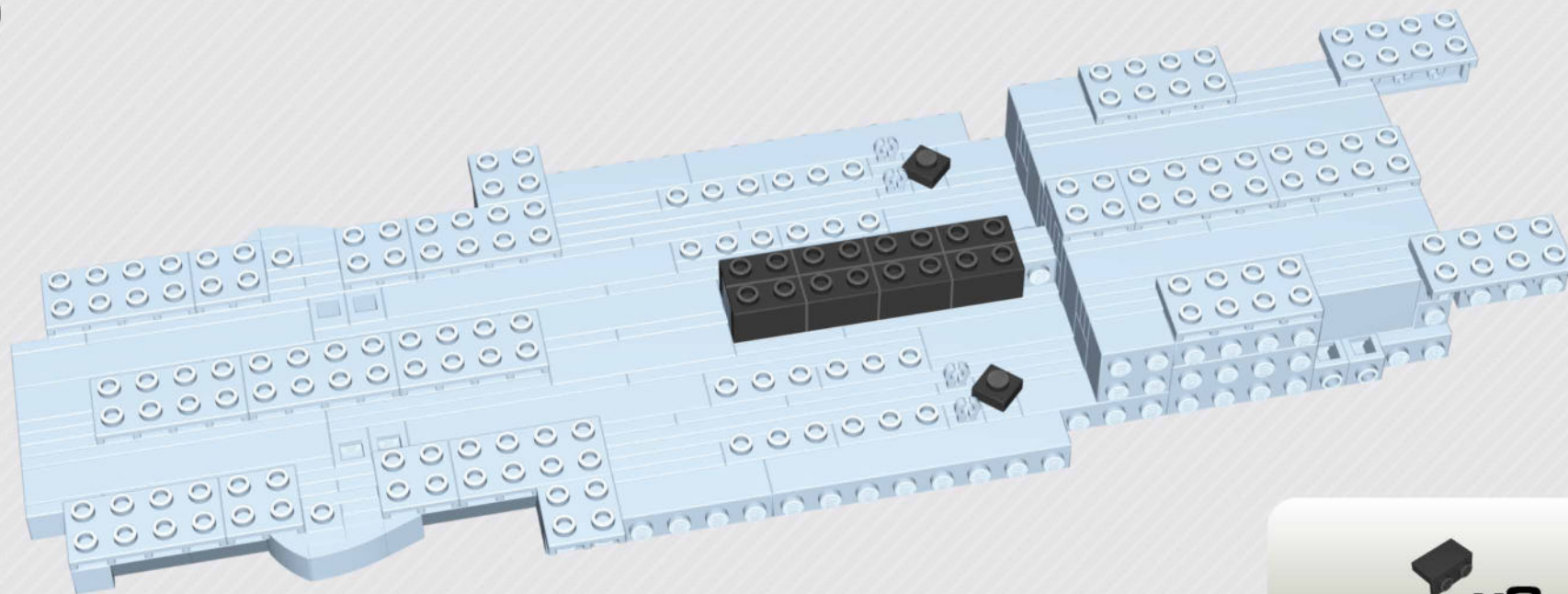

 x8

 x2

63

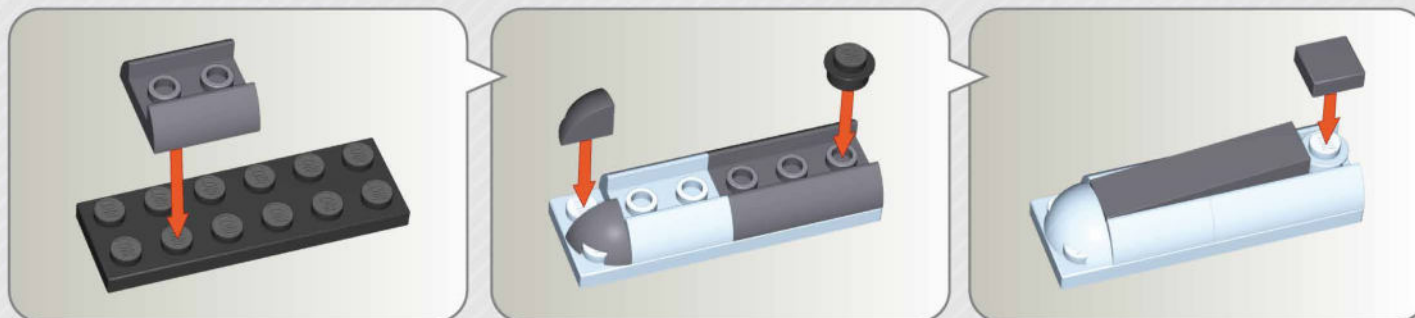

 x1

 x1

 x1

 x2

 x1

 x1

 x1

64

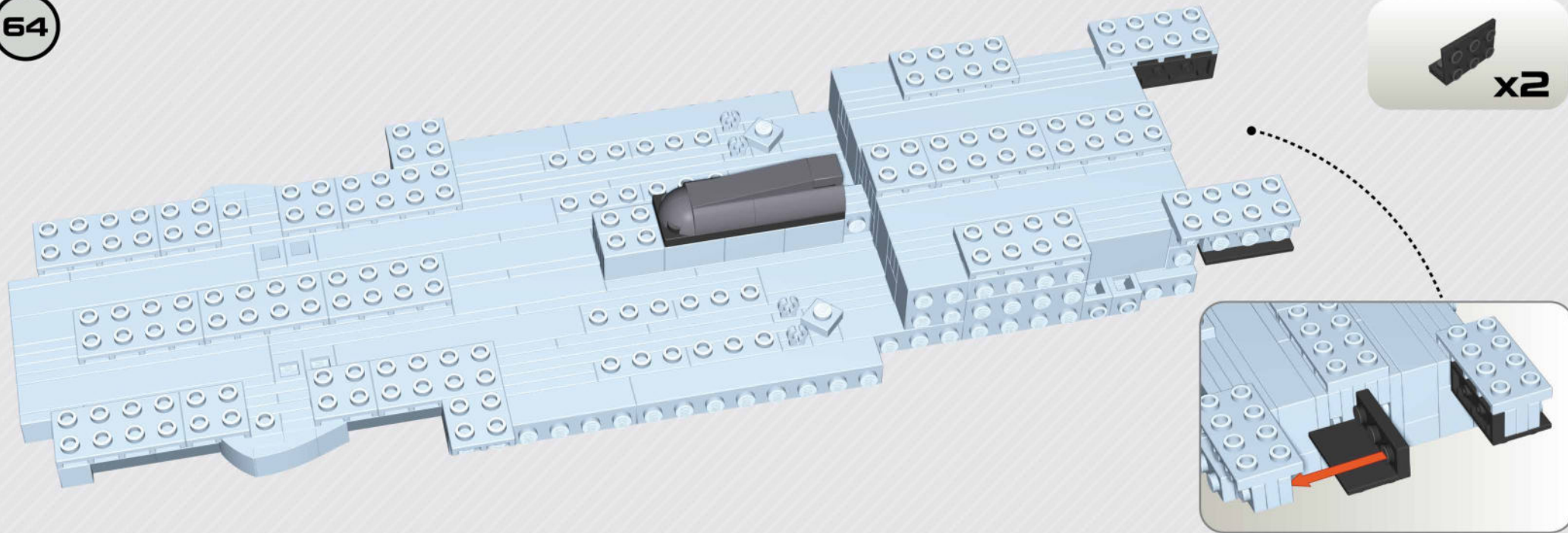

65

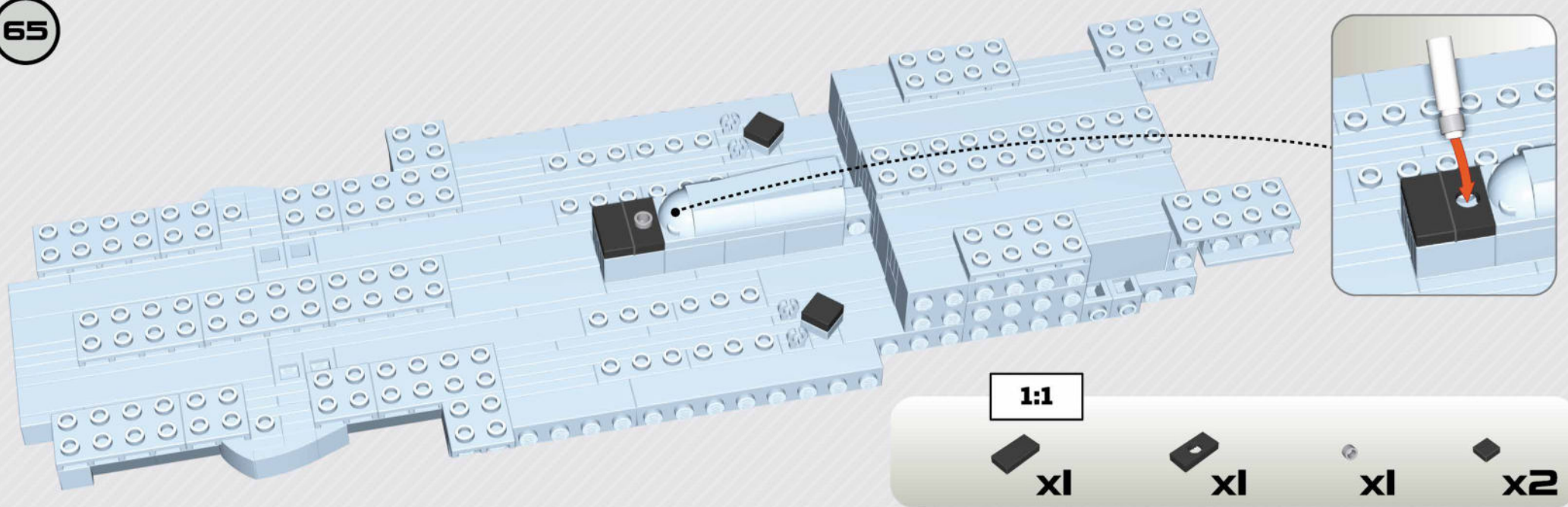



66

A

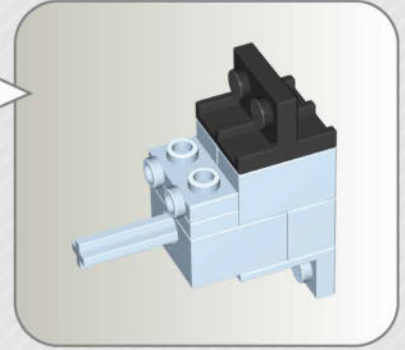
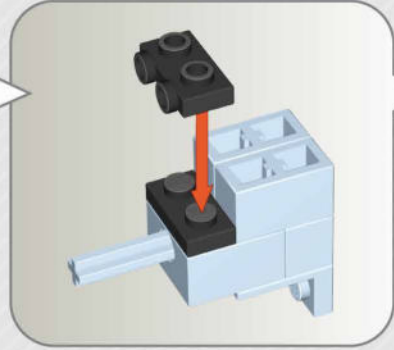
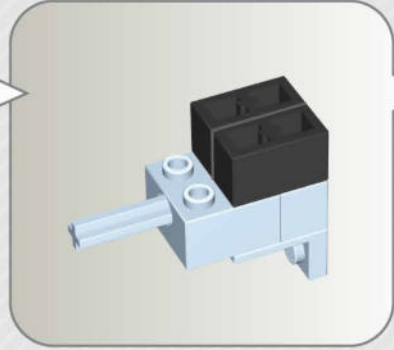
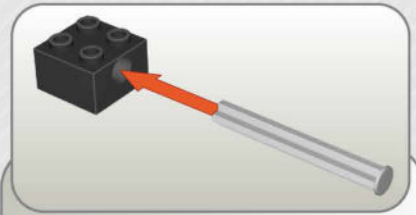
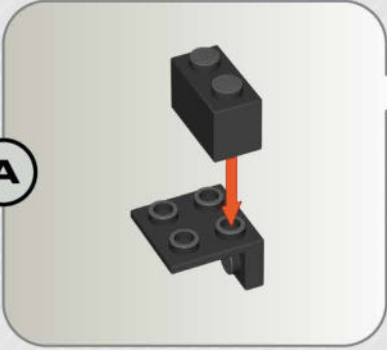

B

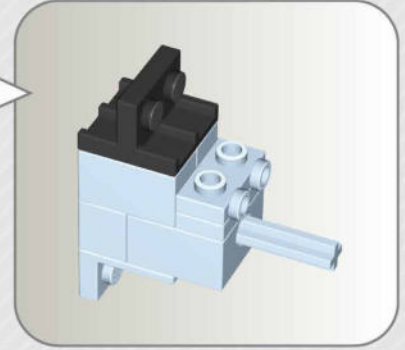
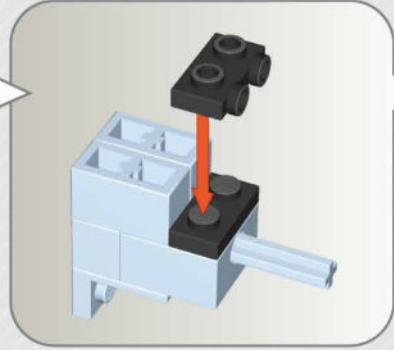
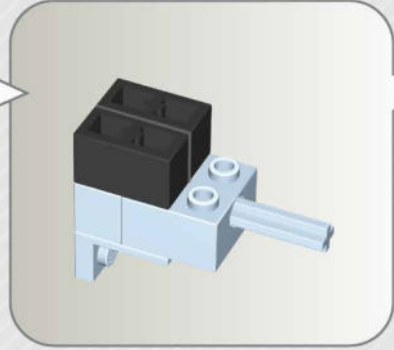
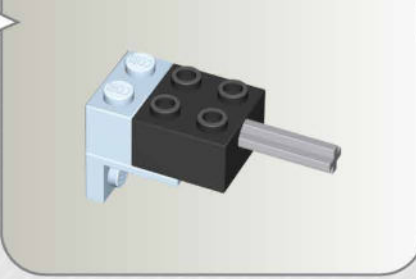
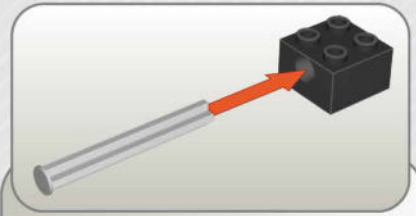
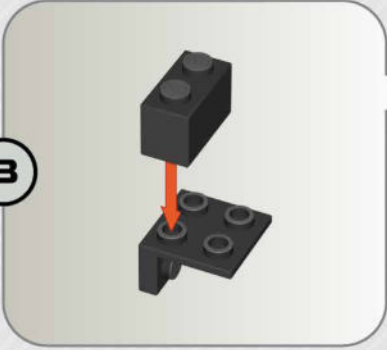

67

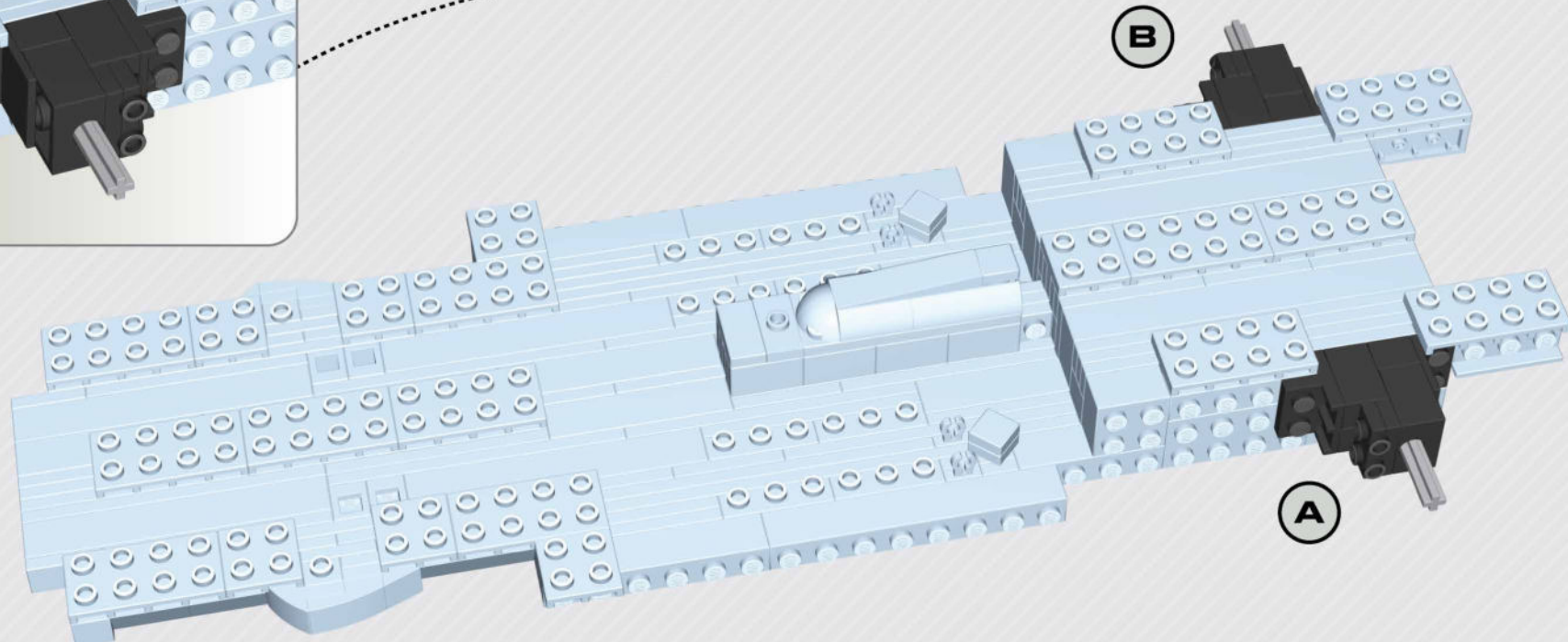
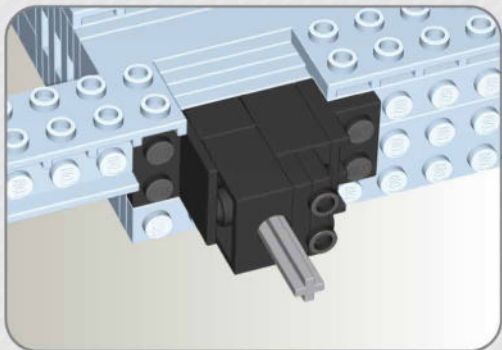

68

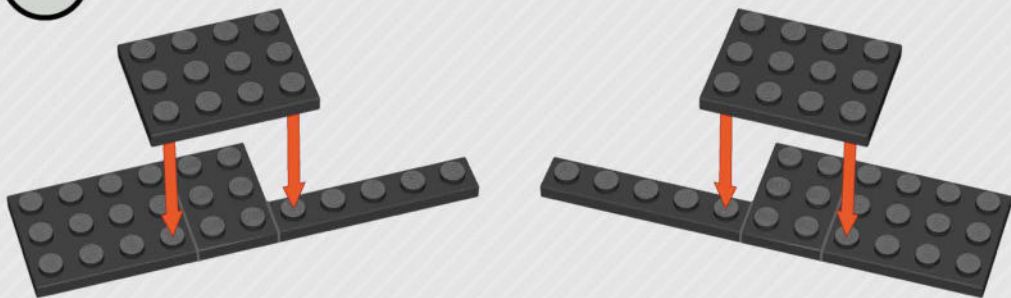

69



70

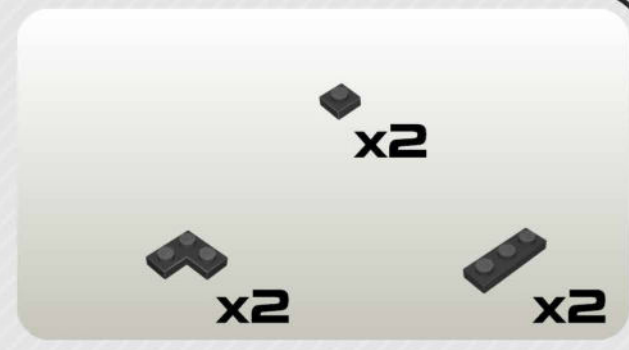

71

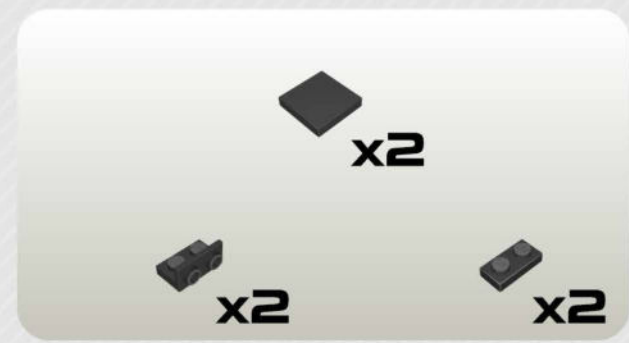

72

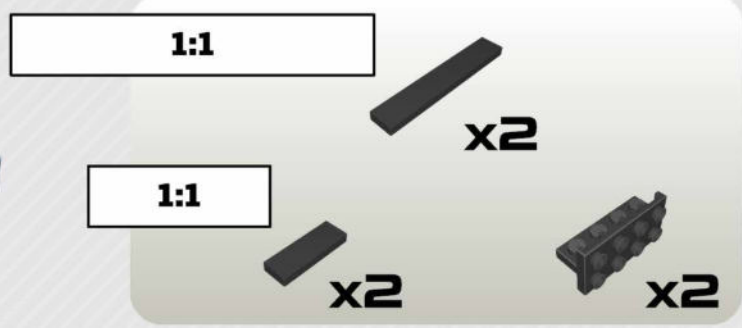

73



74

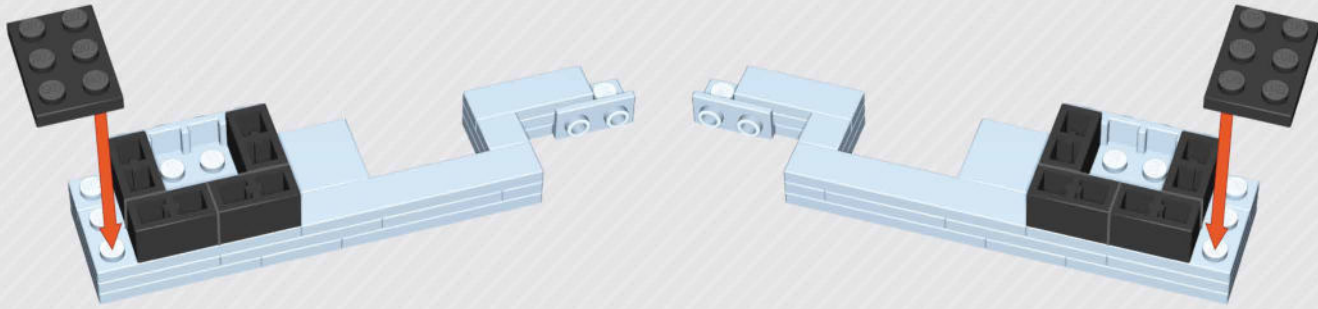

75



76

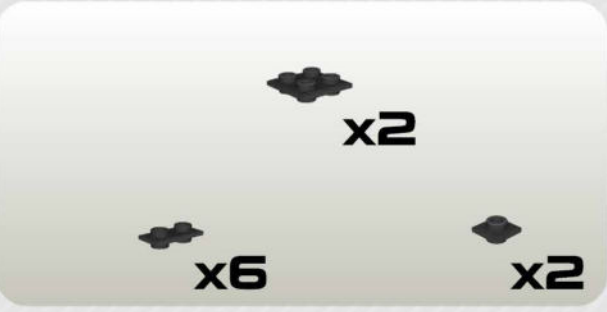

77



78

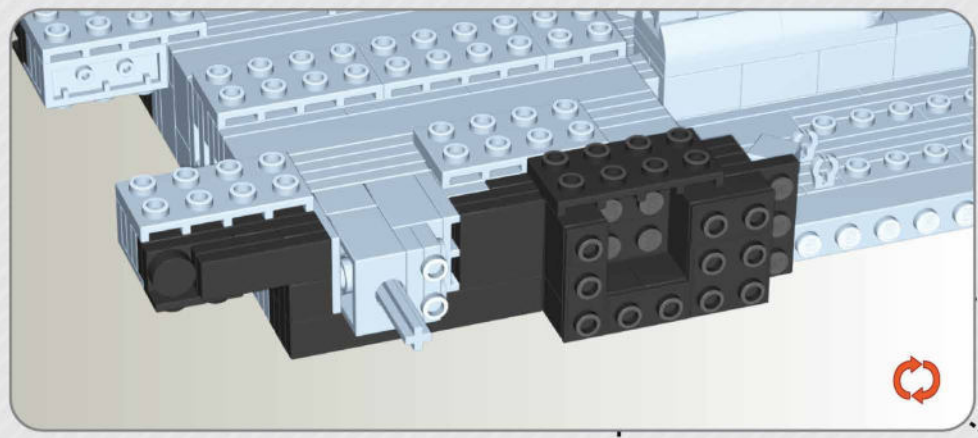

78 □ 146

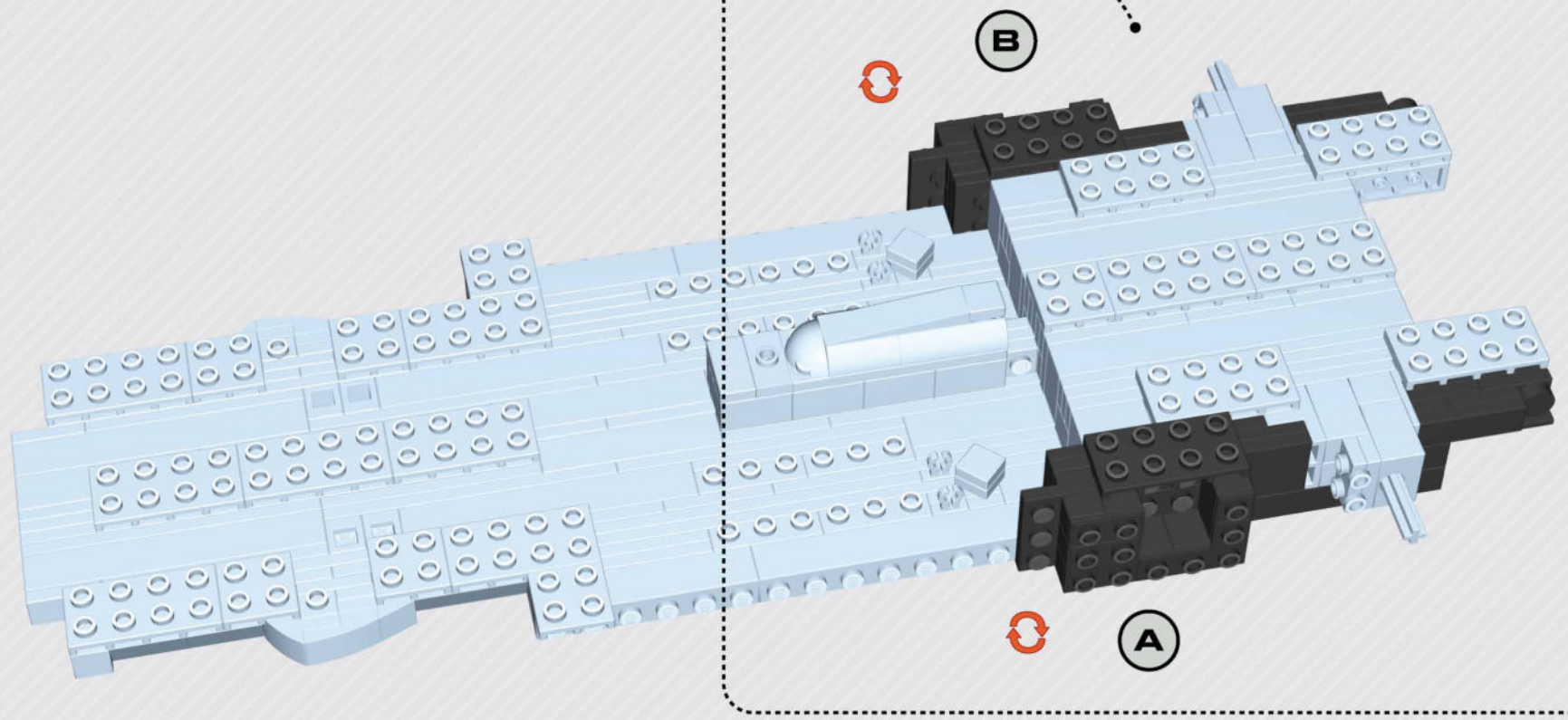

79

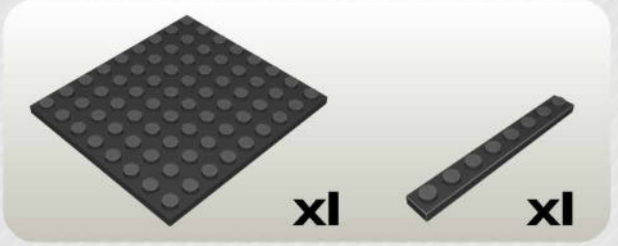
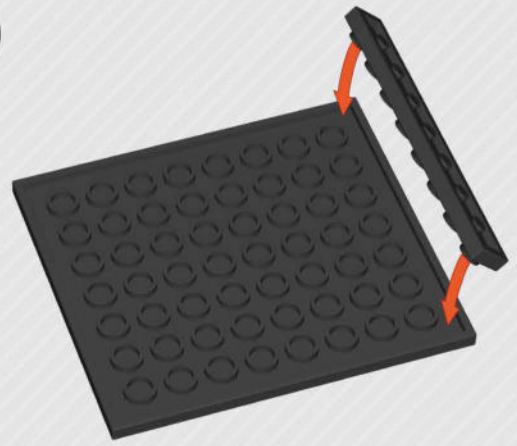

80

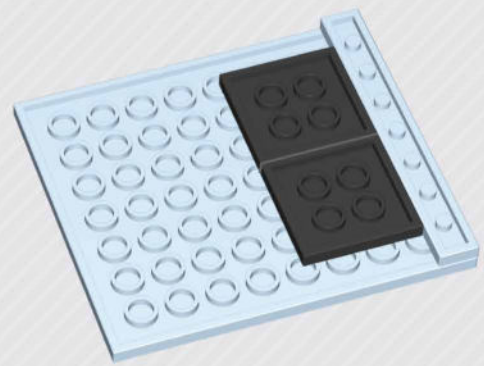

81

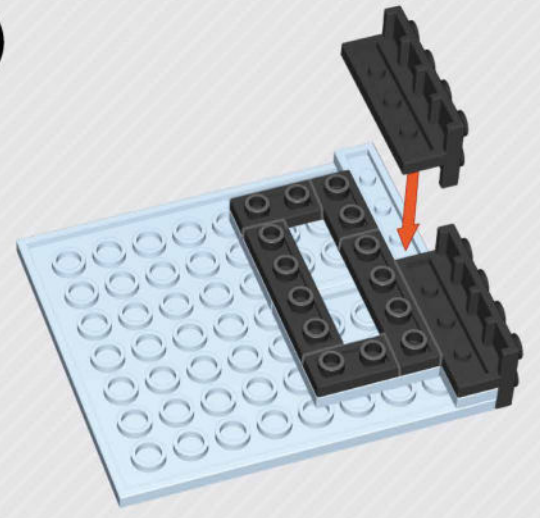

82

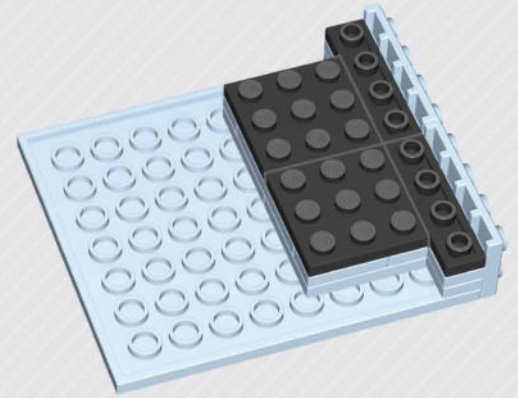

83

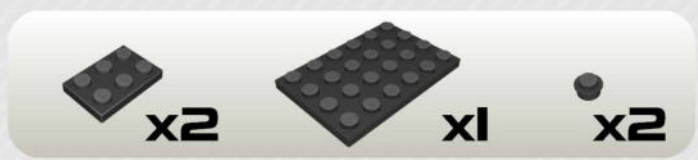
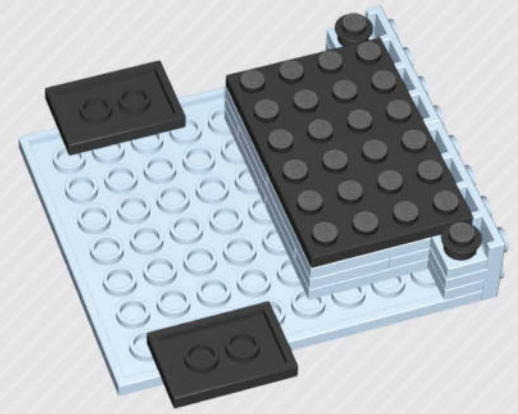

84

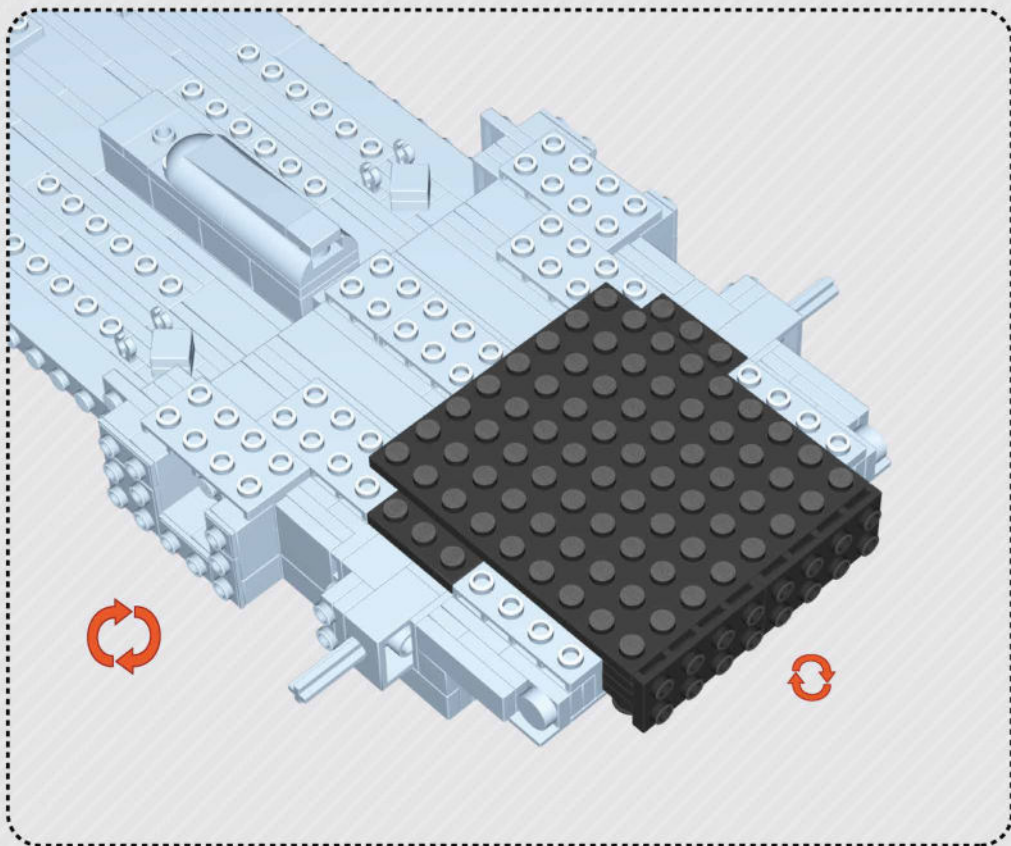

85

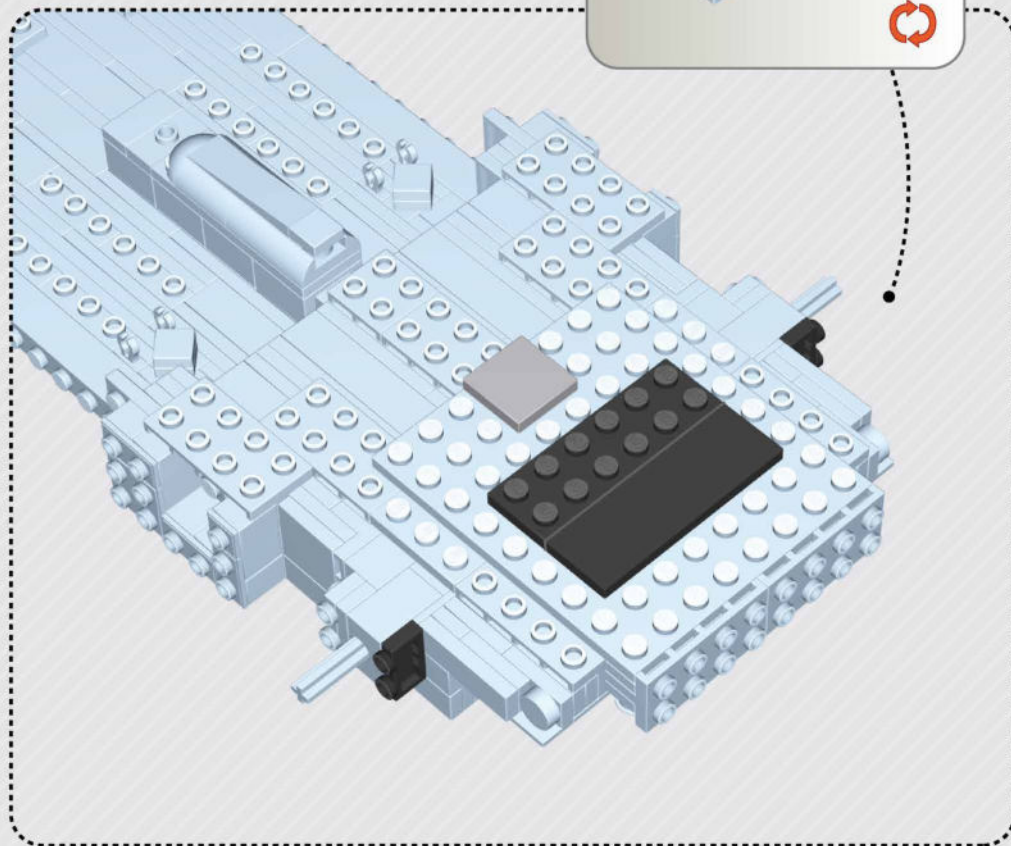

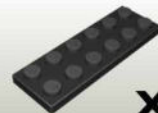

 x2

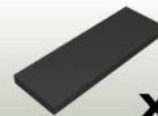
 x1

 x1

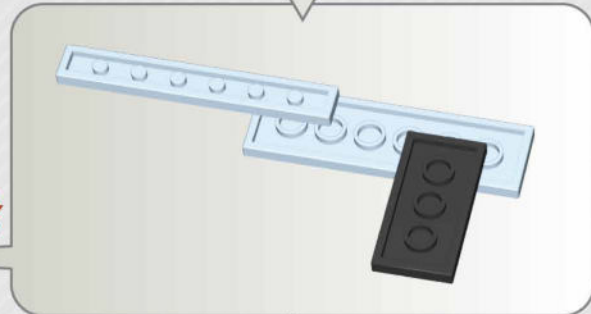
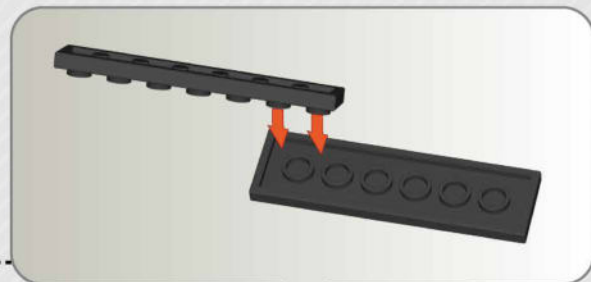
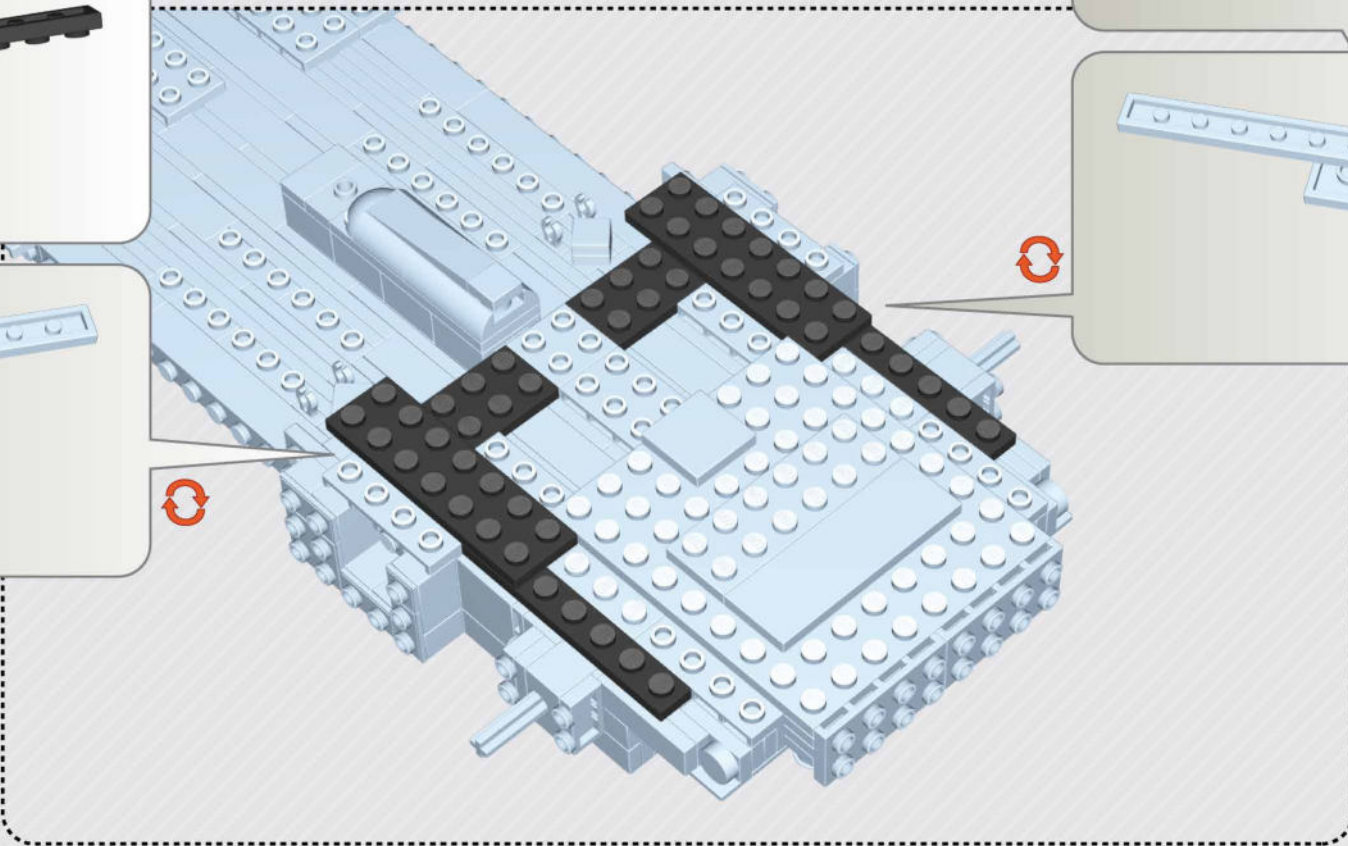
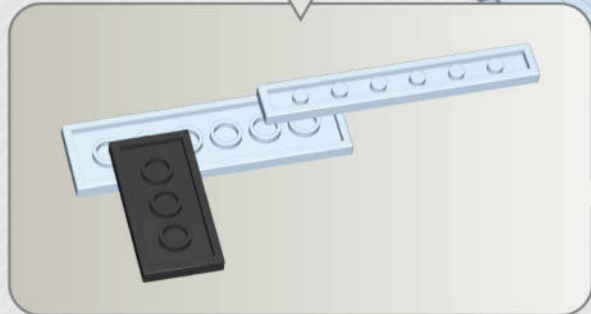
 x1

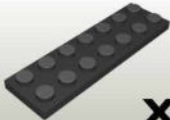

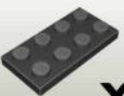
-  x2
-  x2
-  x2

87

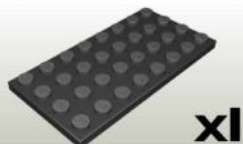
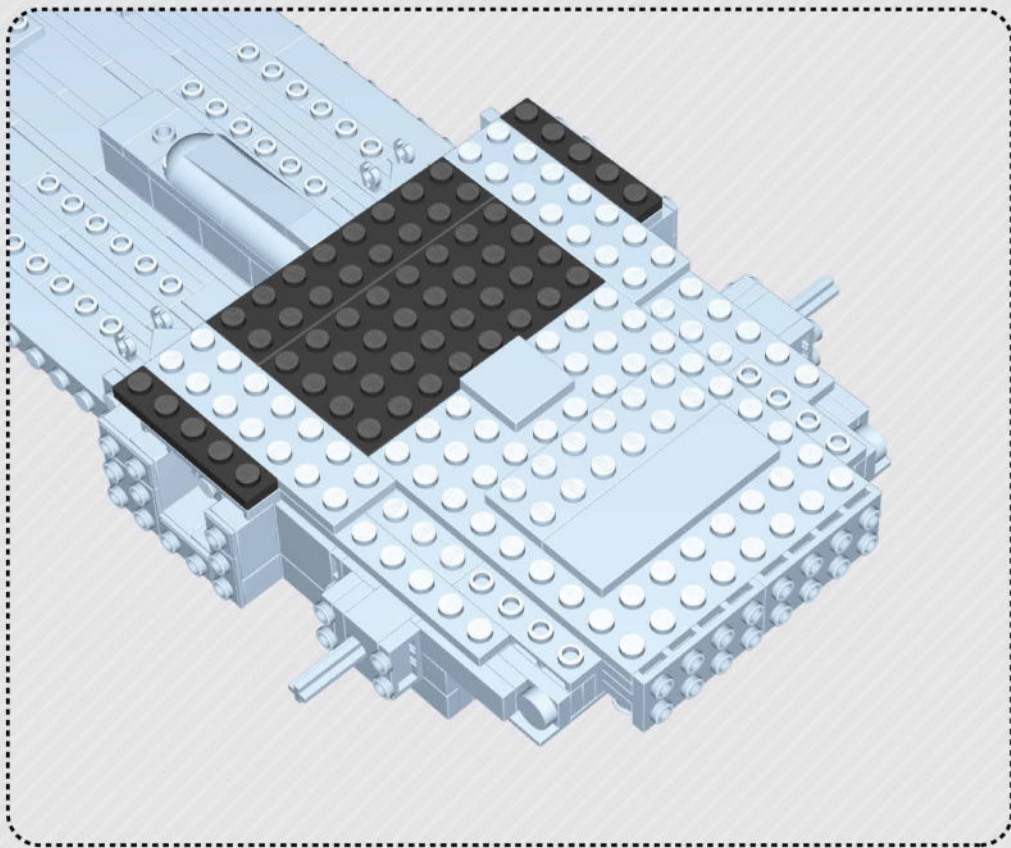

88

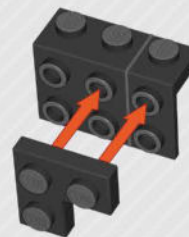

89

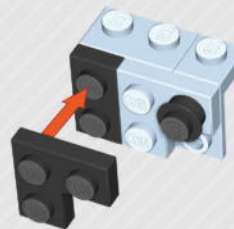
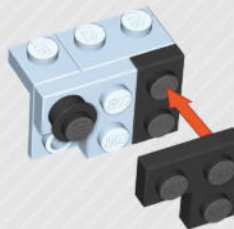

90

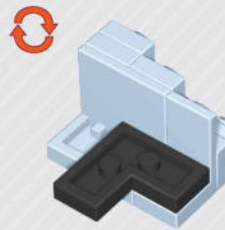
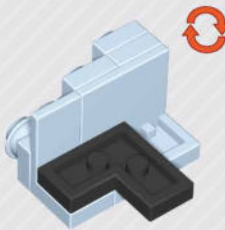

91



 x2  x2

92



 x2  x2

93



 x4  x2

94

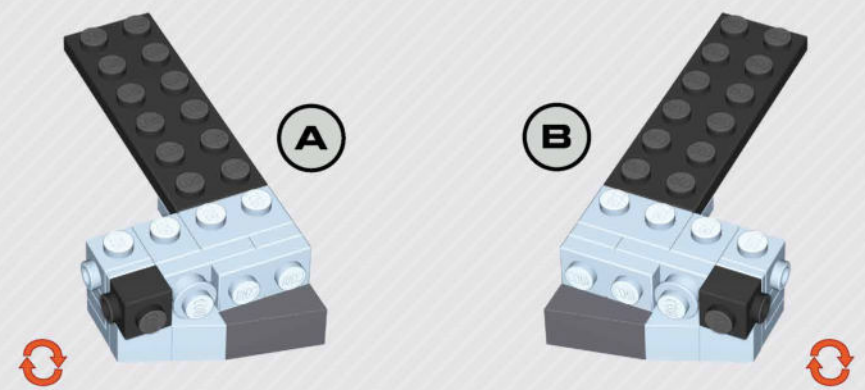

 x2  x2  x2

95

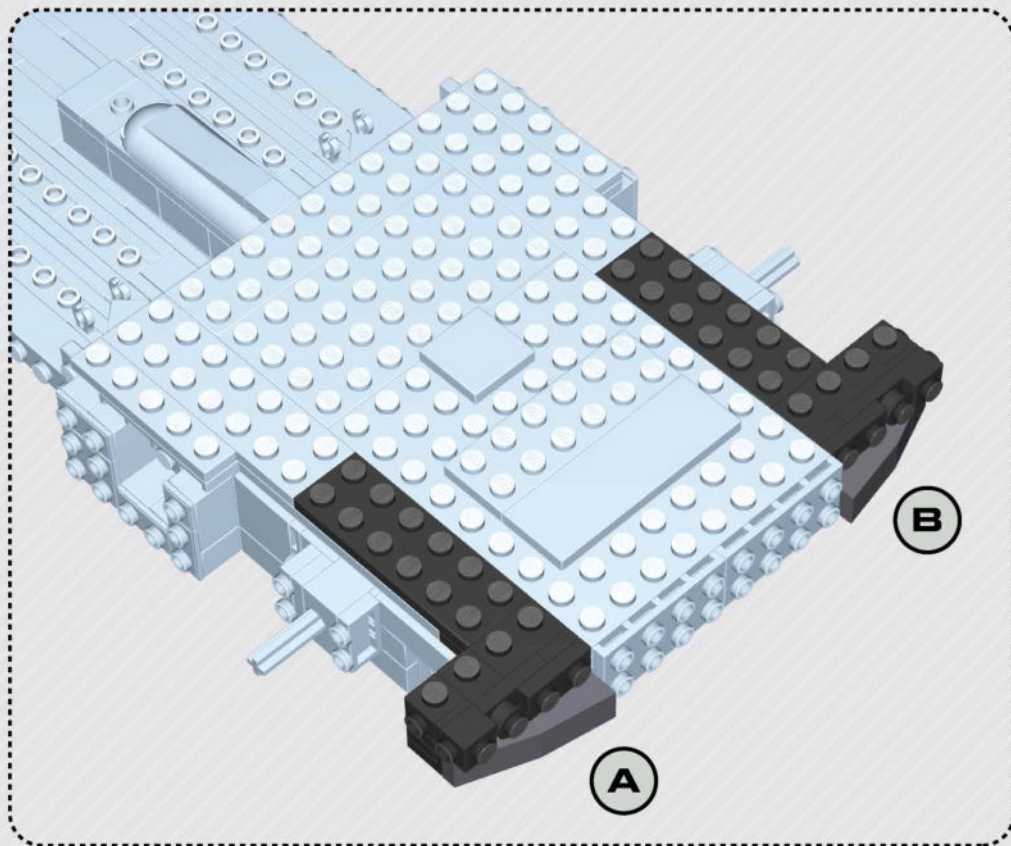

96

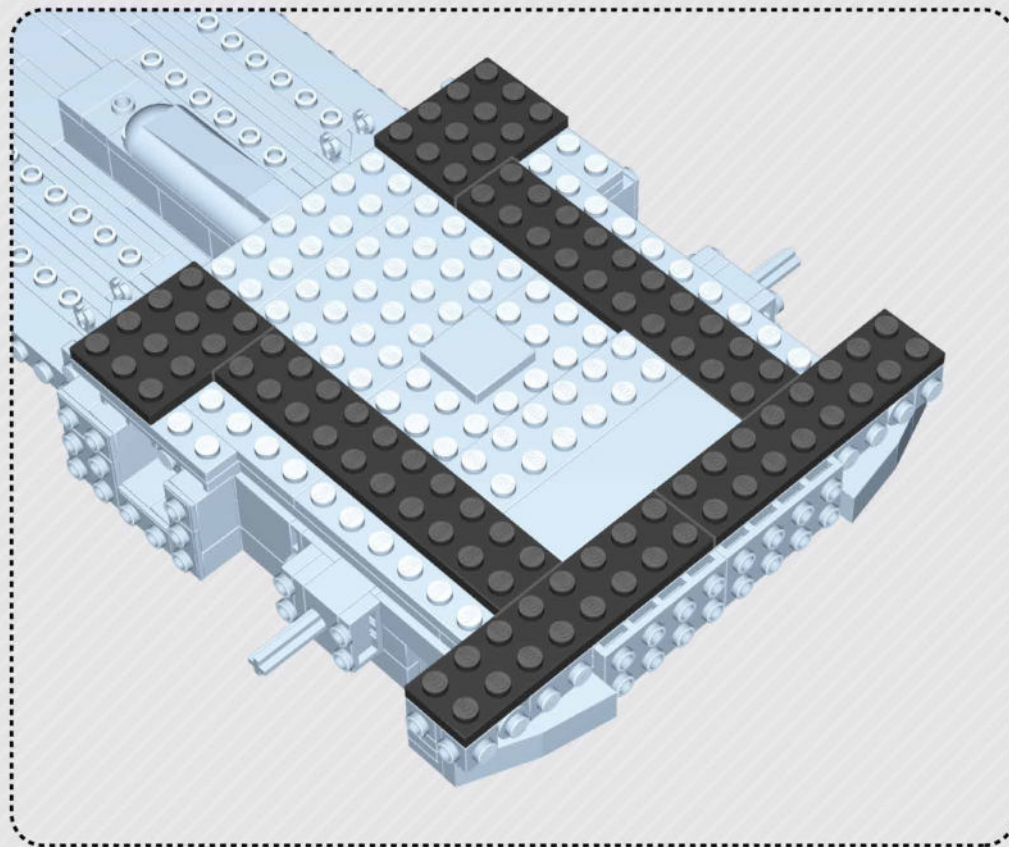

97

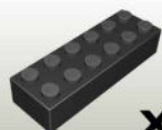
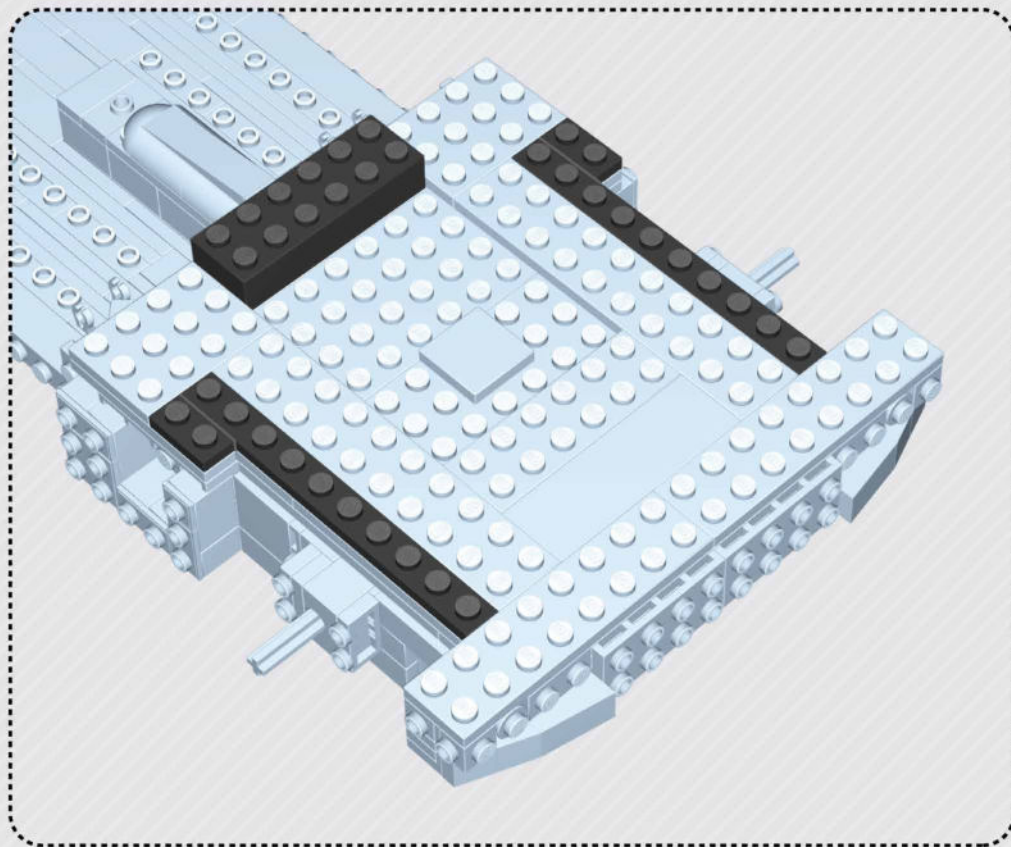

x1



x2

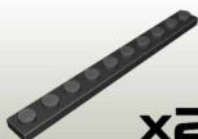

x2

98

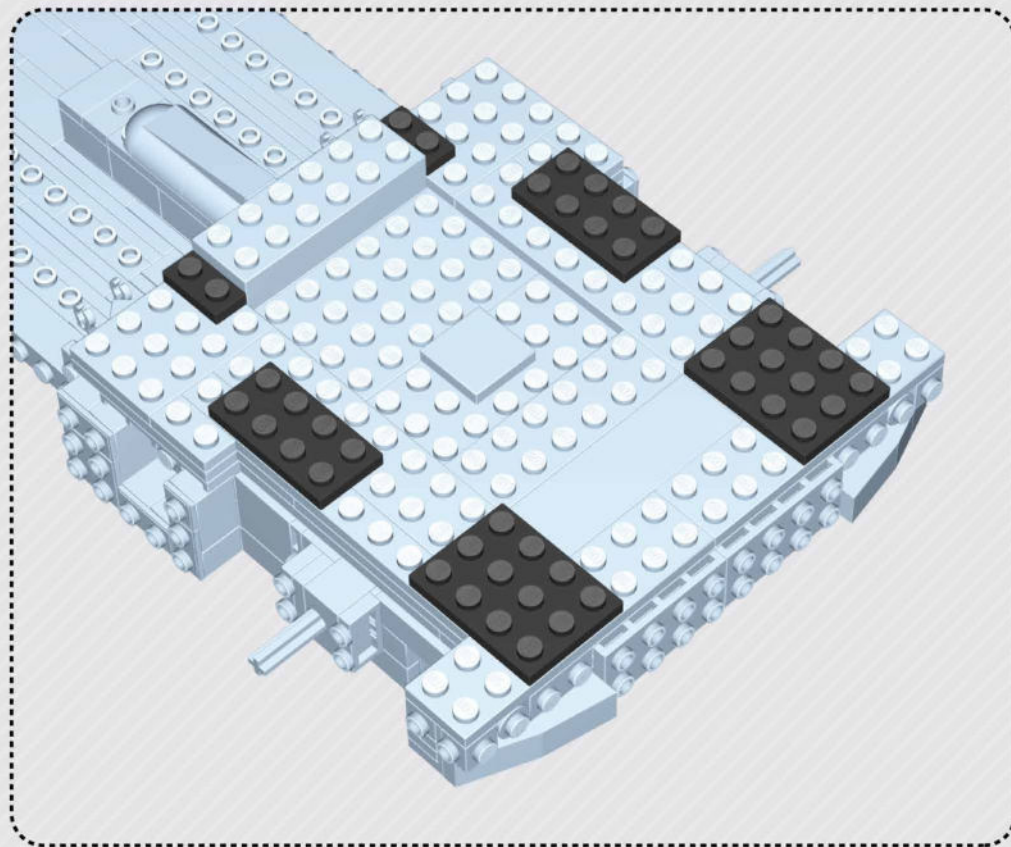

x2

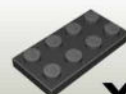

x2

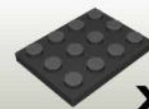

x2

99

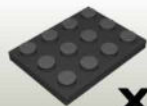
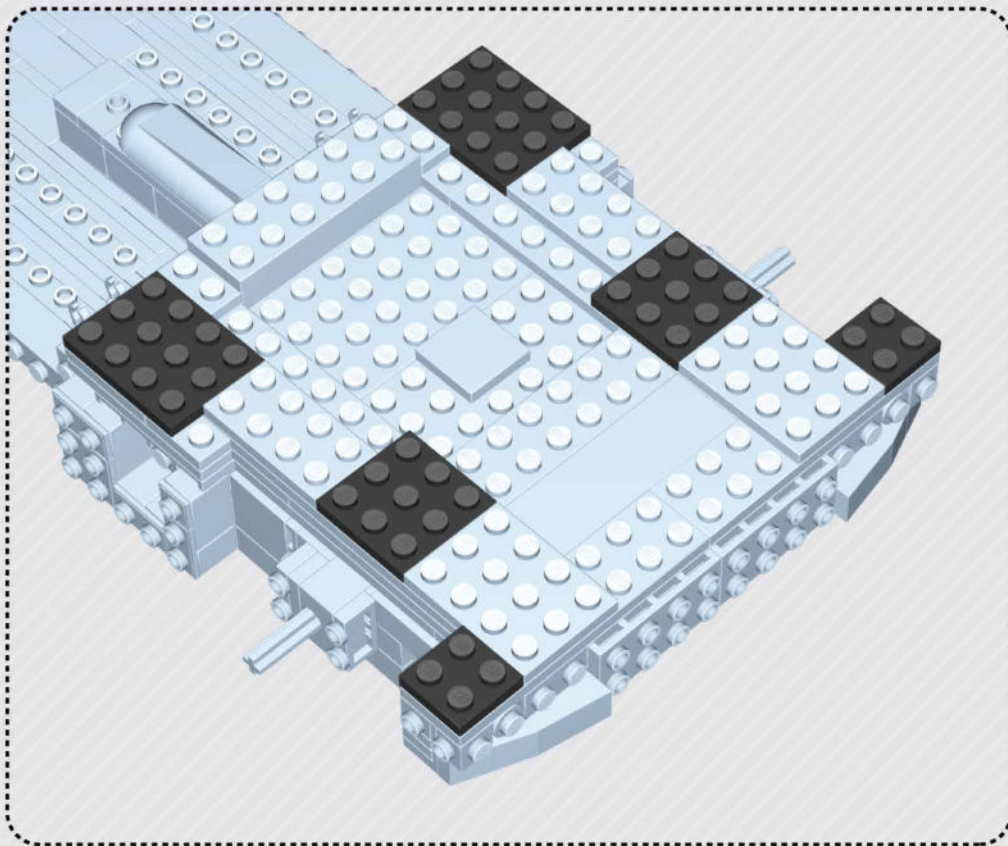

x2

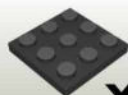

x2



x2

100

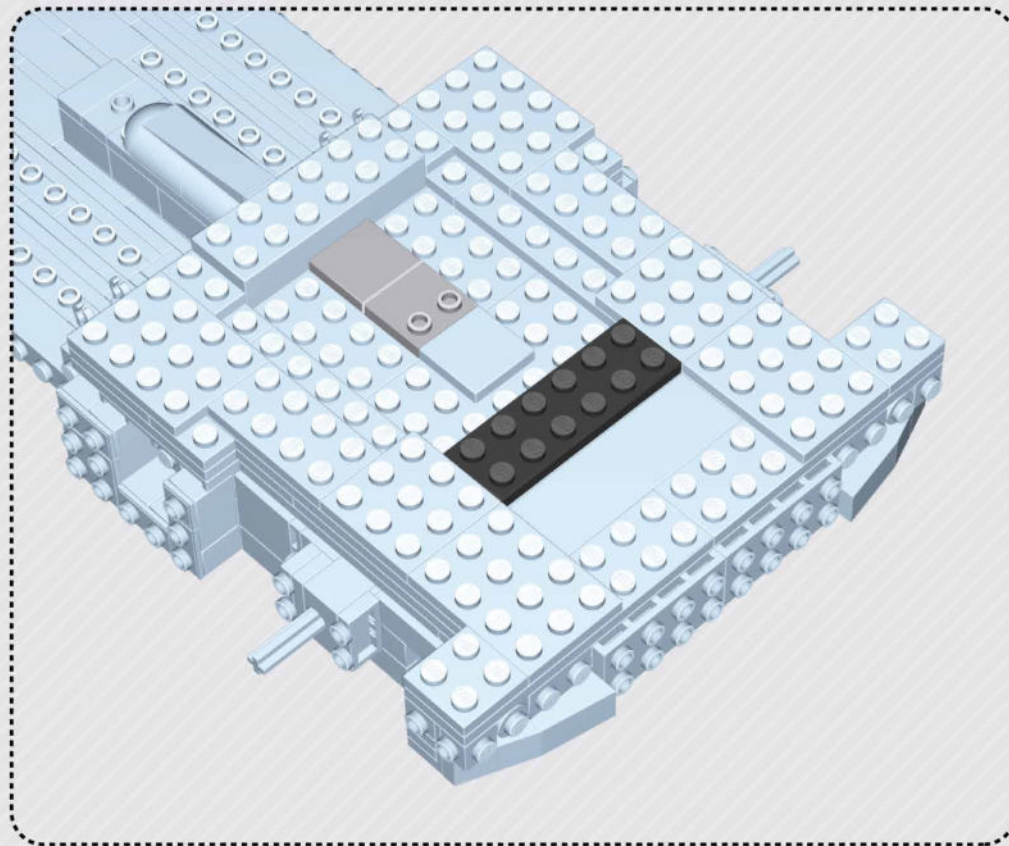

x1



x1

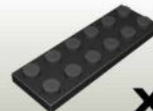

x1

101

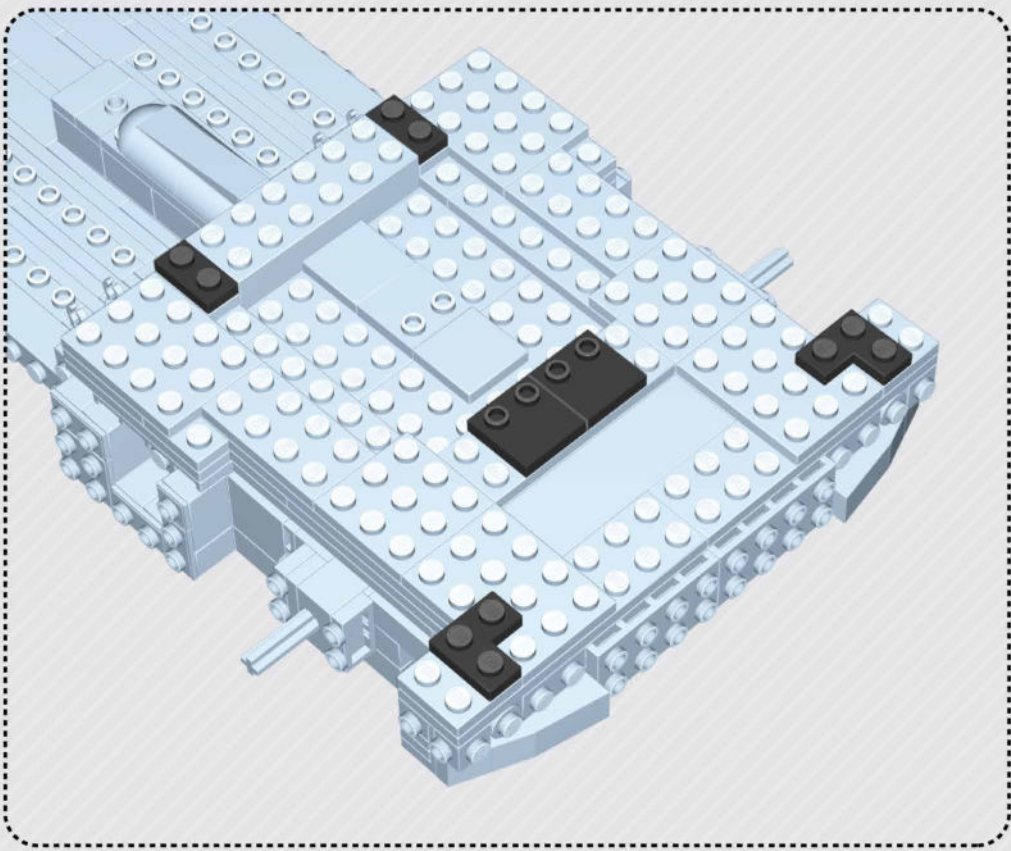

102

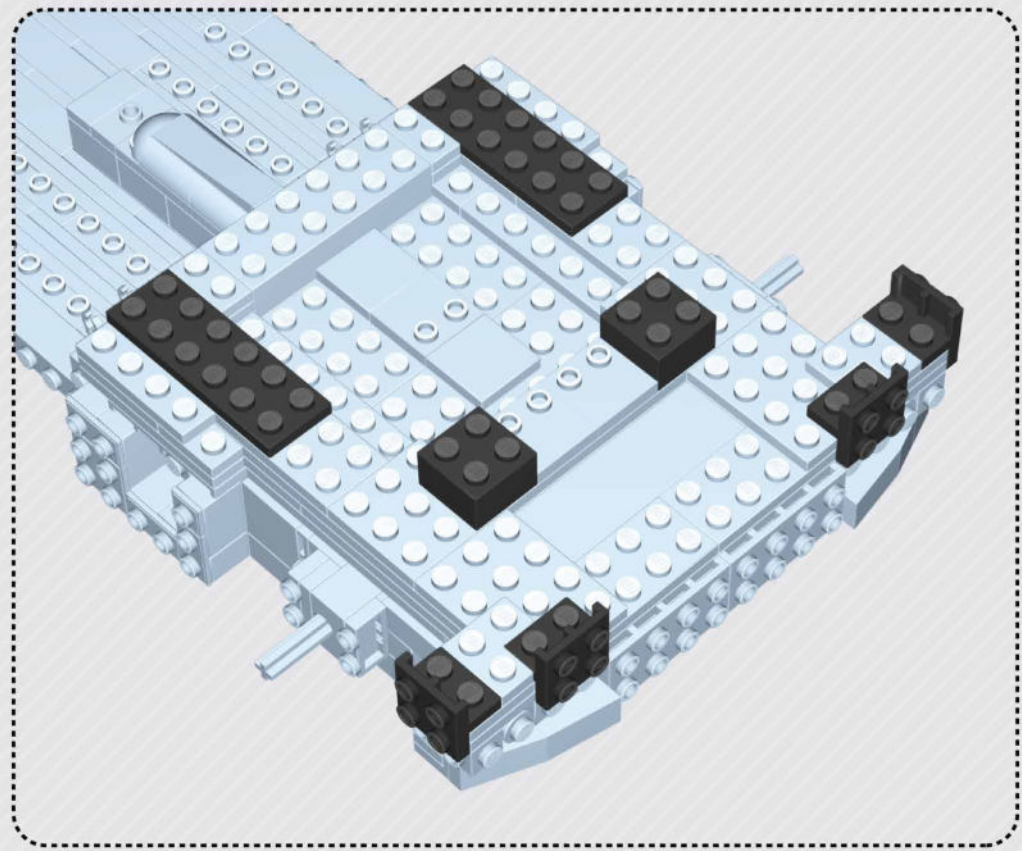

103

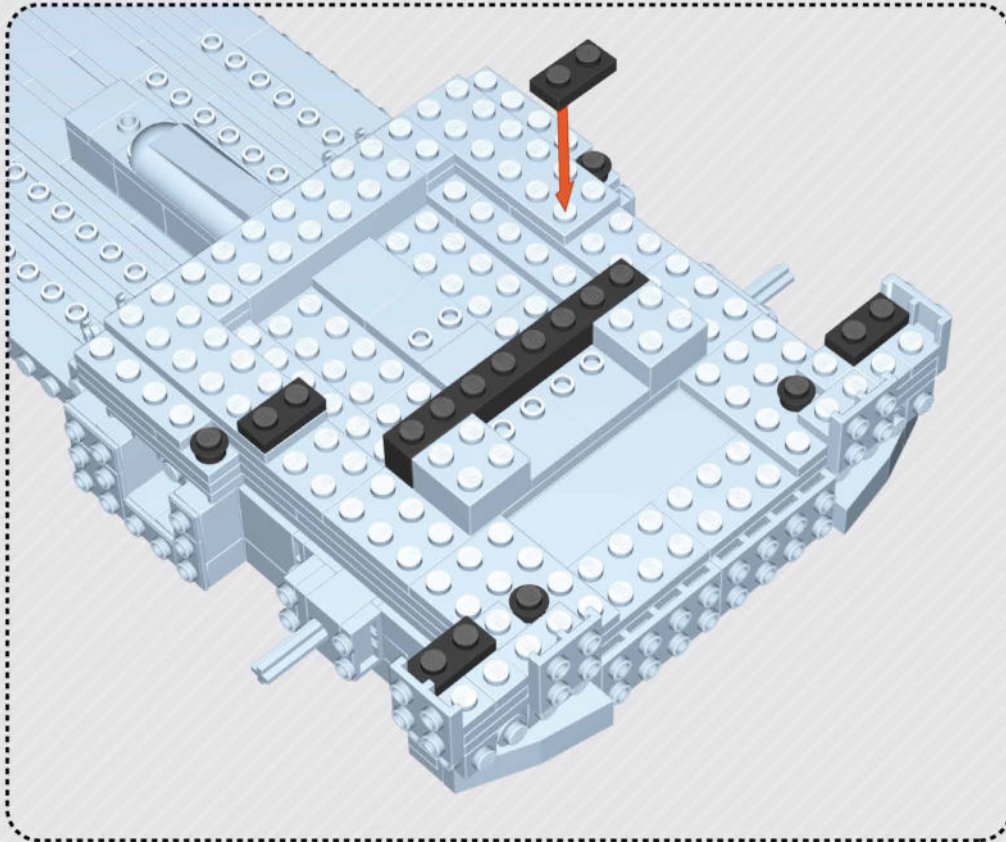

x4

x4

x1

104

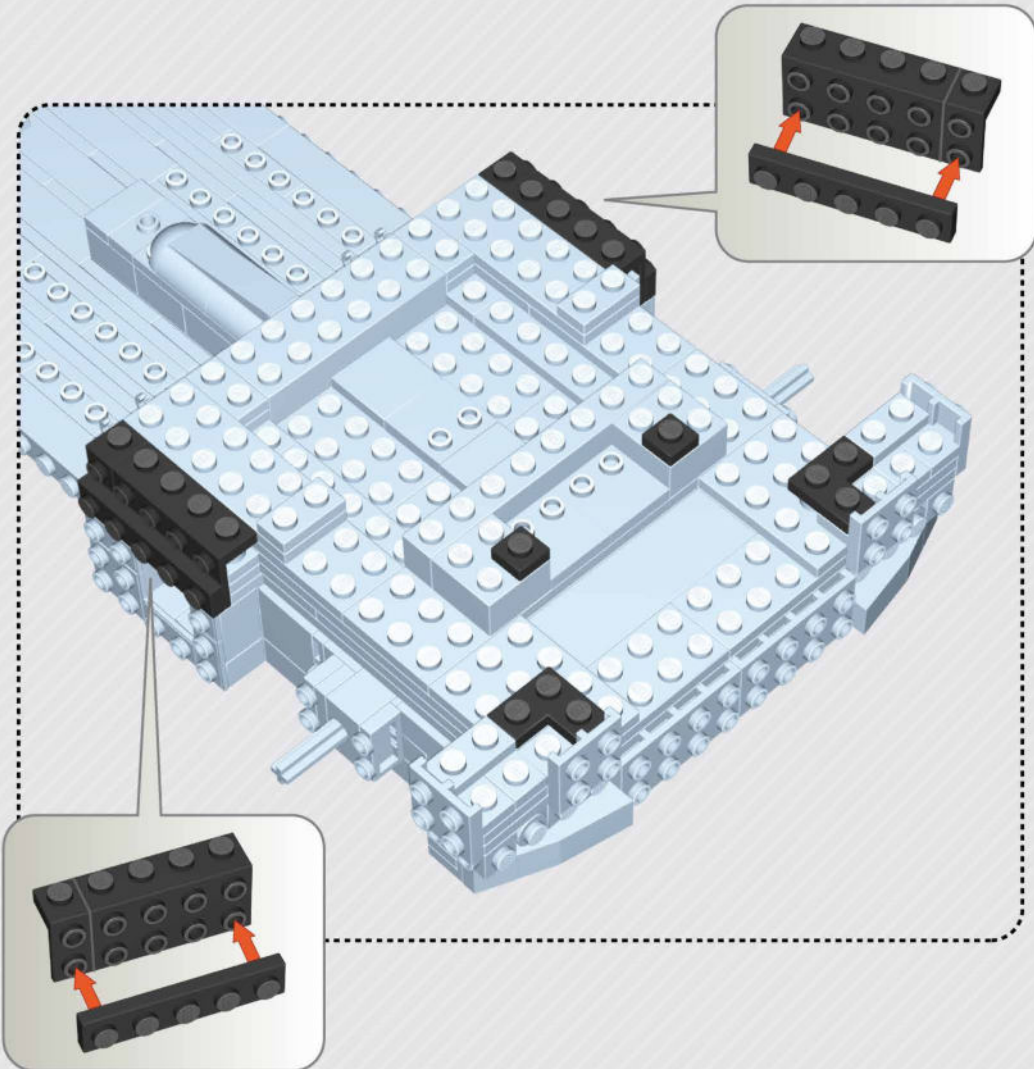

x2

x2

x2

x2

x2

105

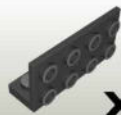
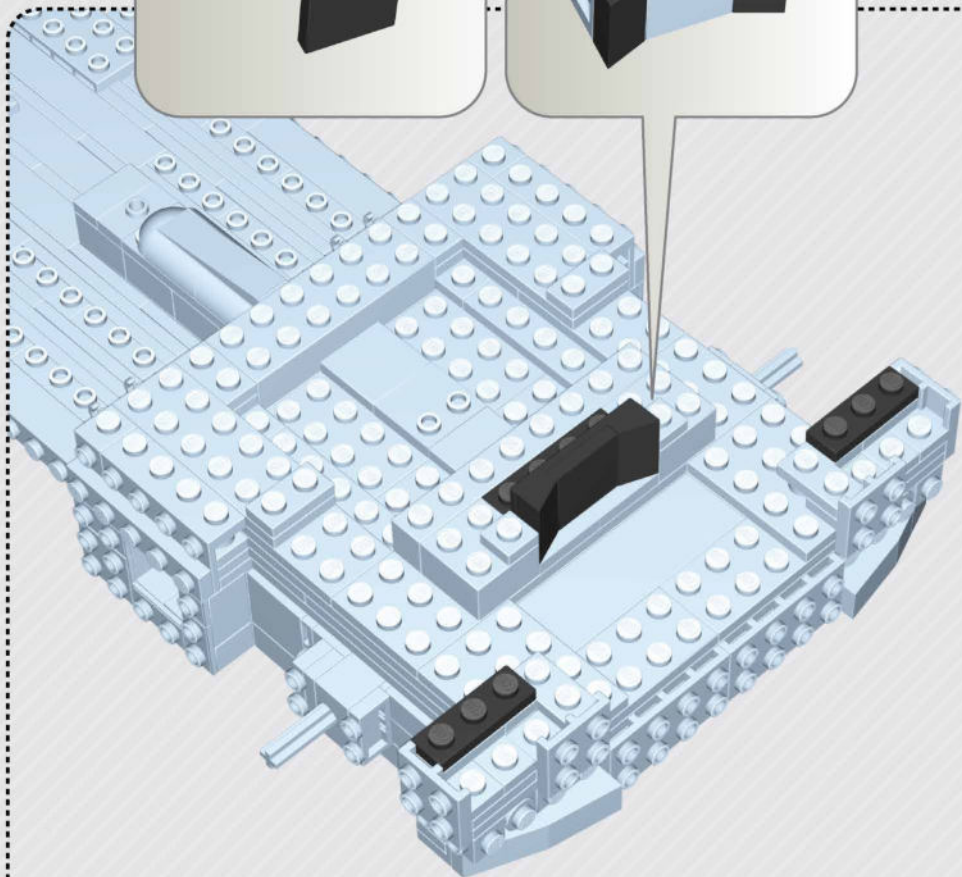
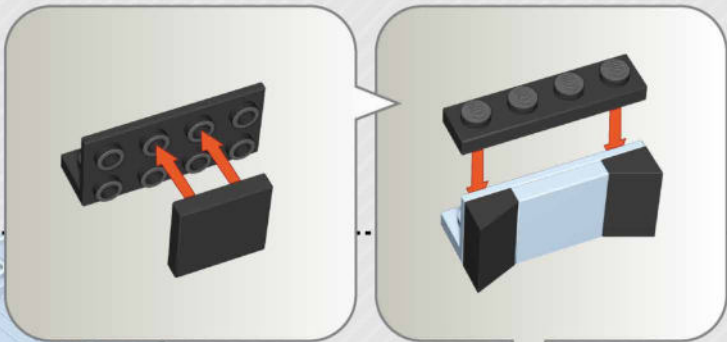

x1



x1

23



x2



x1



x2

106

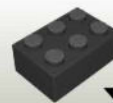
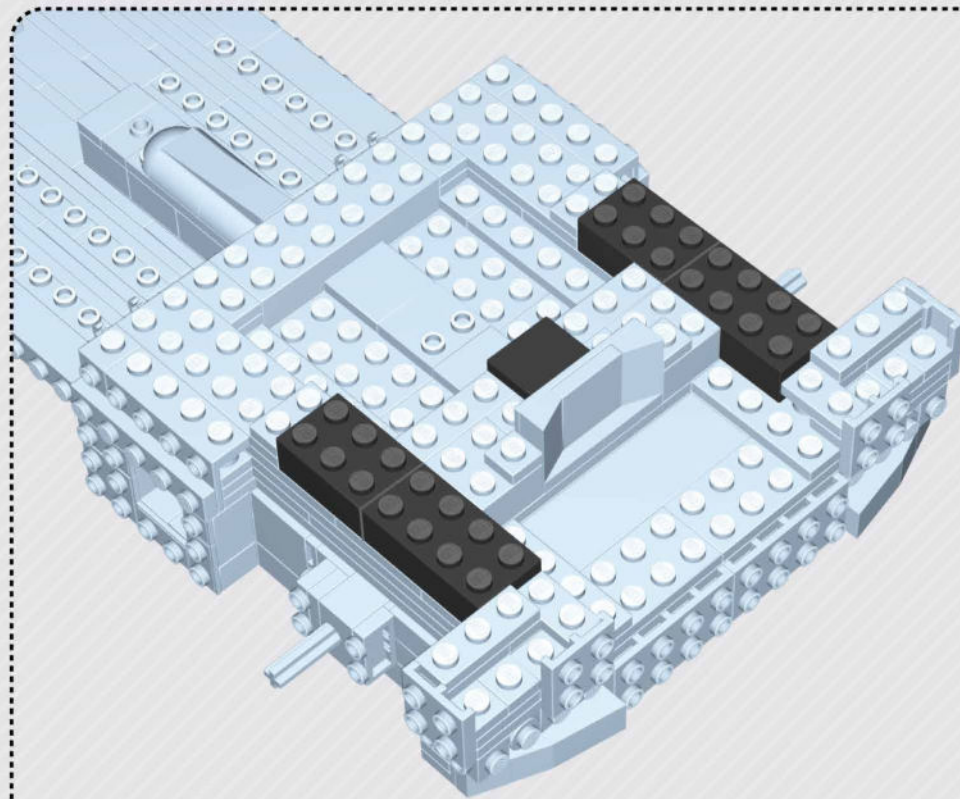

x2

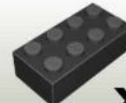

x2



x1

107

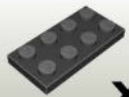

x1



x1

108



x2



x2

109

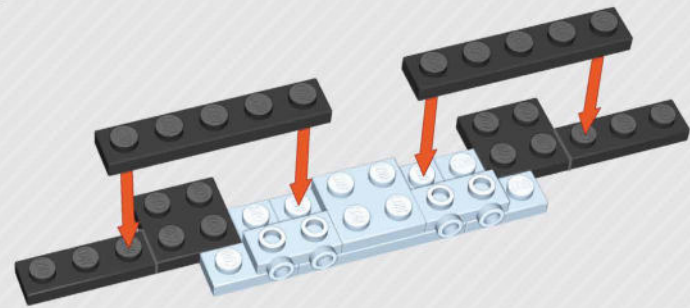

x2



x2

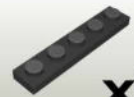

x2

110



x2

1:1



x2

111



x1

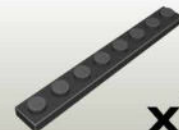

x1

112

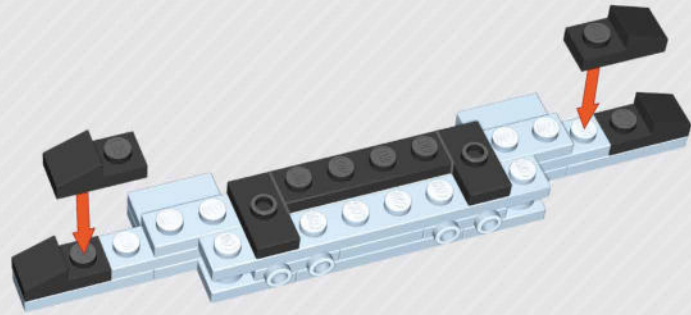

9



x4



x2



x1

113

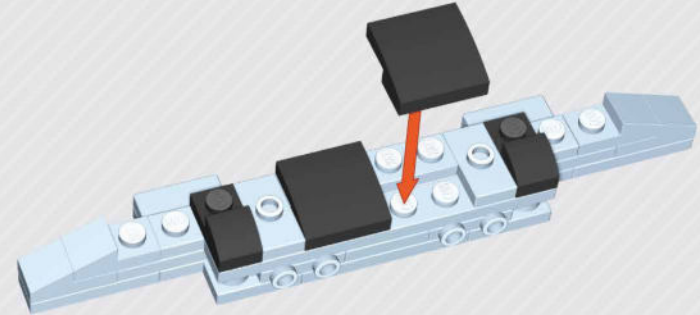

10



x2

21



x2

114

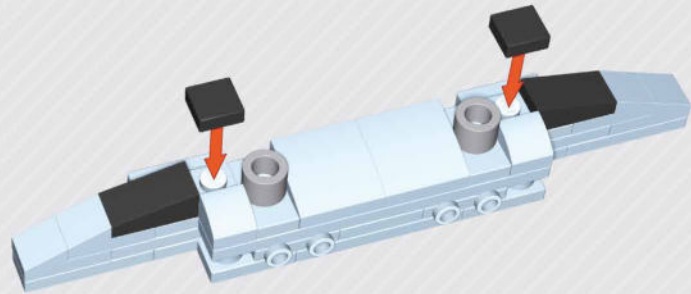

13



x2



x2



x2

115

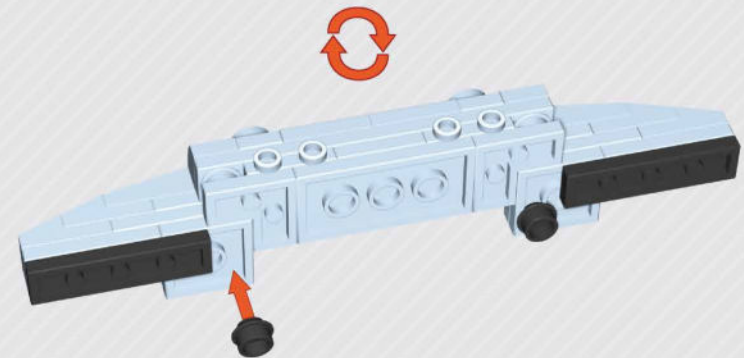

x2



x2