

119

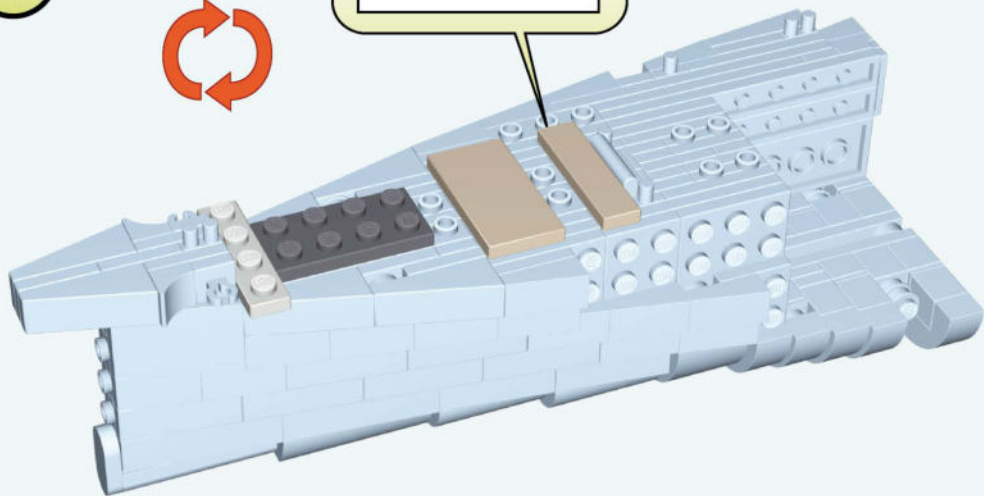

1:1



- x1
- x1
- x1
- x1

120

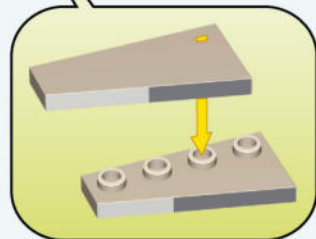
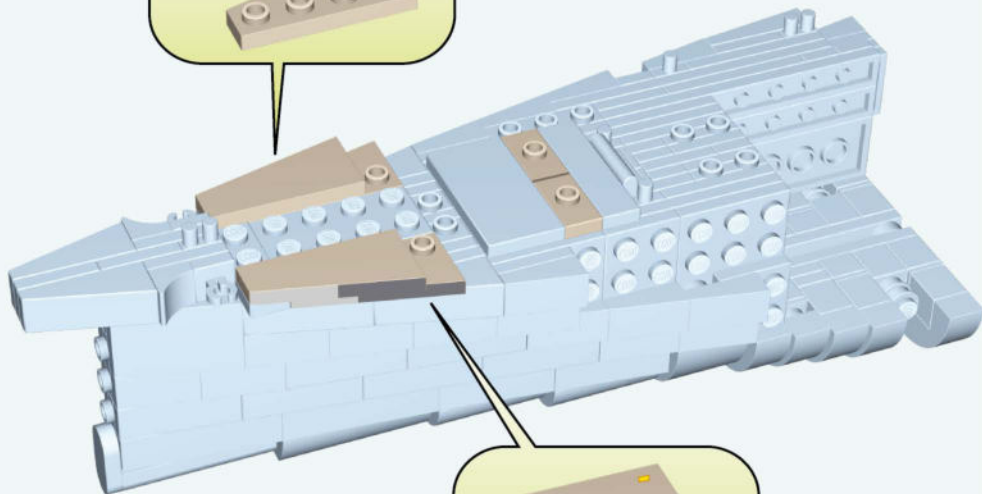
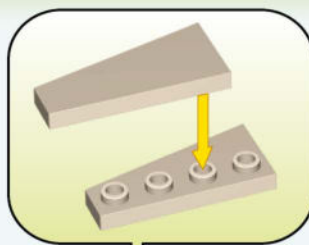

- x1
- x1
- x1
- x1
- x2

121

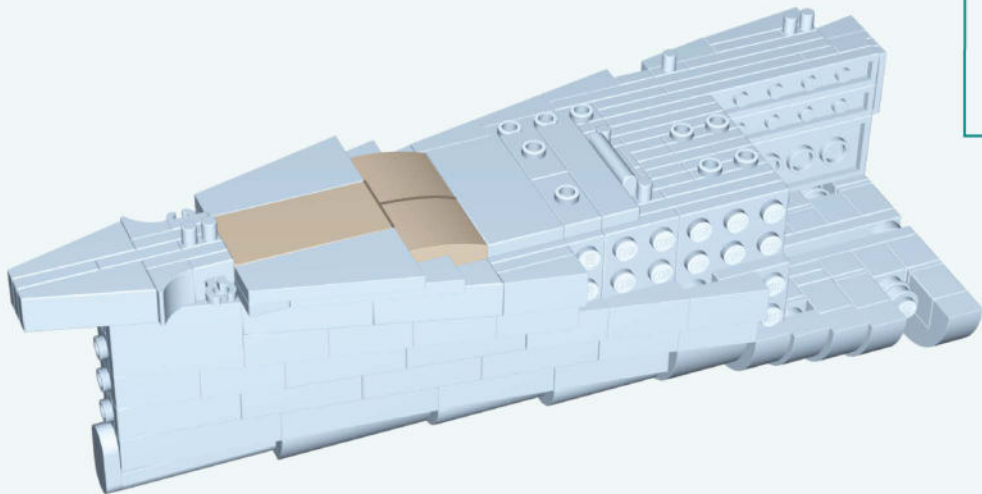

- x1
- x2

122

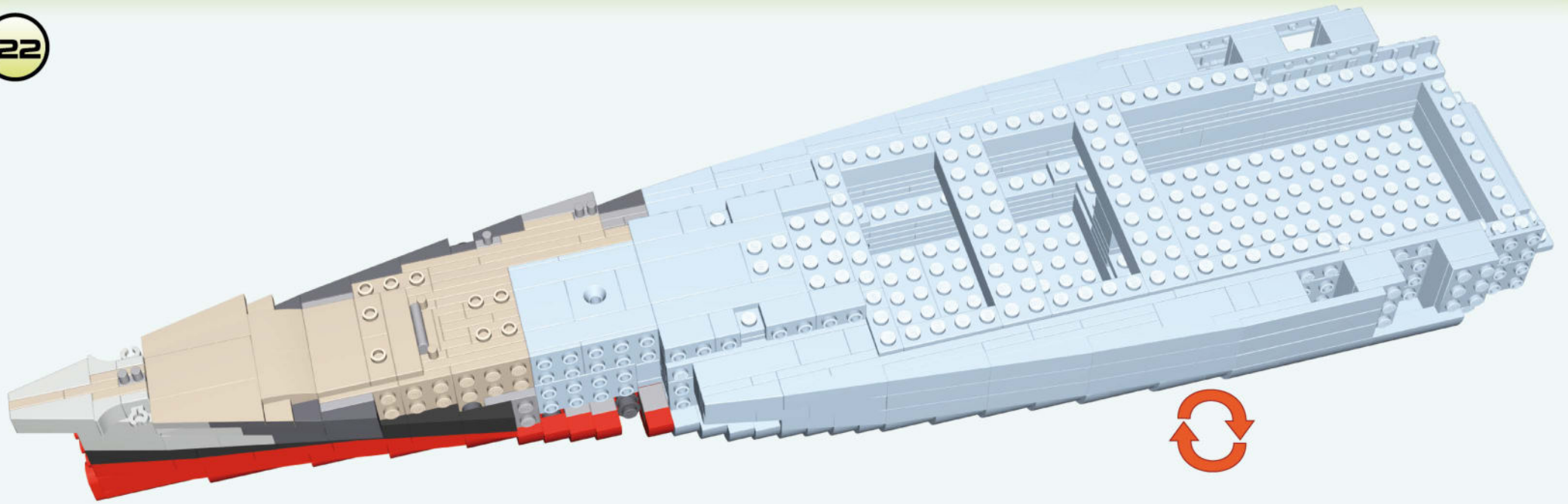

123

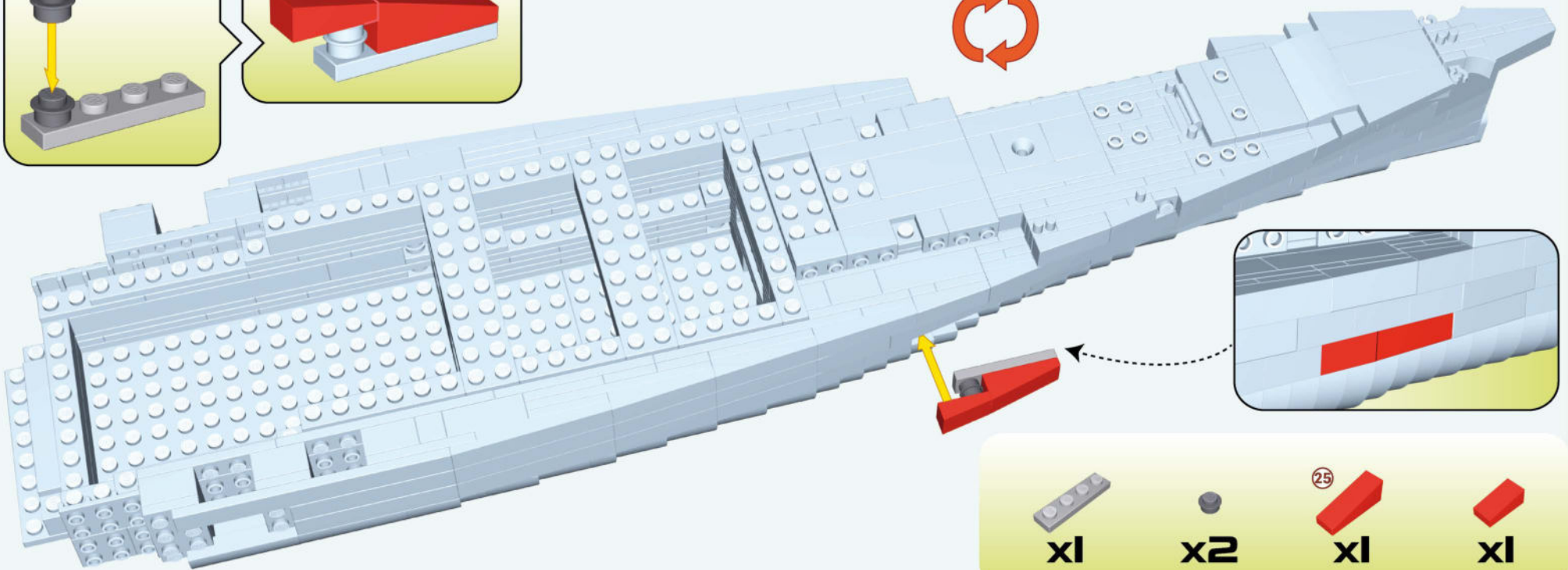
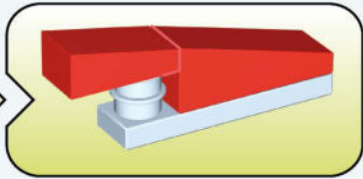
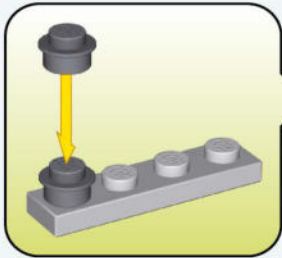

-  x1
-  x2
-  x1
-  x1

124

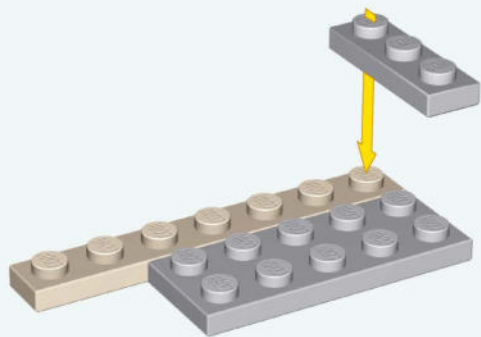

x1



x1



x1

125

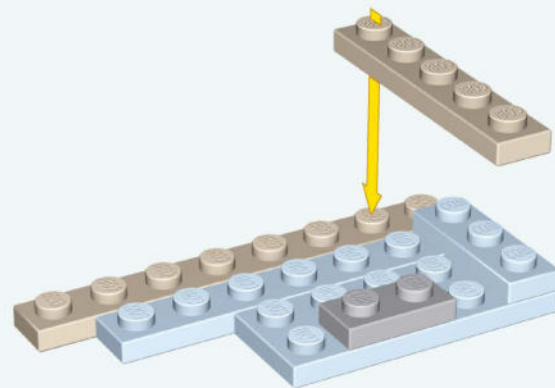

x1



x1



x1

126

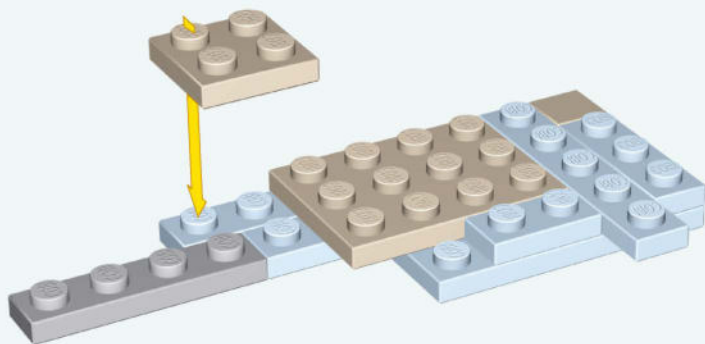

x1



x1



x1



x1

127

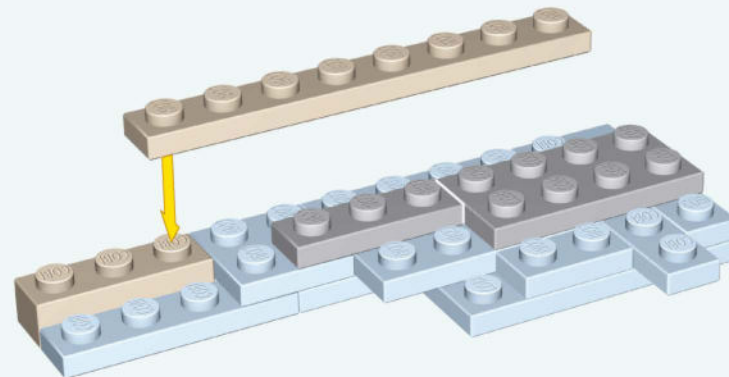

x1



x1



x1



x1



128

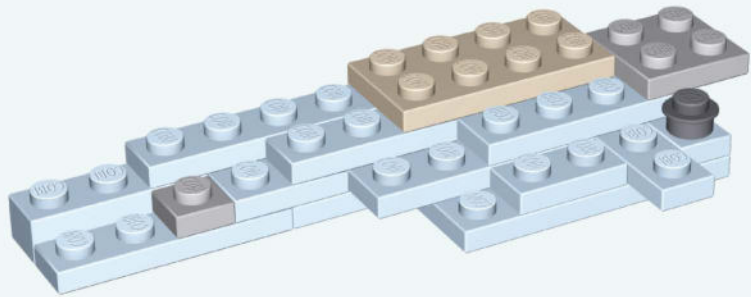

x1



x1



x1



x1

130

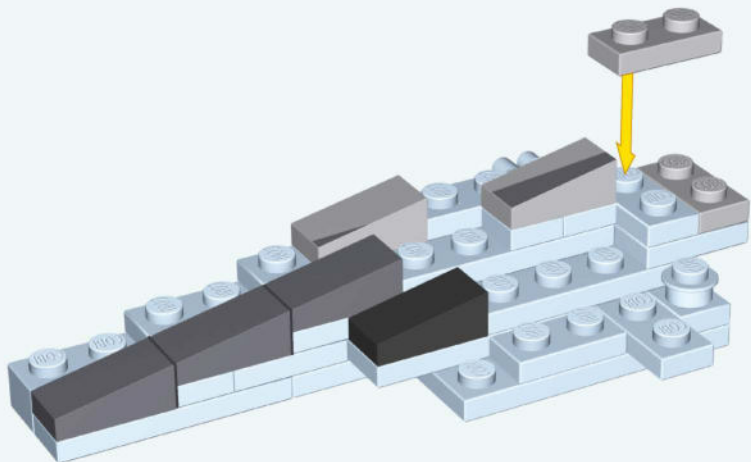

x3



x1



x1



x1



x2

129

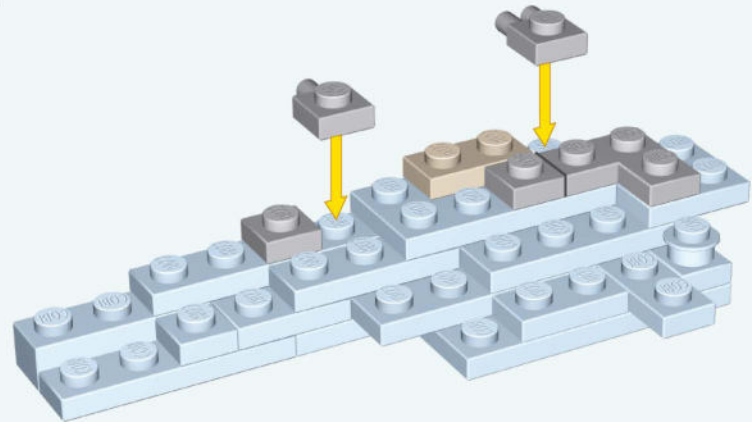

x2



x1



x1



x1



x1

131

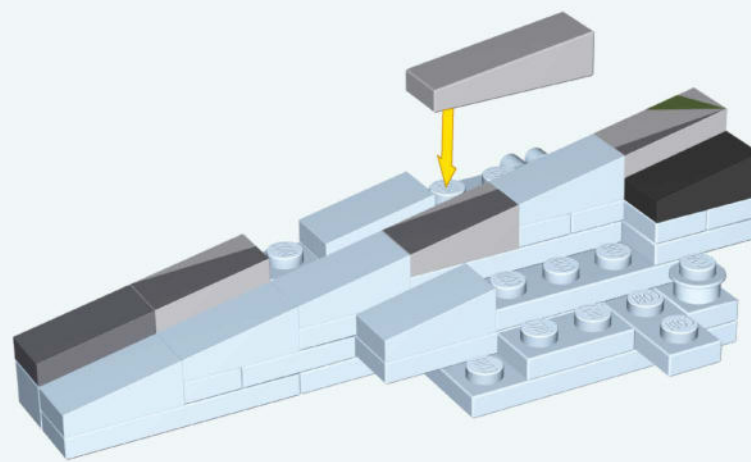

x1



x1



x1



x1



x1



x1



132

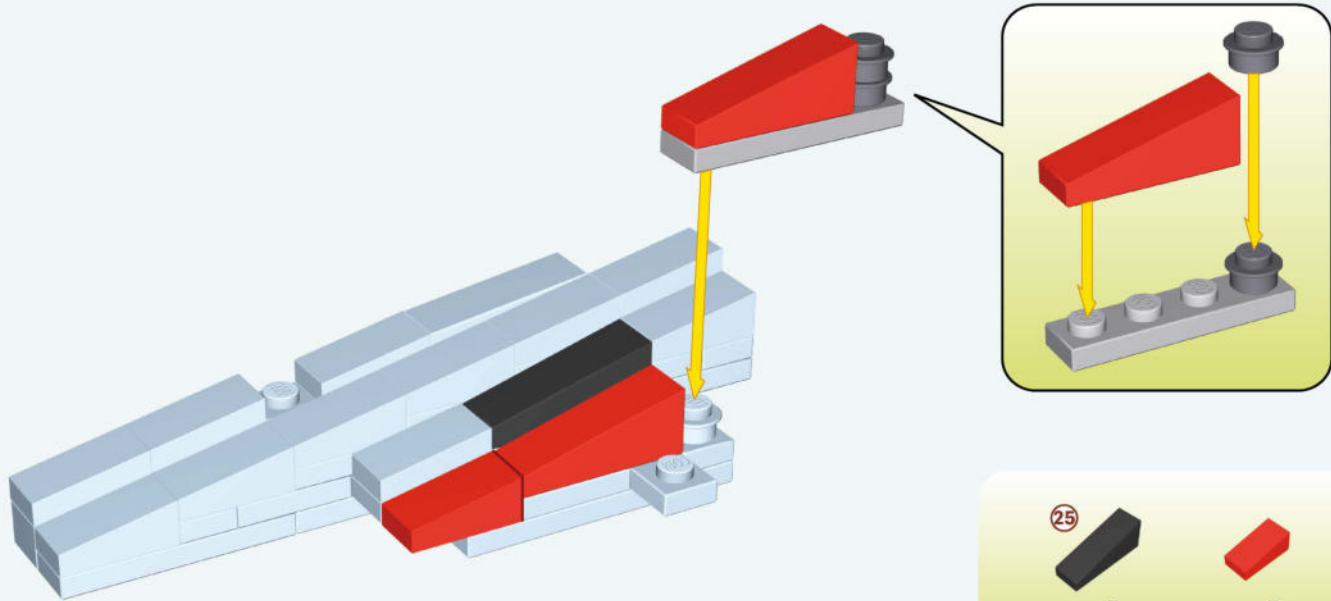

-  **x1**
-  **x1**
-  **x2**
-  **x1**
-  **x2**

133

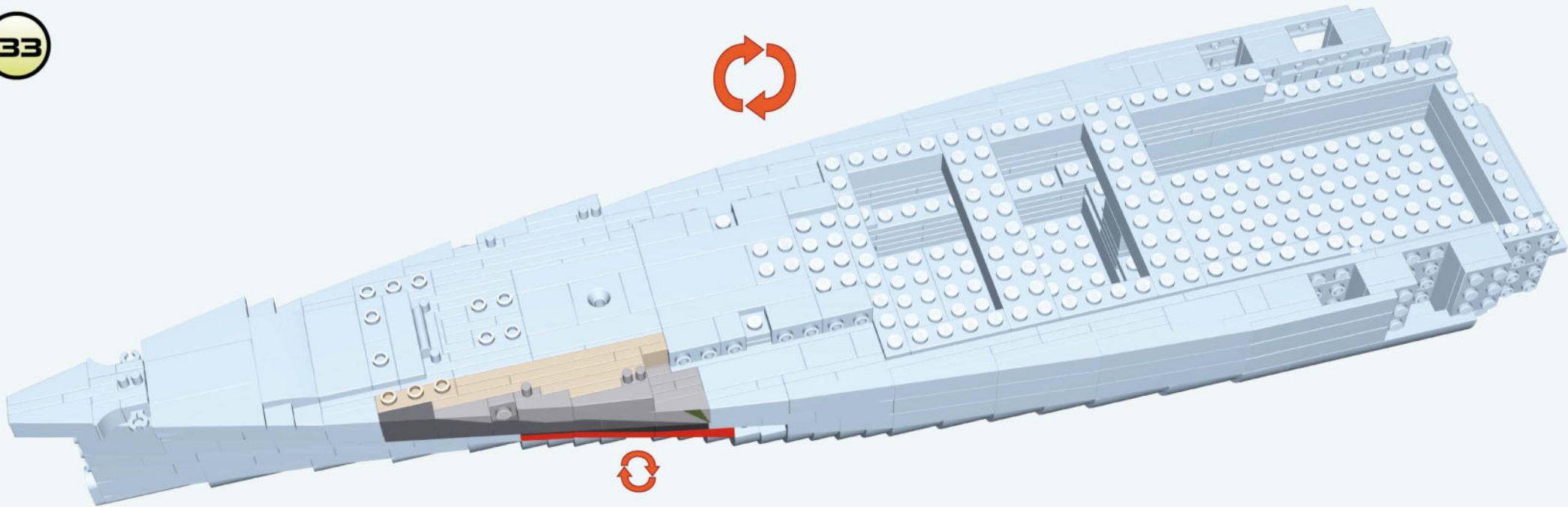

134

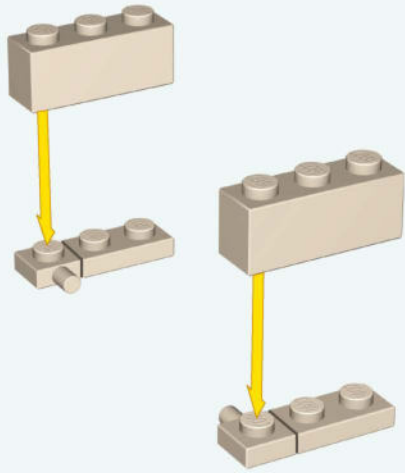

x2



x2



x2

136

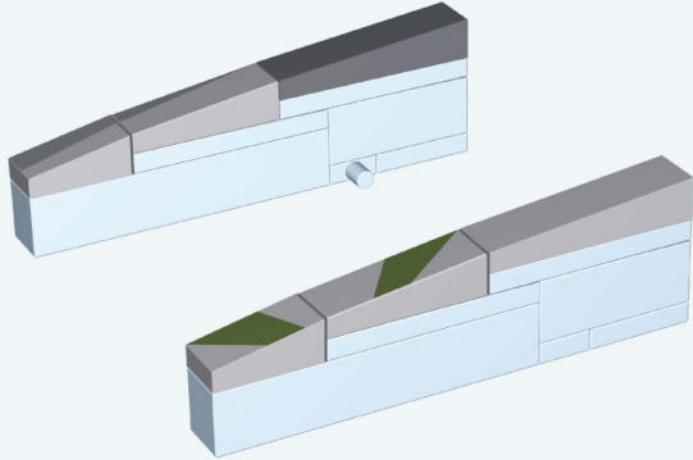

x1



x1



x1



x1



x1



x1

135

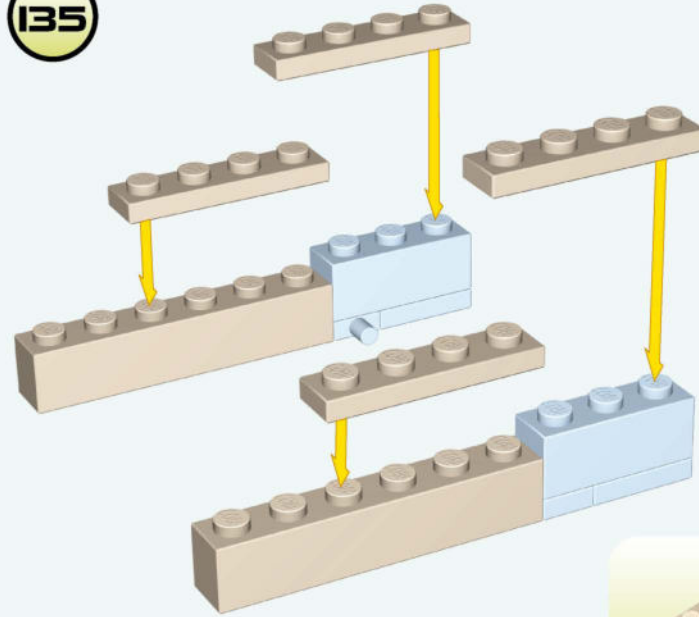

x2



x4

137

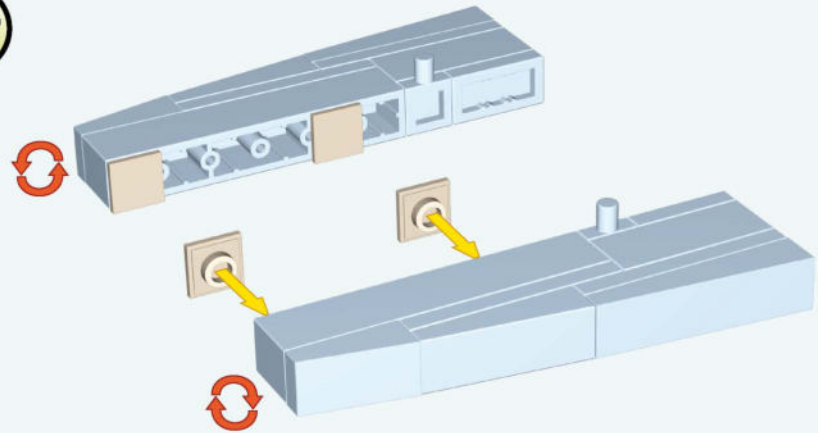

x4

138



x1



x1



x1



x1

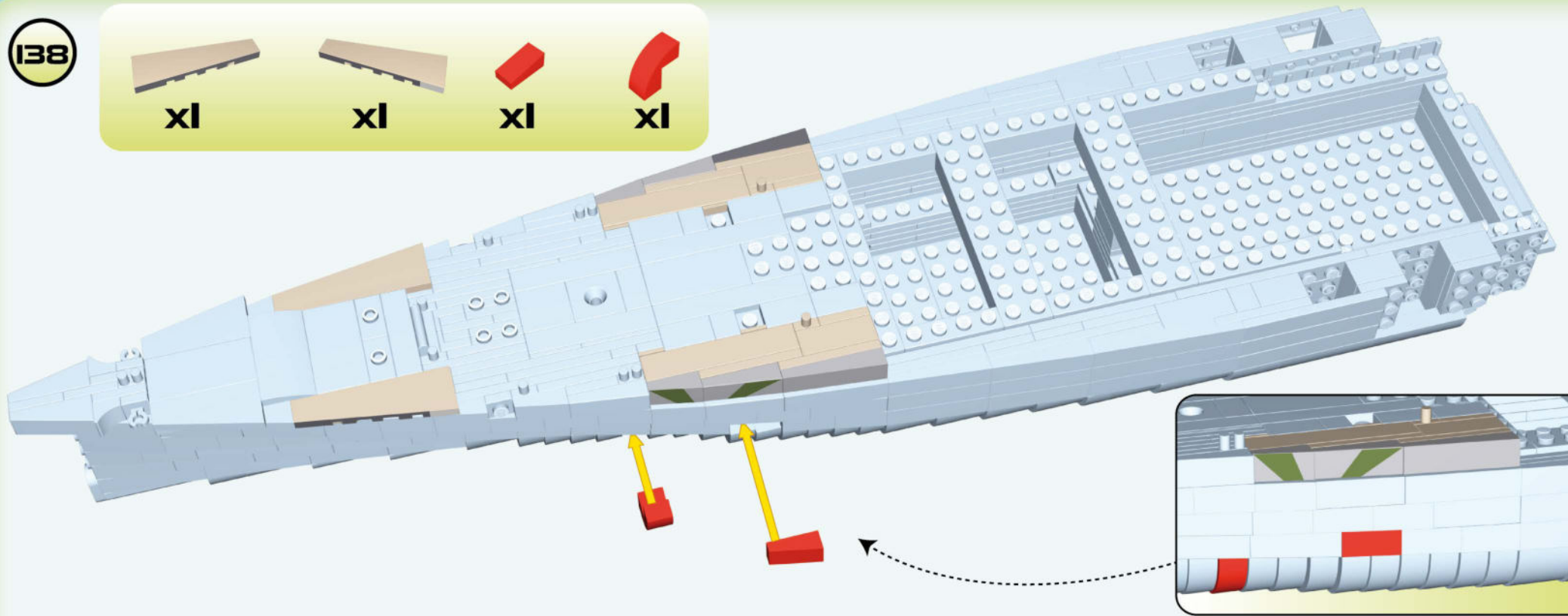

139

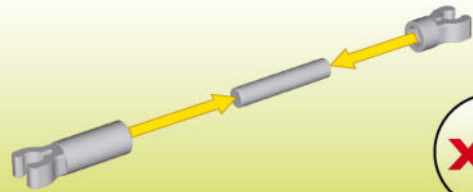

x2

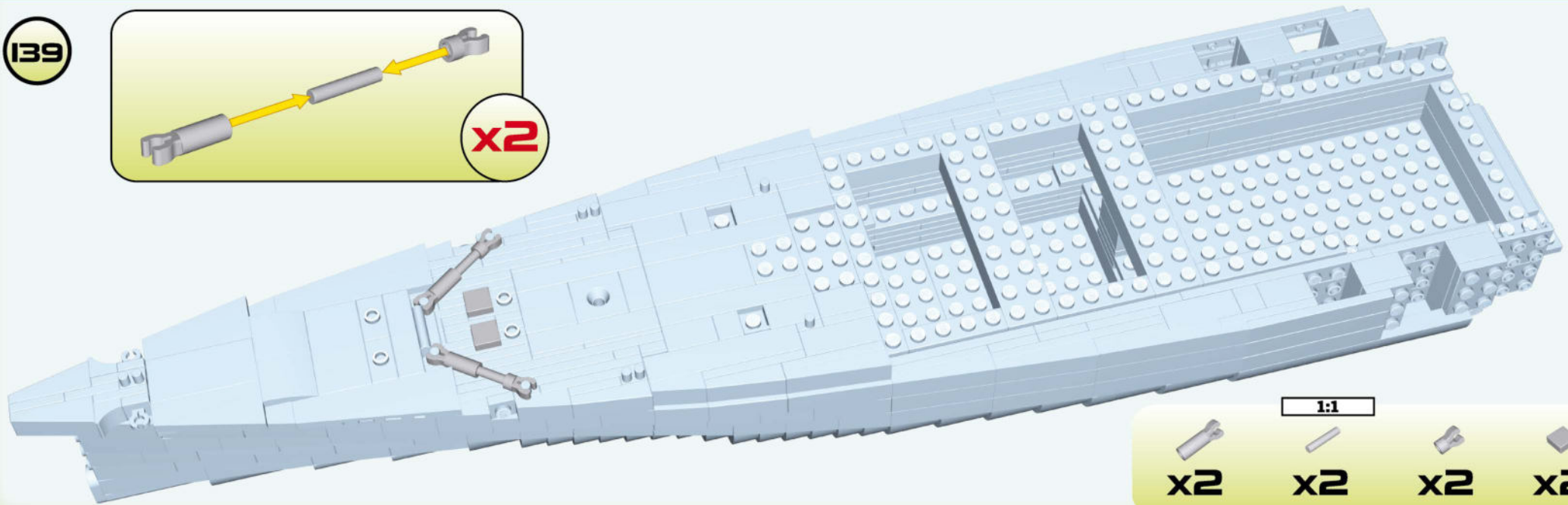

x2



x2



x2



x2

1:1





4

140

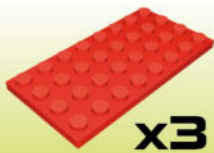
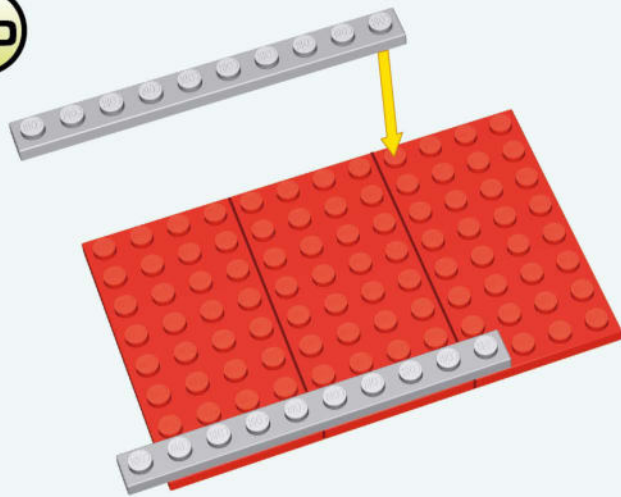

x3



x2

141

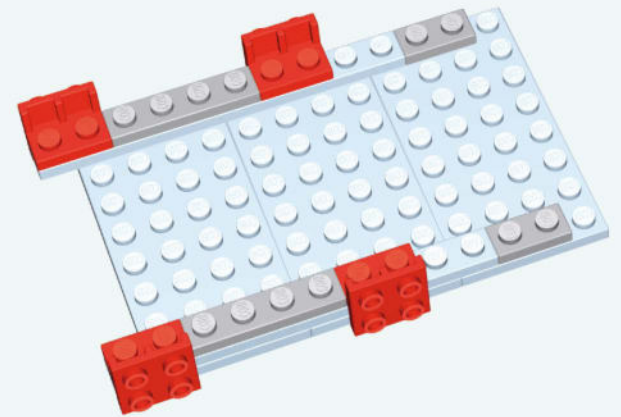

x4



x2



x2

142

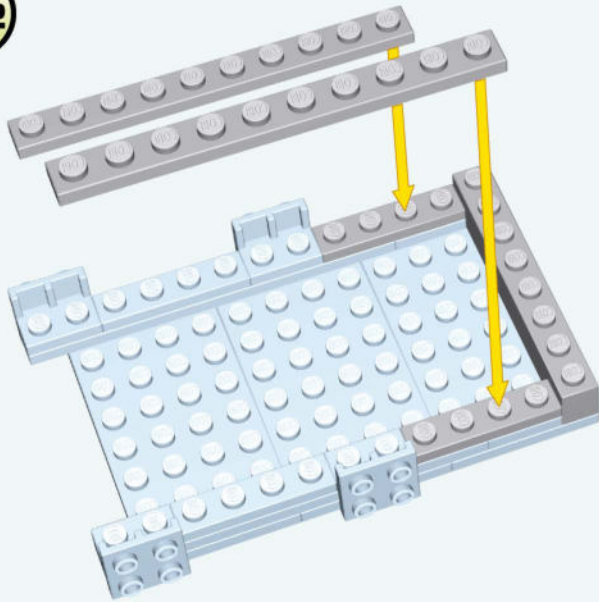

x2



x2

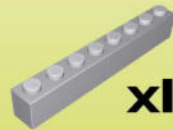

x1

143

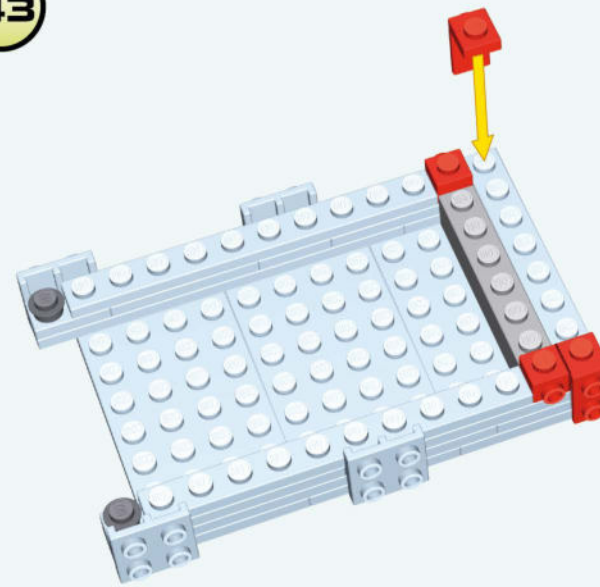

x2



x1



x2



x2

144

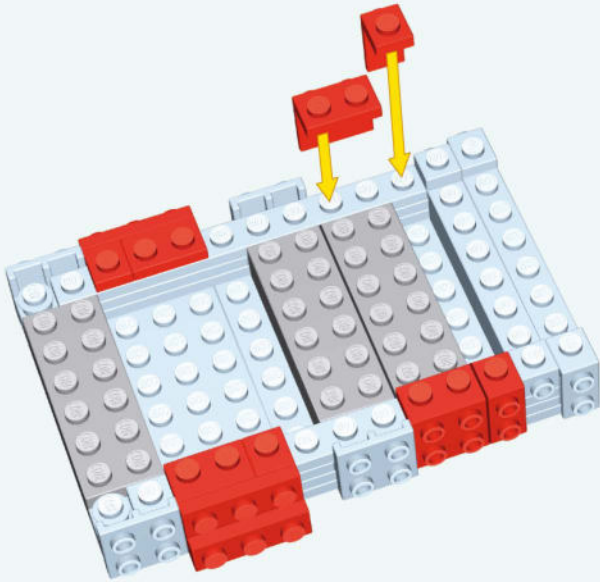
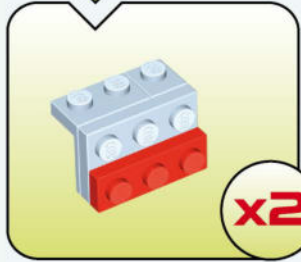
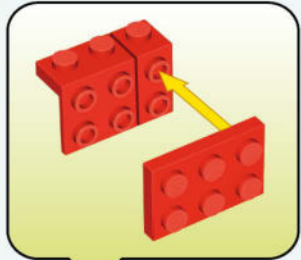

x3



x4



x4



x2



x2

145

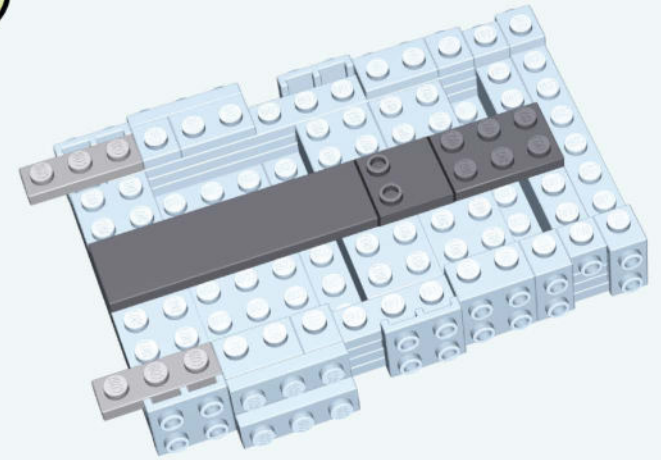

x2



x1



x1



x1

146

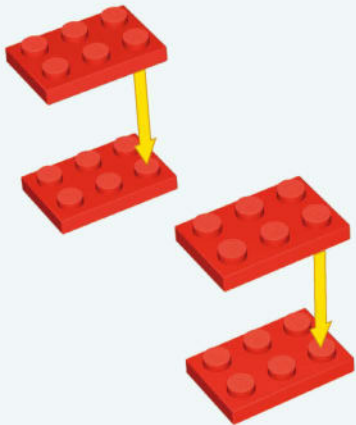

x4

147

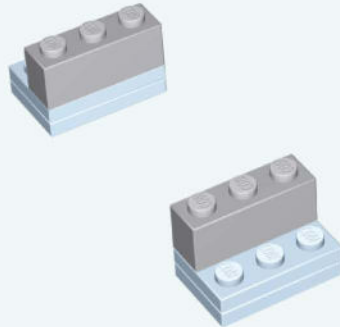

x2

148

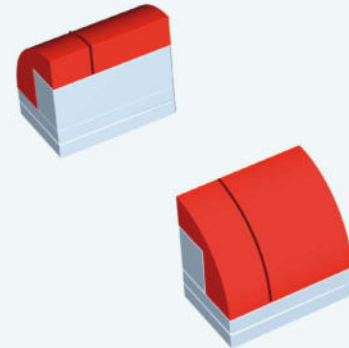

x2



x2

149

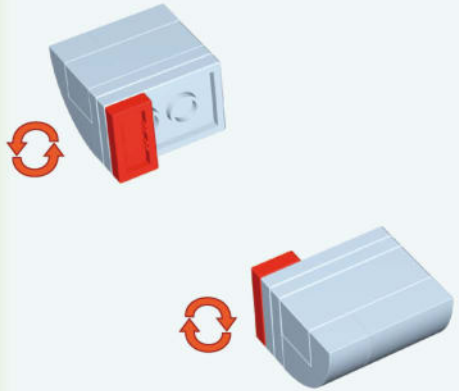

150

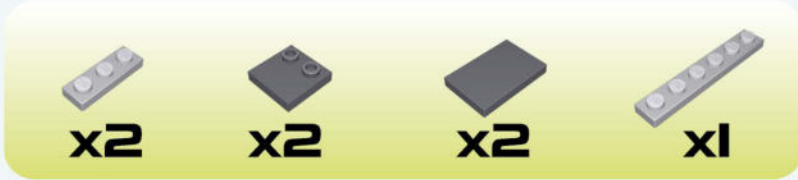
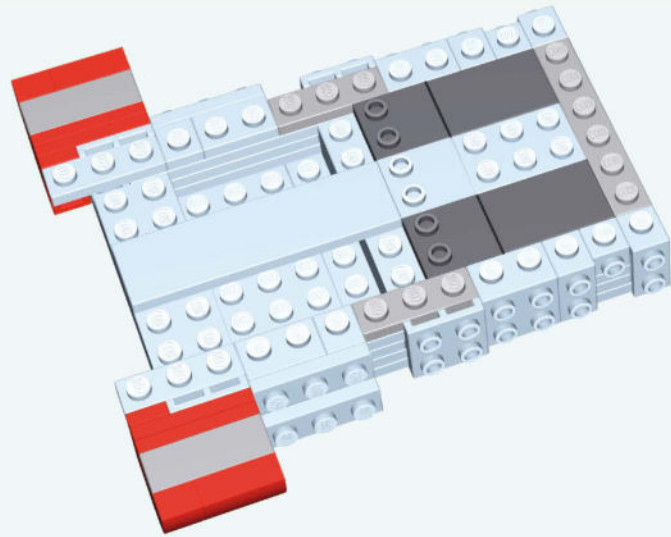

151

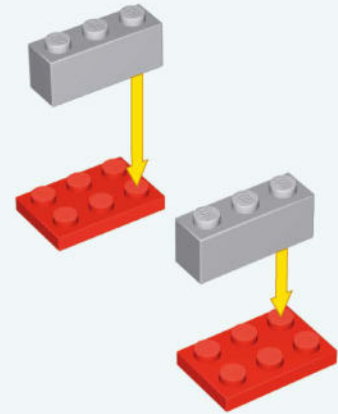

152

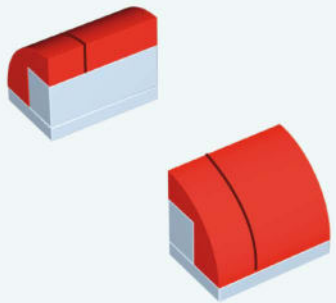

153

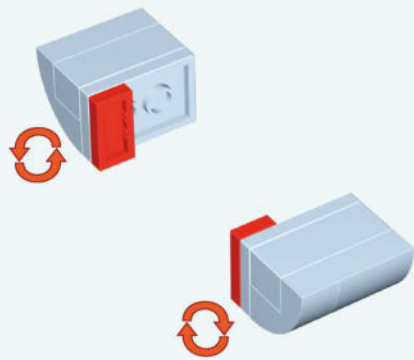

154

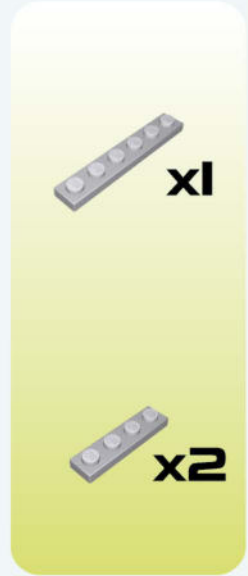
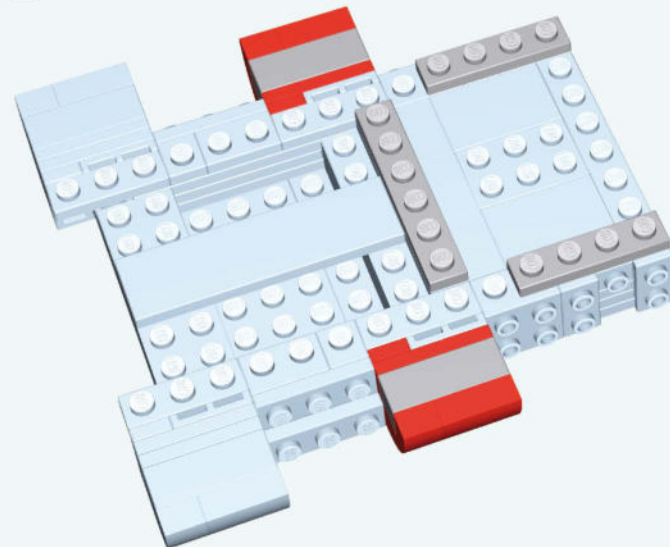



155

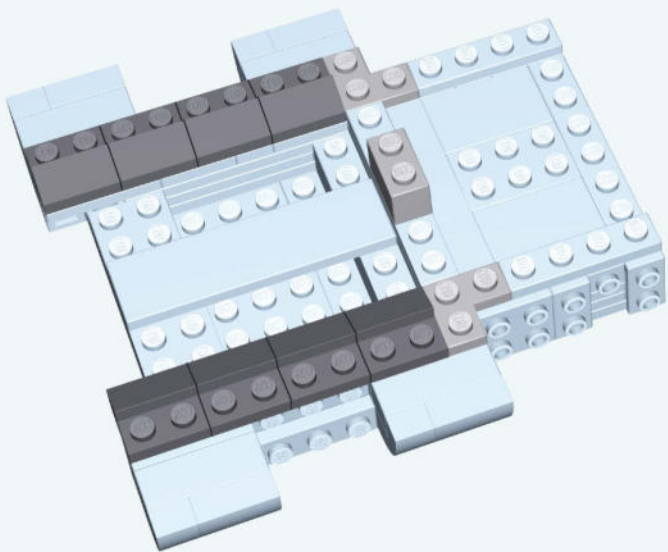

 x8

 x2

 x1

156

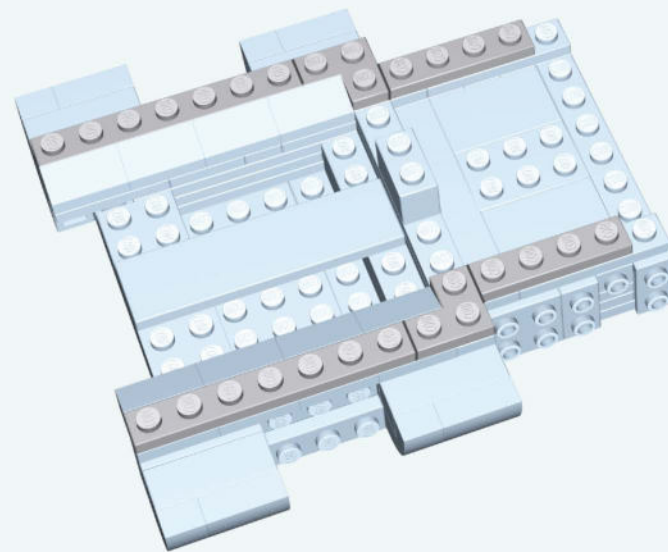

 x2

 x2

 x2

157

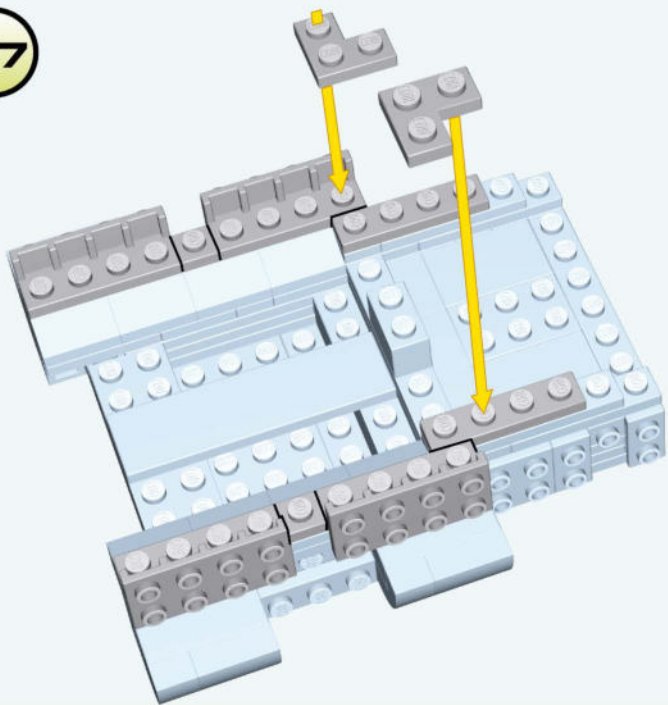

 x4

 x2

 x2

 x2

158

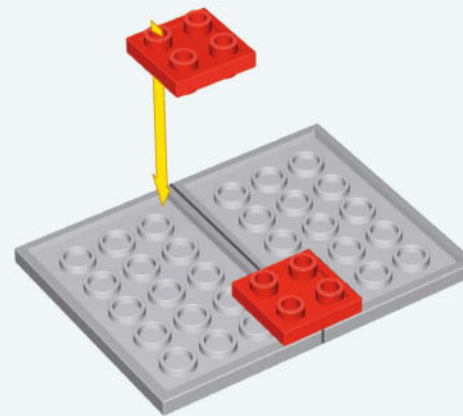

 x2

 x2

159

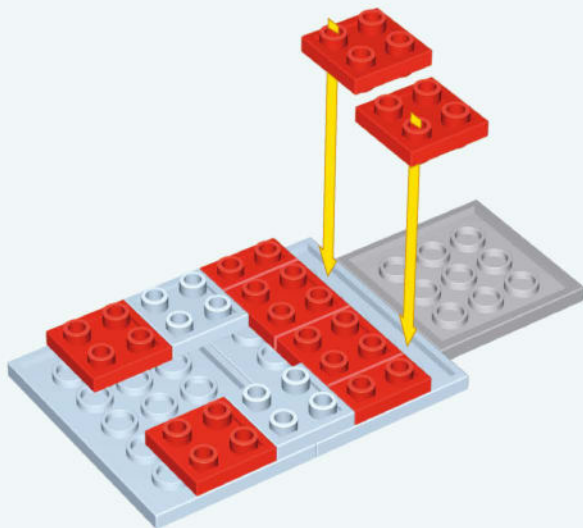

160

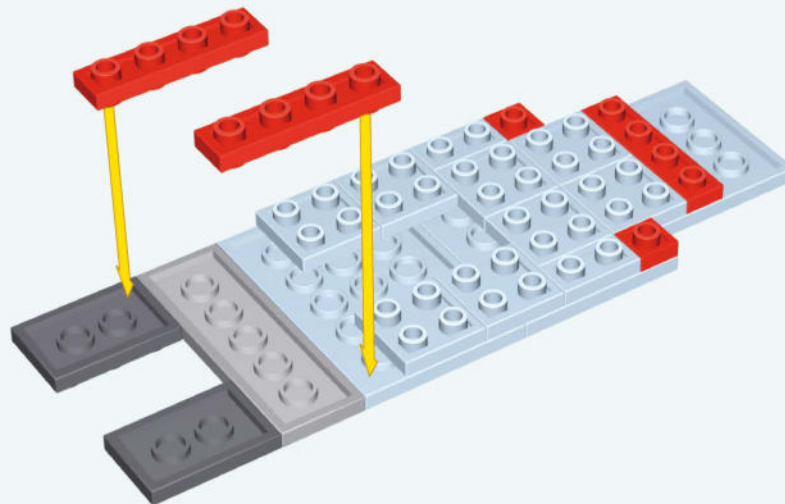

161

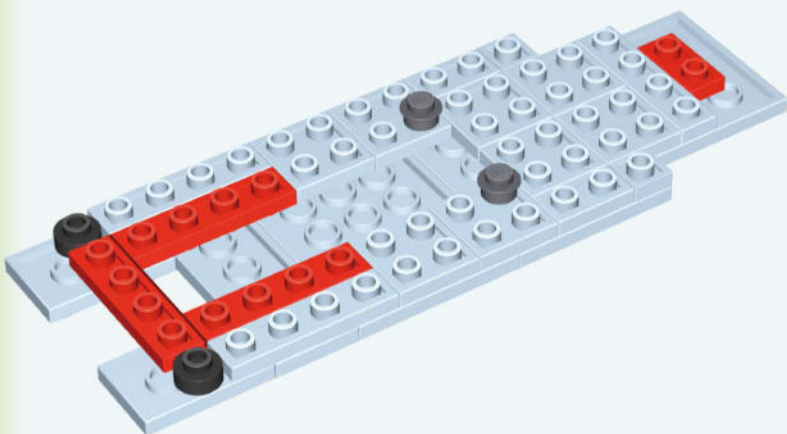

162

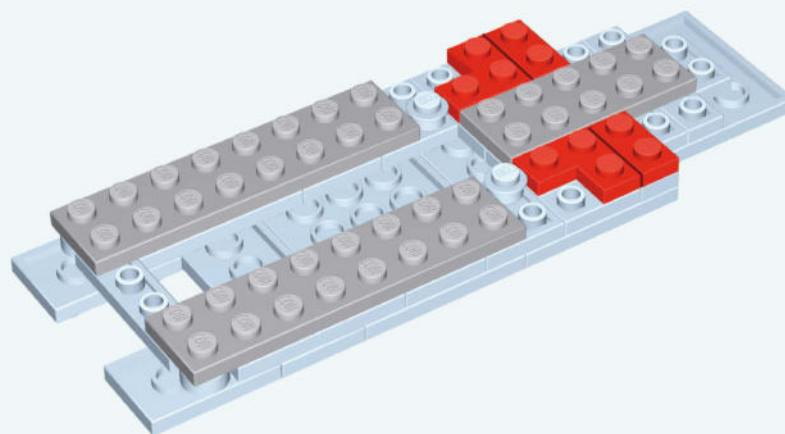

163

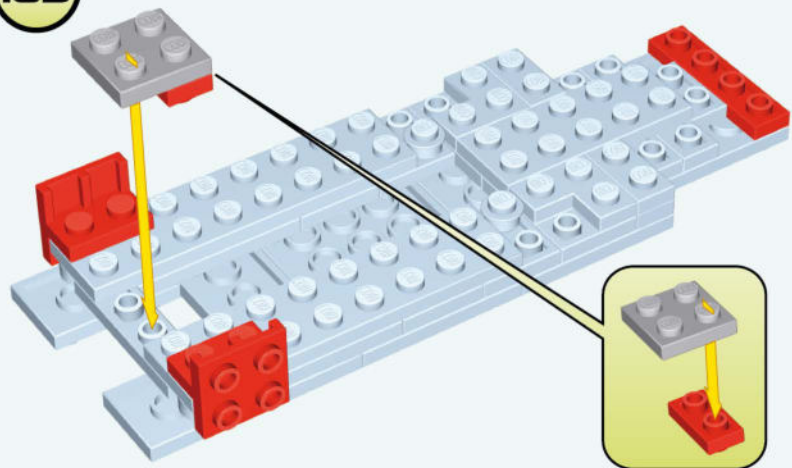

x2



x1



x1



x1

164

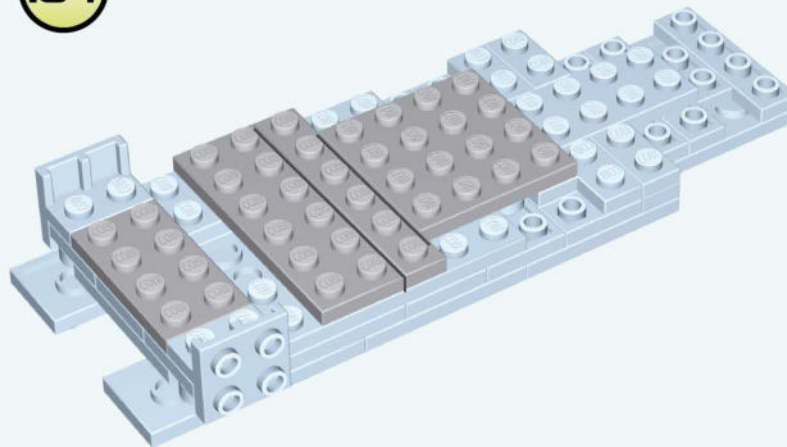

x1



x1



x1

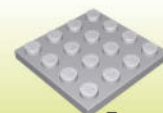

x1

165

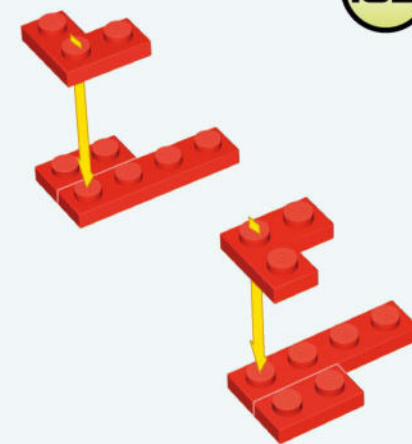

x2



x2



x2

166

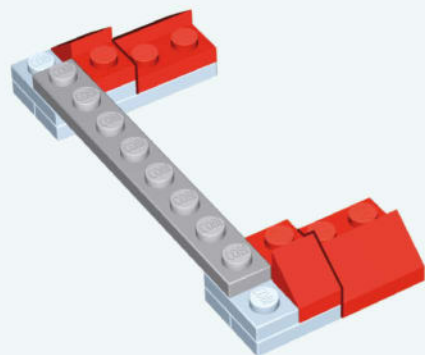

x1



x2



x2

167

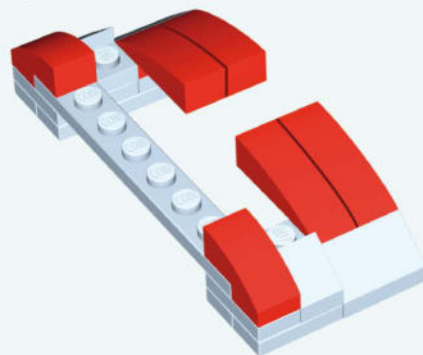

x2



x4

168

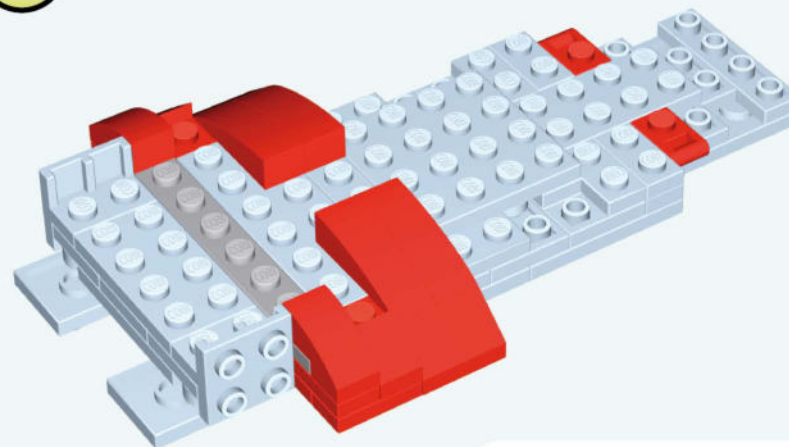

x2



169

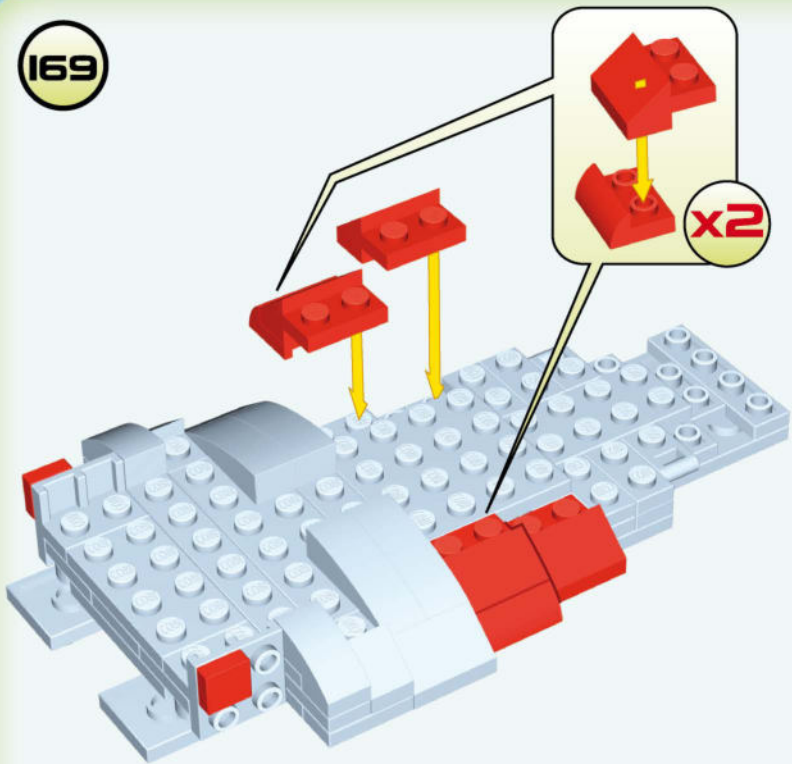

-  x2
-  x2
-  <sup>16</sup> x4

170

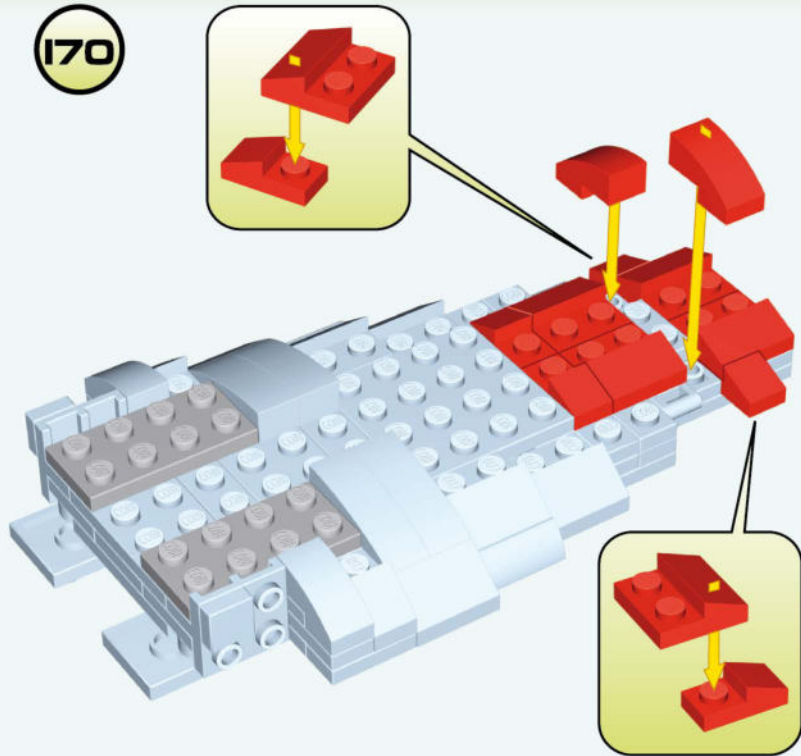

-  x2
-  x4
-  <sup>10</sup> x4
-  <sup>15</sup> x2

171

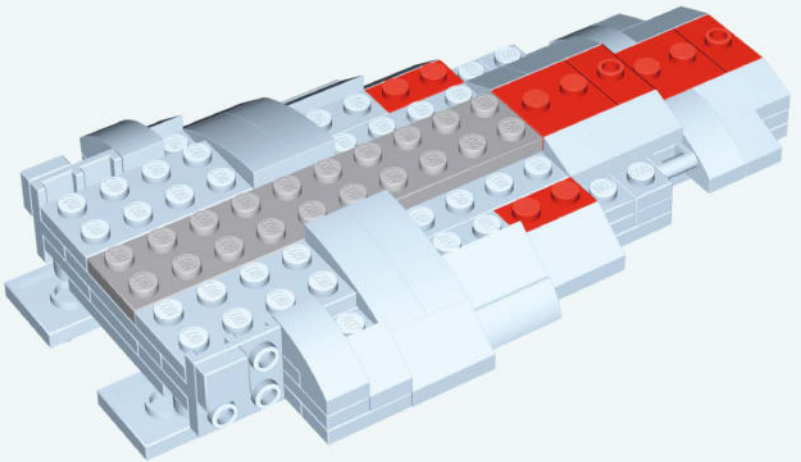

-  x1
-  x2
-  x2
-  x2

172

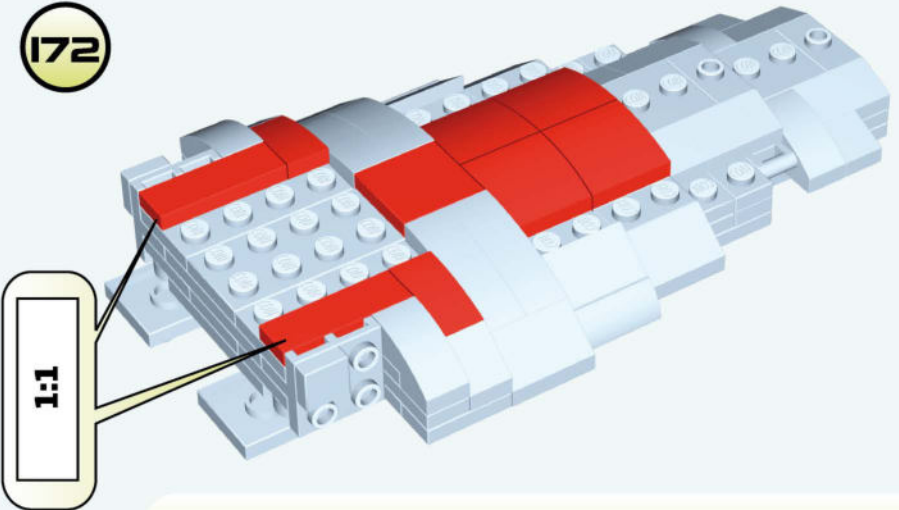

1:1

-  x2
-  <sup>14</sup> x2
-  x1
-  <sup>20</sup> x4

173

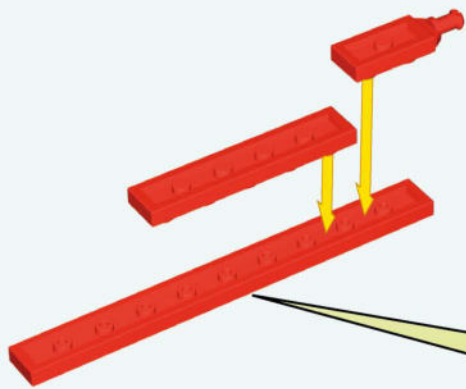

1:1



x1



x1



x1

174

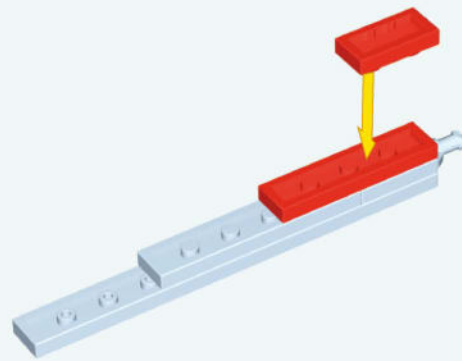

x1



x1

175

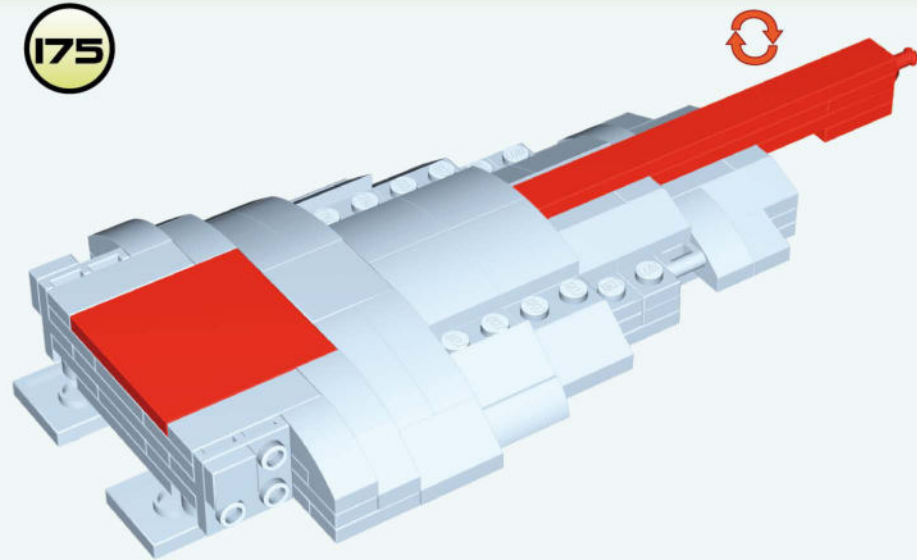

x1

176

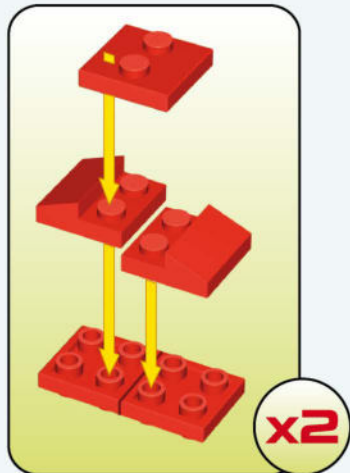

x2

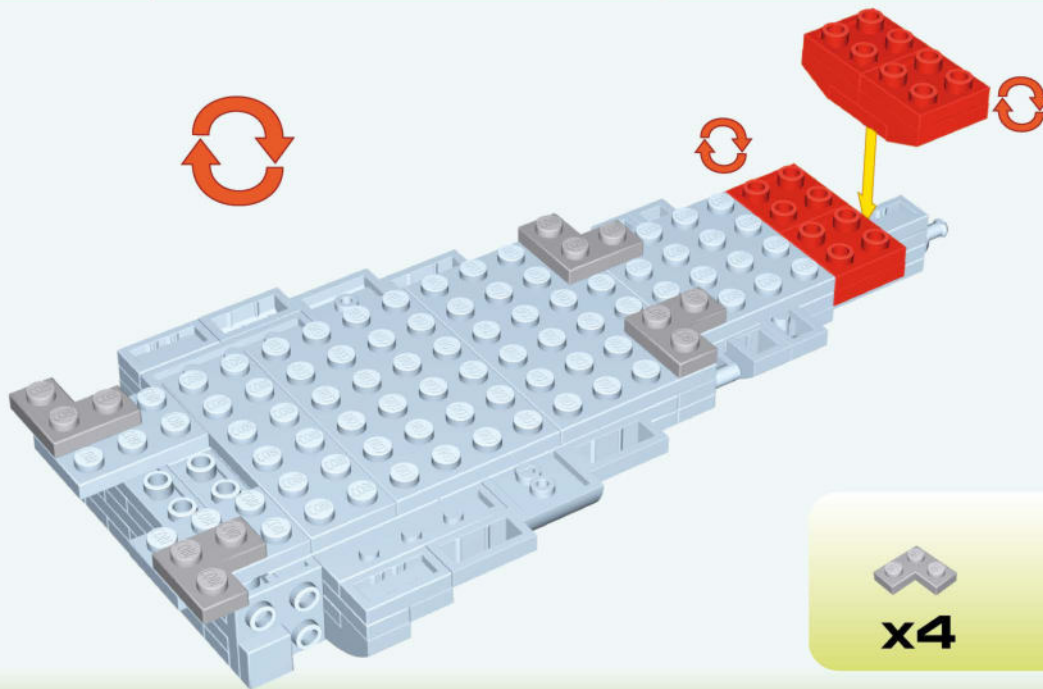

x4



x4



x4



x2



177

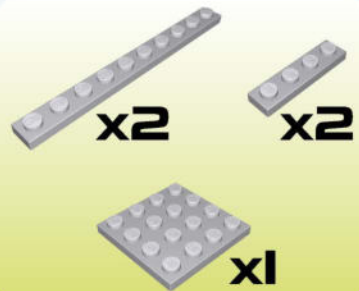
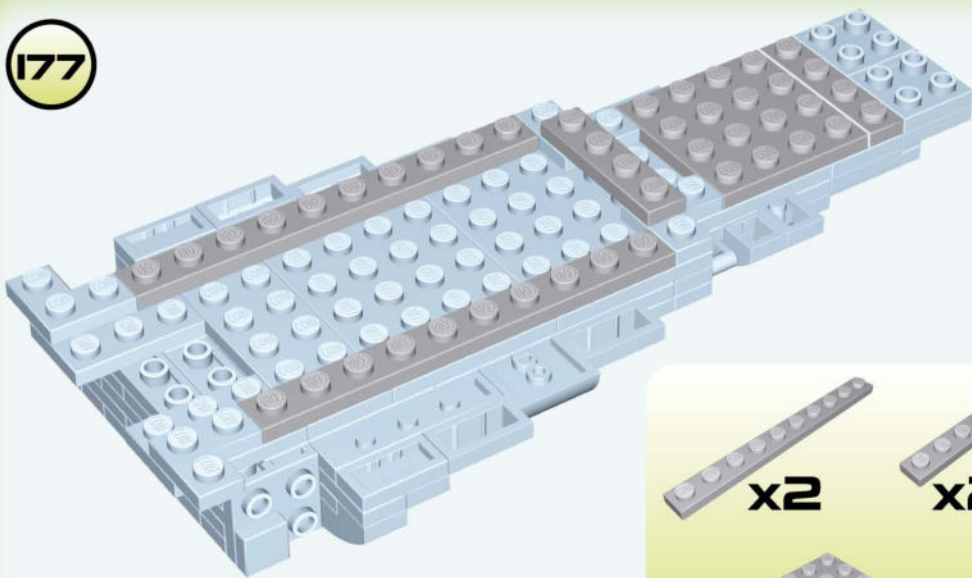

178

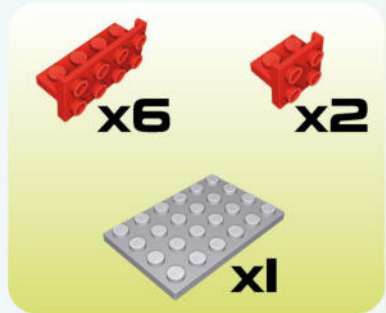
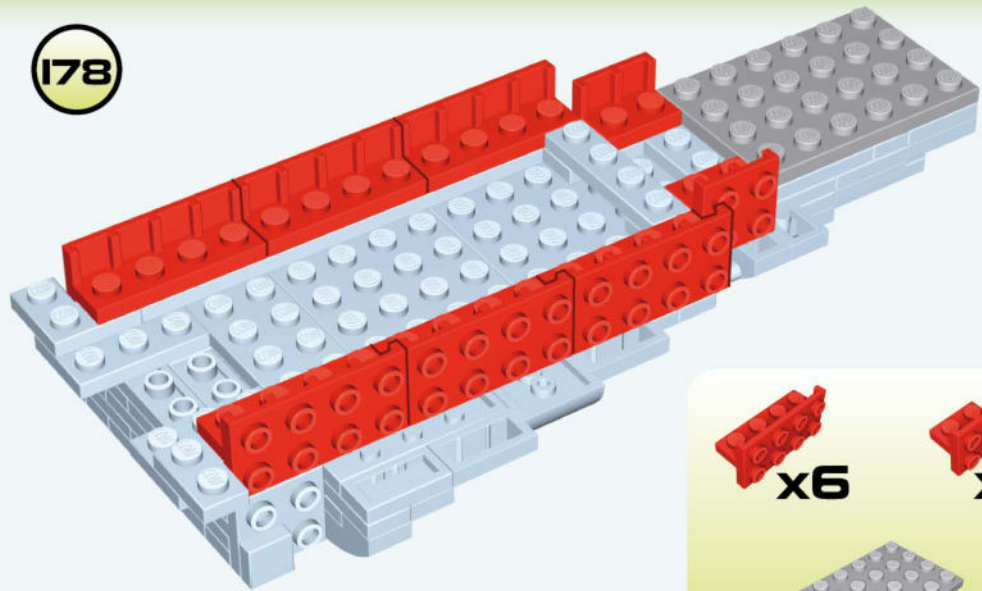

179

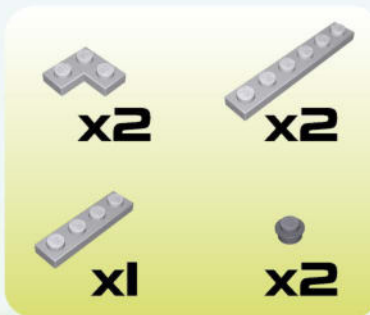
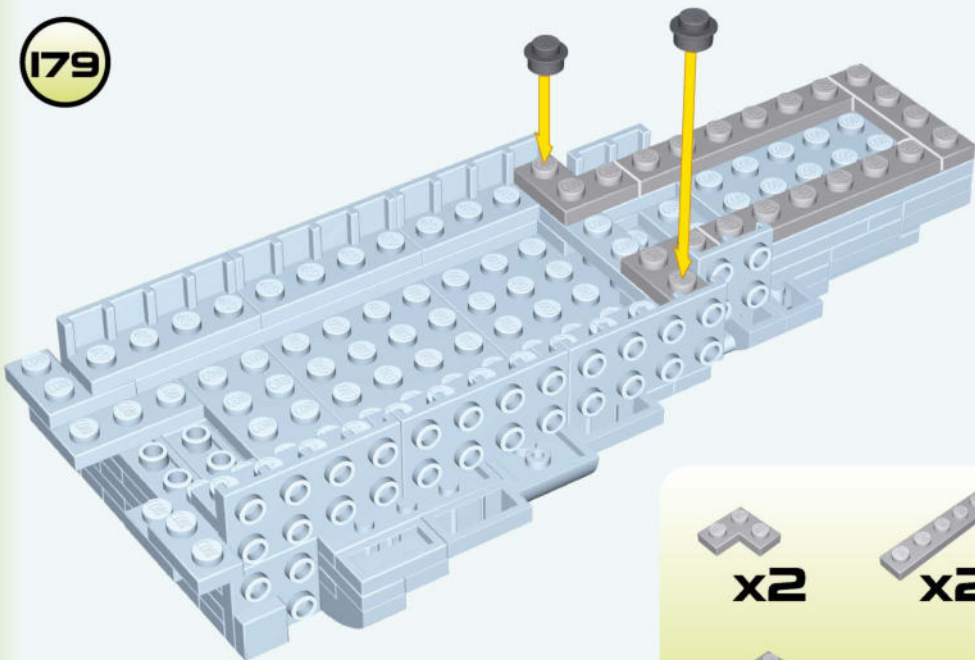

180

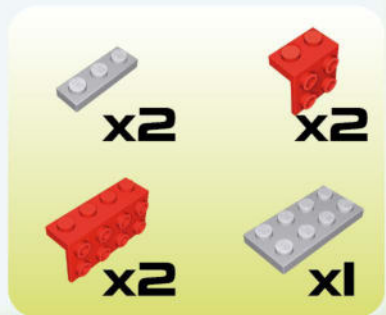
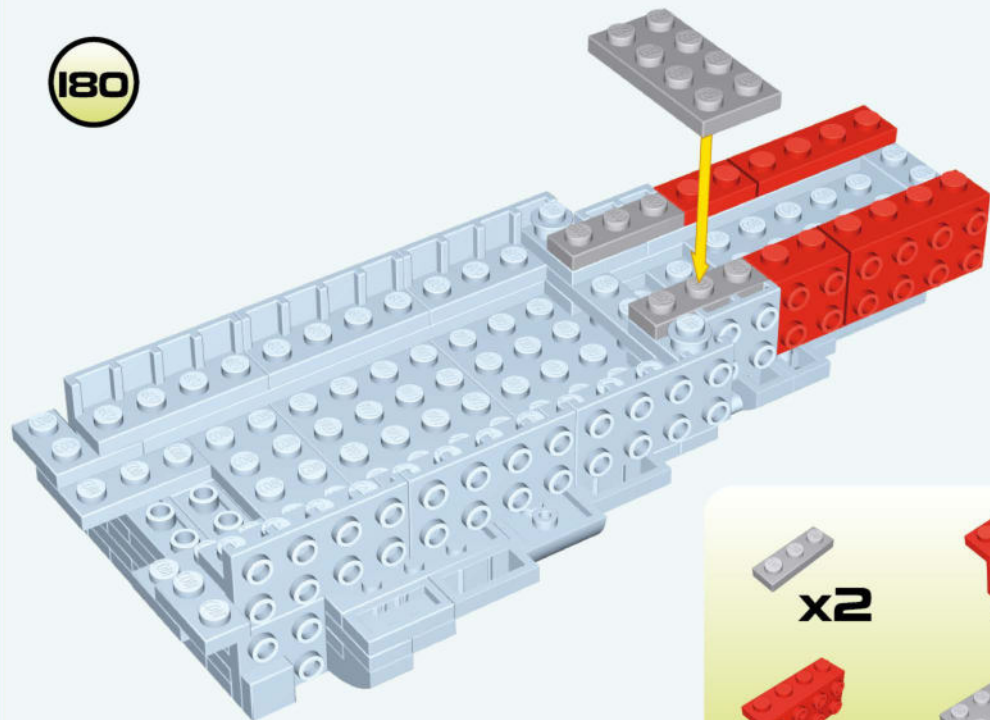



181

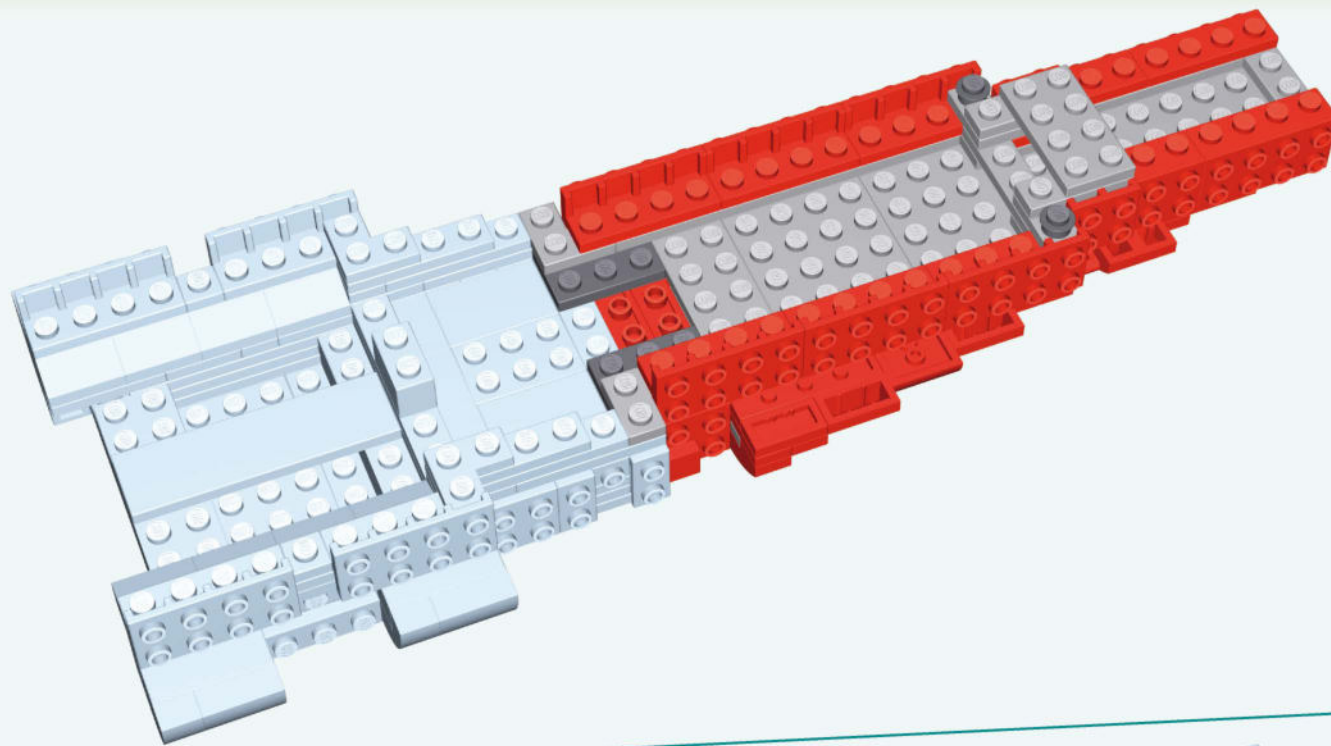

182

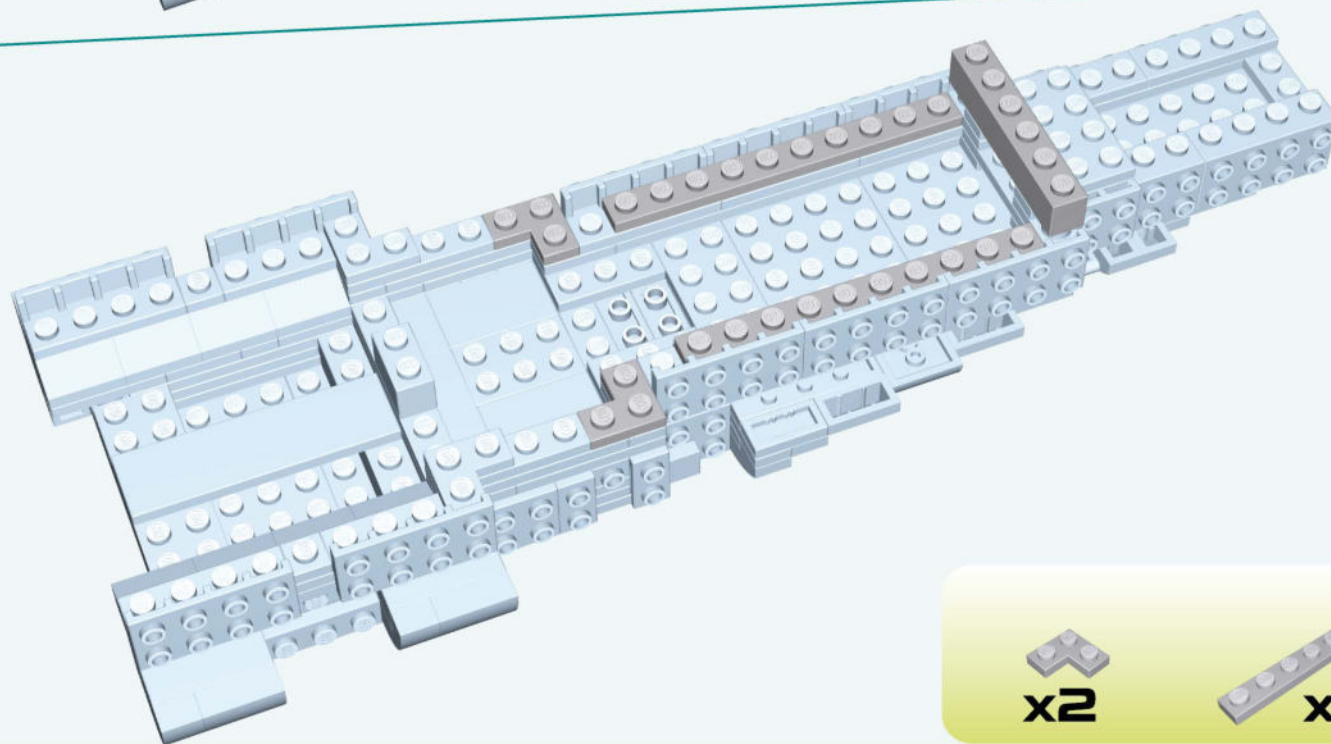

x2



x2



x1

183

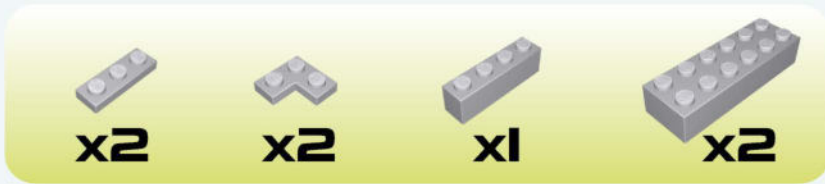
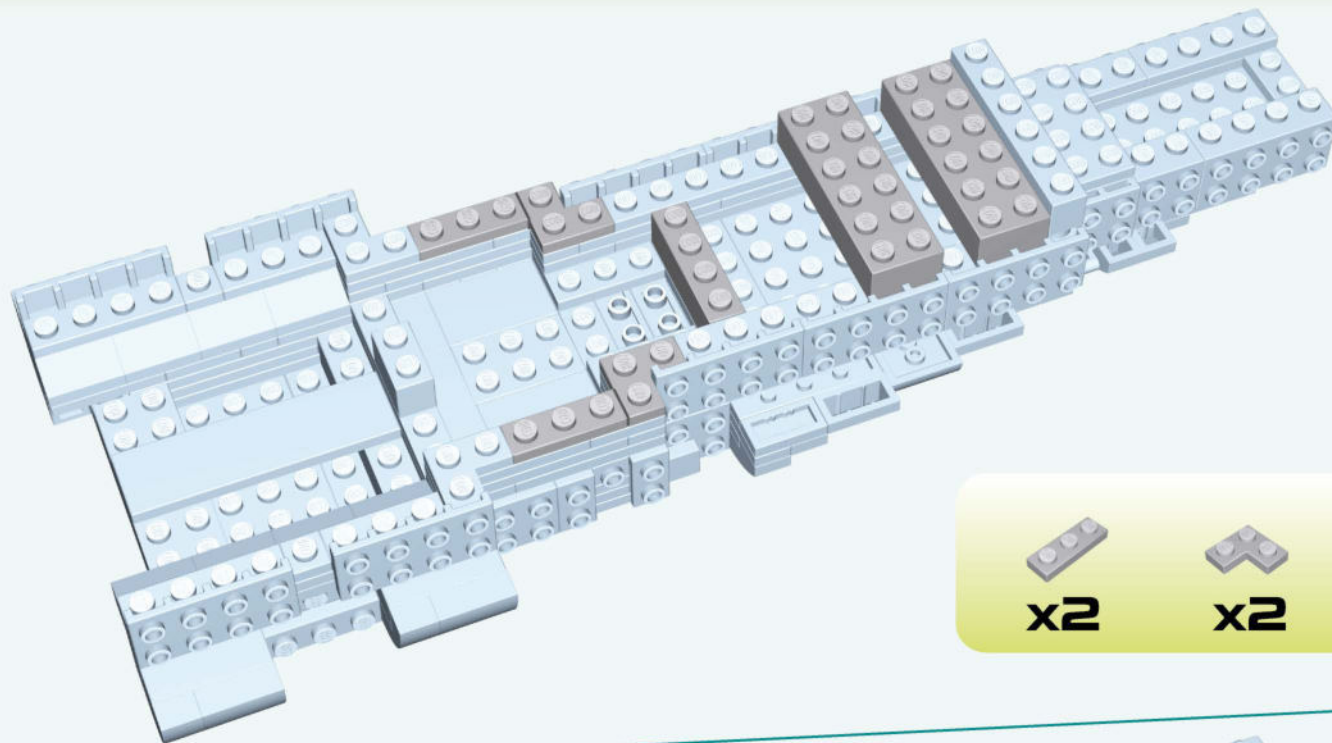

184

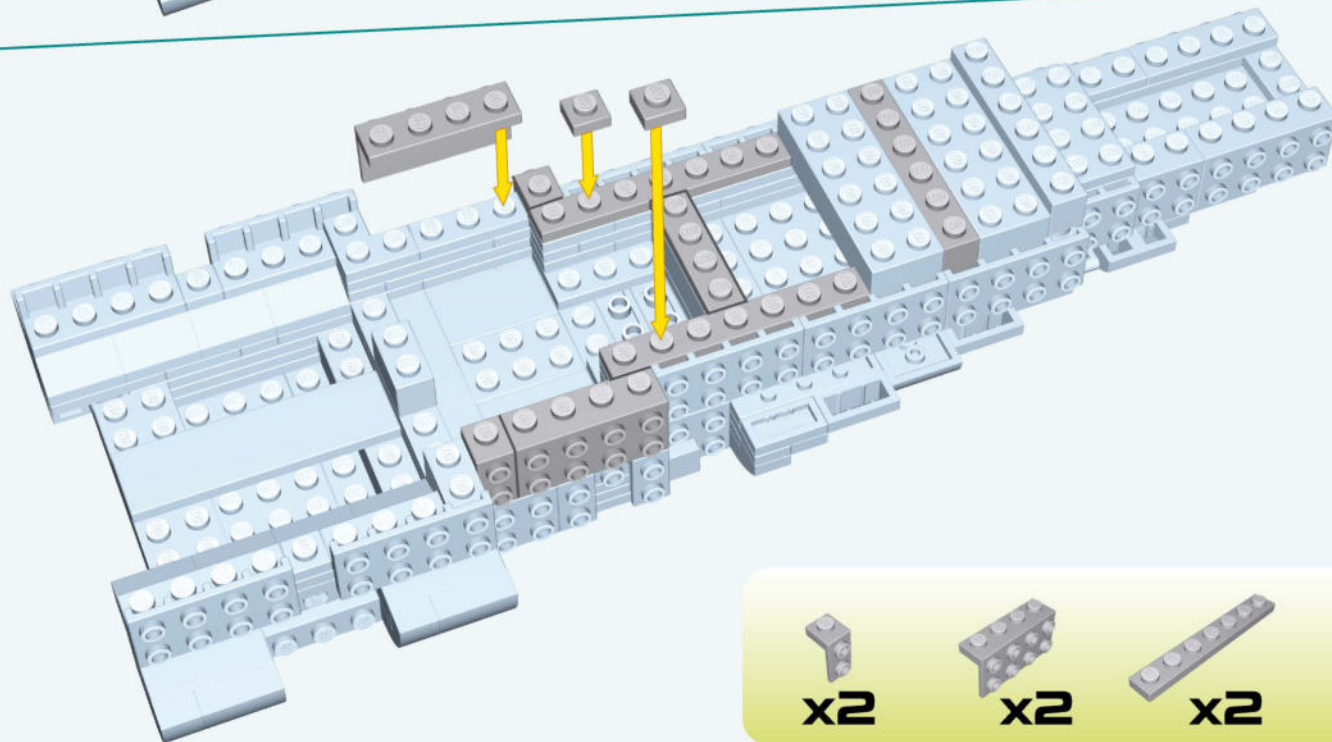





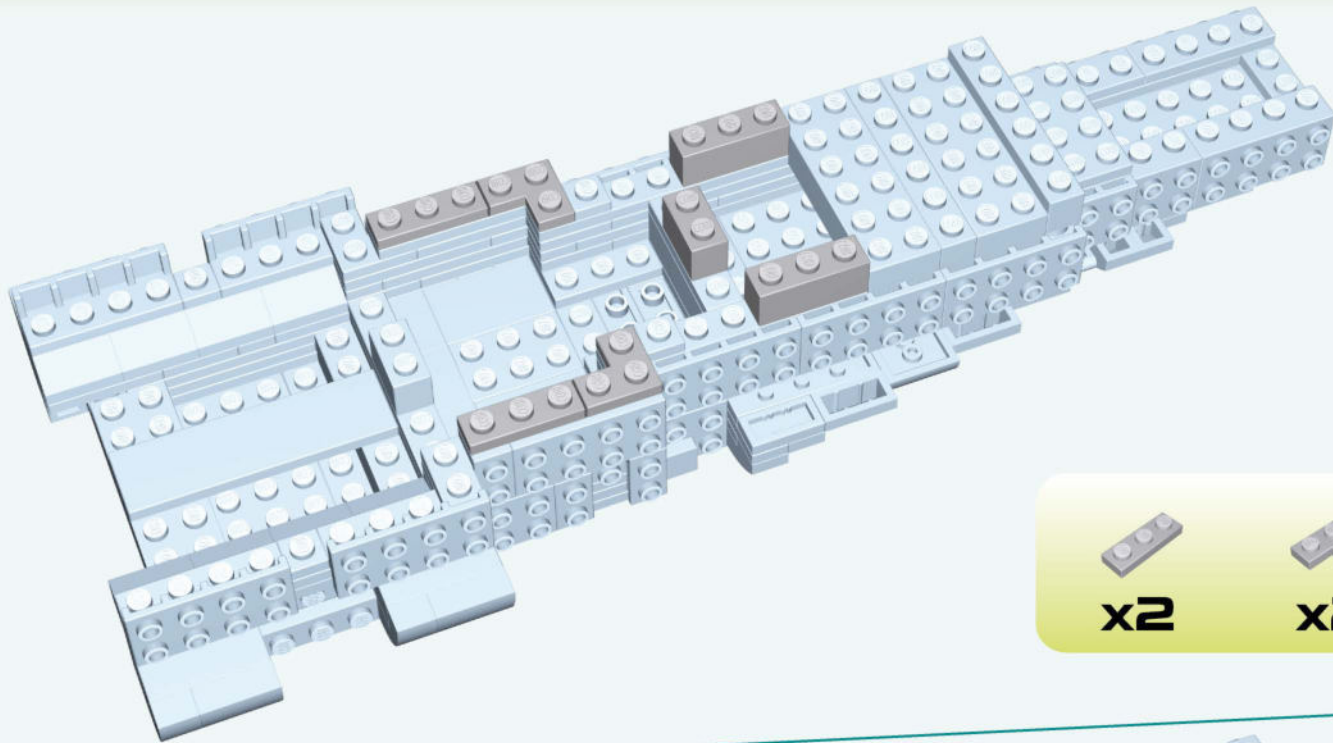

185





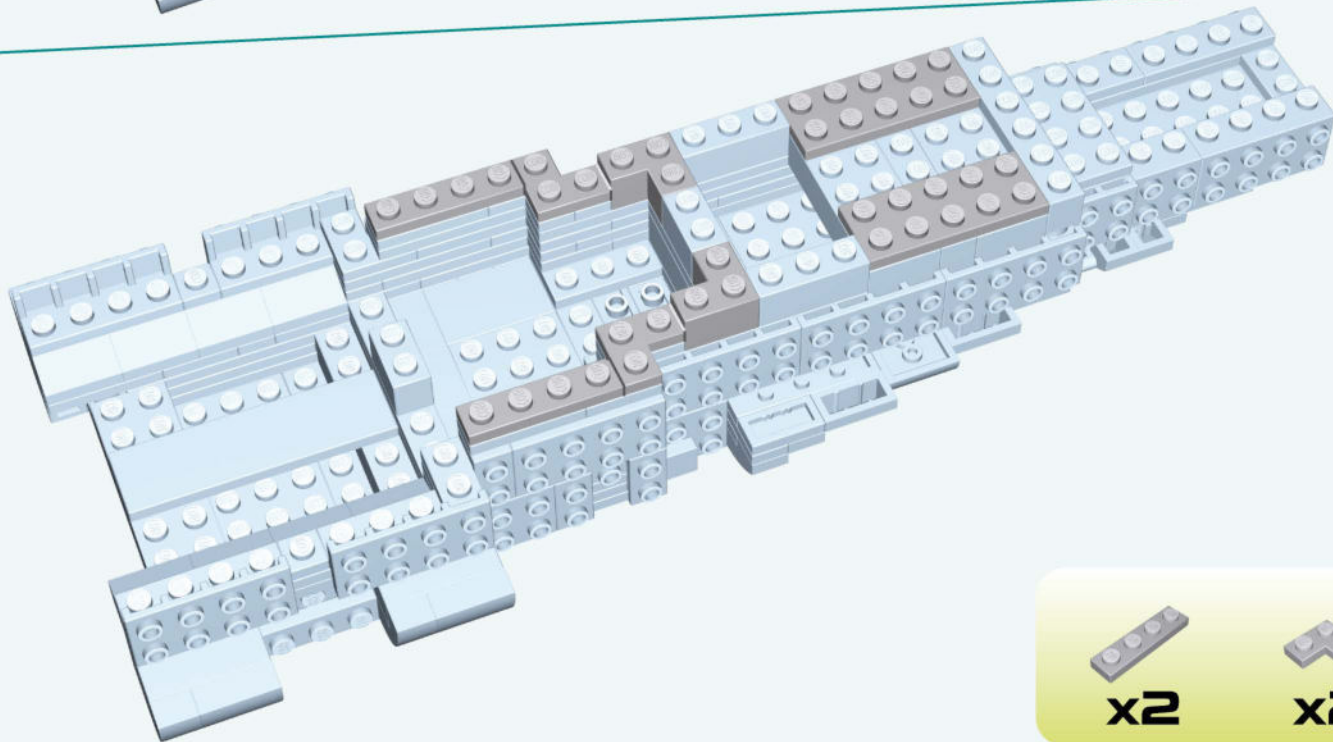

Assembly list for step 185:

-  x2
-  x2
-  x1
-  x2

186



Assembly list for step 186:

-  x2
-  x2
-  x2
-  x2



187

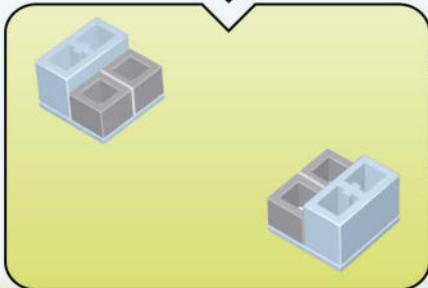
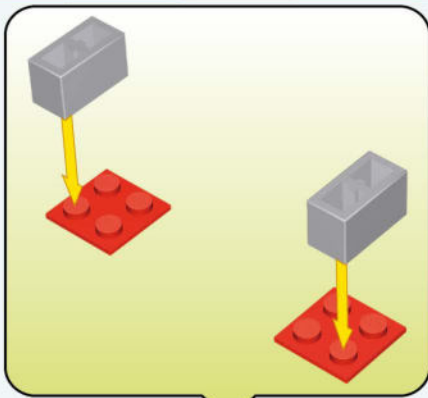
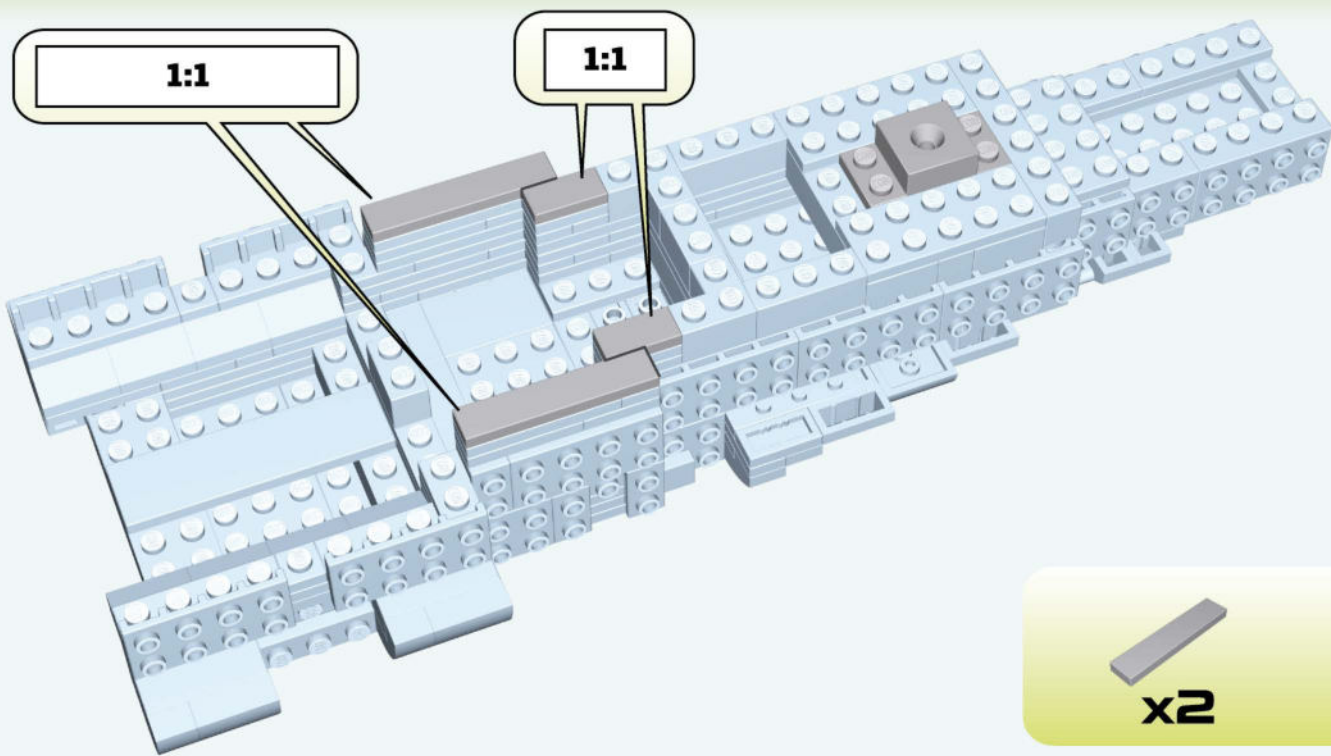

188

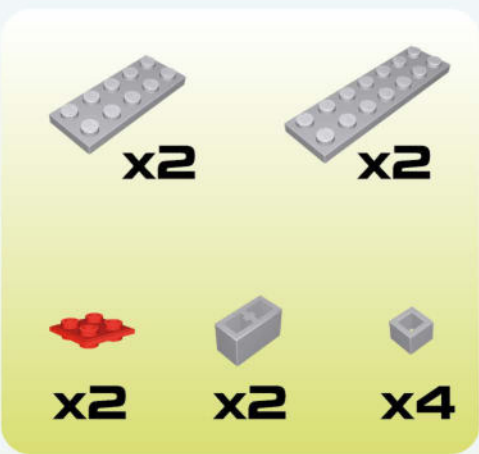
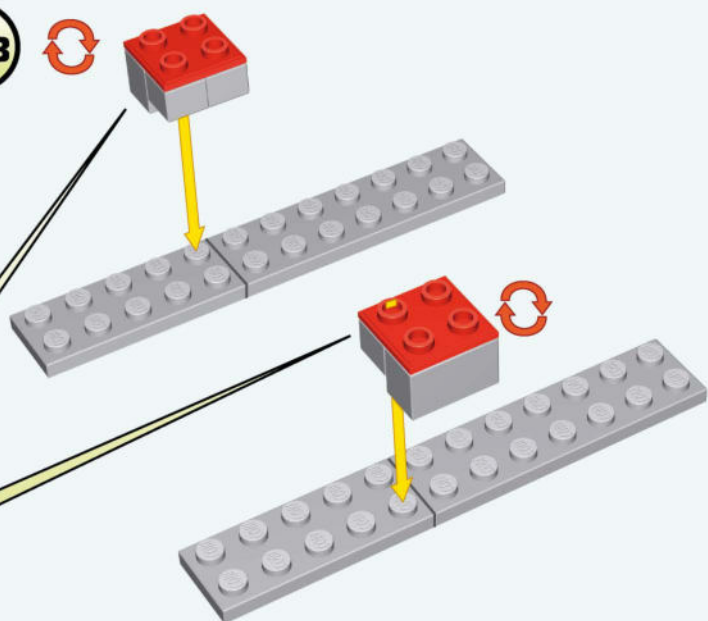

189

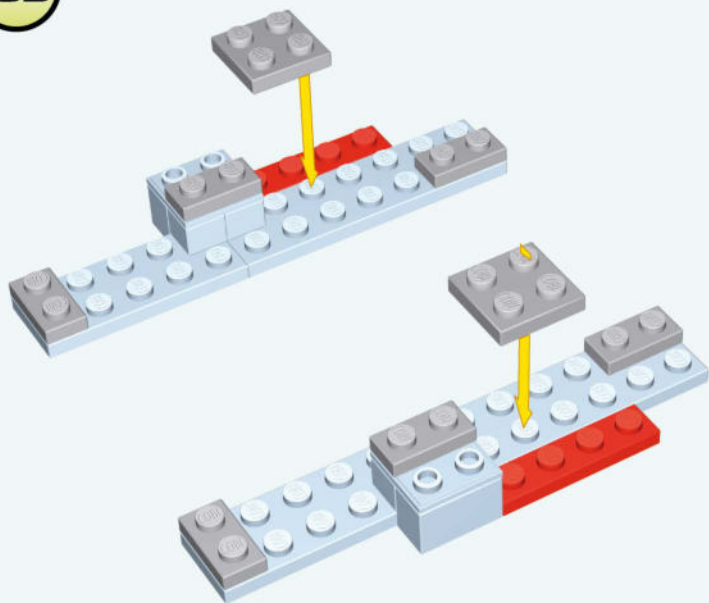

 x6

 x2

 x2

190

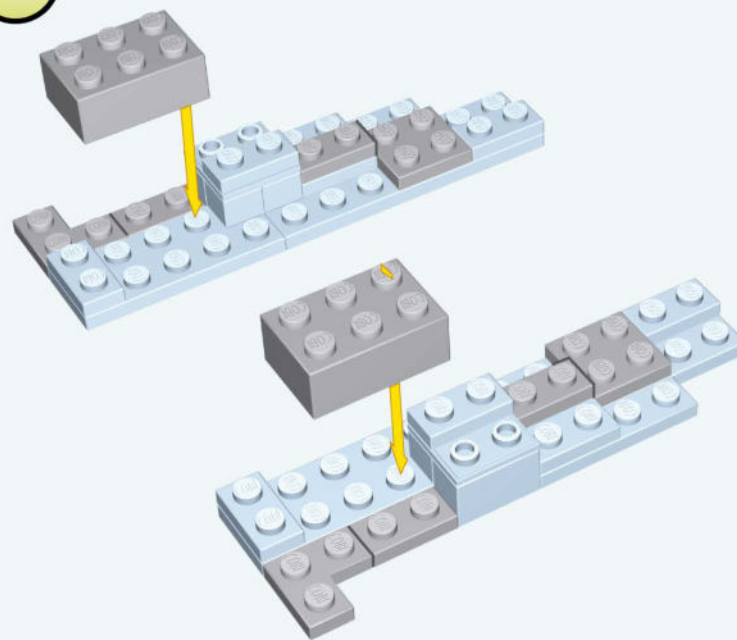

 x2

 x4

 x2

 x2

191

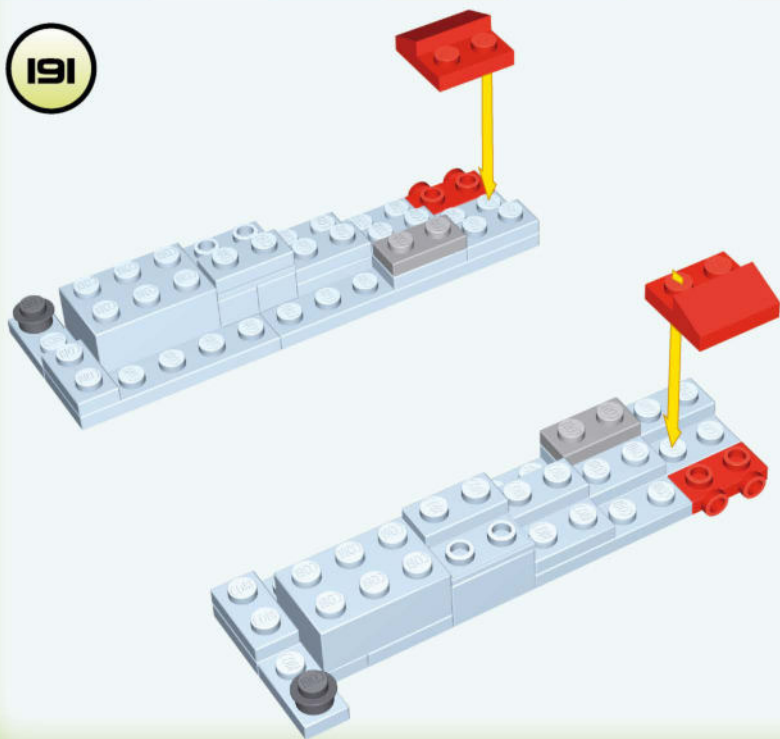

 x2

 x2

 x2

 x2

192

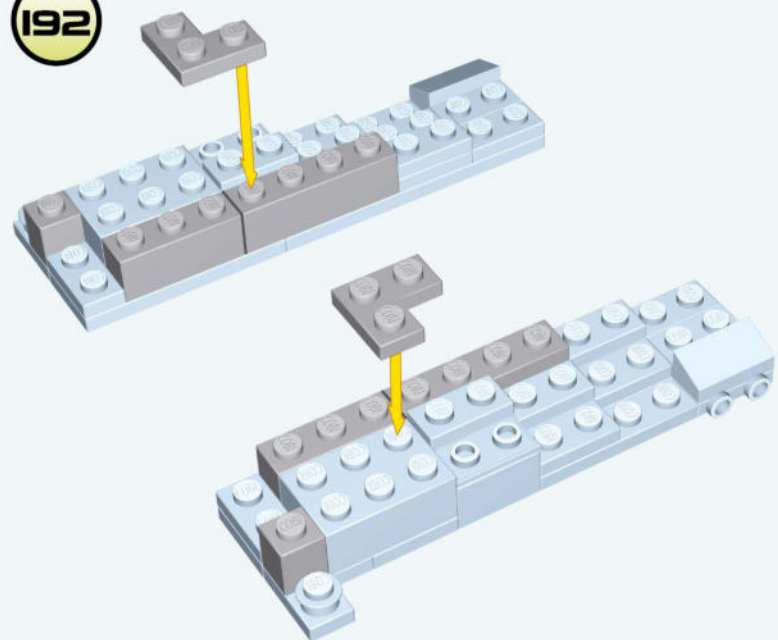

 x2





 x2

 x2

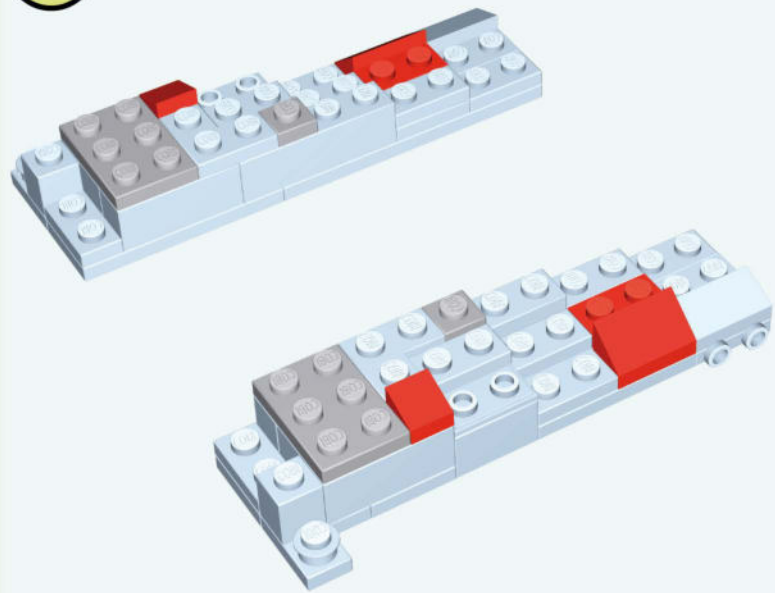
 x2



193



-  x2
-  x2
-  x2
-  x2

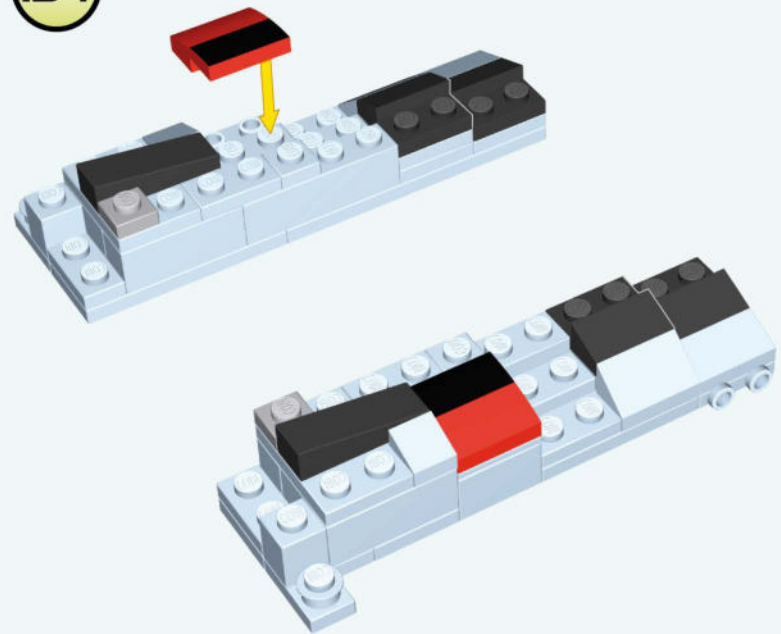





194

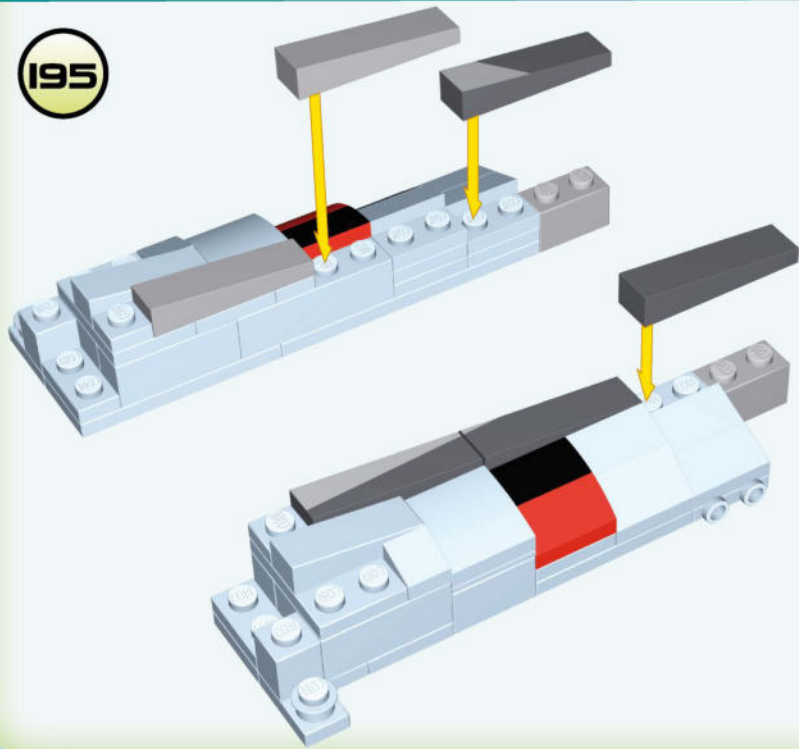

-  x2
-  x2
-  x2
-  x4

195



-  x2
-  x2
-  x2
-  x1
-  x1
-  x1
-  x1

196

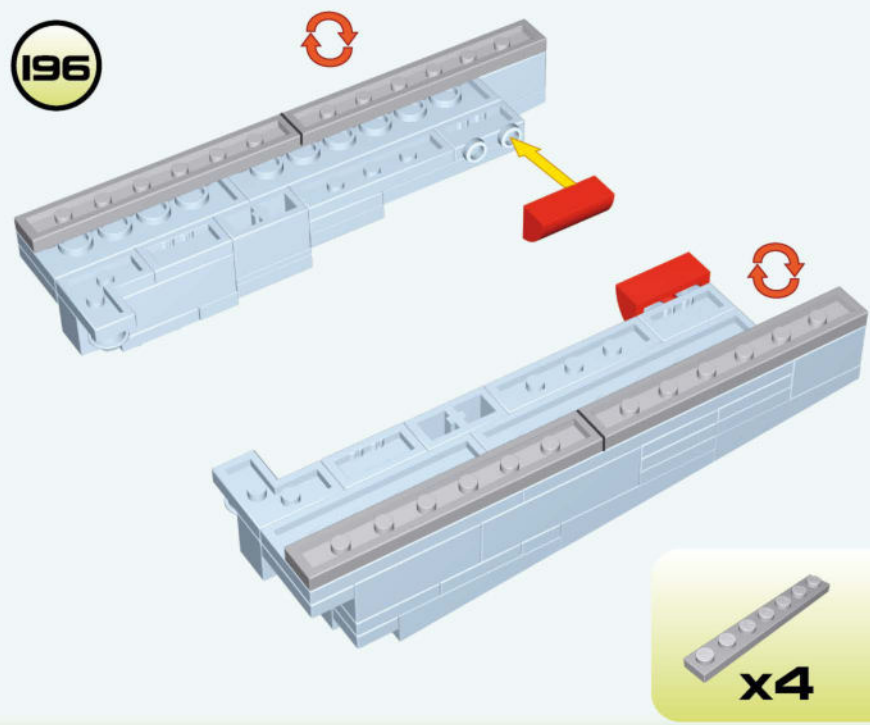

-  x4
-  x2



197

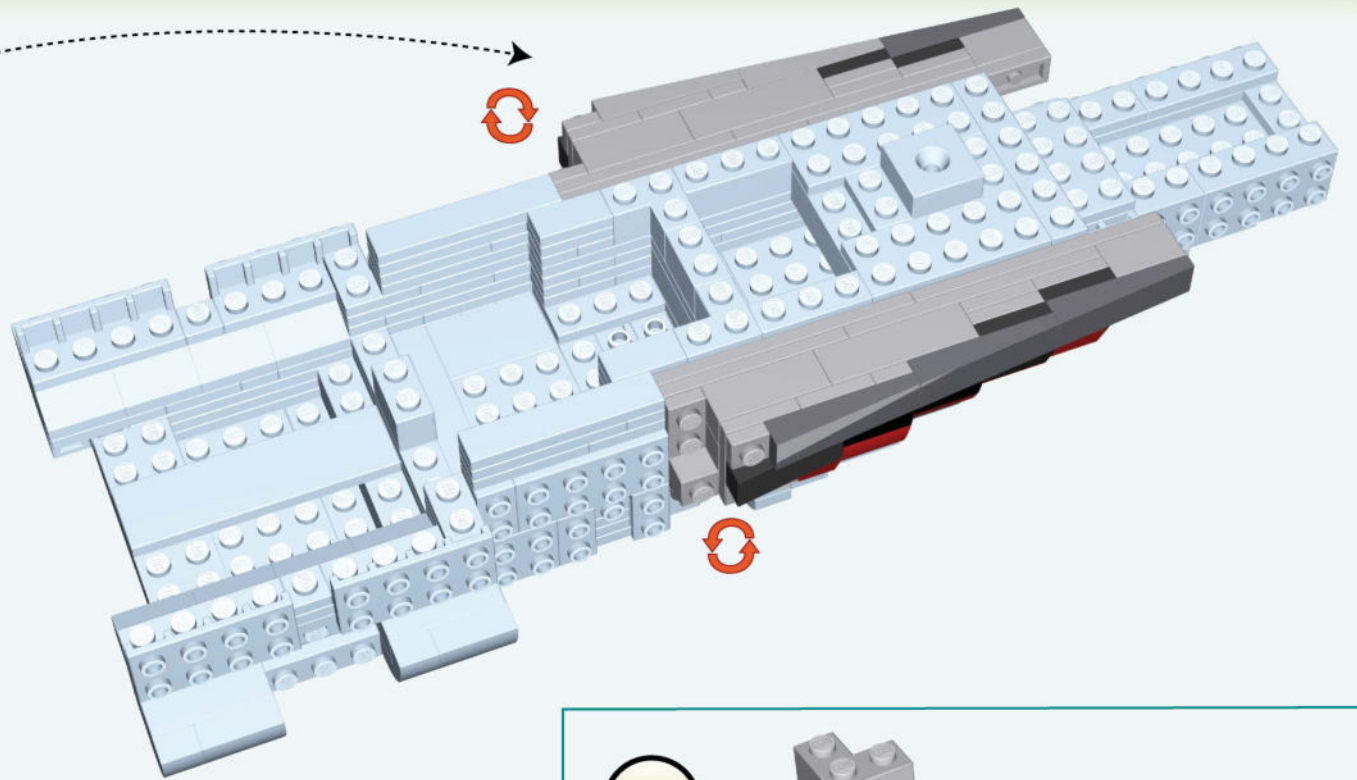
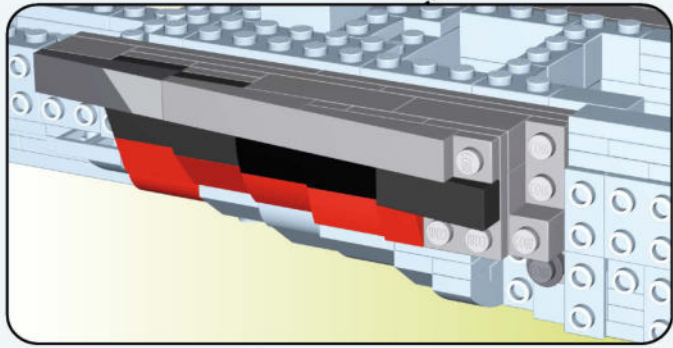

198

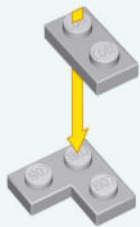

x2



x2

199

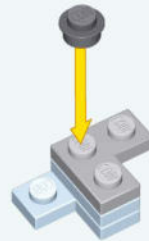
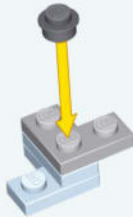

x2



x2

200

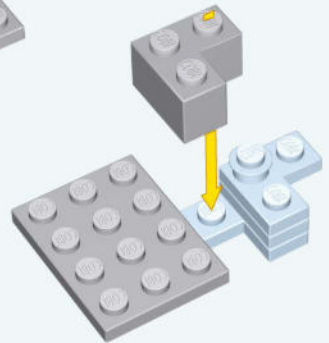
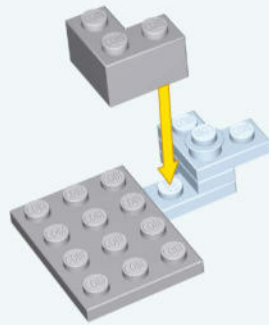

x2



x2

201

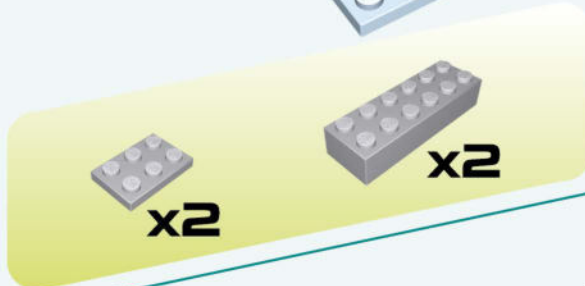
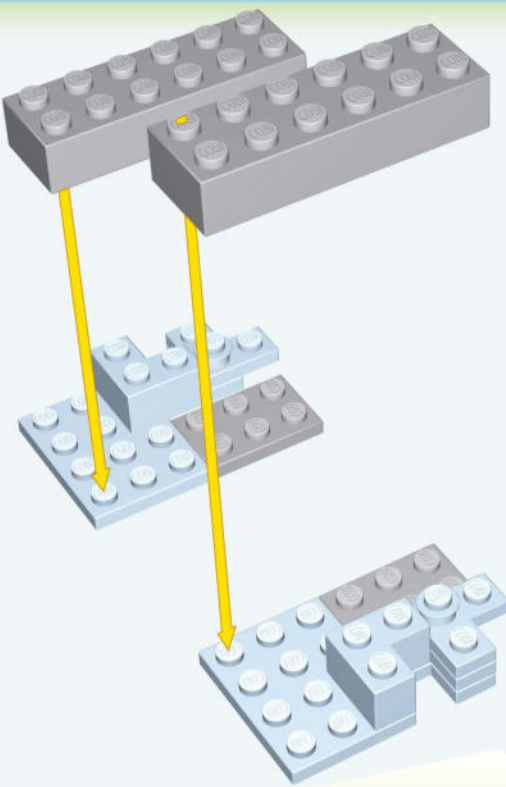

202

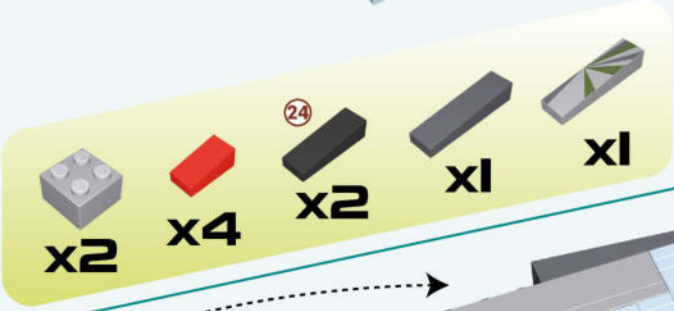
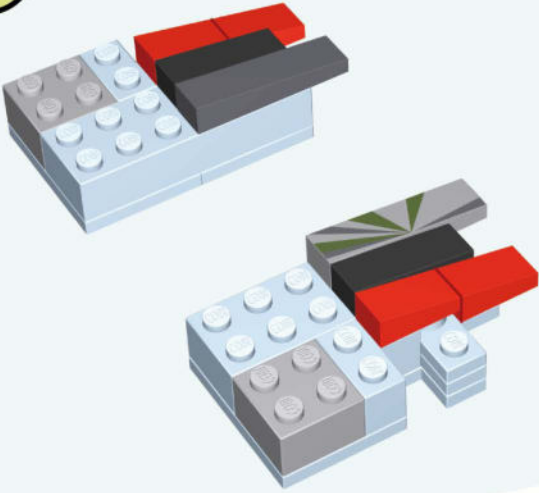

203

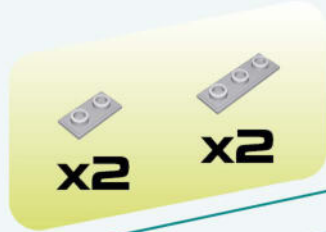
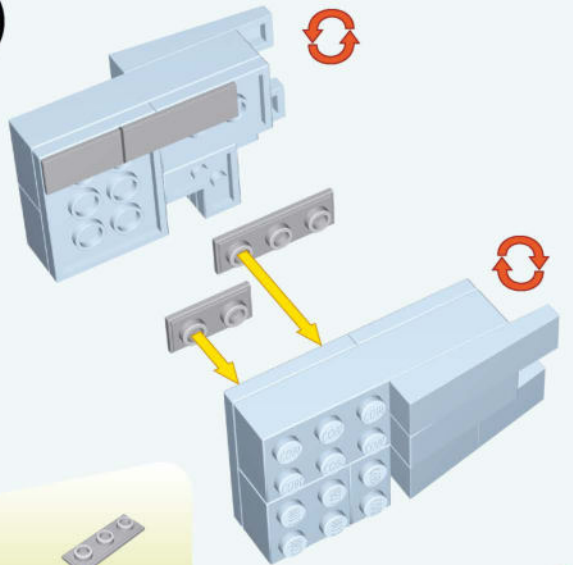

204

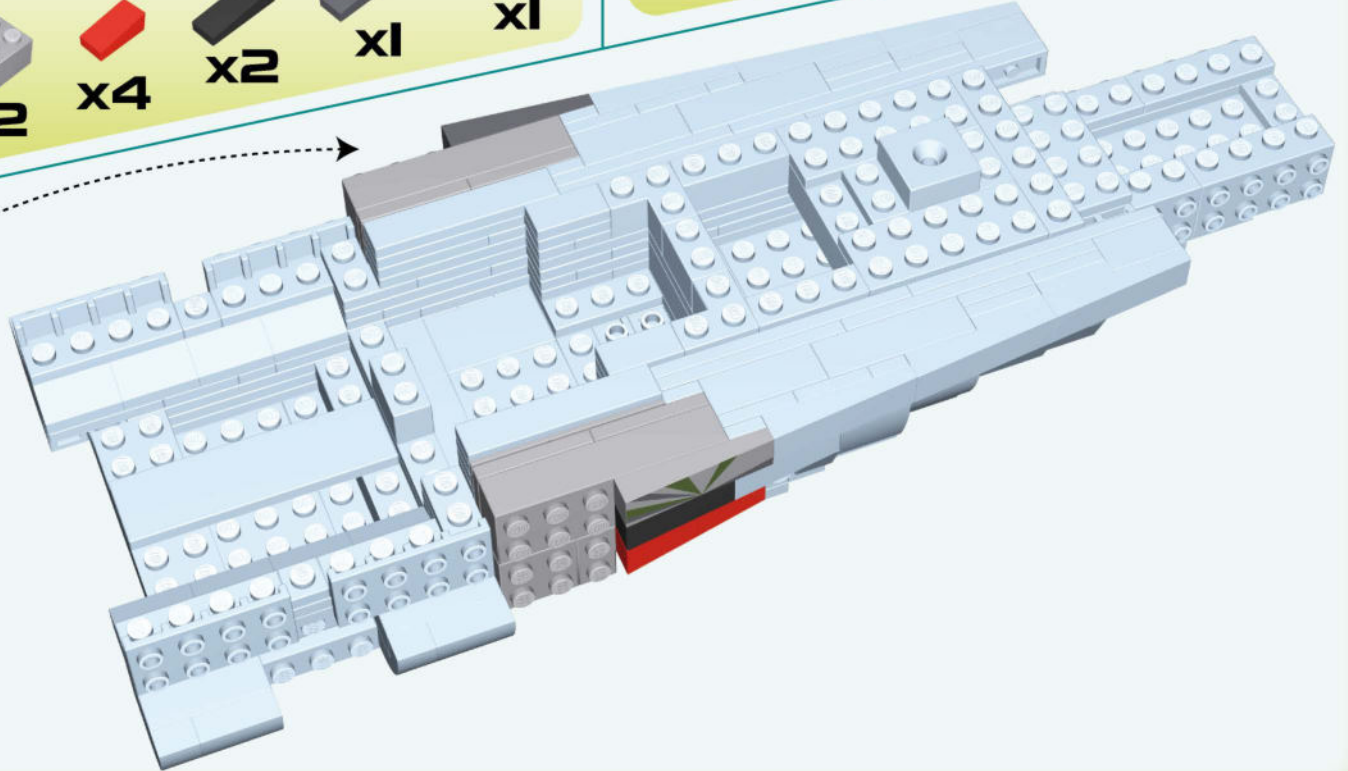
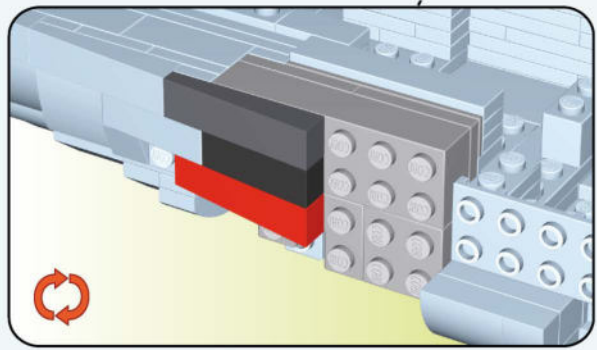

205

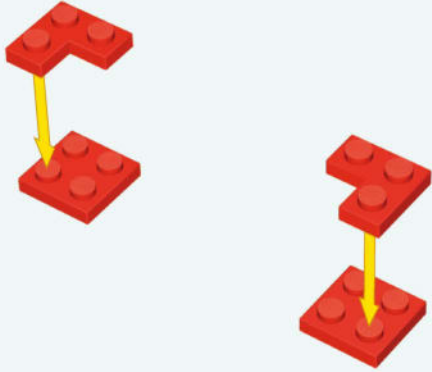

  
x2

  
x2

206

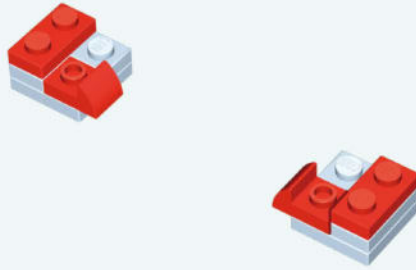

  
x2

  
x2

207

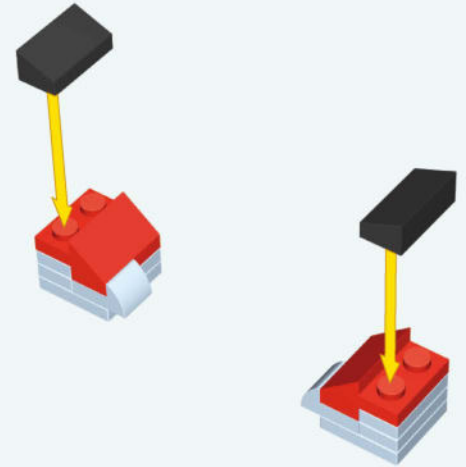

<sup>16</sup>  
  
x2

  
x2

208

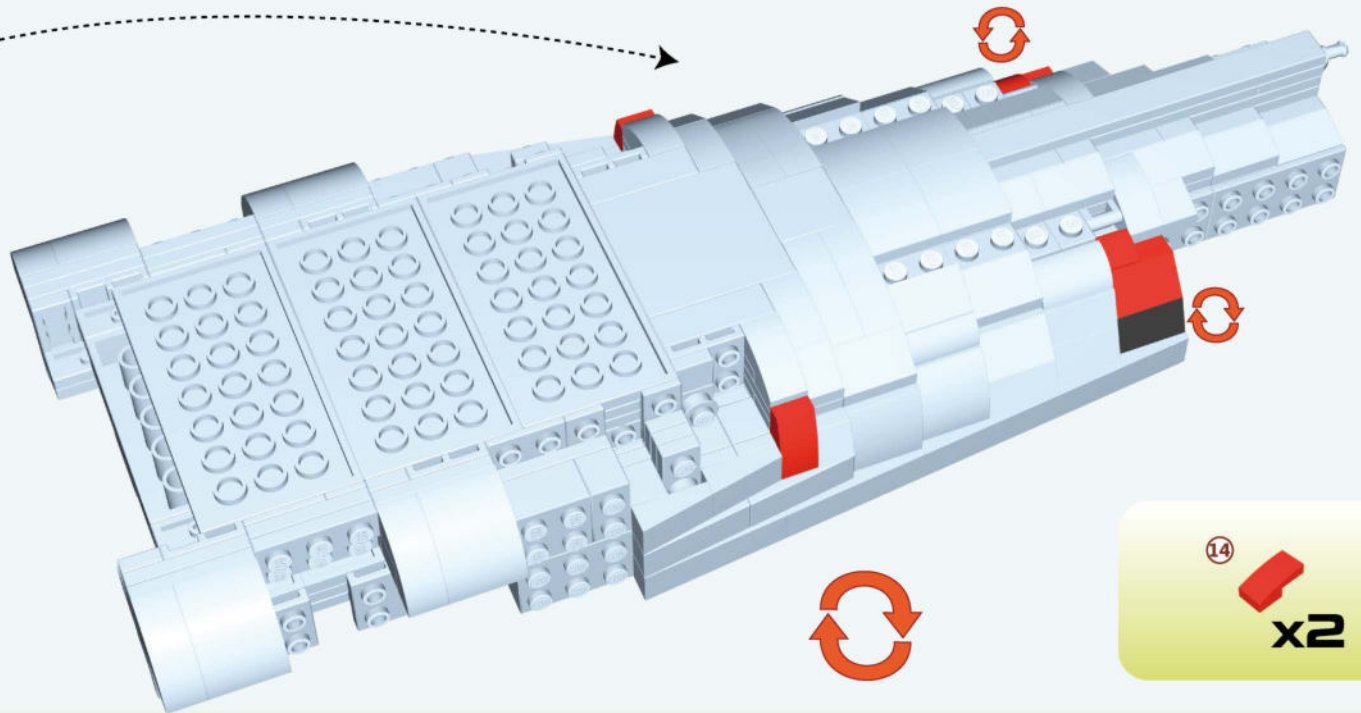
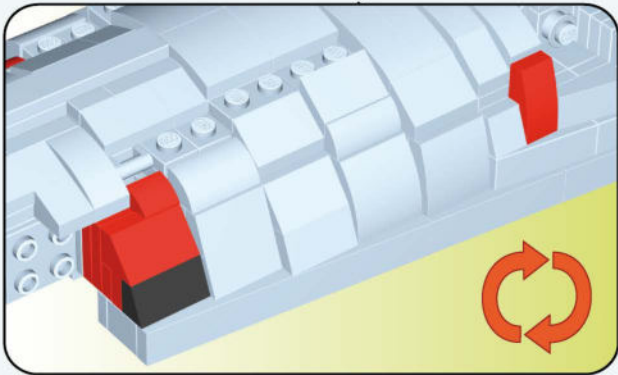

<sup>14</sup>  
  
x2



209

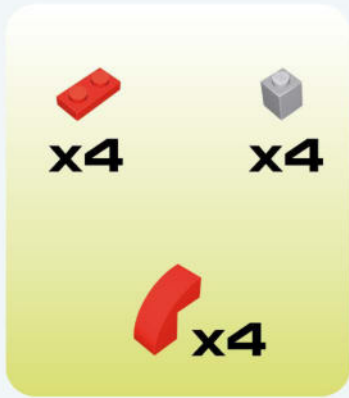
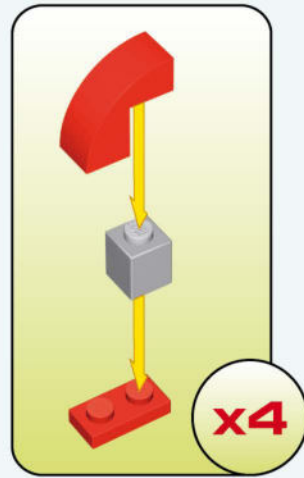
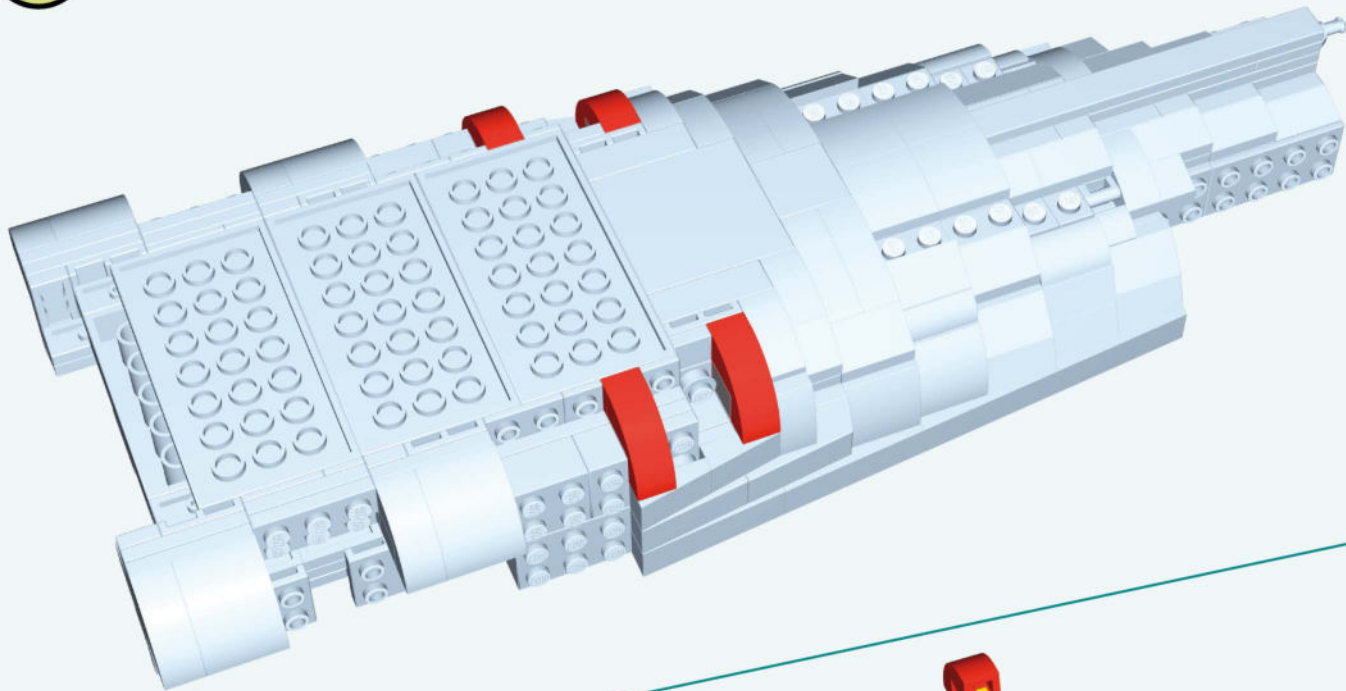

210

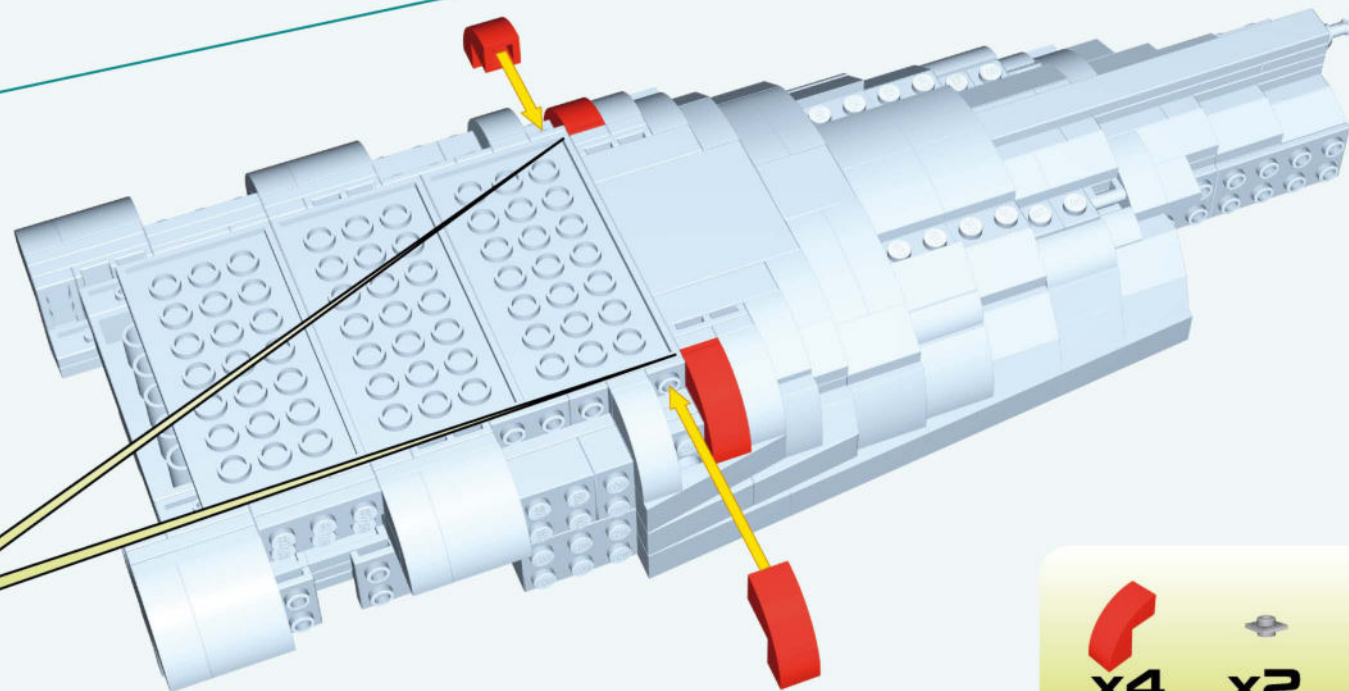
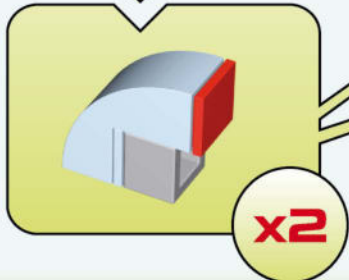
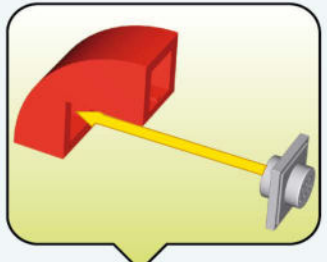

211

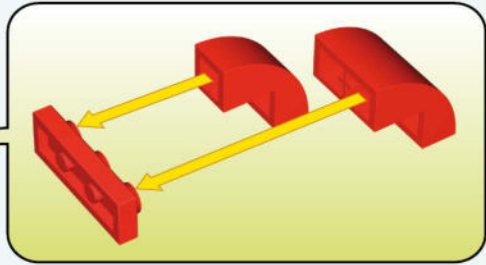
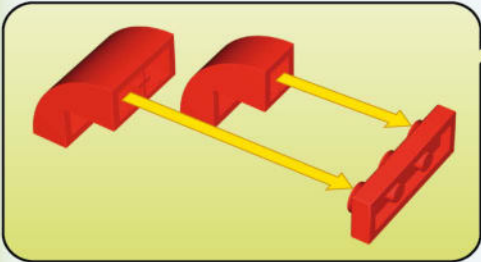
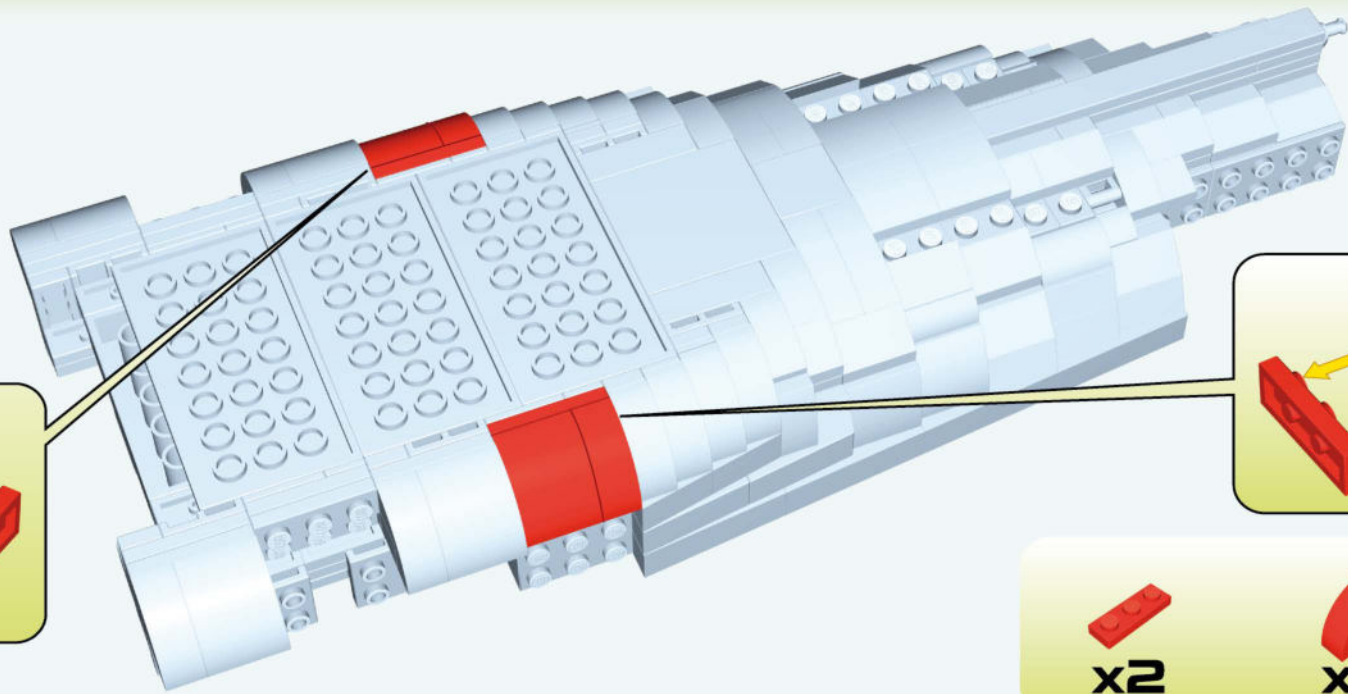

212

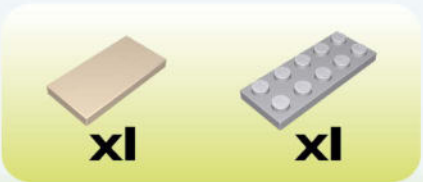
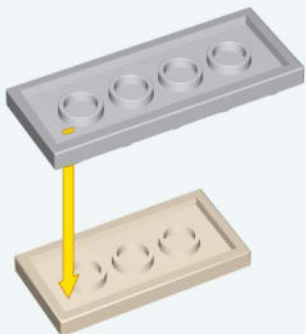

213

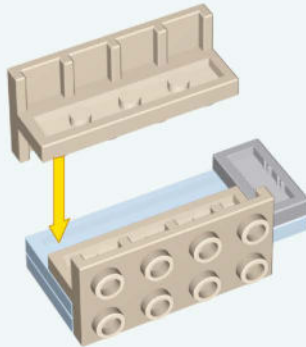

214

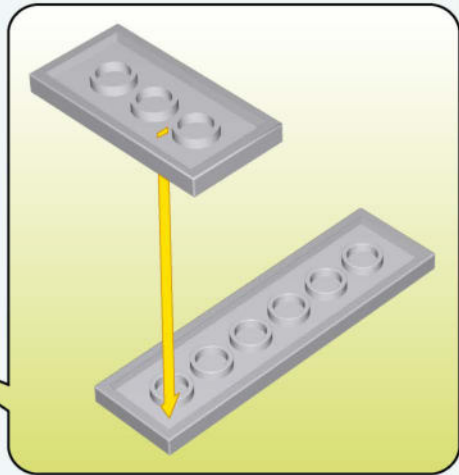
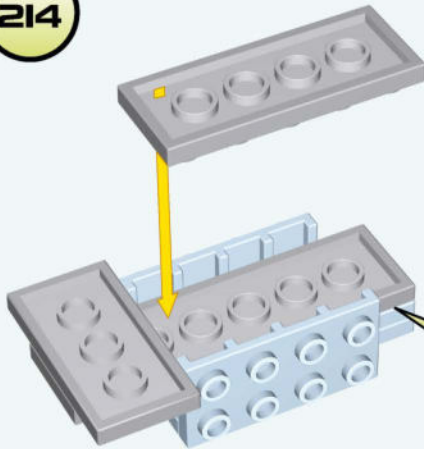

215

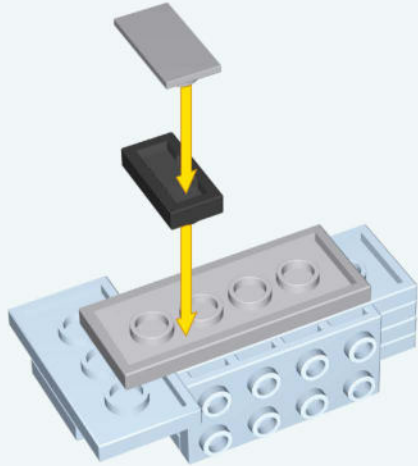

x1



x1



x1

216

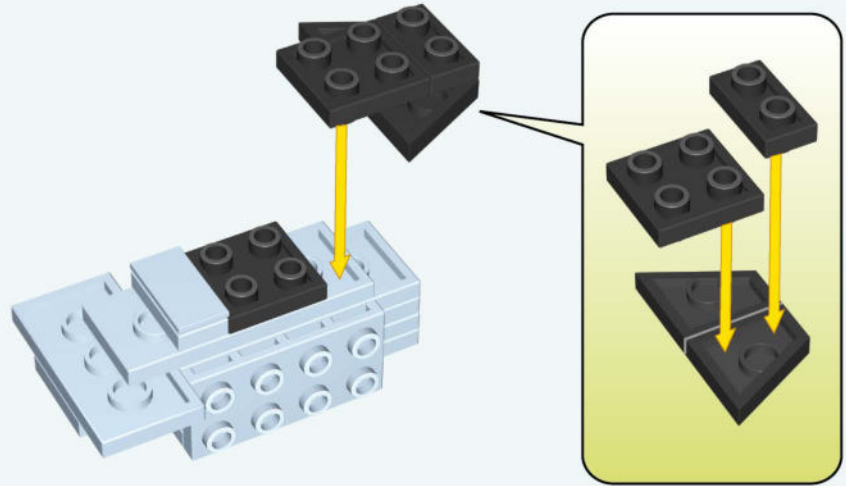

x2



x1



x1



x1

217

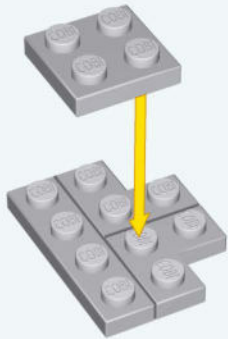

x1



x2



x1

218

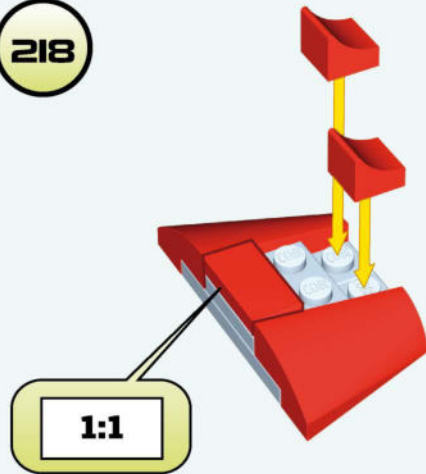

x1



x2



x1



x1

219

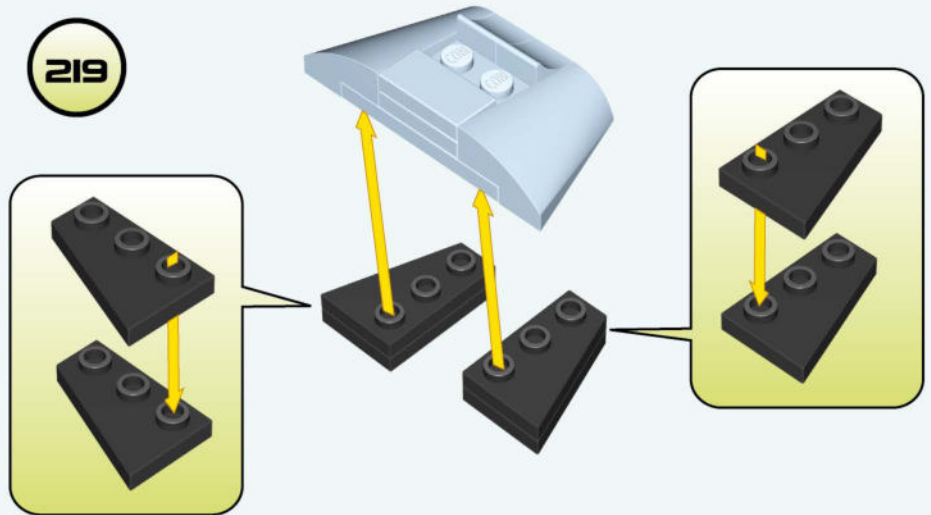

x2



x2



220

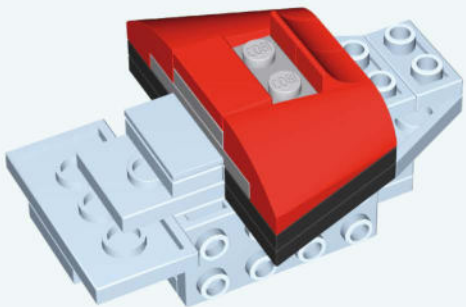

221

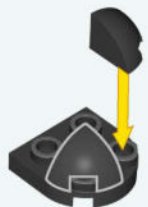

x1



x2

222



x1



x1

223

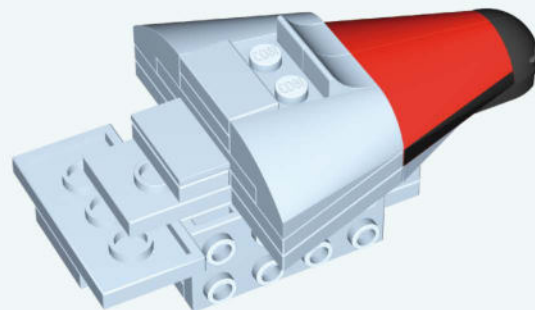

224

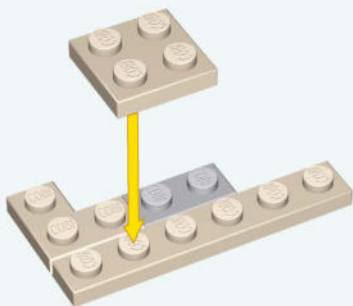

x1



x1



x1



x1

225

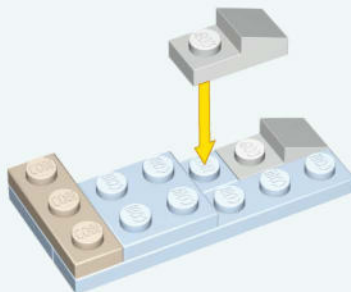

x1



x2

226



x1



x1



x1



x1

227

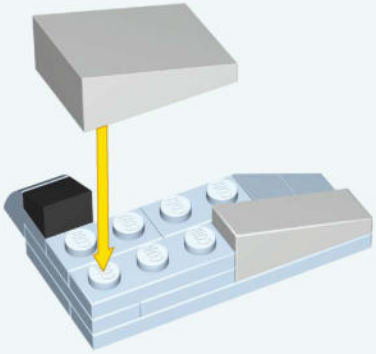

x1



x1



x1

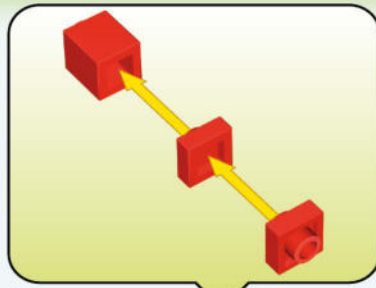

228

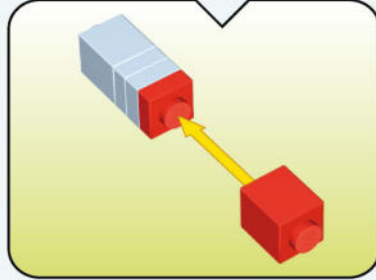
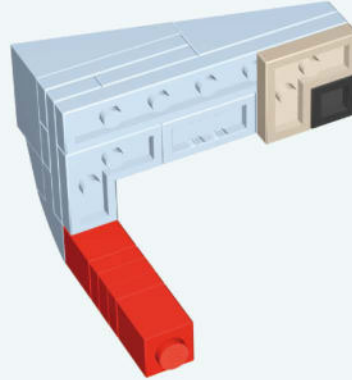

x2



x2



x1



x1



x1

229

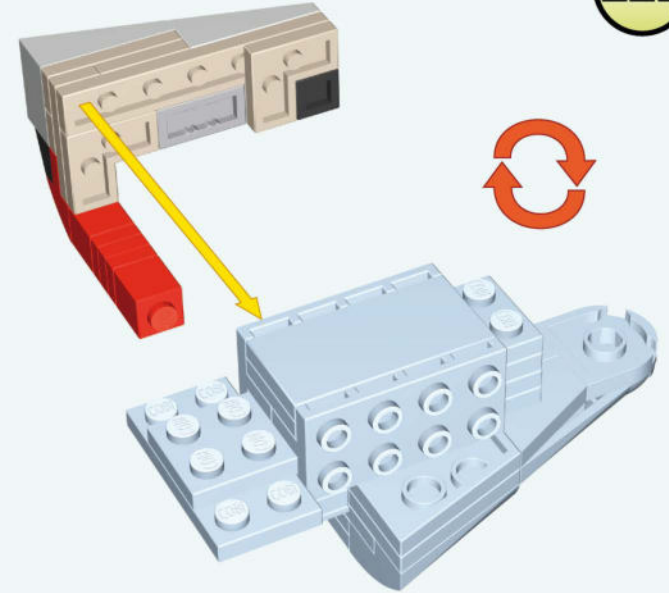

230

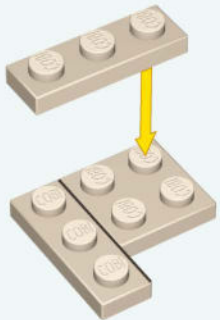

x2



x1

231

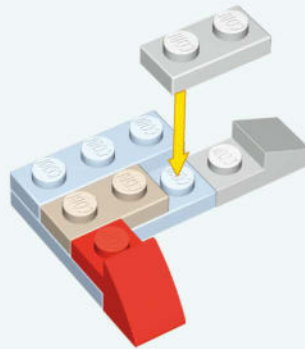

x1



x1



x1



x1

232

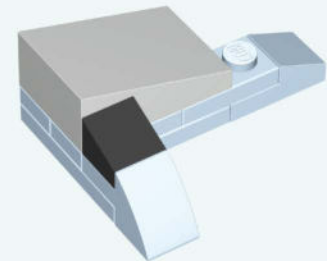

x1



x1

233

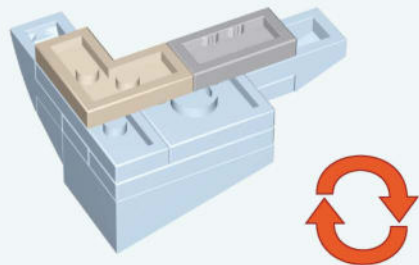

234

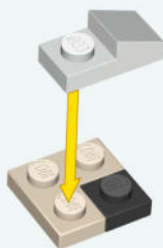

235

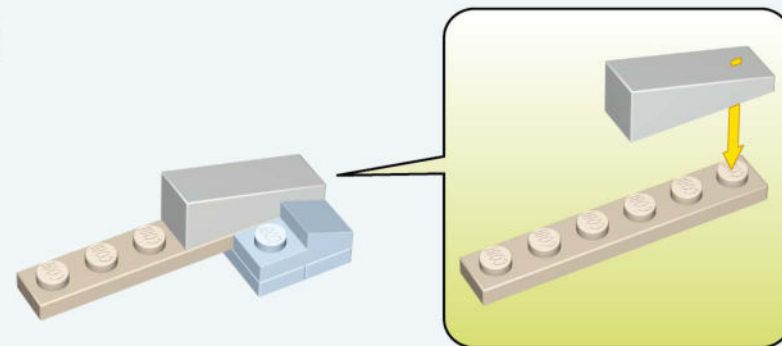

236

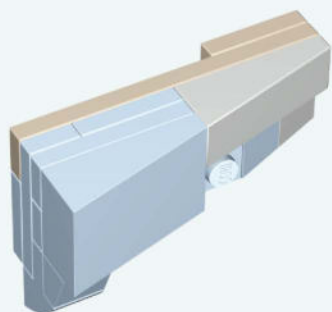

237

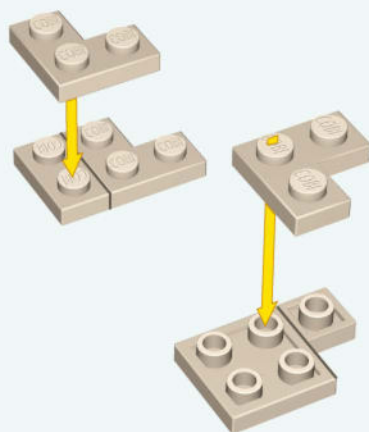

238

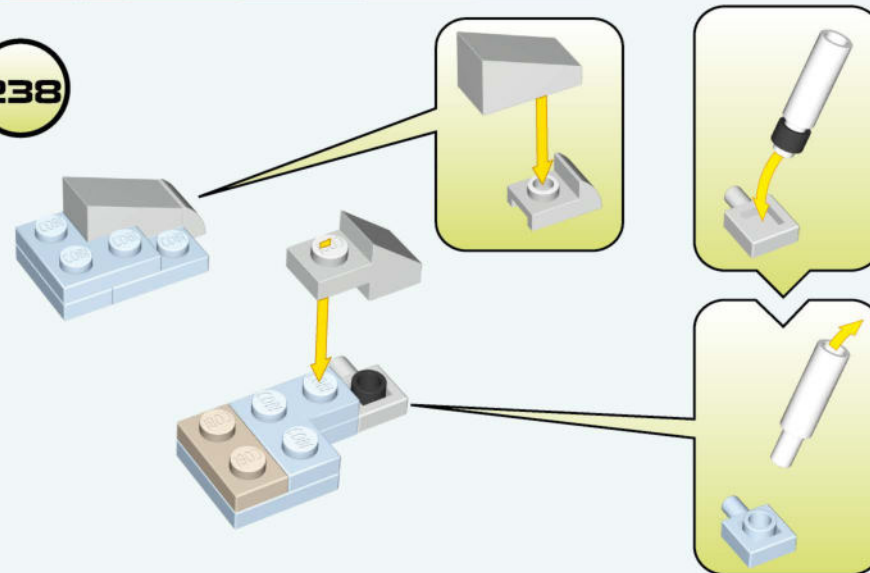



239

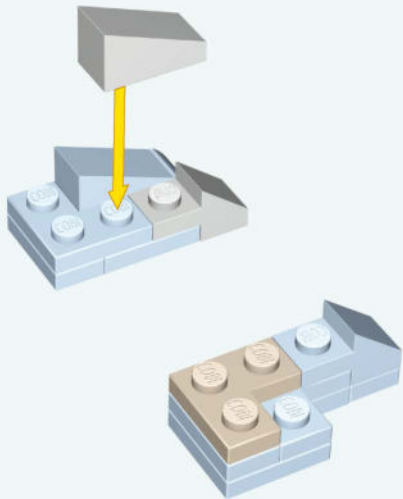

240

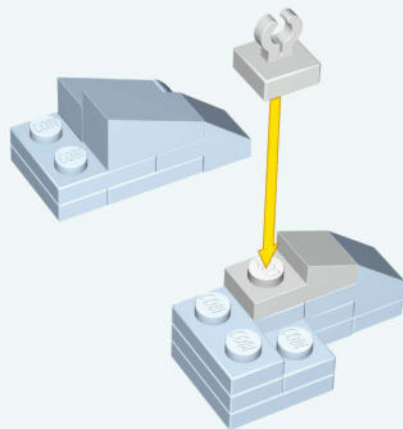

241

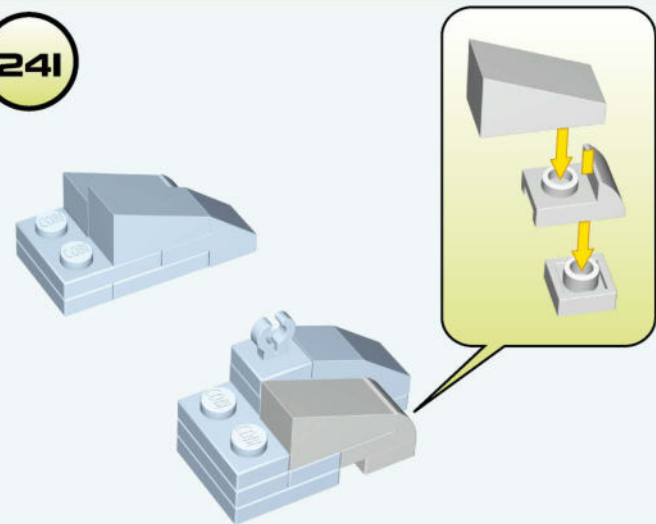

242

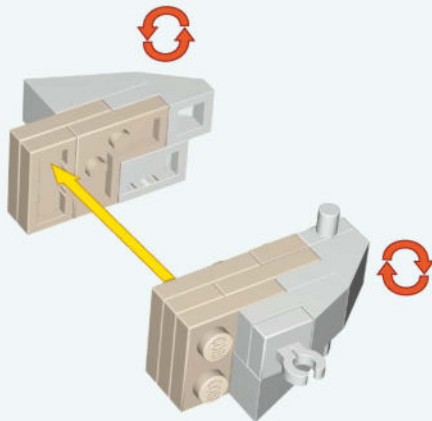

243

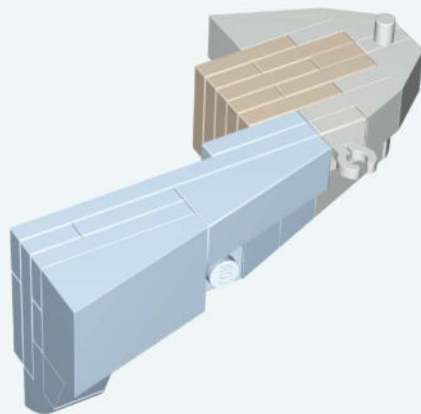

244

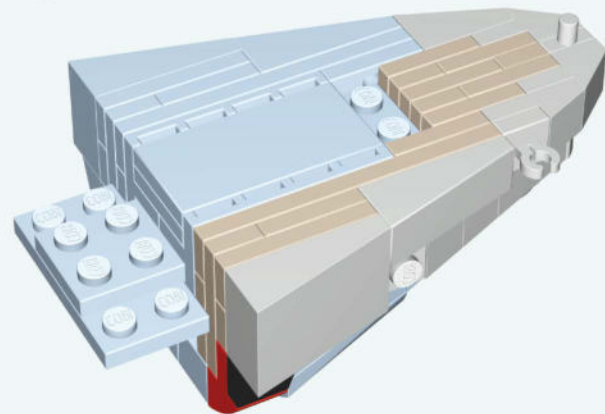

245

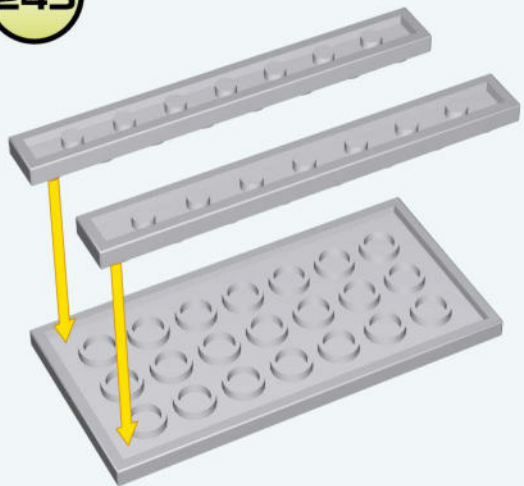

246

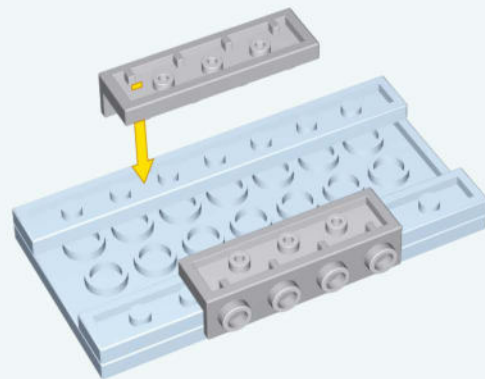

247

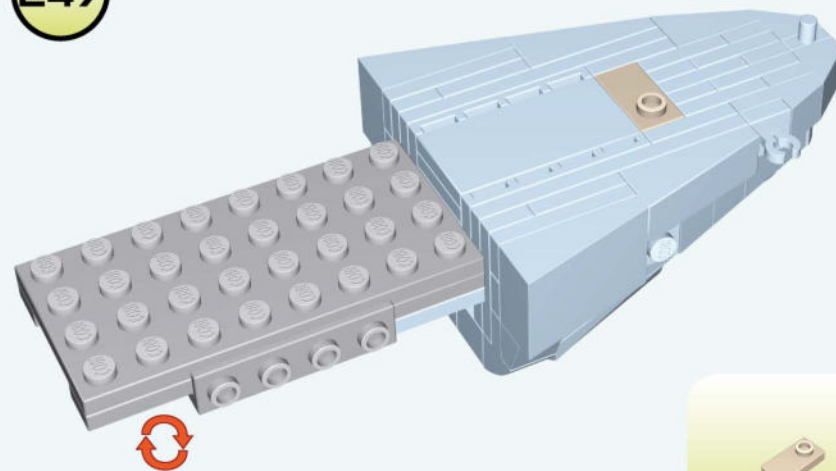

248

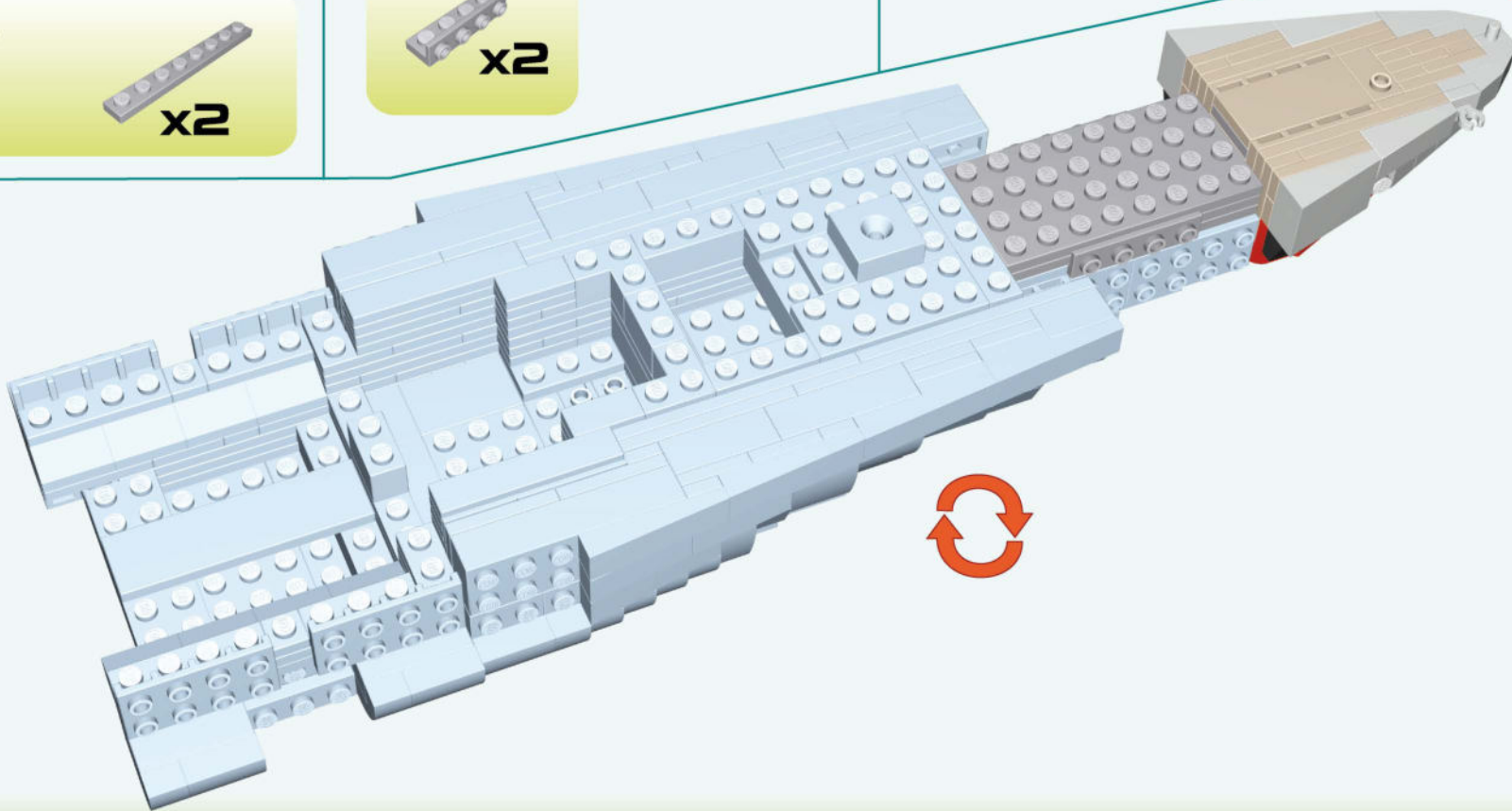

249

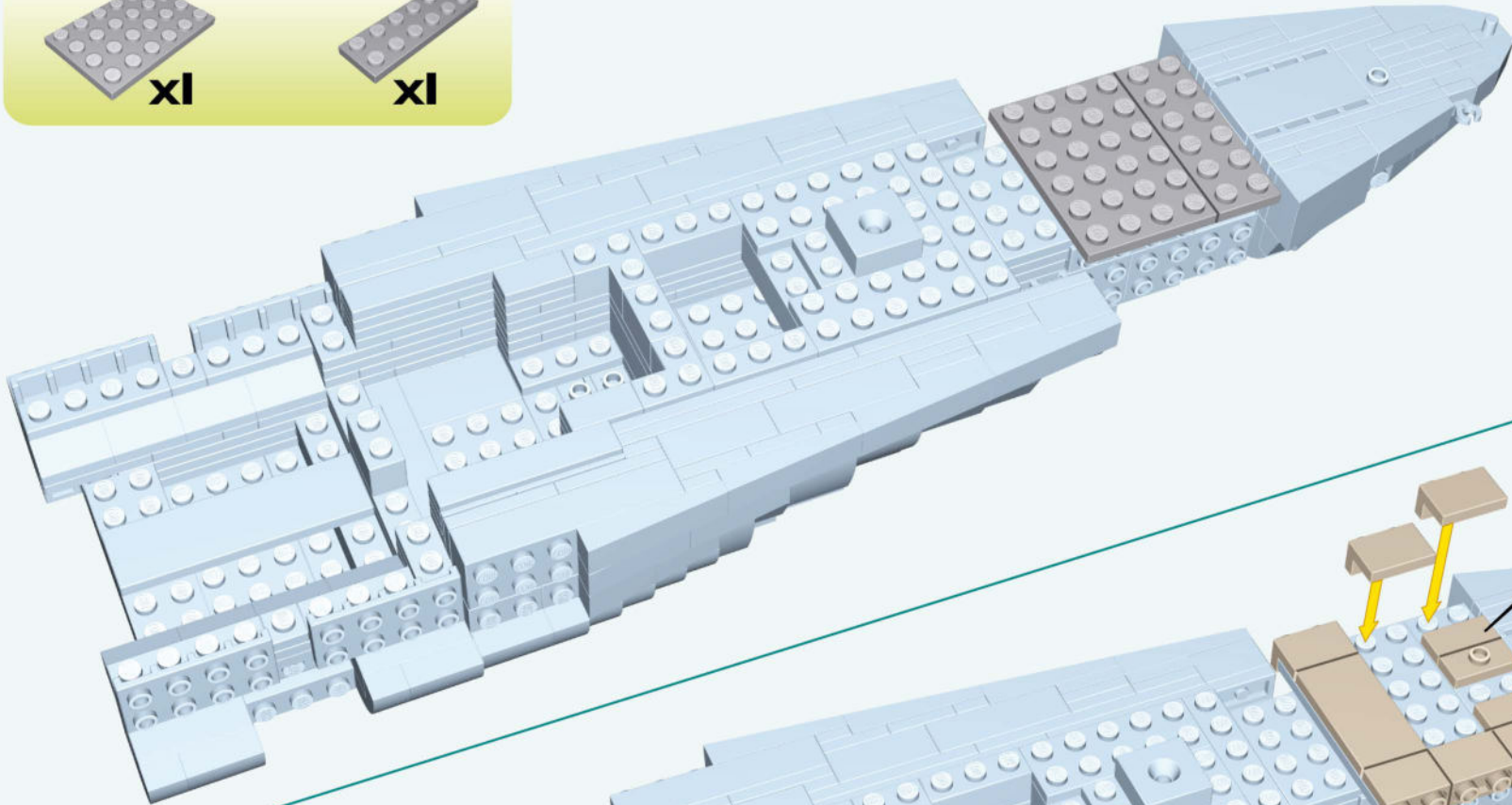

250

1:1

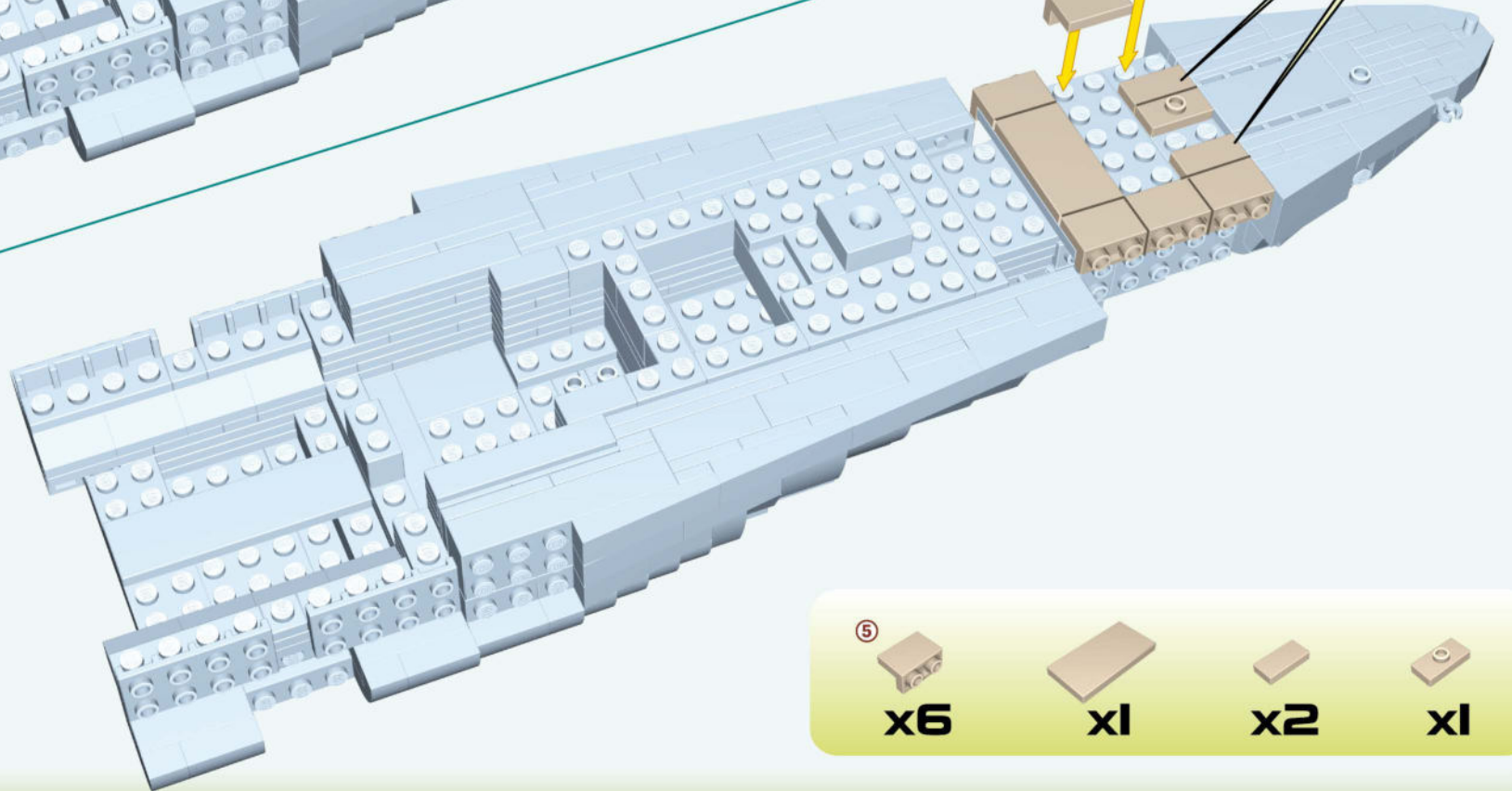



251

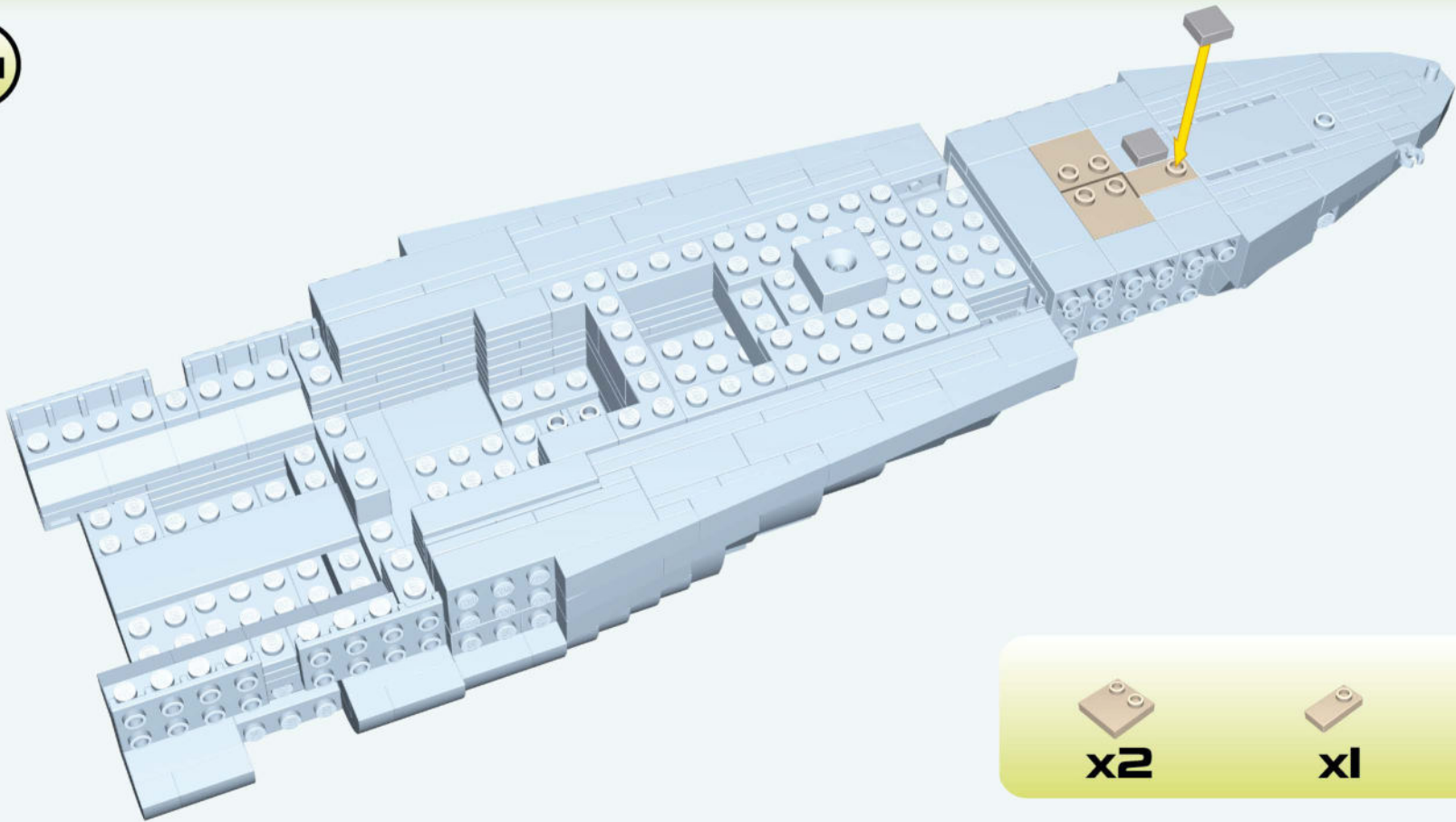

  
x2

  
x1

  
x2

252

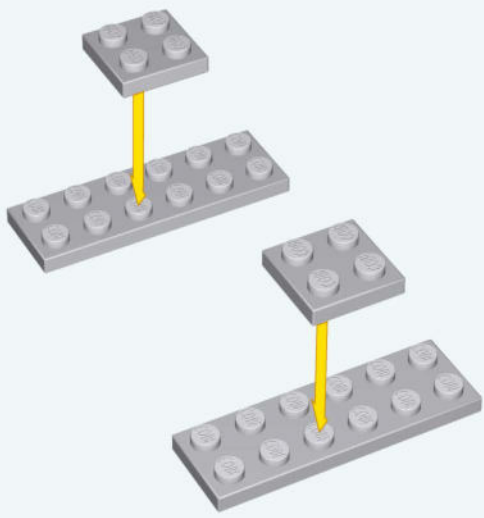

  
x2

  
x2

253

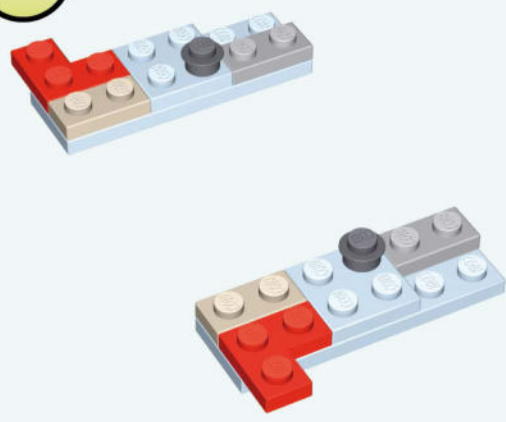

  
x2

  
x2

  
x2

  
x2

254

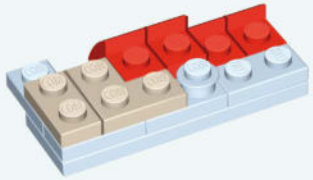

x2



x2



x8

255

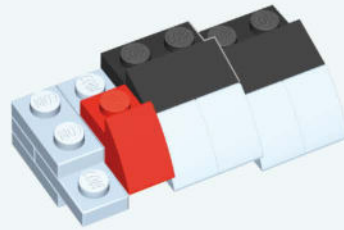

x2



x4

256

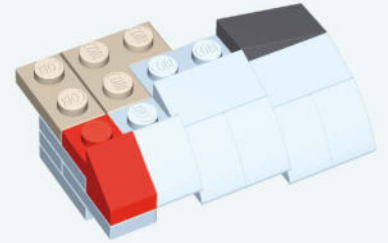

x2



x2



x2



x2

257

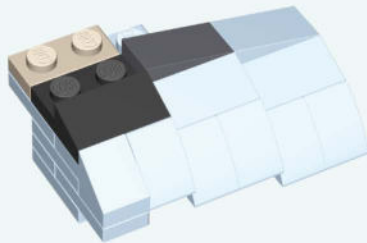
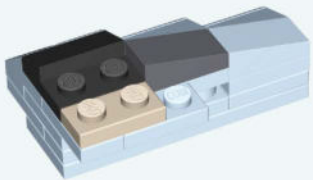

x2



x2



x2

258

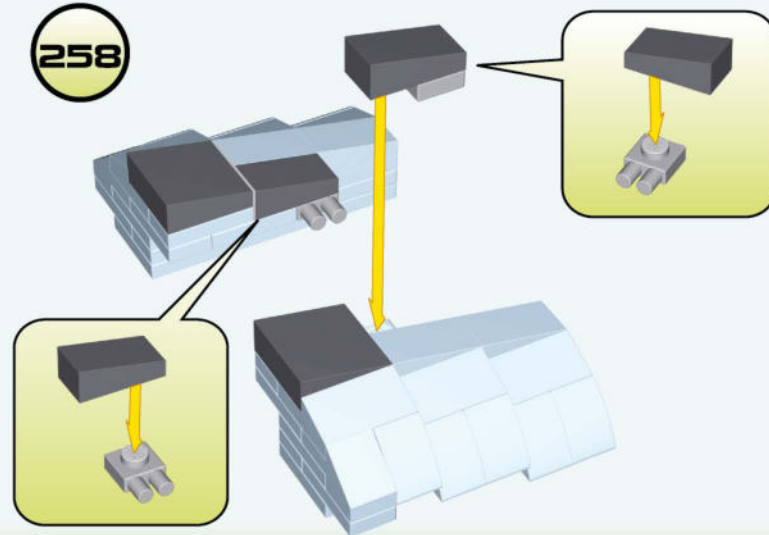

x2



x2



x2

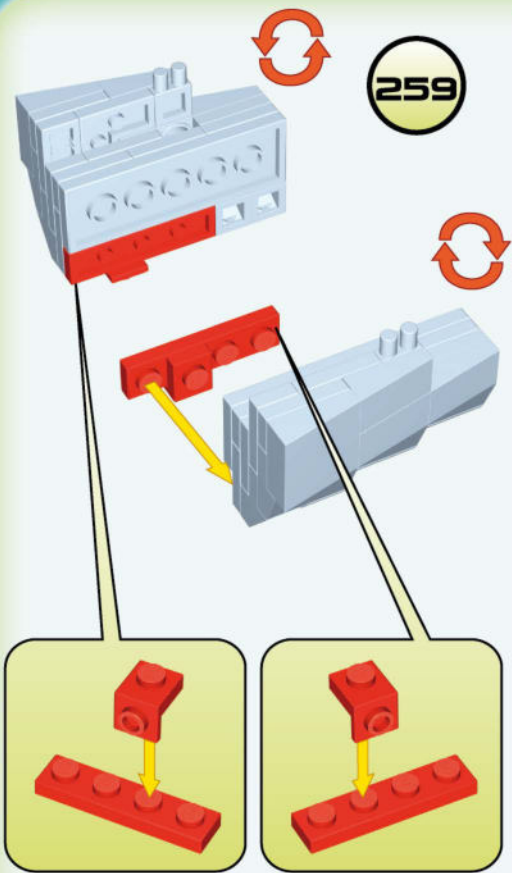

259

x4      x2

260

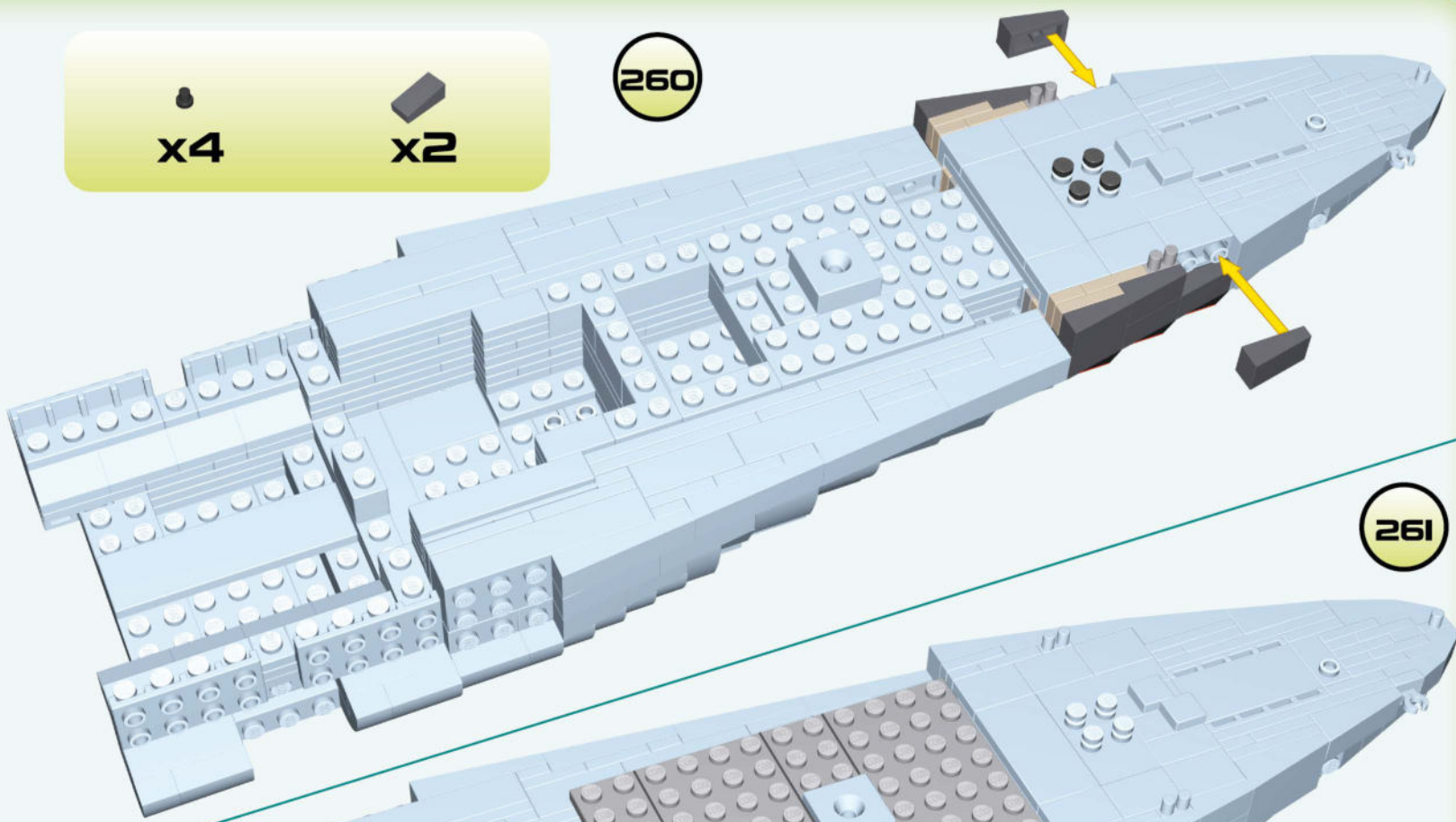

261

x2      x2

x1      x2  
x2



6

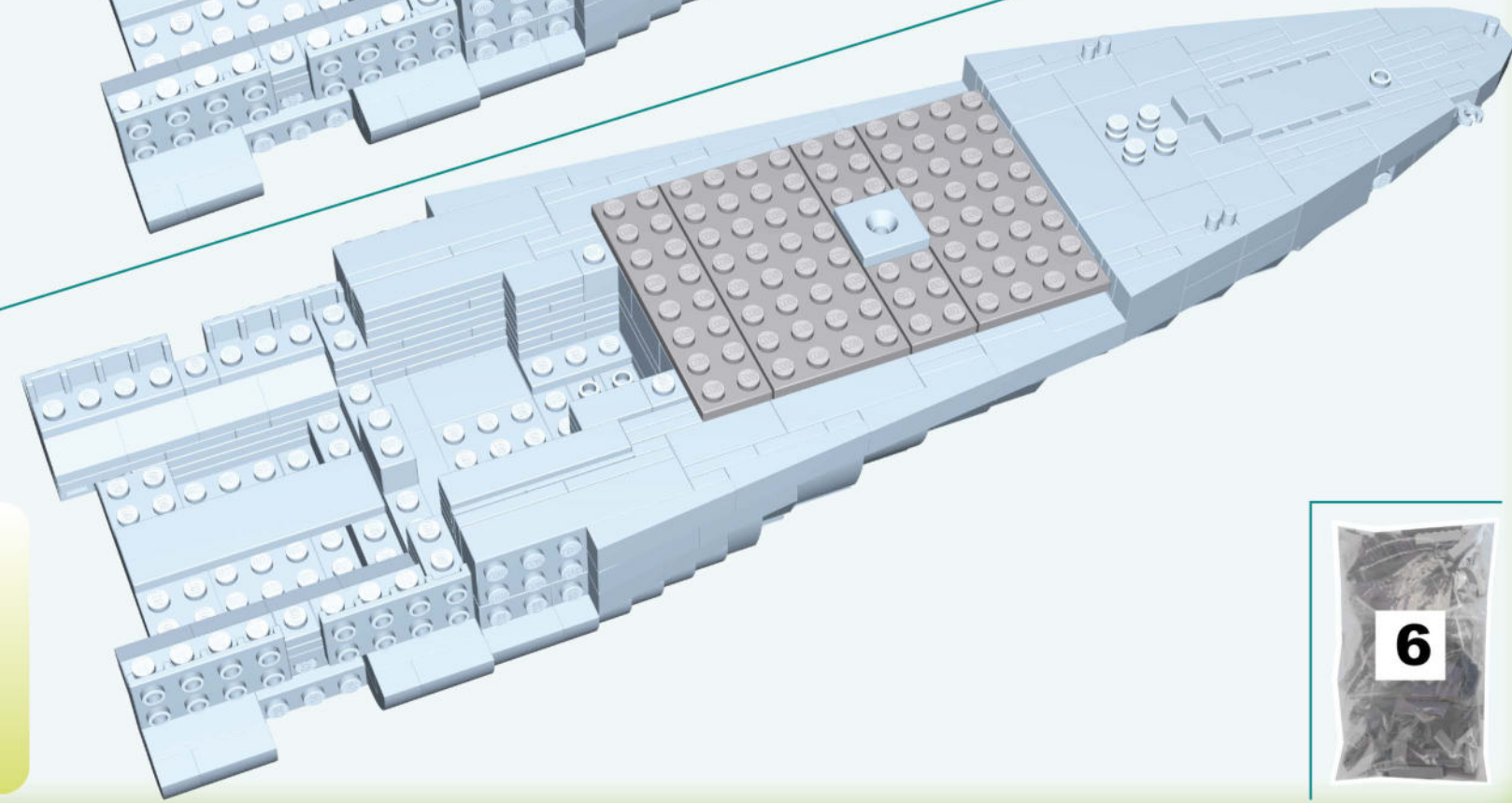

261



262

 x2  
 x2  
 <sup>5</sup> x8

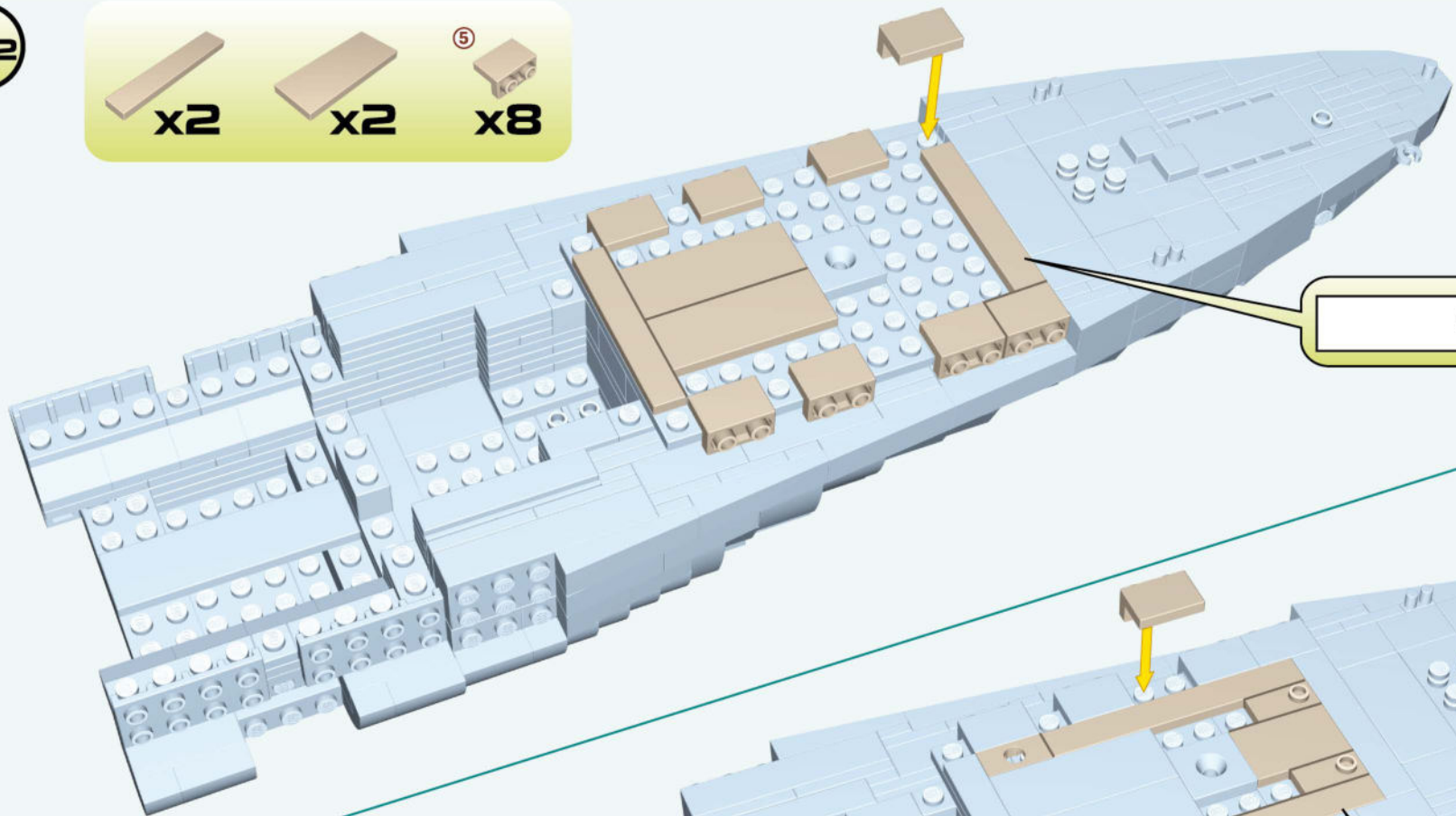

263

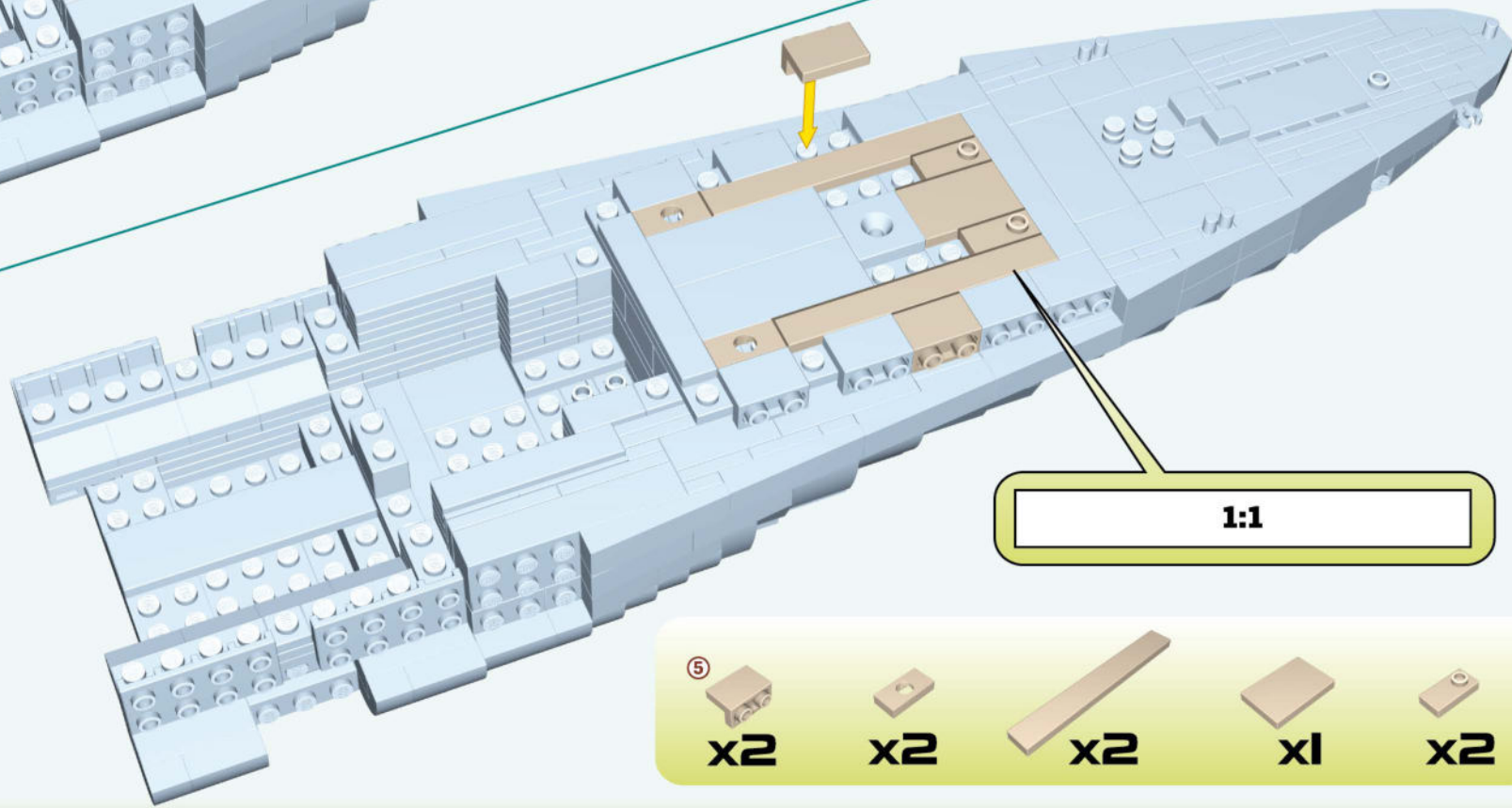

 <sup>5</sup> x2  
 x2  
 x2  
 x1  
 x2

264

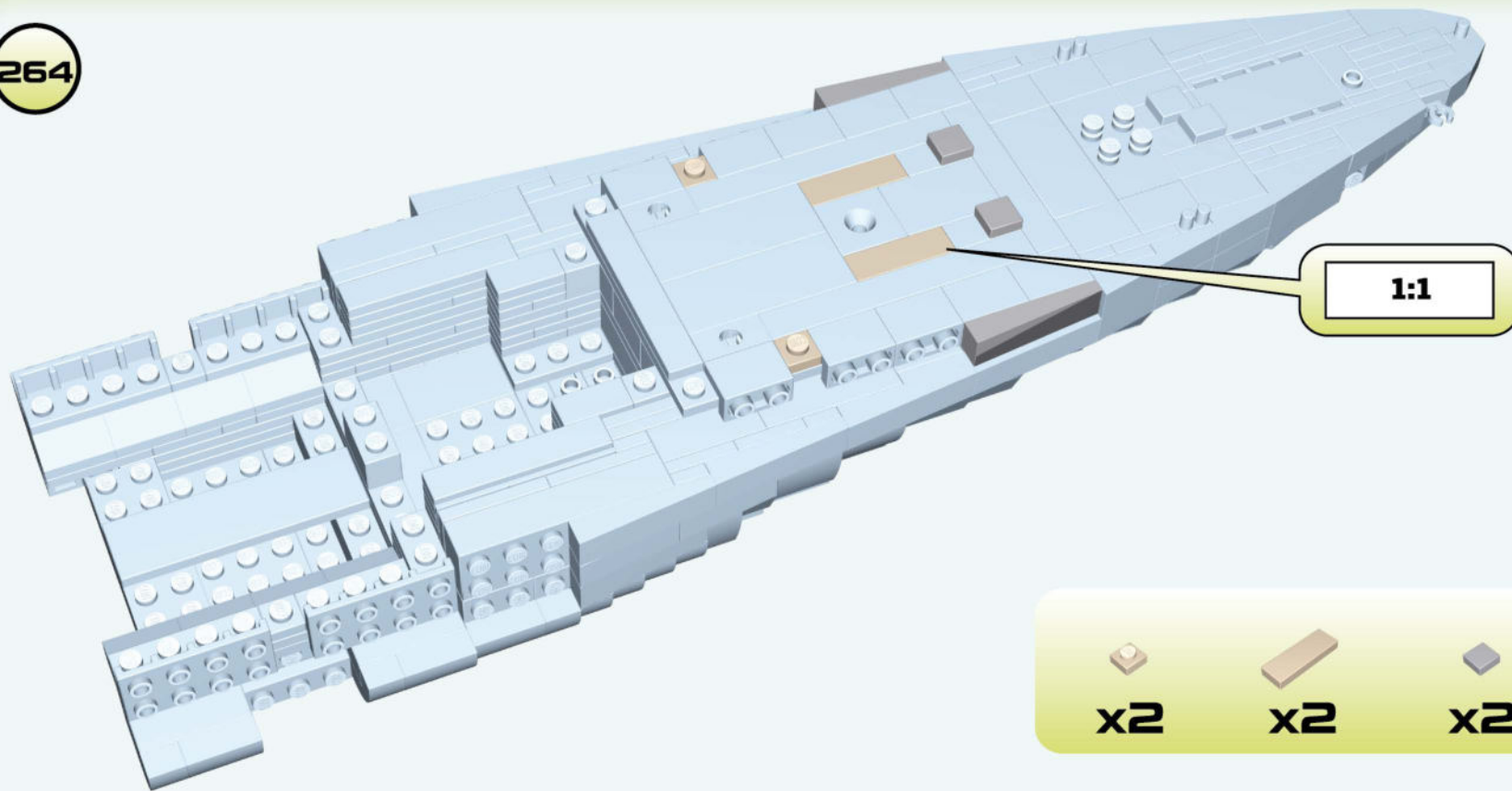

-   
**x2**
-   
**x2**
-   
**x2**
-   
**x1**
-   
**x1**



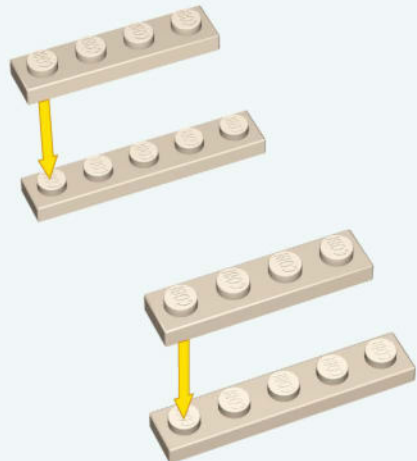

265

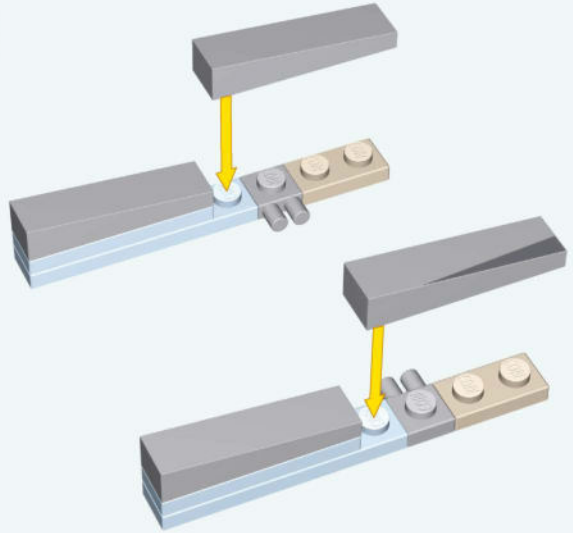

-   
**x2**
-   
**x2**

266



-   
**x2**
-   
**x2**
-   
**x3**
-   
**x1**

267

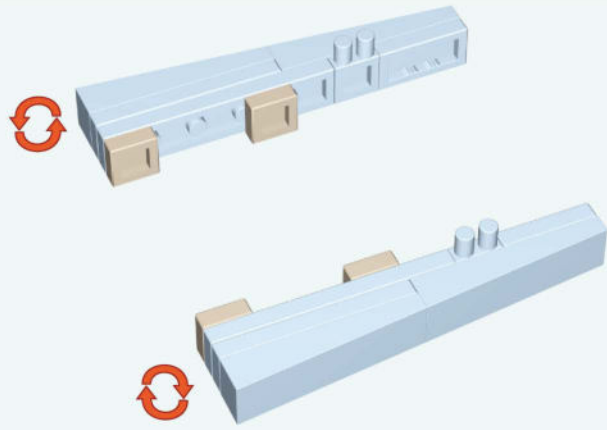

  
**x4**

268

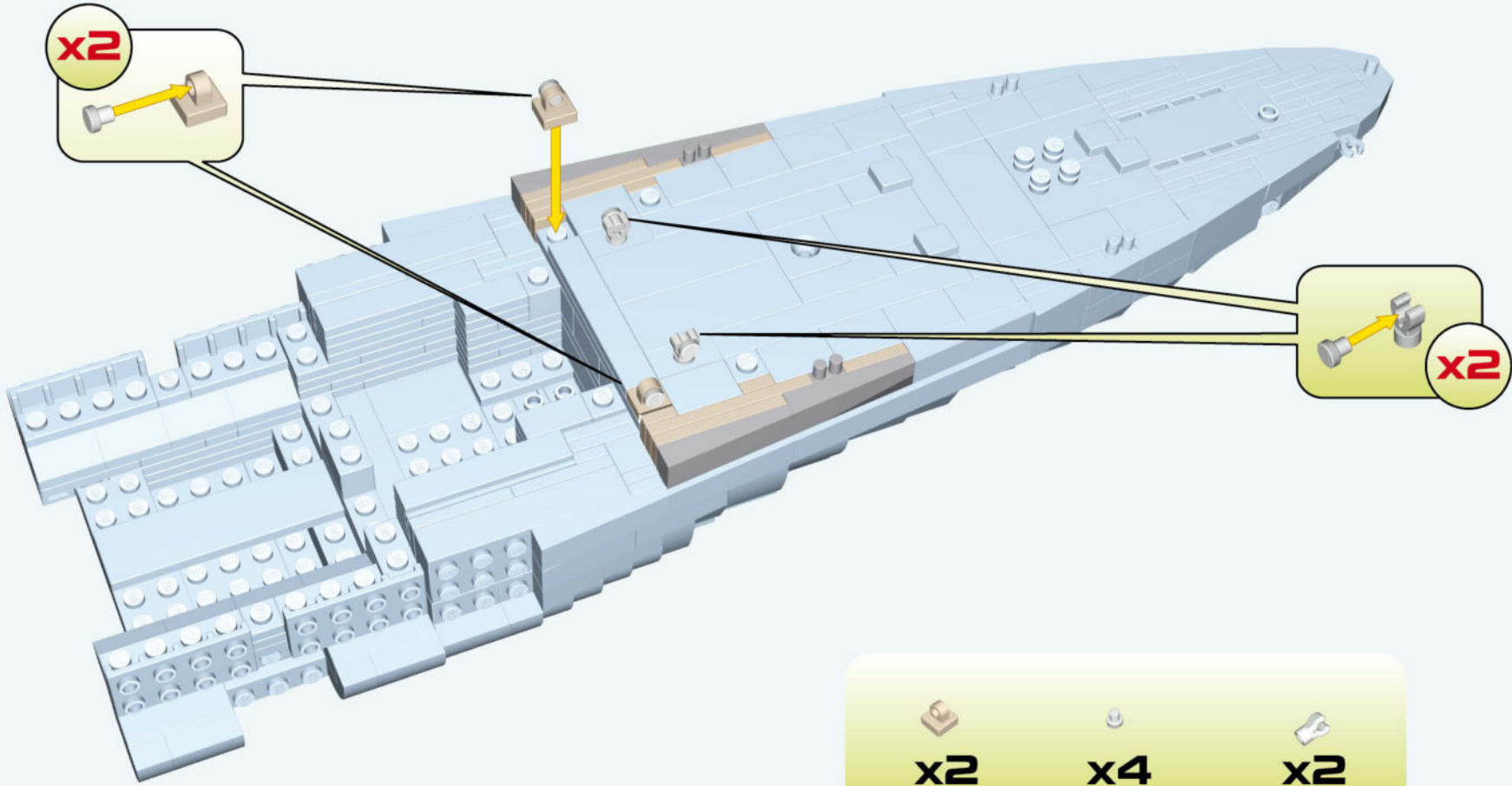

  
**x2**        
**x4**        
**x2**