

HISTORICAL COLLECTION

WORLD WAR II



**EXECUTIVE
EDITION**



P-47 THUNDERBOLT™

IN SERVICE - 1942 - EARLY 50s
 PLACE OF ORIGIN - UNITED STATES
 ROLE - FIGHTER
 WINGSPAN - 12,5m (41')
 LENGTH - 11m (36')
 HEIGHT - 4,5m (14' 8")
 EMPTY WEIGHT - 4540kg (10,000LB)
 ENGINE - PRATT&WHITNEY R-2800-59,
 2000HP (1500kW)
 RANGE - ~1300KM (800mi)
 RATE OF CLIMB - 15m/s (3200FT/MIN)
 MAXIMUM SPEED - 700KM/H (433MPH)
 MAXIMUM FLIGHT LEVEL - 13km (42,000FT)
 ARMAMENT - 8x 12,7mm (.50") BROWNING M2
 EQUIPMENT - EXTERNAL FUEL TANK
 CREW - 1

TANK TRAILER

CAPACITY - 250GAL (1136L)
 LENGTH - 3,4m (136')
 WIDTH - 1,8m (71")
 EMPTY WEIGHT - 680KG (1500LB)



5736

**NORTHROP
GRUMMAN**

P-47 Thunderbolt™ is a trademark of Northrop Grumman Systems Corporation and are used under license by COBI.

**PAD PRINTED
NO STICKERS**

Printed in EU



WARNING: CHOKING HAZARD-
 Toy contains small parts.
 Not for children under 3 years.

567 2

P-47 THUNDERBOLT™ & TANK TRAILER

SCALE 1:32



1

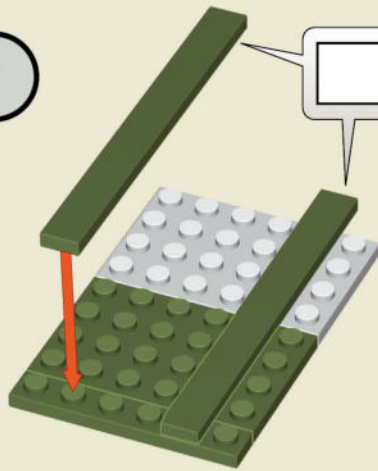

1:1

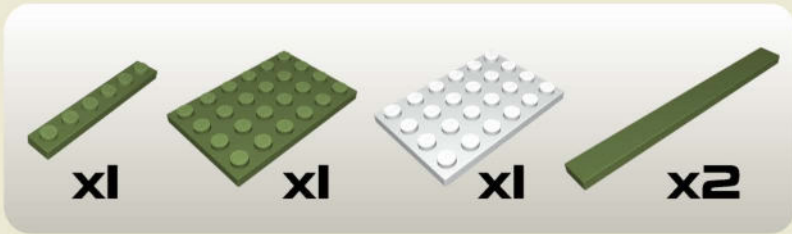

2

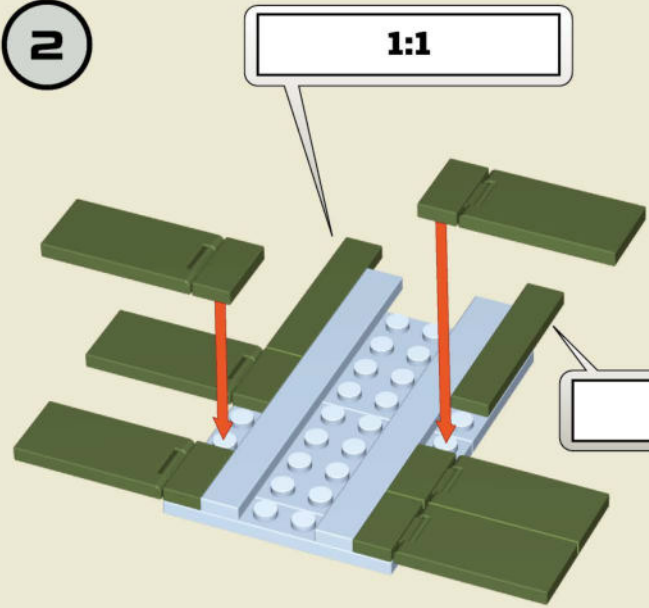

1:1

1:1

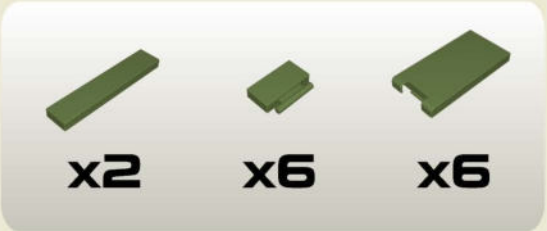
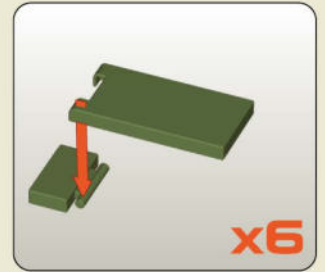

3

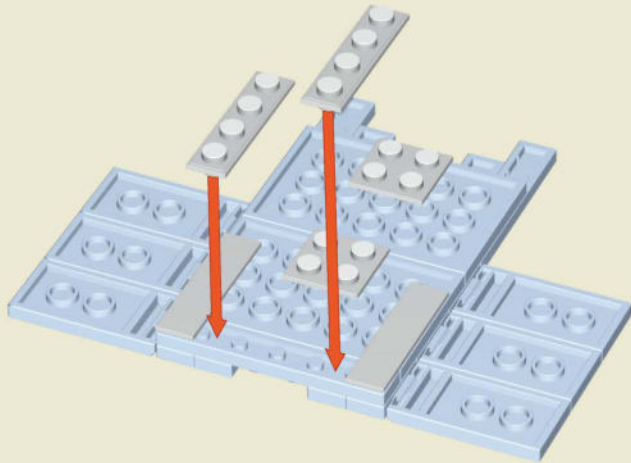

4

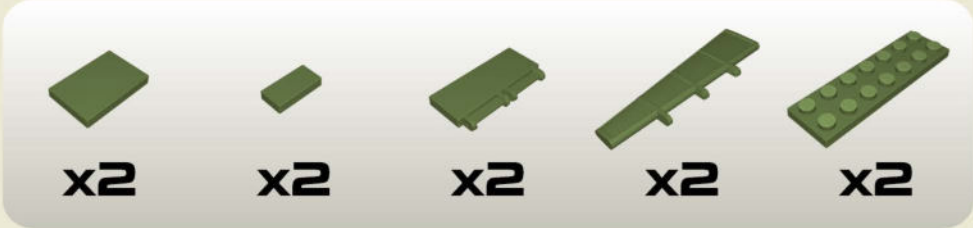
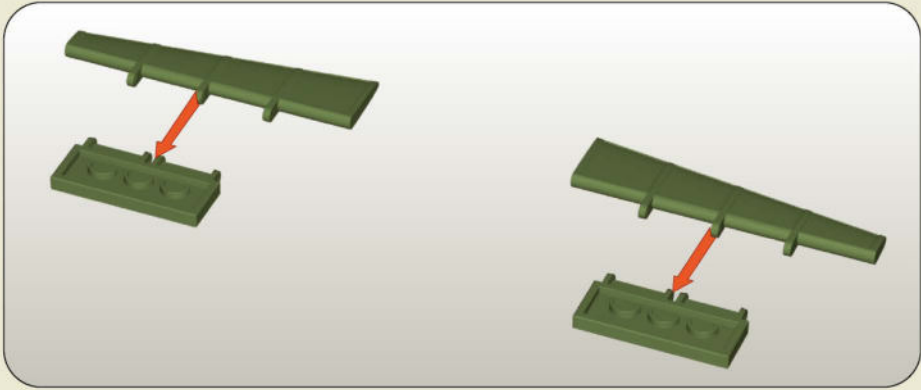
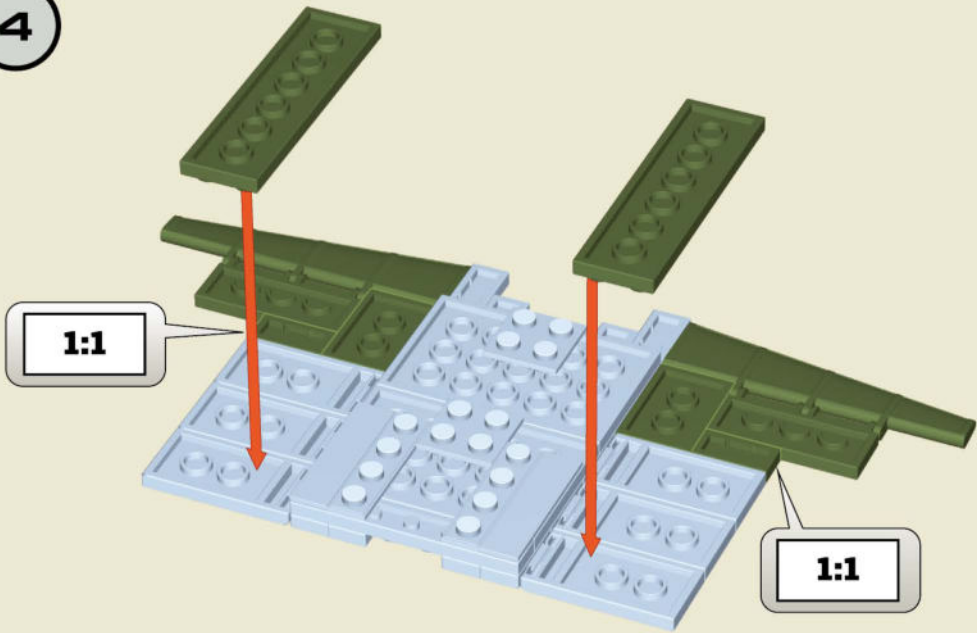

5

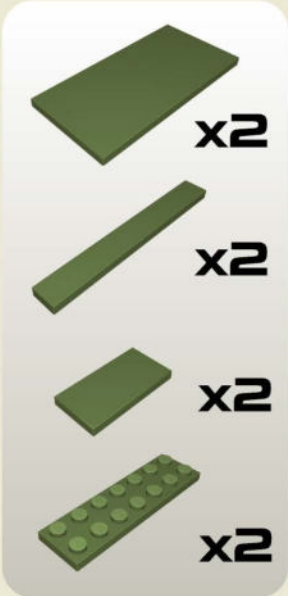
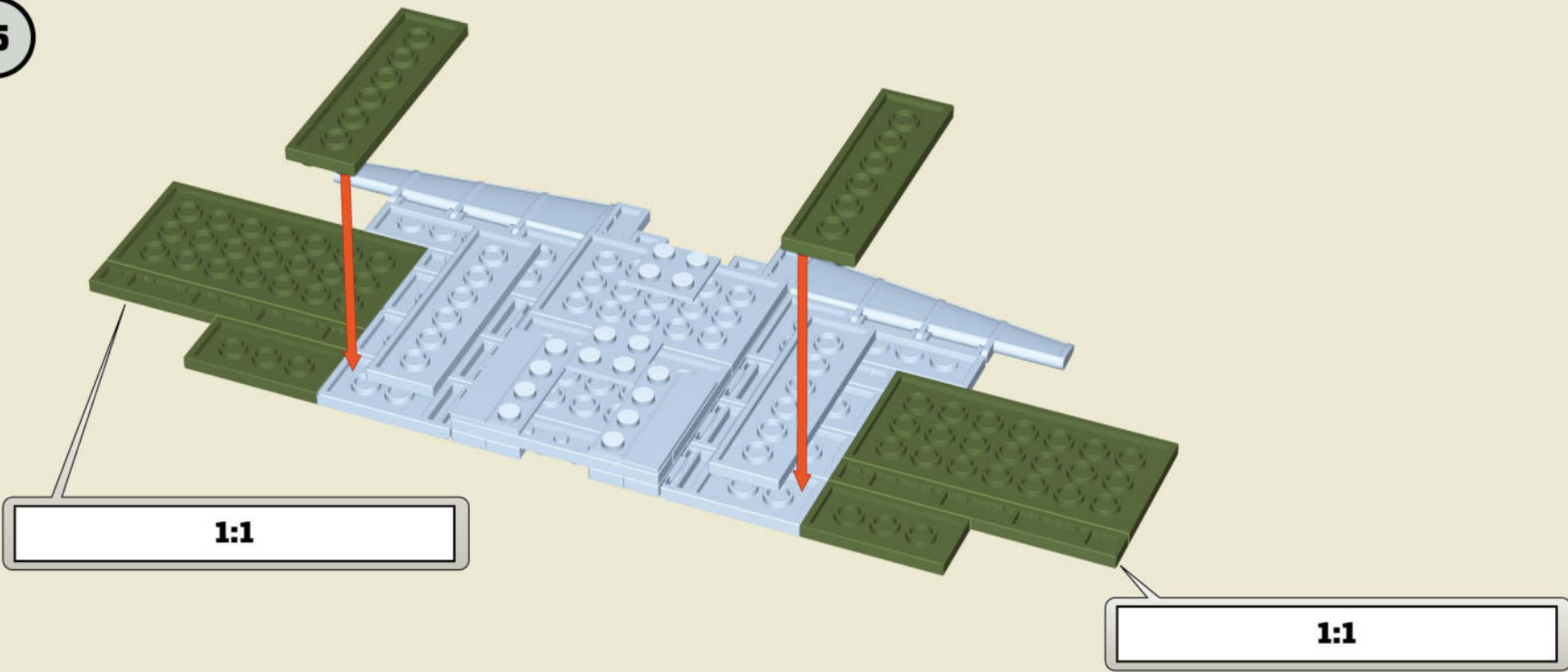

6

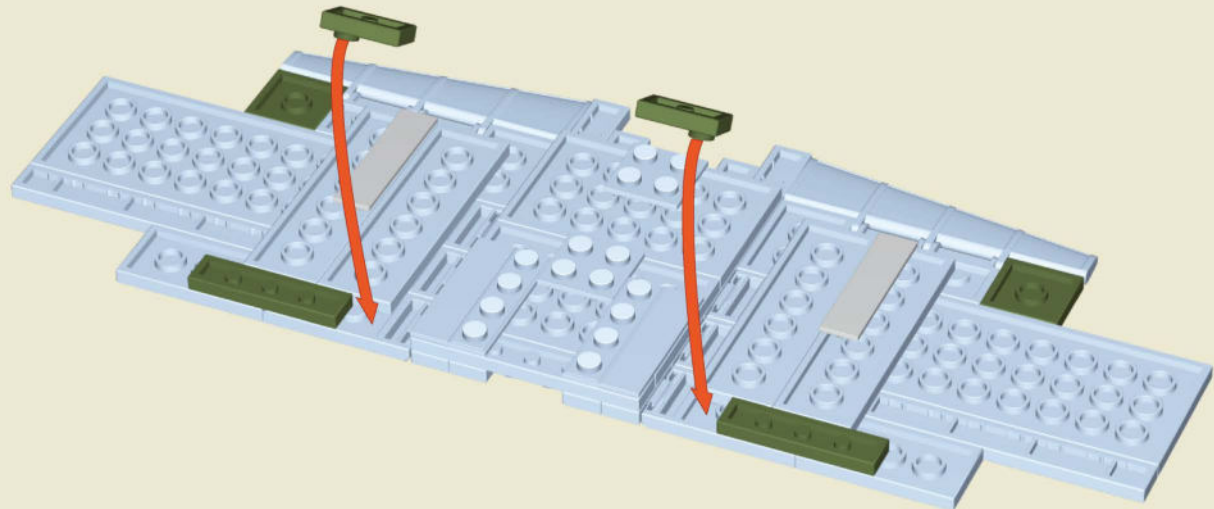

-  x2
-  x2
-  x2
-  x2

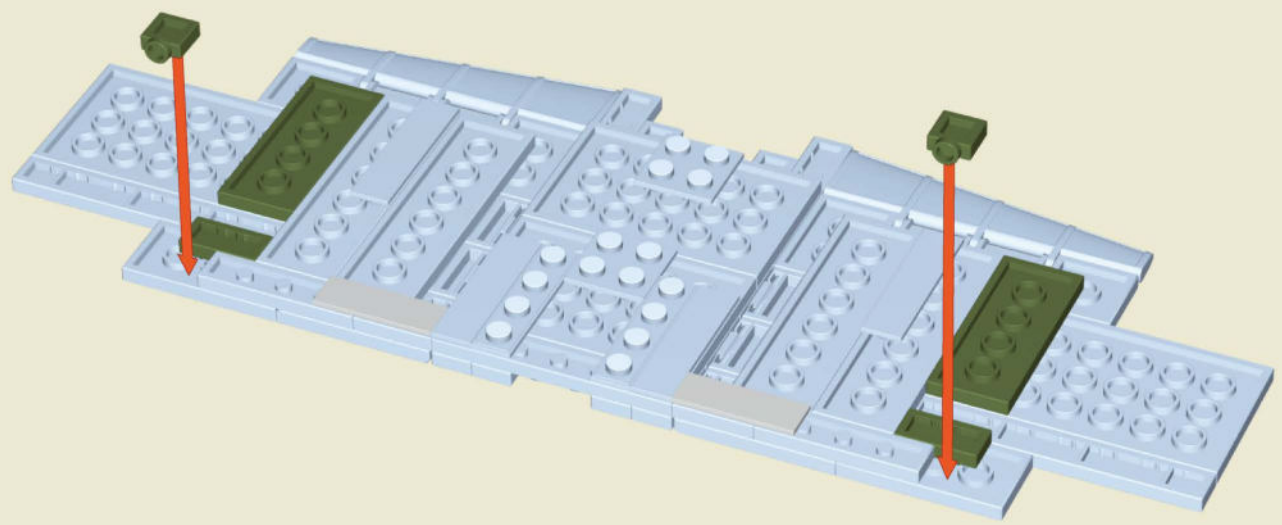

7



-  x2
-  x2
-  x2
-  x2

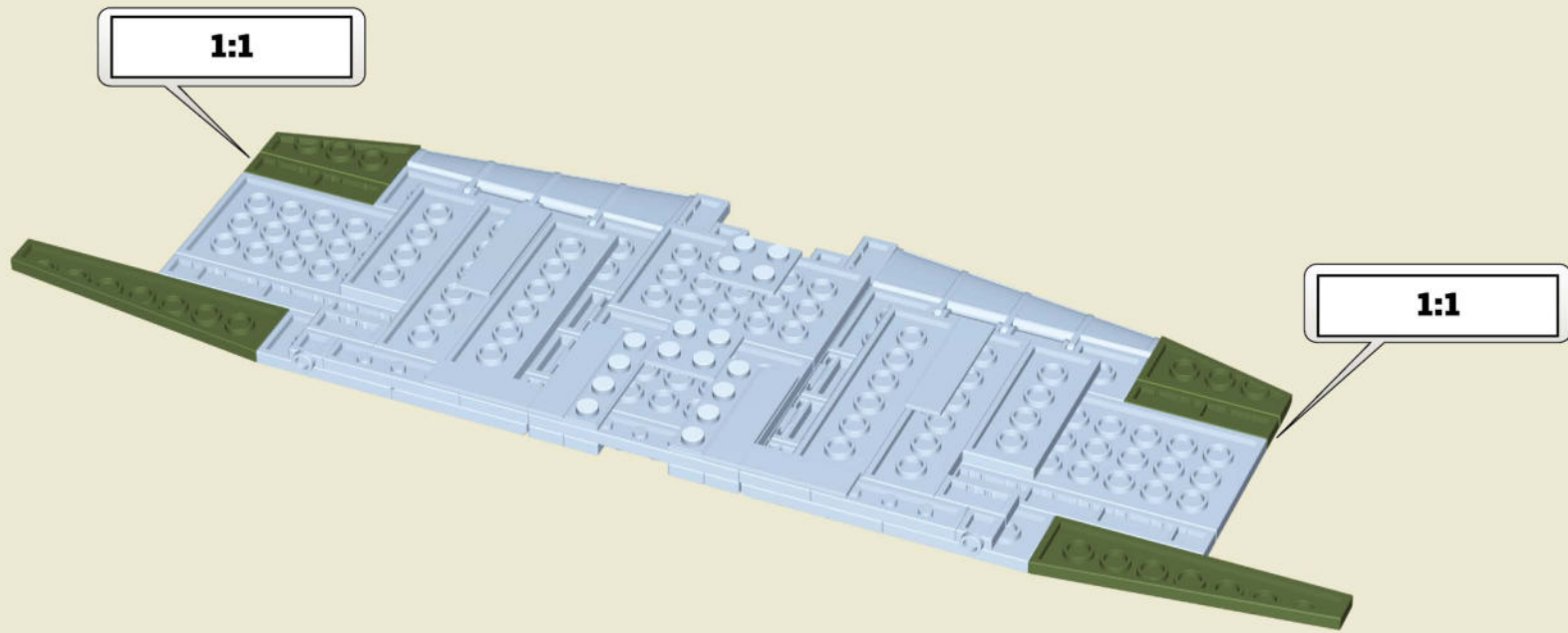

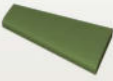

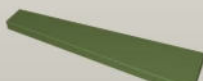
8

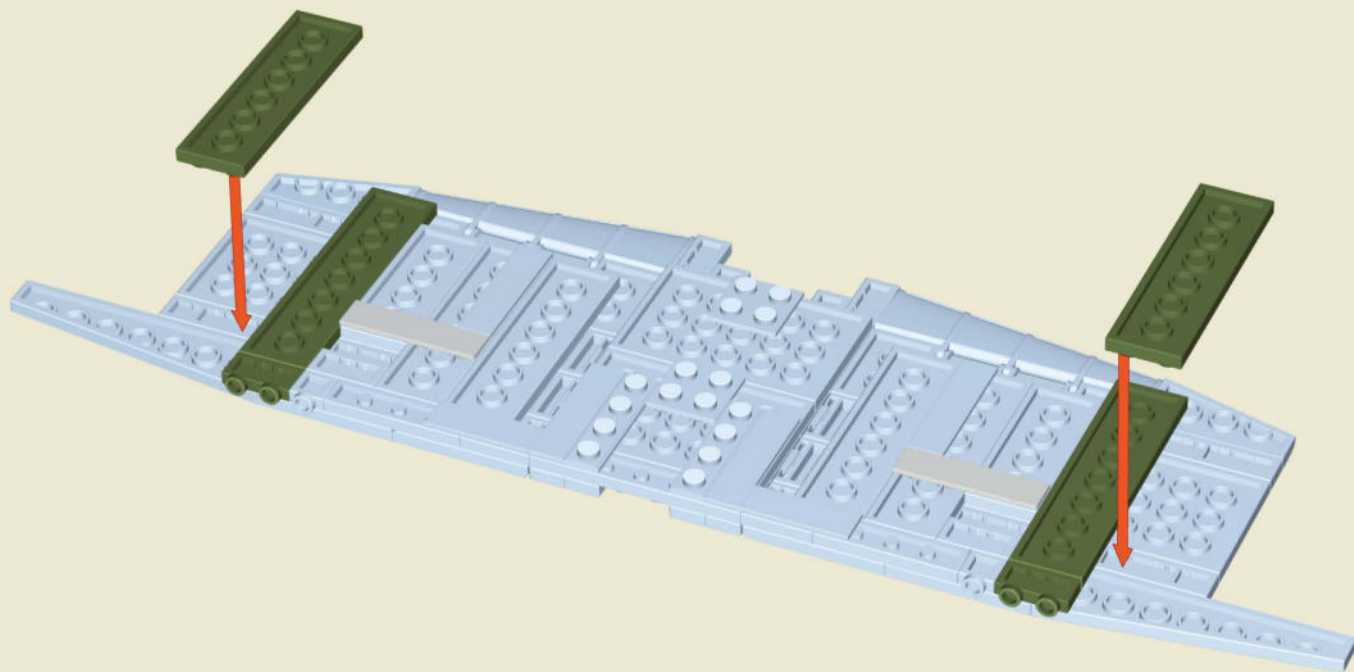

-  x1
-  x1
-  x2
-  x1
-  x1

9



-  x2
-  x2
-  x2
-  x2

10









1:1

1:1



-  x1
-  x1
-  x1
-  x2
-  x1
-  x6

11

-  x1
-  x1
-  x1
-  x1
-  x1
-  x1
-  x1
-  x1
-  x2

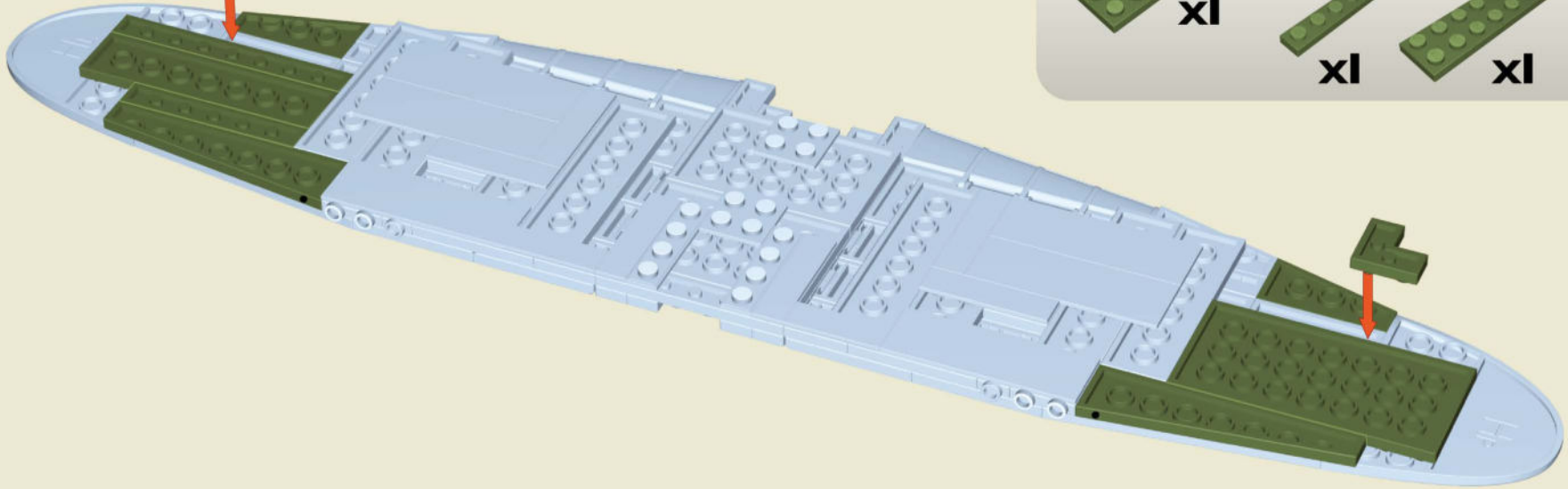

12

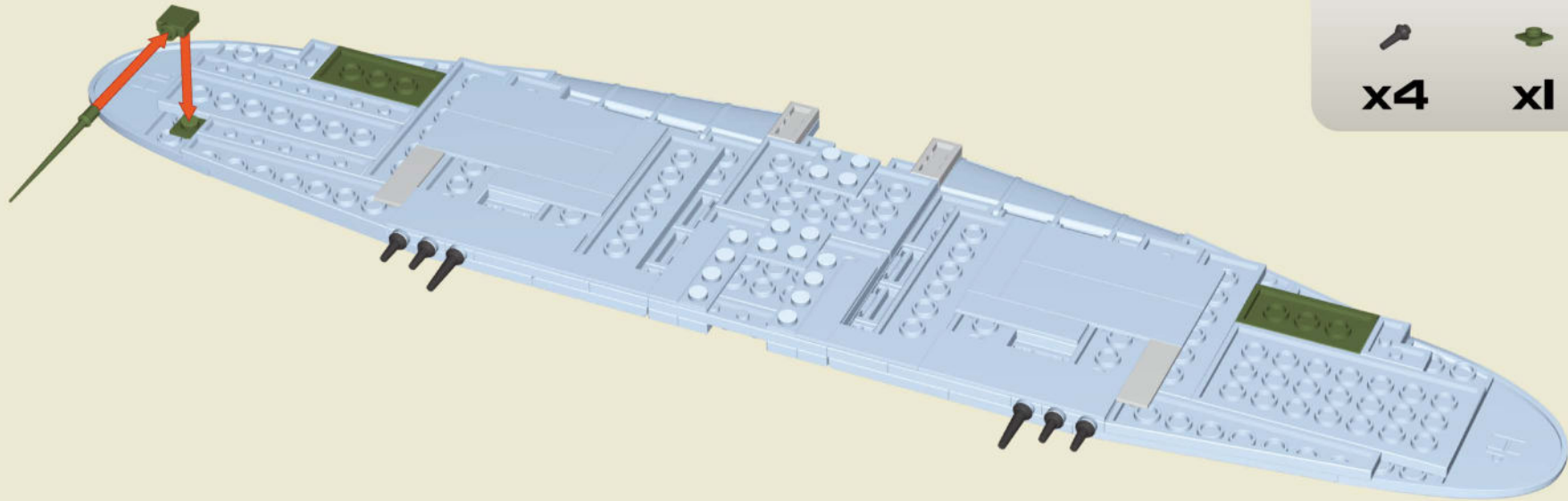

- | | | | |
|----|----|----|----|
| | | | |
| x2 | x2 | x2 | x2 |
| | | | |
| x4 | x1 | x1 | x1 |

13

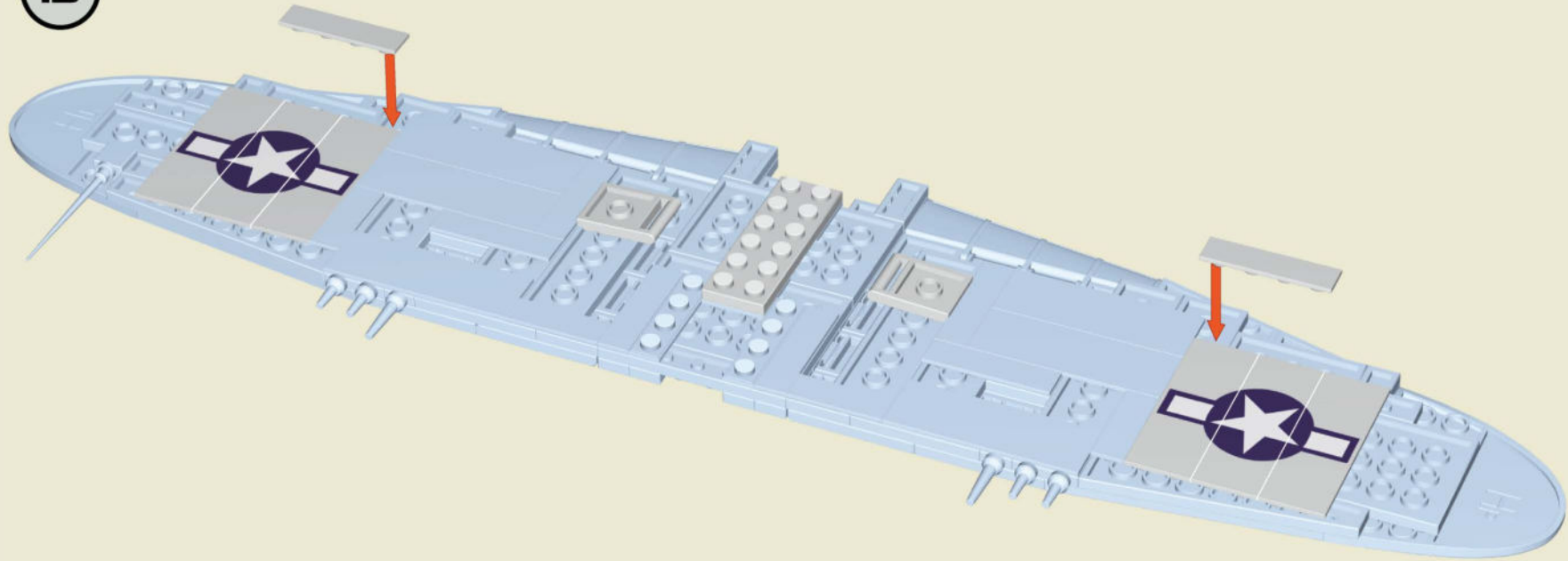

- | | |
|--|----|
| | x1 |
| | x2 |
| | x2 |
| | x2 |
| | x2 |
| | x2 |

14

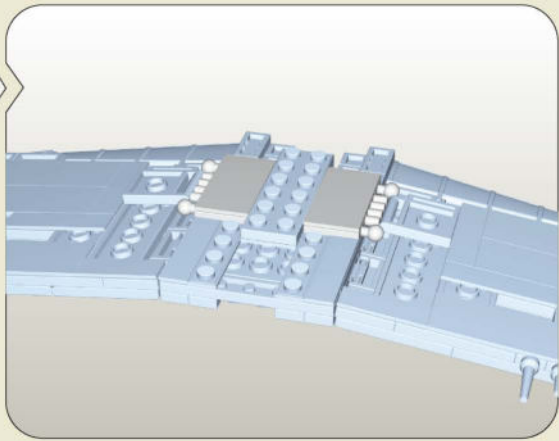
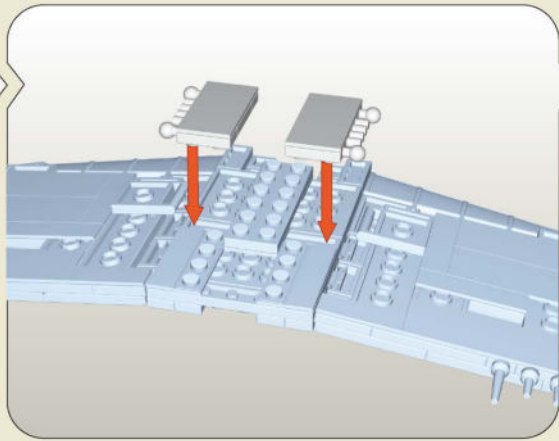
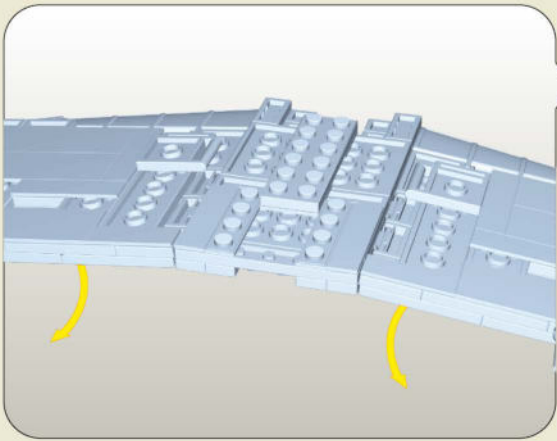

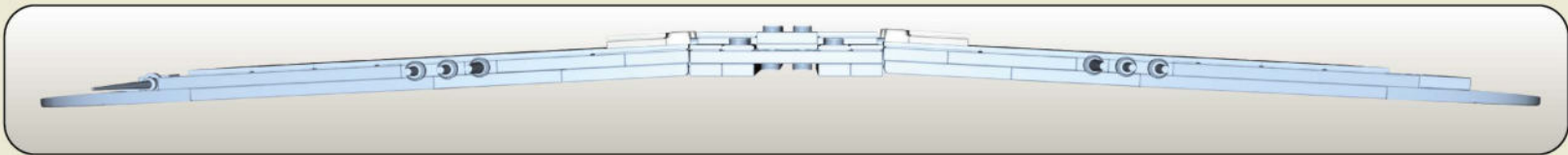
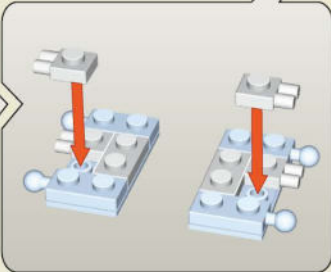
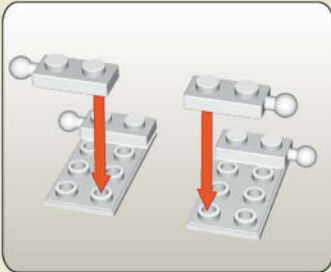
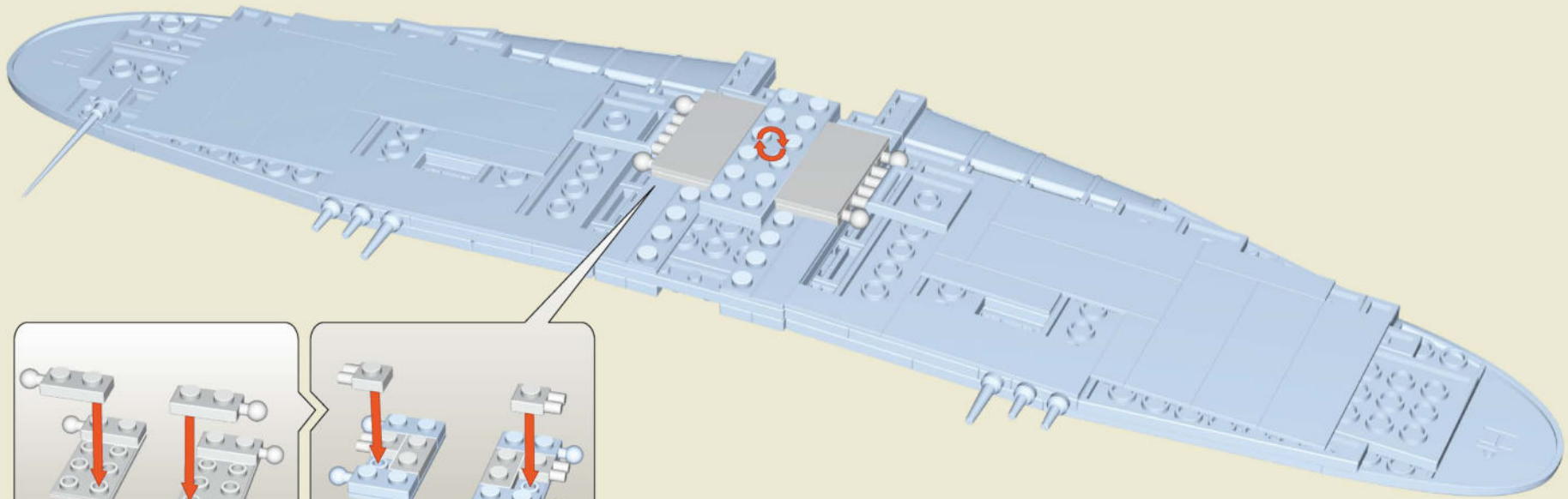

-  x2
-  x4
-  x4
-  x2

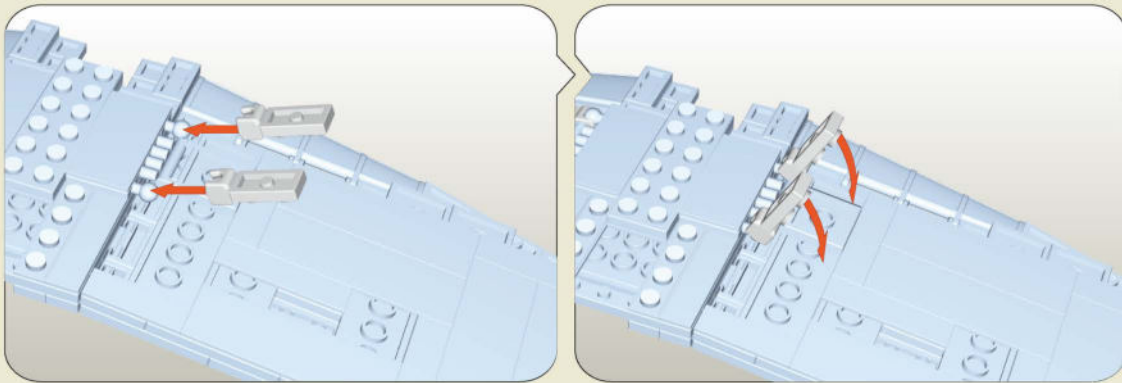

15



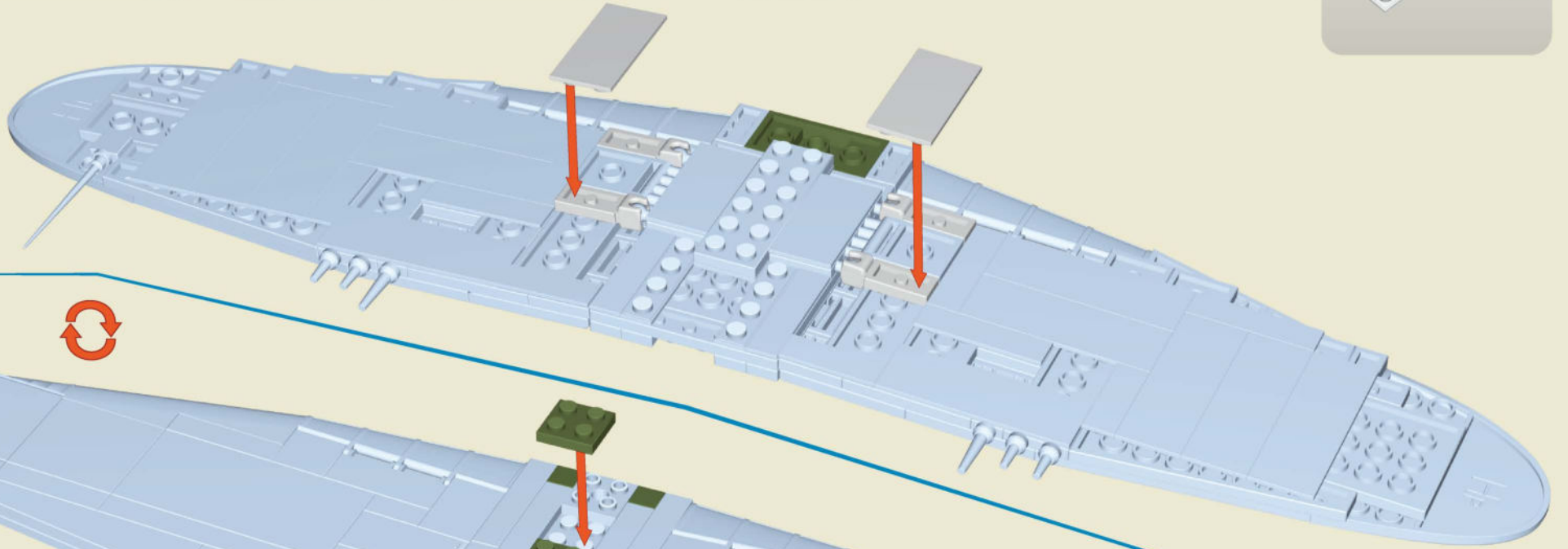

-  **x4**
-  **x1**
-  **x2**

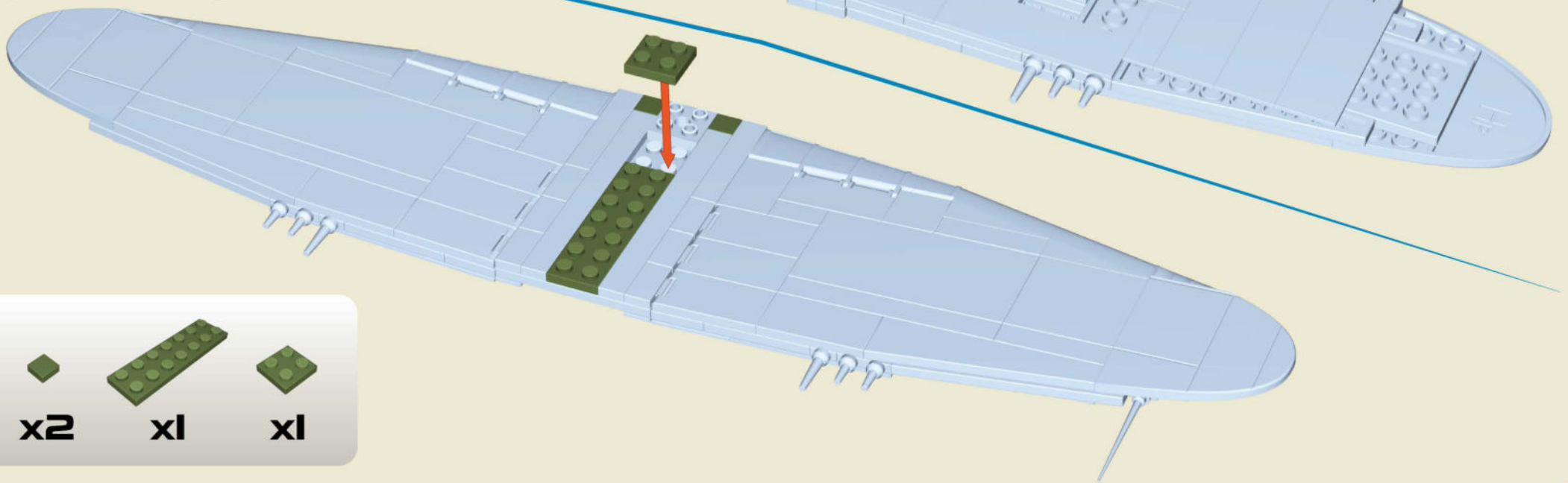

16



-  **x2**
-  **x1**
-  **x1**

17

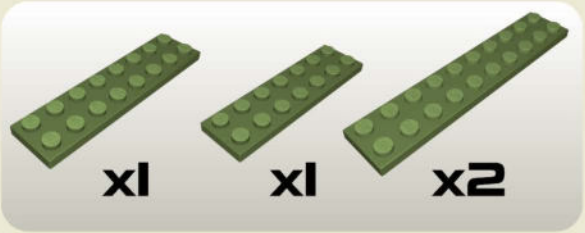
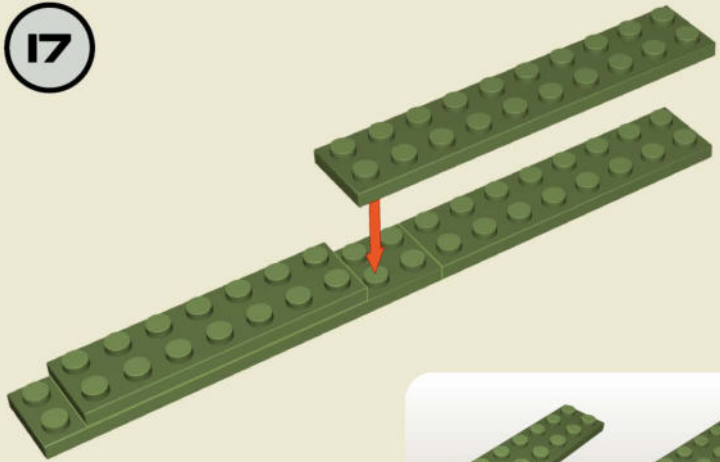

18

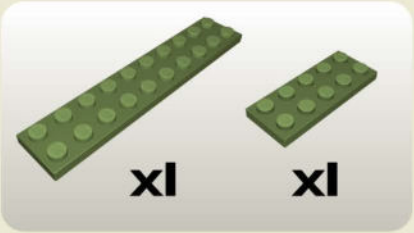
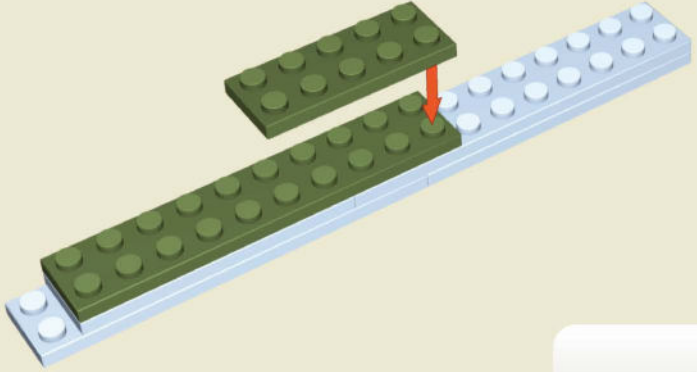

19

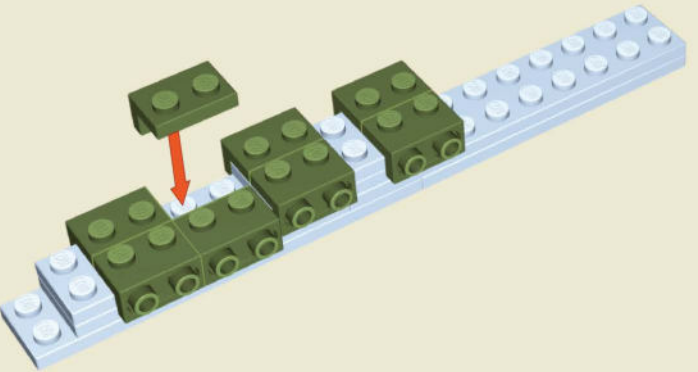

20

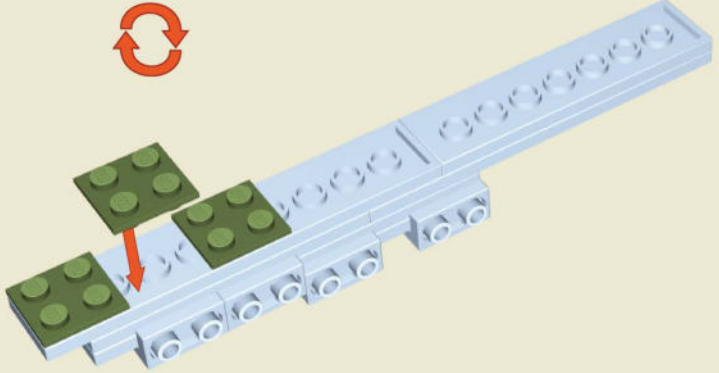

21

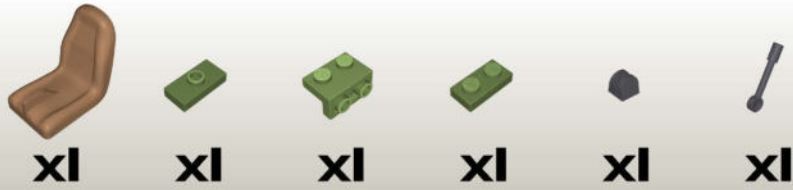
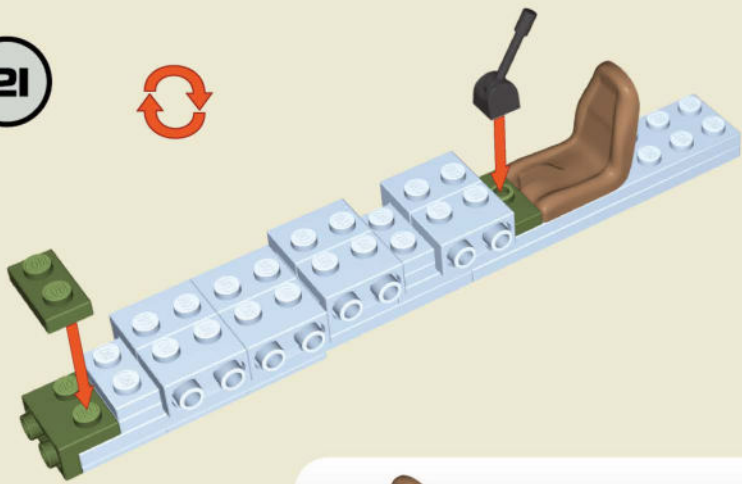

22

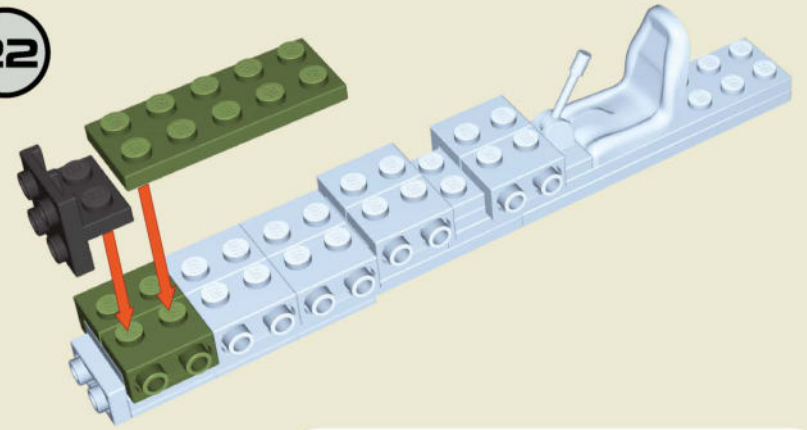

23

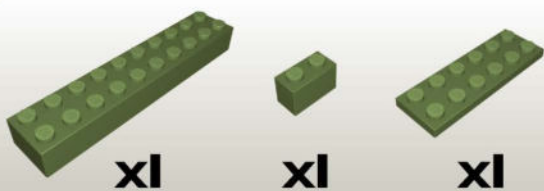
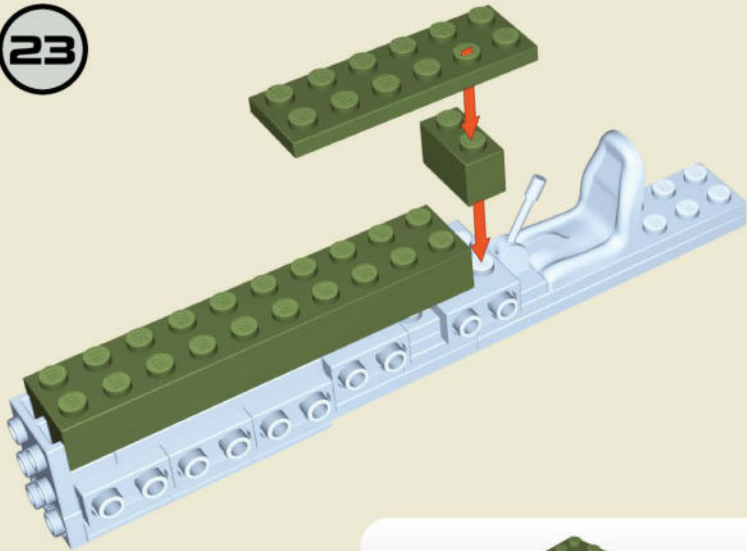

24

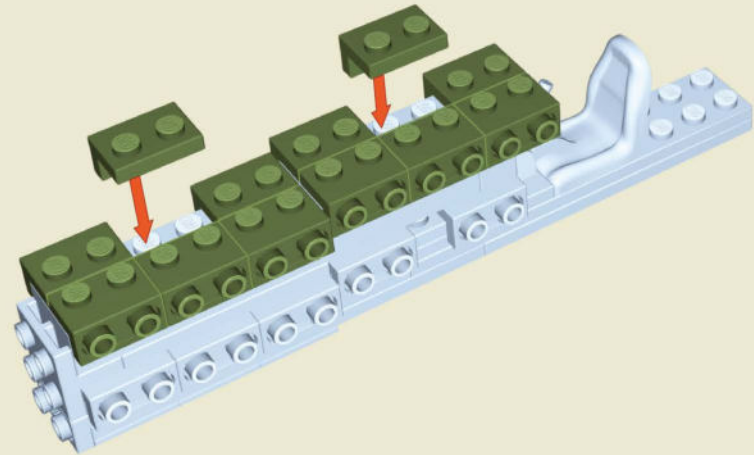

25

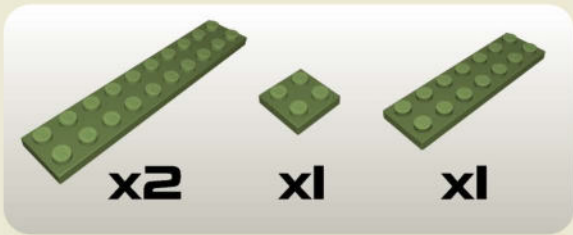
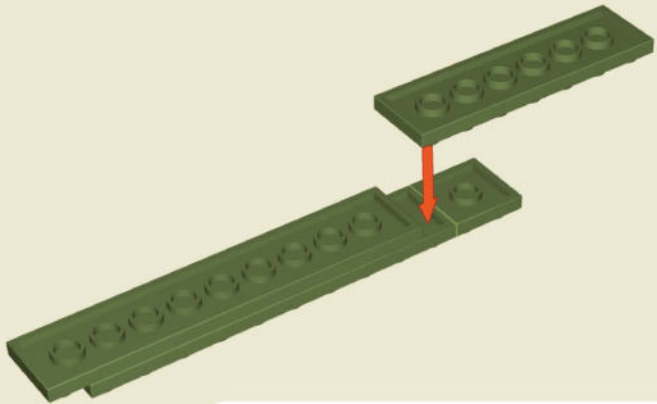

26

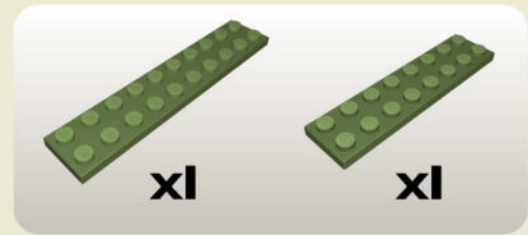
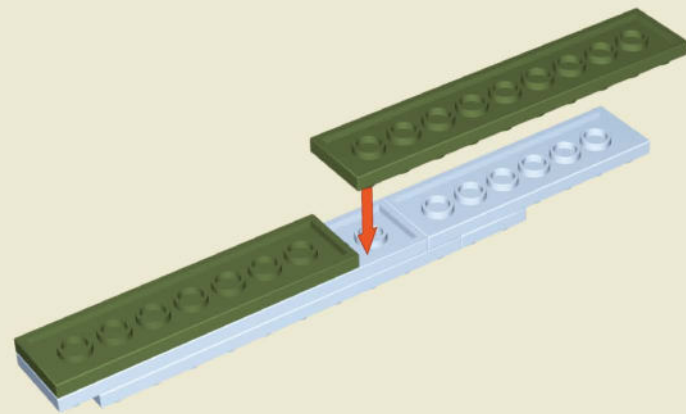

27

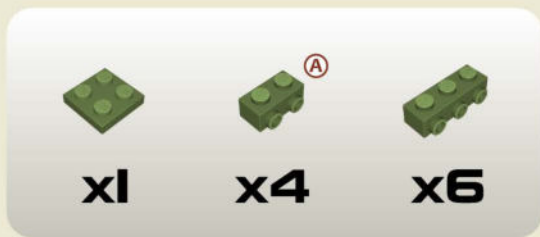
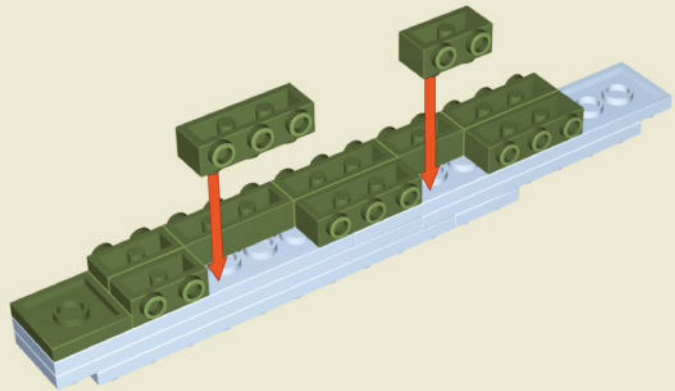



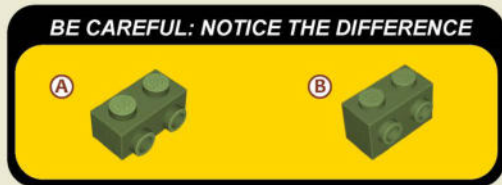
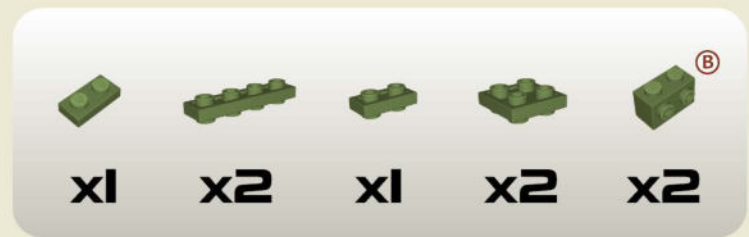
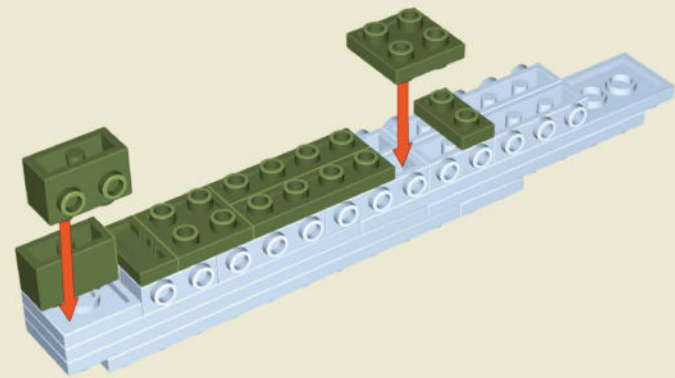

28

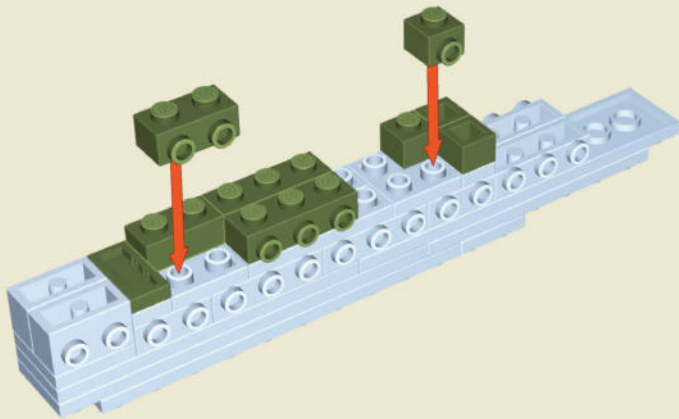

29



 **x1**
  **x2**
  **x2**
  ^A **x2**
  **x2**

30

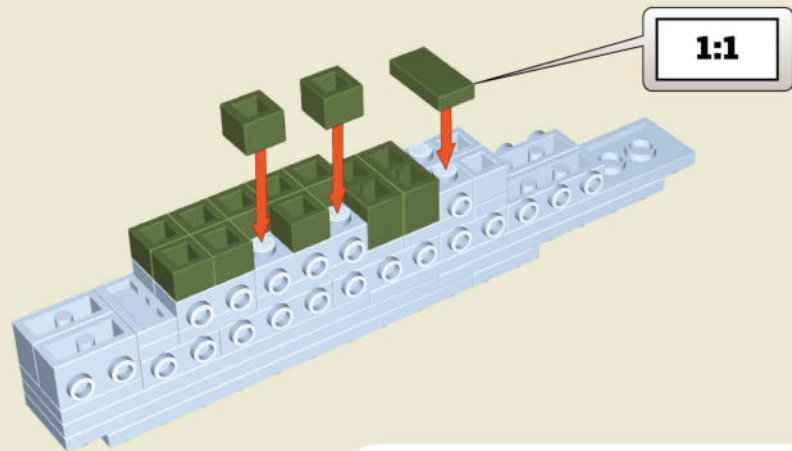

 **x2**
  **x10**
  **x1**



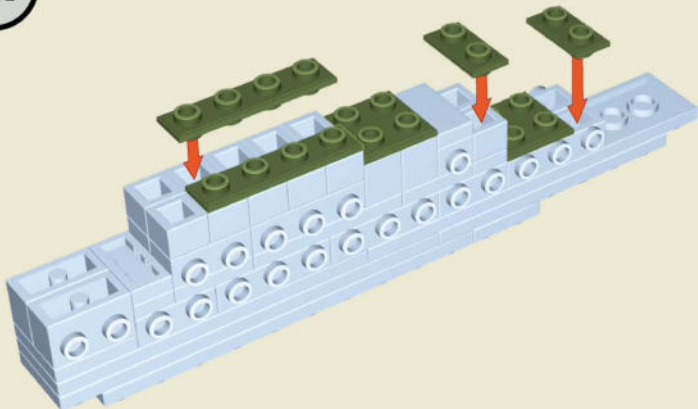

31

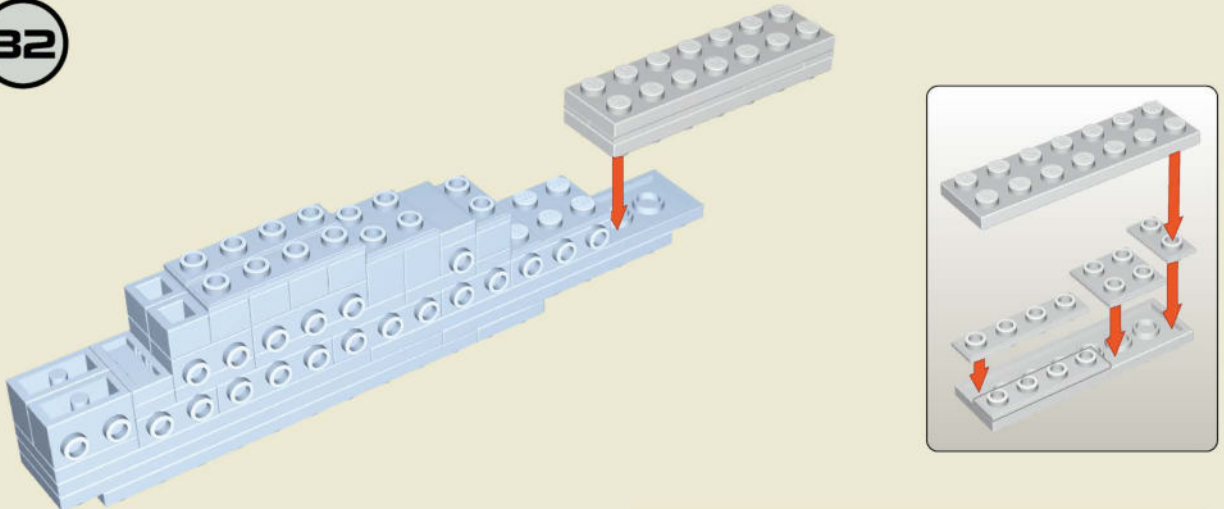

 **x2**
  **x2**
  **x2**

32



 **x2**
  **x2**
  **x1**
  **x1**

33

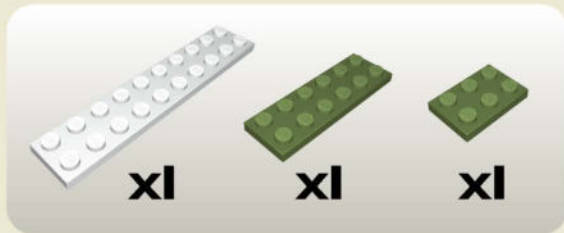
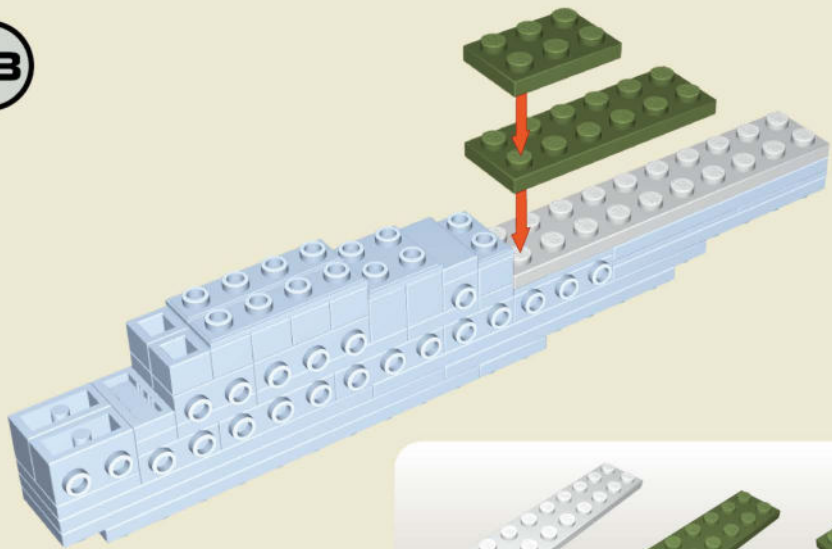

34

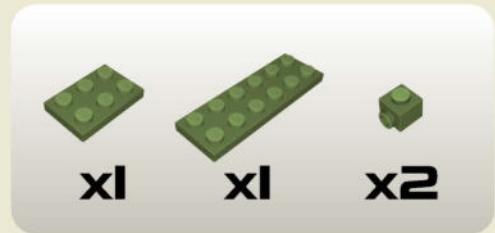
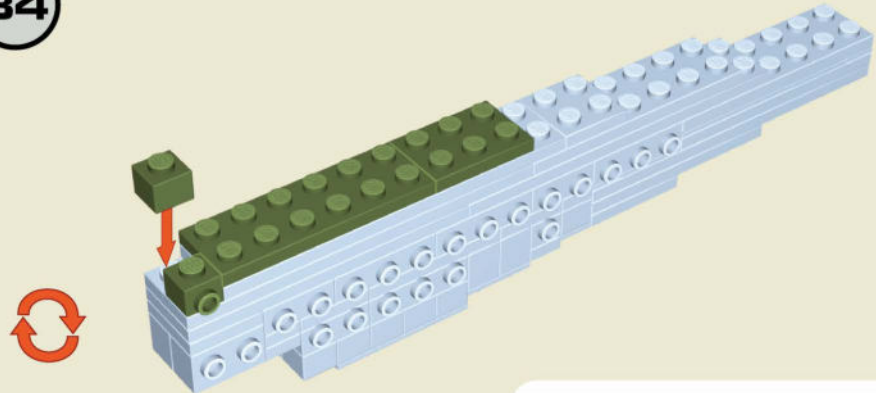

35

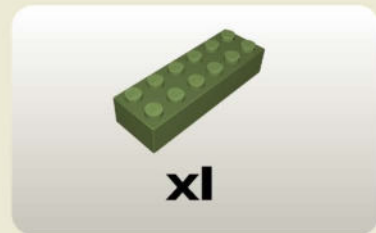
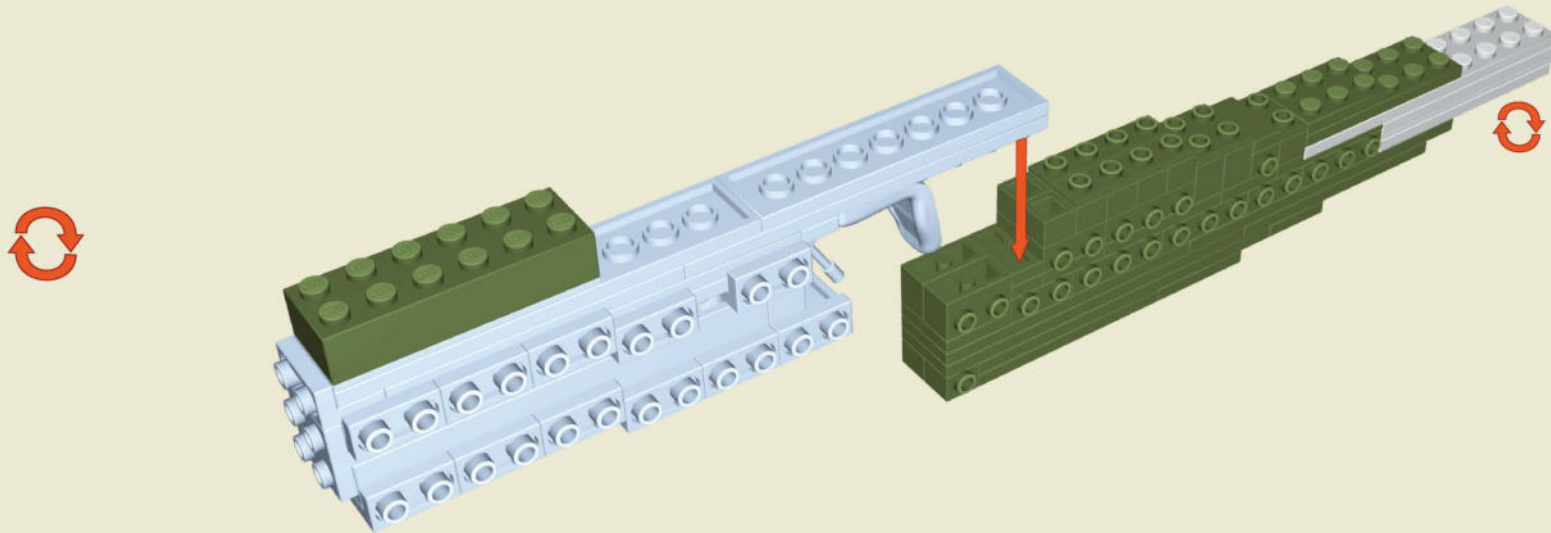



36

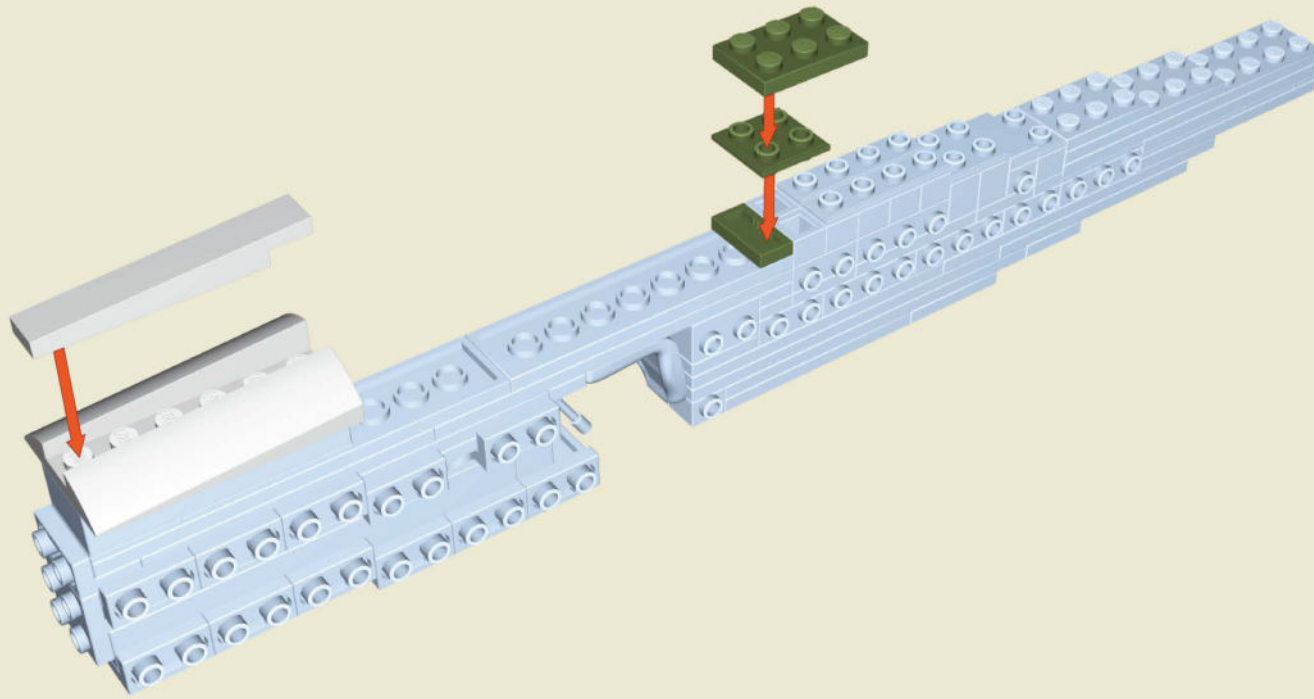

- x1
- x1
- x1
- x1
- x1

37

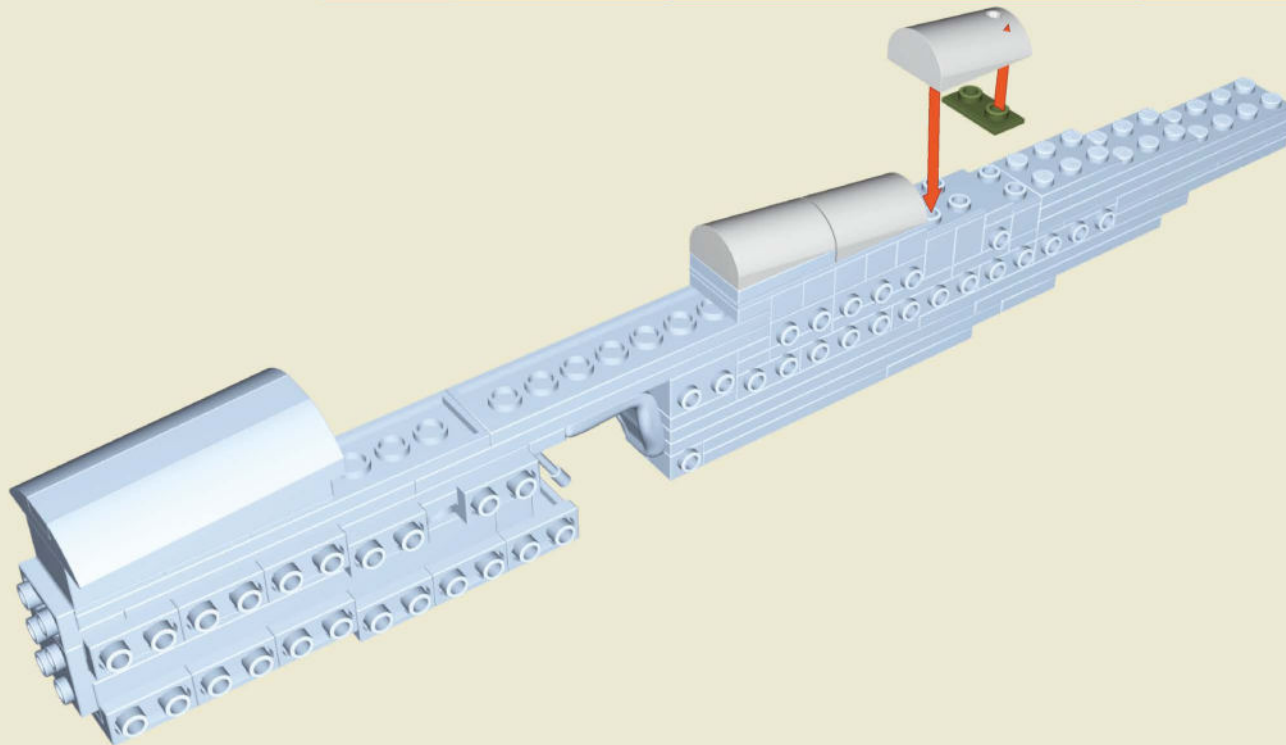





- x2
- x1
- x1

BE CAREFUL: NOTICE THE DIFFERENCE

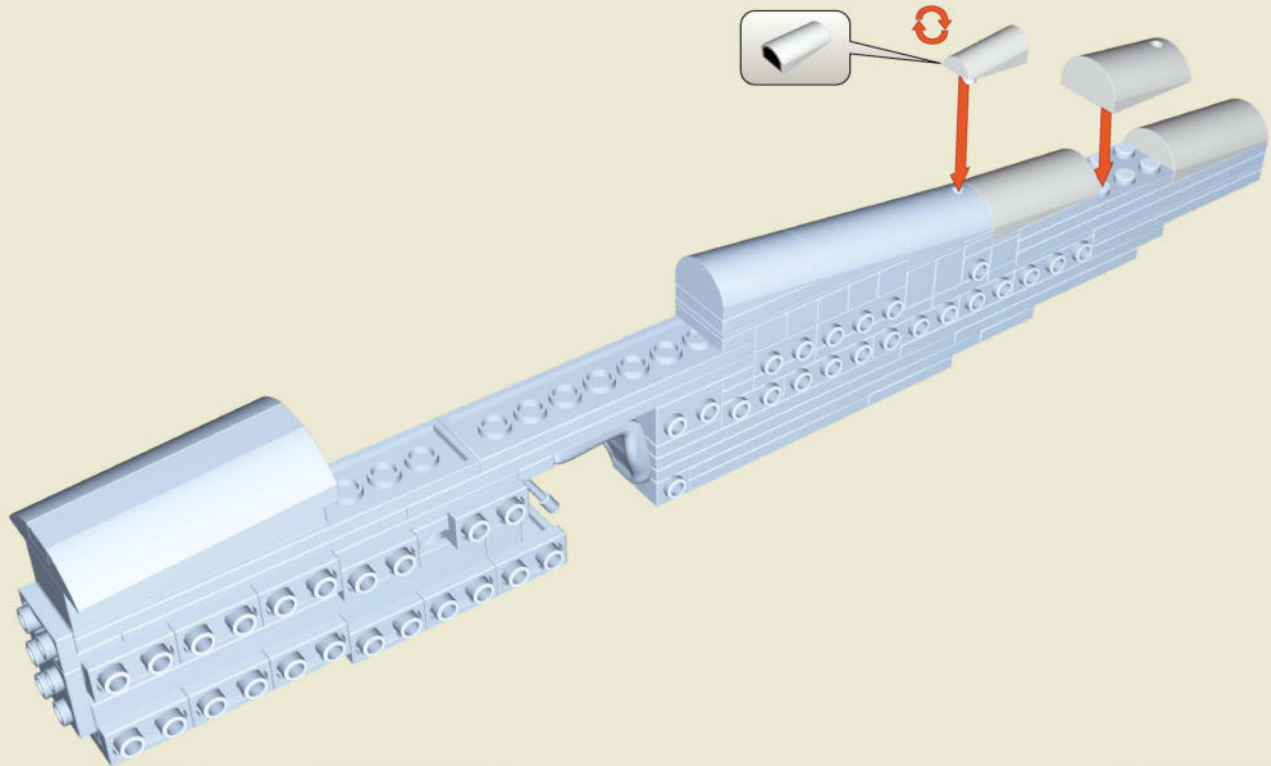
C D E F

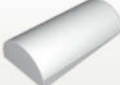

38

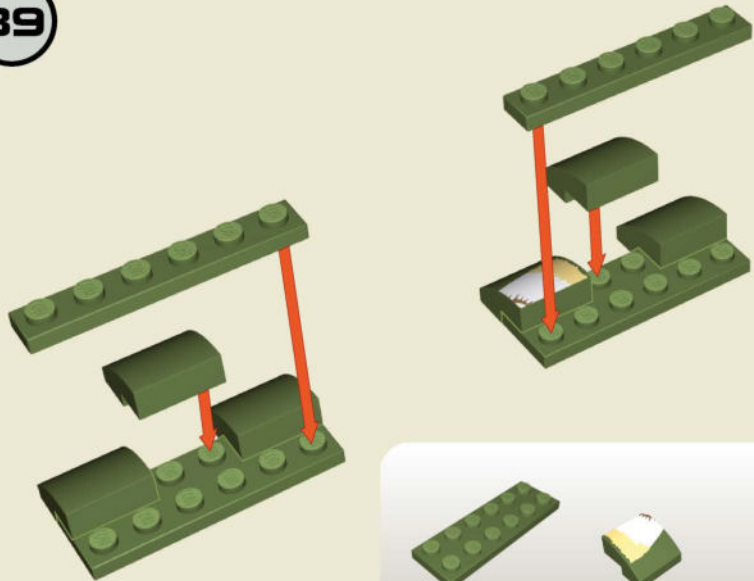

-  x2
-  x1
-  x1
-  x1

39



-  x2
-  x1
-  ^E x5
-  x2

40

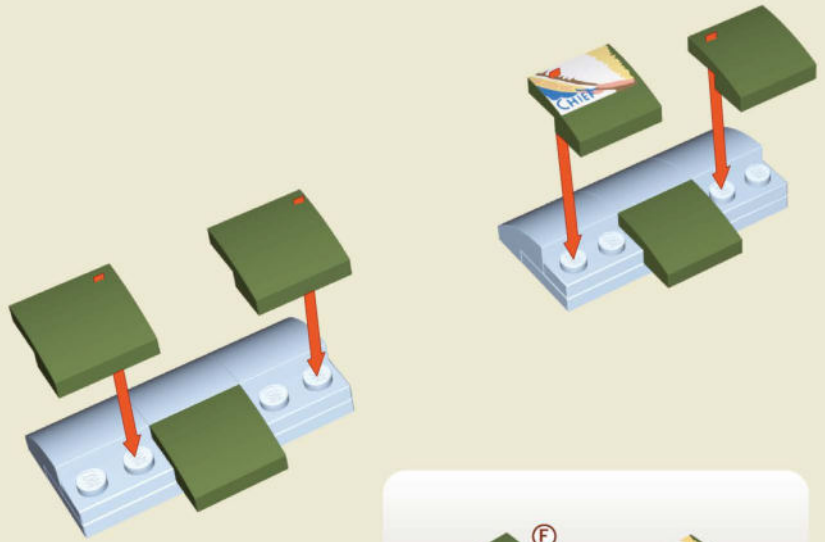

-  ^F x5
-  x1

41

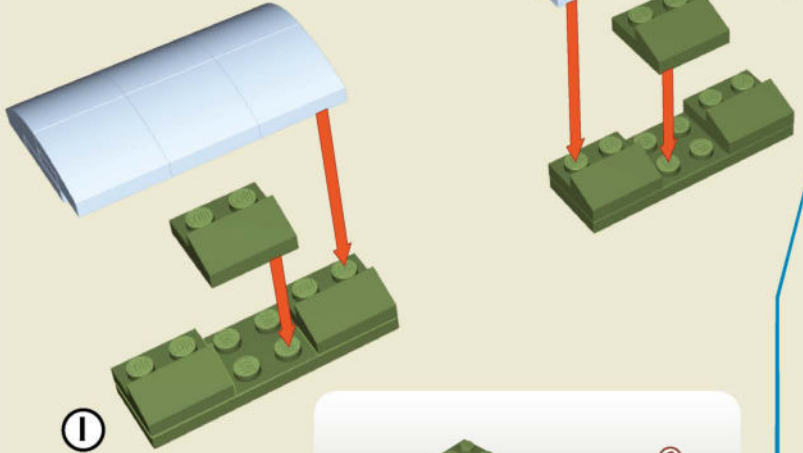

①

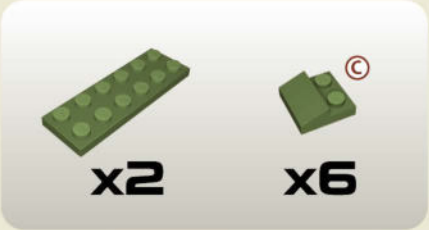

②

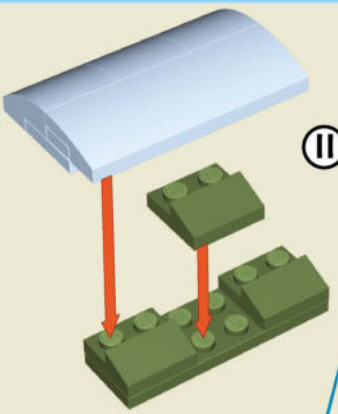

42

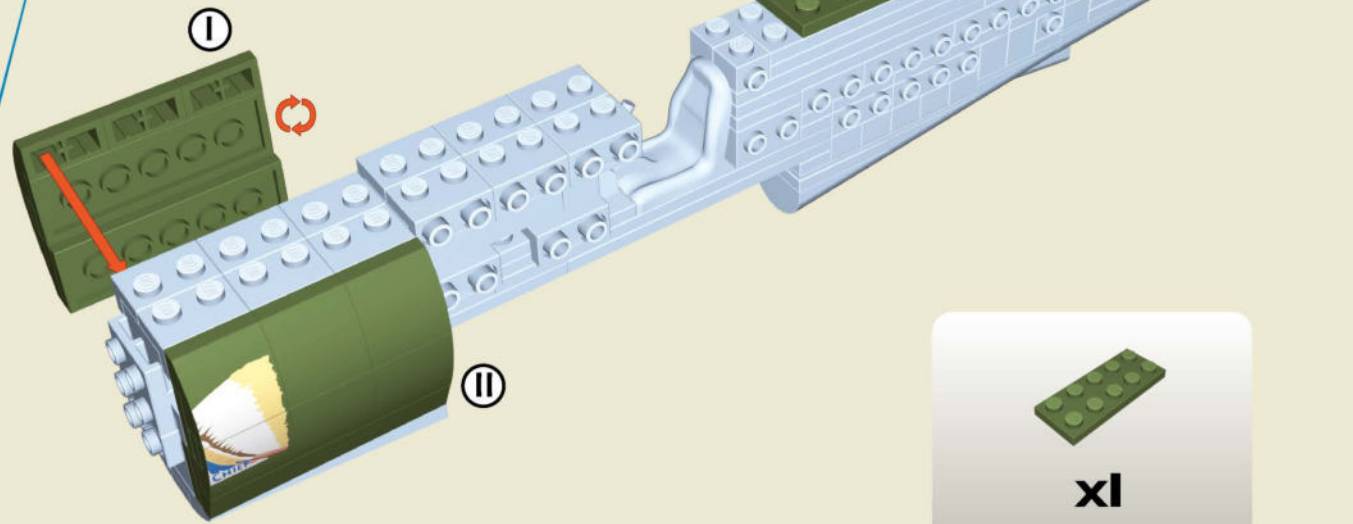

①

②



43

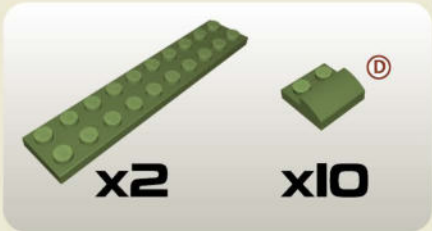
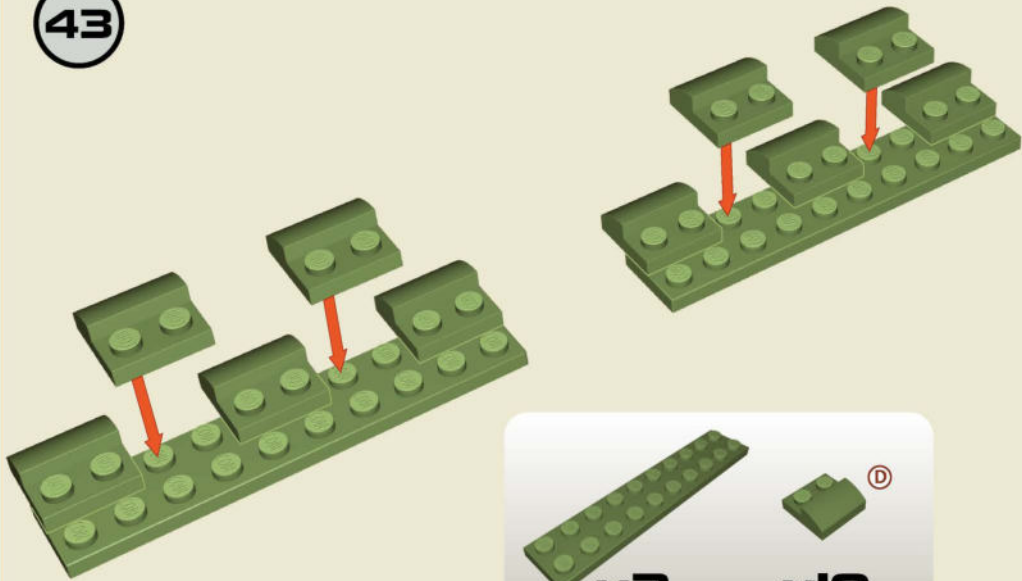

44

1:1

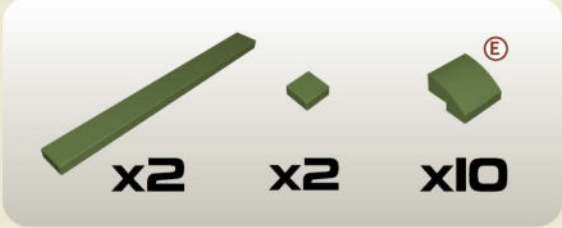
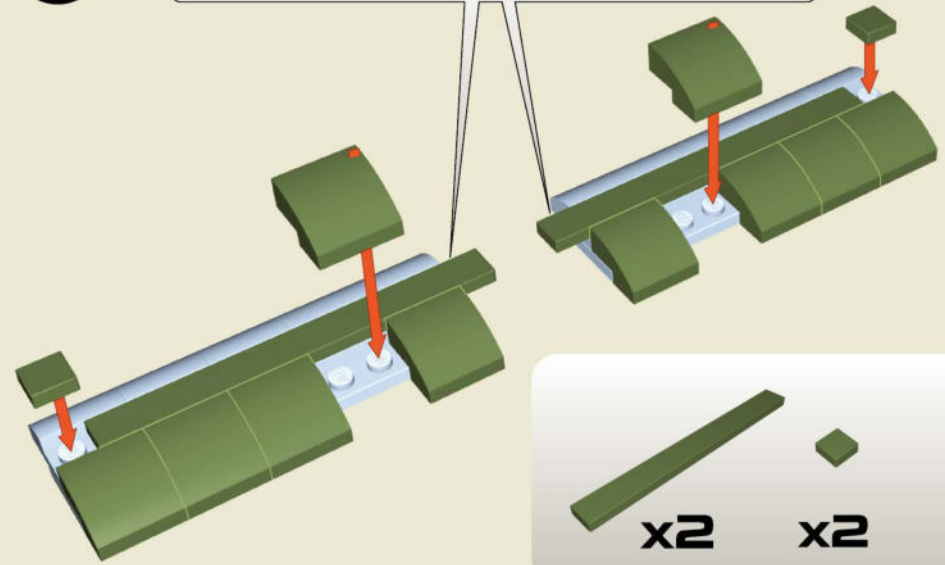

45

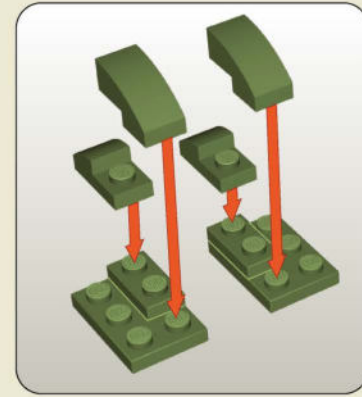
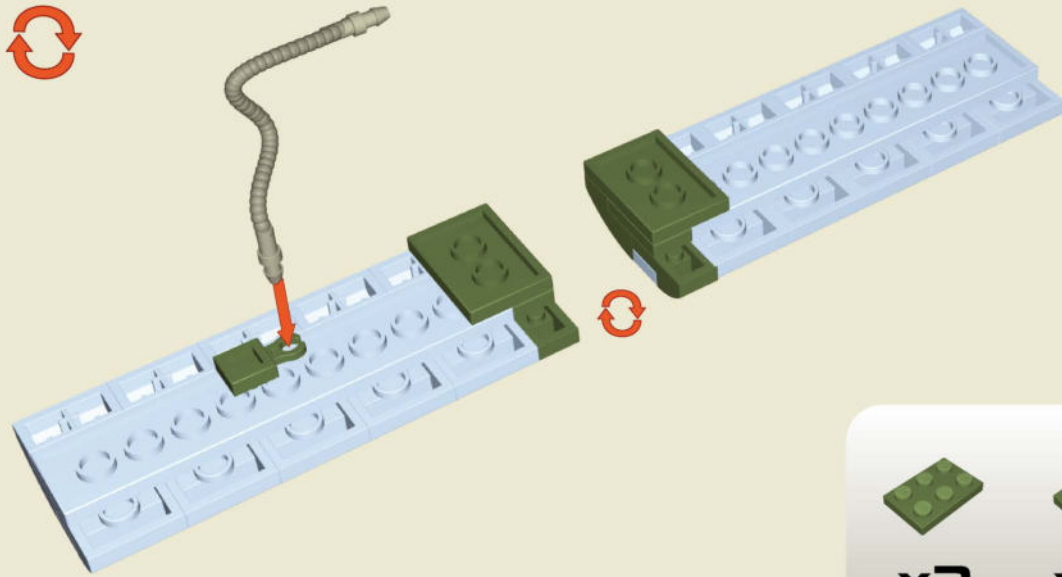

x2



x2



x2



x2



x1







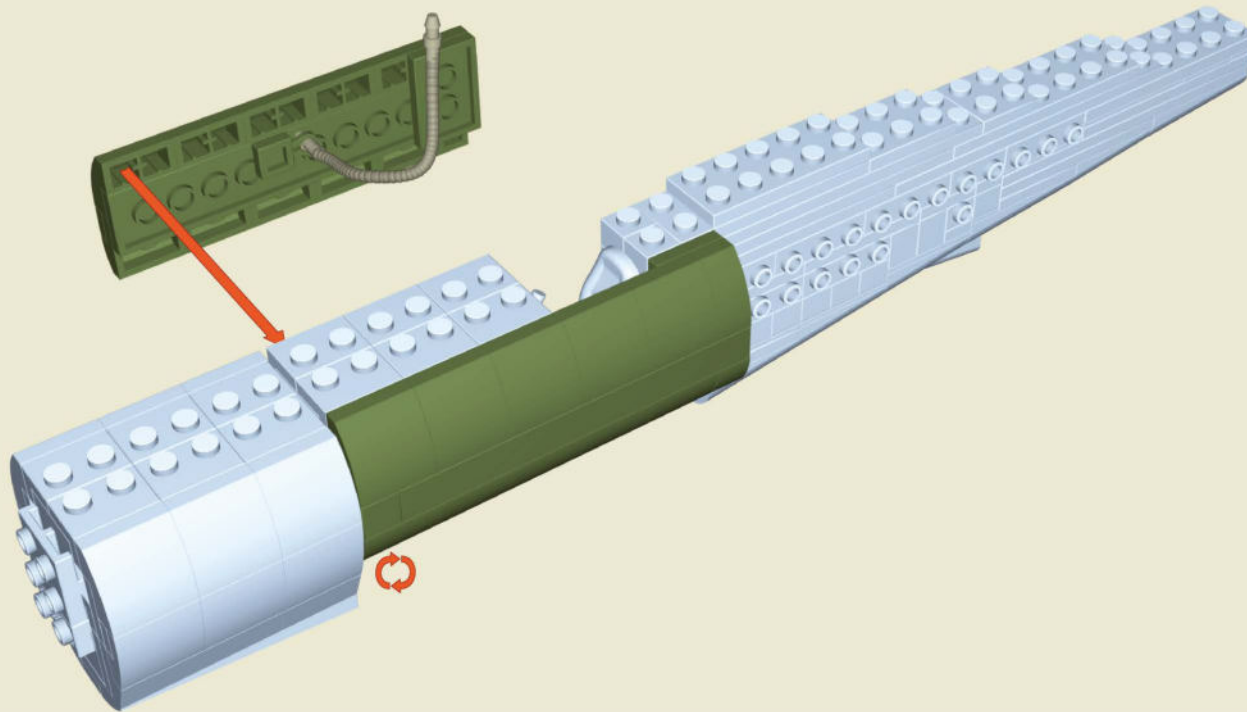

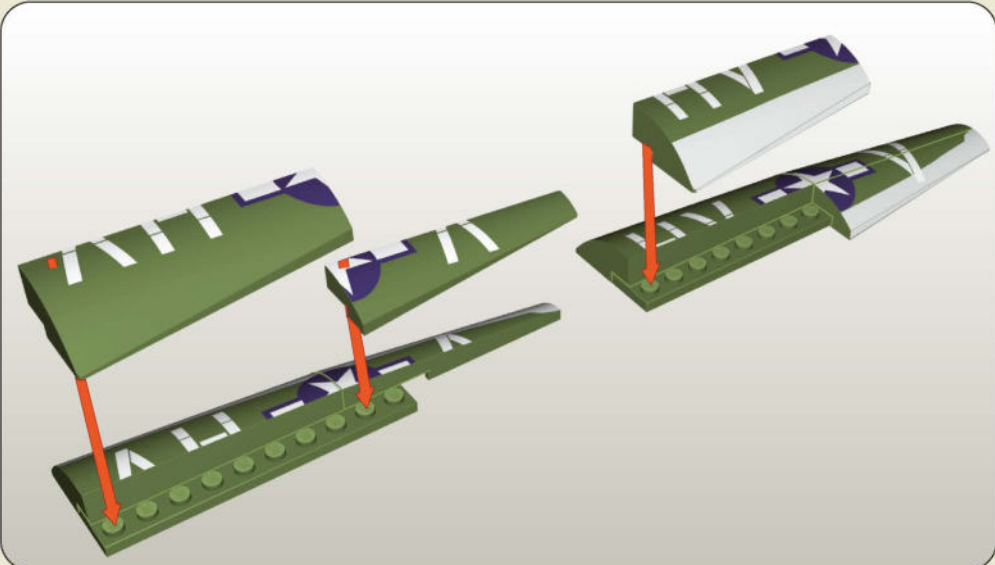
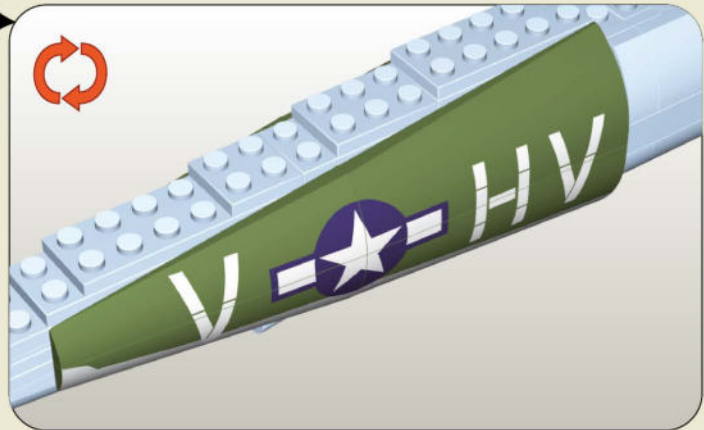
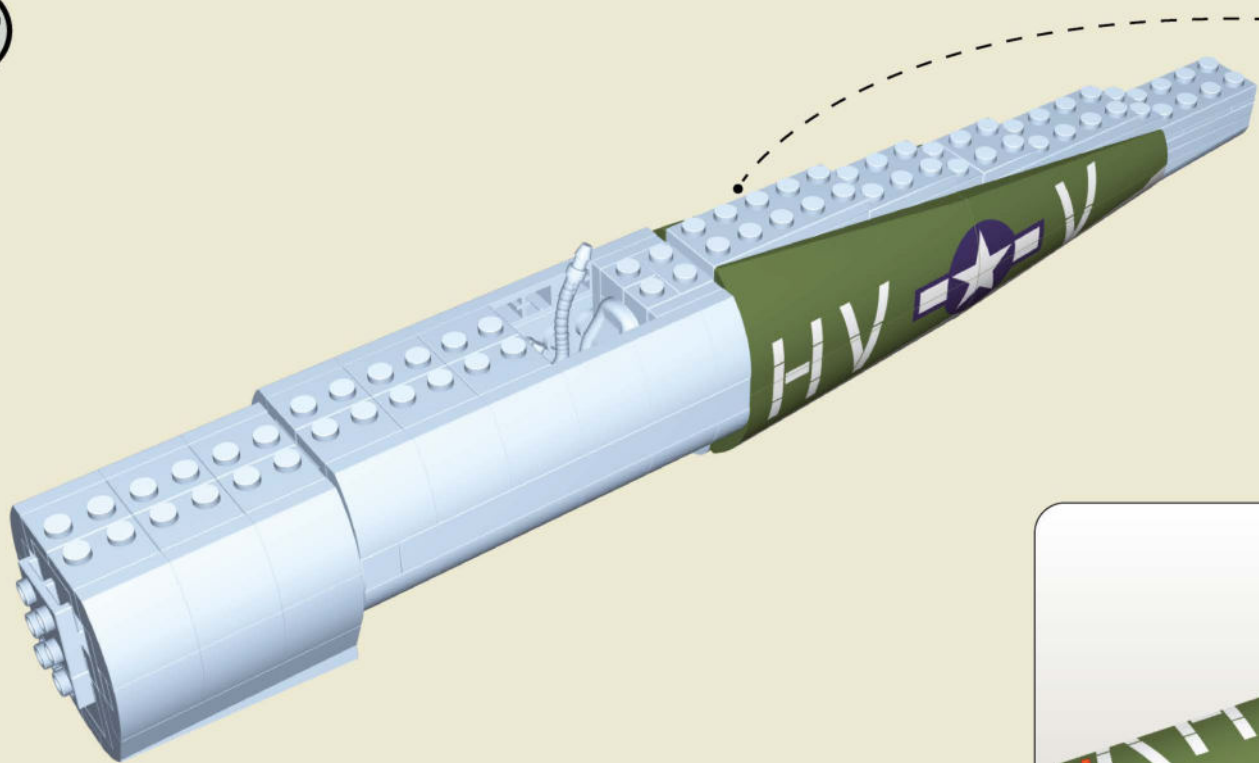
x1

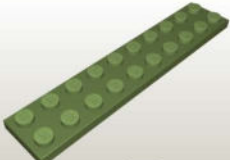
46

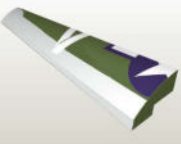
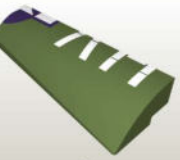
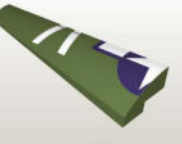

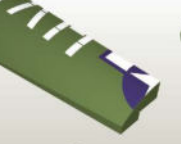

-  x2
-  x1
-  x1
-  x1
-  x1
-  x1
-  x1
-  x1
-  x1

48

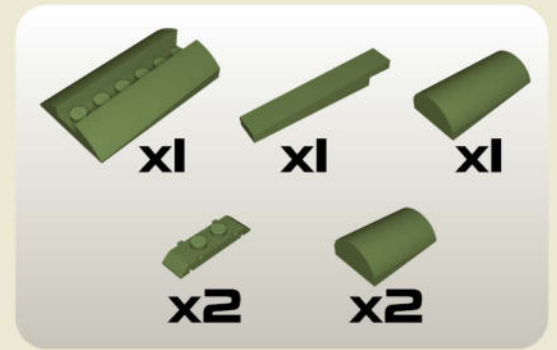
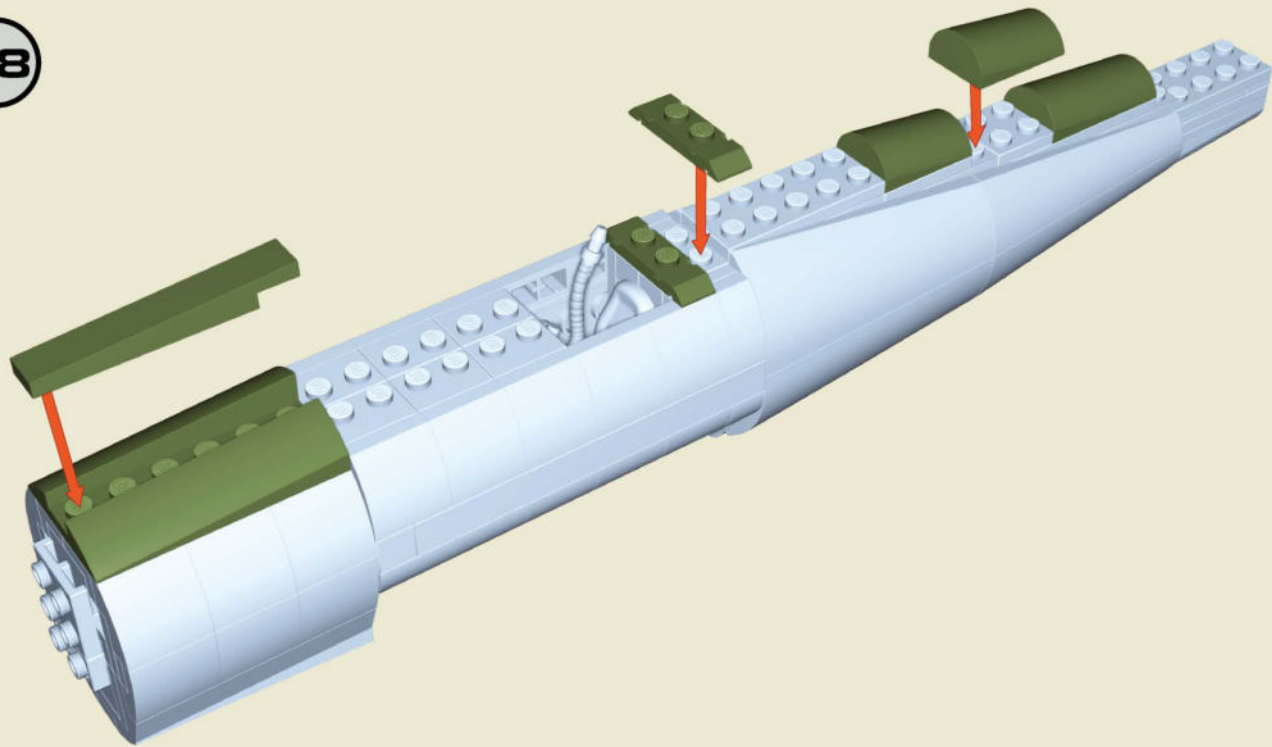

49

1:1

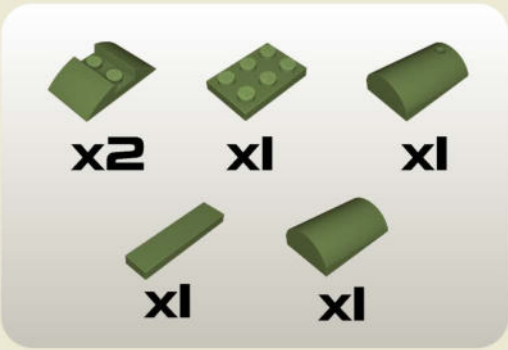
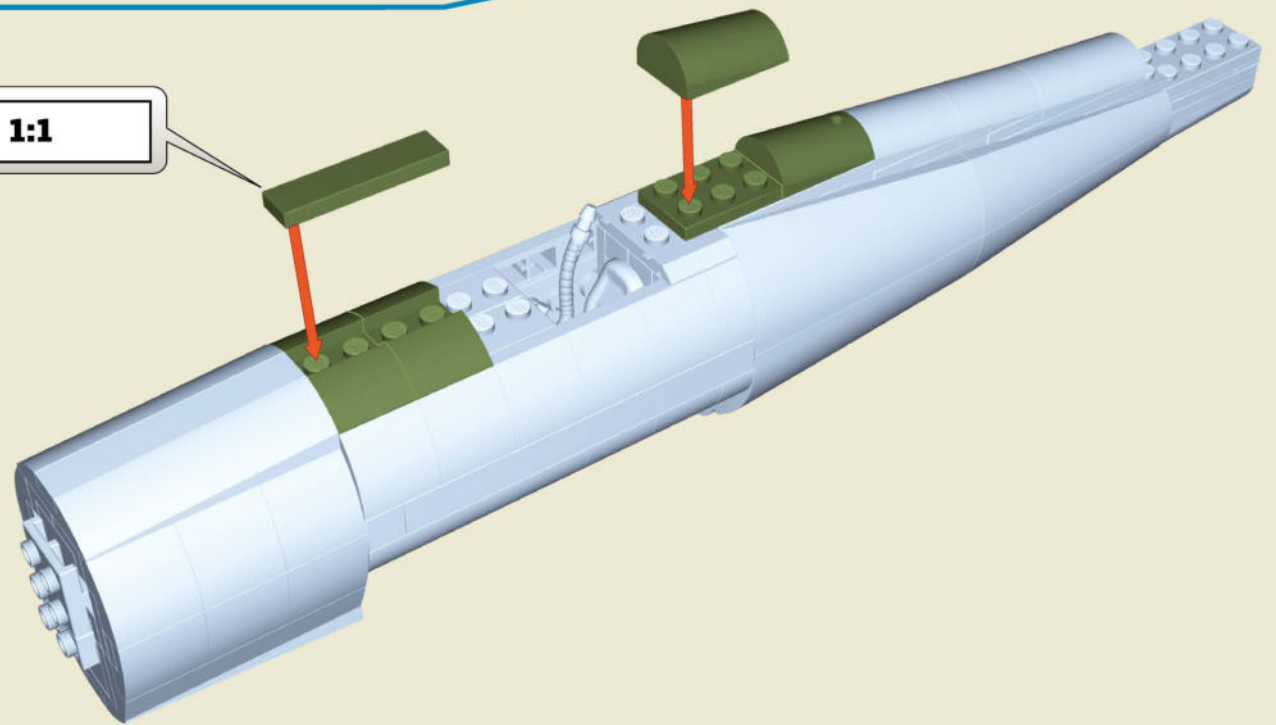

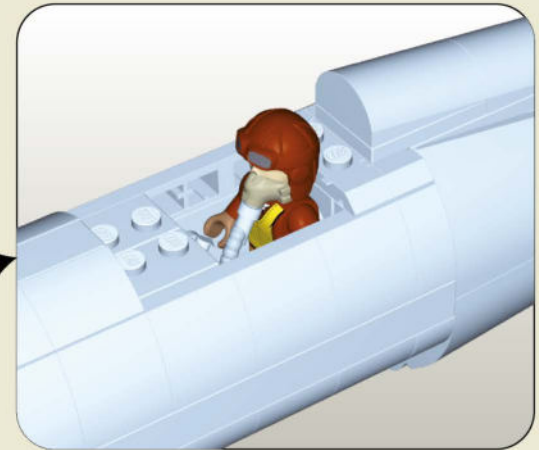
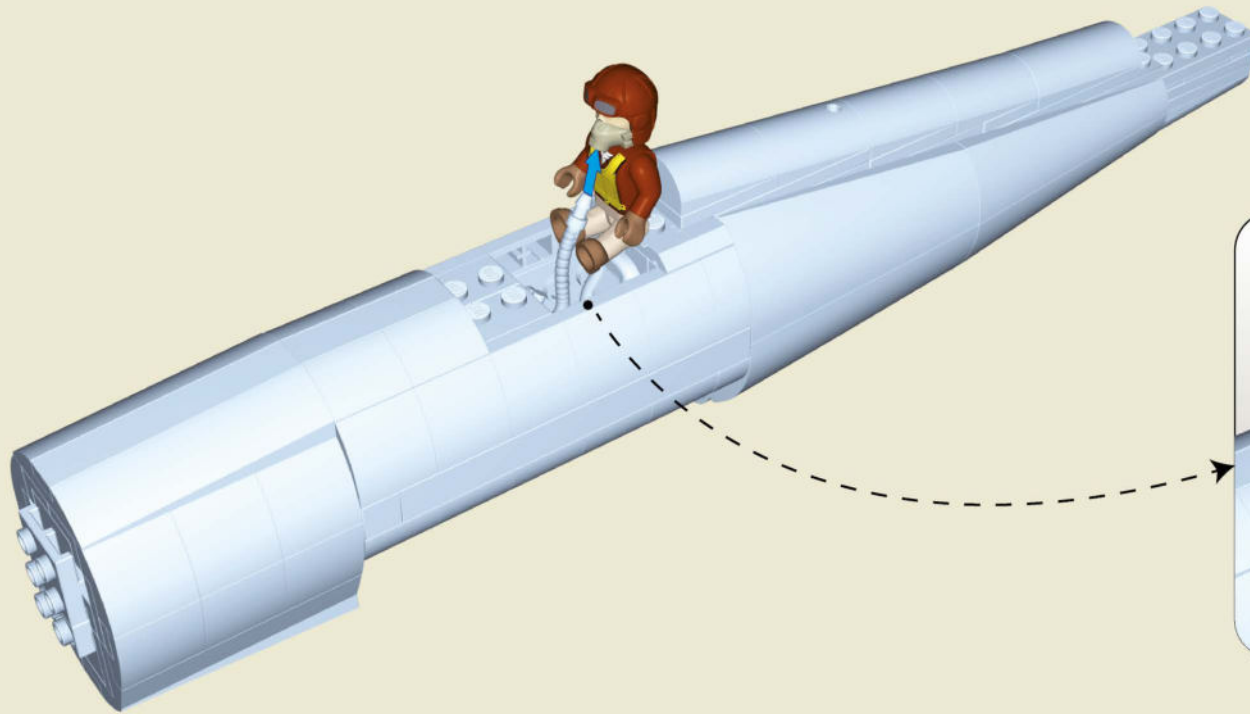

x1	x1	x1	x2
x1	x1	x1	x1

A sequence of three diagrams showing the assembly of the minifigure. The first diagram shows a brown minifigure torso with a yellow vest and light blue pants, with a light grey head being placed on top. The second diagram shows the torso with the head and a red hood being placed on top. The third diagram shows the complete minifigure with the red hood on its head.

51

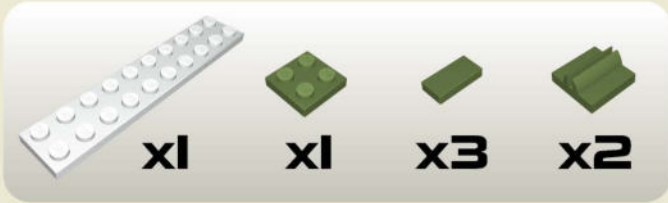
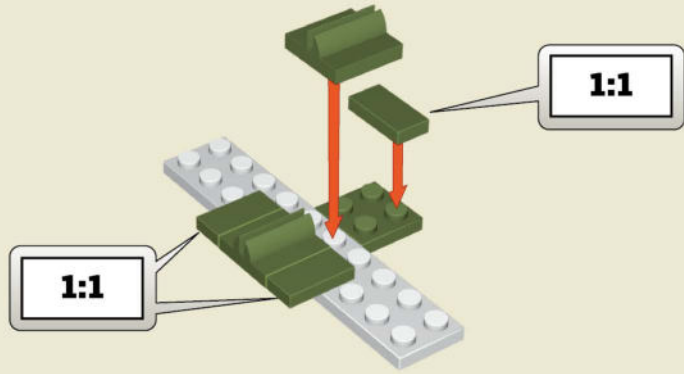

52

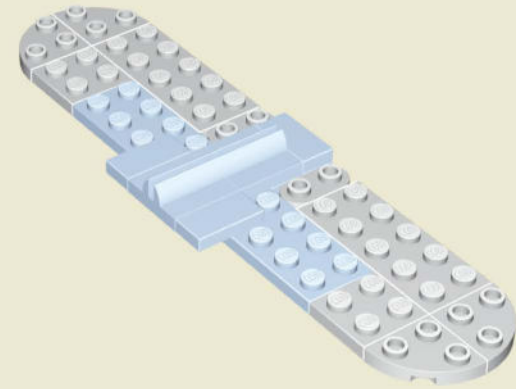

53

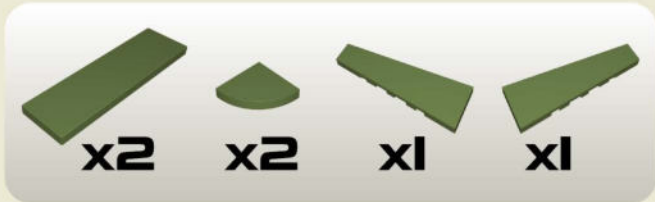
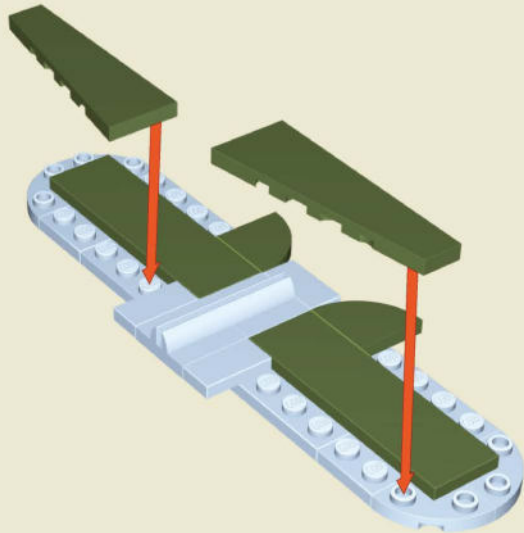

54

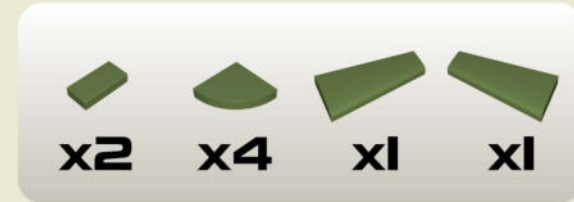
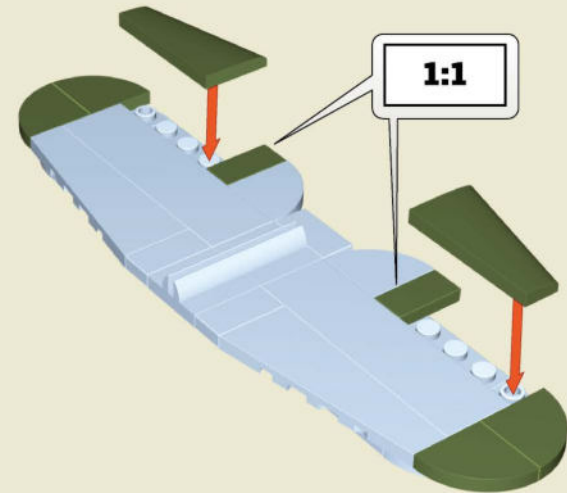

55



x1



x1



x1

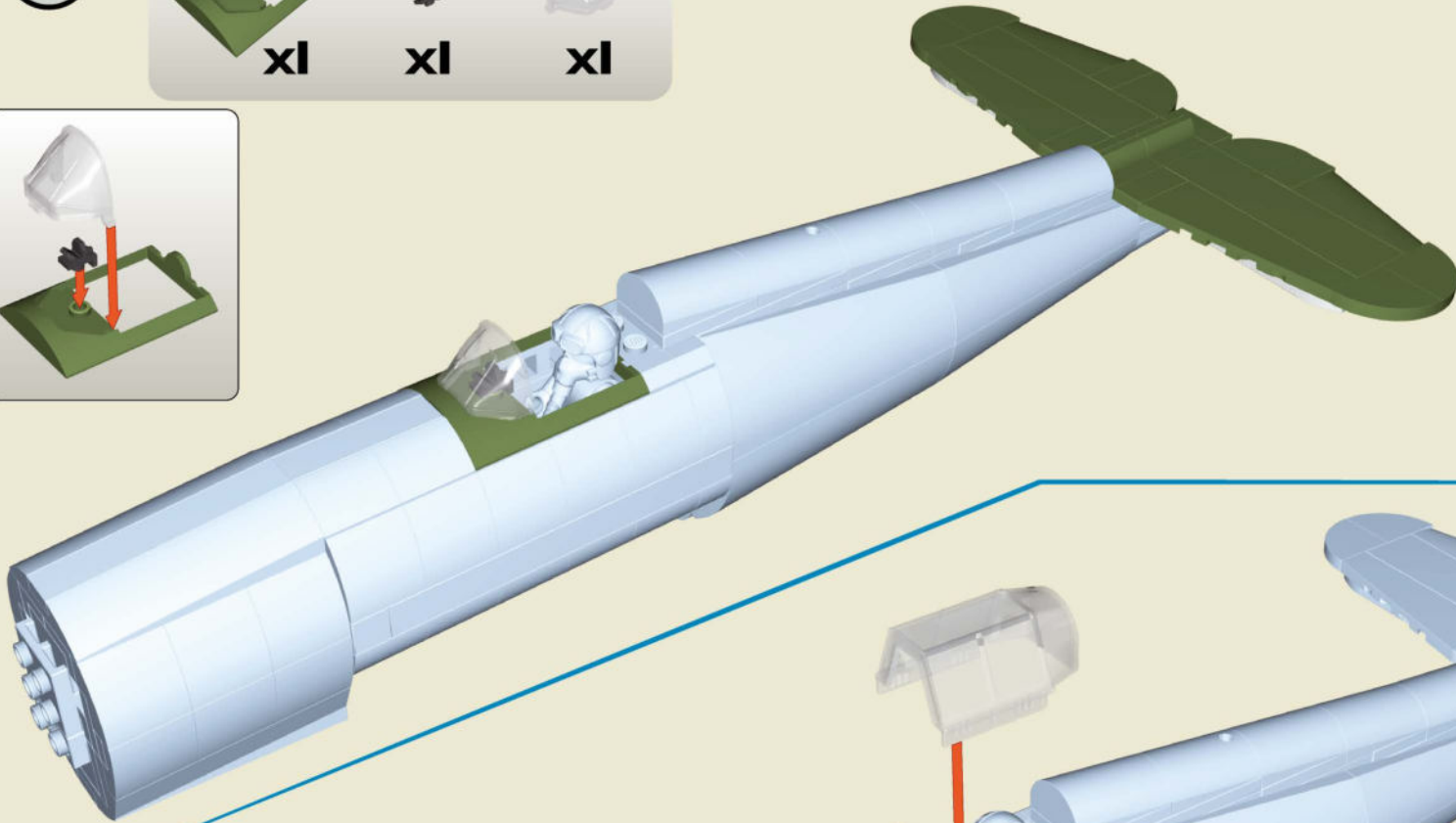
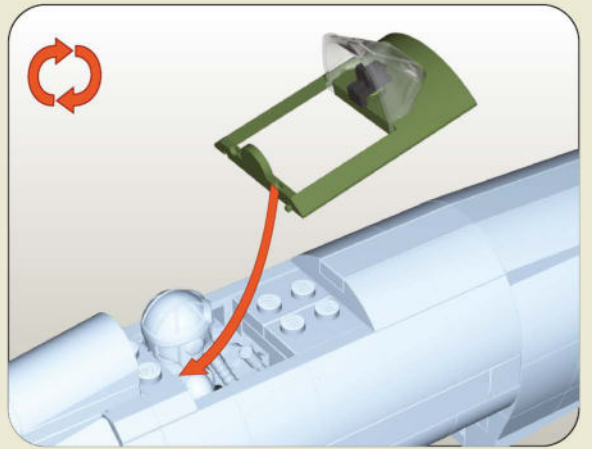

56

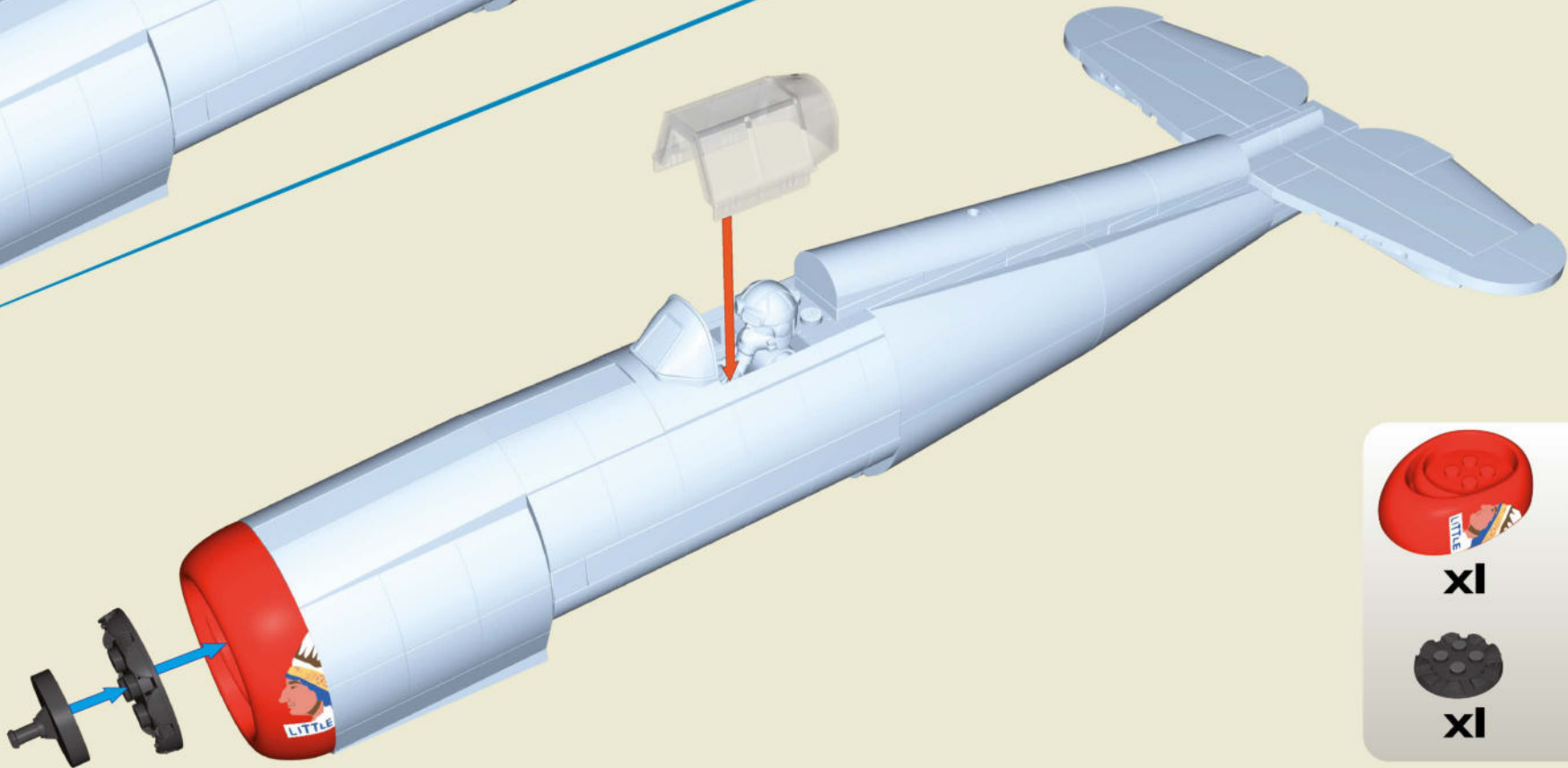

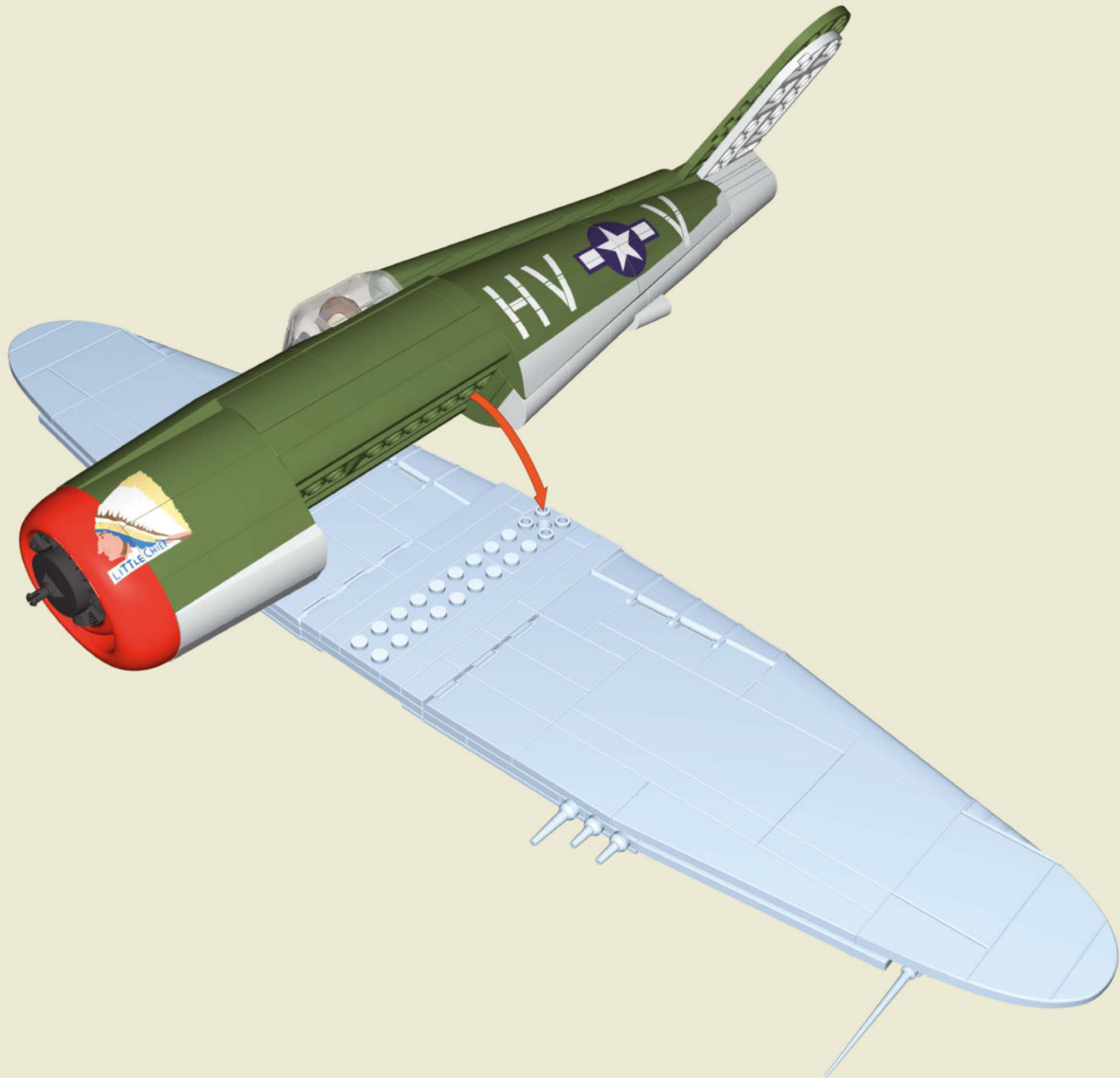

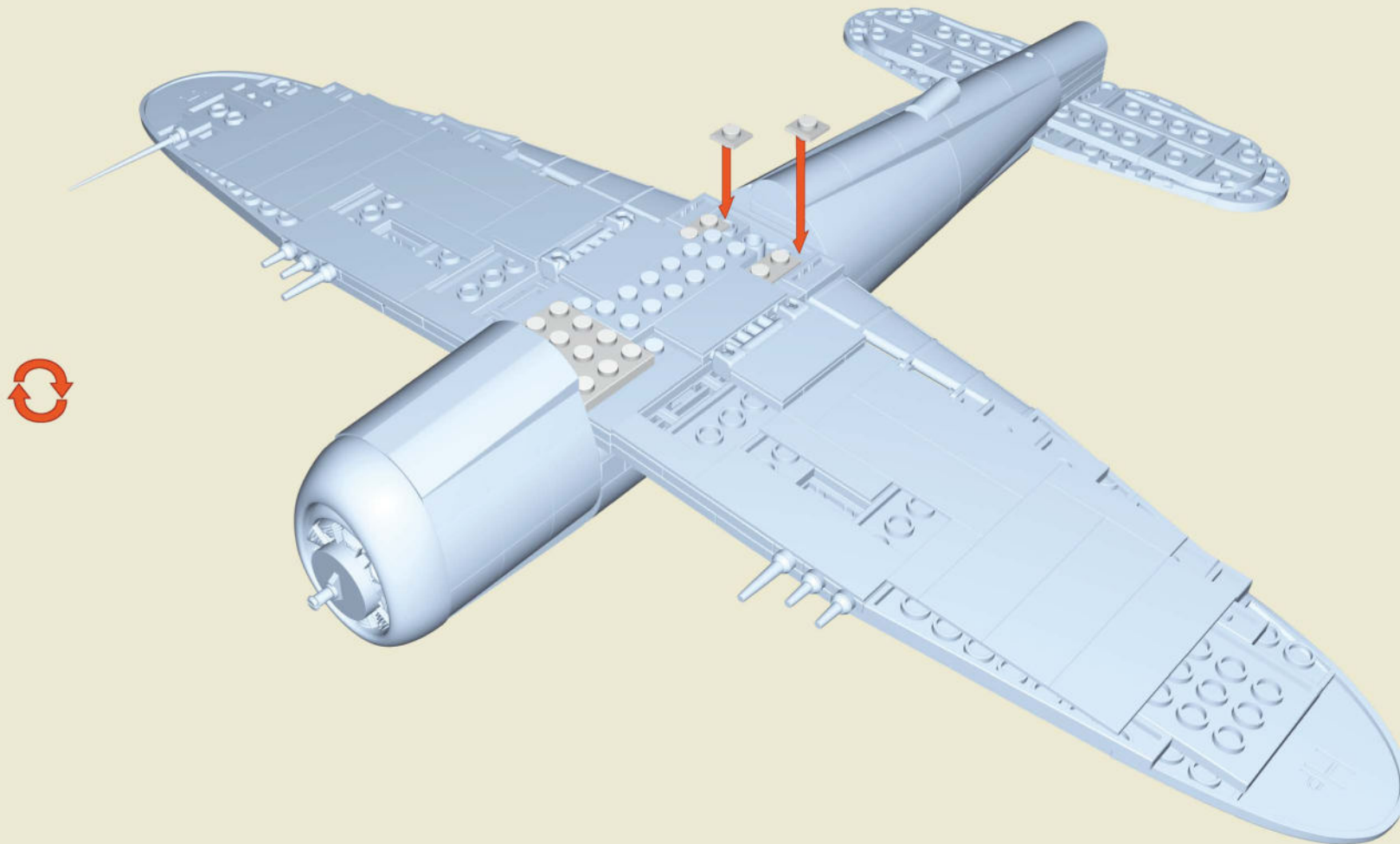

x1



x2





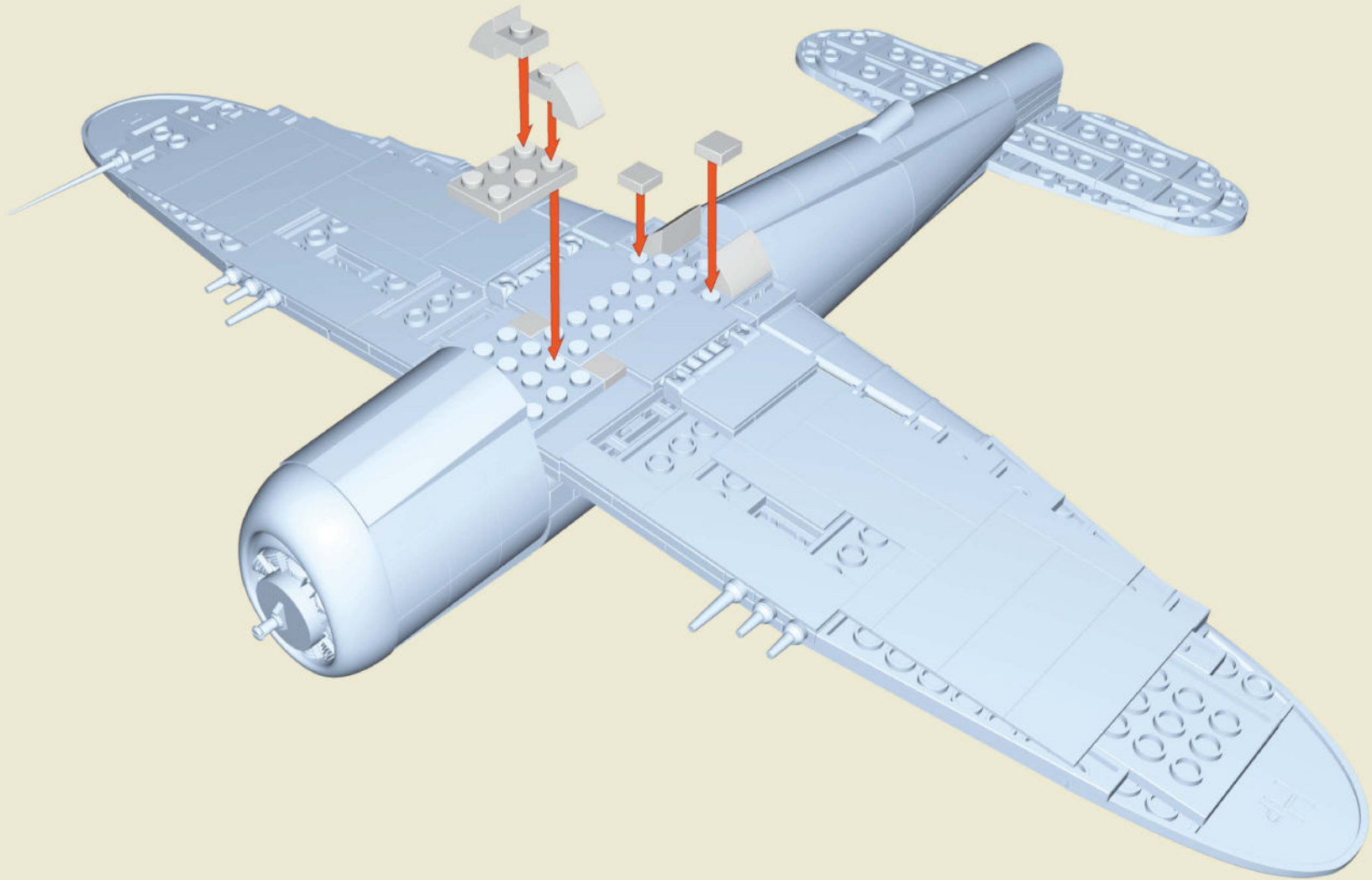

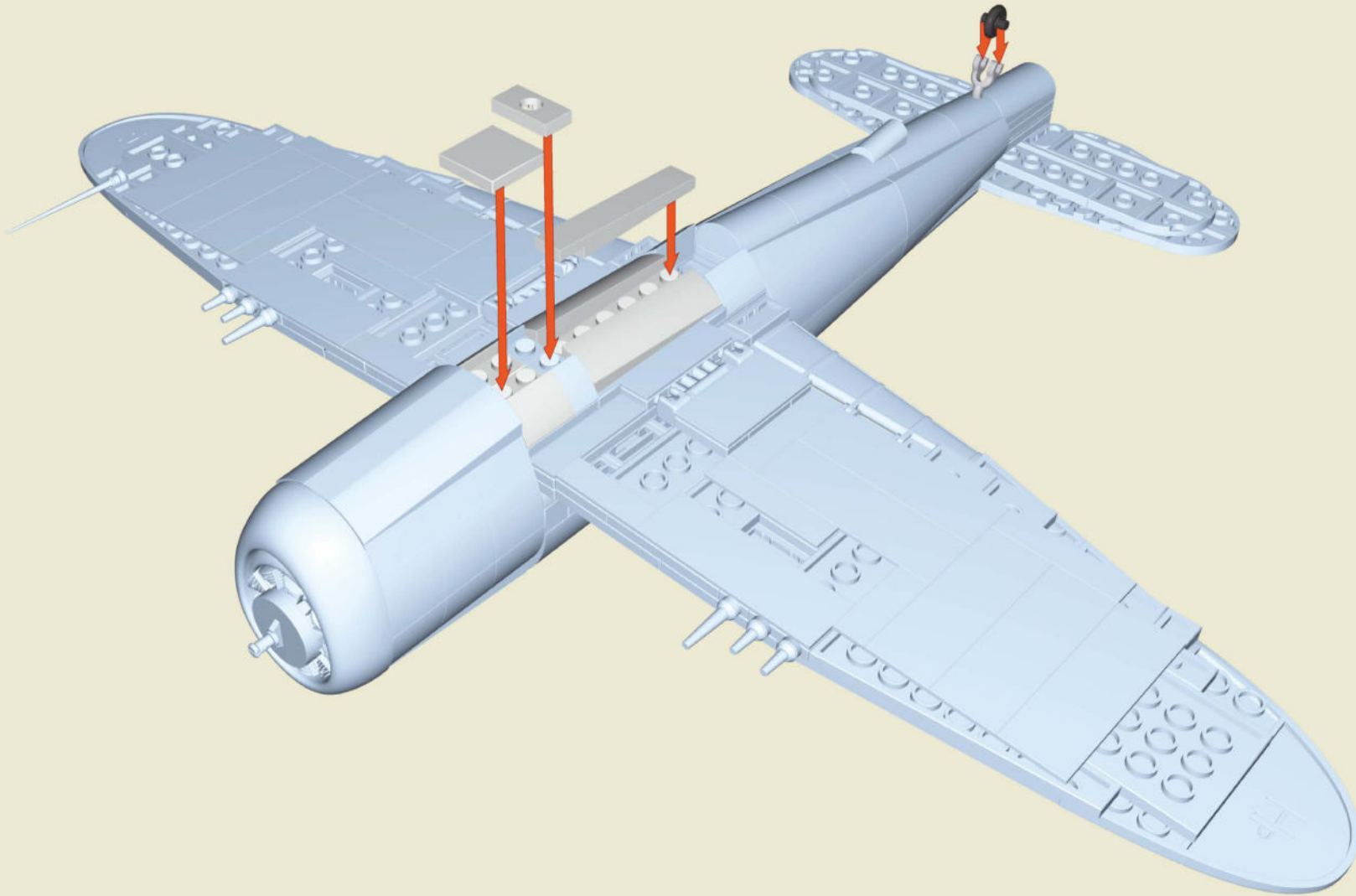

x2



-  **x2**
-  **x4**
-  **x1**
-  **x2**



-  x2
-  x1
-  x1
-  x1
-  x1
-  x1
-  x1

61

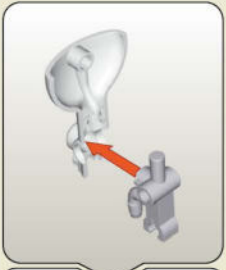
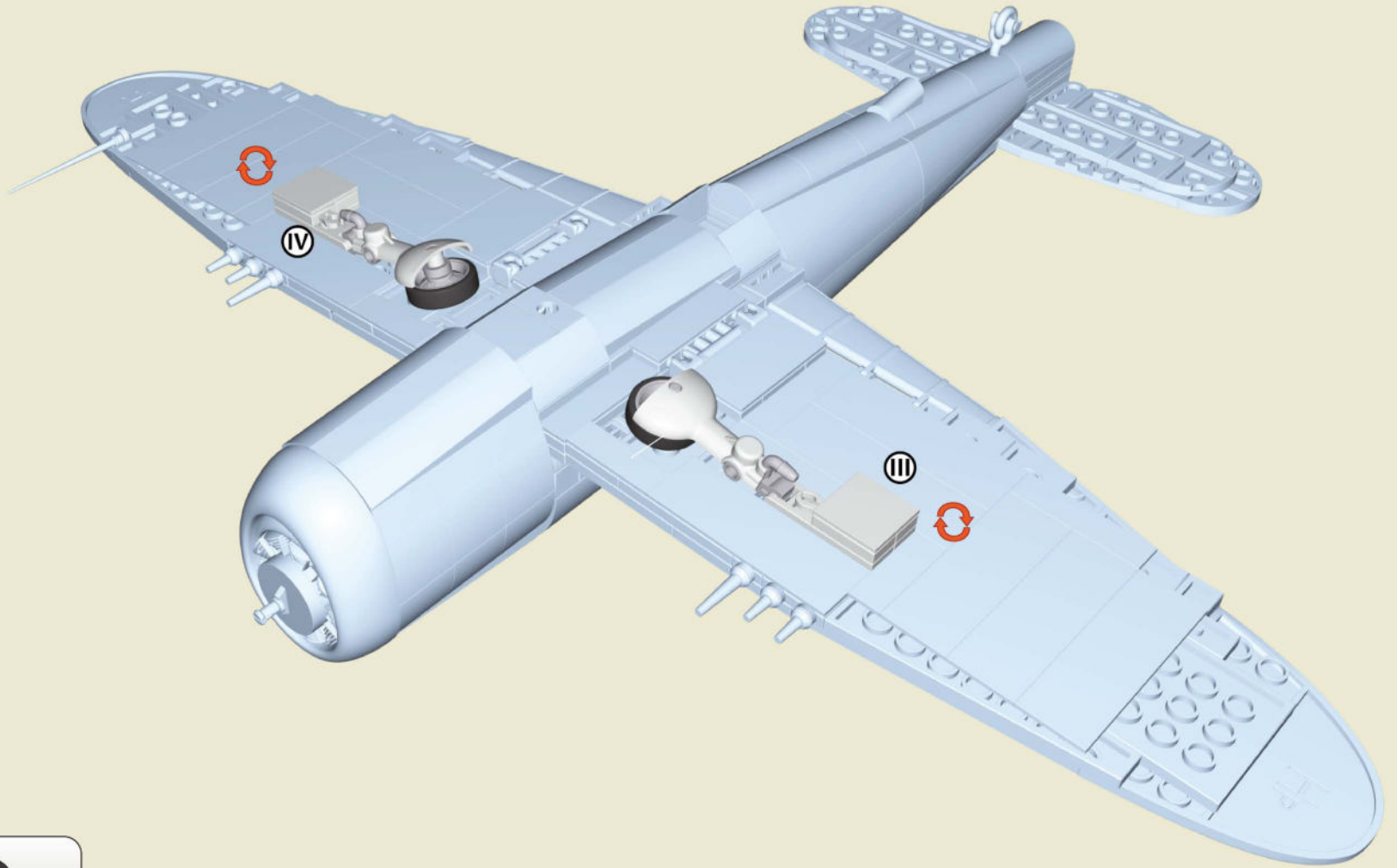

x2

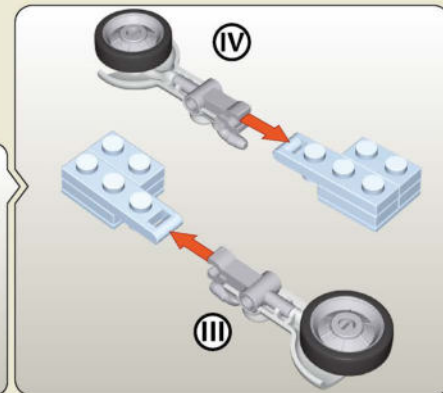
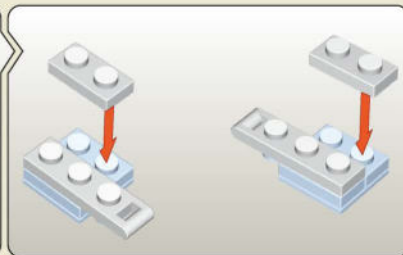
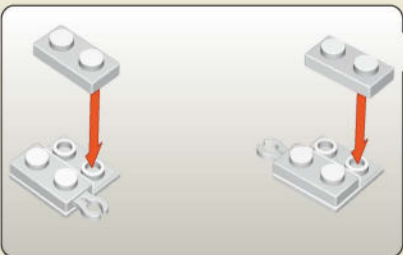

x2	x2	x4	x2	x2
x2	x2	x2	x2	

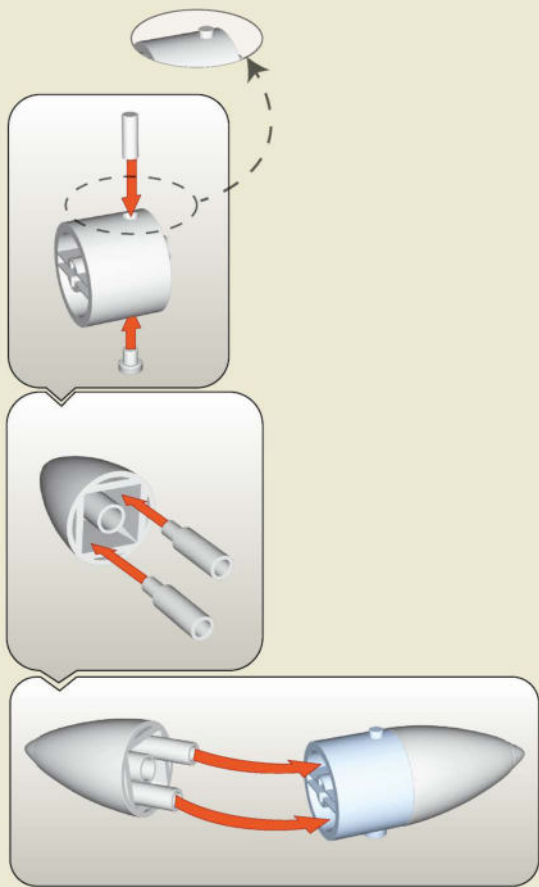
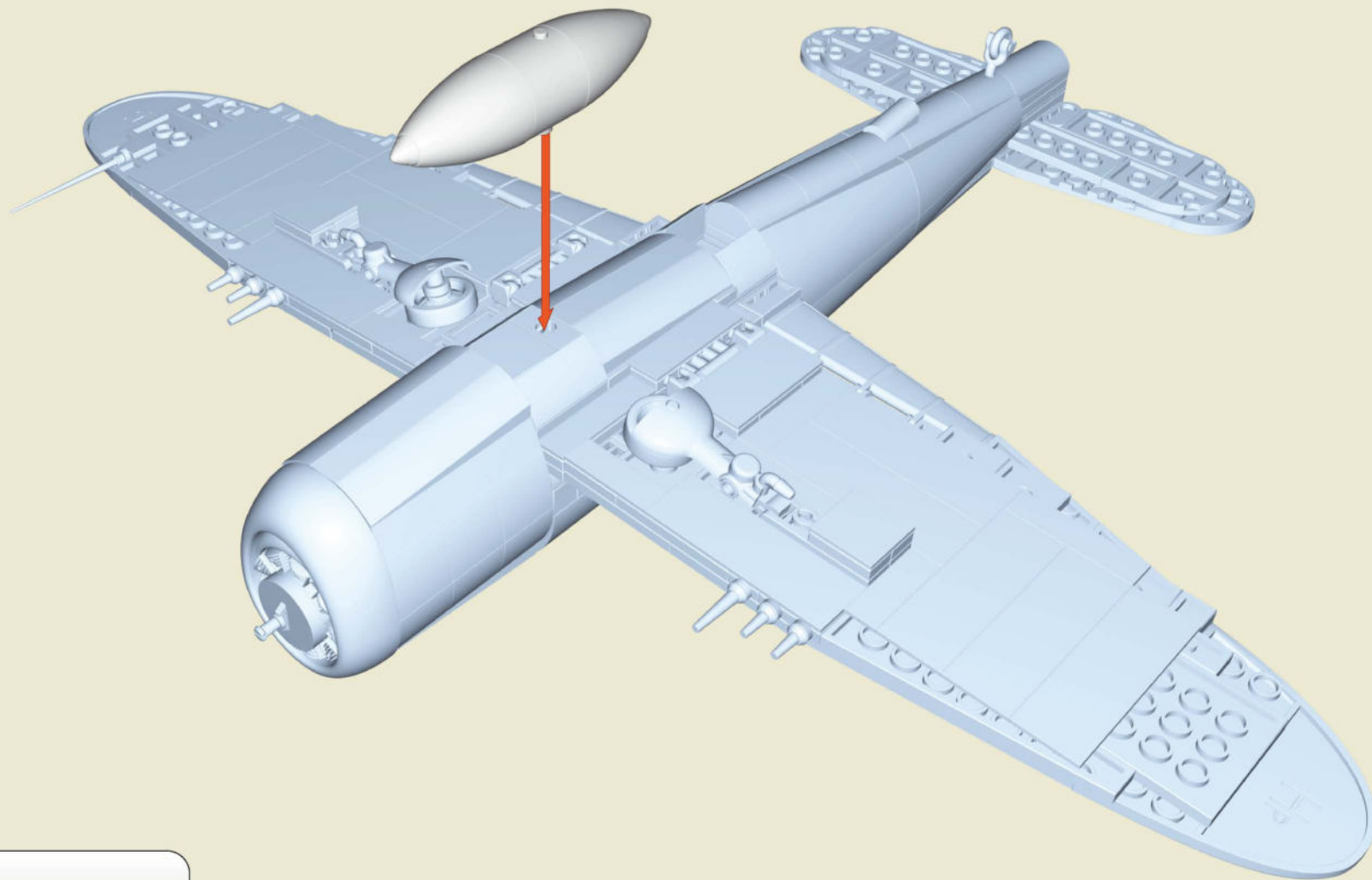

-  x1
-  x1
-  x1
-  x2
-  x2

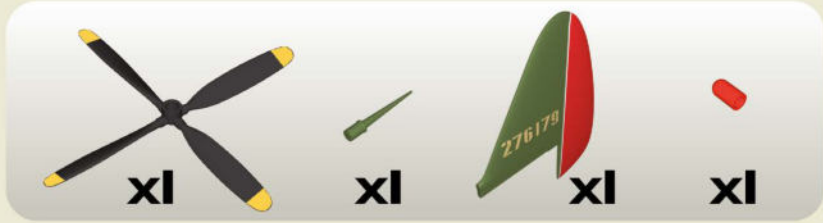
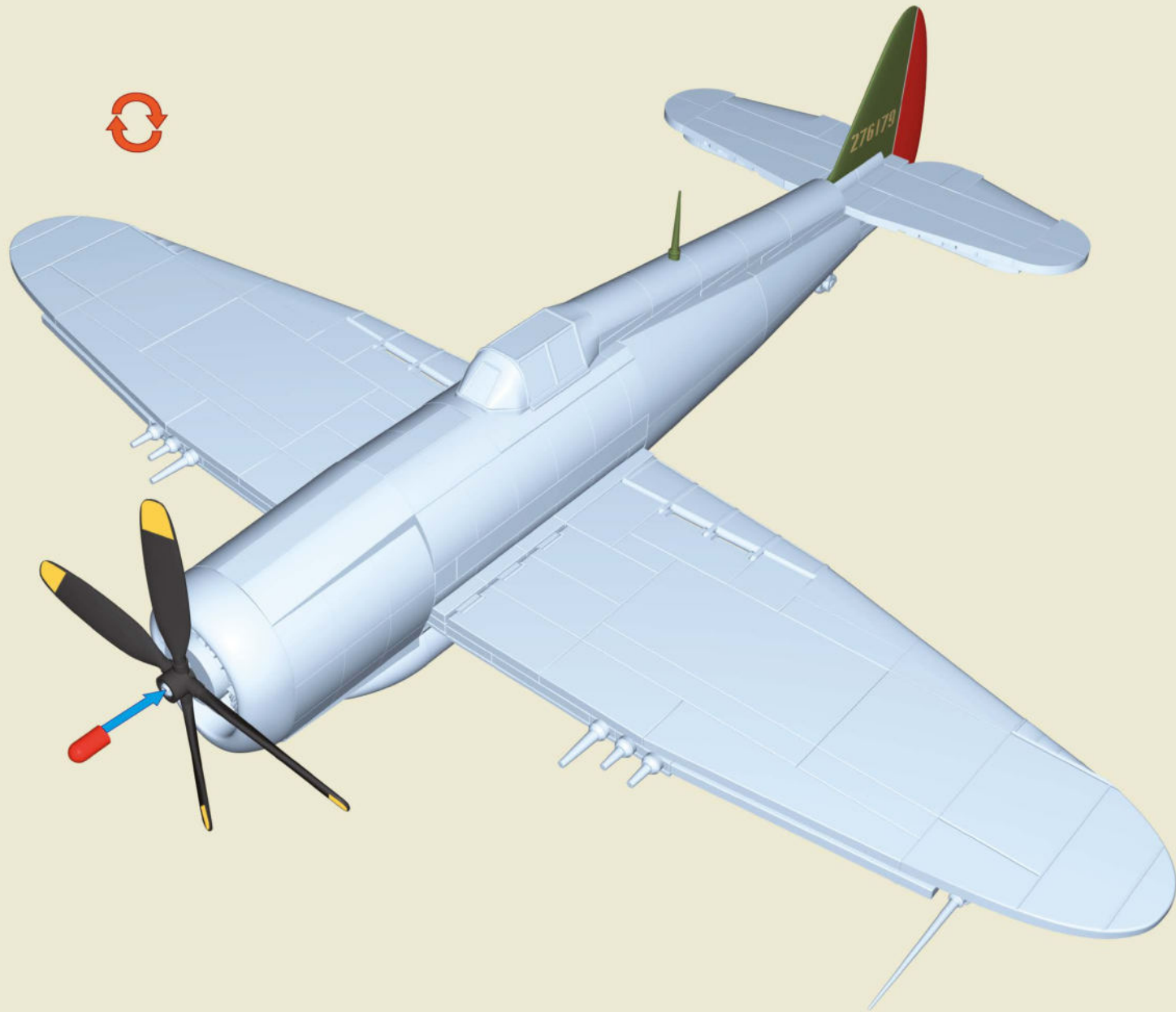

64

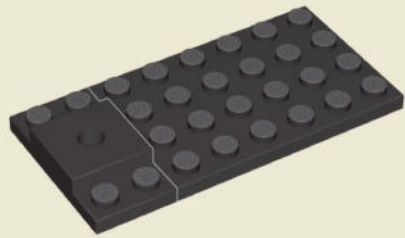

65

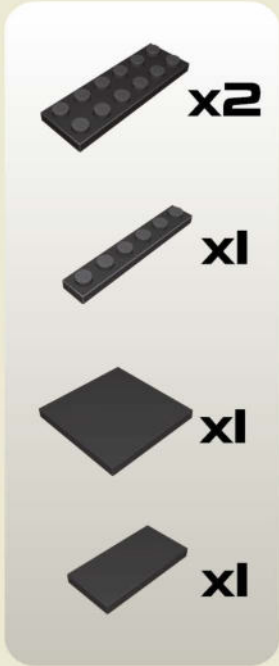
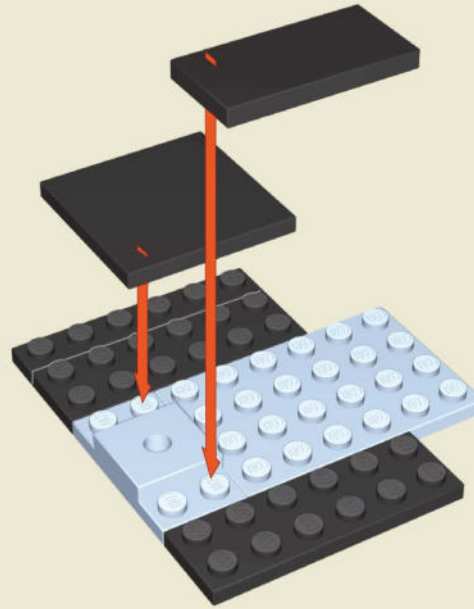

66

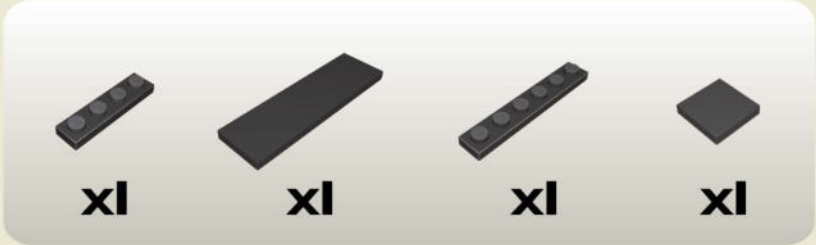
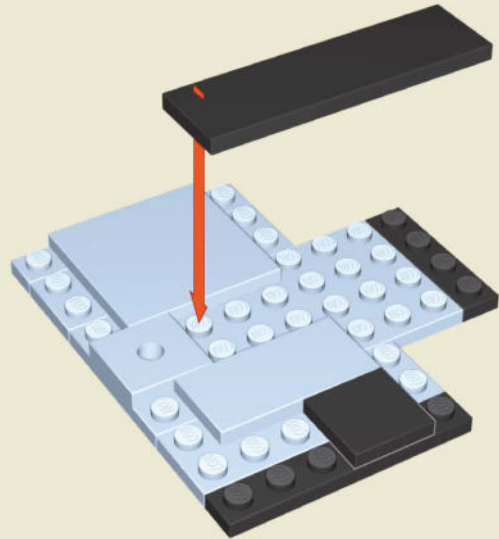

67

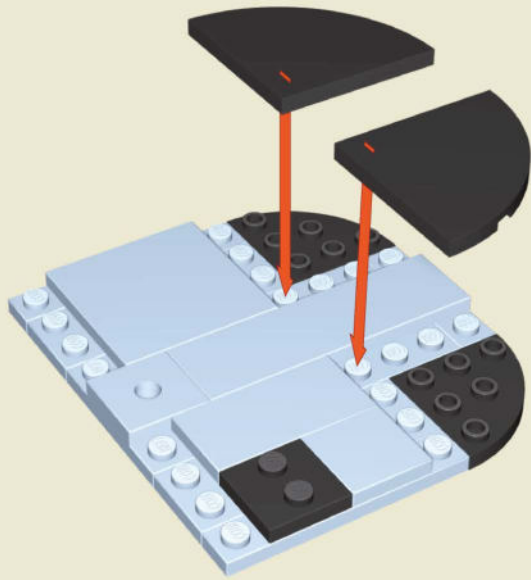

68

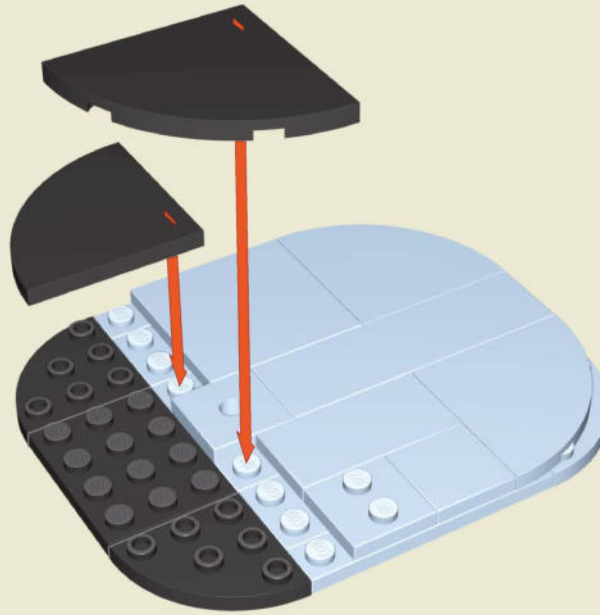

69

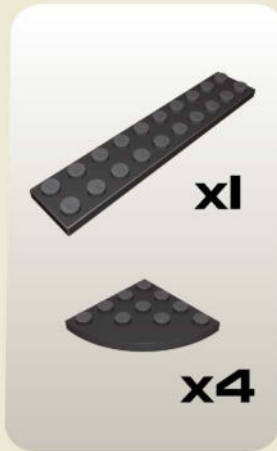
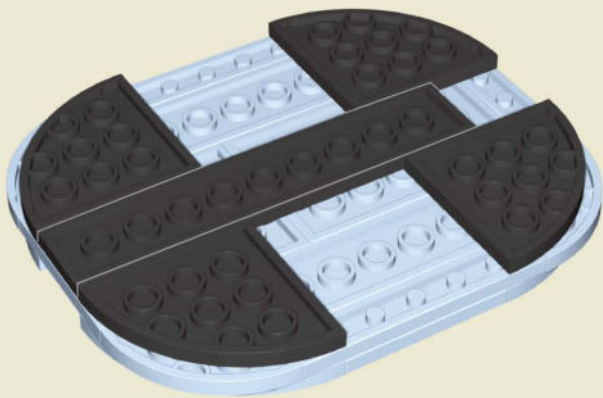

70



1:1

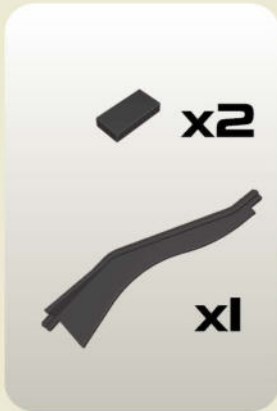
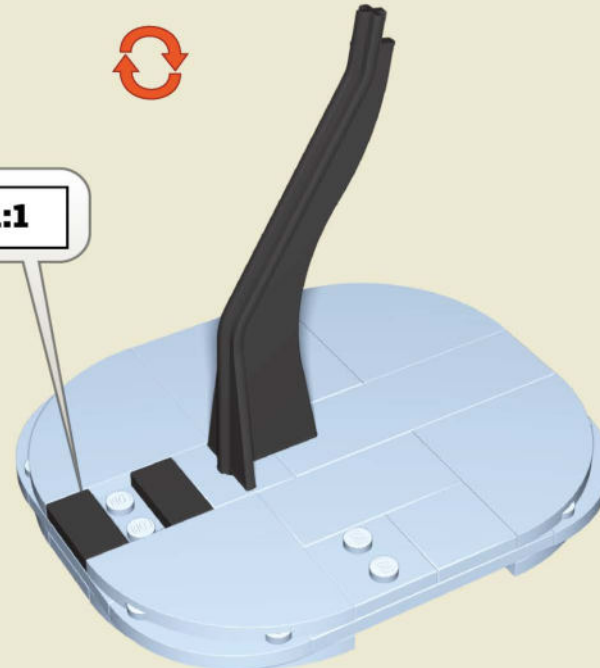

71

x2 x1 x1

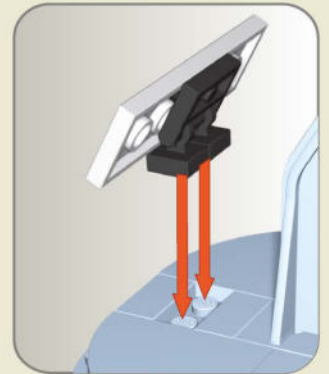
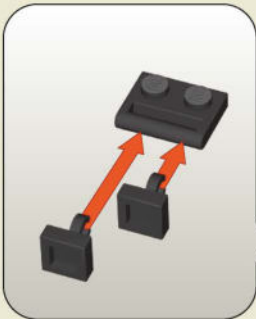
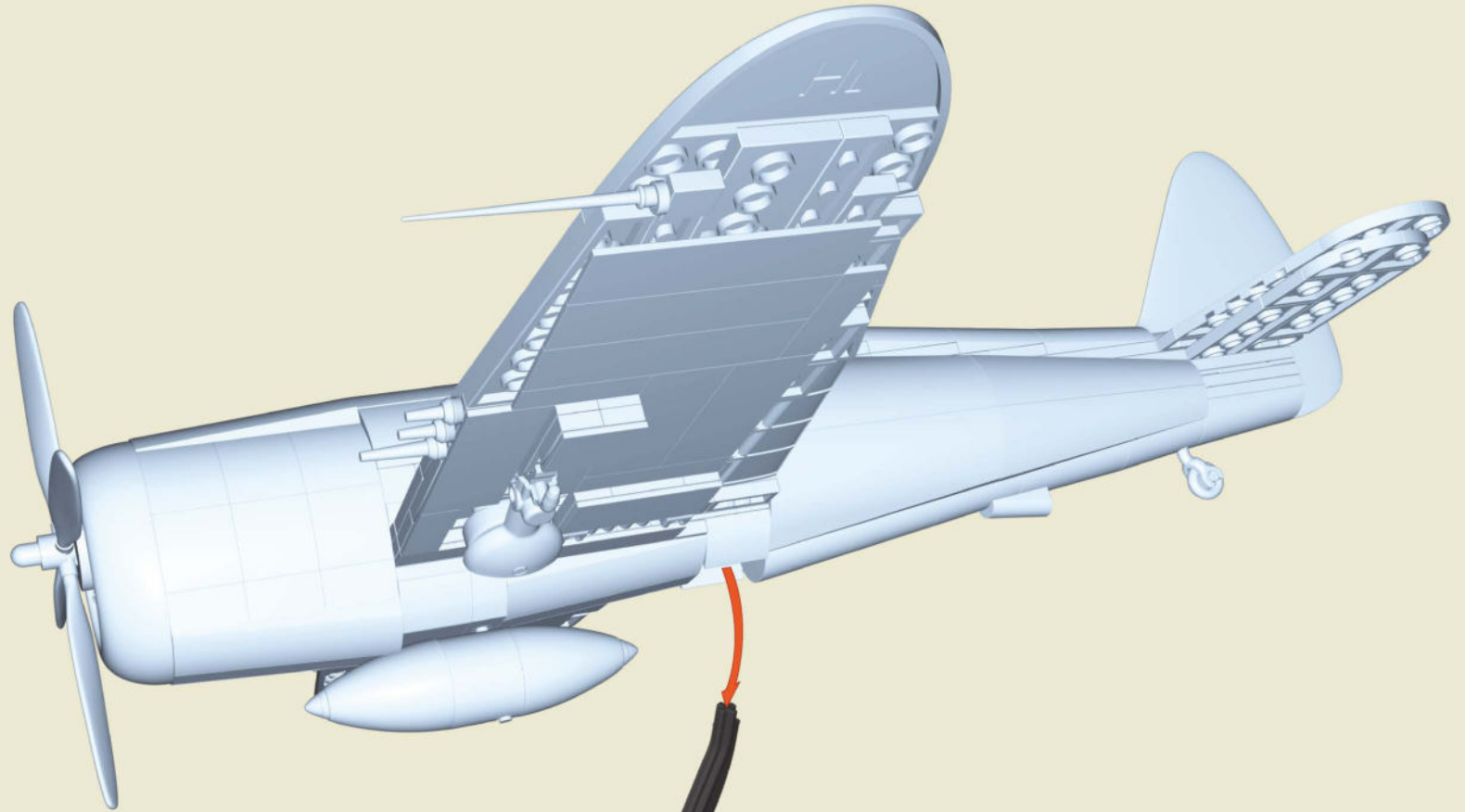

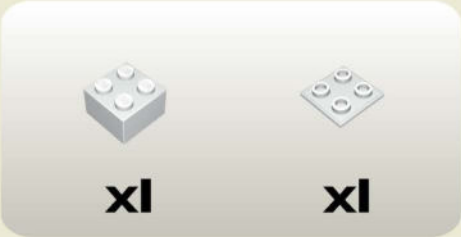
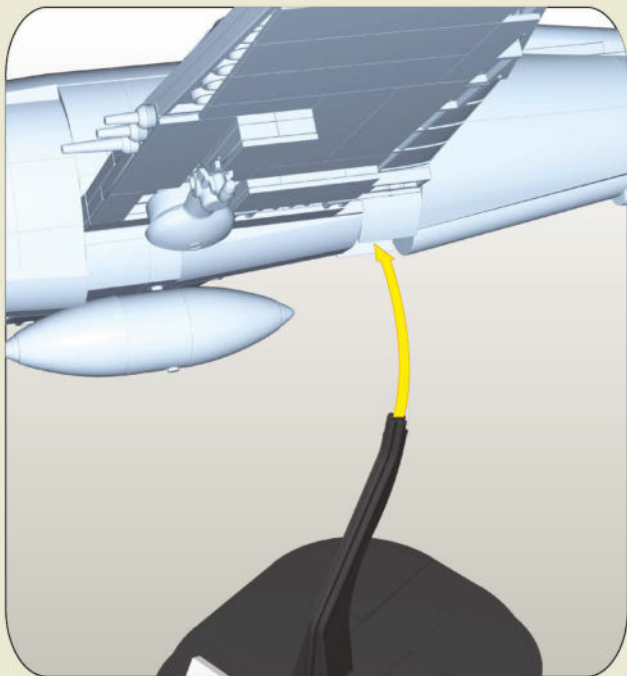
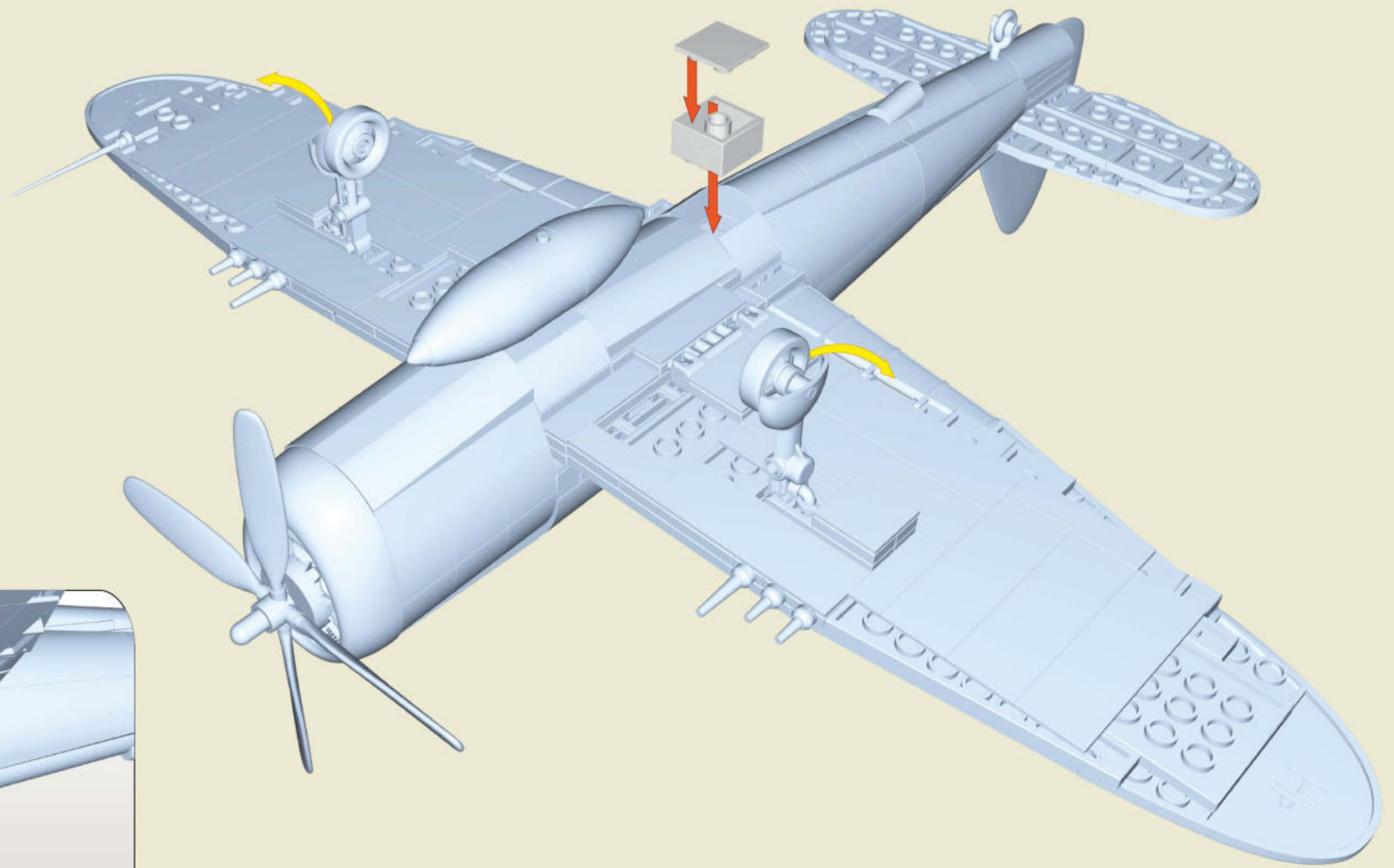

78

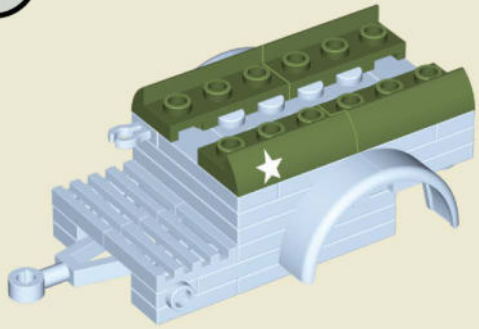

x1



x3

79

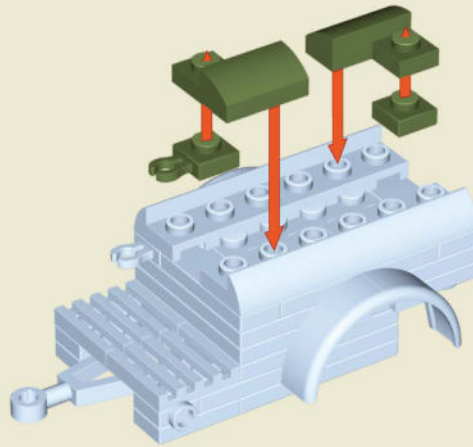

x1



x1



x2

80

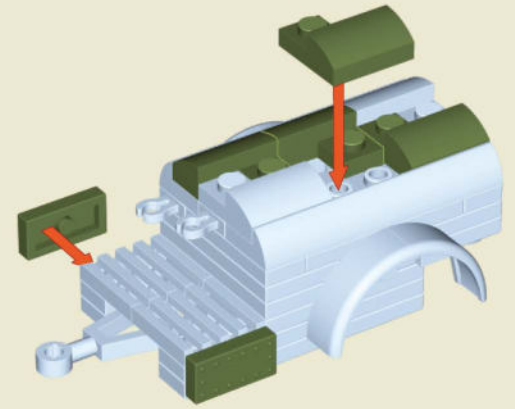

x4



x2

81

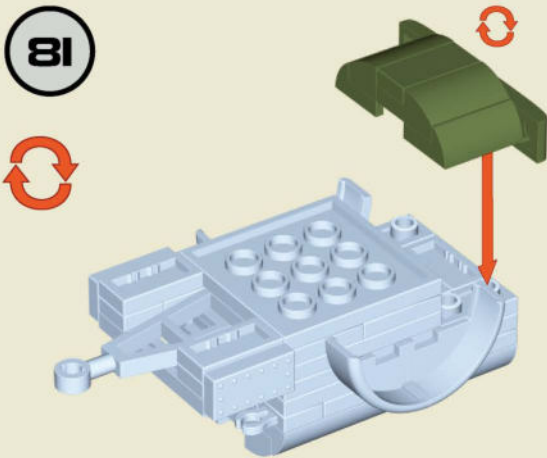

x1



x2



x1



x2



x1

1:1

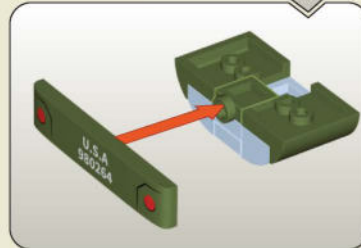
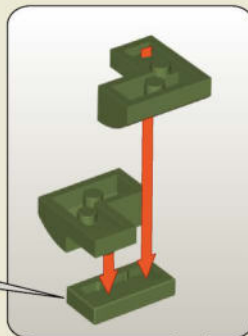

82

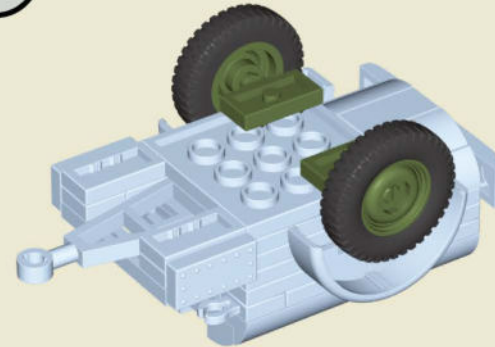

x2



x2



x2



x2

83

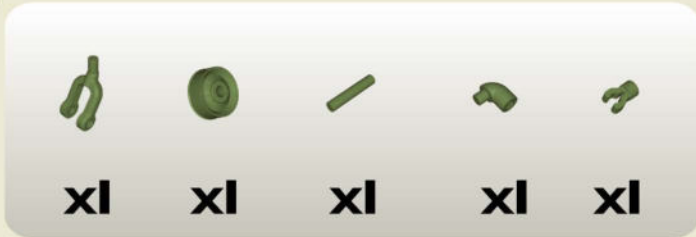
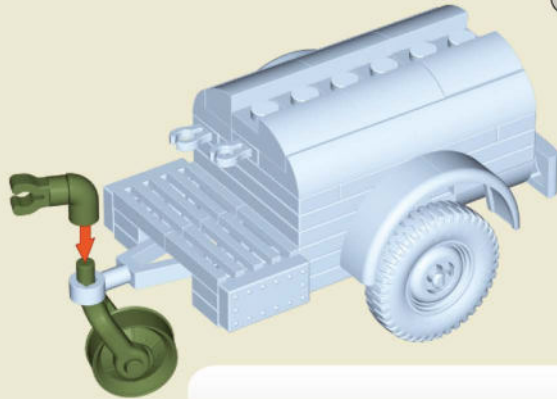
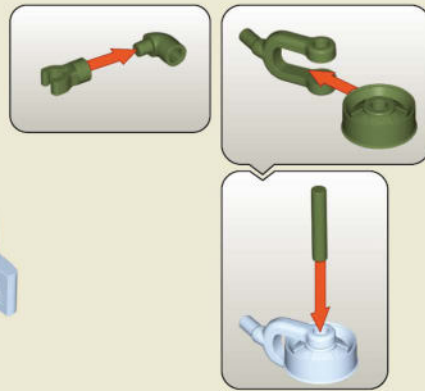

84

1:1

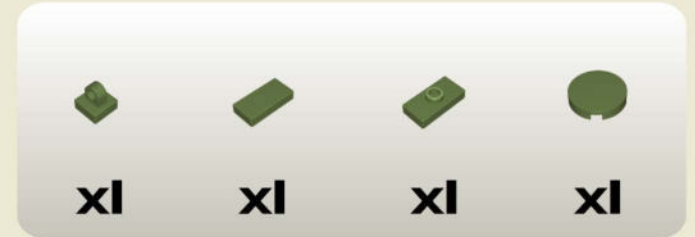
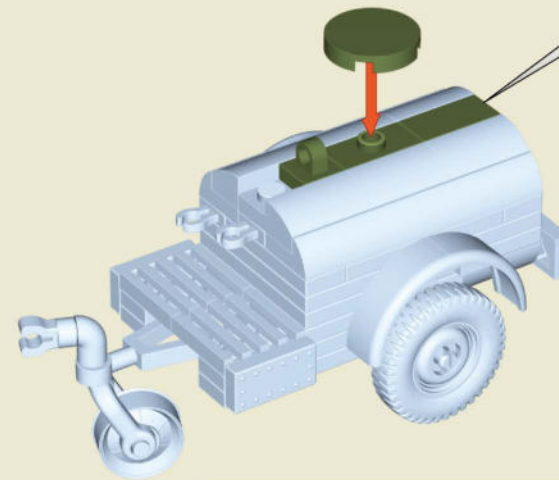

85

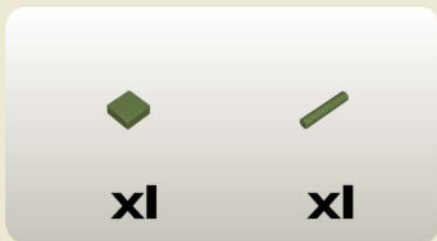
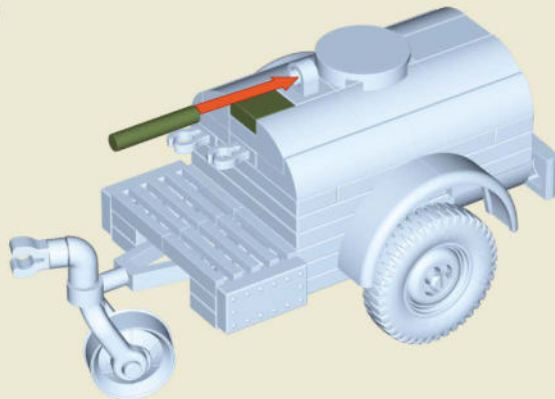

86

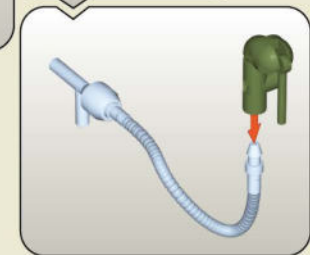
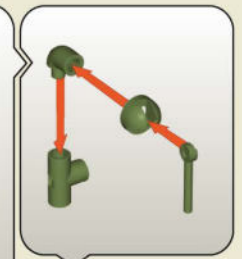
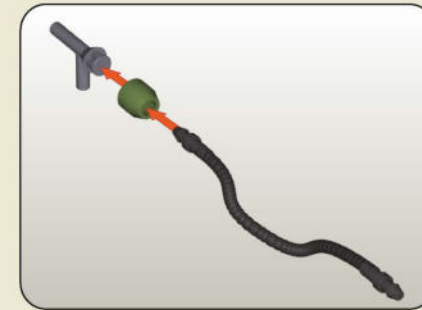
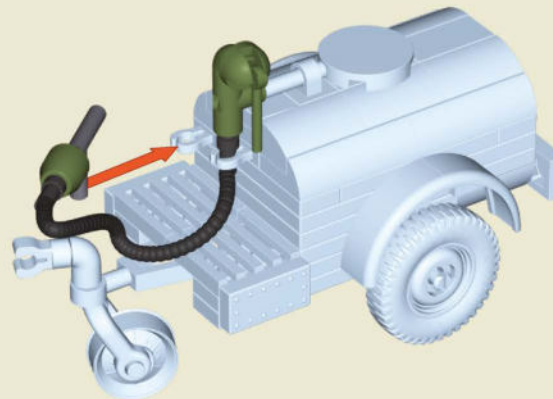





DEWOITINE D.520
🇫🇷 5734

HISTORICAL COLLECTION



F4U-4™ CORSAIR®
★ 2417



NORTHROP GRUMMAN



JUNKERS JU-88
✚ 5733



De HAVILLAND D.98 MOSQUITO
🇬🇧 5735

For news and special deals

WWW.COBIBRICKS.EU

01-05736-558

Find us on:
f cobibricks
cobi.klocki
📺 COBI SA