

HISTORICAL COLLECTION

WORLD WAR II



P-47 THUNDERBOLT™
 IN SERVICE - 1942 - EARLY 50s
 PLACE OF ORIGIN - UNITED STATES
 ROLE - FIGHTER
 WINGSPAN - 12,5m (41')
 LENGTH - 11m (36')
 HEIGHT - 4,5m (14' 8")
 EMPTY WEIGHT - 4540kg (10,000LB)
 ENGINE - PRATT&WHITNEY R-2800-59,
 2000HP (1500kw)
 RANGE - ~1300km (800mi)
 RATE OF CLIMB - 15m/s (3200FT/MIN)
 MAXIMUM SPEED - 700km/h (433MPH)
 MAXIMUM FLIGHT LEVEL - 13km (42,000FT)
 ARMAMENT - 8x 12,7mm (.50")
 BROWNING M2
 CREW - 1

5737

**NORTHROP
GRUMMAN**

P-47 Thunderbolt™ is a trademark of Northrop Grumman Systems Corporation and are used under license by COBI.

**PAD PRINTED
NO STICKERS**

Printed in EU



WARNING: CHOKING HAZARD-
 Toy contains small parts.
 Not for children under 3 years.

477 1

P-47 THUNDERBOLT™

SCALE 1:32



1

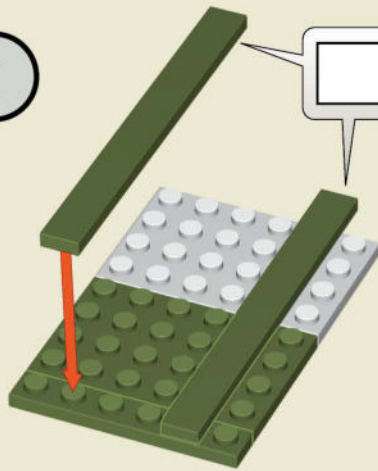

1:1

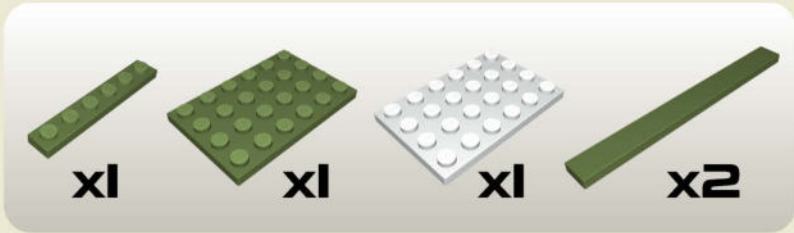

2

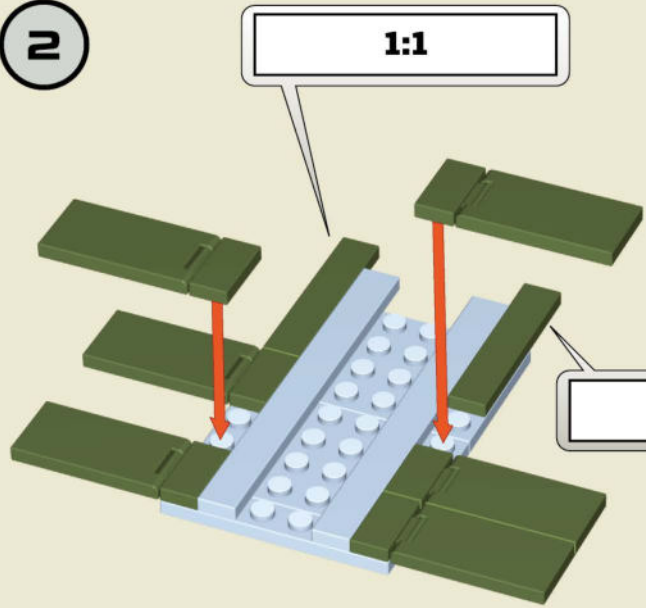

1:1

1:1

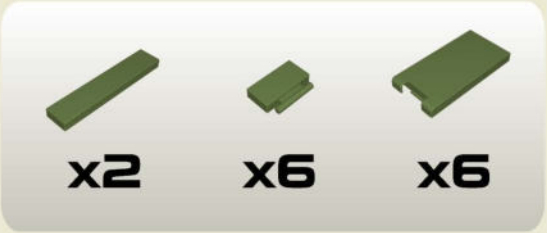
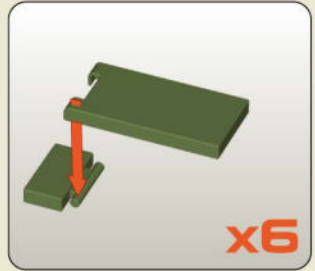

3

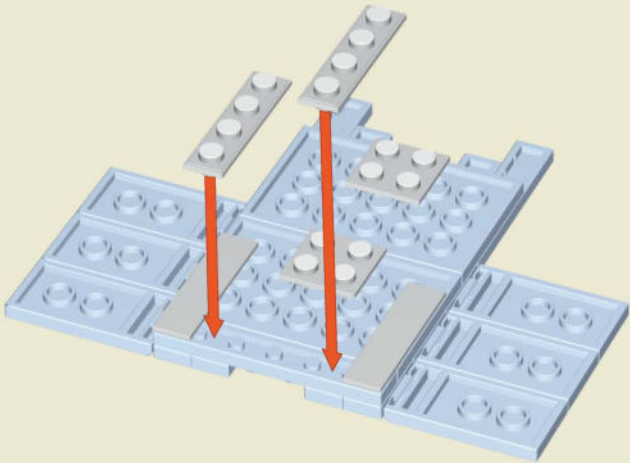

4

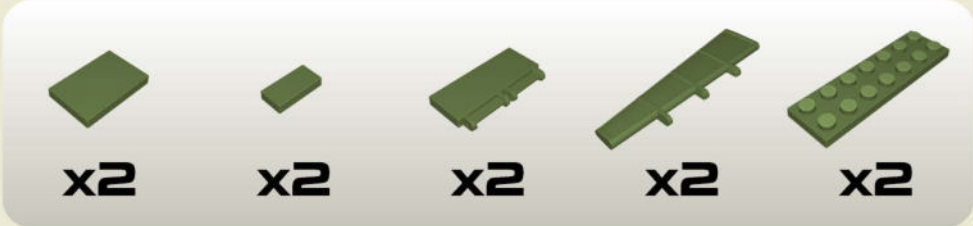
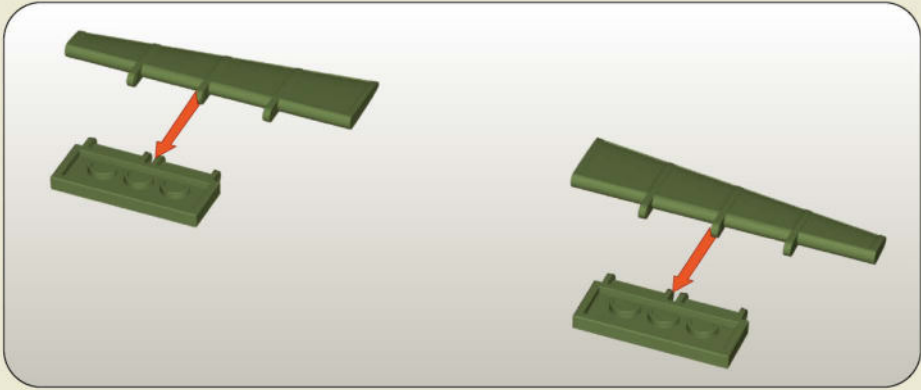
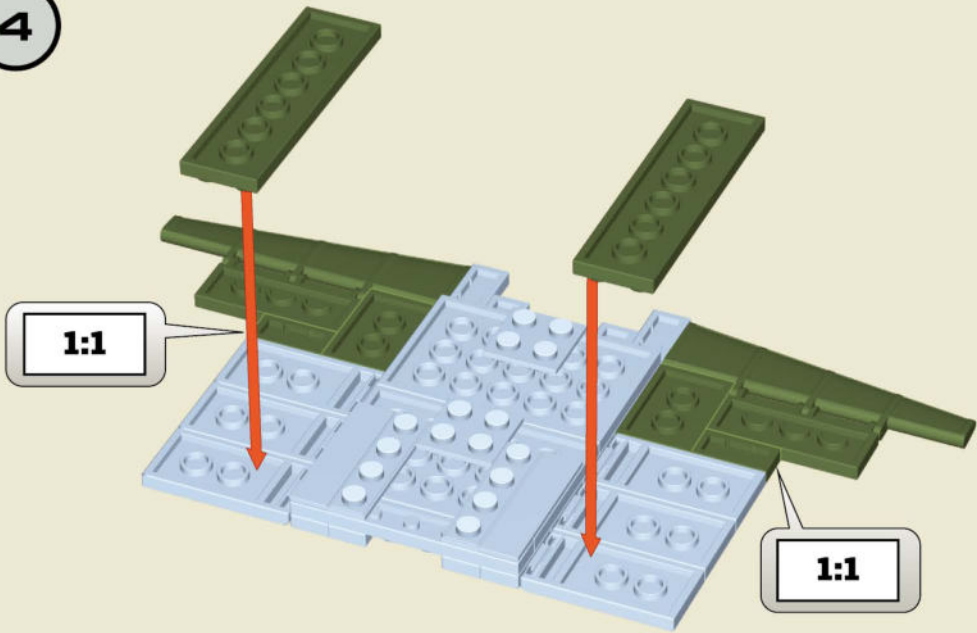



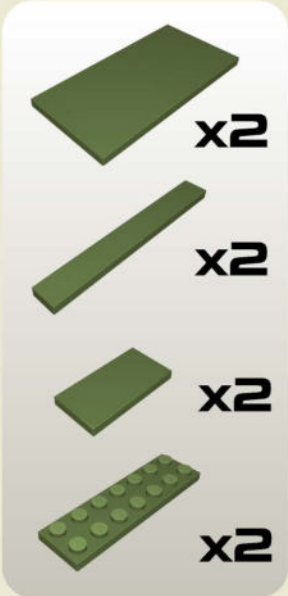
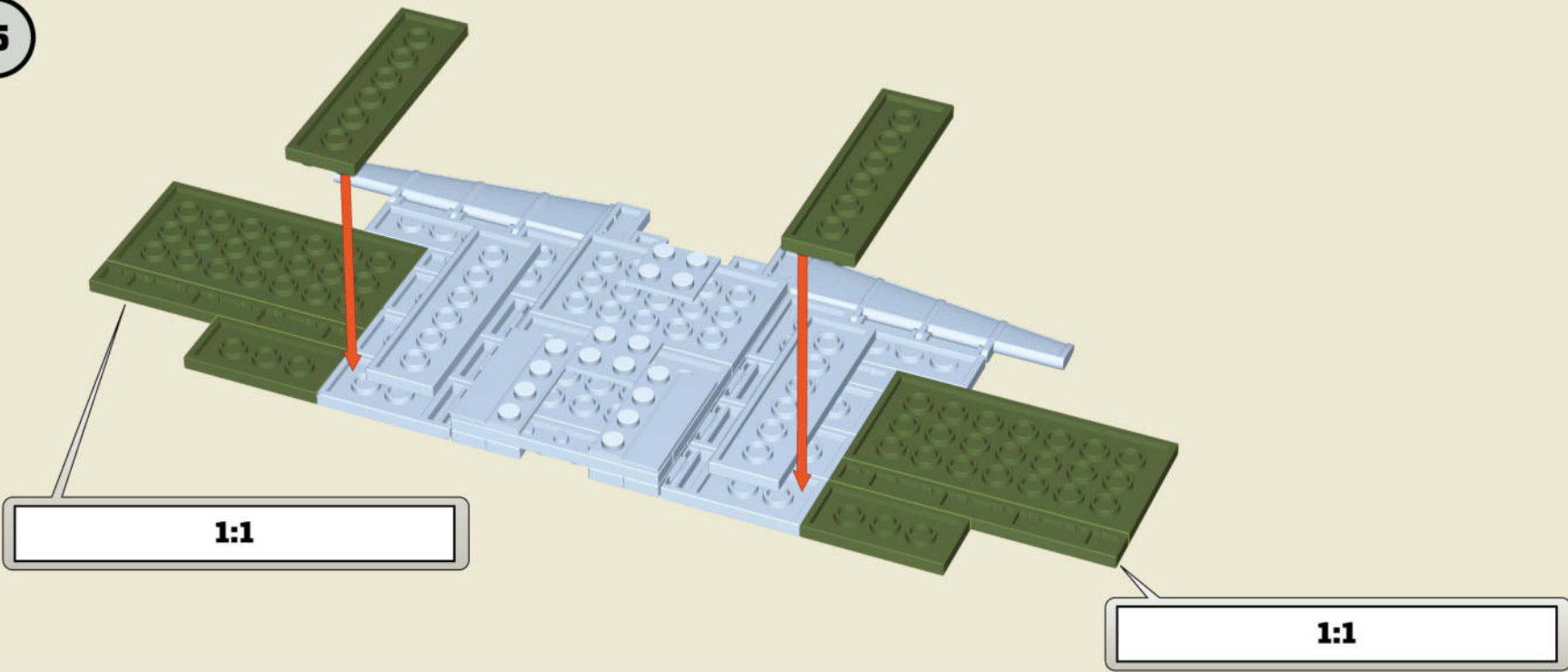

5

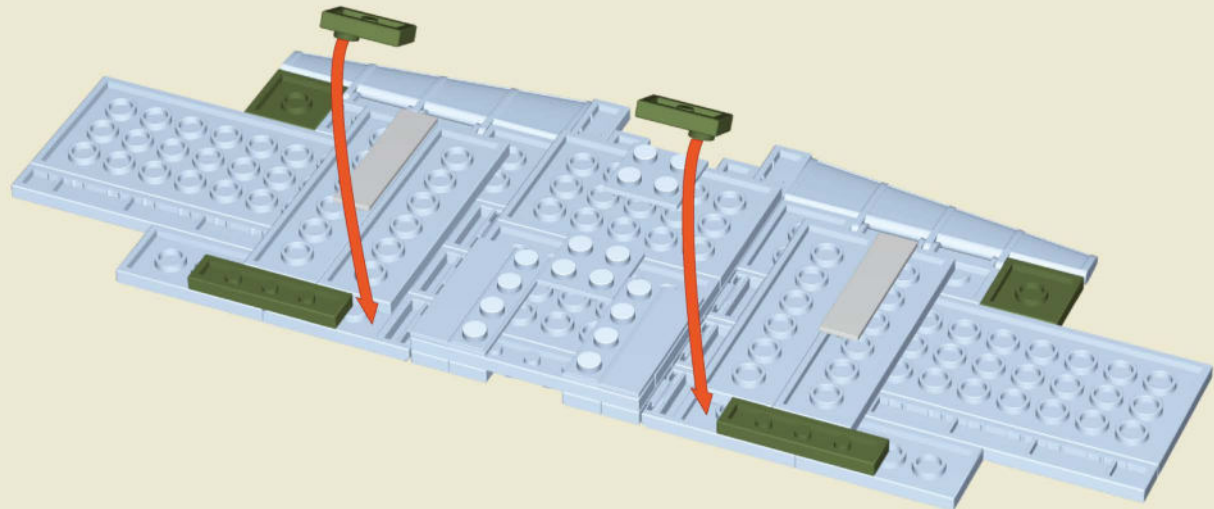

6



-  x2
-  x2
-  x2
-  x2

7

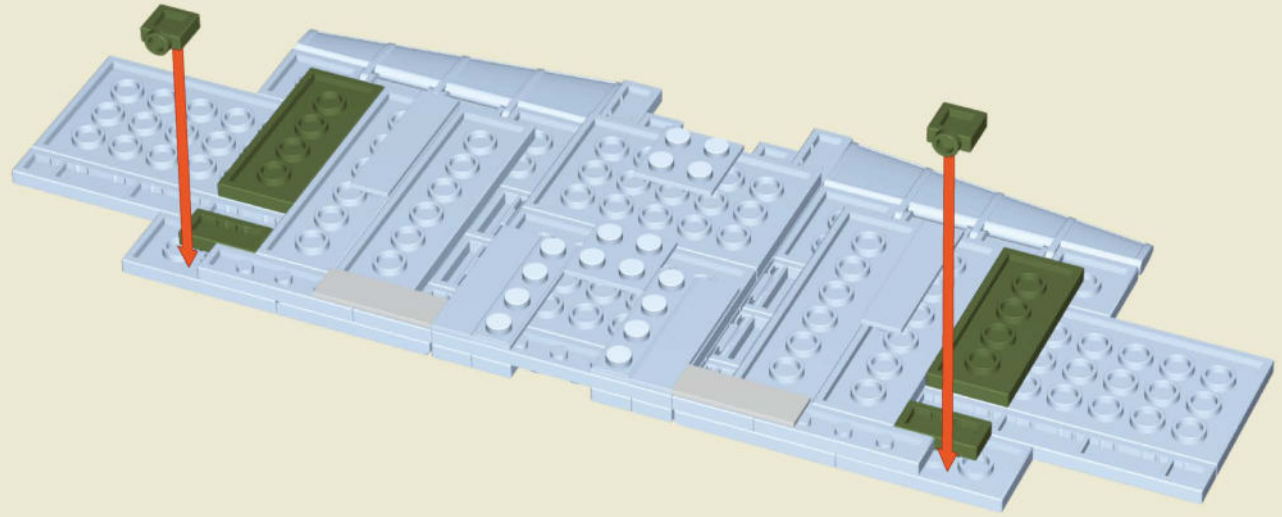



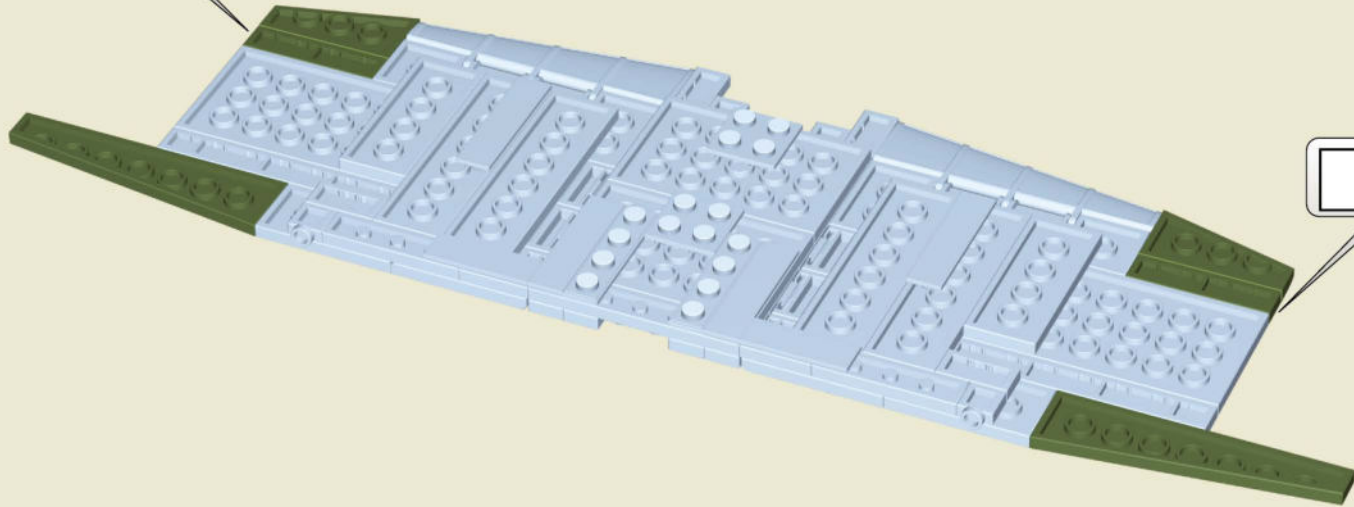

-  x2
-  x2
-  x2
-  x2

8

1:1





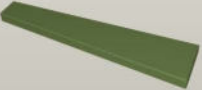

1:1

-  x1
-  x1
-  x2
-  x1
-  x1

9



-  x2
-  x2
-  x2
-  x2

10









1:1

1:1



-  x1
-  x1
-  x1
-  x2
-  x1
-  x6





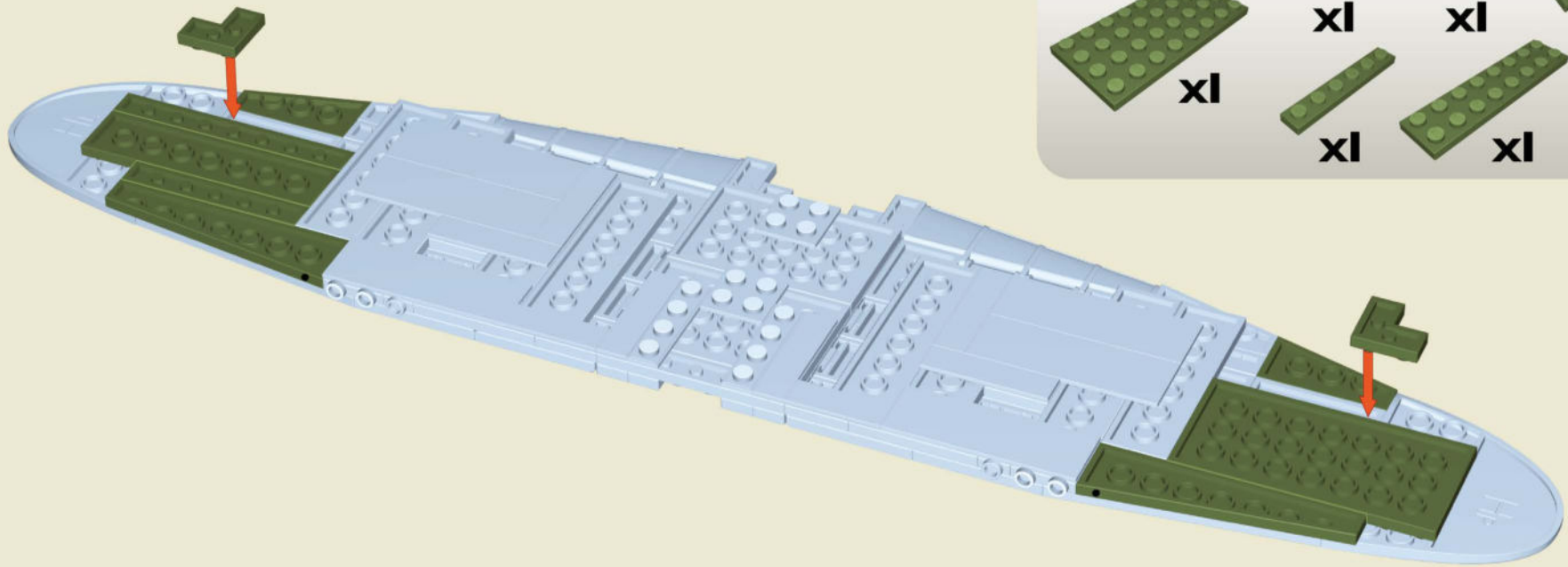

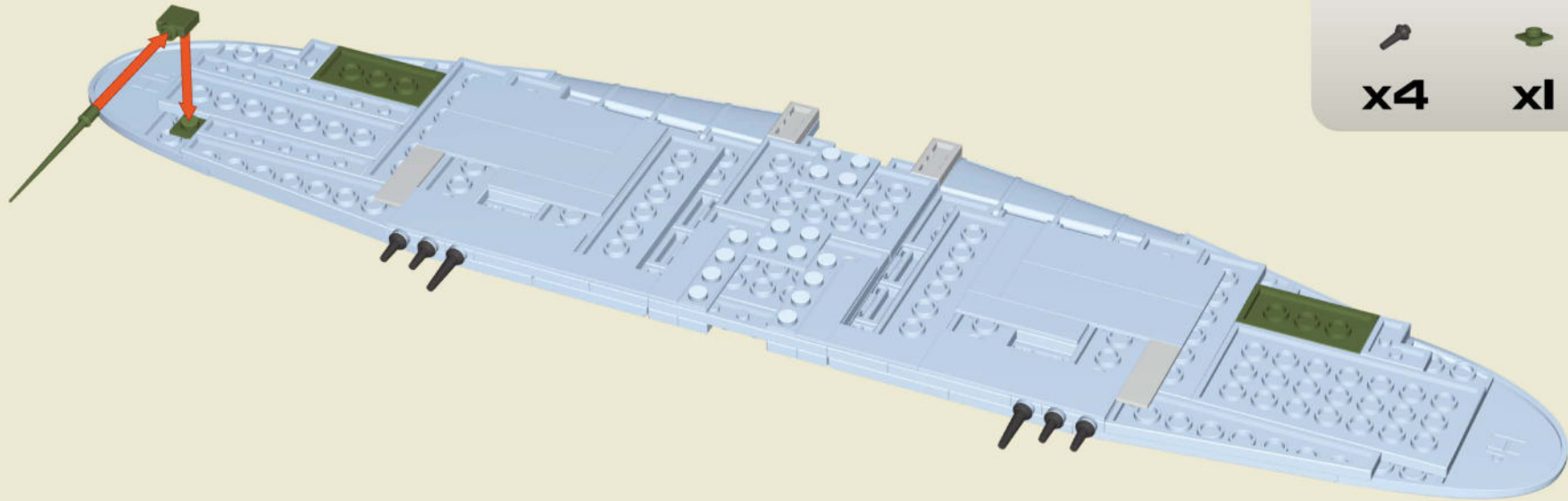

11

-  x1
-  x1
-  x1
-  x1
-  x1
-  x1
-  x1
-  x1
-  x2

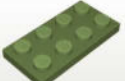

12



- | | | | |
|---|---|---|---|
|  |  |  |  |
| x2 | x2 | x2 | x2 |
|  |  |  |  |
| x4 | x1 | x1 | x1 |

13

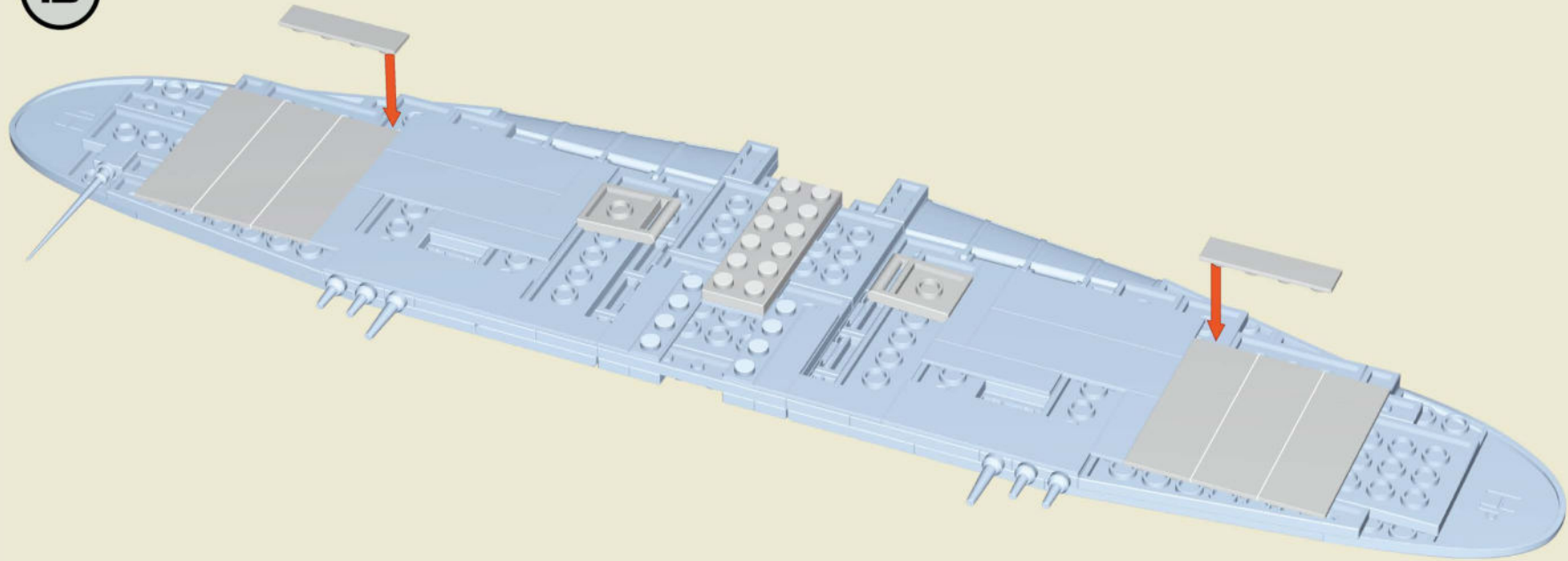

- | | |
|---|-----------|
|  | x1 |
|  | x2 |
|  | x6 |
|  | x2 |

14

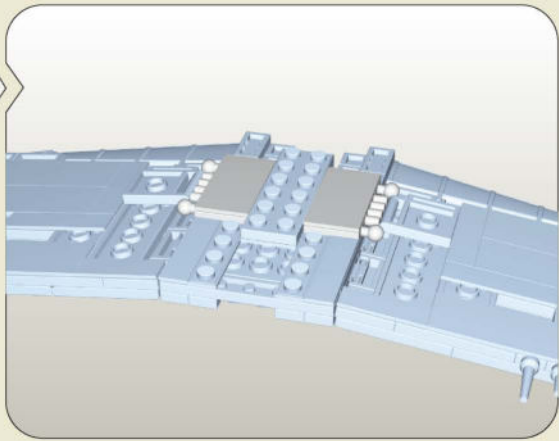
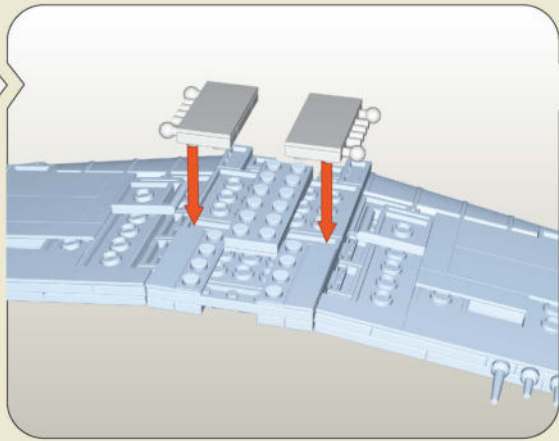
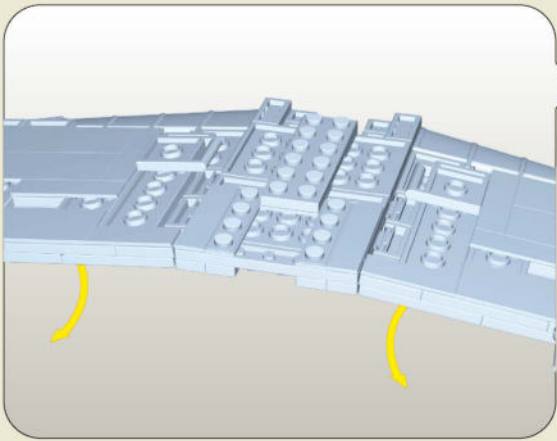

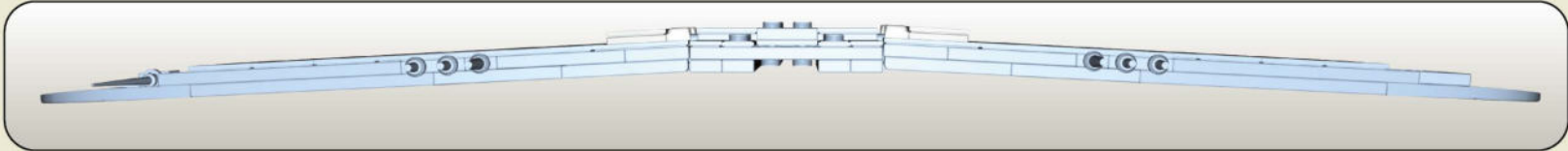
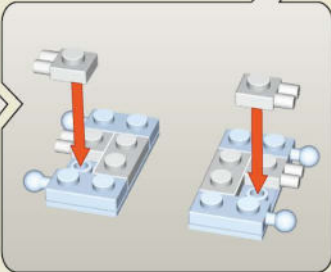
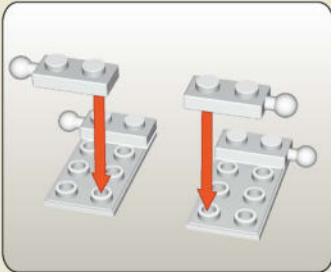
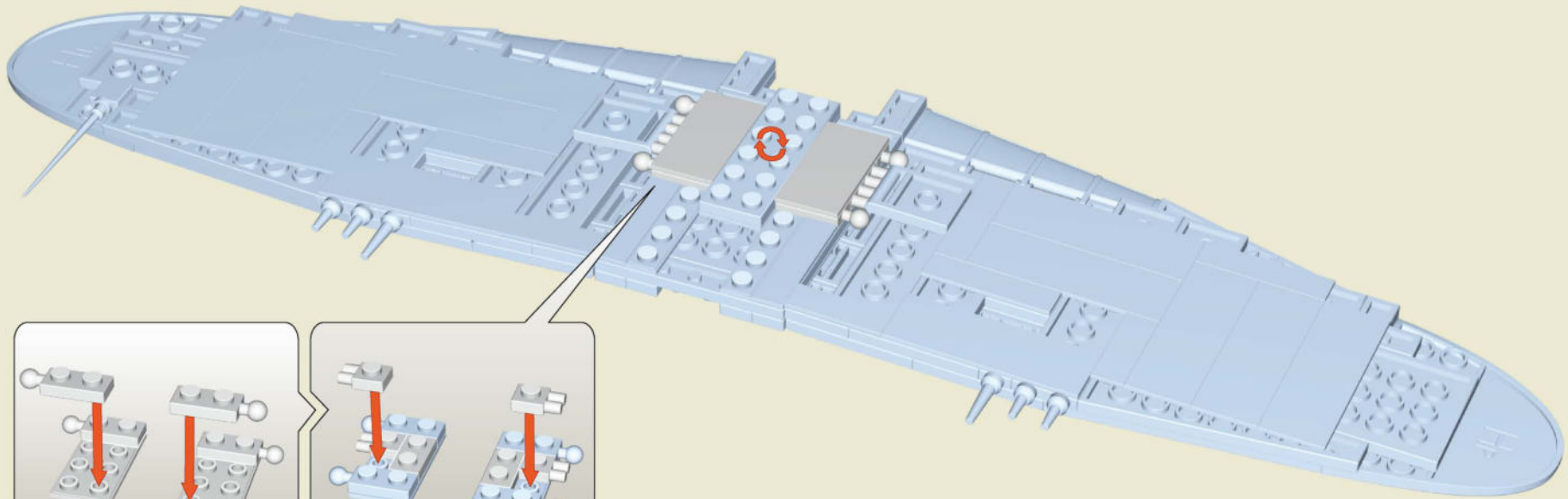

-  x2
-  x4
-  x4
-  x2

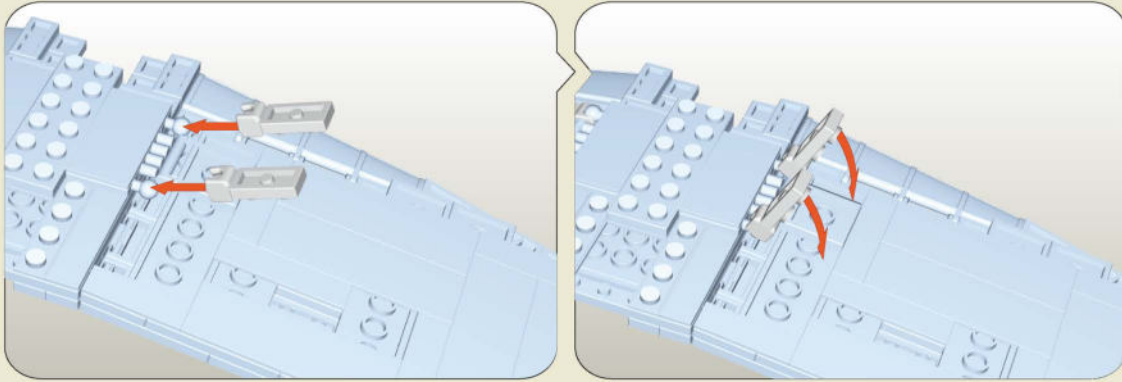

15



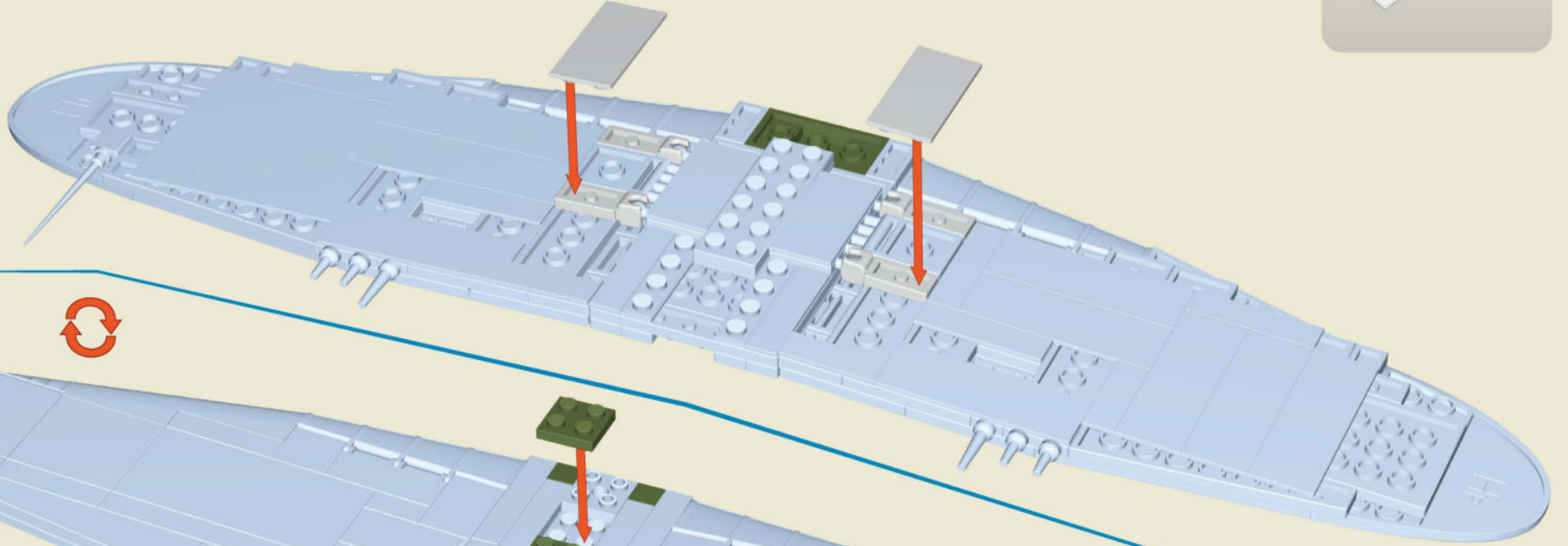

-  **x4**
-  **x1**
-  **x2**

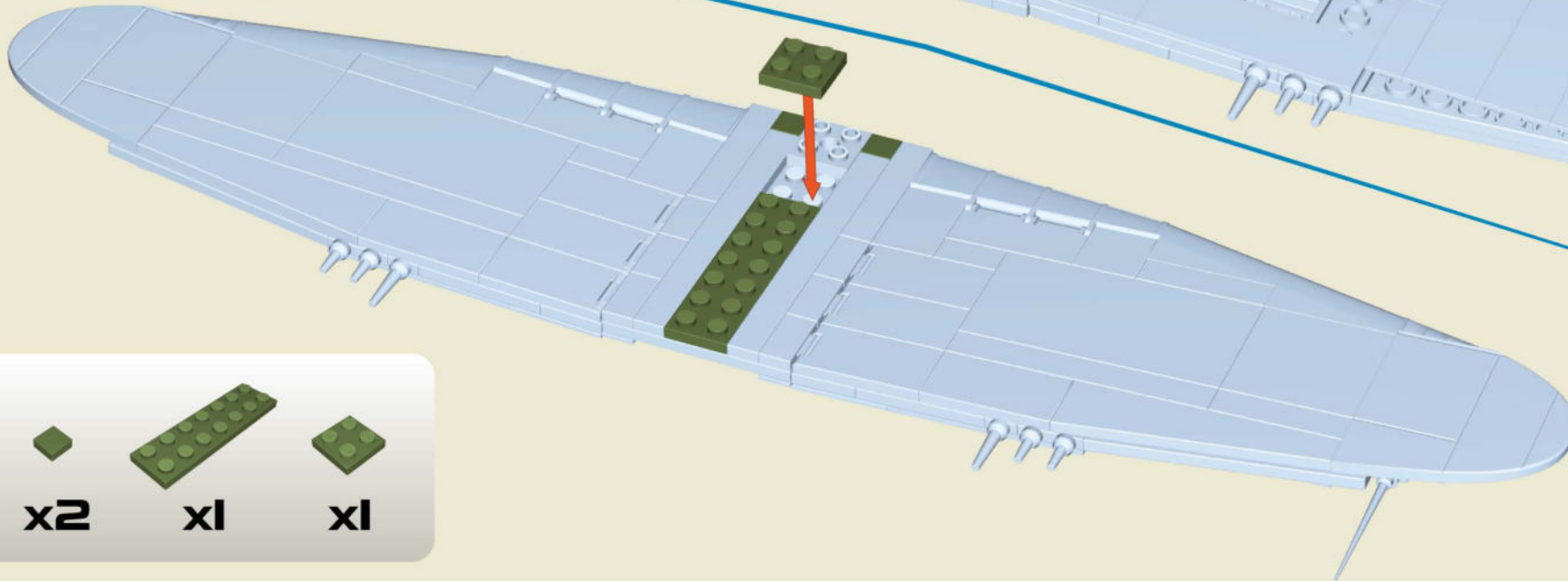

16



-  **x2**
-  **x1**
-  **x1**

17

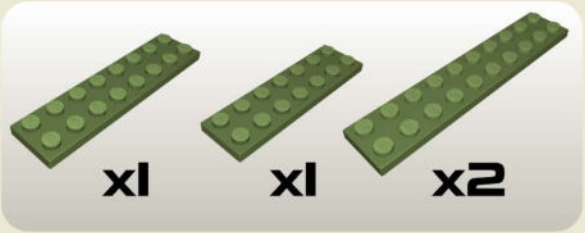
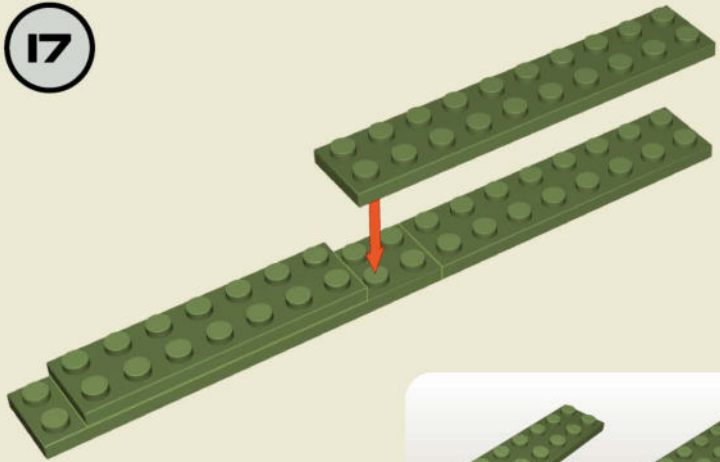

18

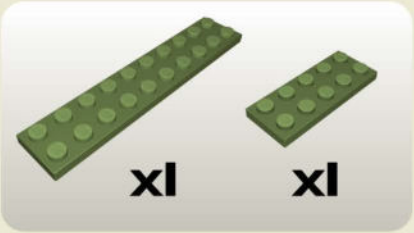
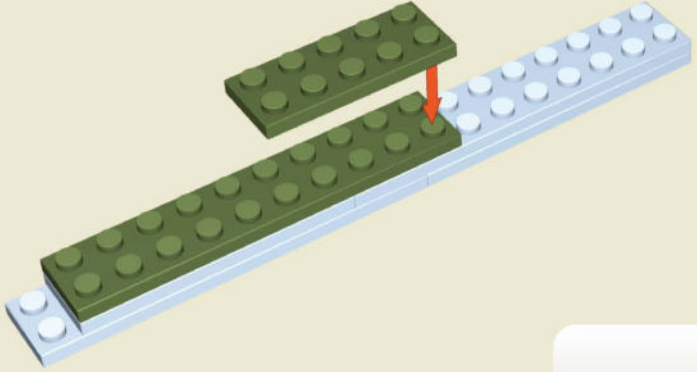

19

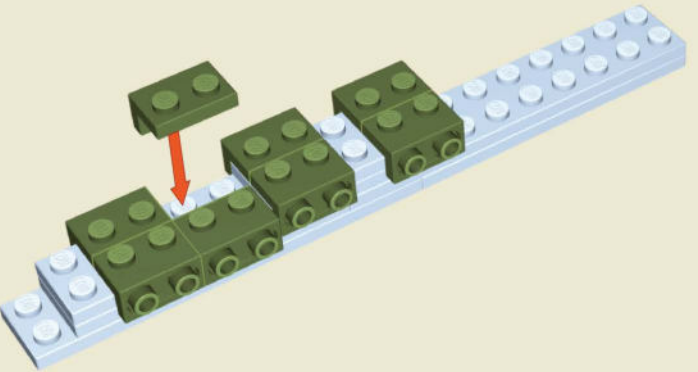

20

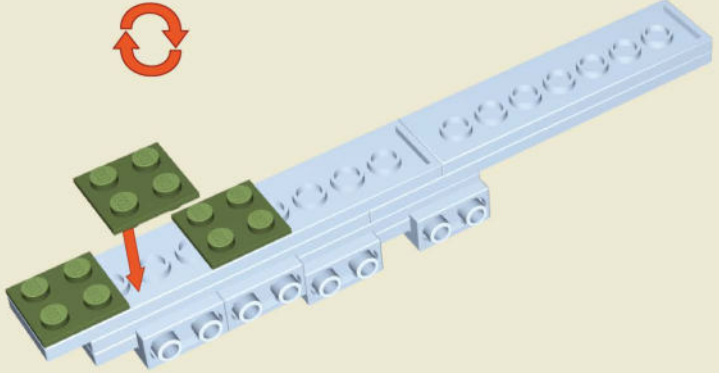

21

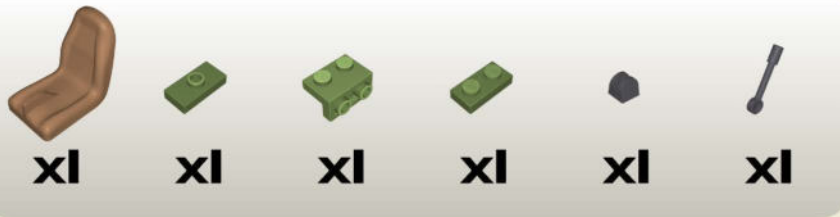
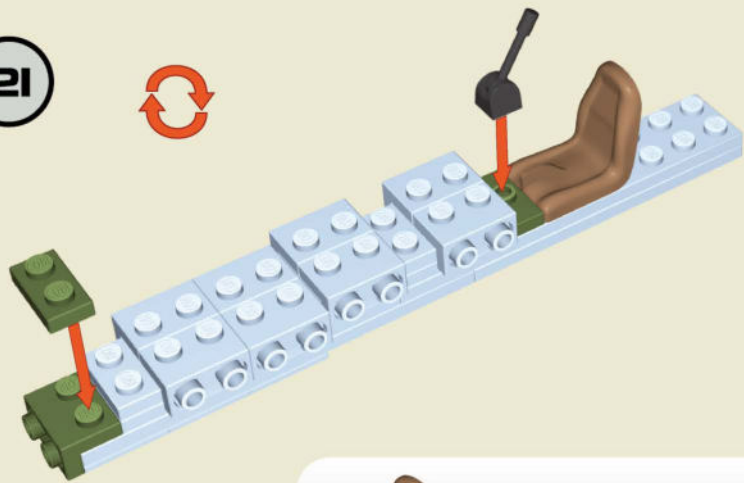

22

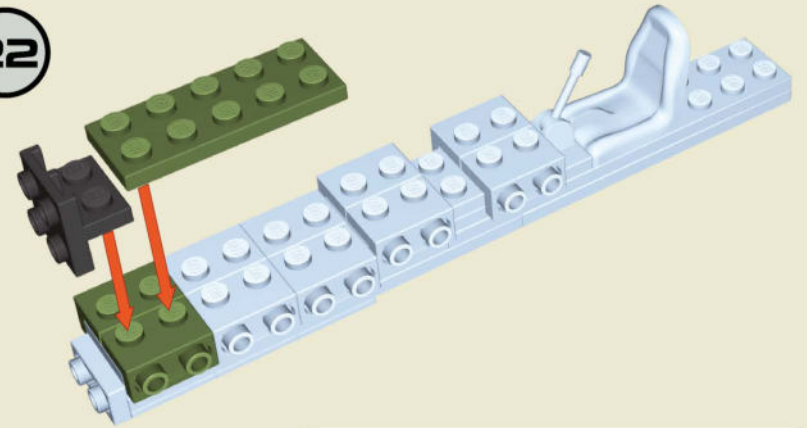

23

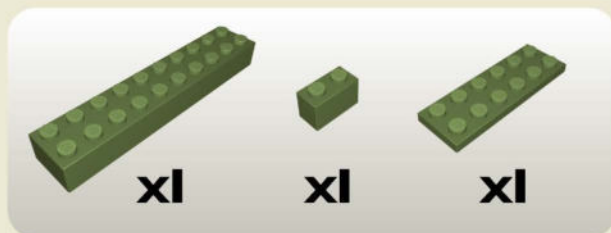
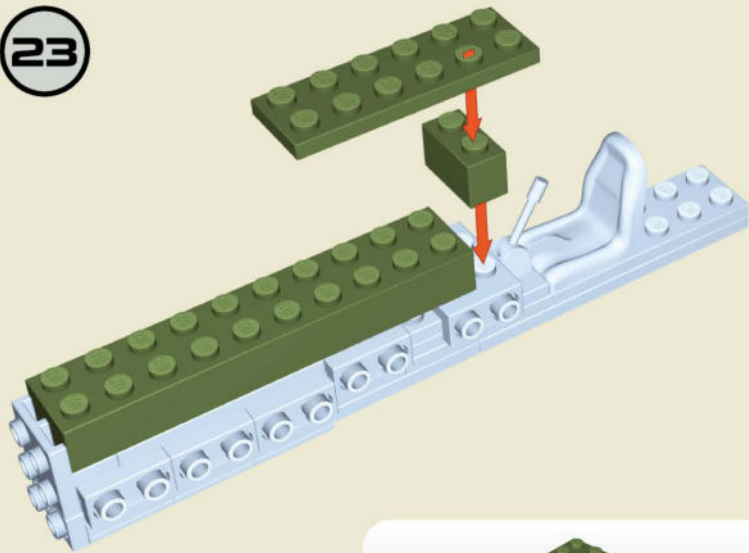

24

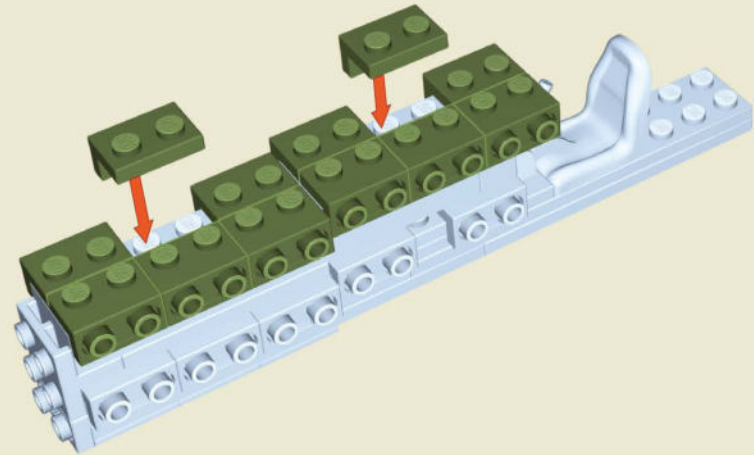

25

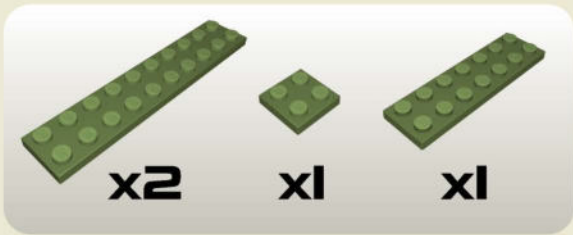
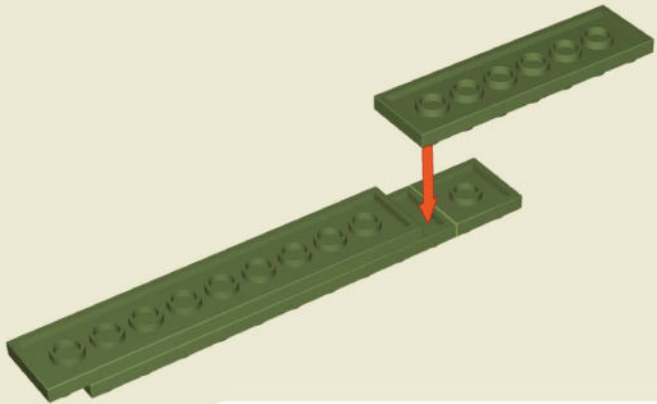

26

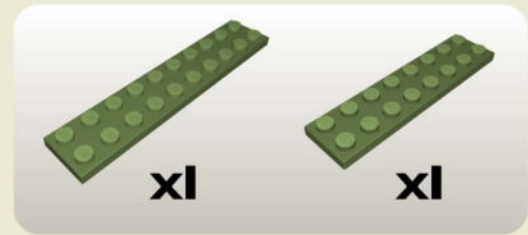
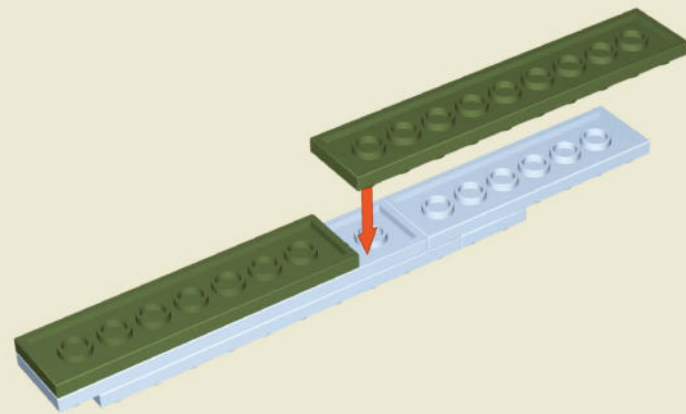

27

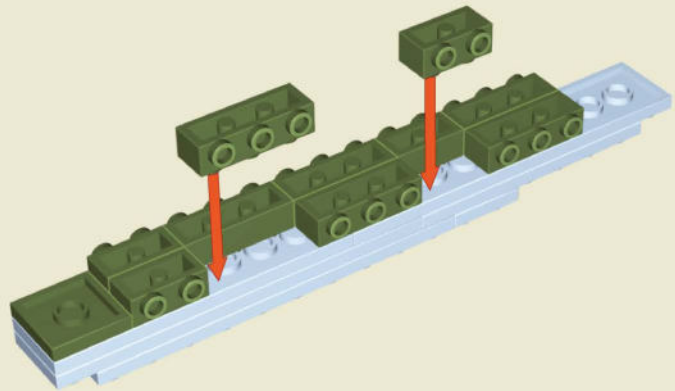

28

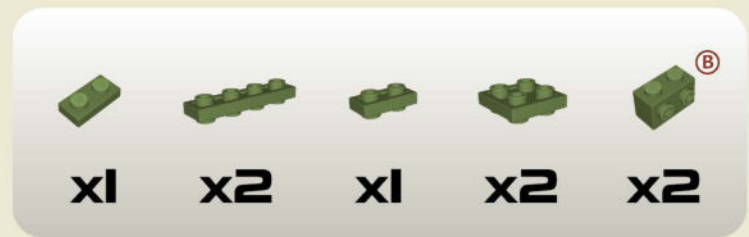
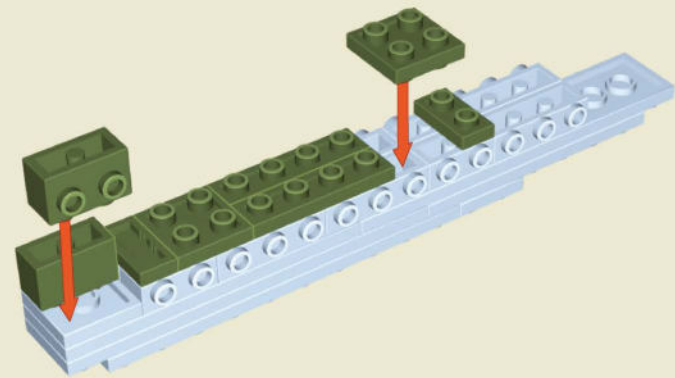

BE CAREFUL: NOTICE THE DIFFERENCE

A **B**

29

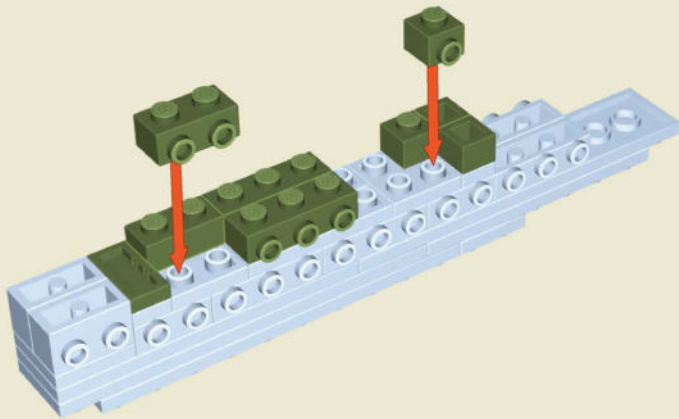

-  **x1**
-  **x2**
-  **x2**
-  **x2**
-  **x2**

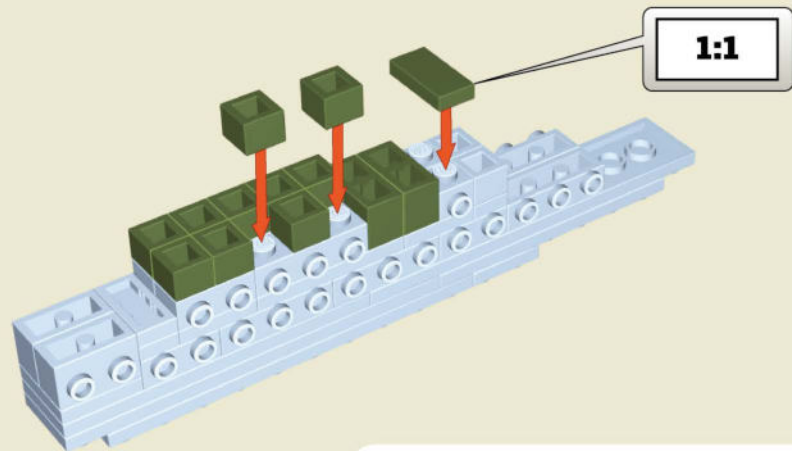

30



-  **x2**
-  **x10**
-  **x1**

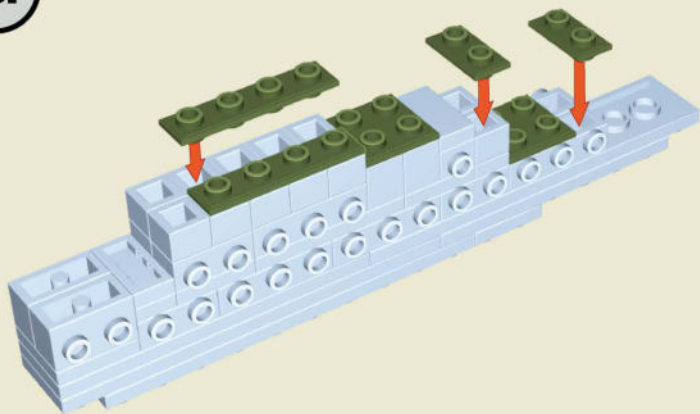



31

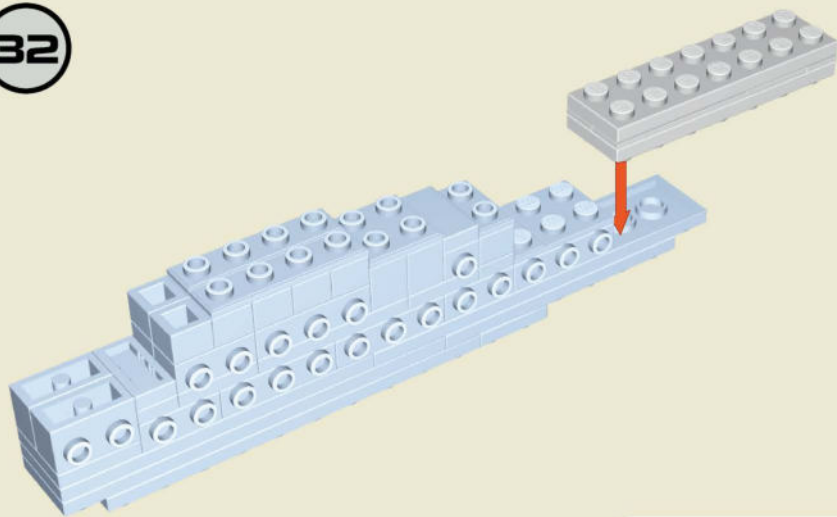

-  **x2**
-  **x2**
-  **x2**

32



-  **x2**
-  **x2**
-  **x1**
-  **x1**

33

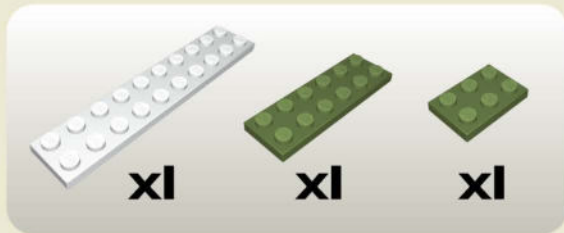
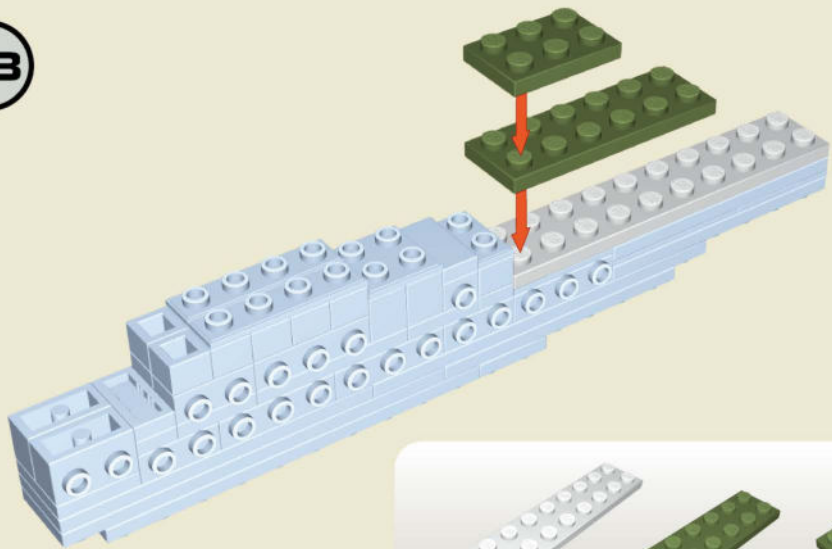

34

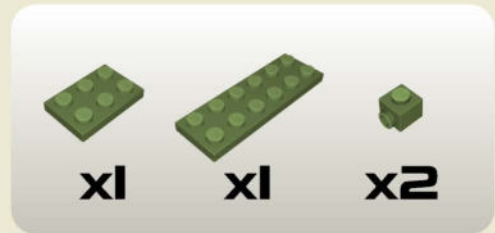
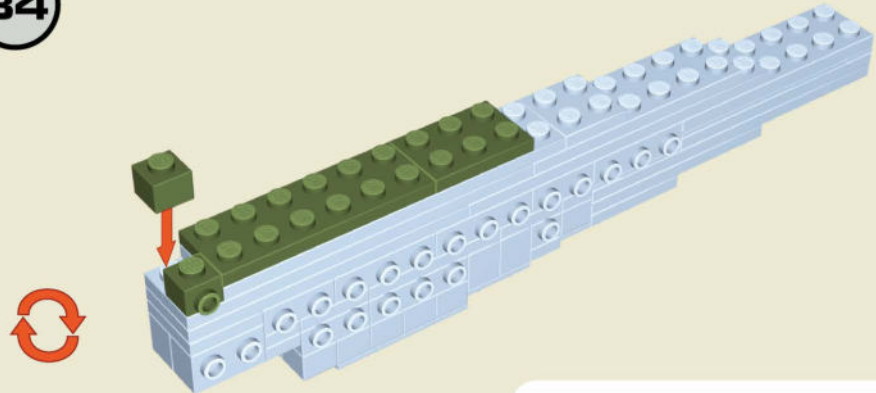

35

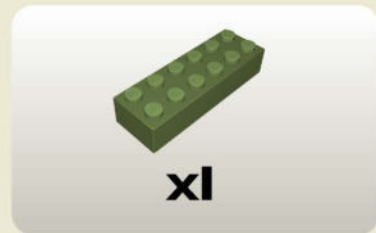
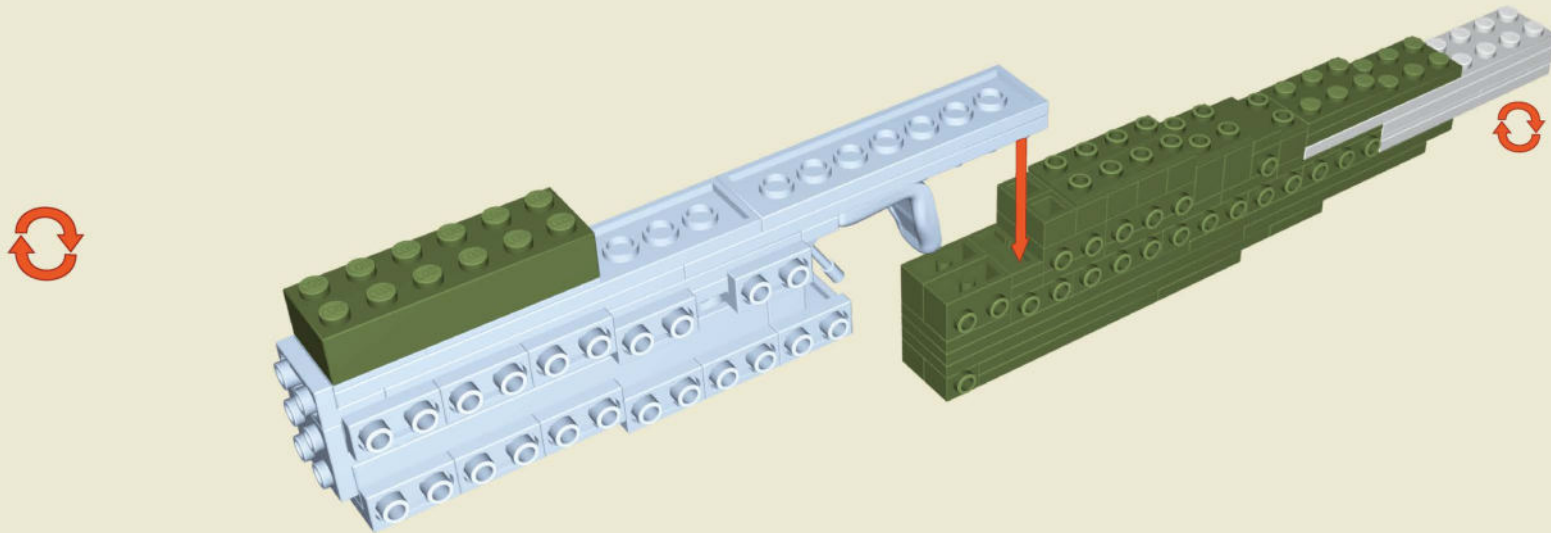



36

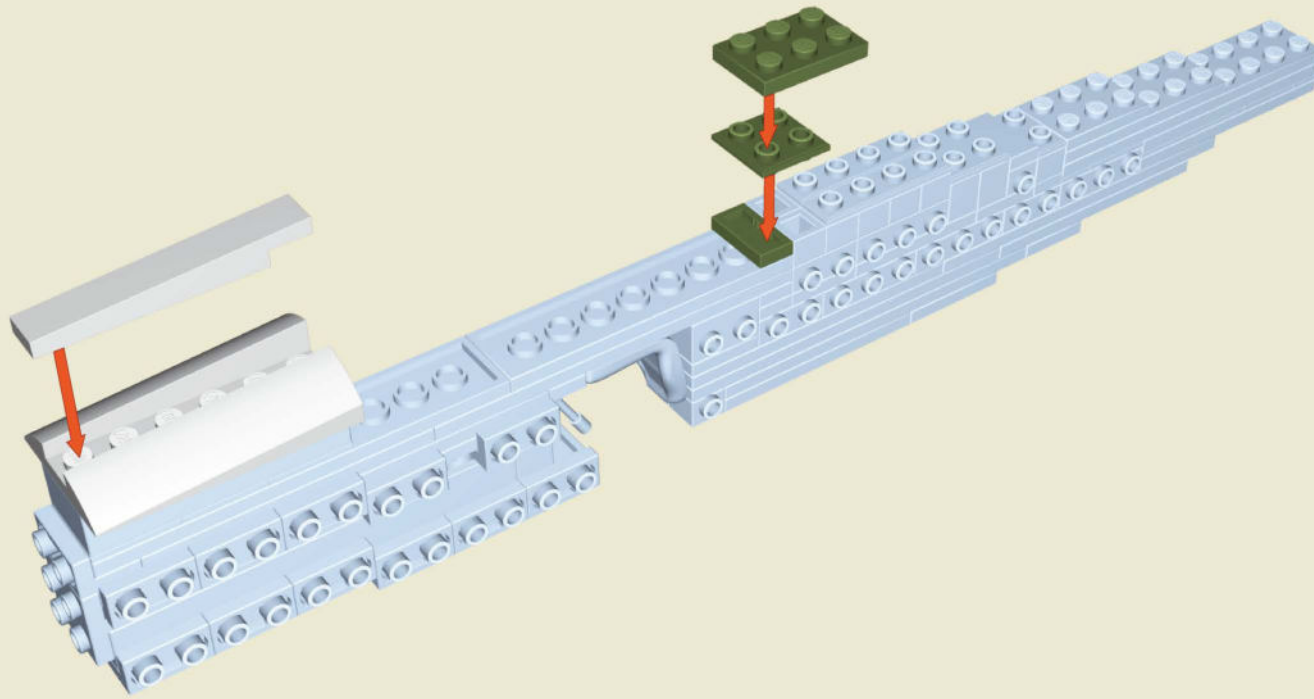



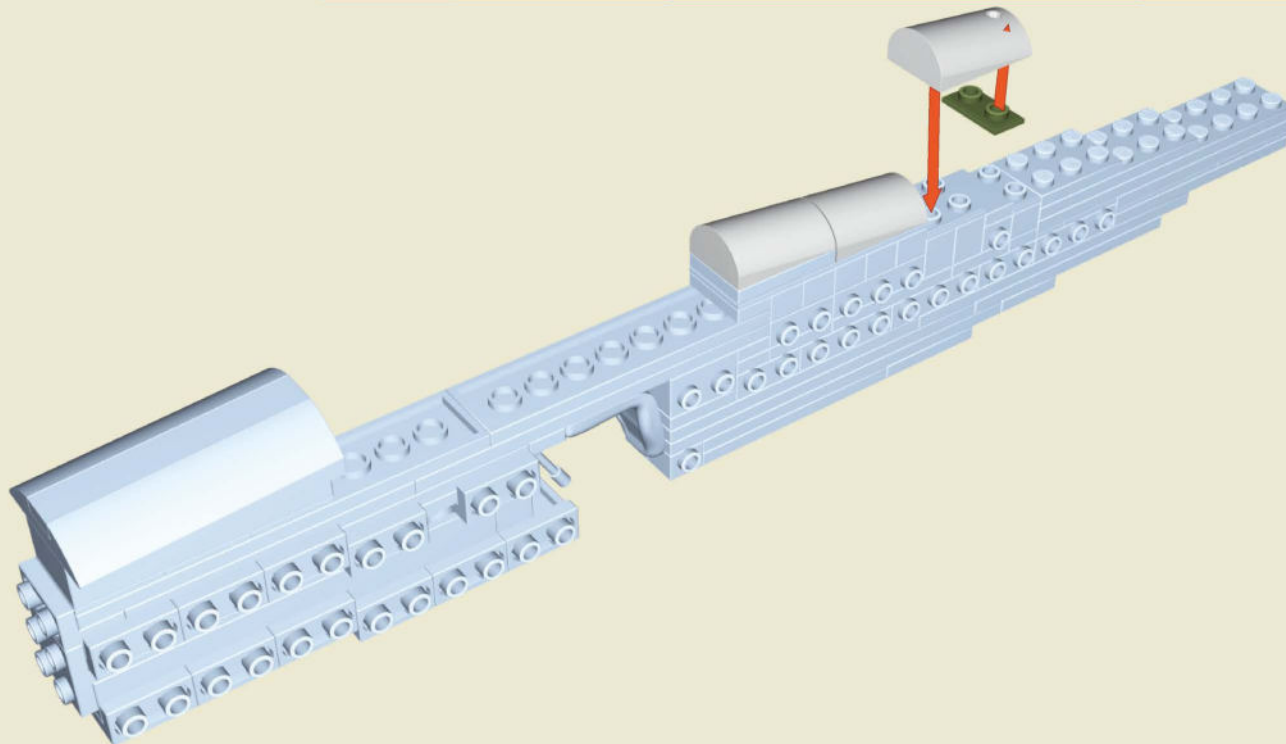

-  x1
-  x1
-  x1
-  x1
-  x1

37







-  x2
-  x1
-  x1

BE CAREFUL: NOTICE THE DIFFERENCE

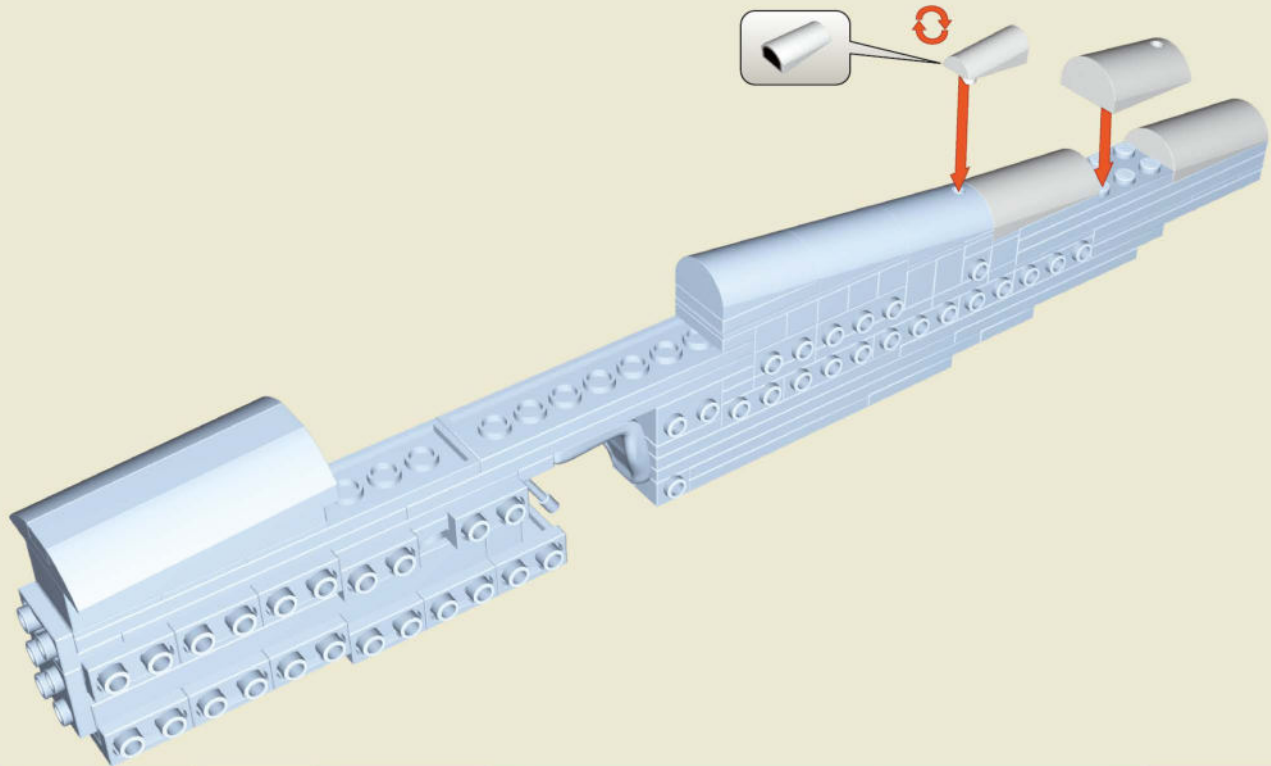
C  D  E  F 

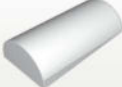



38

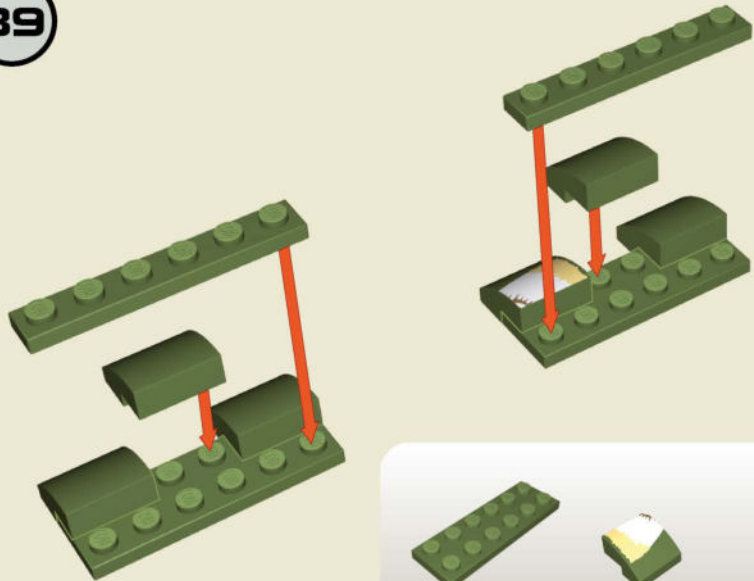

-  x2
-  x1
-  x1
-  x1

39



-  x2
-  x1
-  ^E x5
-  x2

40

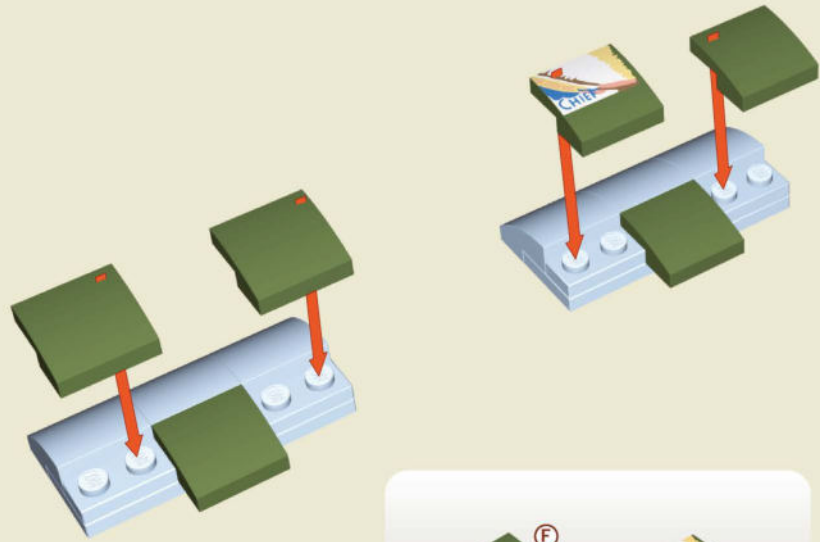

-  ^F x5
-  x1

41

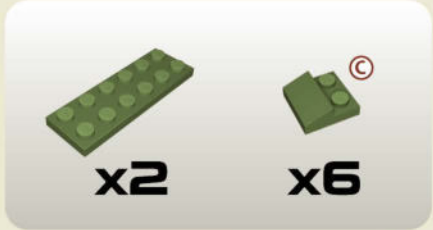
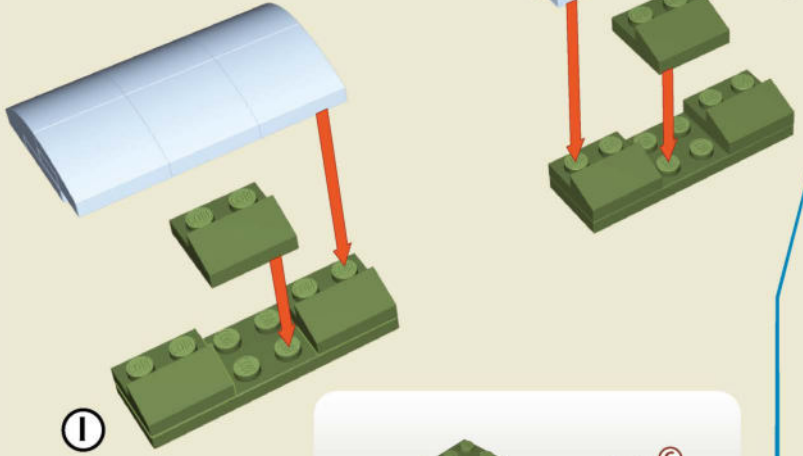

42

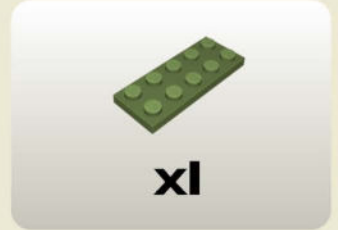
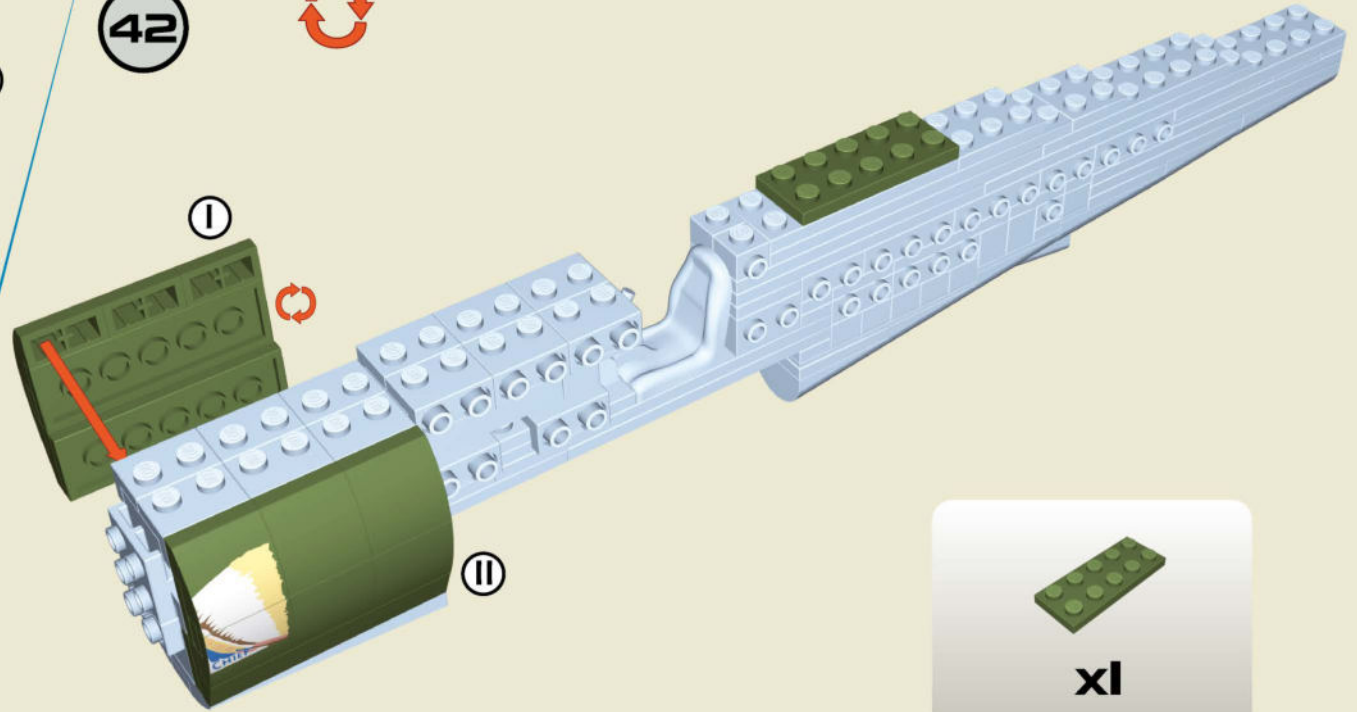

43

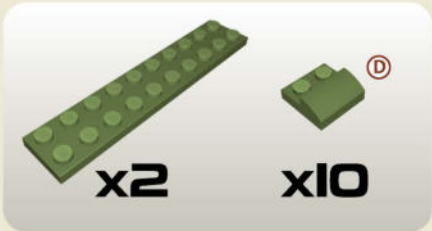
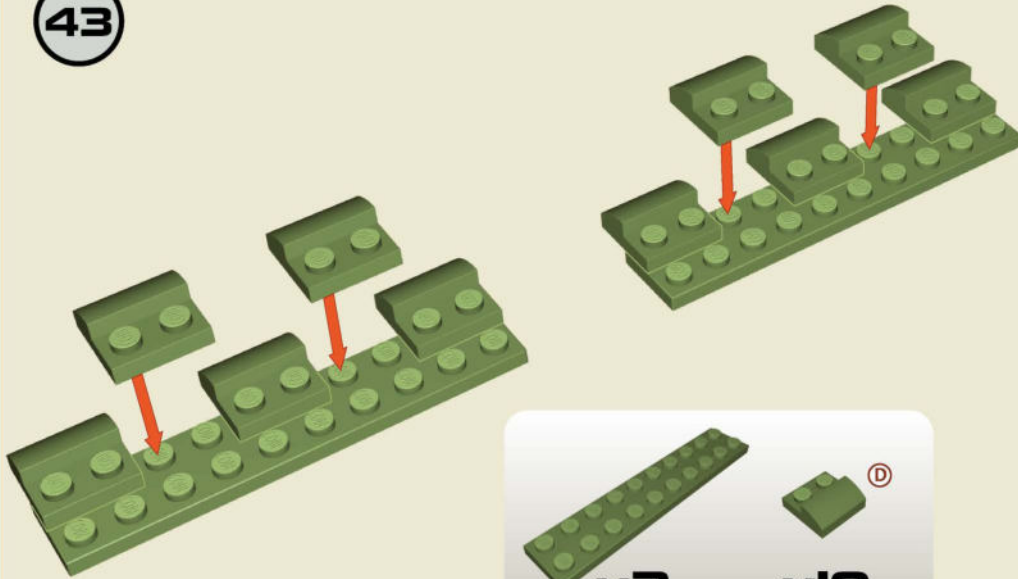

44

1:1

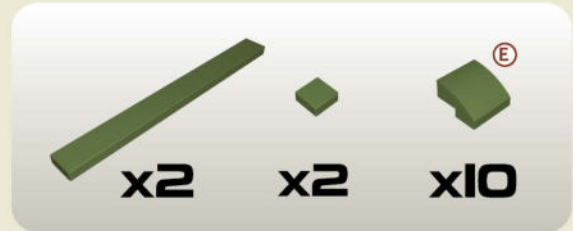
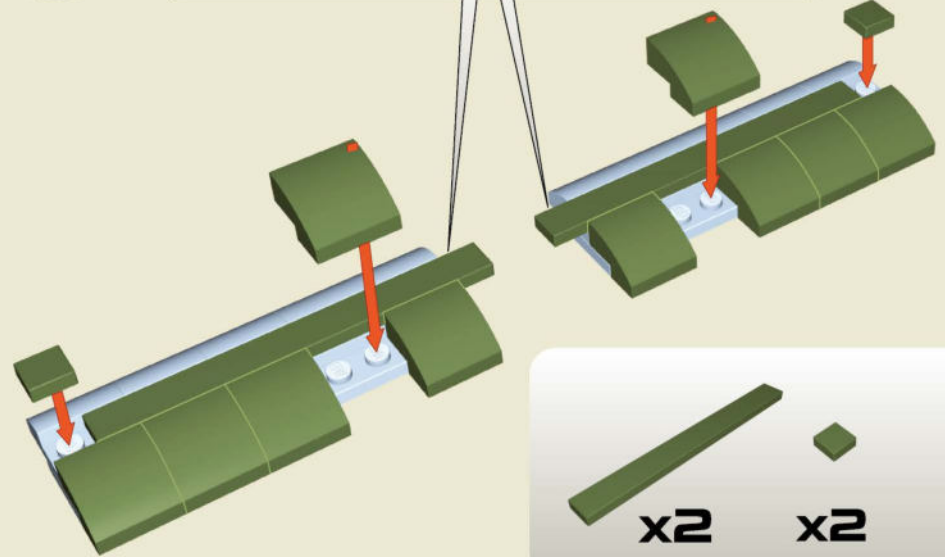

45

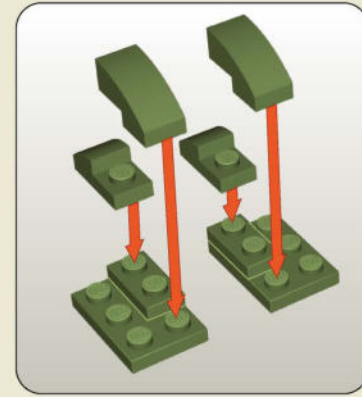
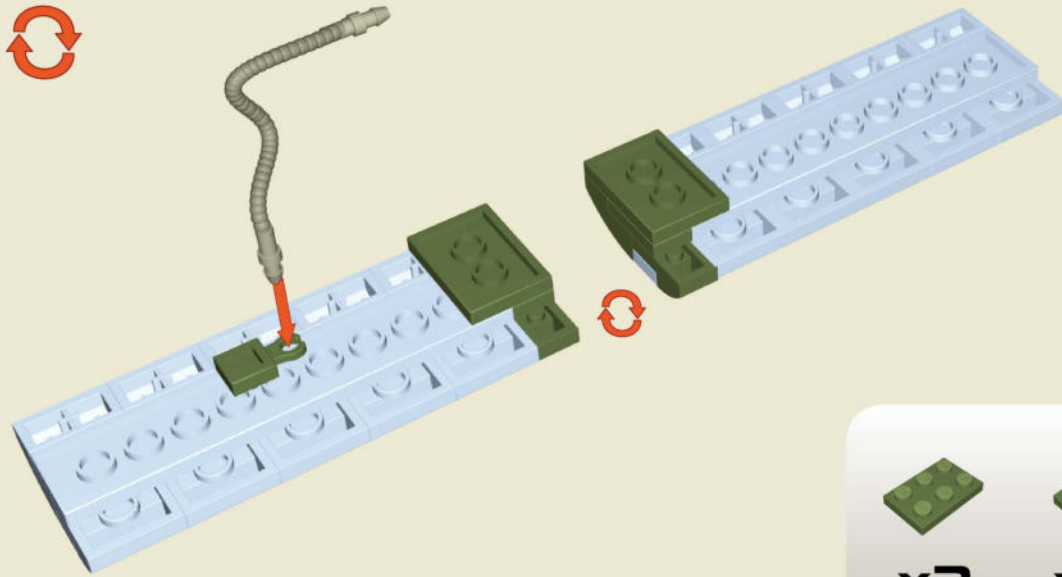

x2



x2



x2



x2



x1



x1

46

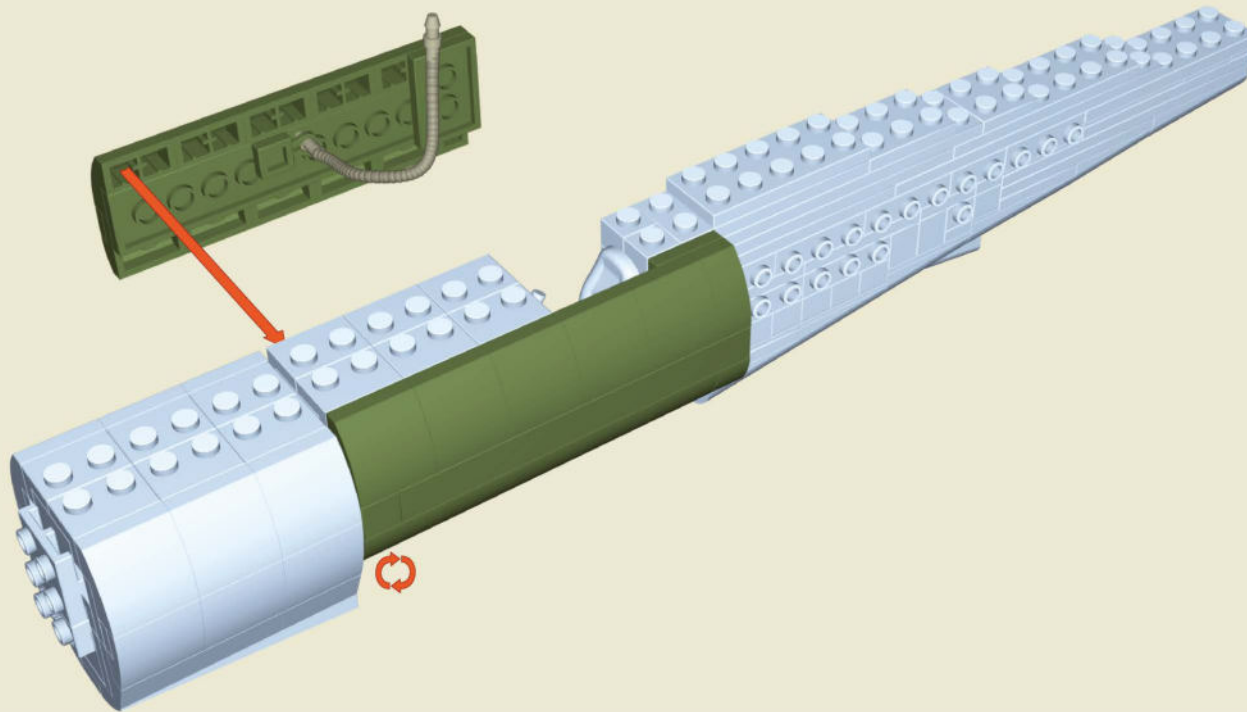

48

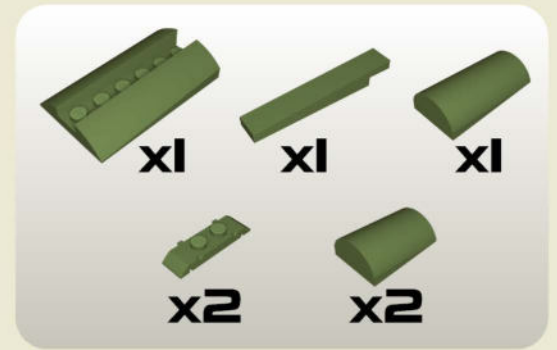
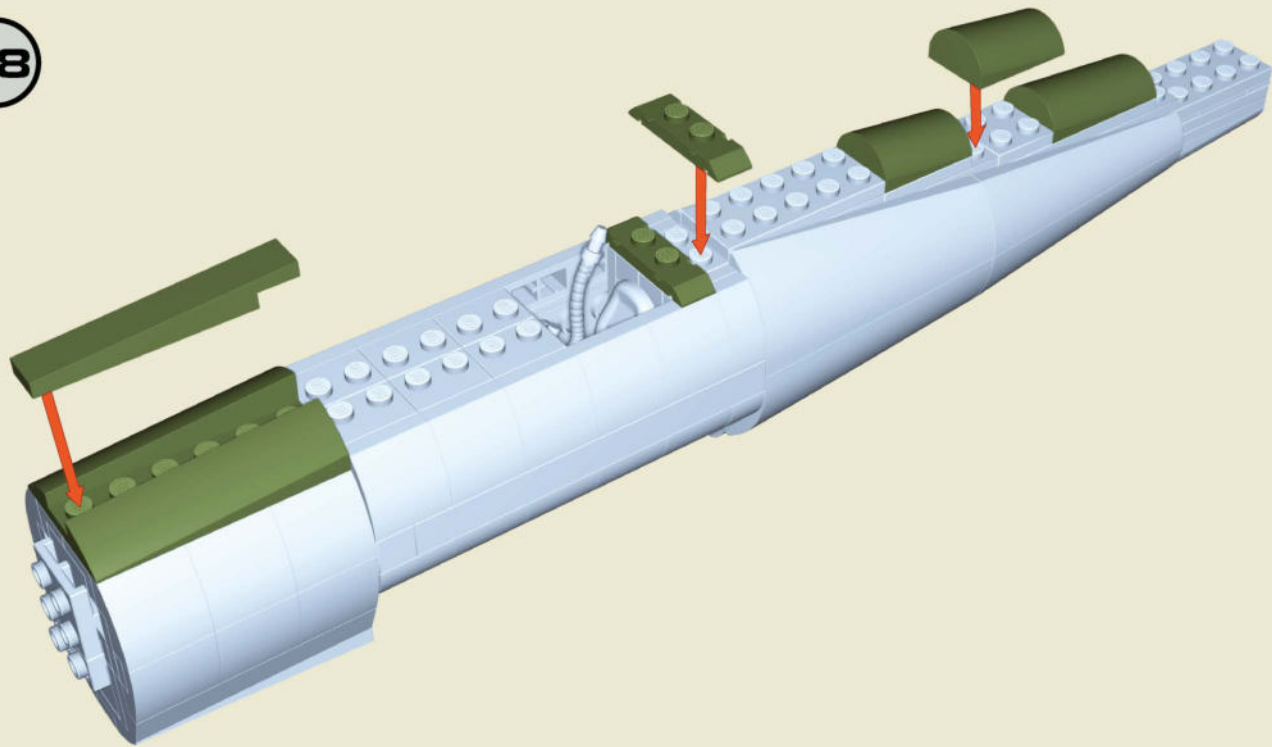

49

1:1

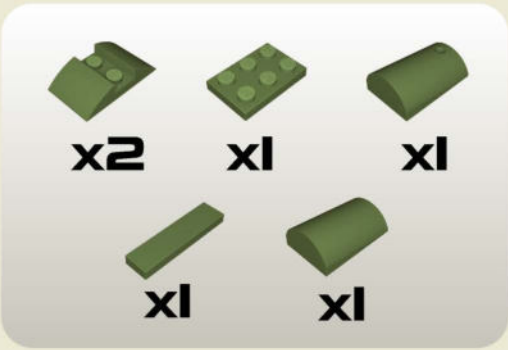
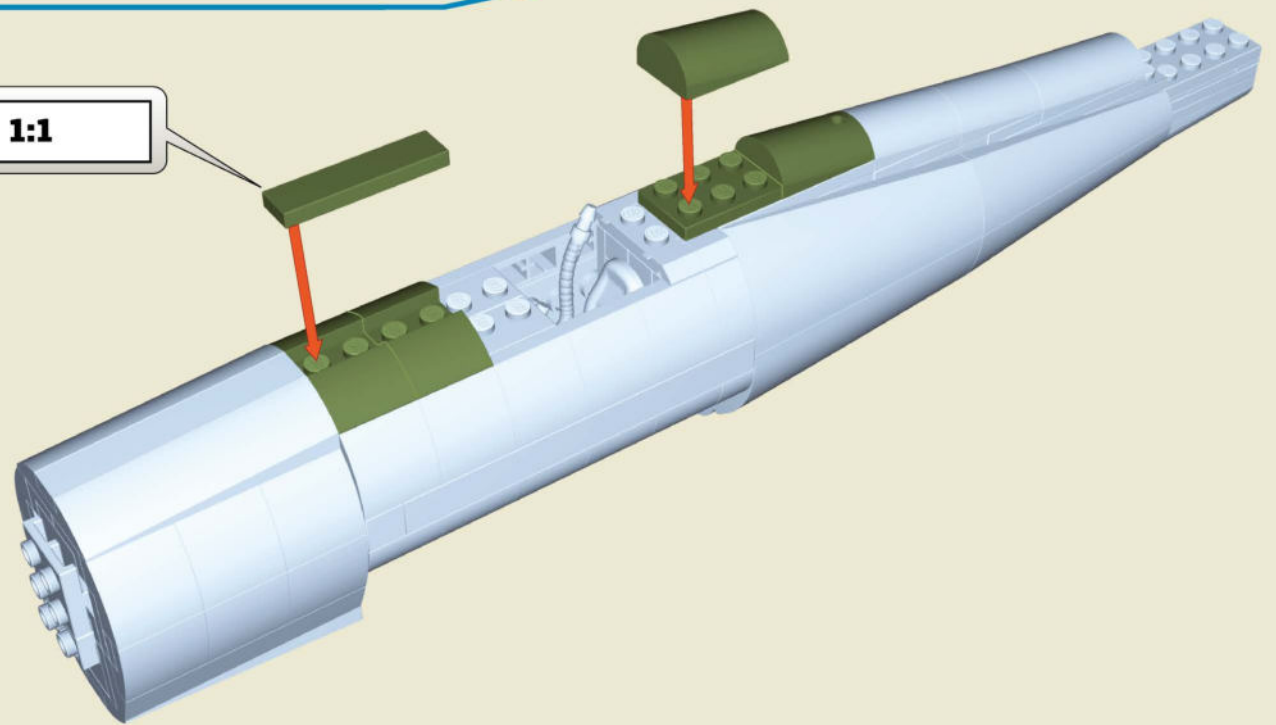

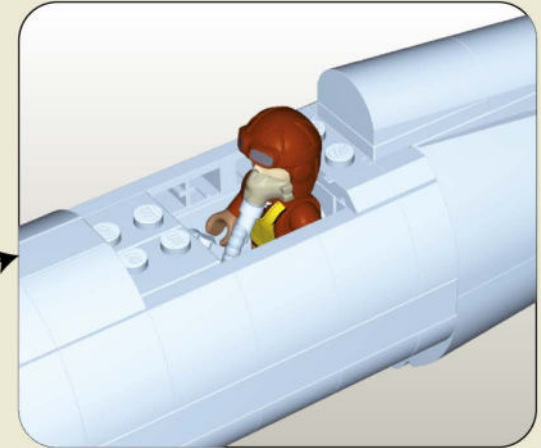
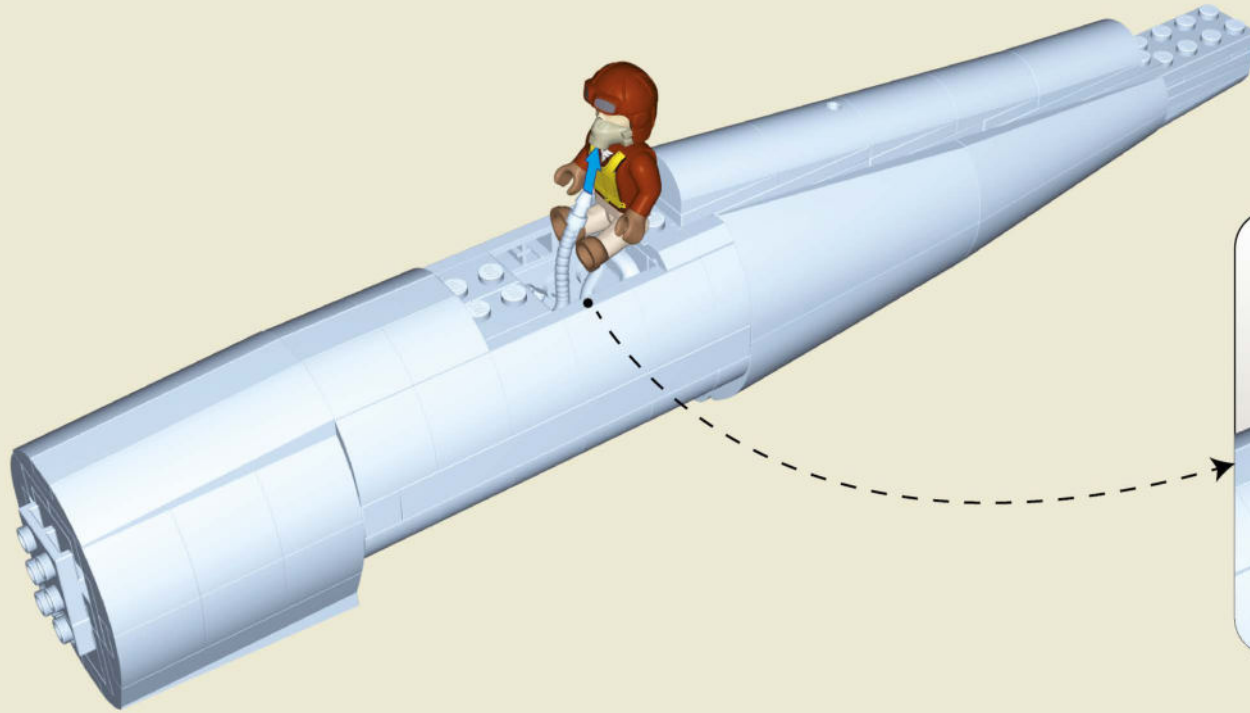

x1	x1	x1	x2
x1	x1	x1	x1

A sequence of three diagrams showing the assembly of the minifigure. The first diagram shows a brown minifigure torso with a yellow vest and a brown helmet being placed on top. The second diagram shows the torso being placed on a white minifigure body. The third diagram shows the helmet being placed on the head of the white minifigure body.

51

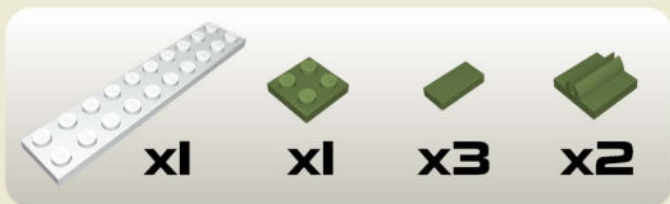
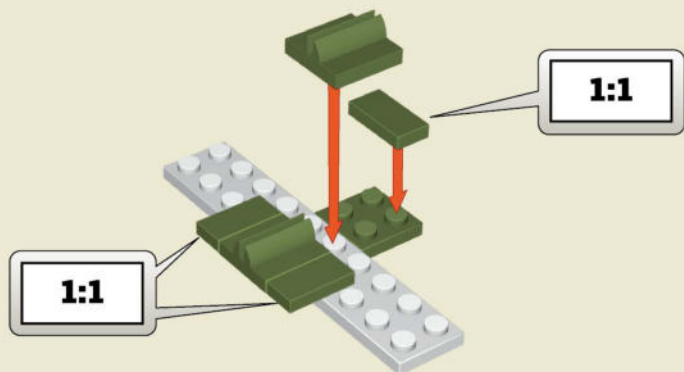

52

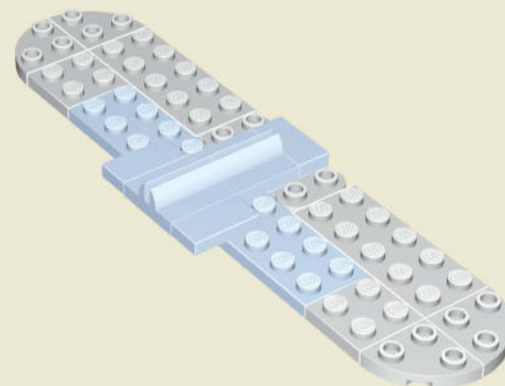

53

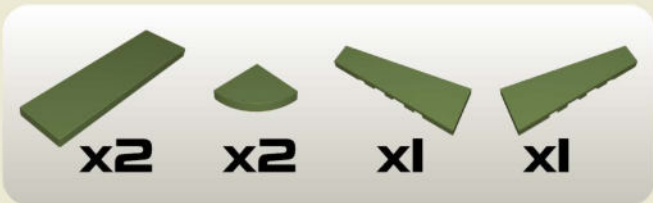
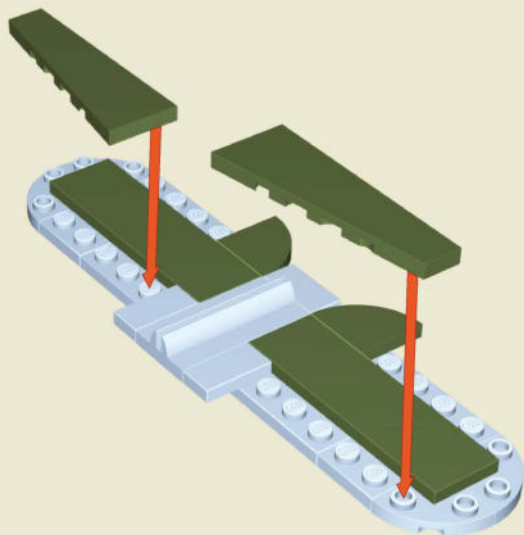

54

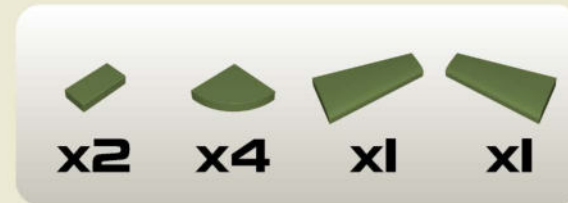
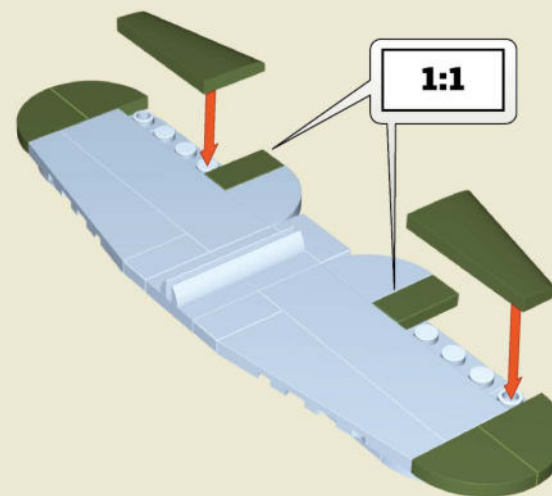

55



x1



x1



x1

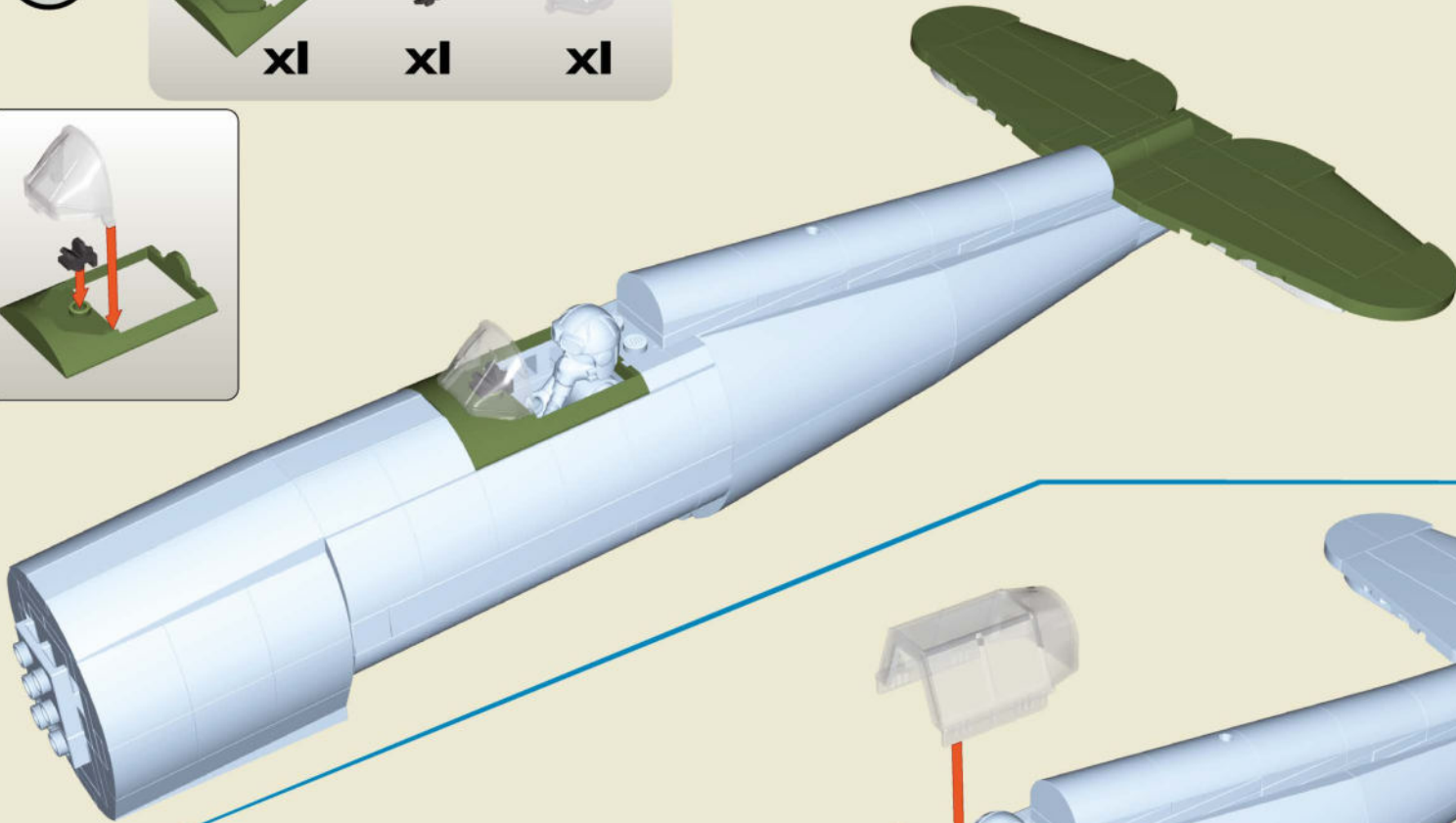
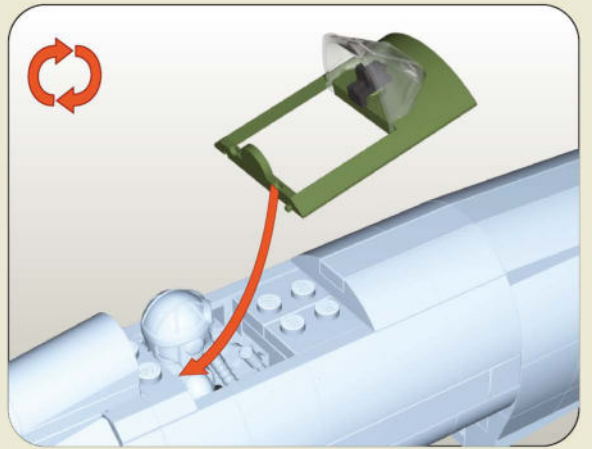

56

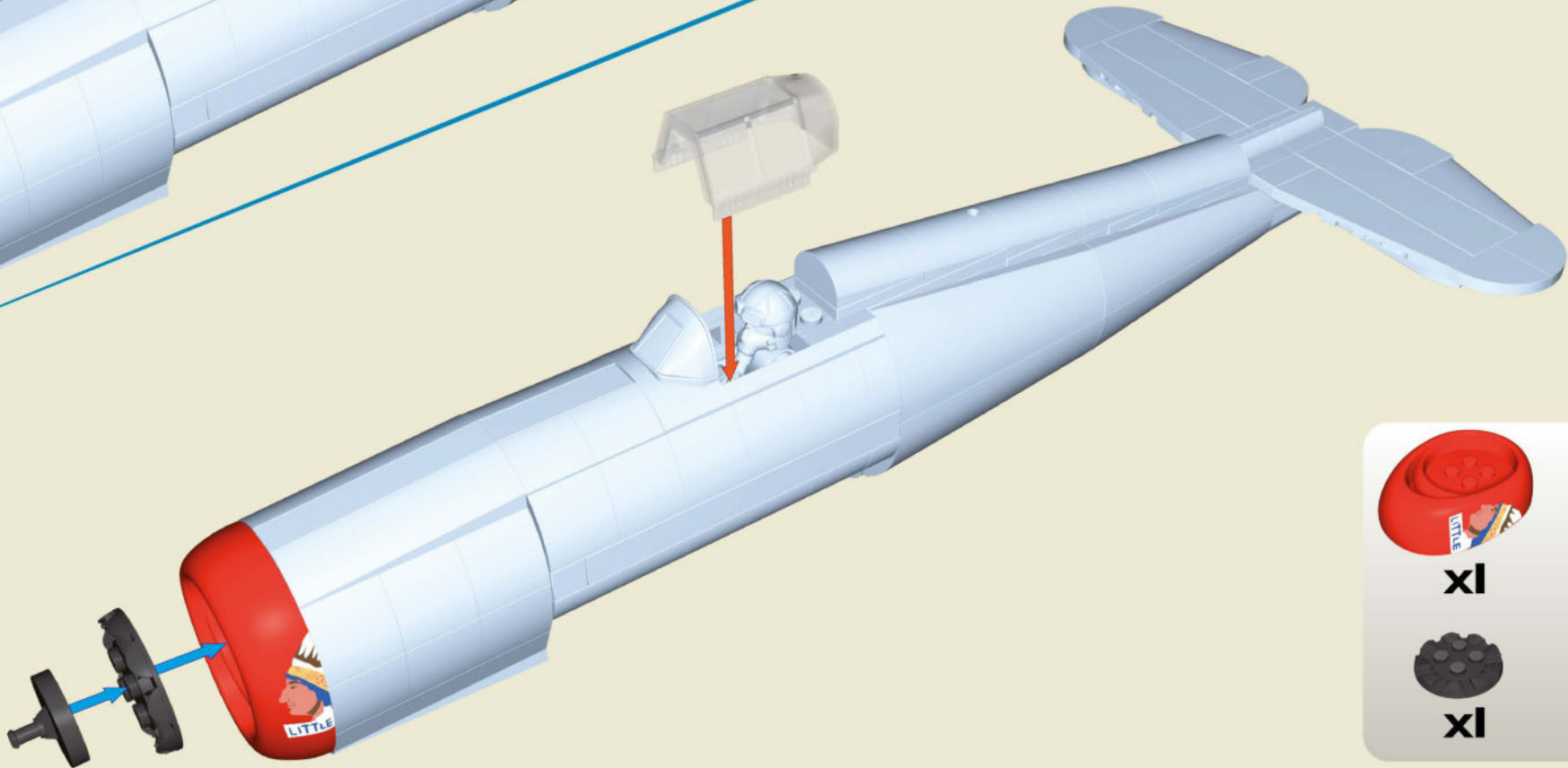

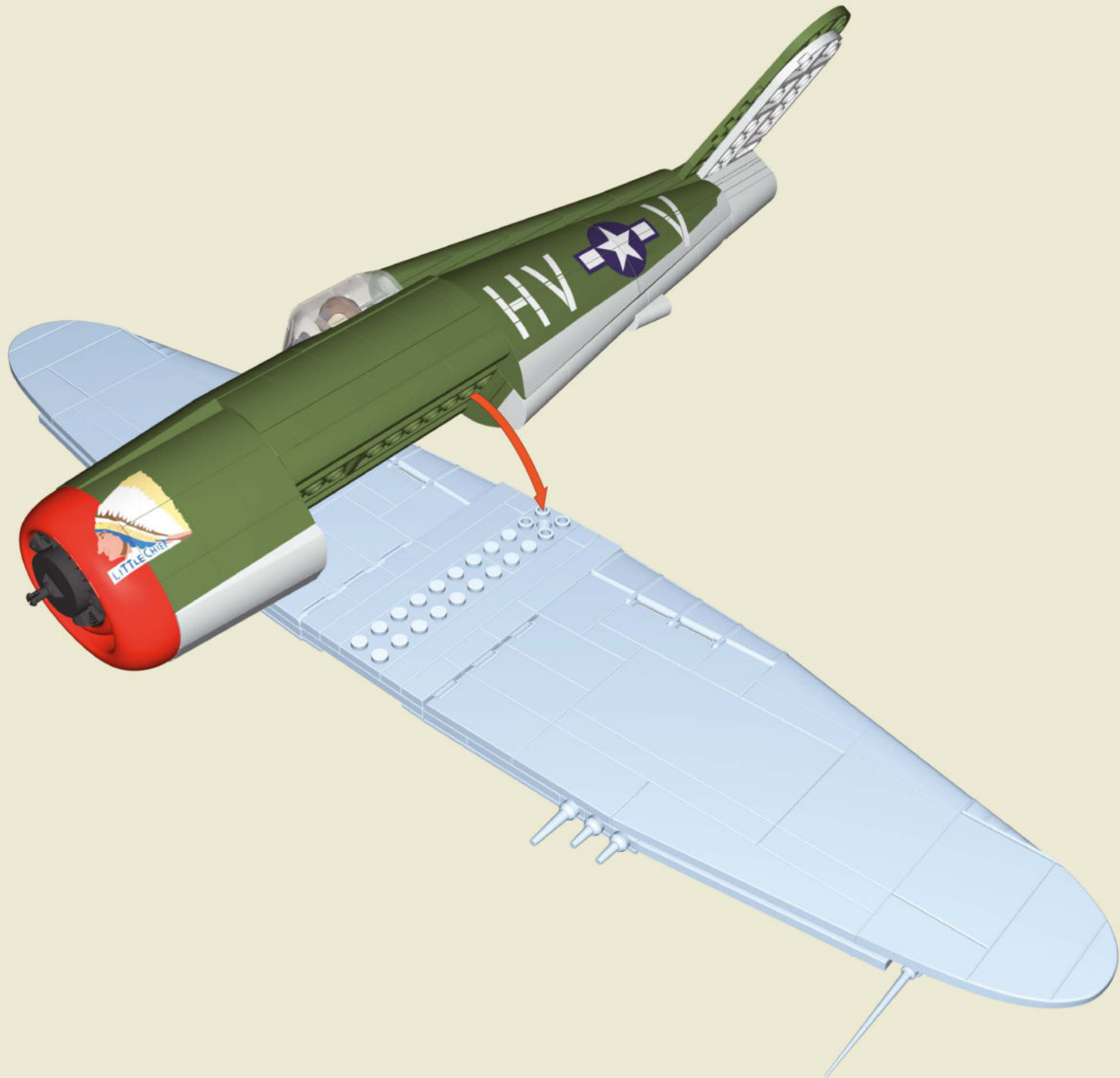

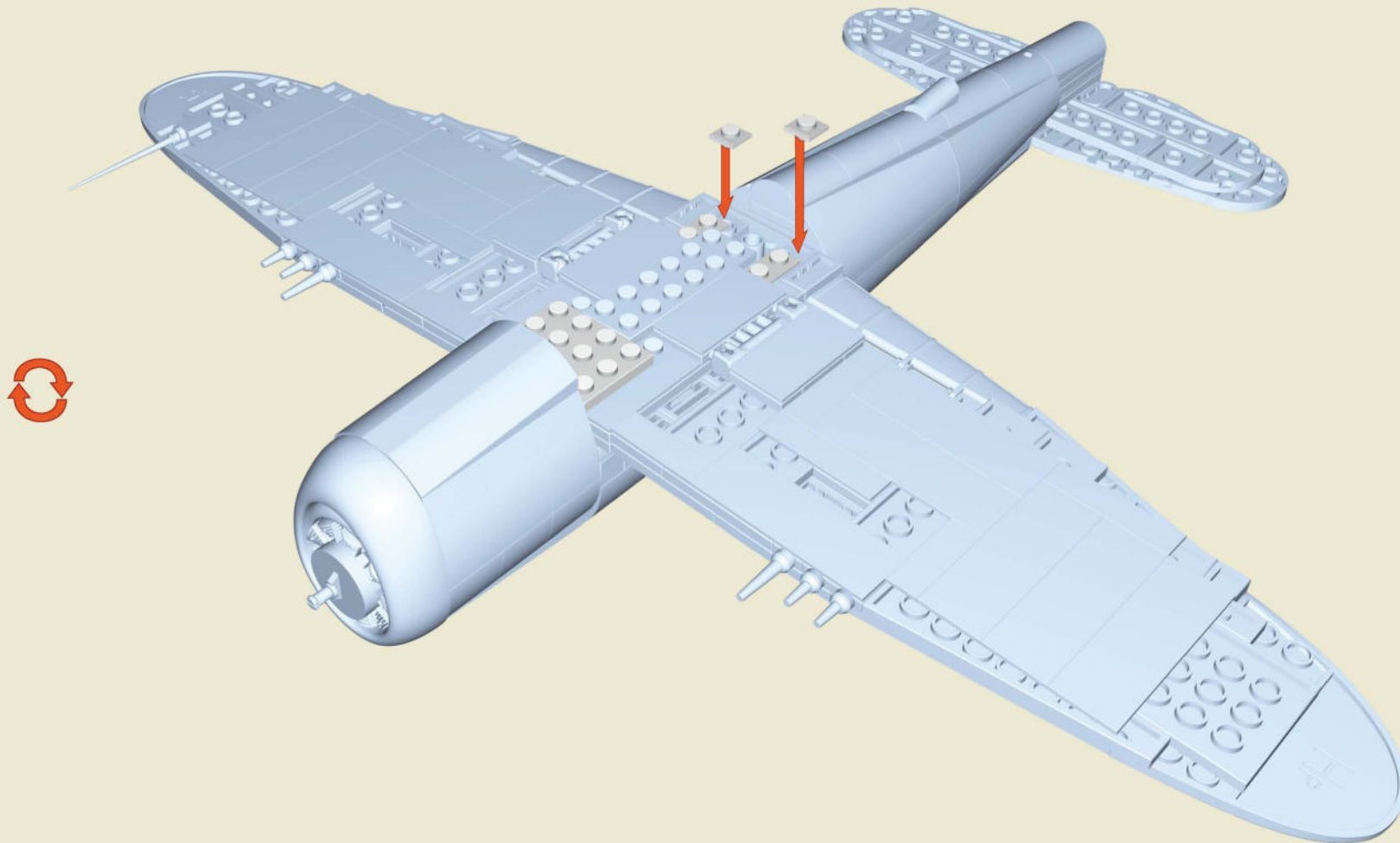



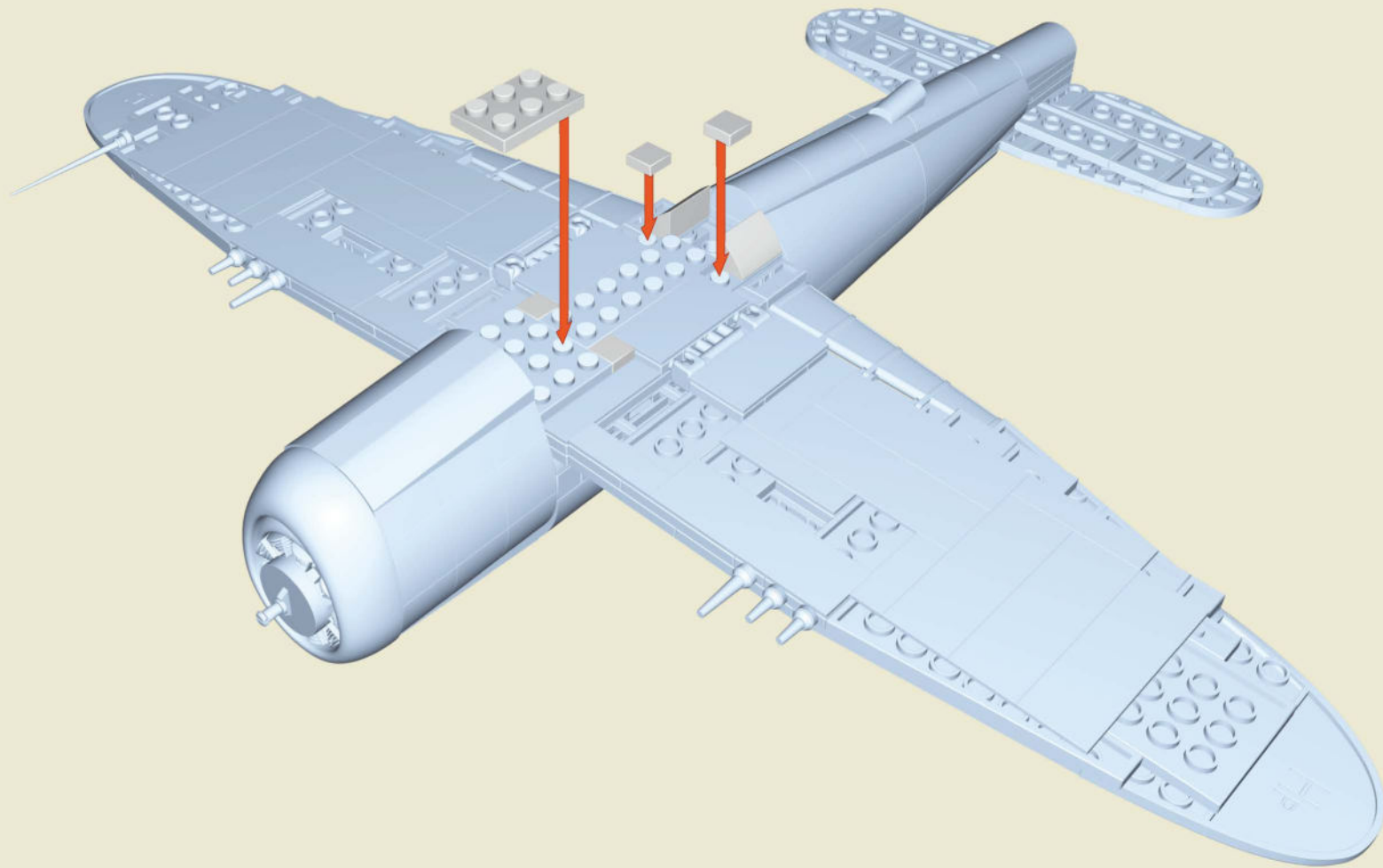

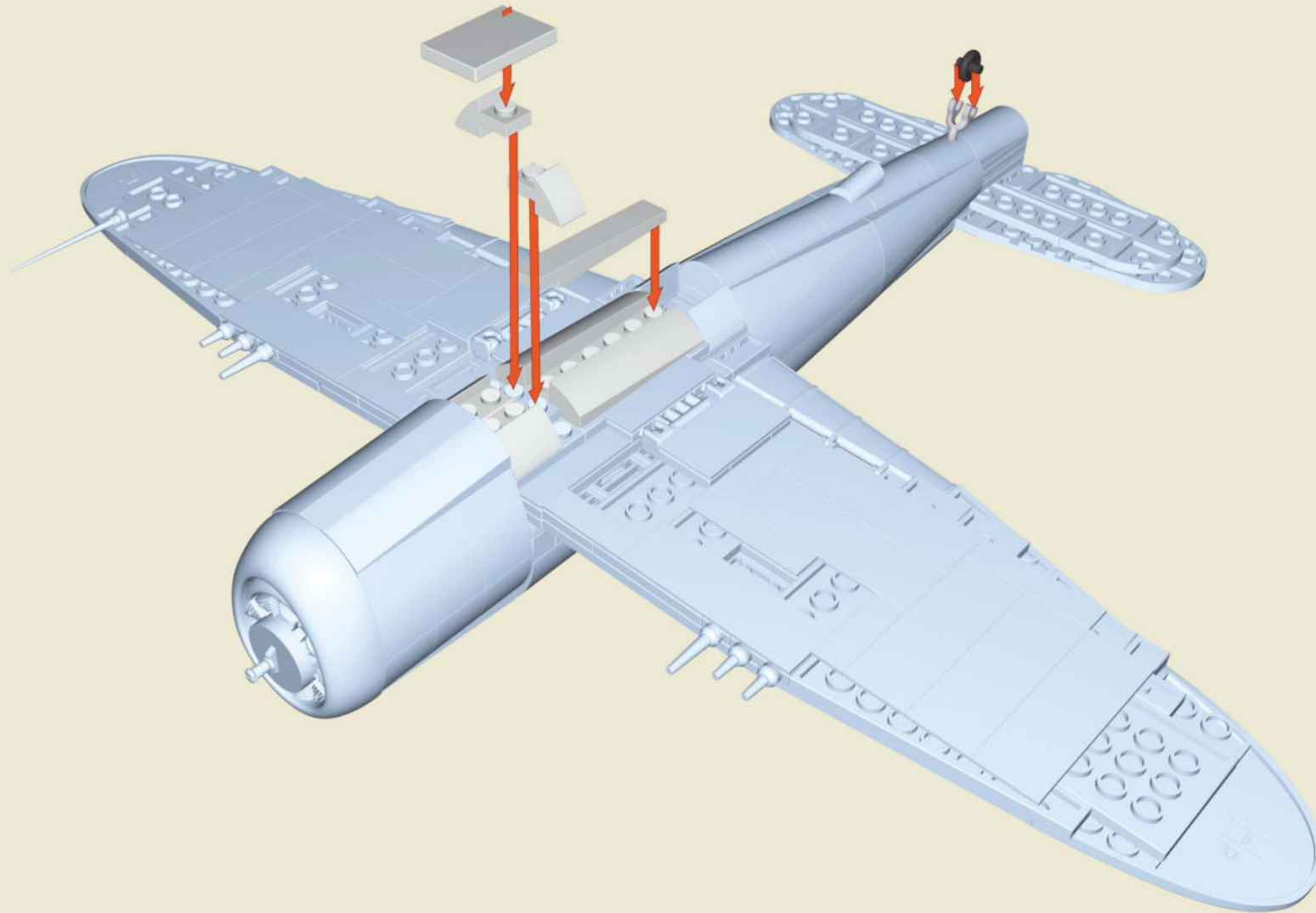

		
x1	x2	x2



 **x2**  **x4**  **x1**



-  x2
-  x1
-  x1
-  x1
-  x1
-  x2
-  x1

61

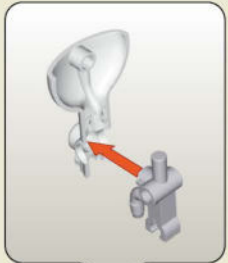
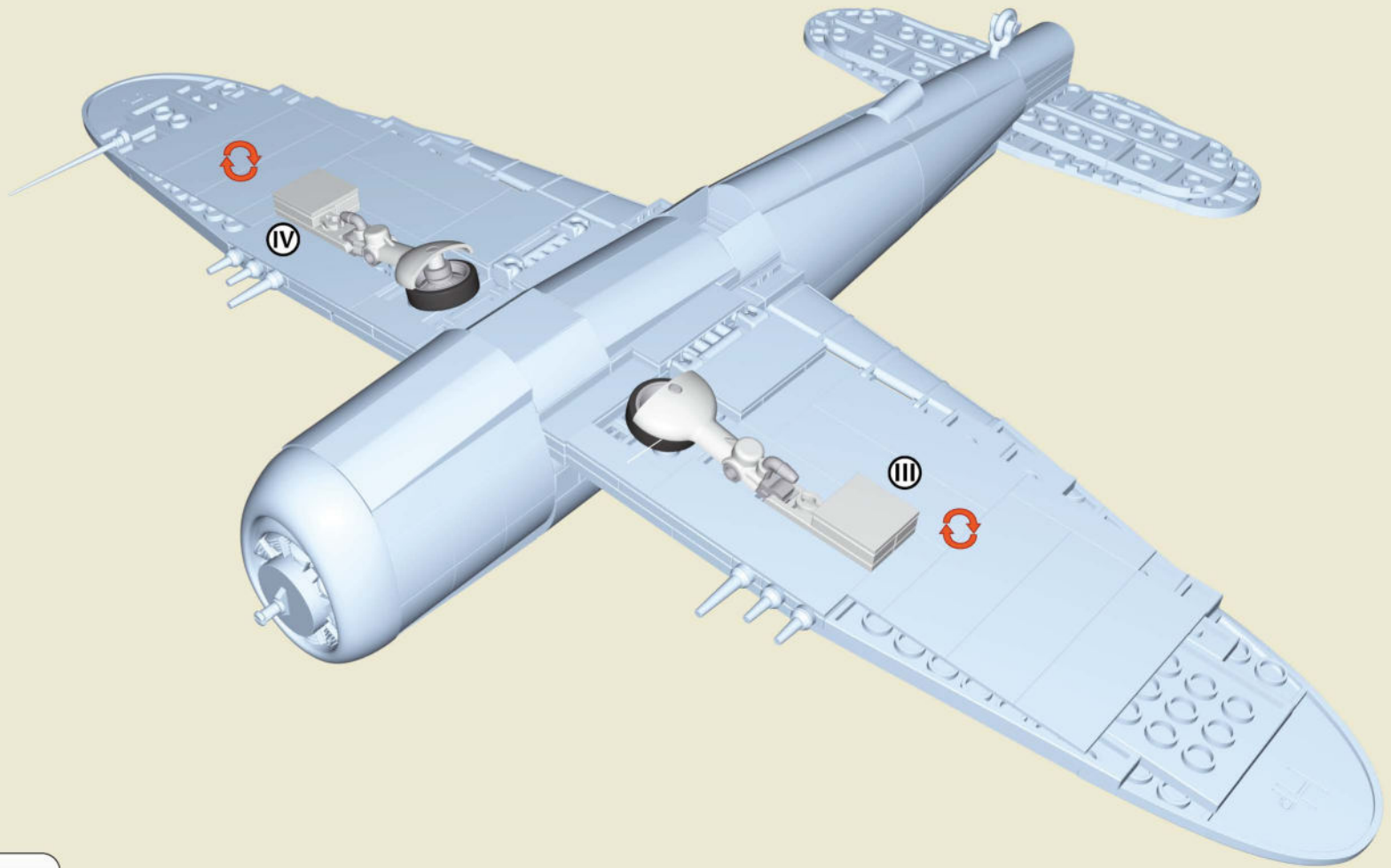

x2

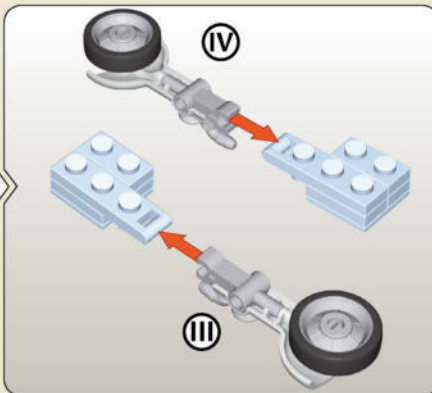
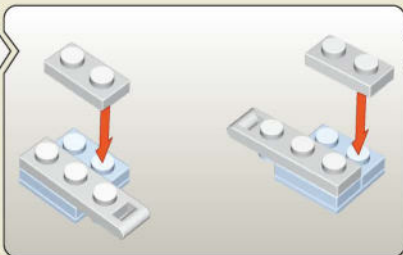
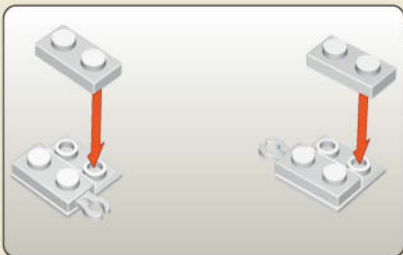

x2	x2	x4	x2	x2
x2	x2	x2	x2	

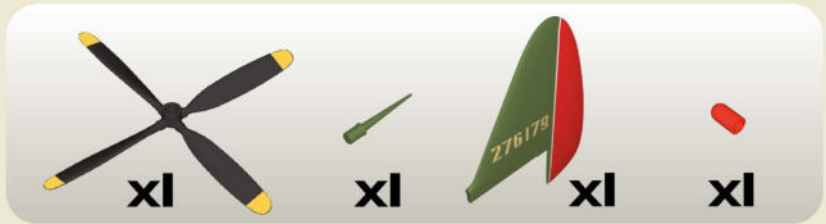
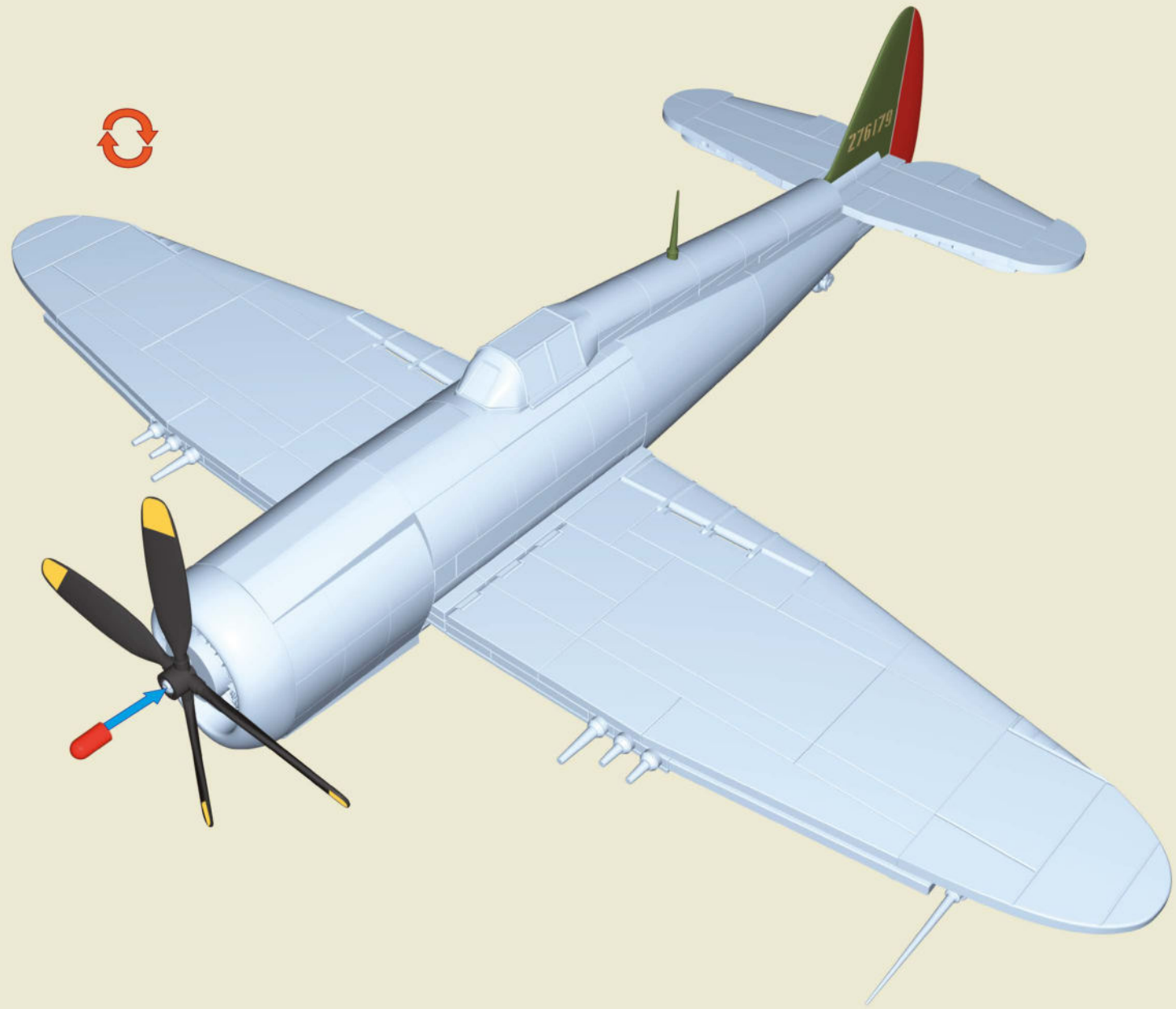

63

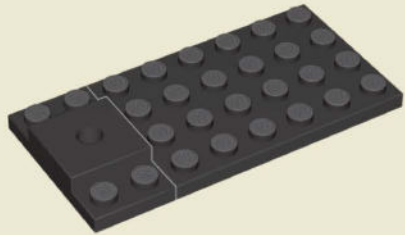

64

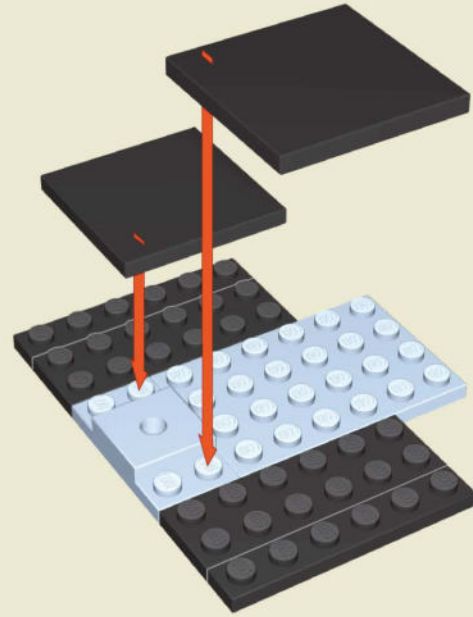

65

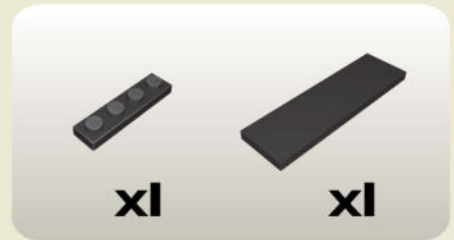
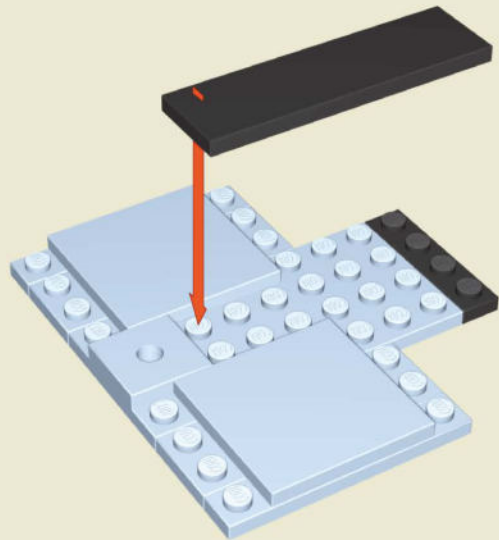

66

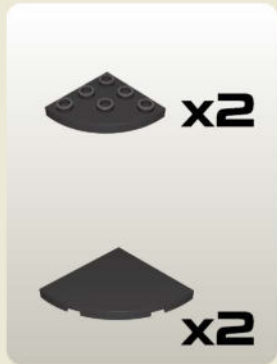
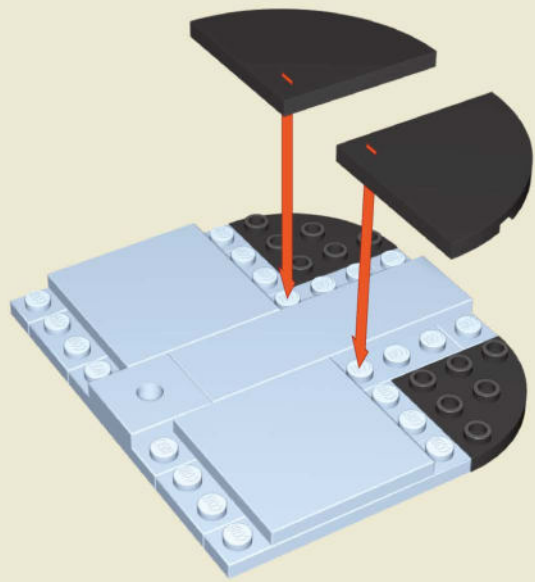

67

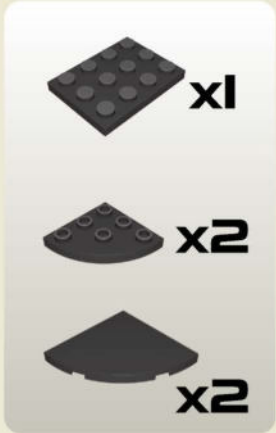
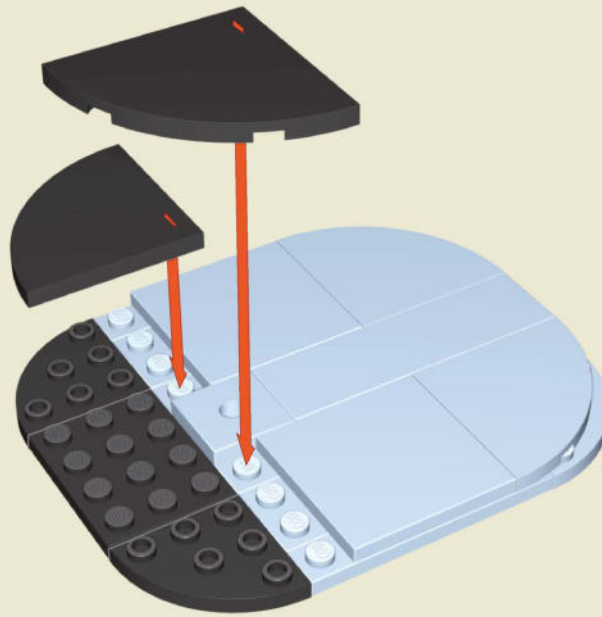

68

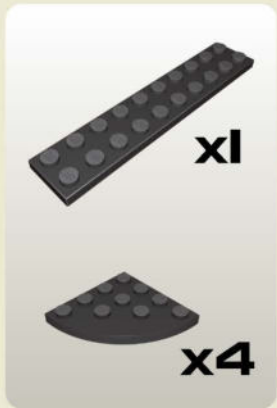
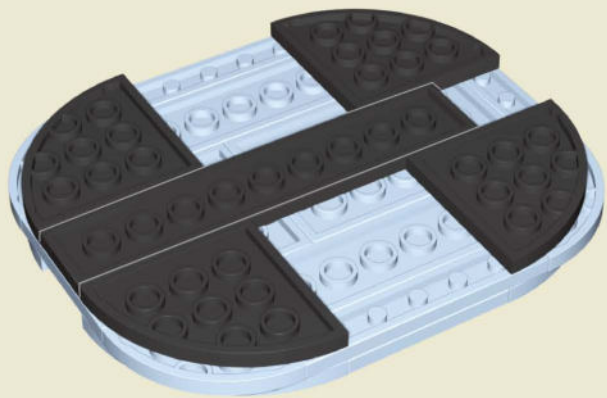

69



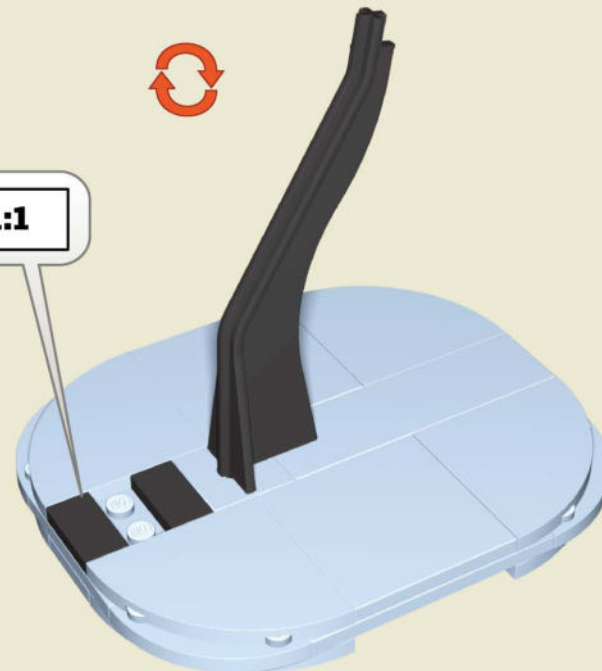

1:1



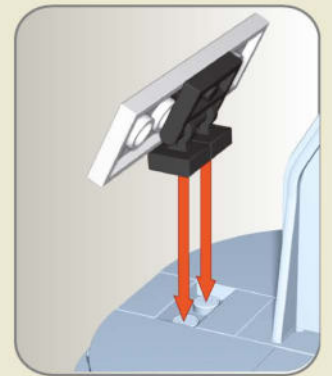
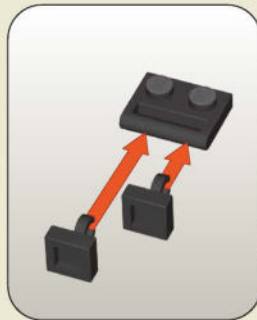
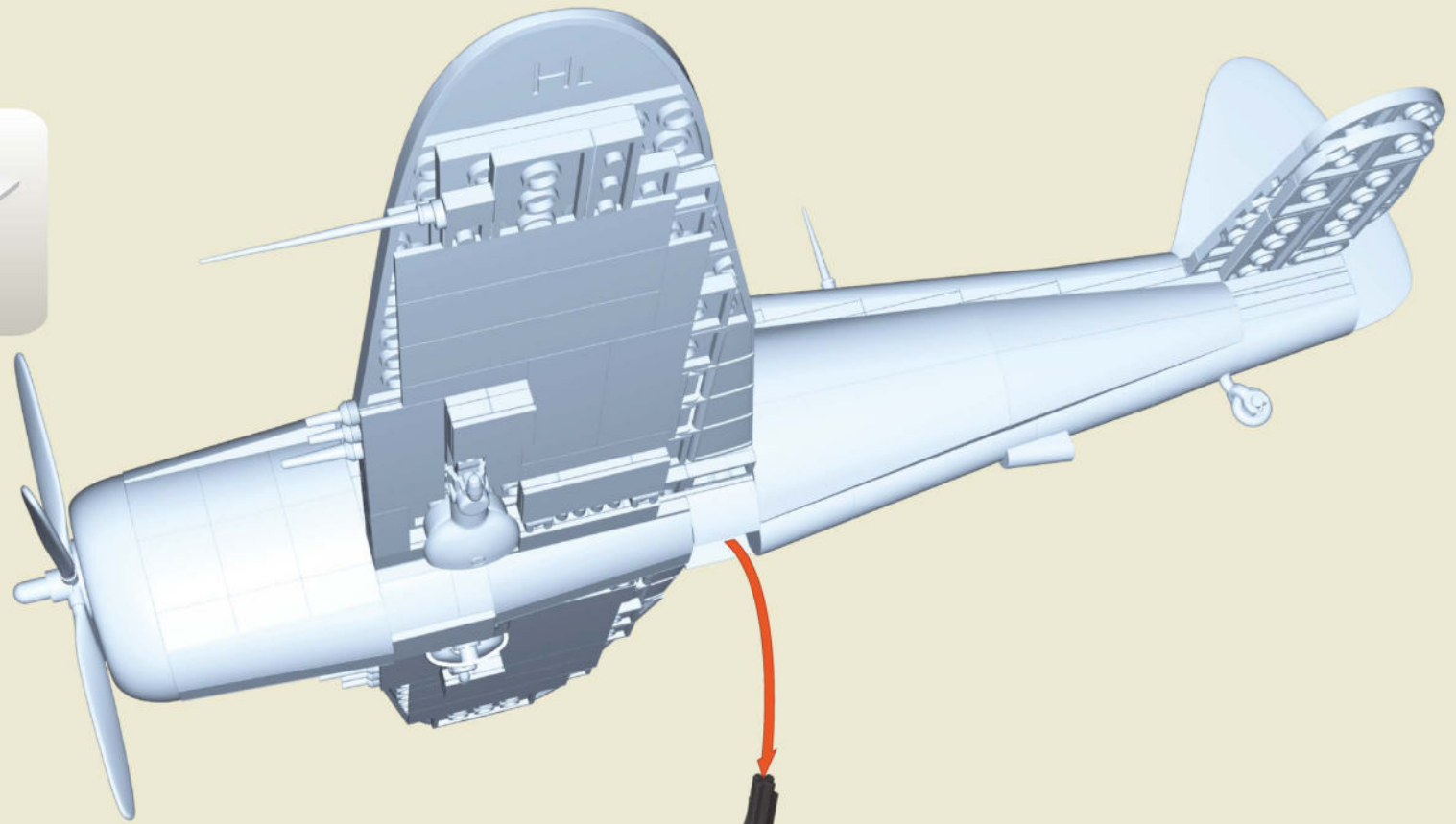

70

x2 x1 x1

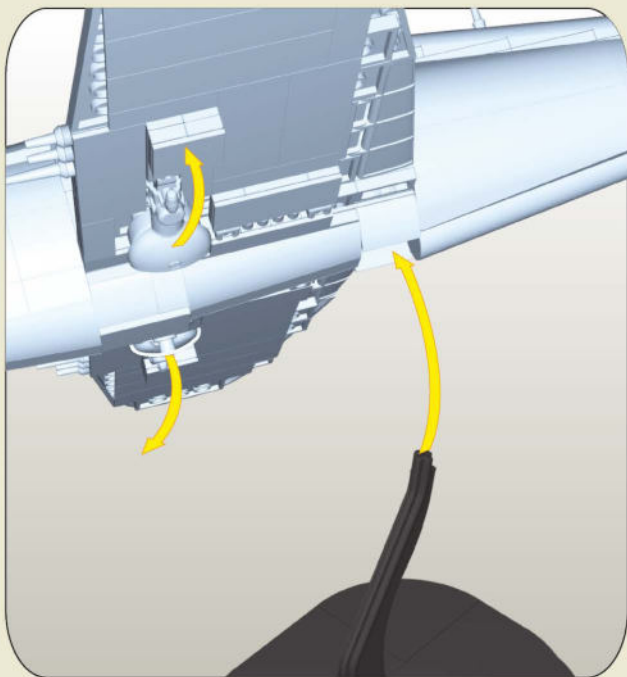
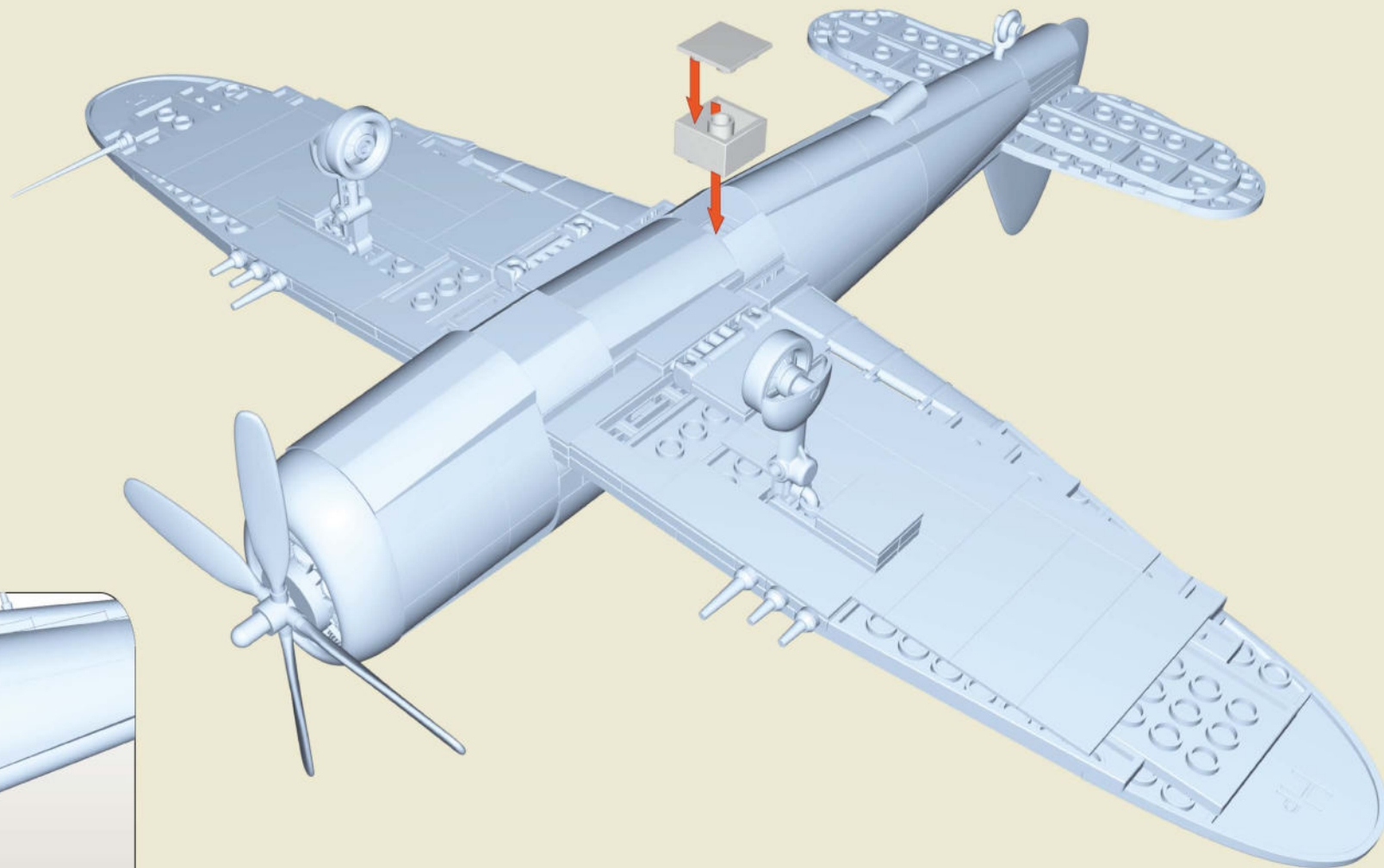



	
x1	x1

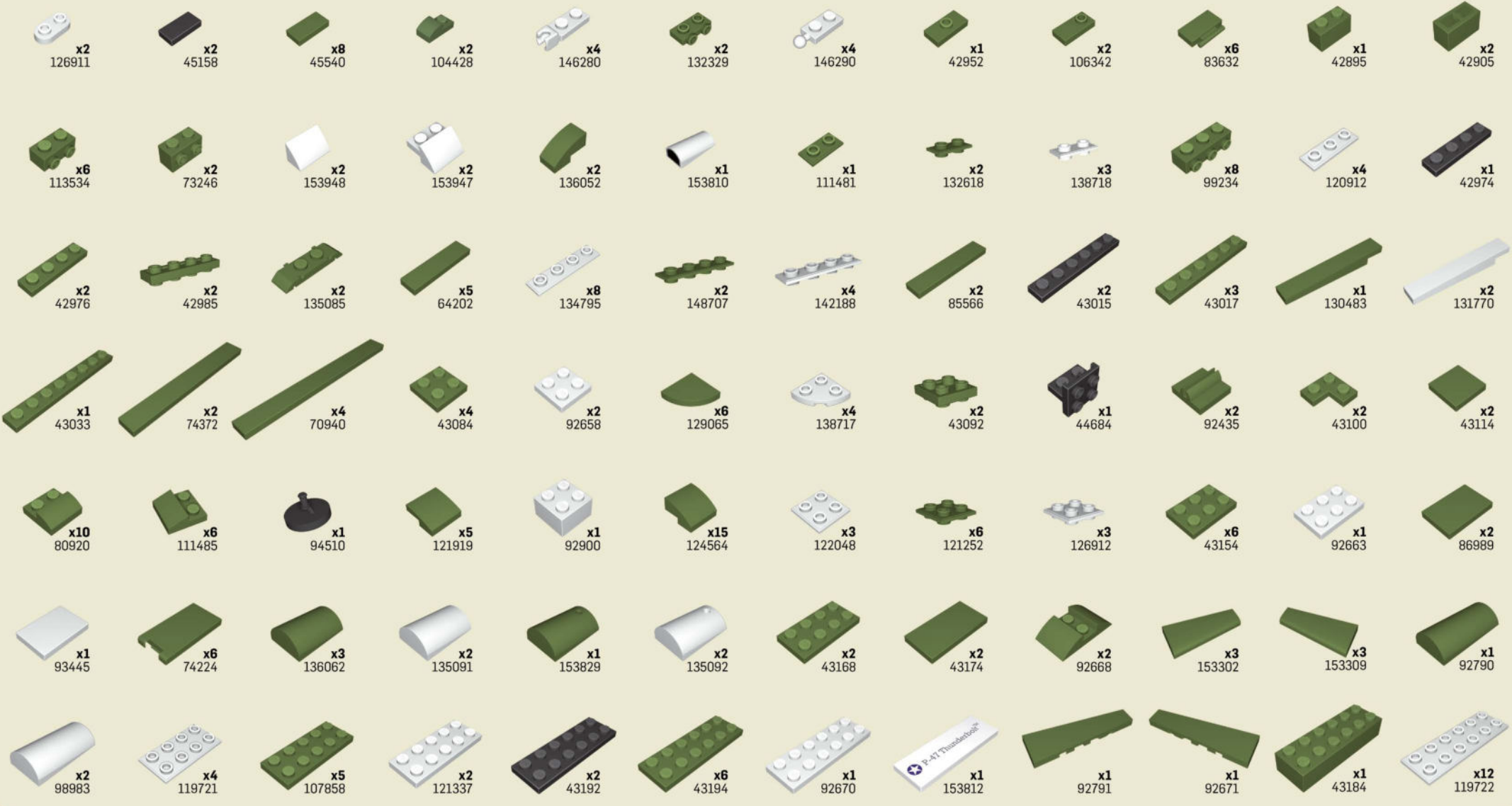
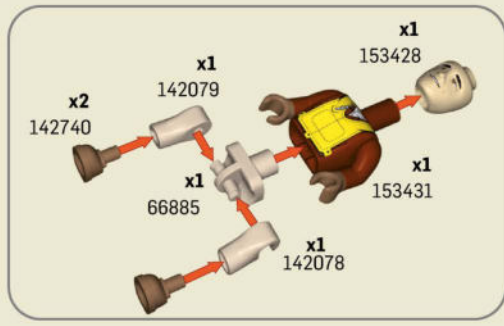

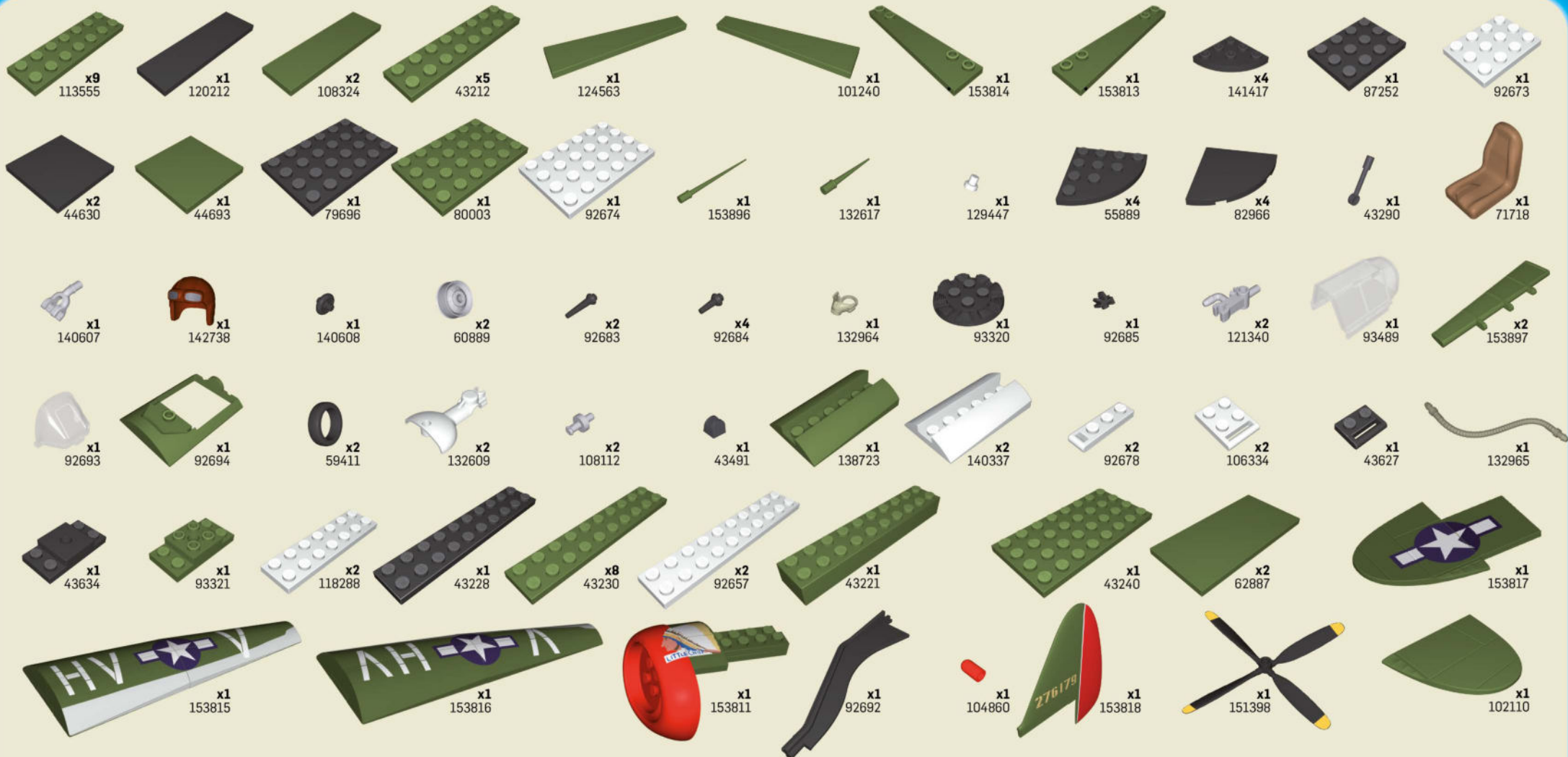



DEWOITINE D.520
🇫🇷 5734

HISTORICAL COLLECTION



F4U-4™ CORSAIR®
🇺🇸 2417



NORTHROP GRUMMAN



JUNKERS JU-88
✚ 5733



De HAVILLAND D.98 MOSQUITO
🇬🇧 5735

WWW.COBIBRICKS.EU

01-05737-476

For news and special deals

Find us on:
f cobibricks
cobi.klocki
📺 COBI SA