

ARMED FORCES



Produced under license from Boeing. Boeing and F/A-18 Hornet are trademarks of The Boeing Company.



F/A-18C HORNET™
 IN US SERVICE - 1983 - PRESENT
 PLACE OF ORIGIN - USA
 ROLE - FIGHTER
 WINGSPAN - 11,7m (38' 5")
 LENGTH - 17,1m (56' 1")
 HEIGHT - 4,7m (15' 5")
 ENGINE - 2x GENERAL ELECTRIC F404-GE-402
 RANGE - 2000km (1070nm)
 RATE OF CLIMB - 250m/s (50000ft/min)
 MAXIMUM FLIGHT LEVEL - 16000m (52493ft)
 MAXIMUM SPEED - 1,8MACH
 ARMAMENT - 1x 20mm M61A1 GATLING CANNON,
 2x AIM-9X, 4x AIM-120B AMRAAM
 OR AIM-120C-7 AIR-TO-AIR MISSILES
 CREW - 1 PILOT

5810

PAD PRINTED
NO STICKERS

Printed in EU



**UK
CA**



WARNING: CHOKING HAZARD-
 Toy contains small parts.
 Not for children under 3 years.

538

F/A-18C HORNET™

SCALE 1:48

1

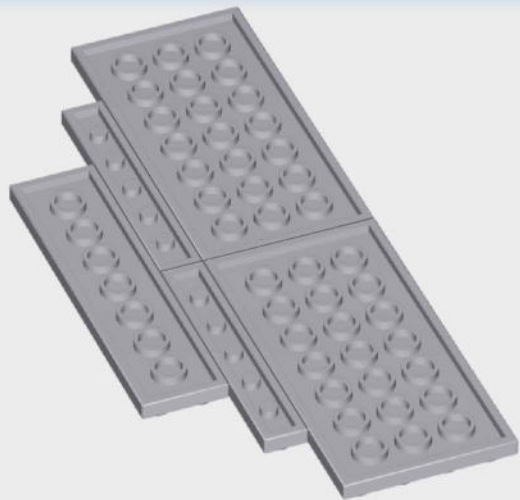

2

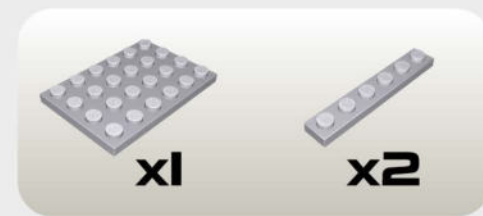
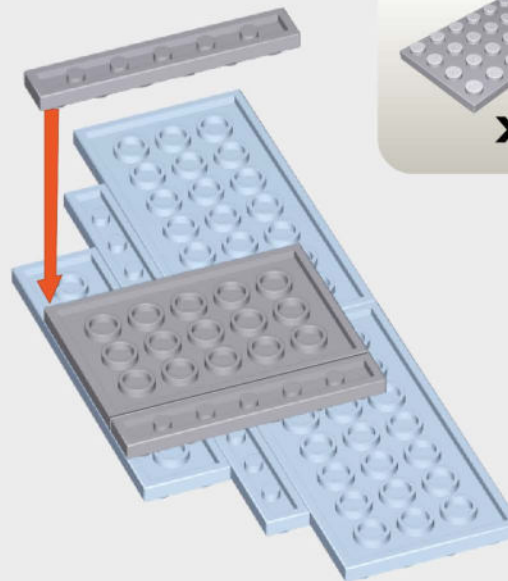

3

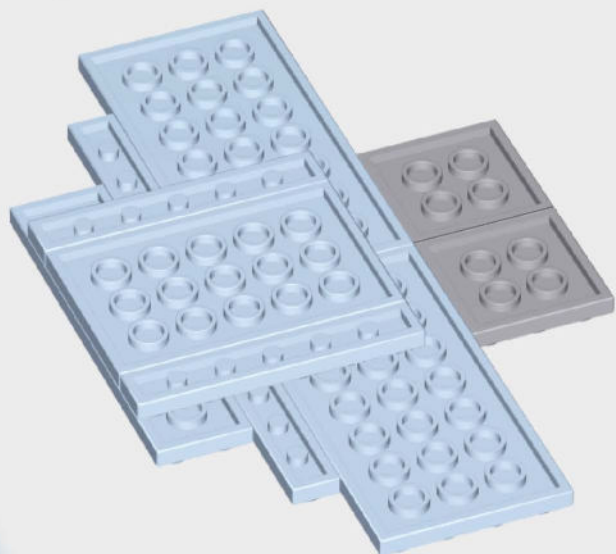

4

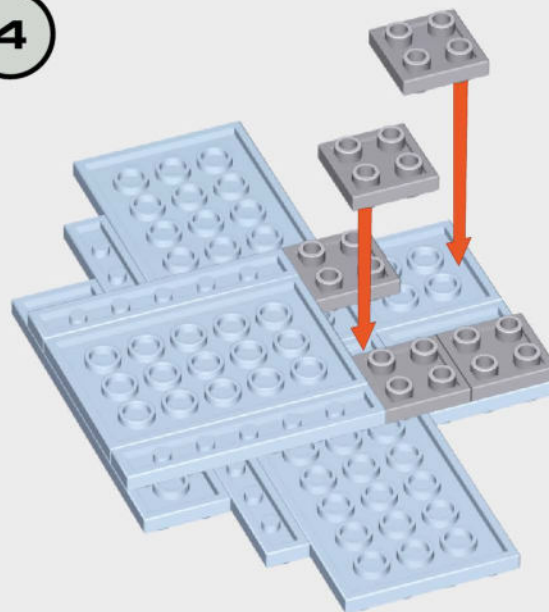

5

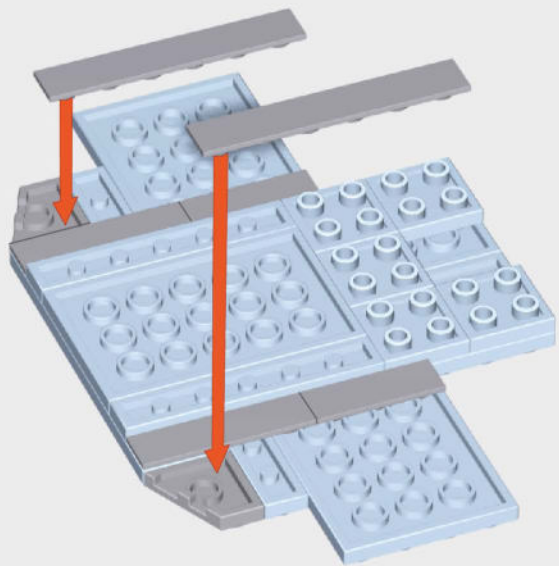

6

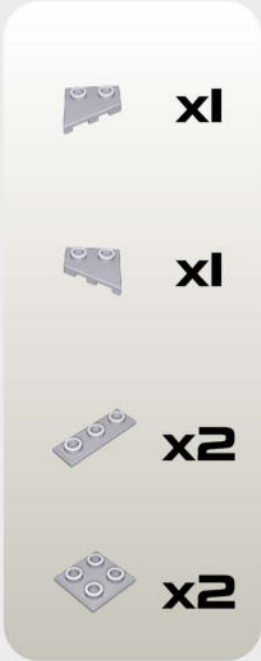
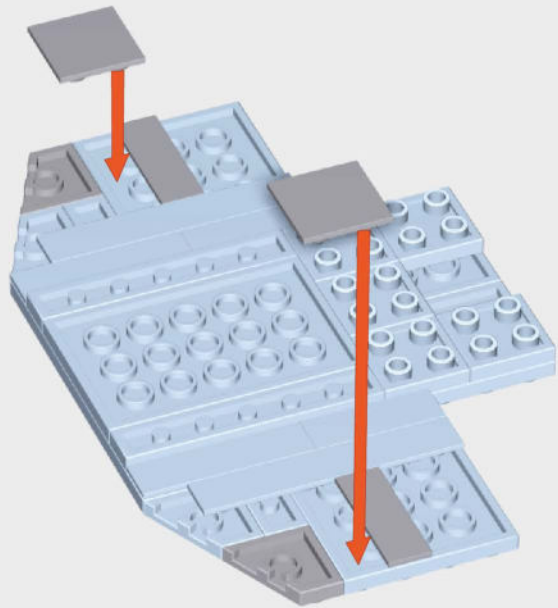

7

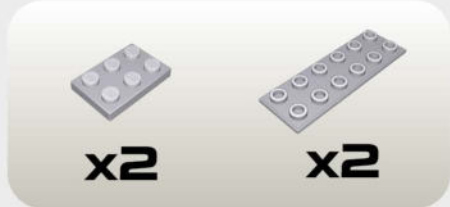
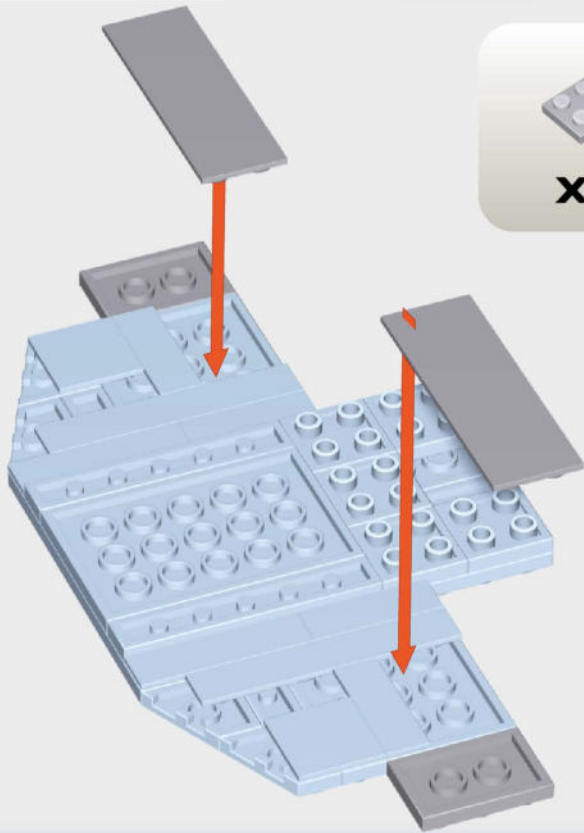

8

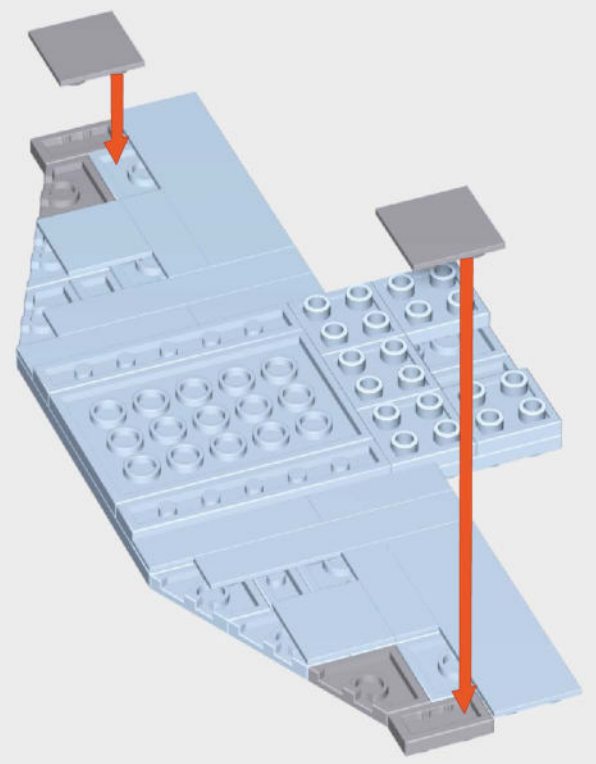

	
x1	x1
	
x2	x2

9

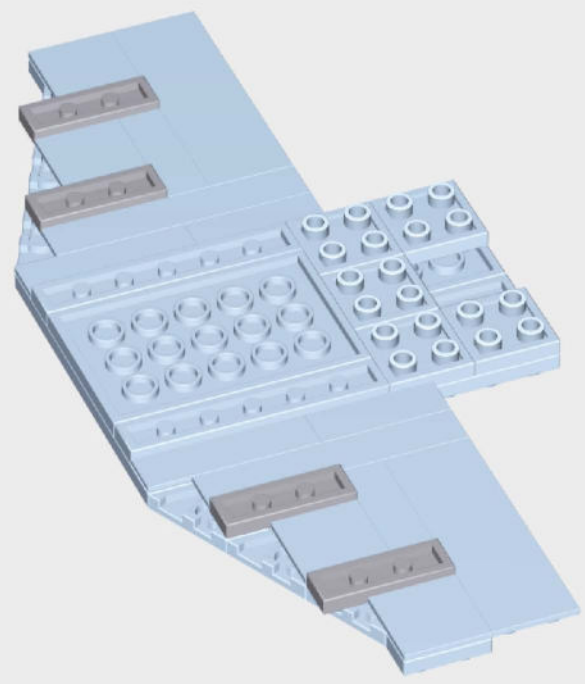

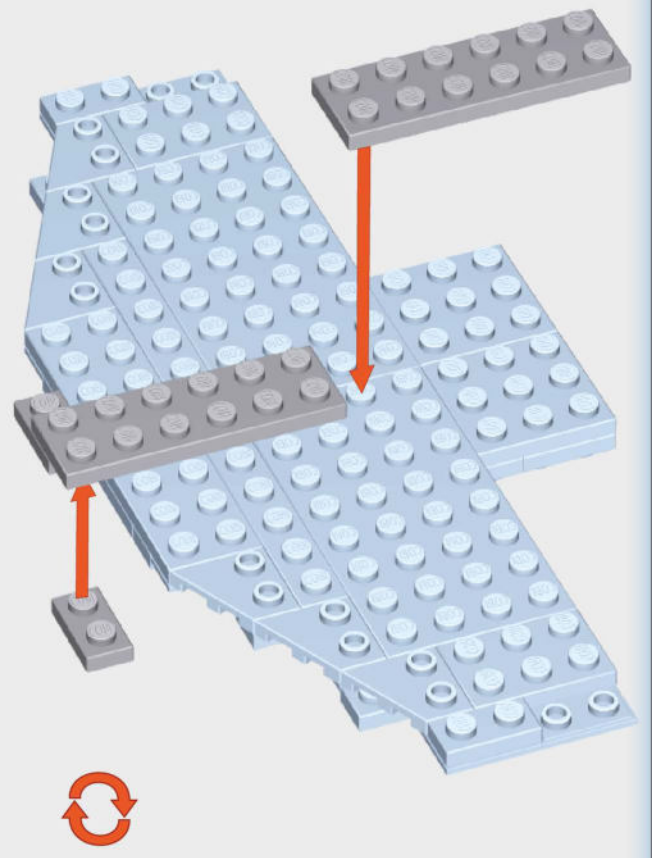

x4

10

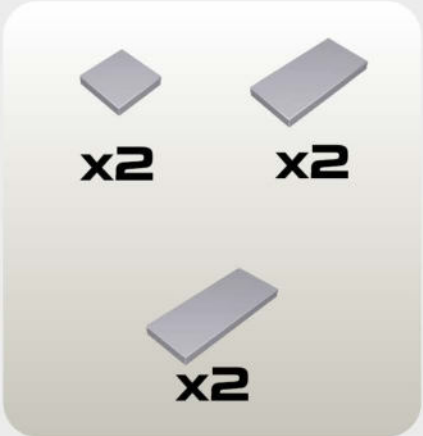
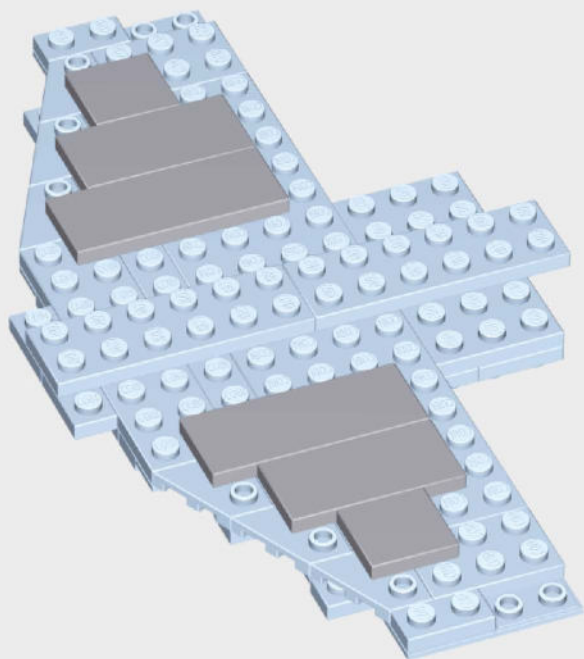

	
x2	x2

11



12

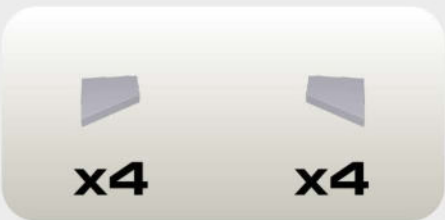
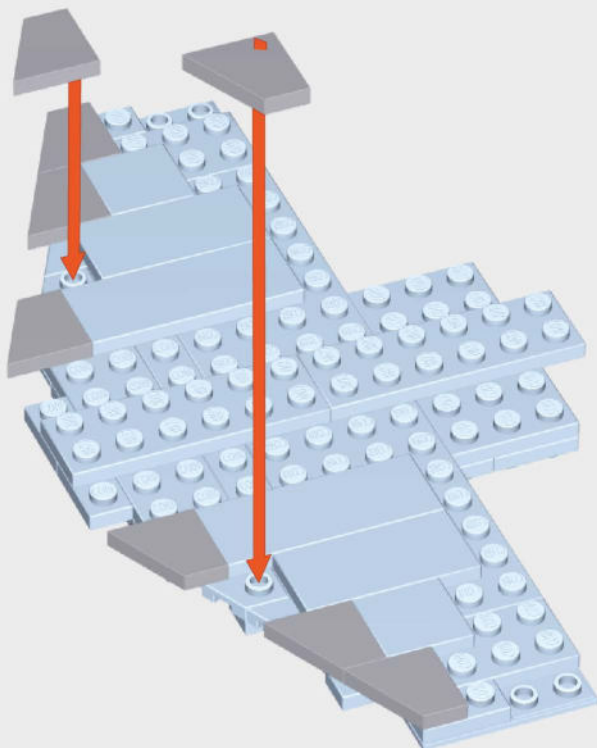

13

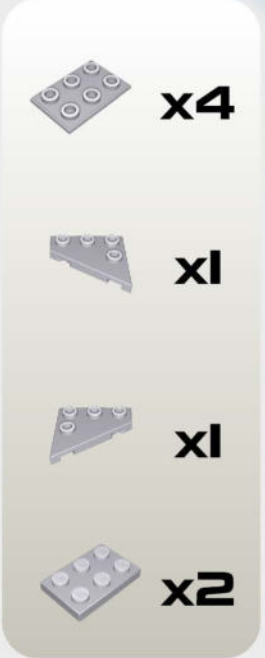
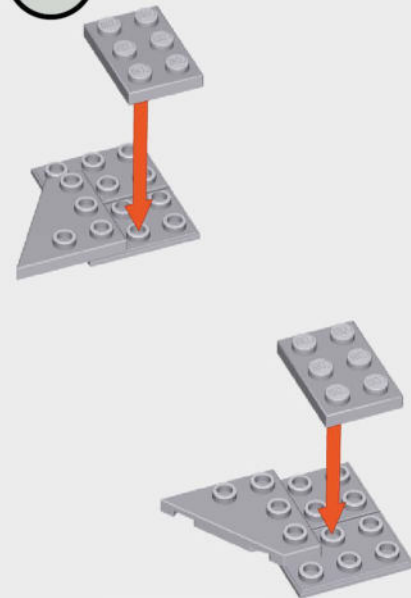



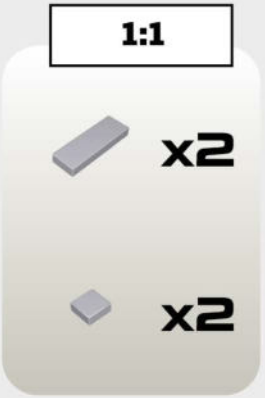
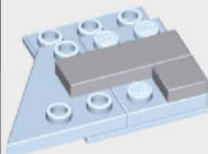

14

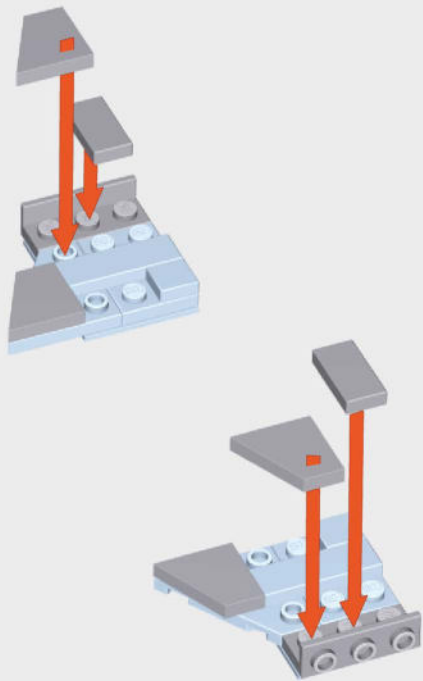

15



	
x2	x2
	
x2	x2
1:1	

16

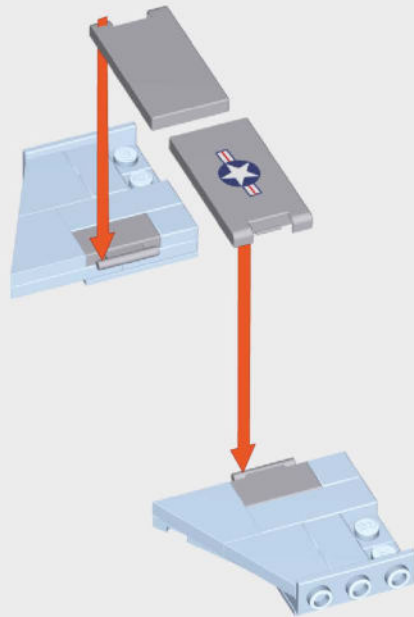

		
x2	x1	x1

17

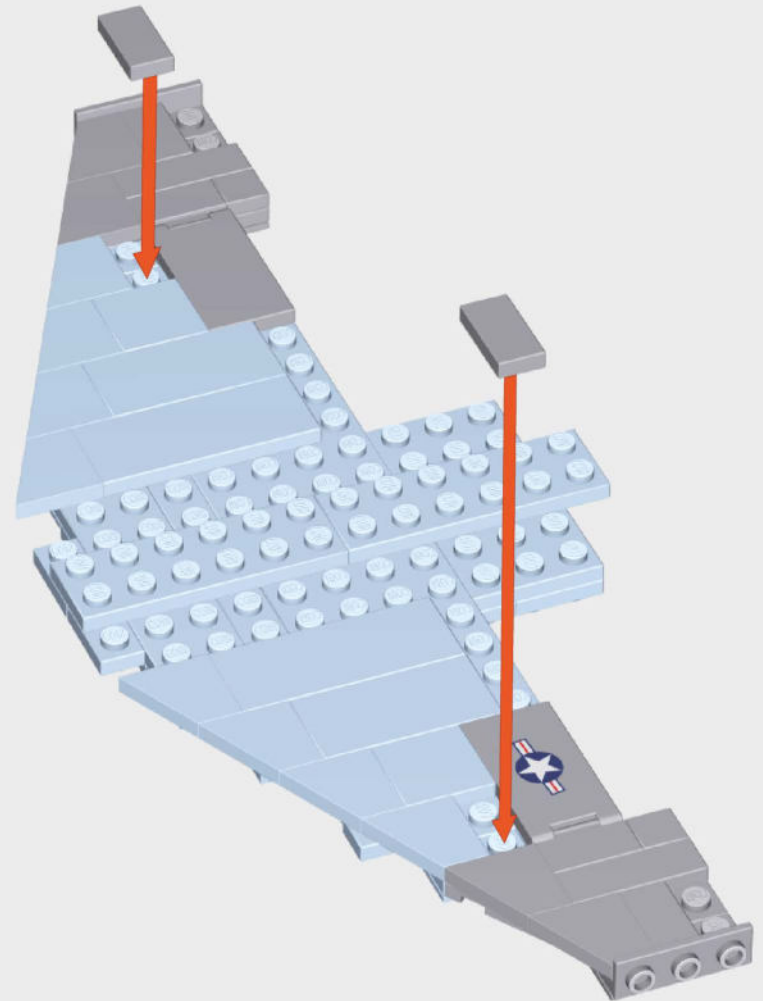

1:1

x2

18

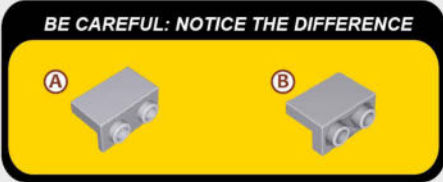
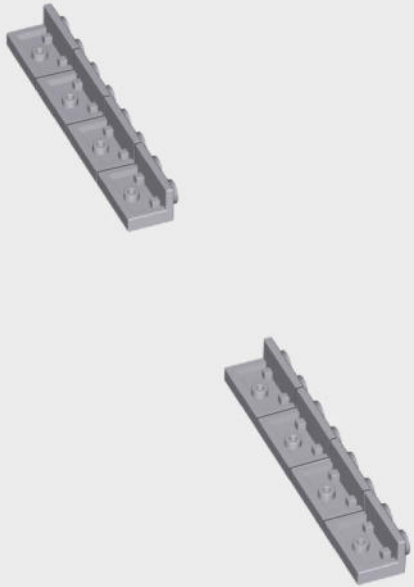

19

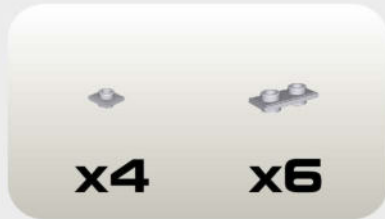
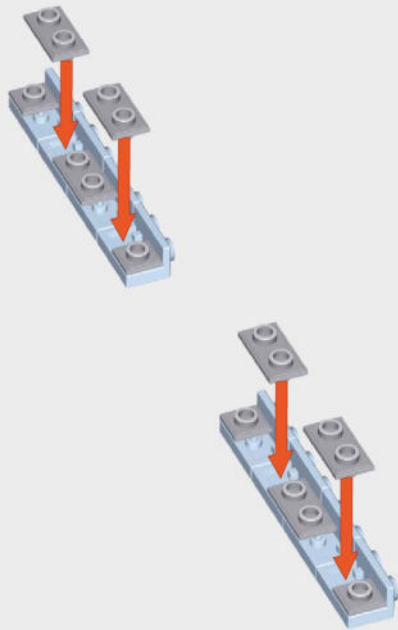

20

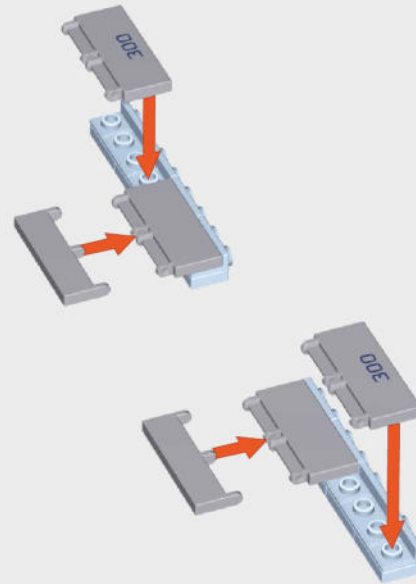

21

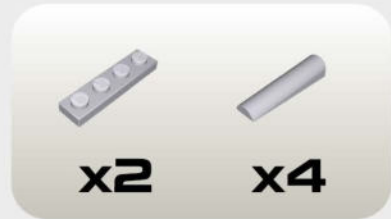
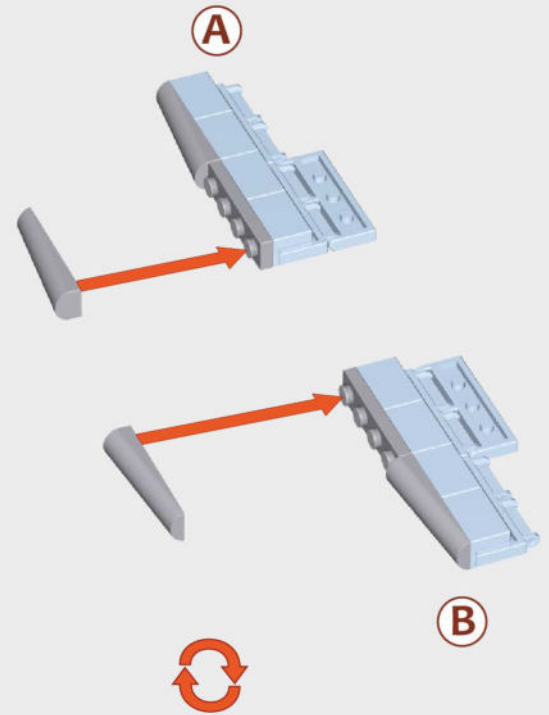

22

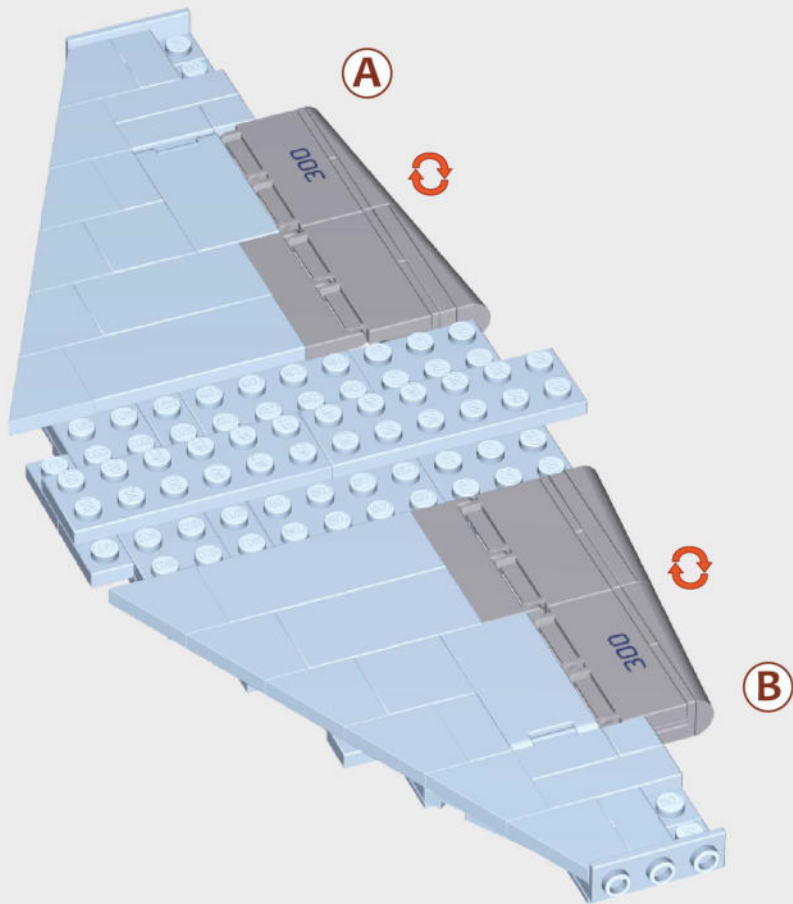

23

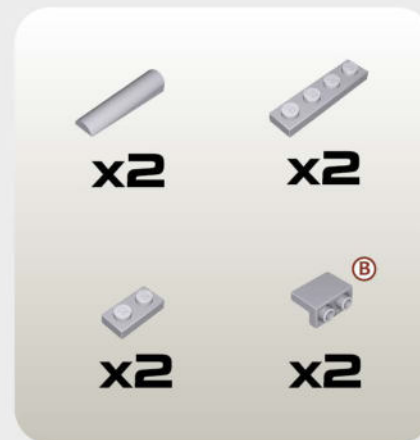
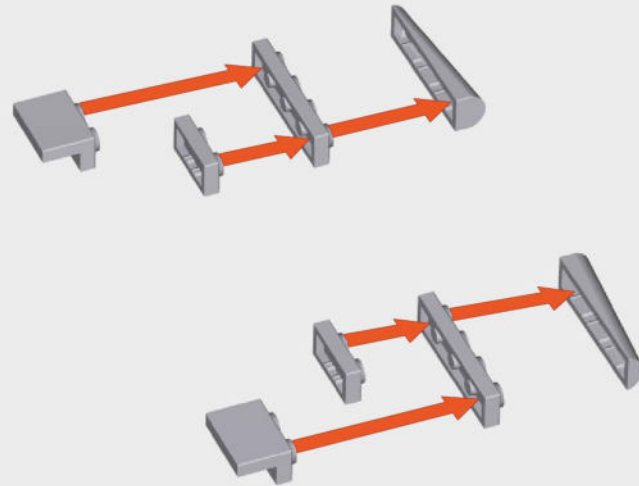

24

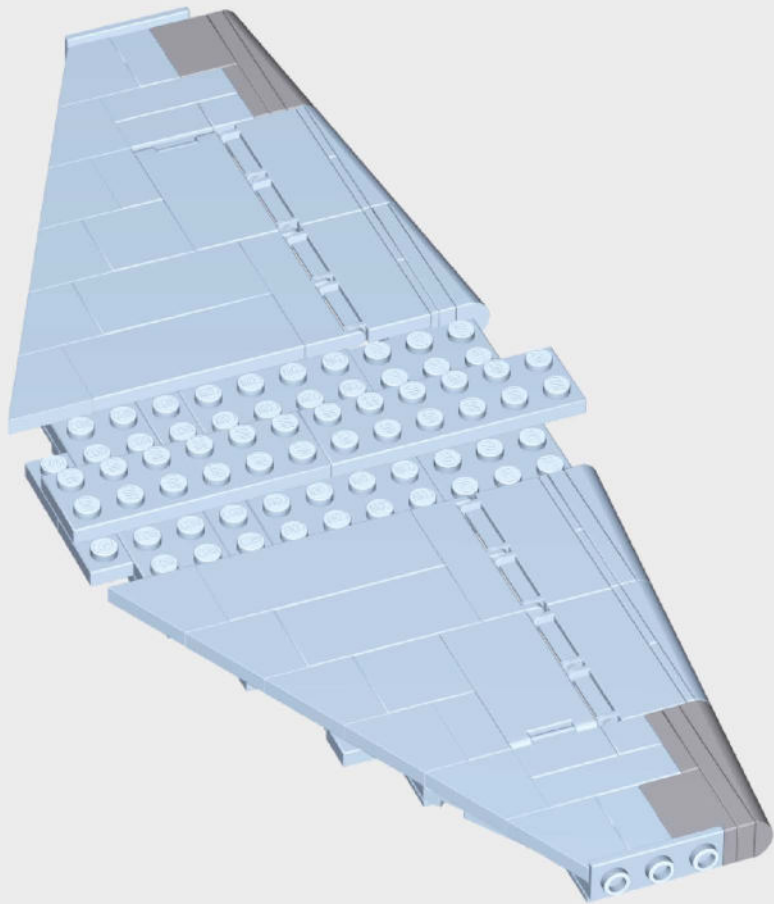

25

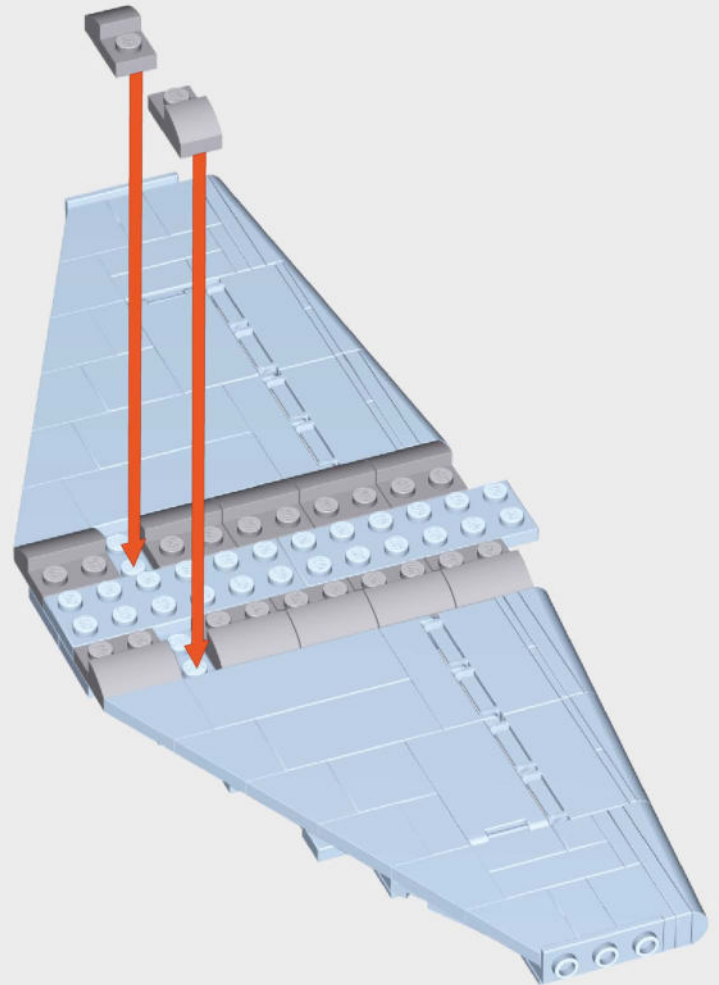

x2



x10

26

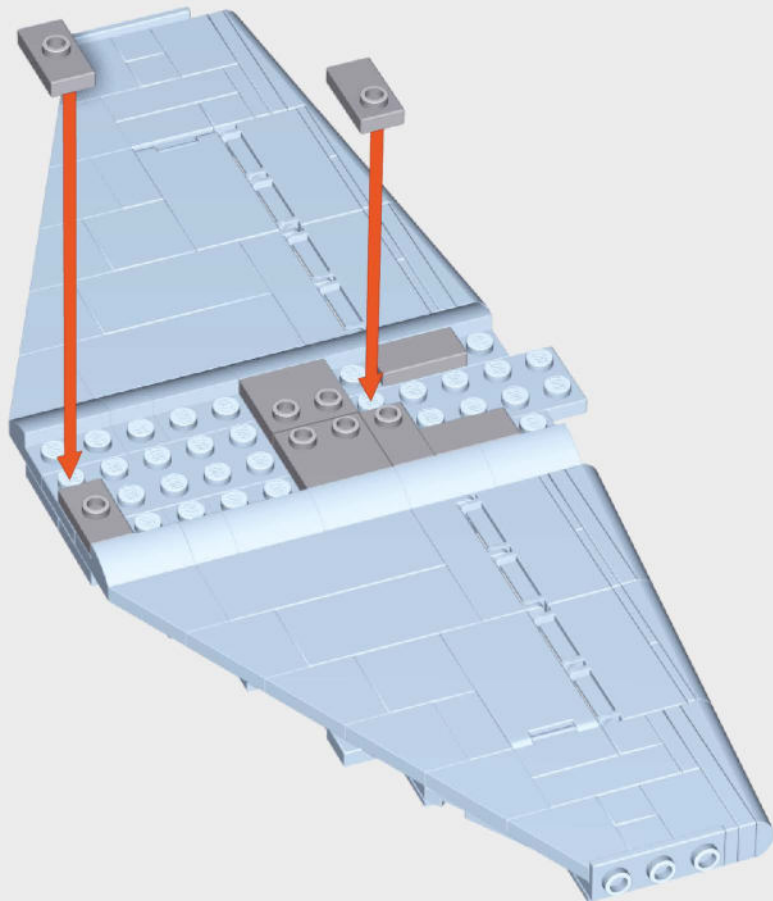

1:1



x2



x2



x2



x2

27

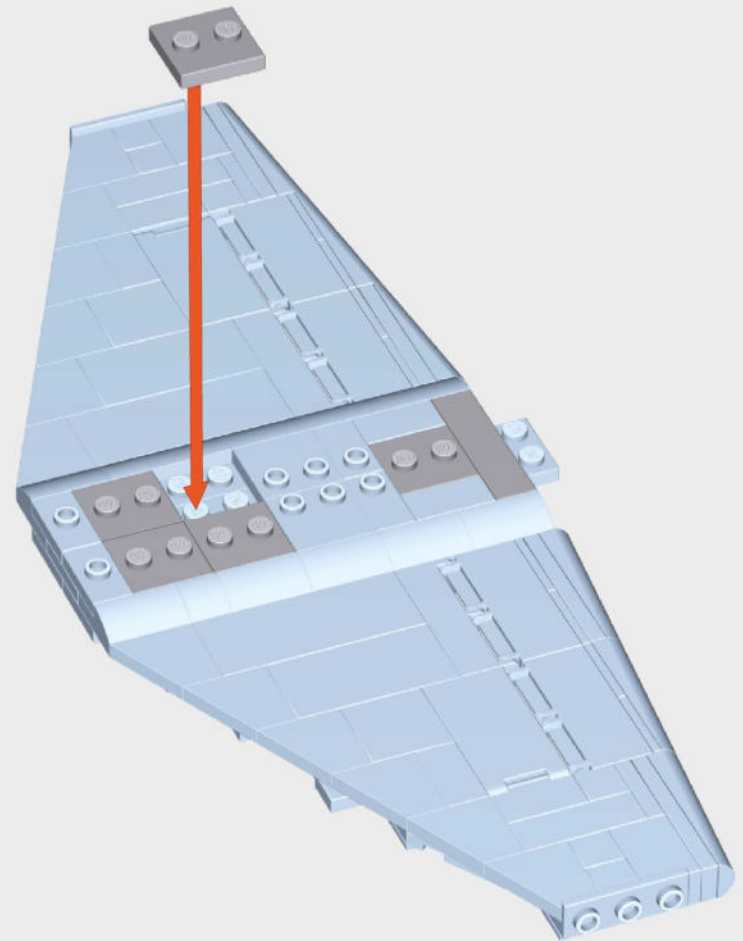

1:1



x1



x5

28

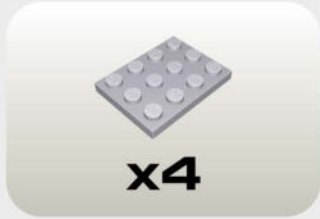
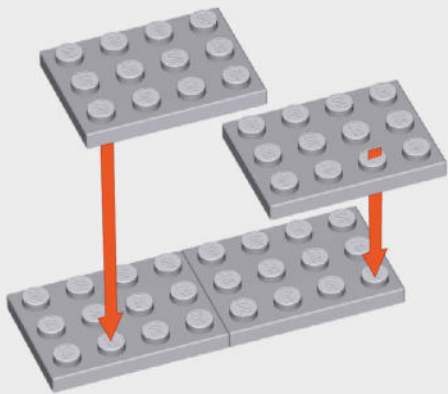

29



30

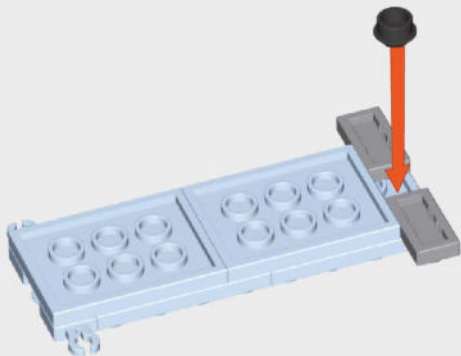

31

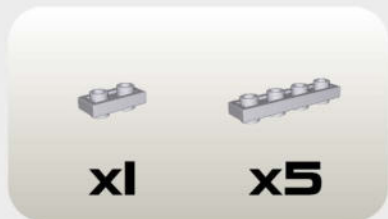
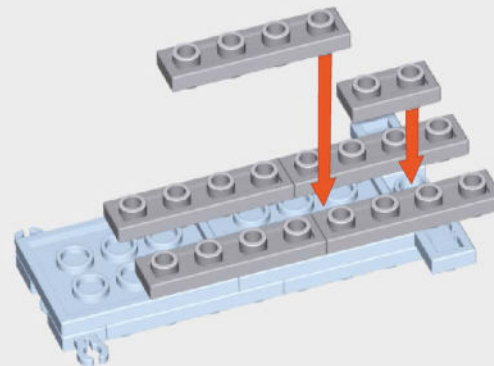

32

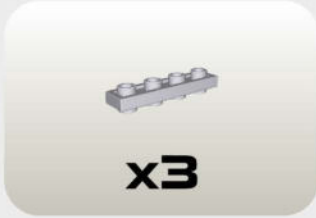
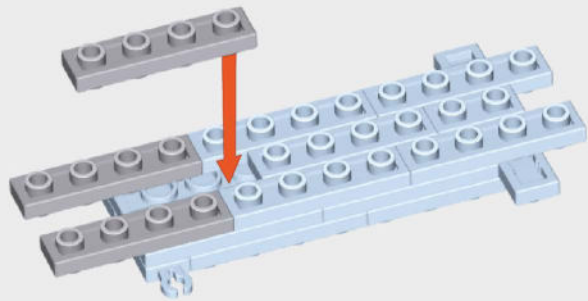

33

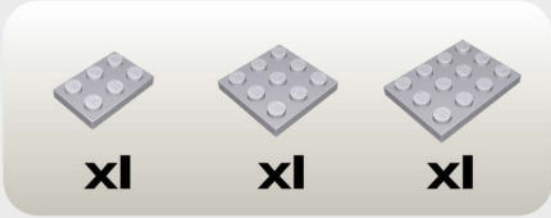
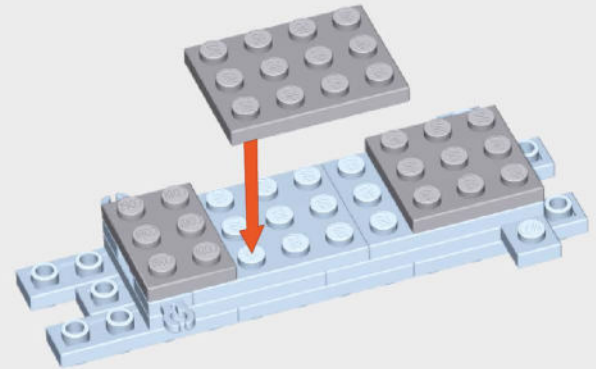

34

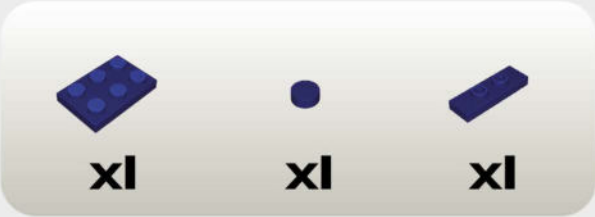
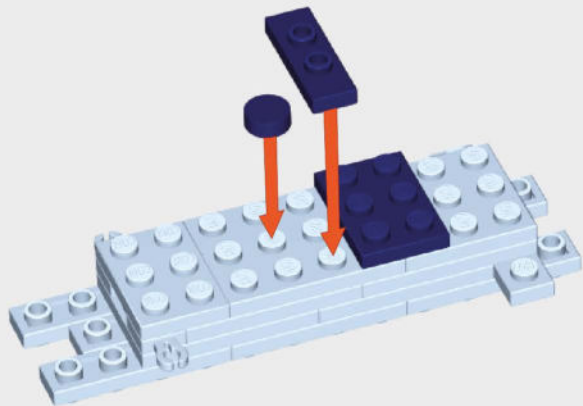

35

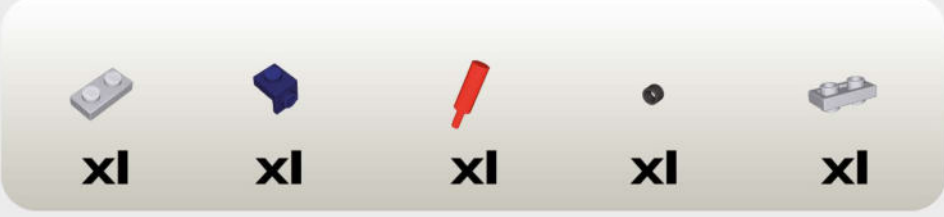
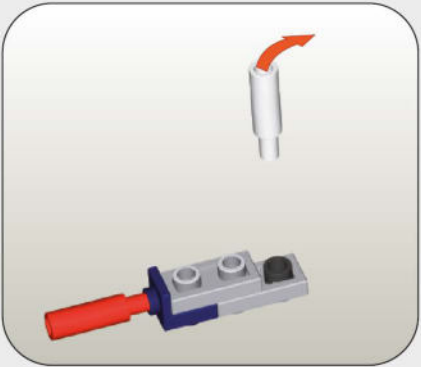
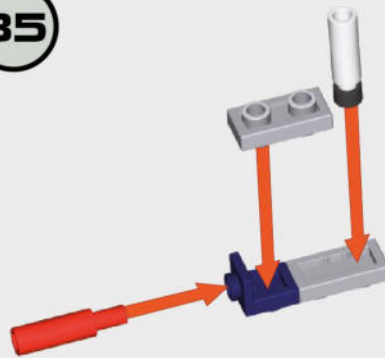

36

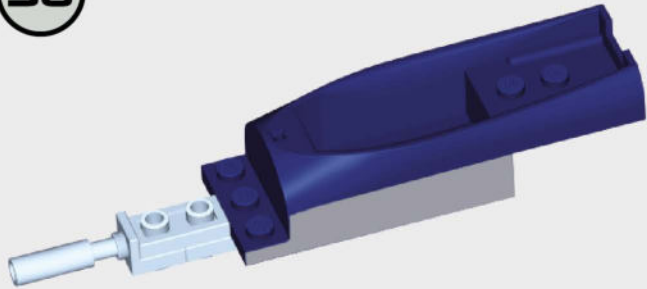

x1

37

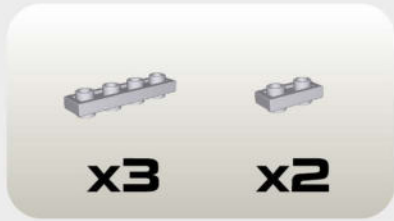
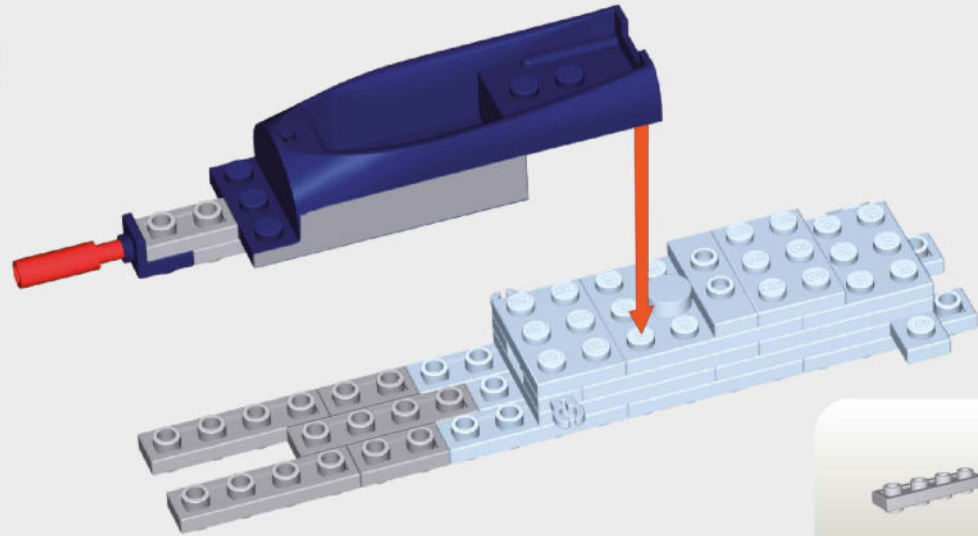

x3

x2

38

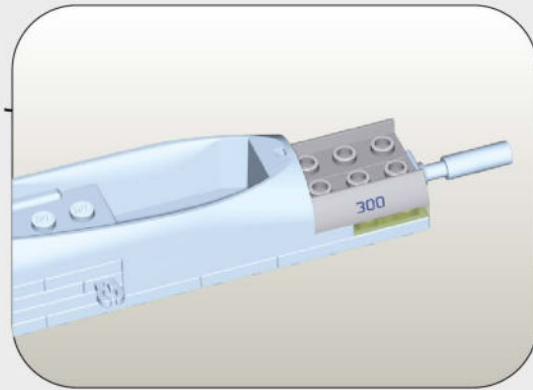
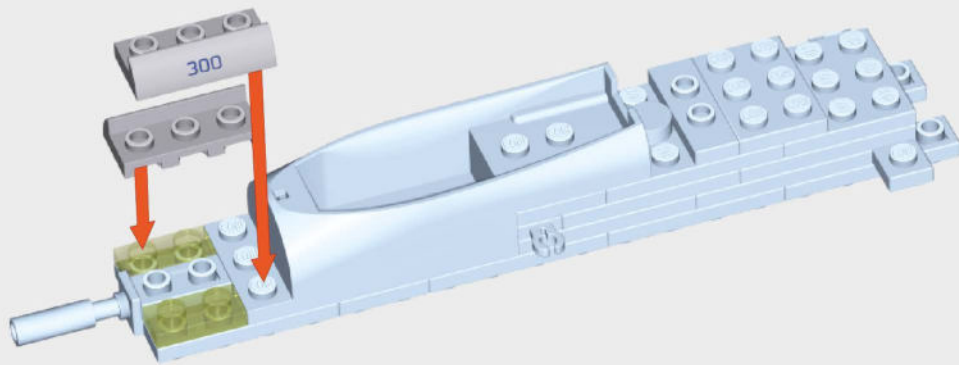

x2

x2

39

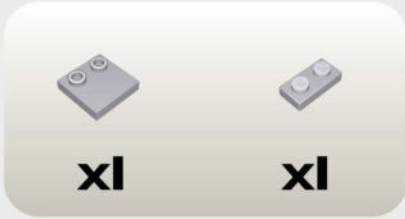
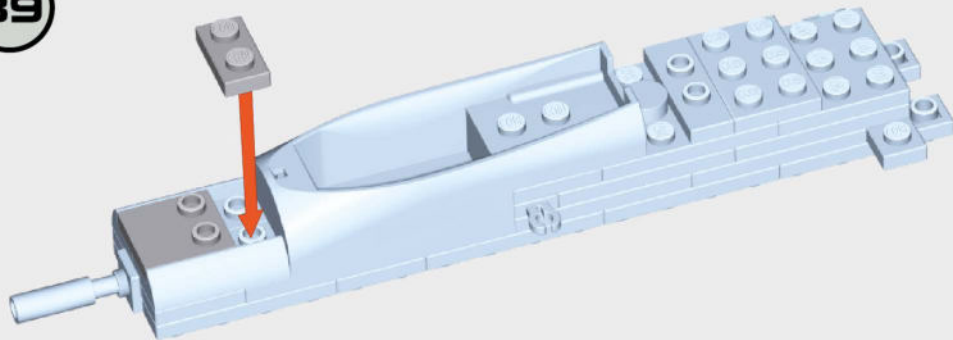

40

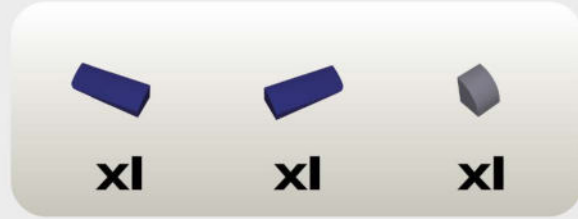
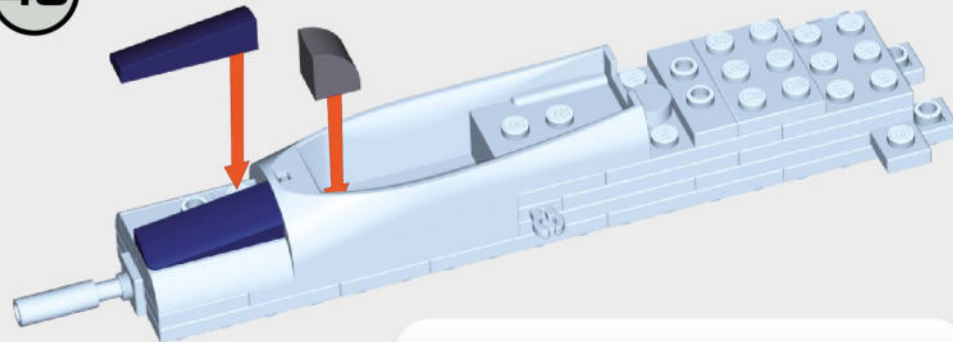

41

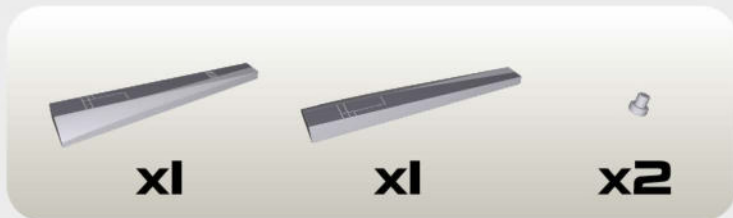

42

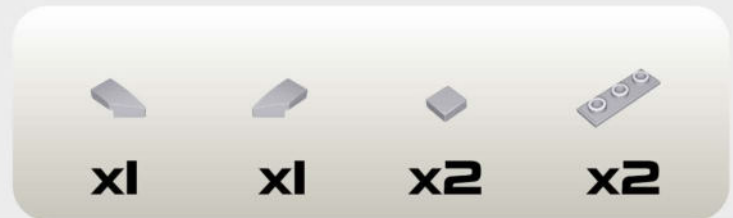
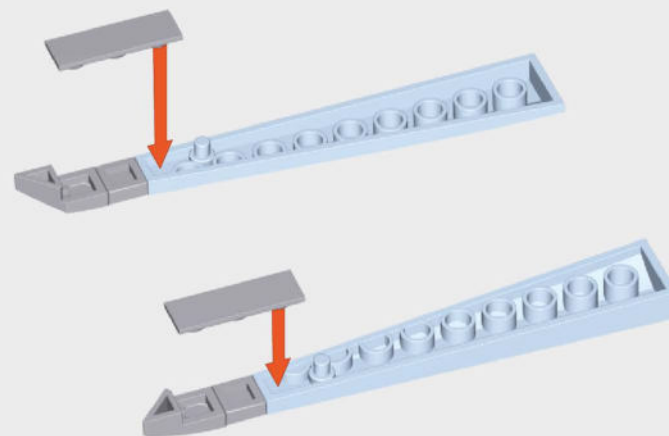

43

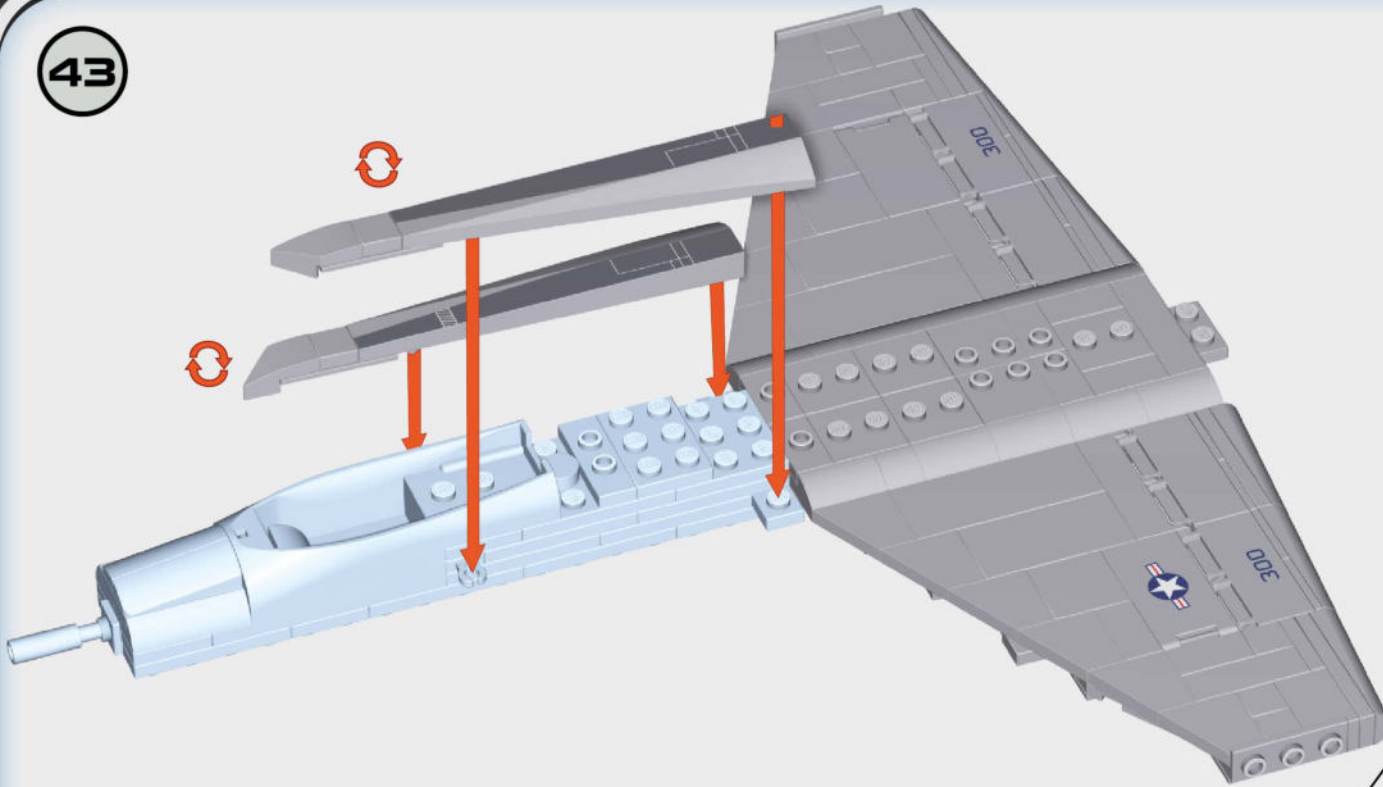

44

- | | |
|---|---|
|  |  |
| x2 | x1 |
|  |  |
| x2 | x2 |

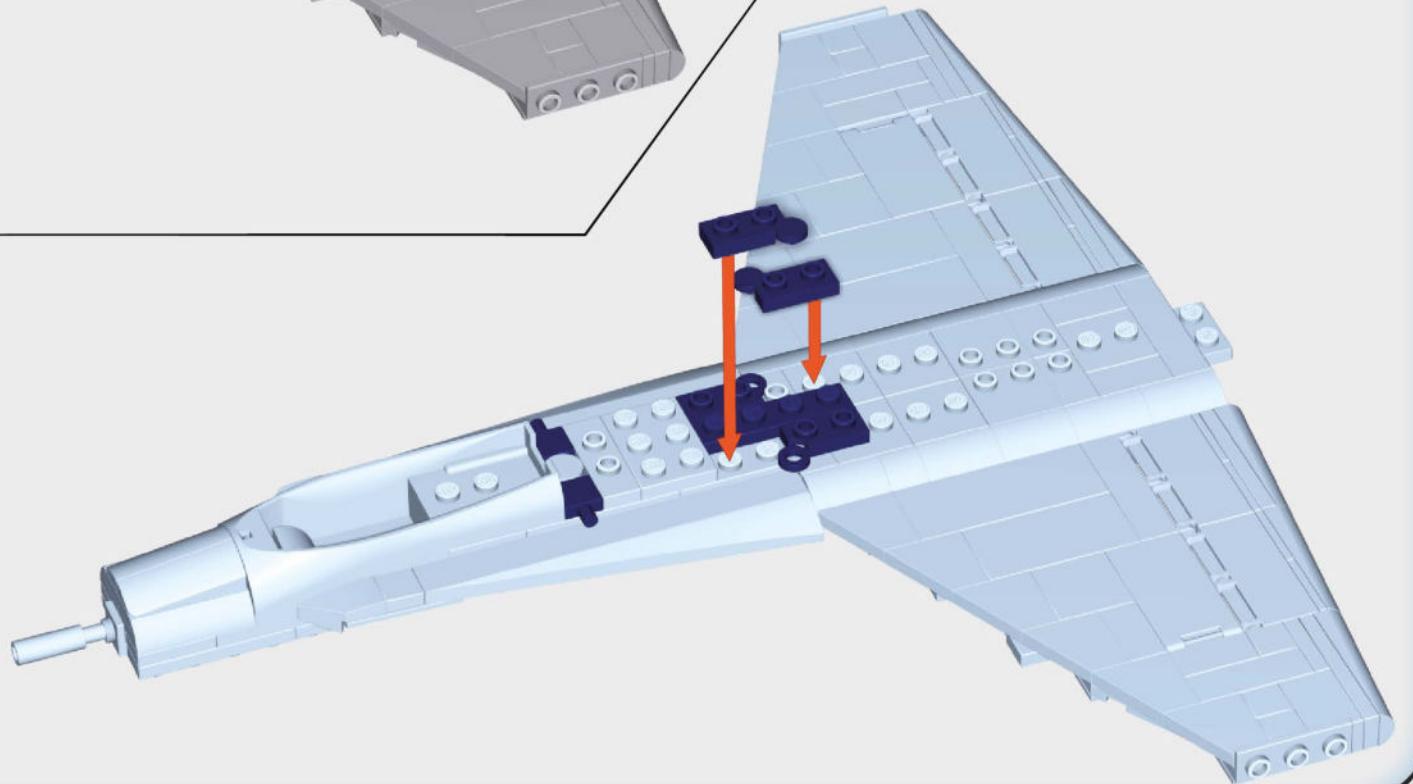

45

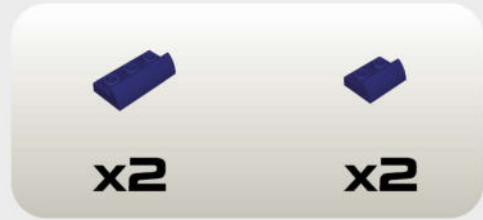
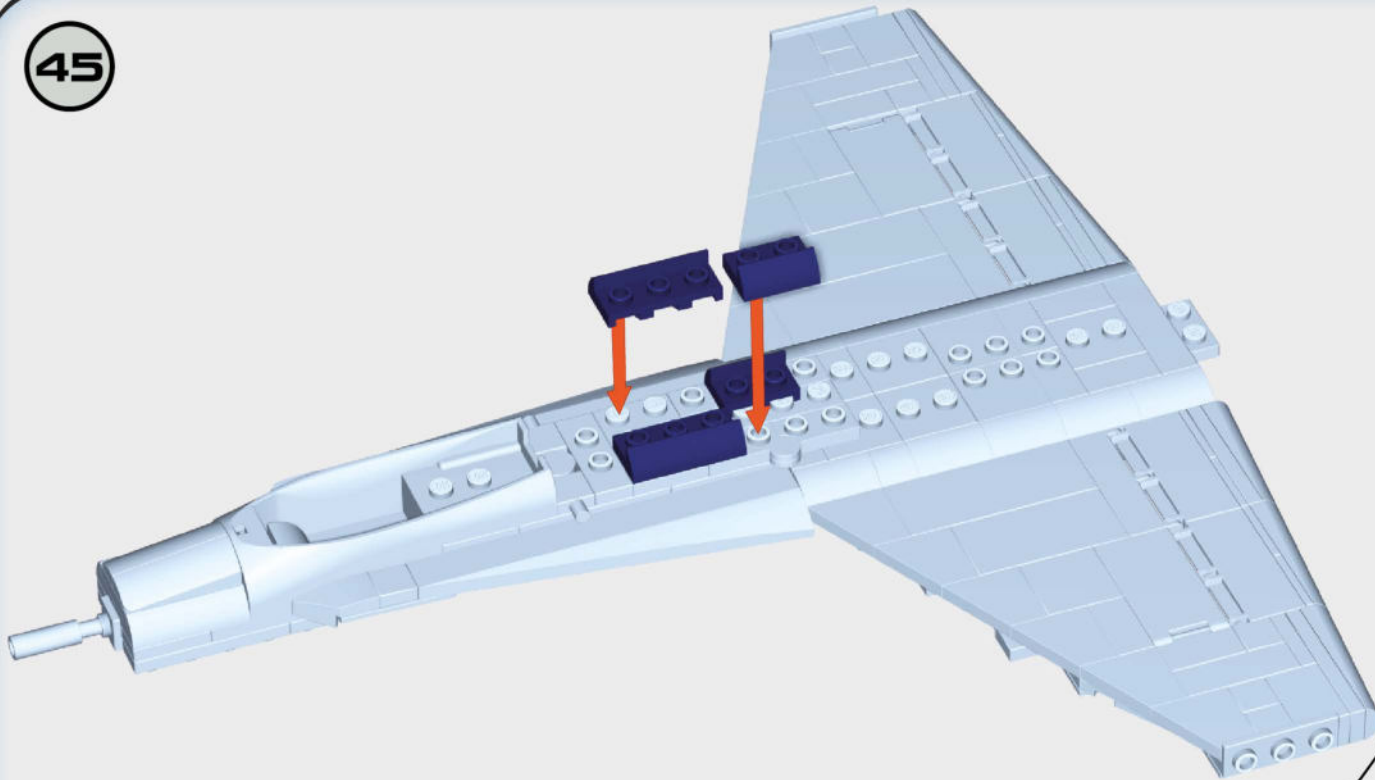



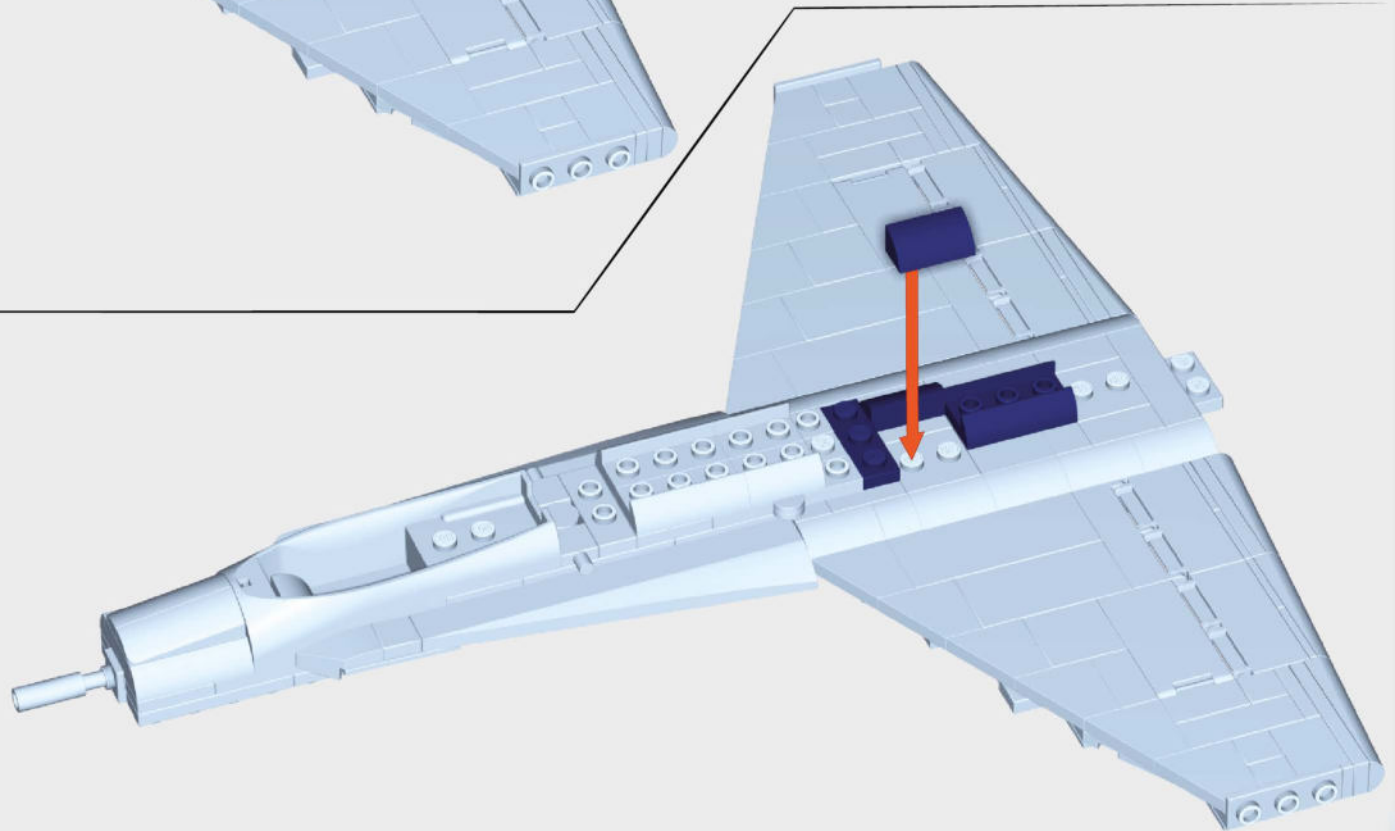

46

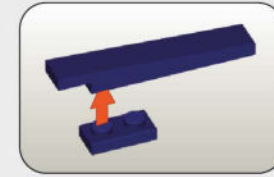
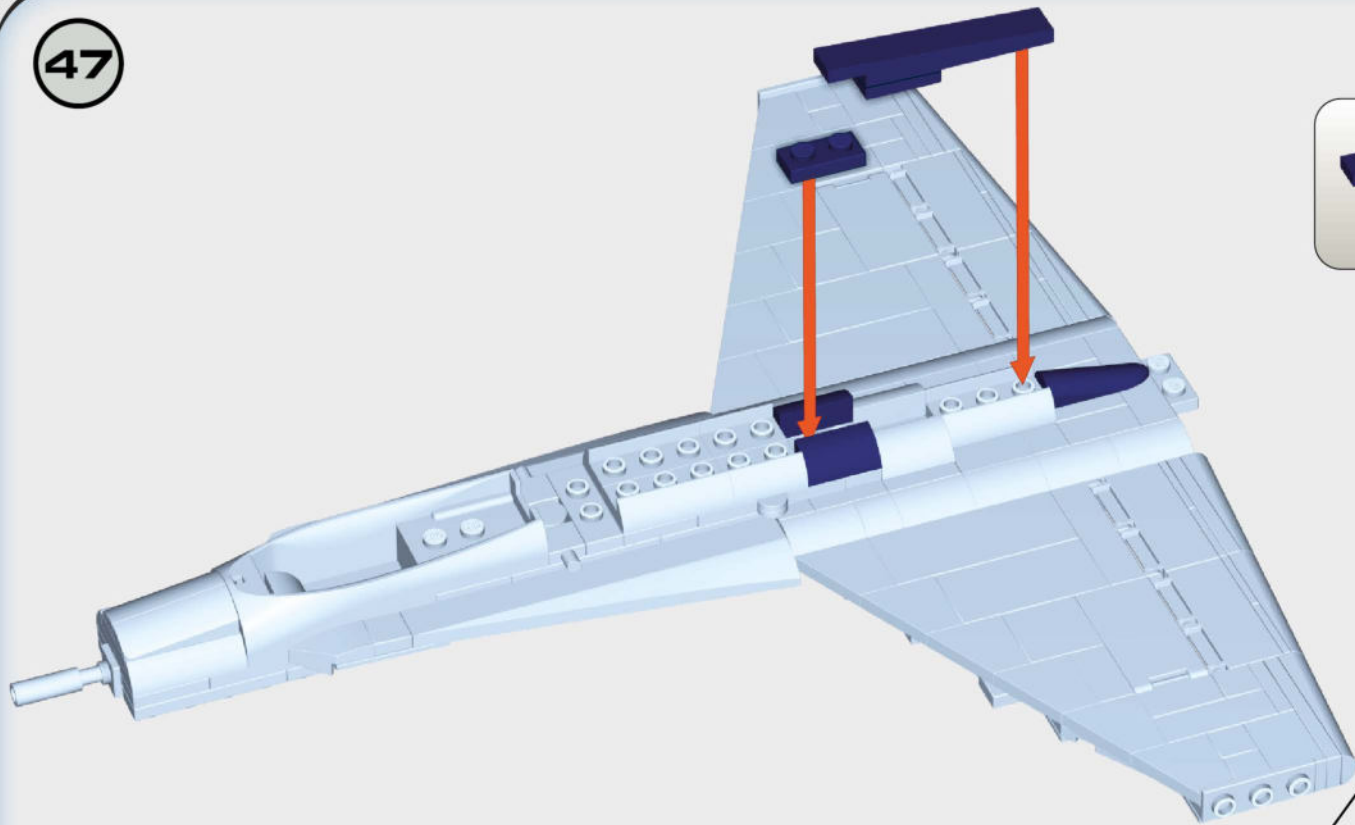

47



	
x2	x1
	
x2	x1

48

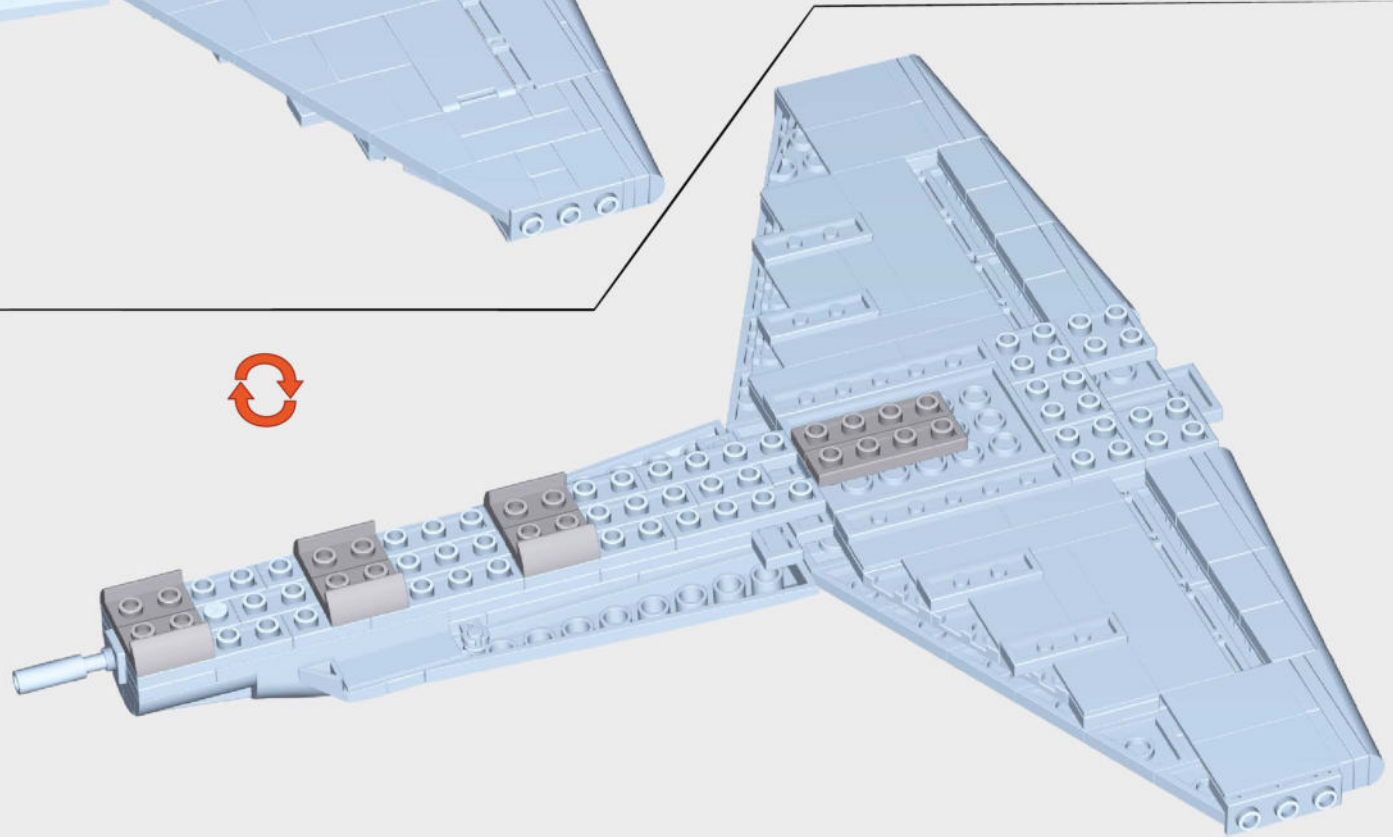

	
x6	x2

49

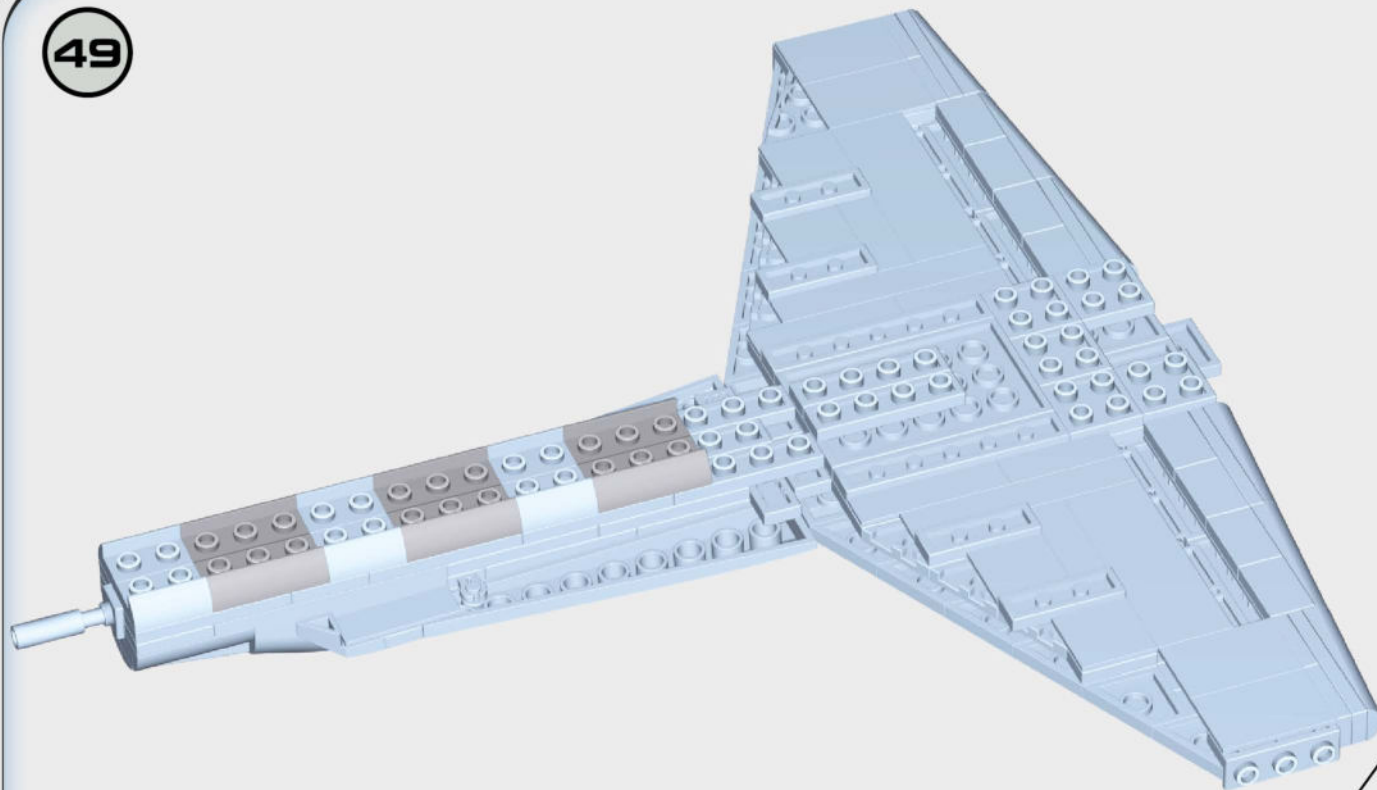

50

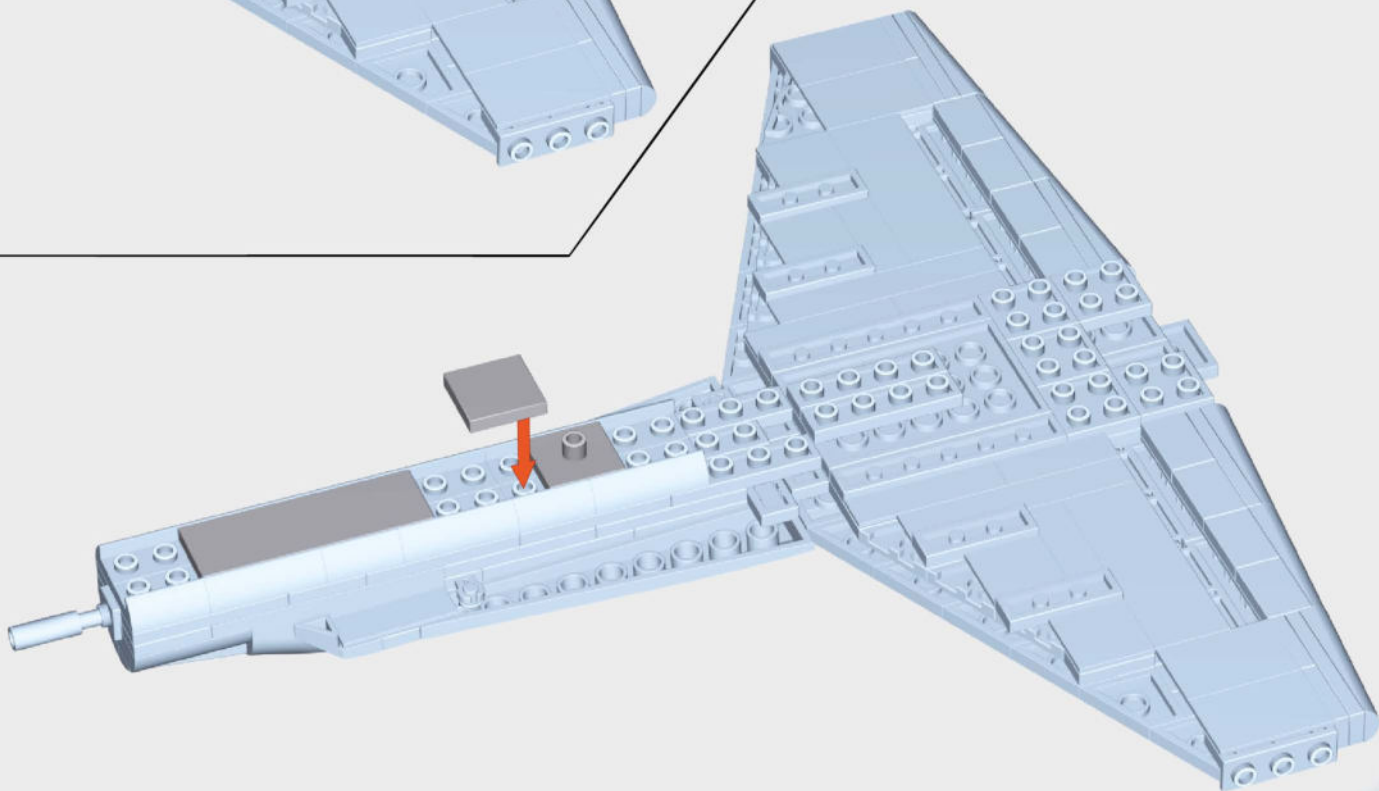

51

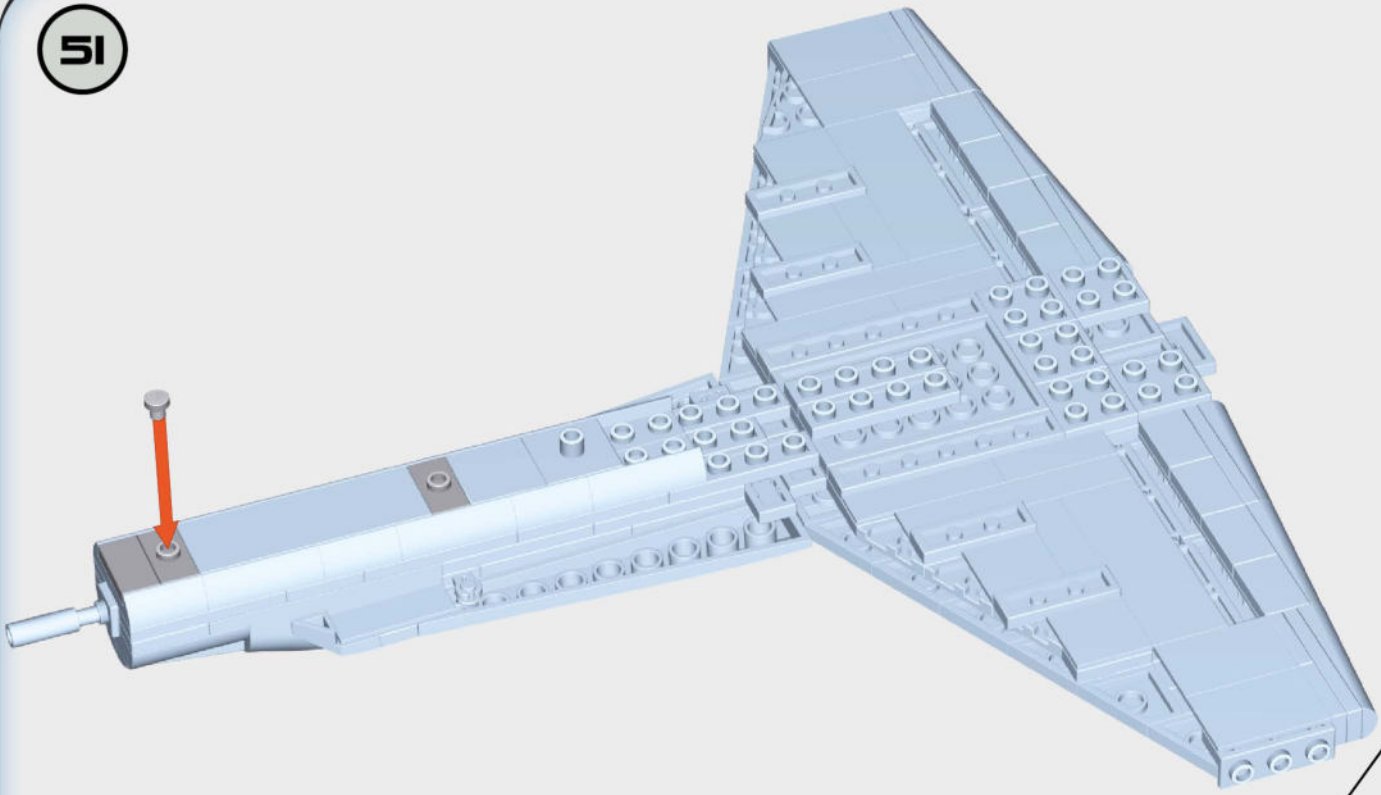

1:1



52

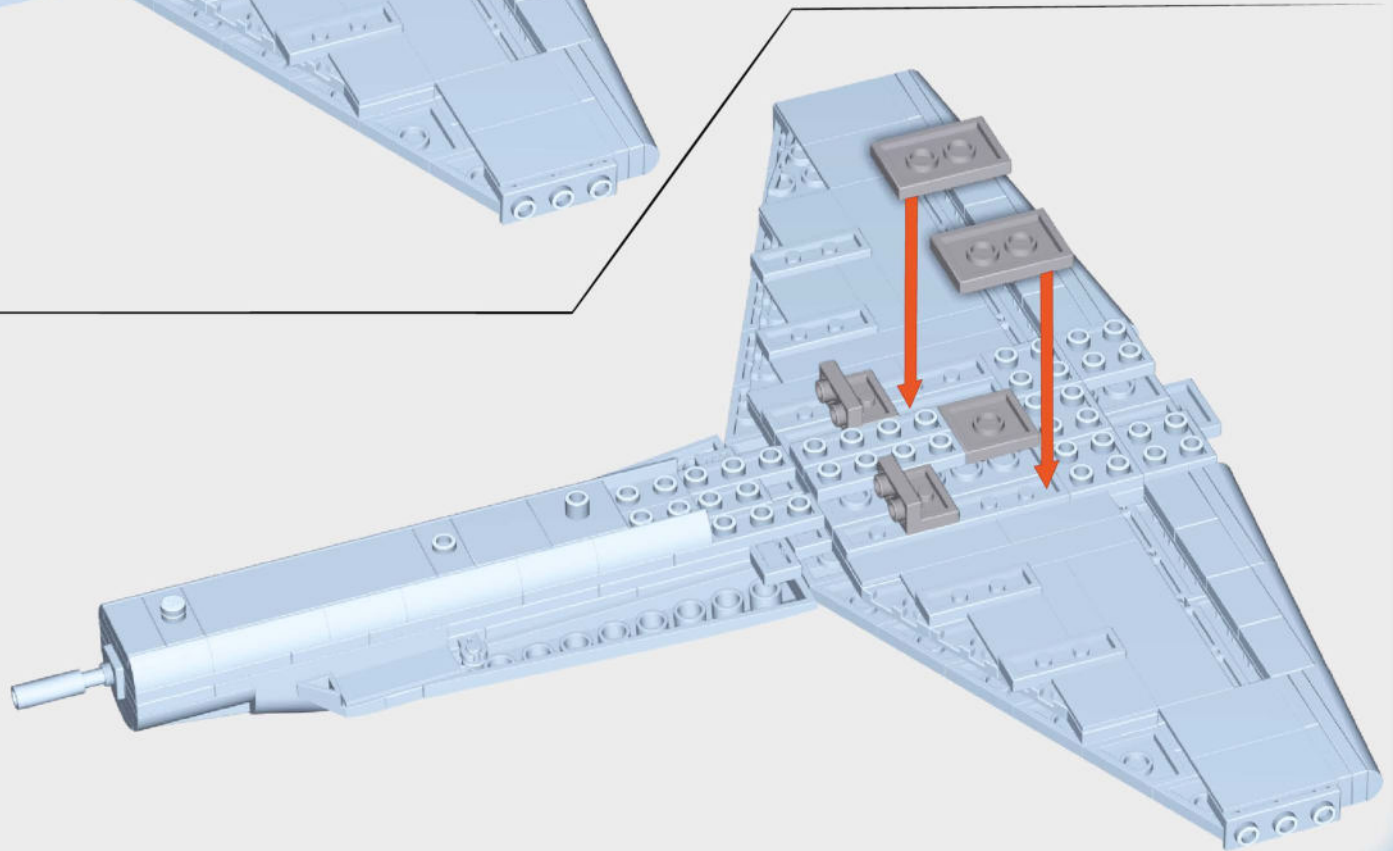

53

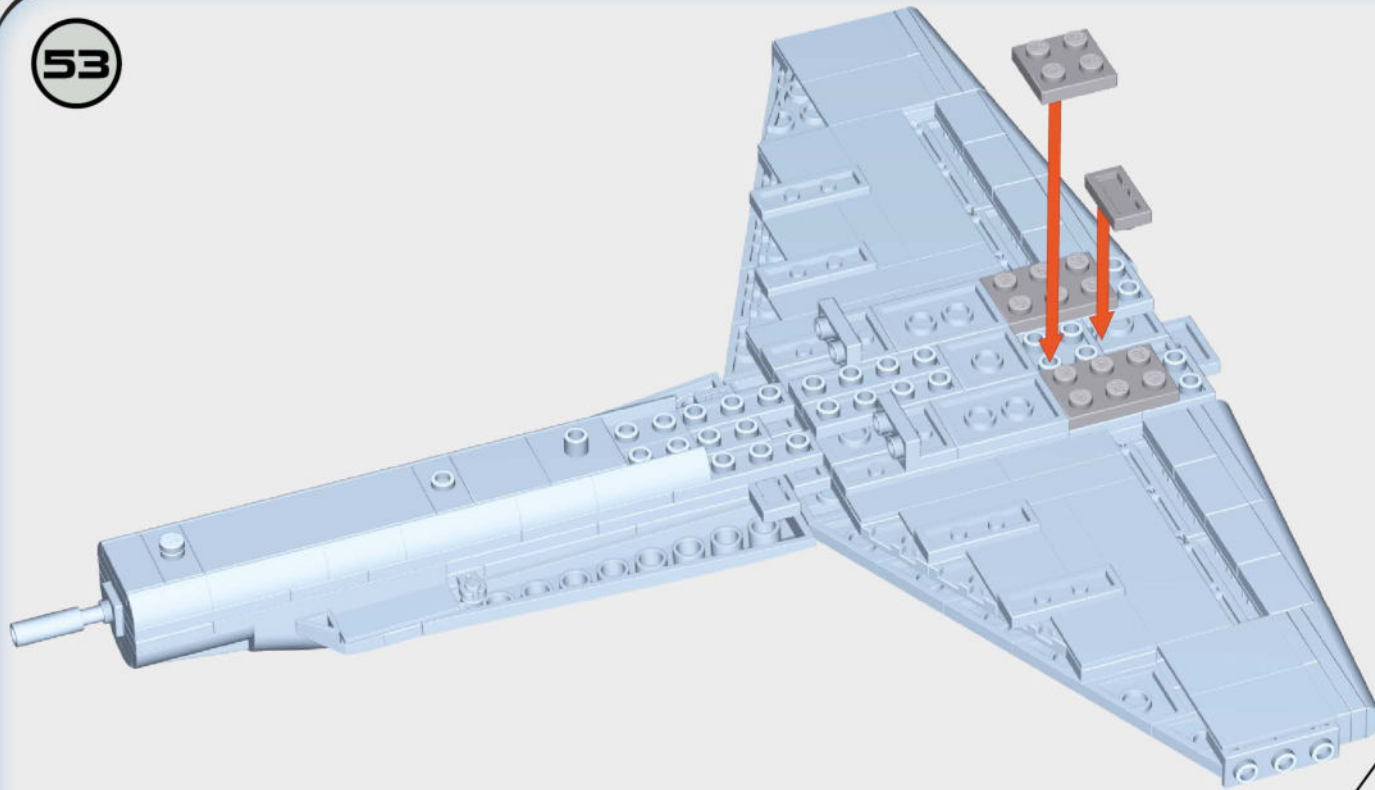

Legend for step 53:

-  x2
-  x1
-  x1

54

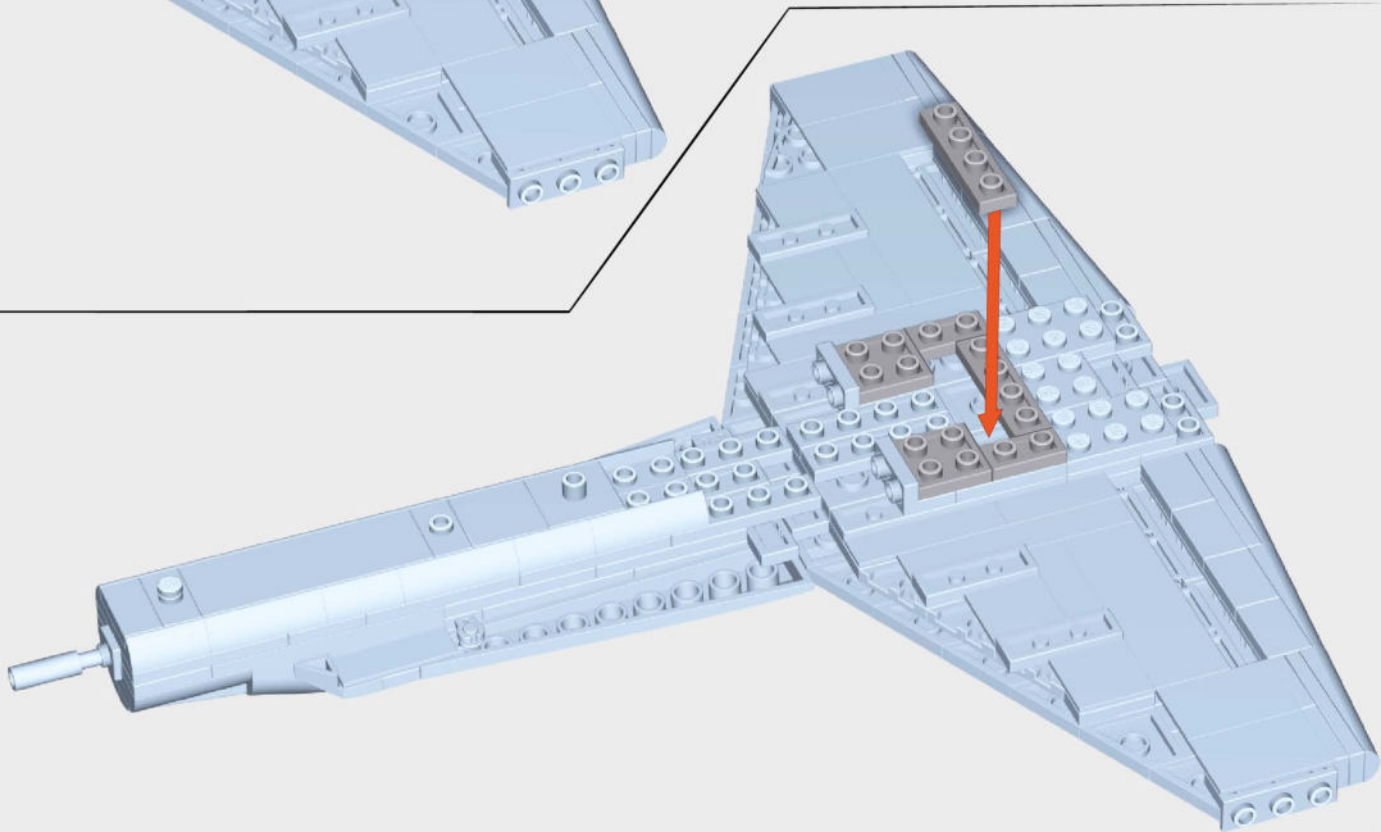

Legend for step 54:

-  x2
-  x2
-  x2

55

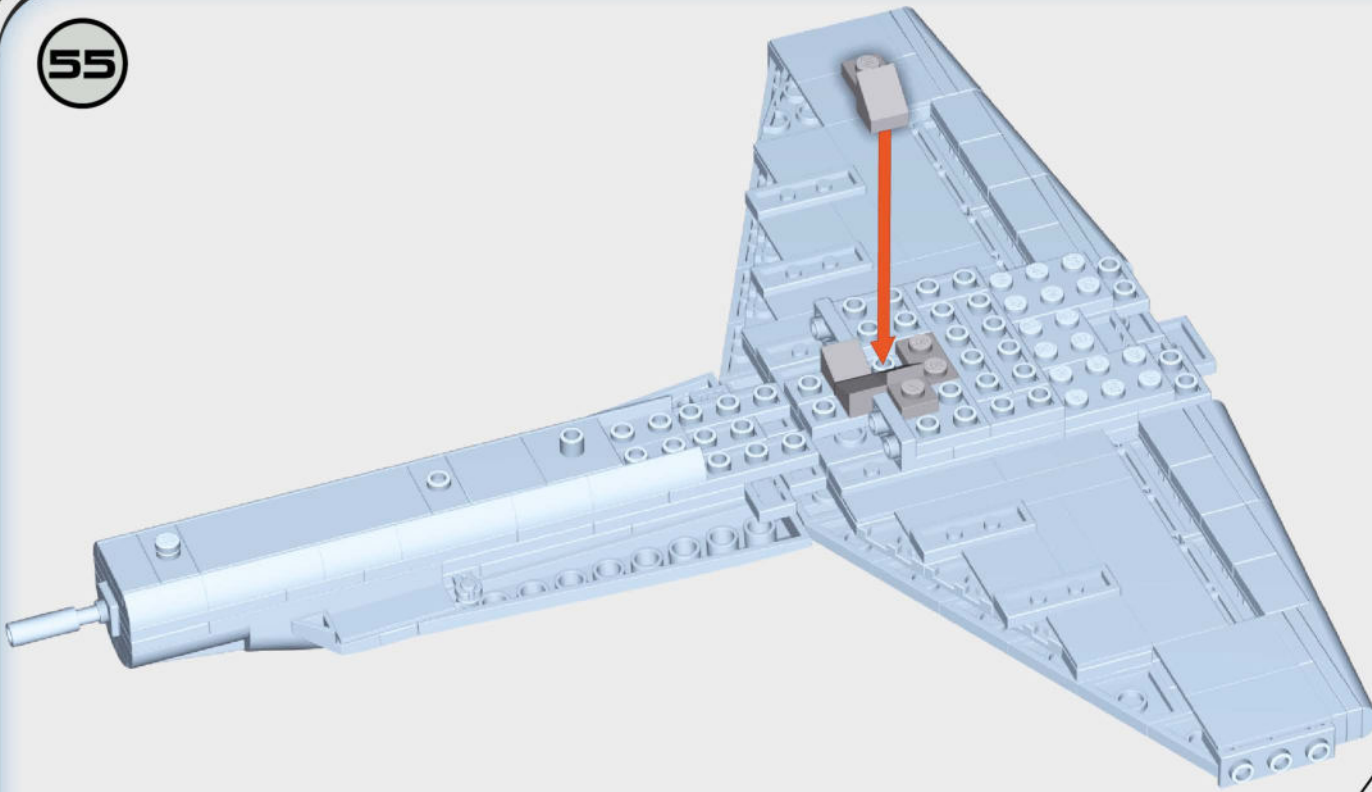

56

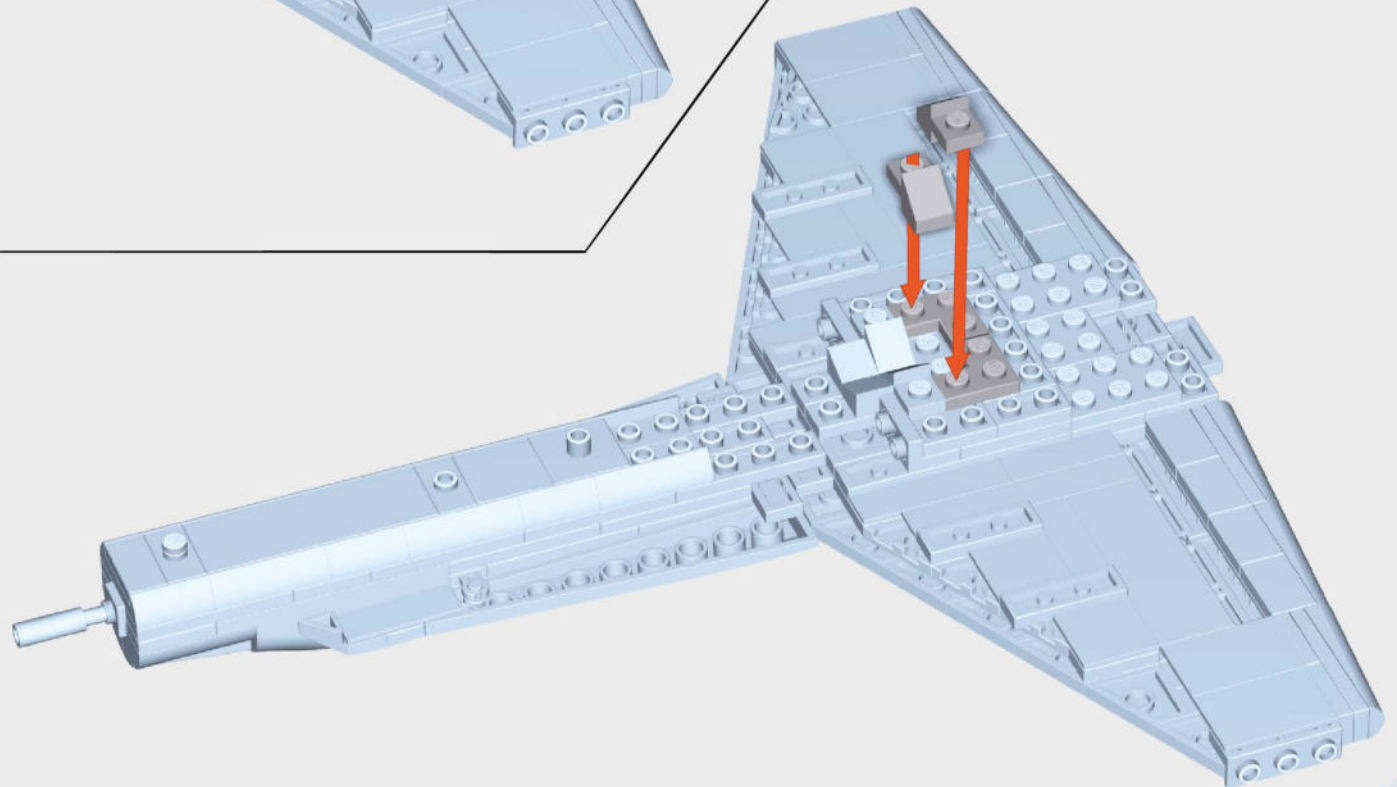

57



x1

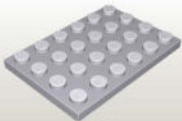

x1



x1



x1

58



x3

59

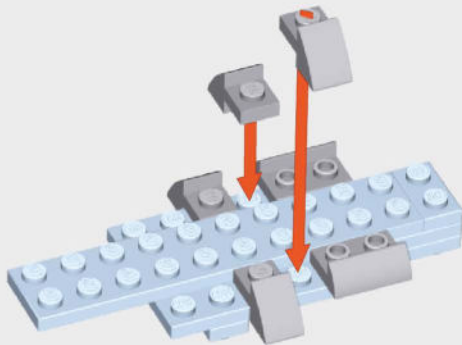

x2



x4

60

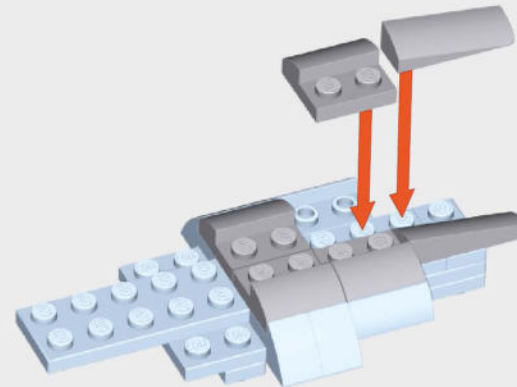

x1



x1



x4

61

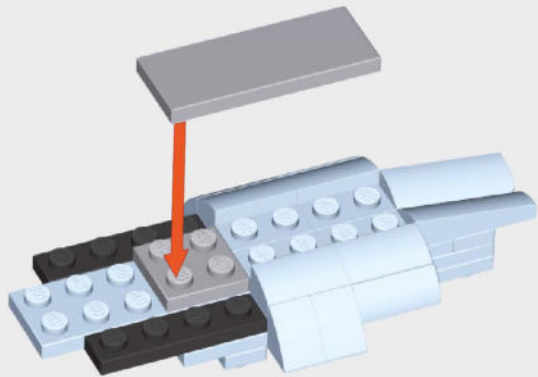

x2



x1

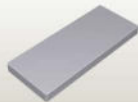

x1

62

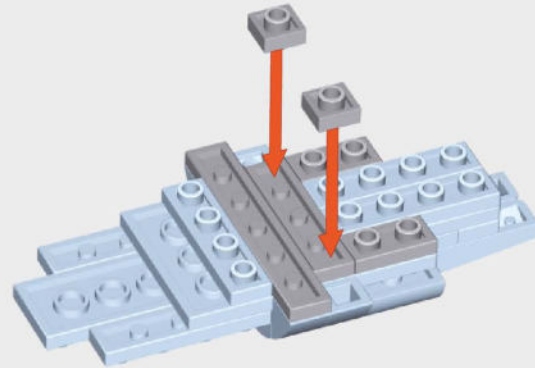

x1



x1



x2



x2

63

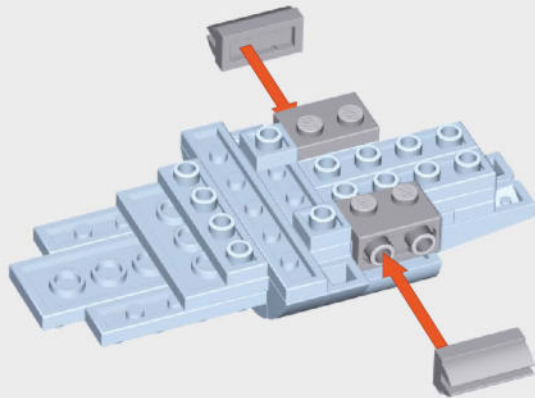

x2



x2

64

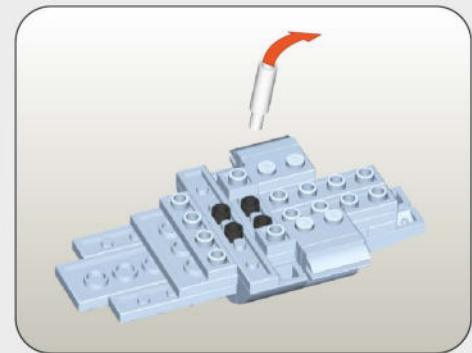
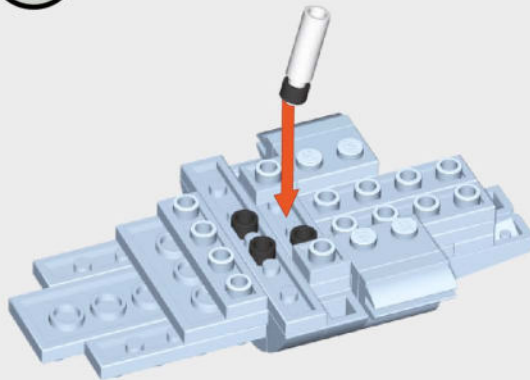

x4

65



x2

66

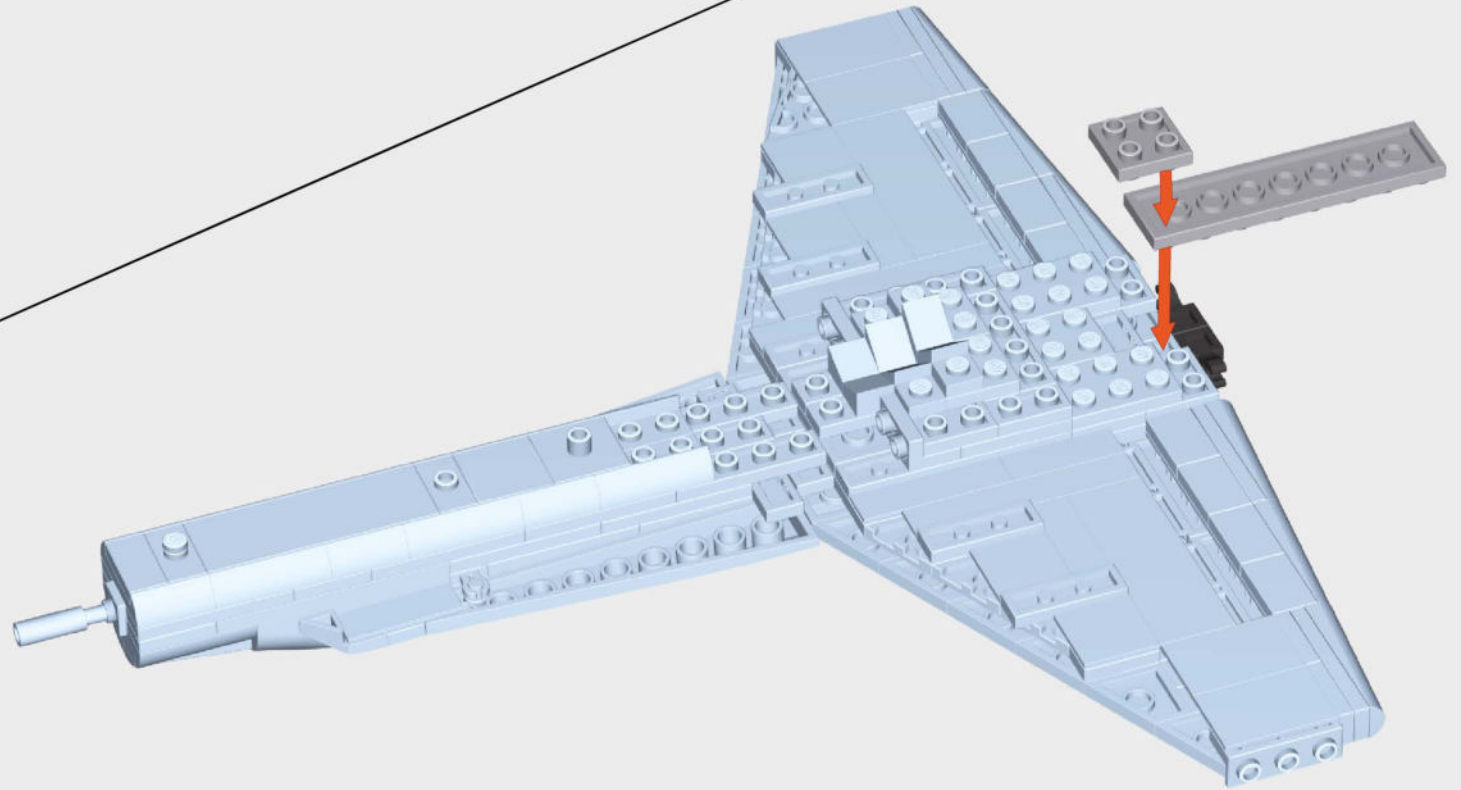

x2



x1



x1

67

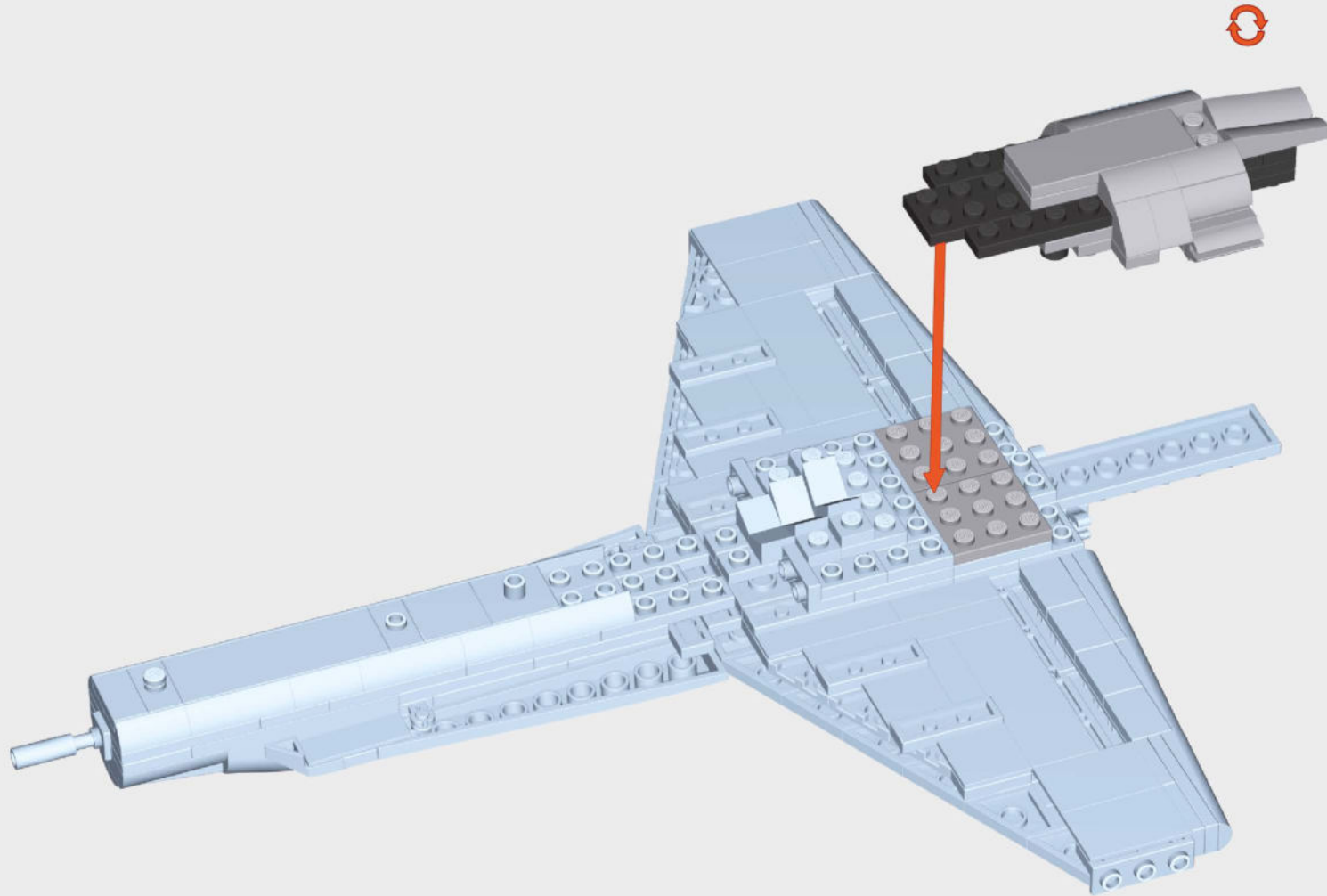

68

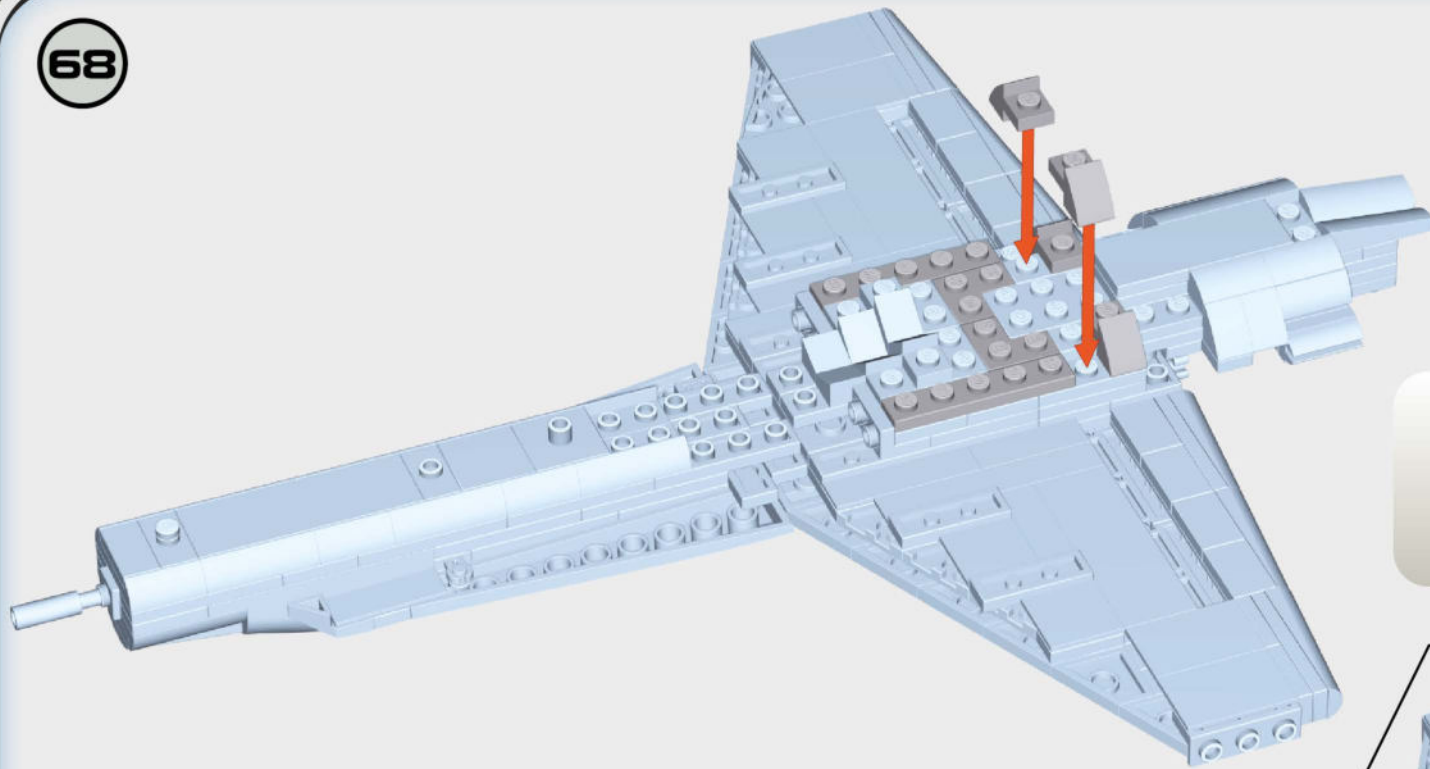

x2



x2



x4

69

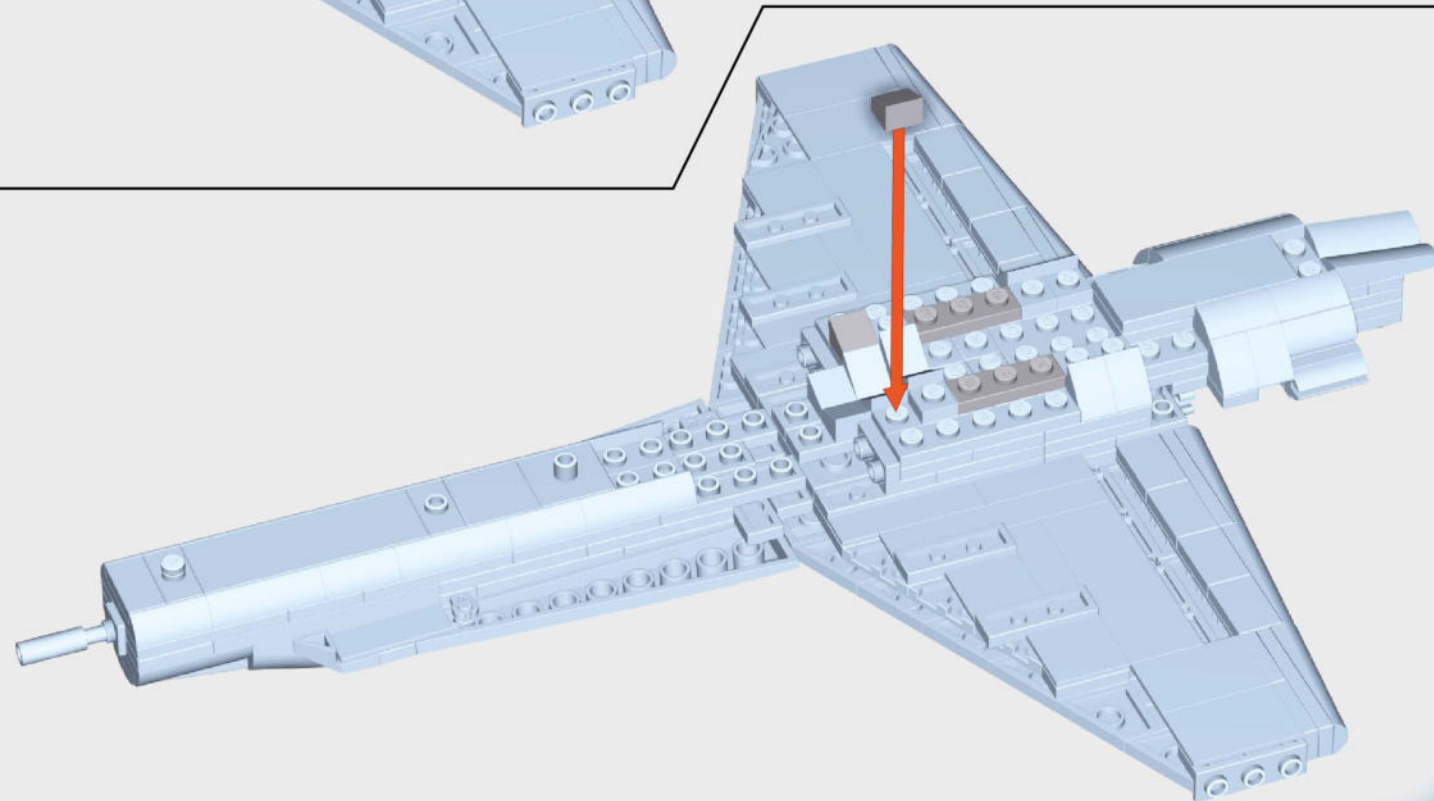

x2



x2

70

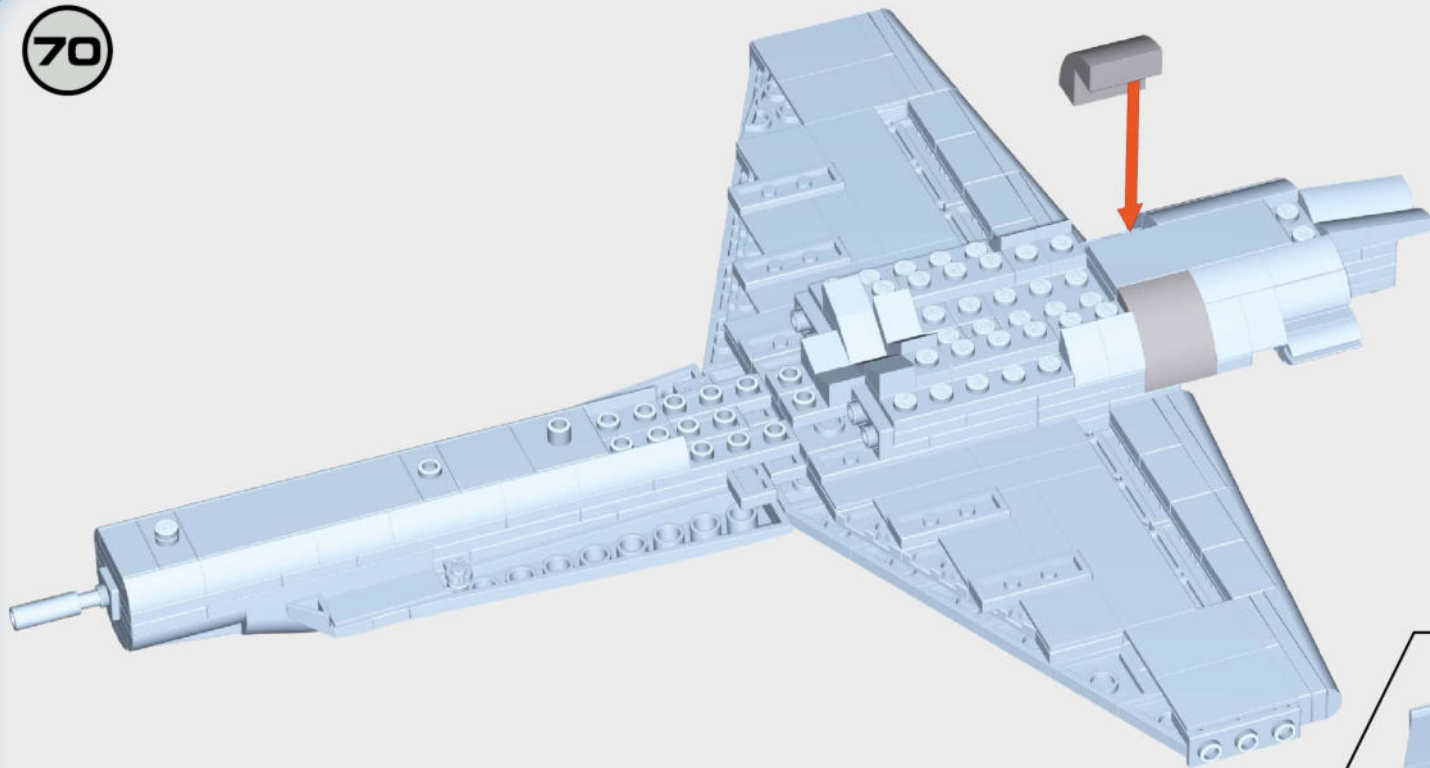

71

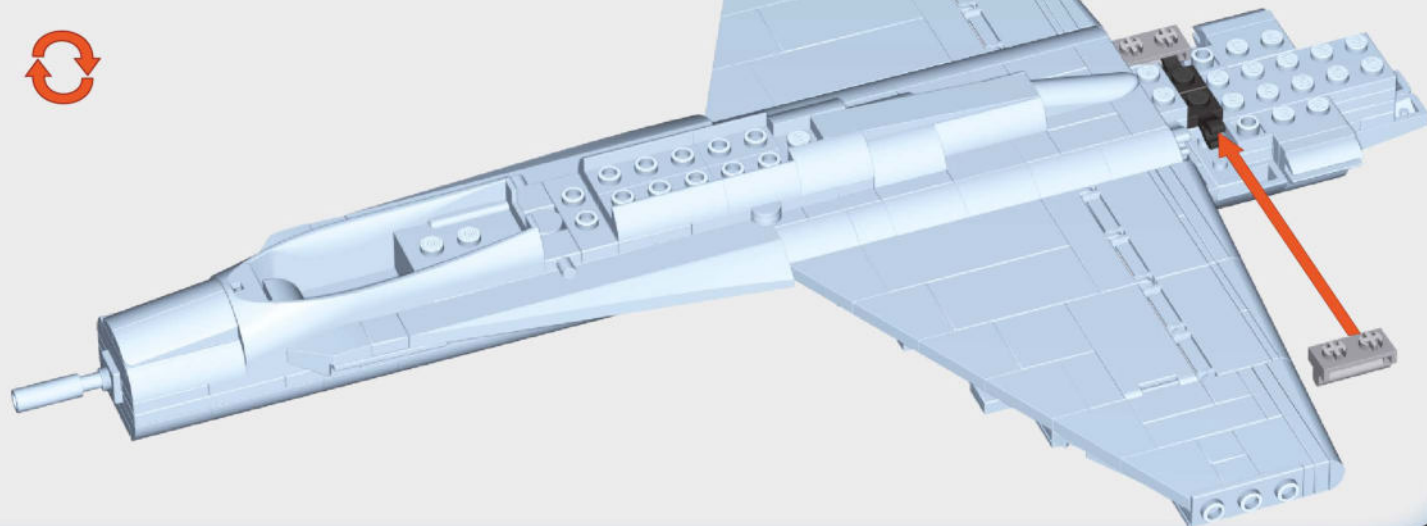

72

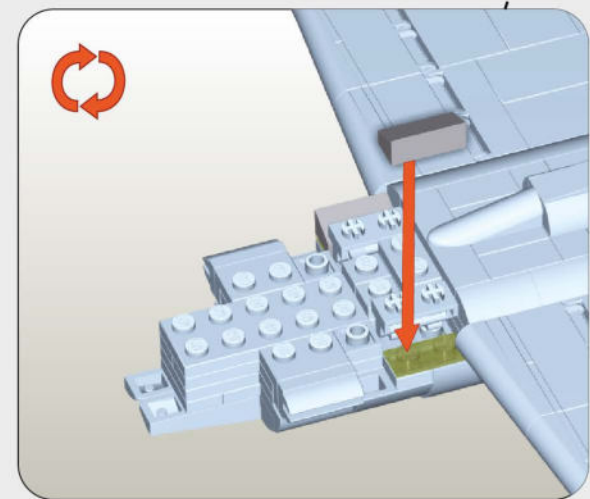
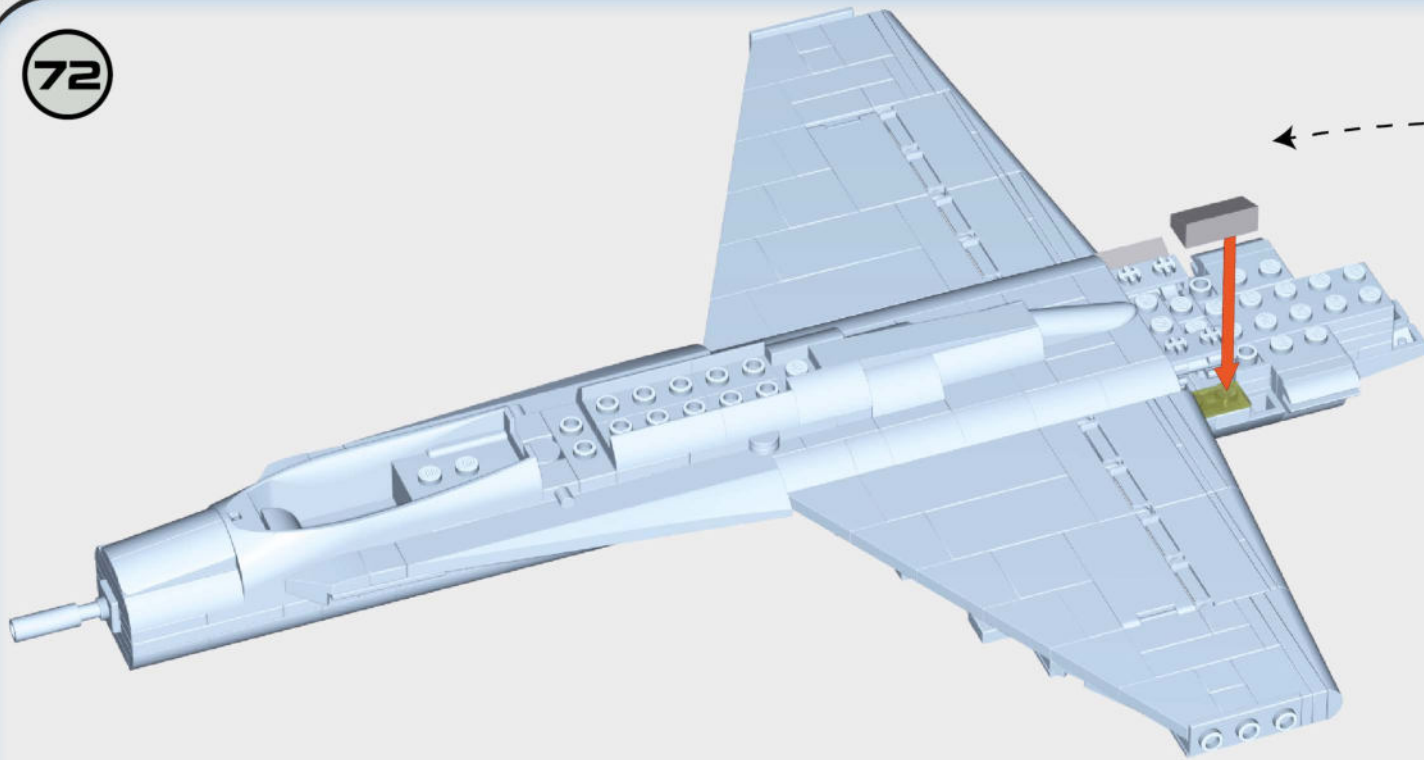

x2



x2

73

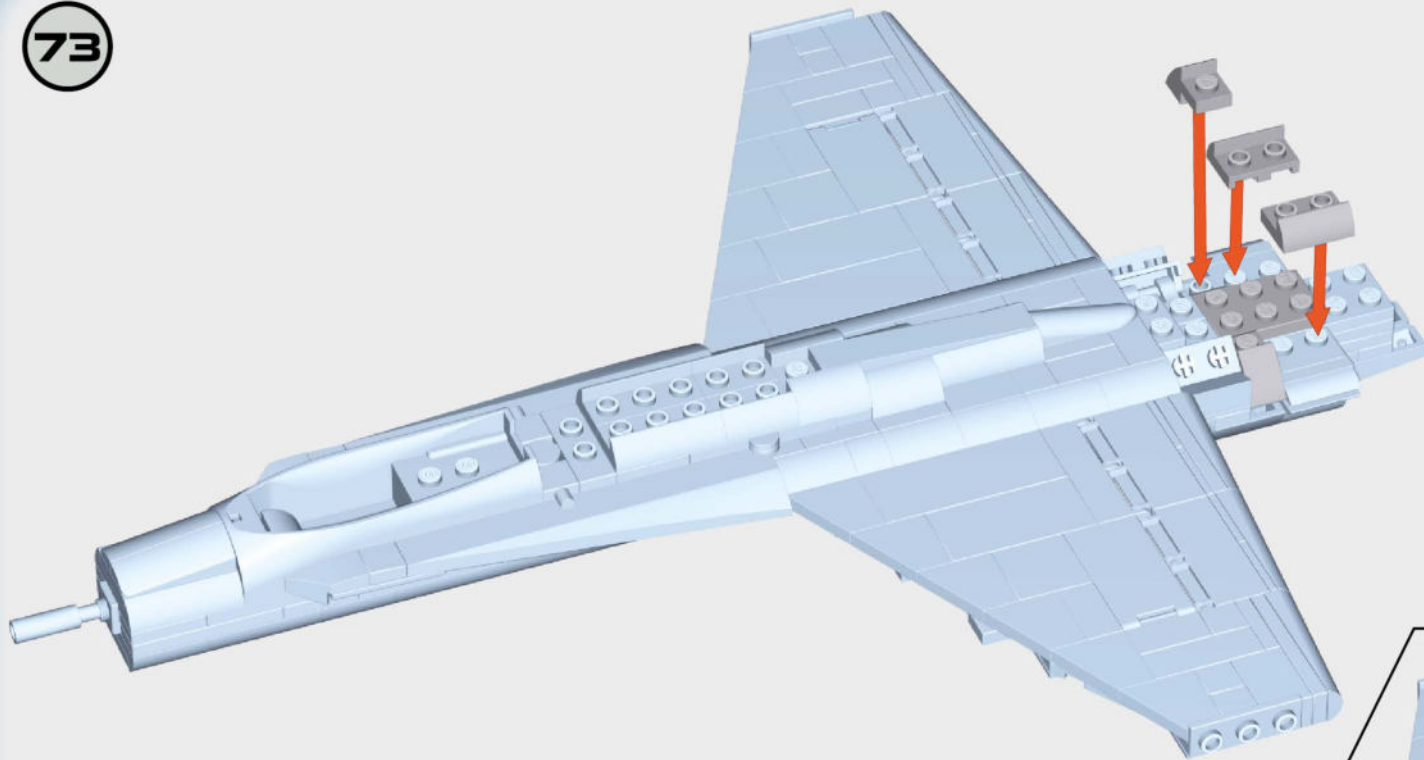

74

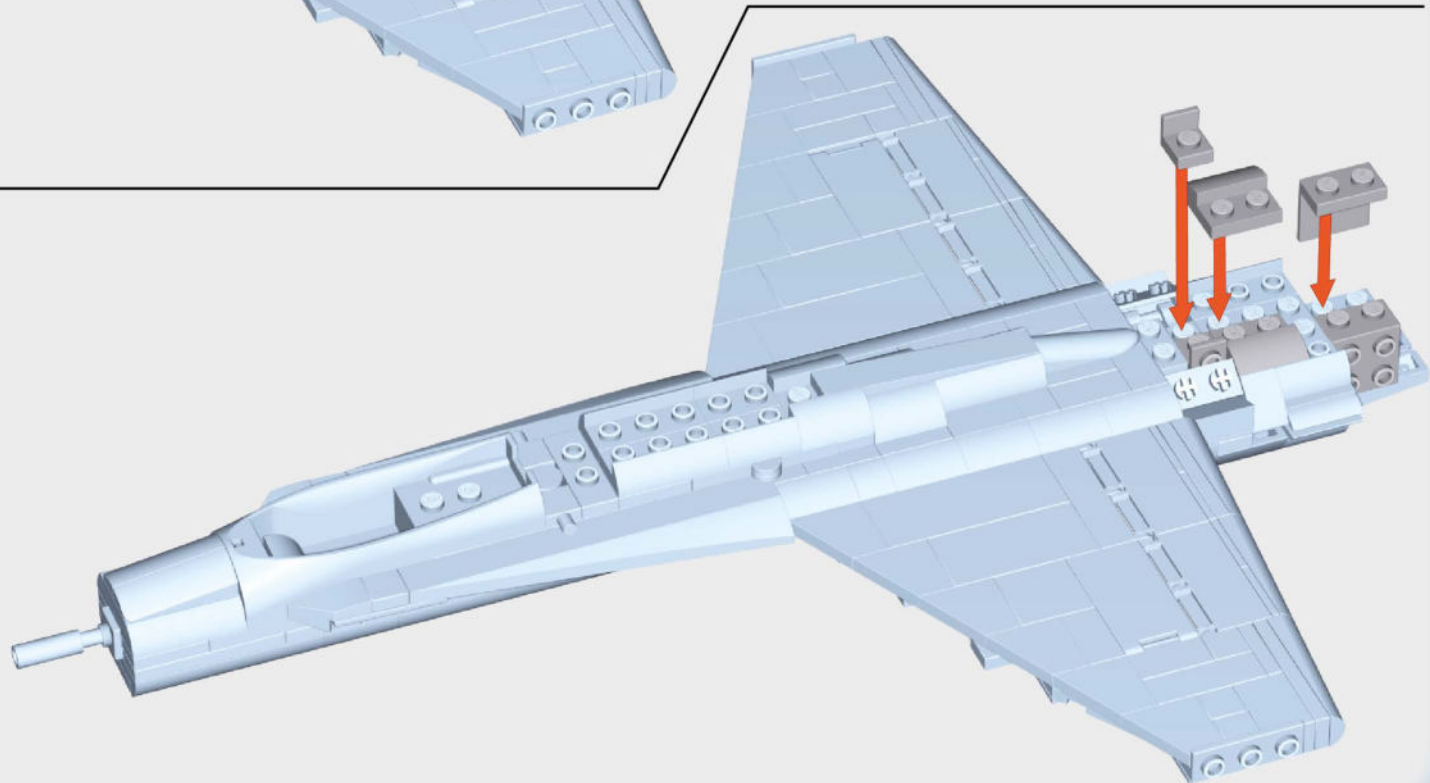

75

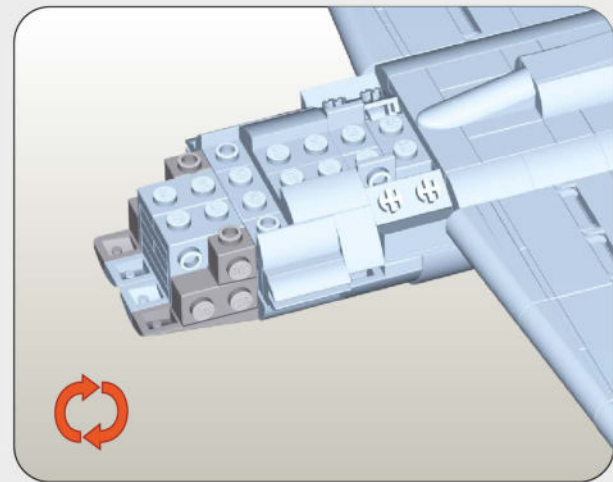
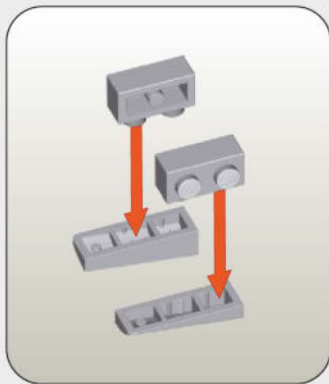
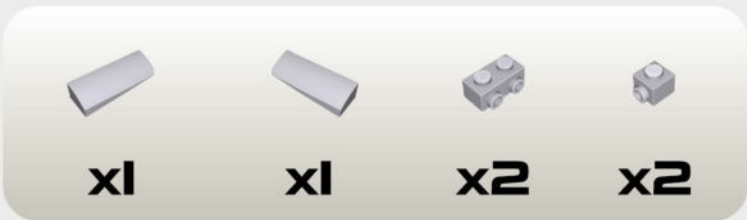
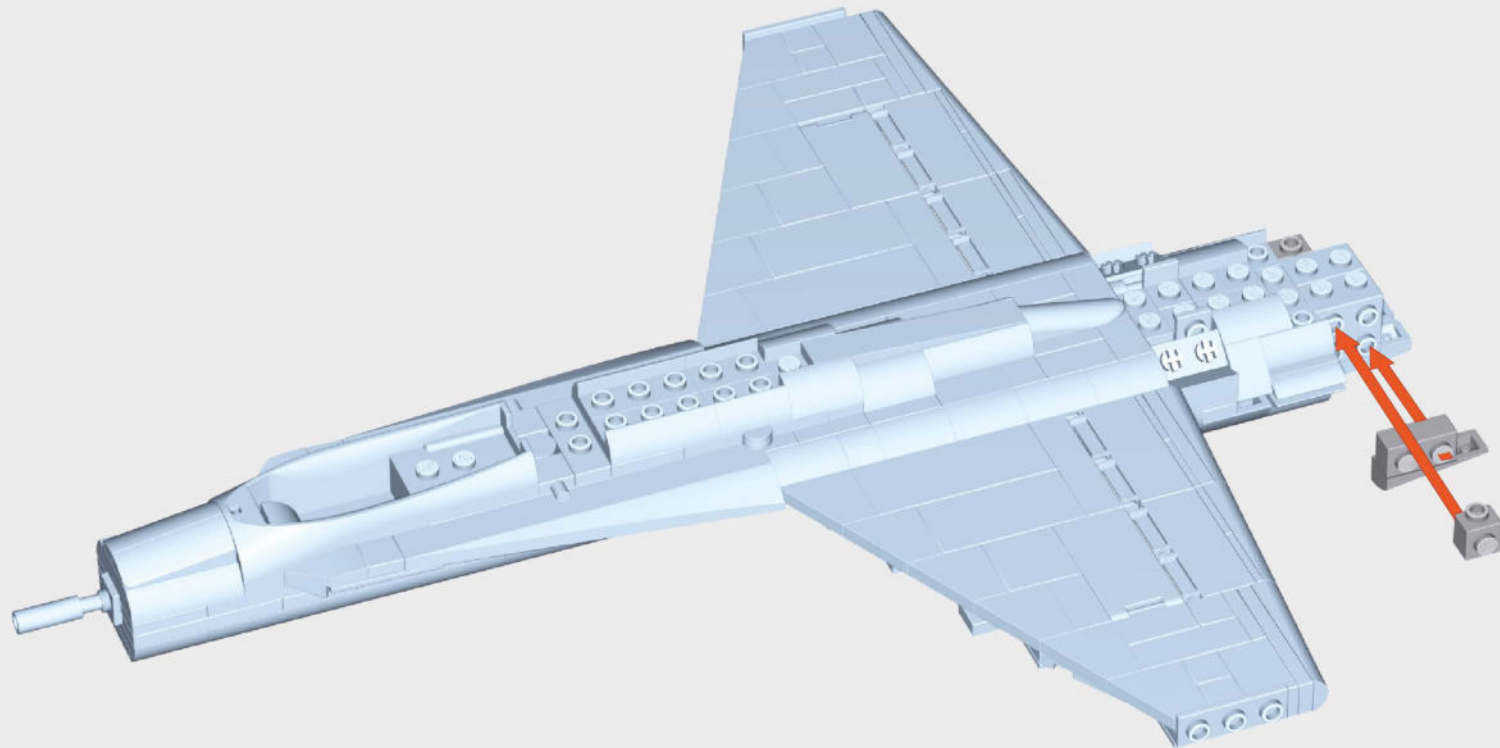

76

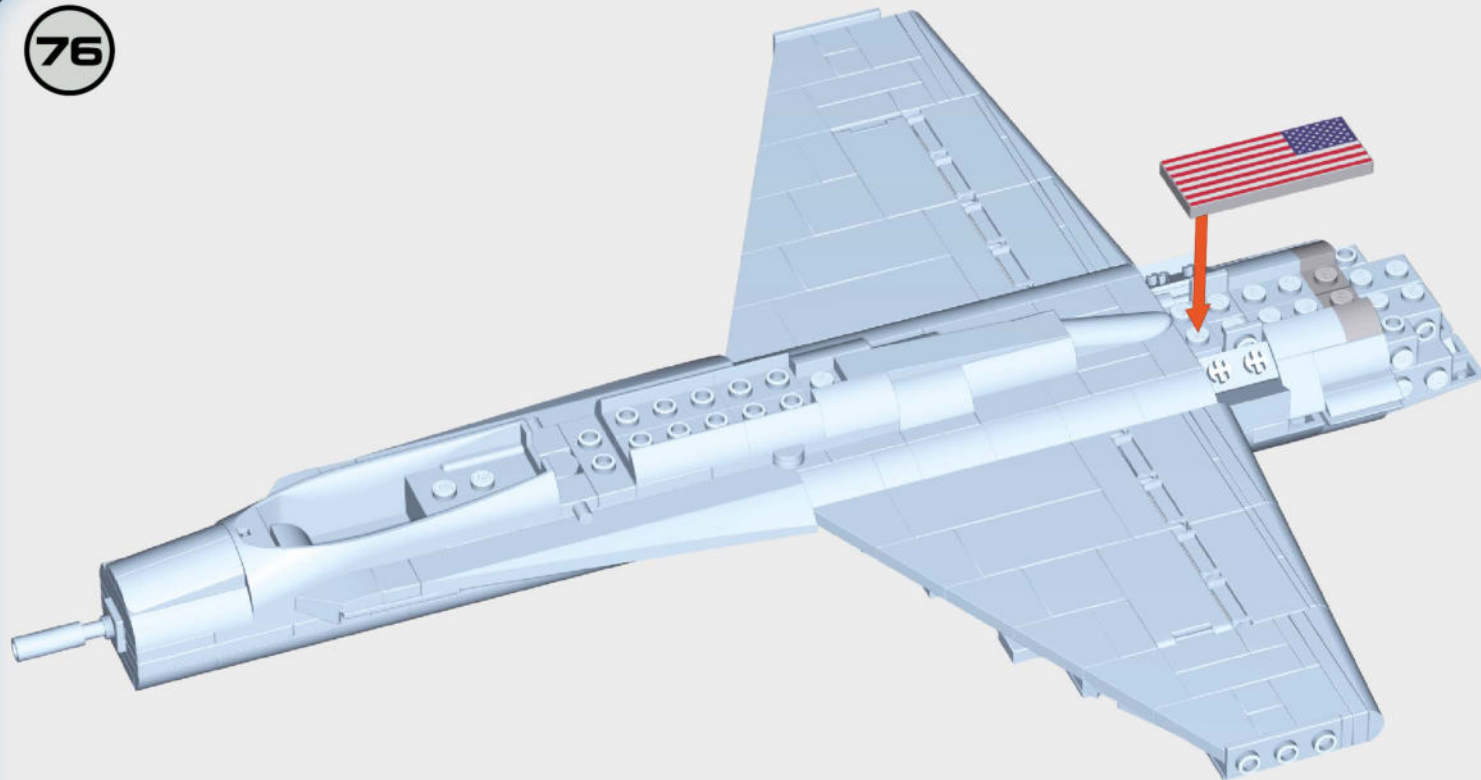

77

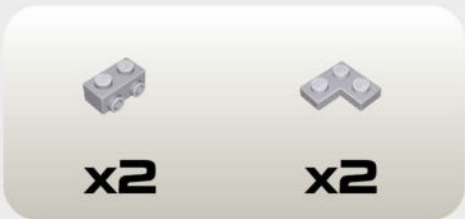
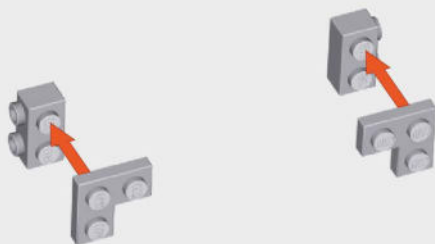

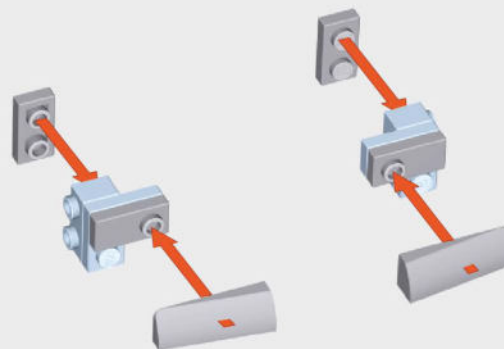

78

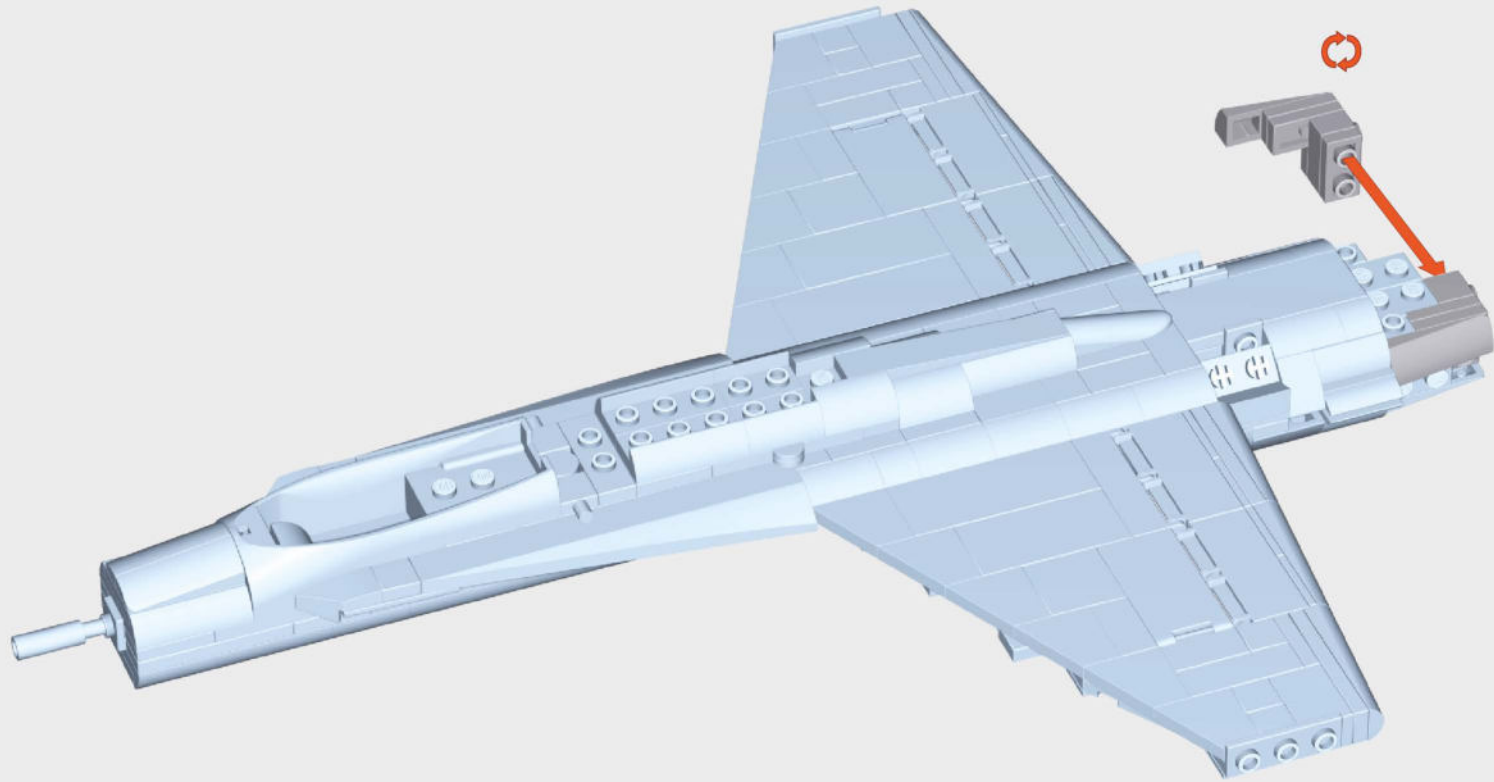

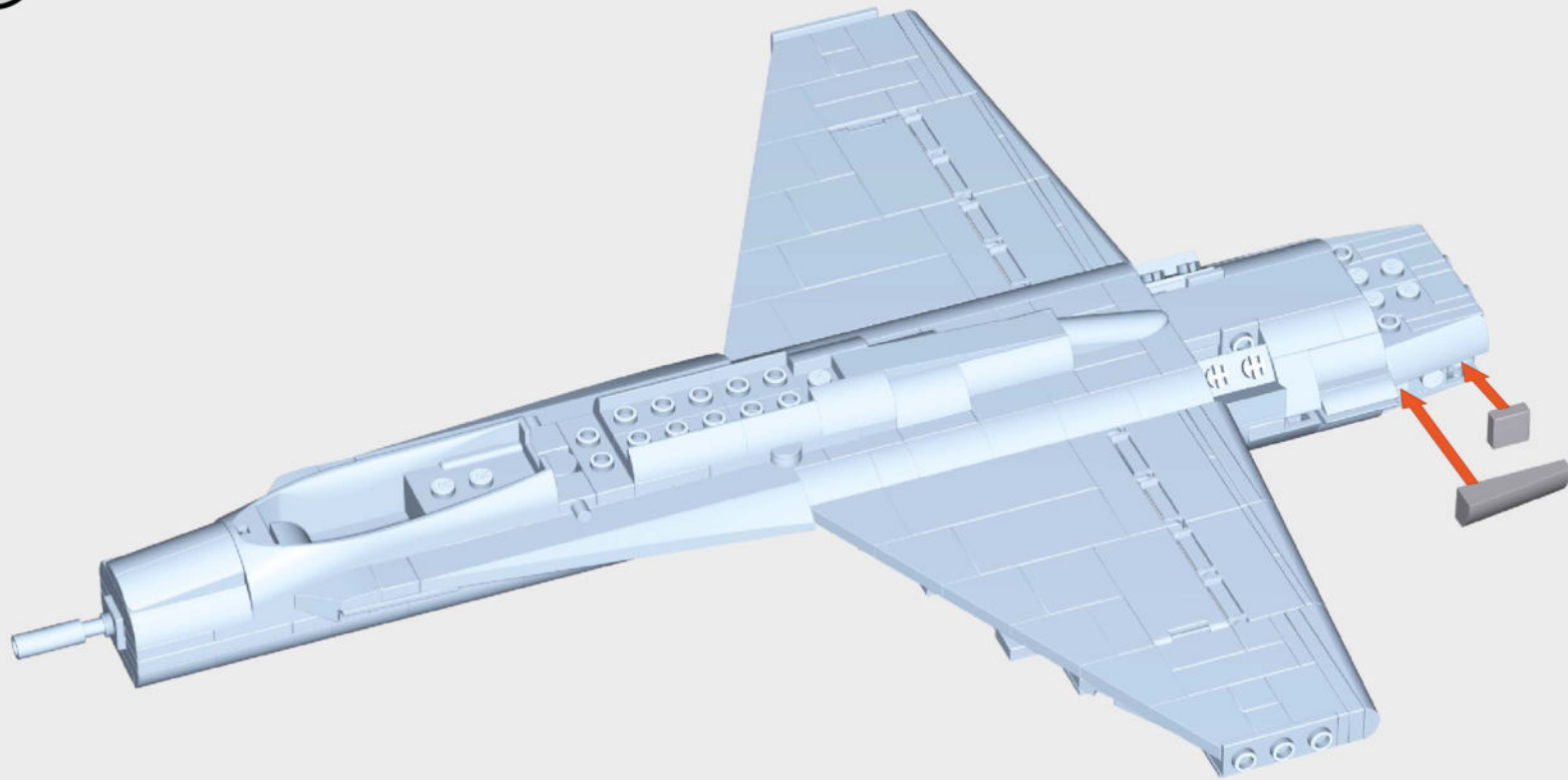



-  x1
-  x1
-  x2

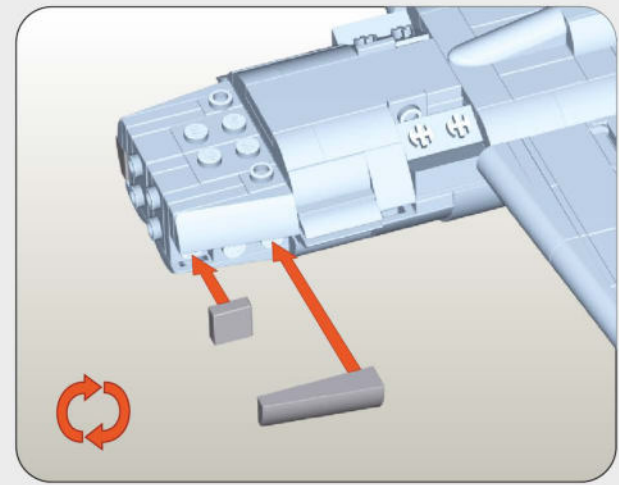

81

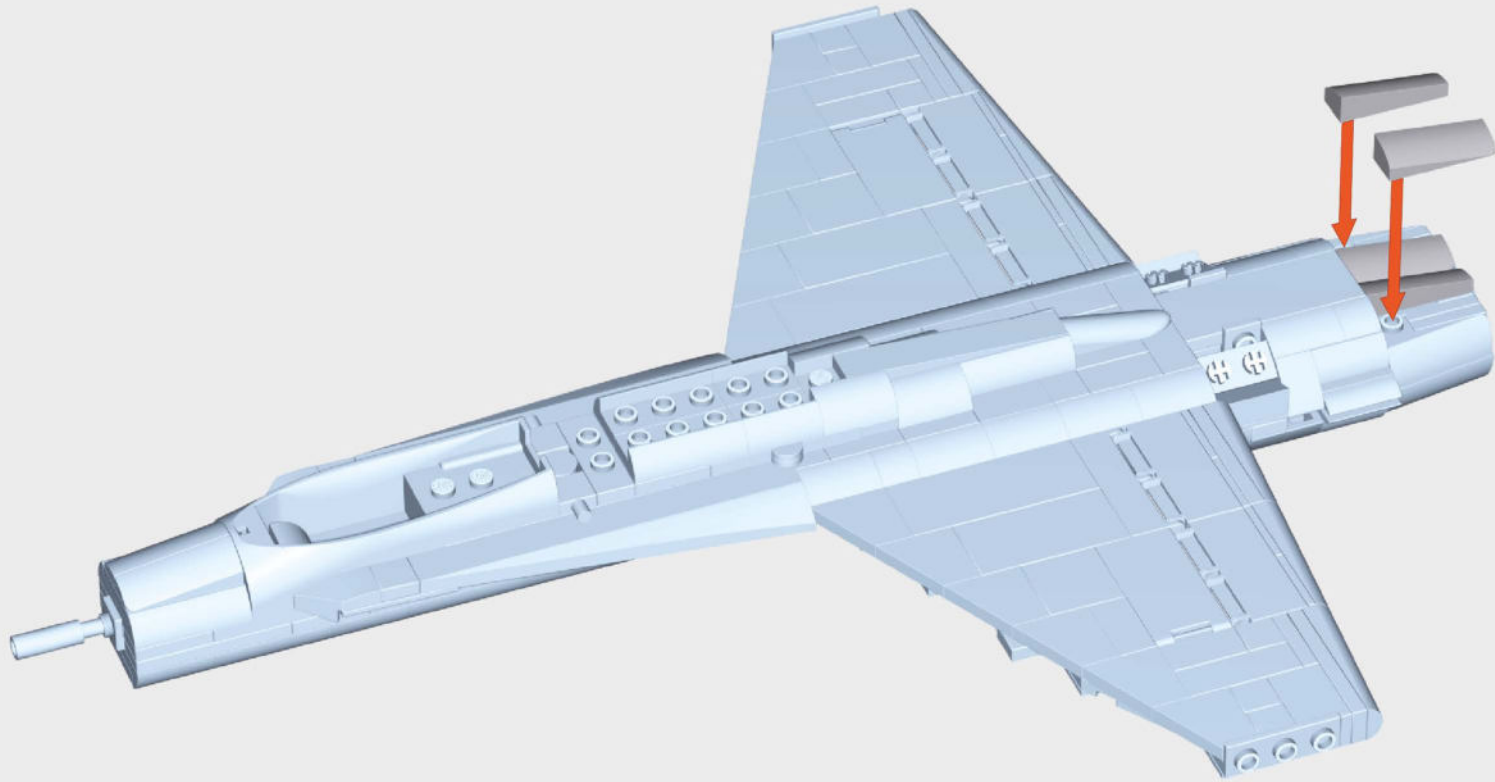

x2



x2

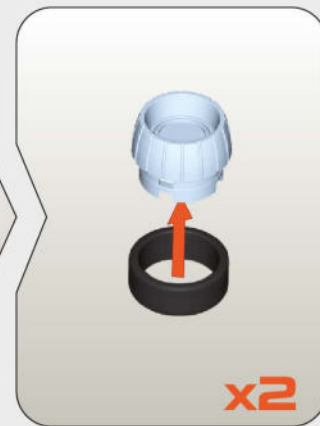
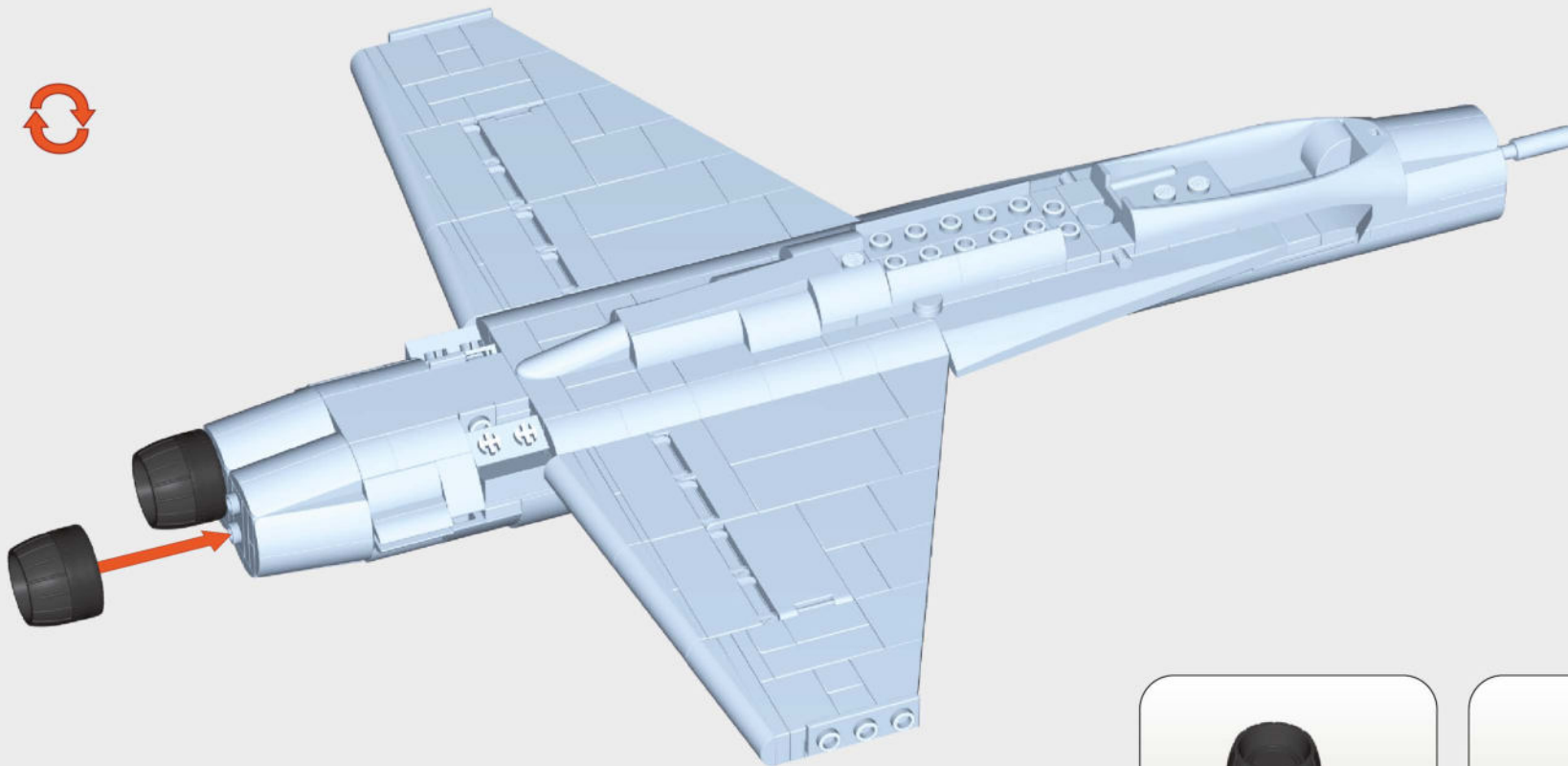

x4

x2

x2

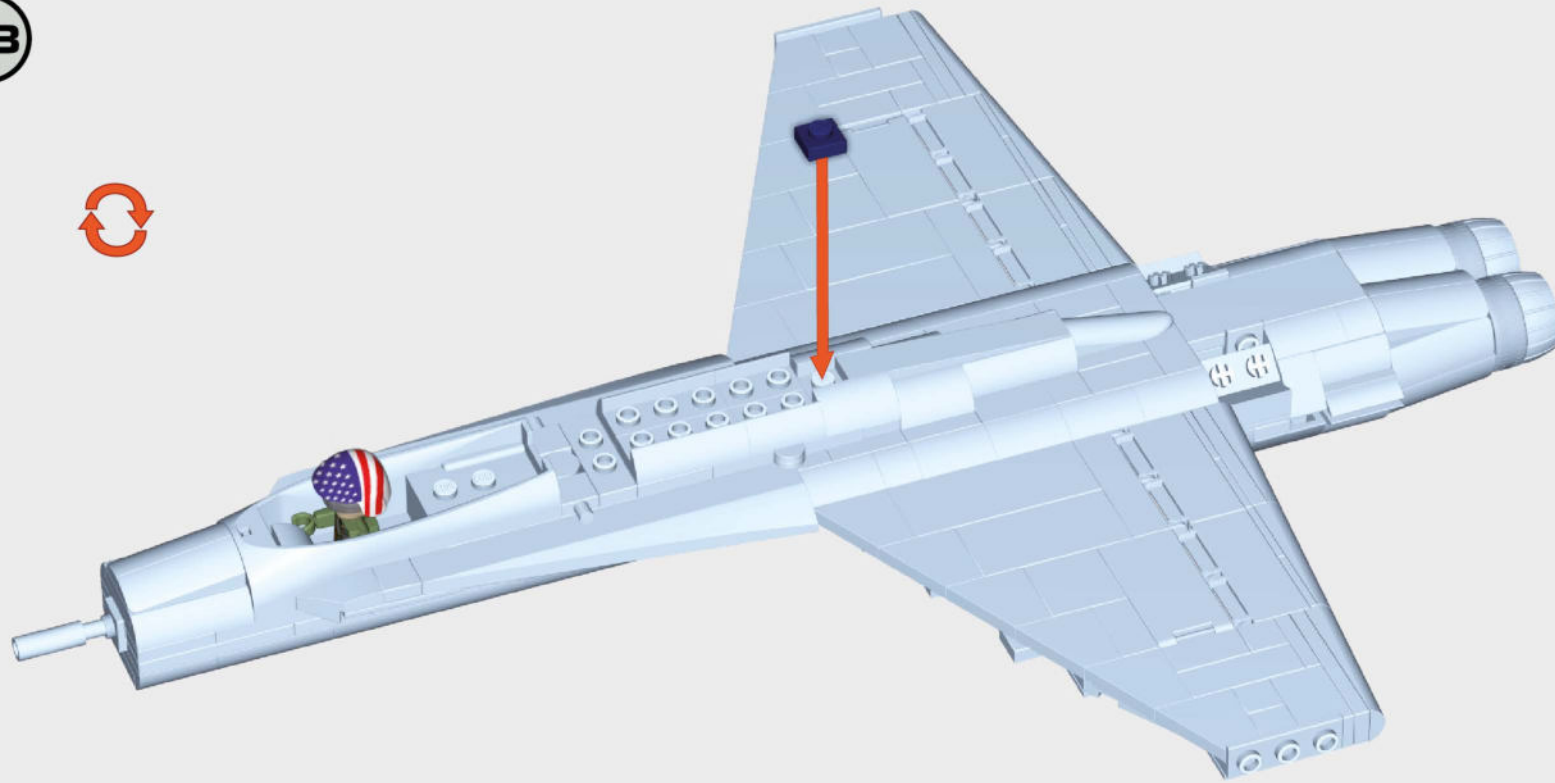

x1



x1



x1



x1



x1



x1

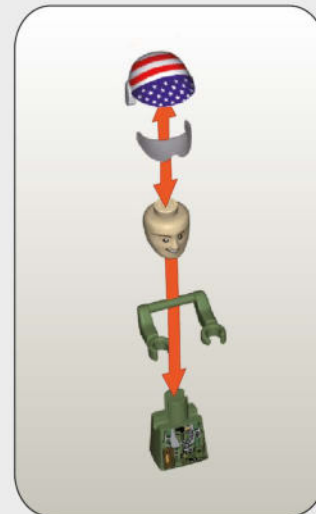

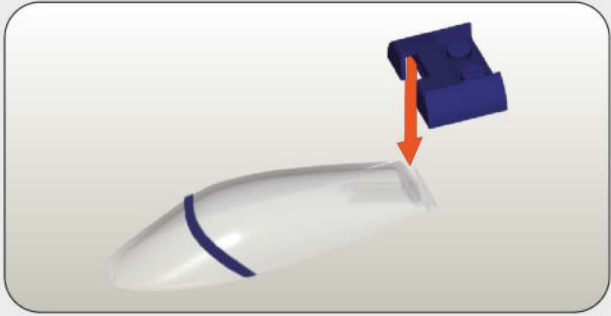
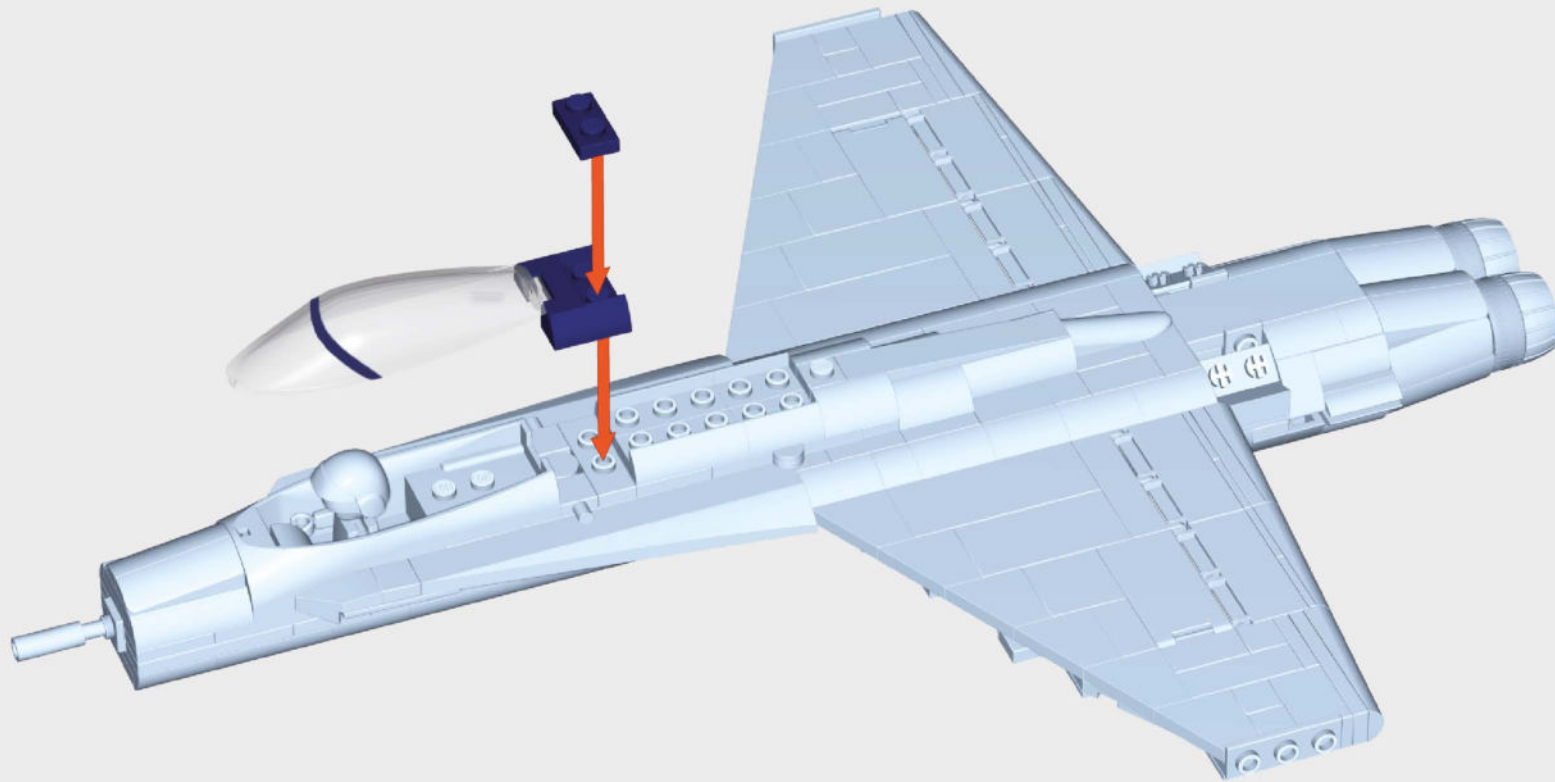

85

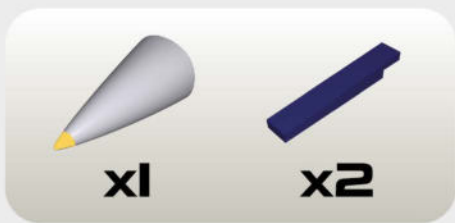
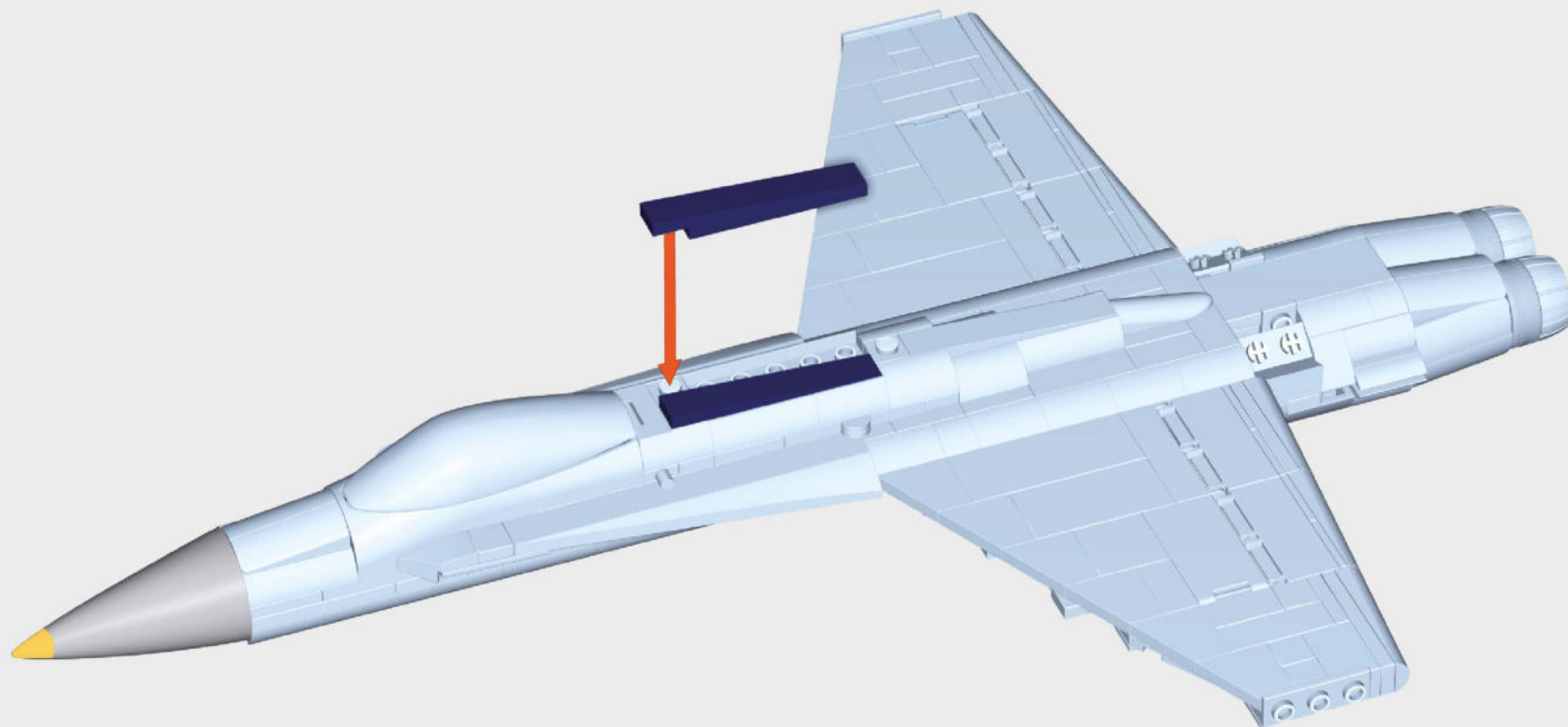

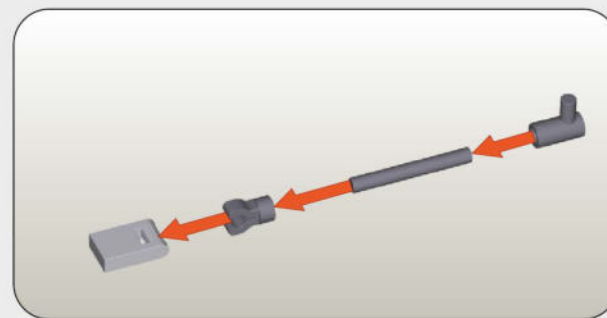
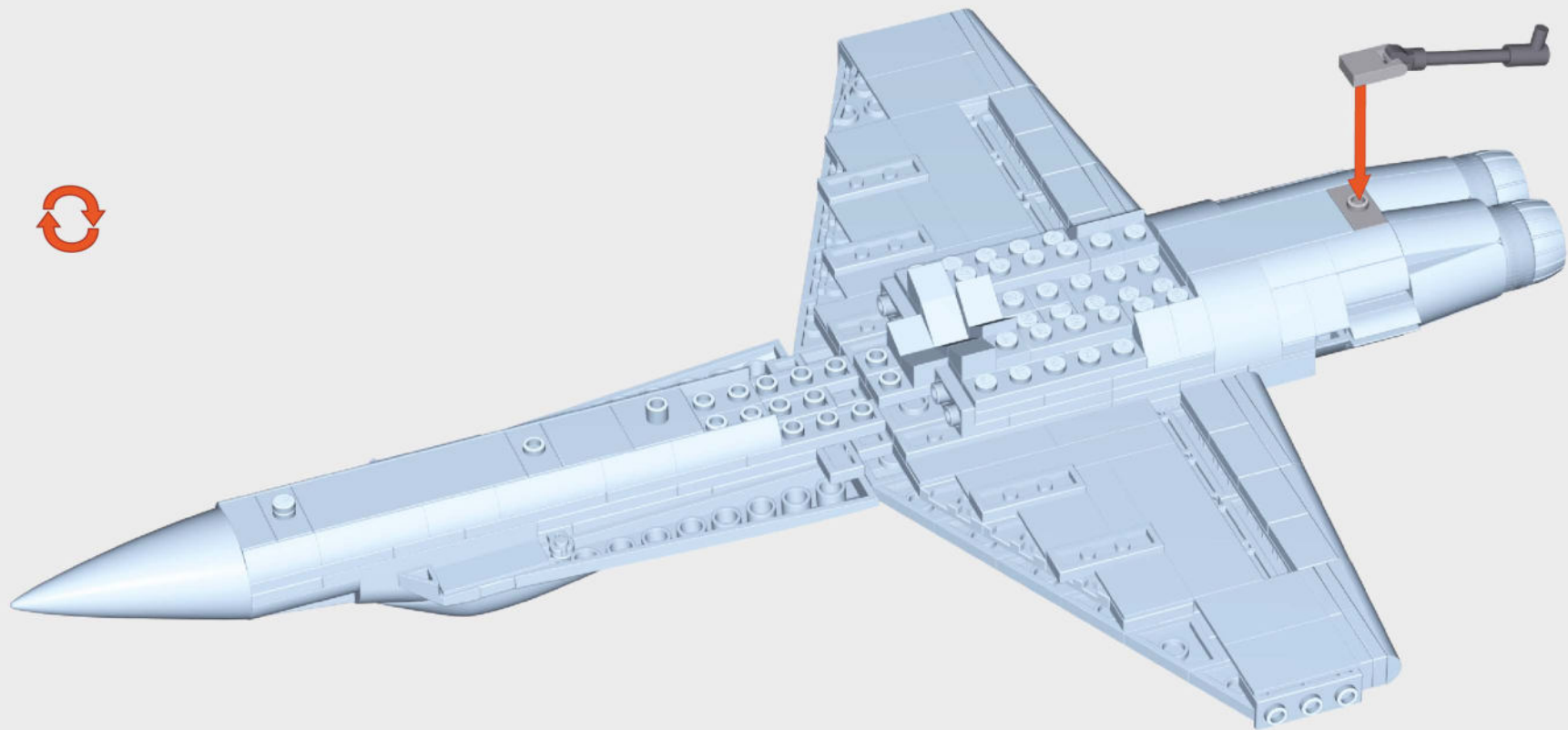

x1



x1



x1



x1



x1

87

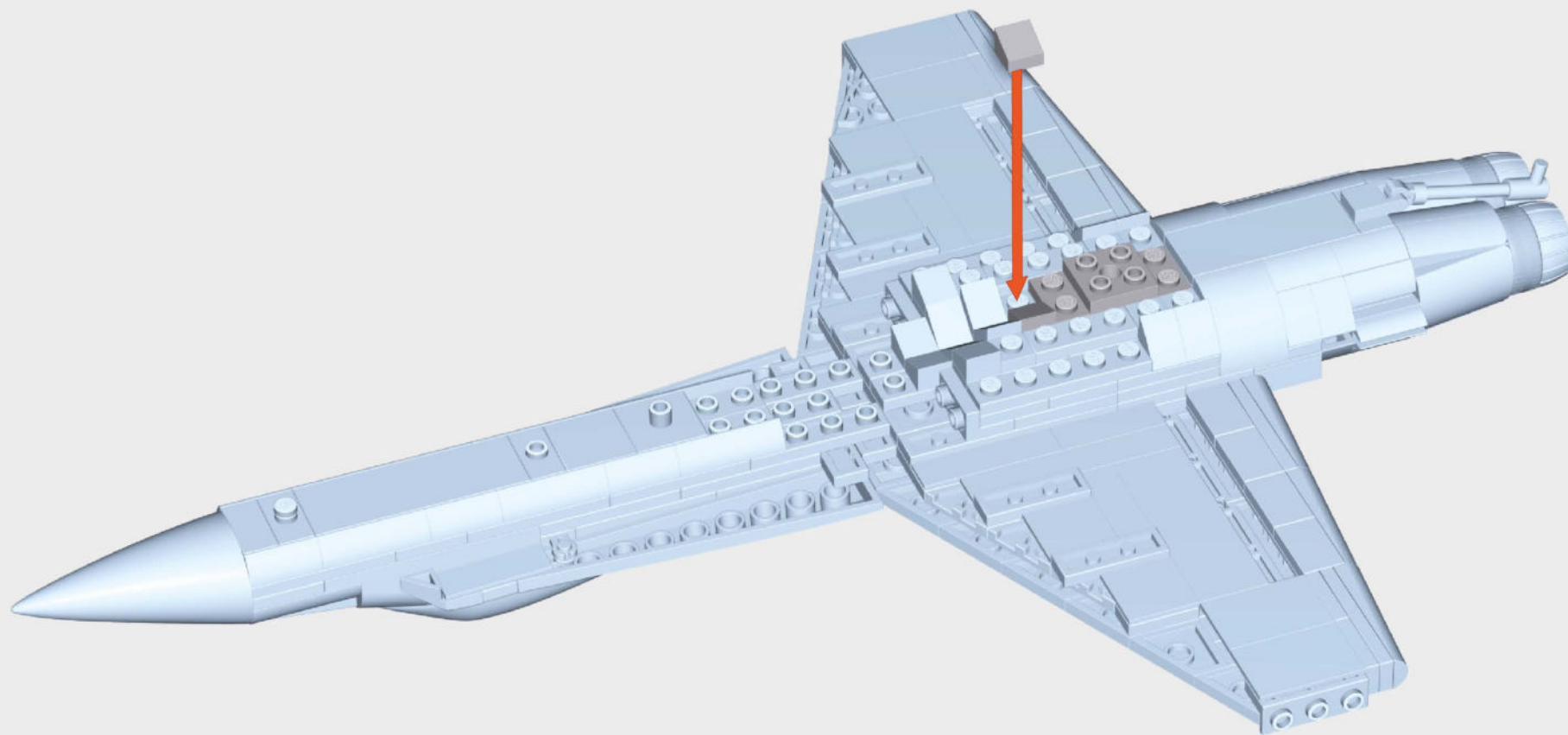

x2

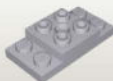

x1

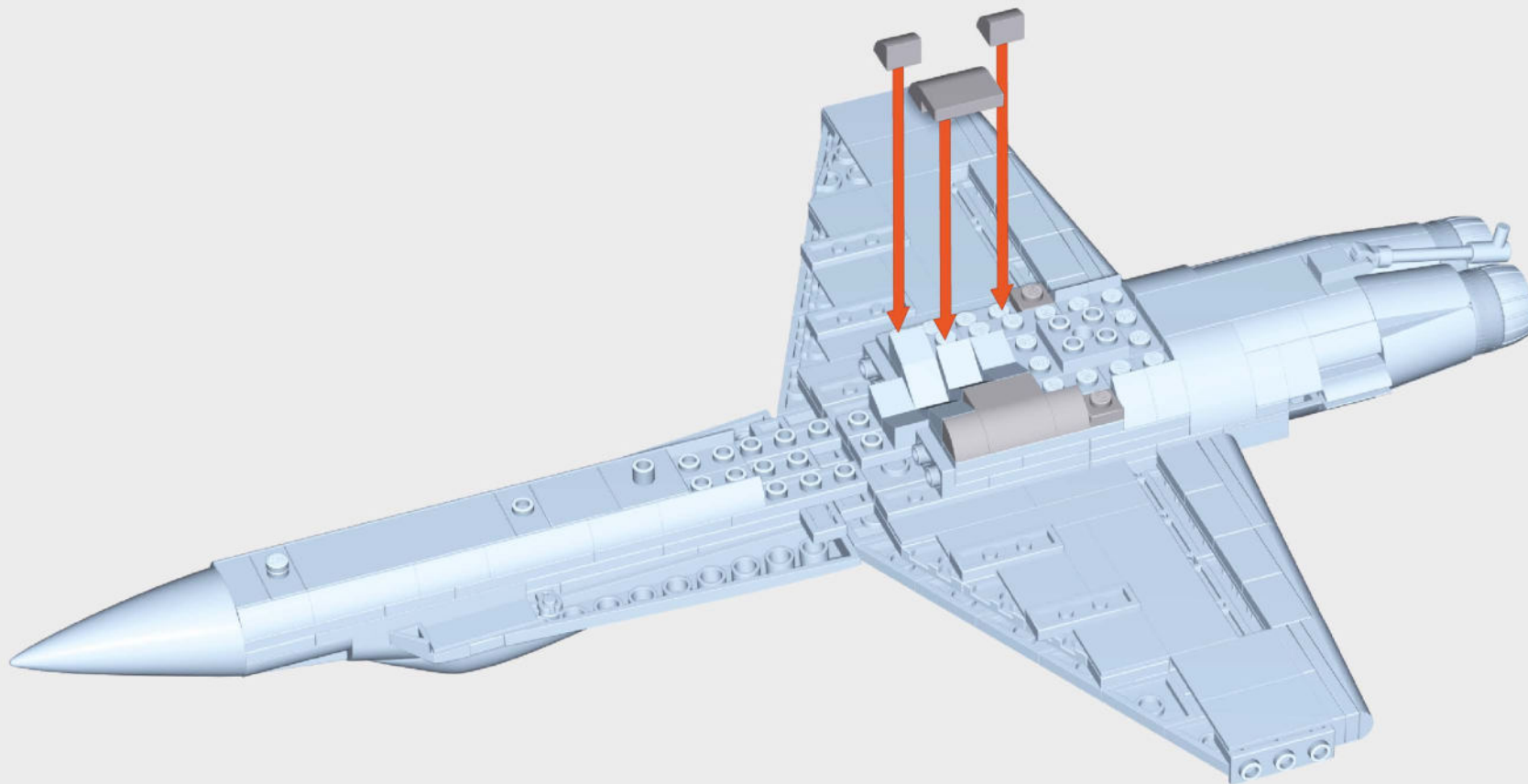

x2



x2



x4

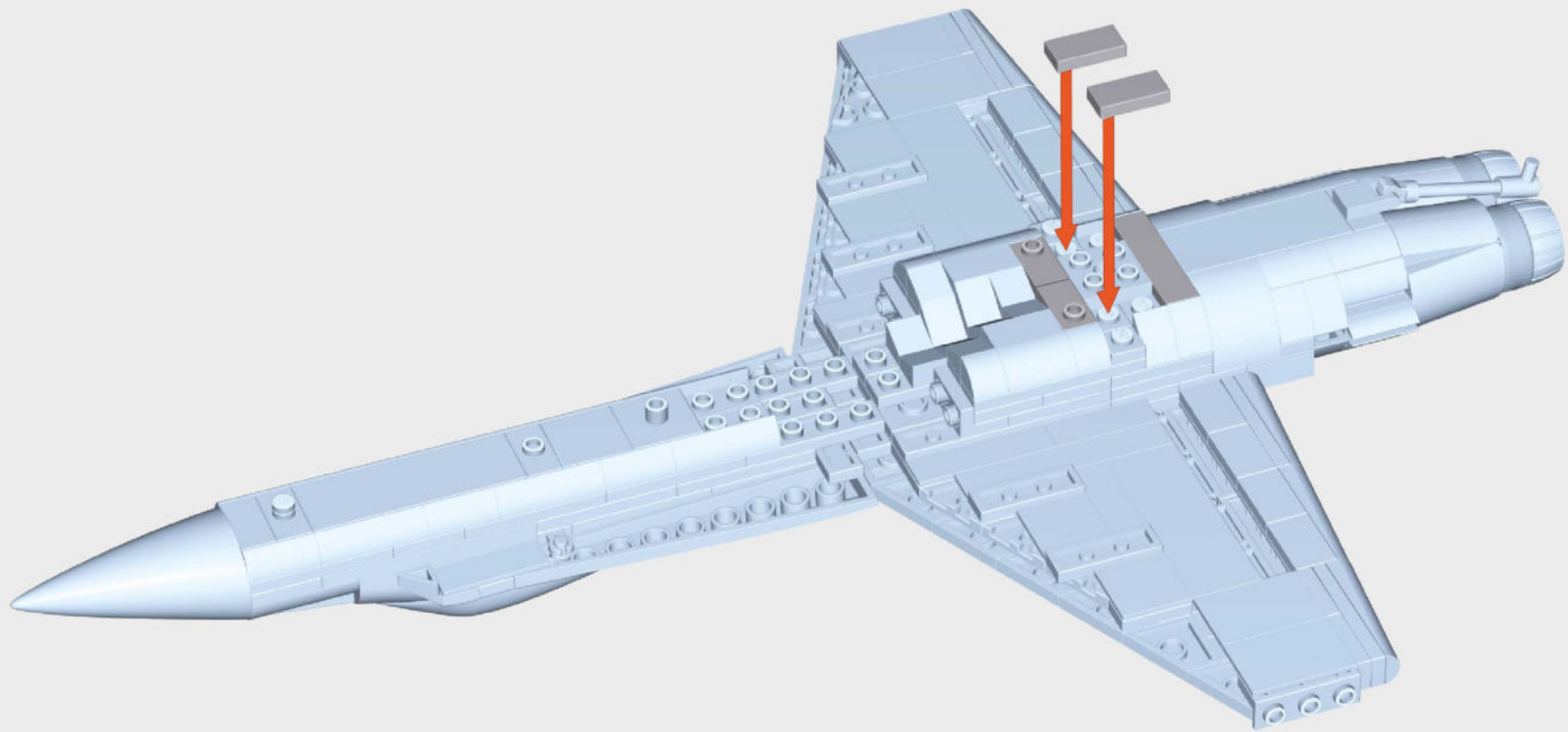

1:1

1:1



x2



x1



x2

90

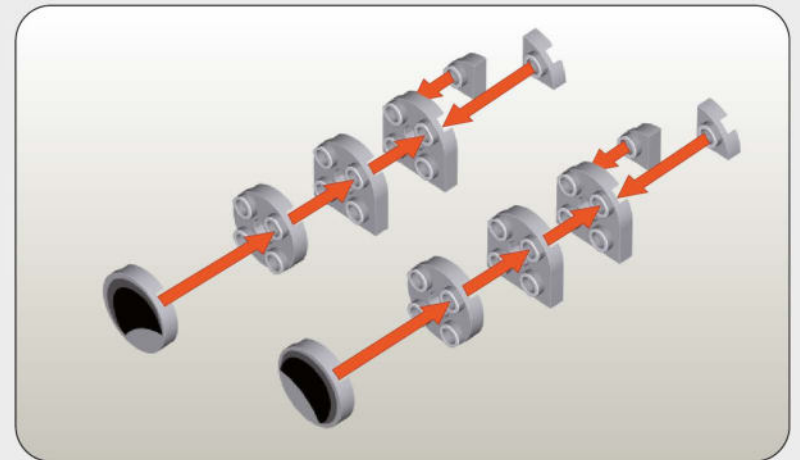
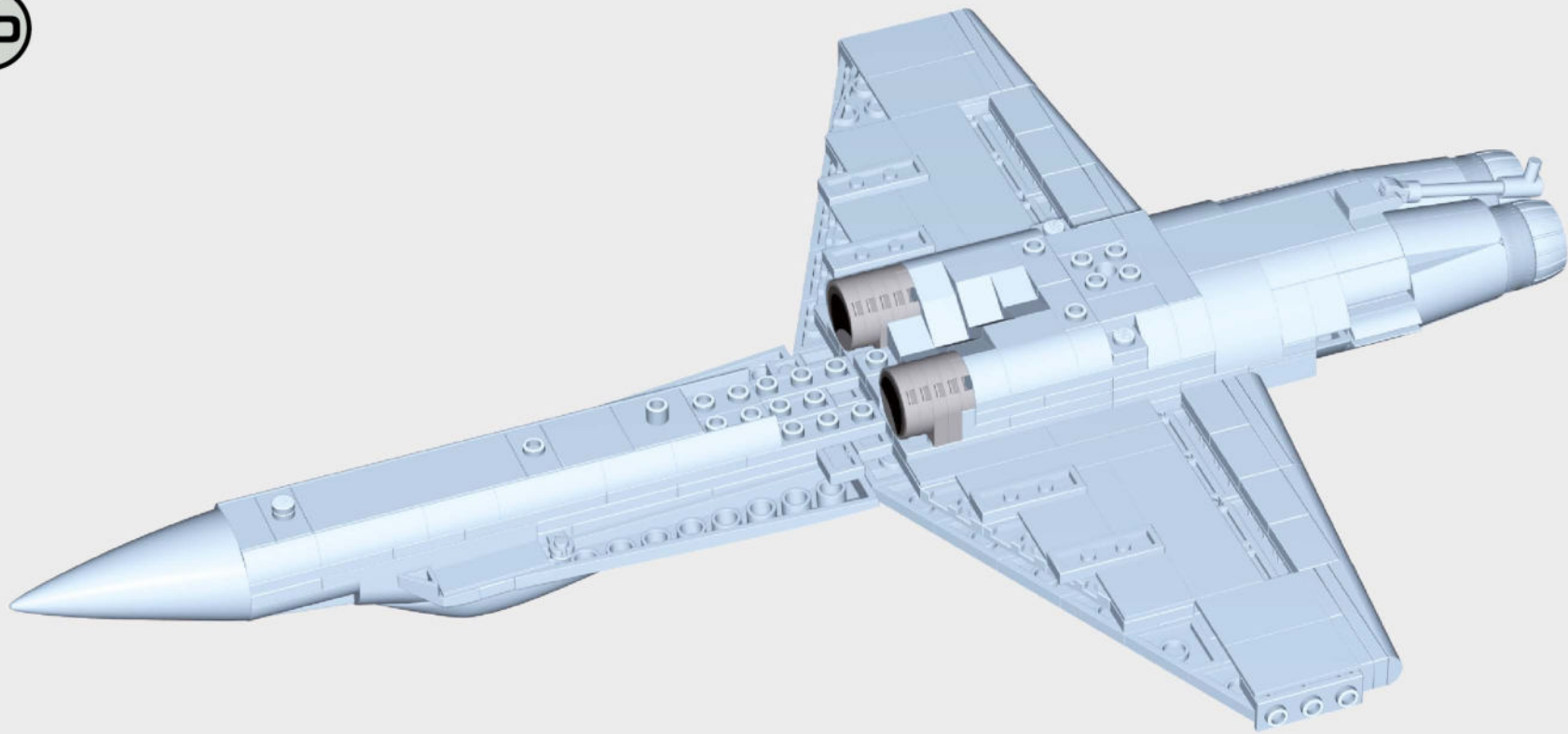

x2



x2







x4

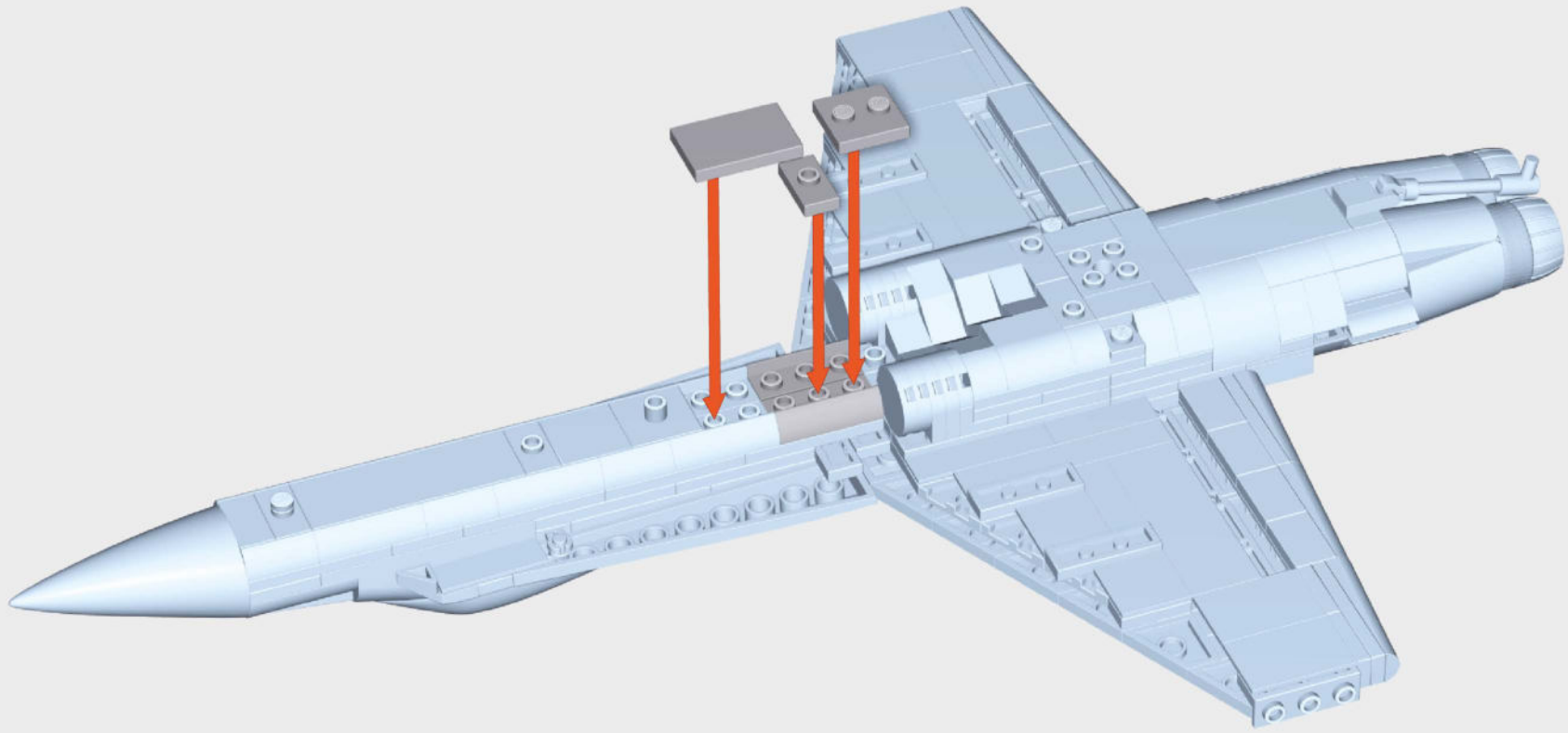

x4



-  x2
-  x1
-  x1
-  x1

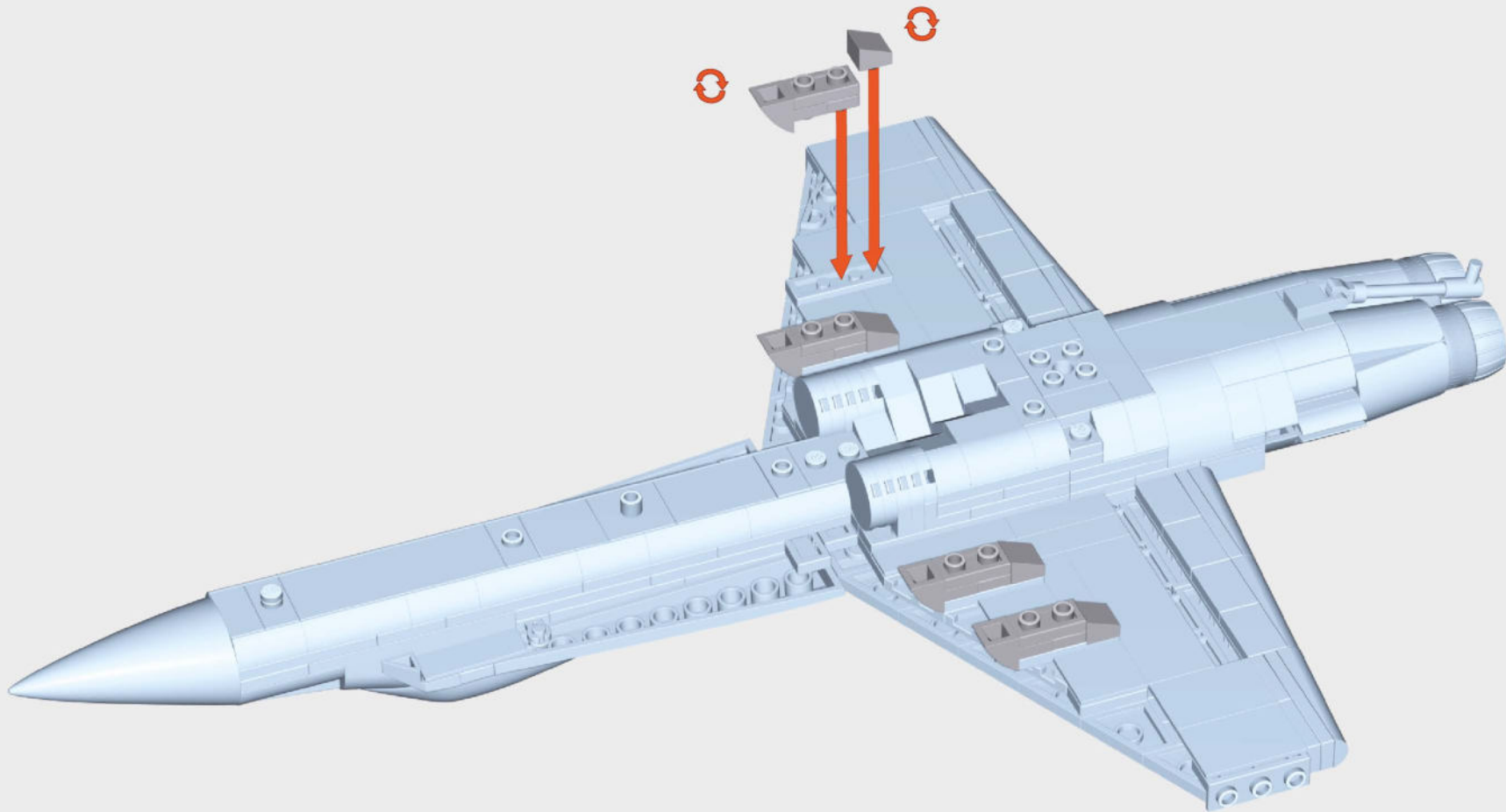

-  x4
-  x4
-  x4
-  x4
-  x4

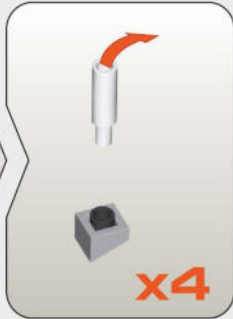
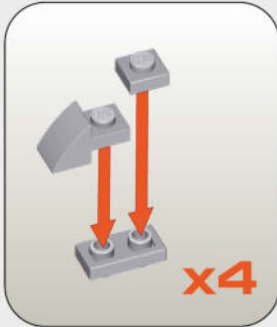

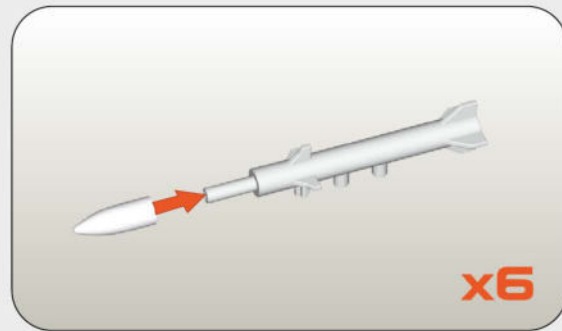
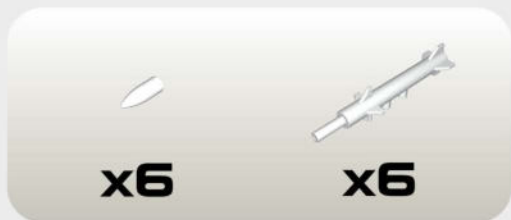
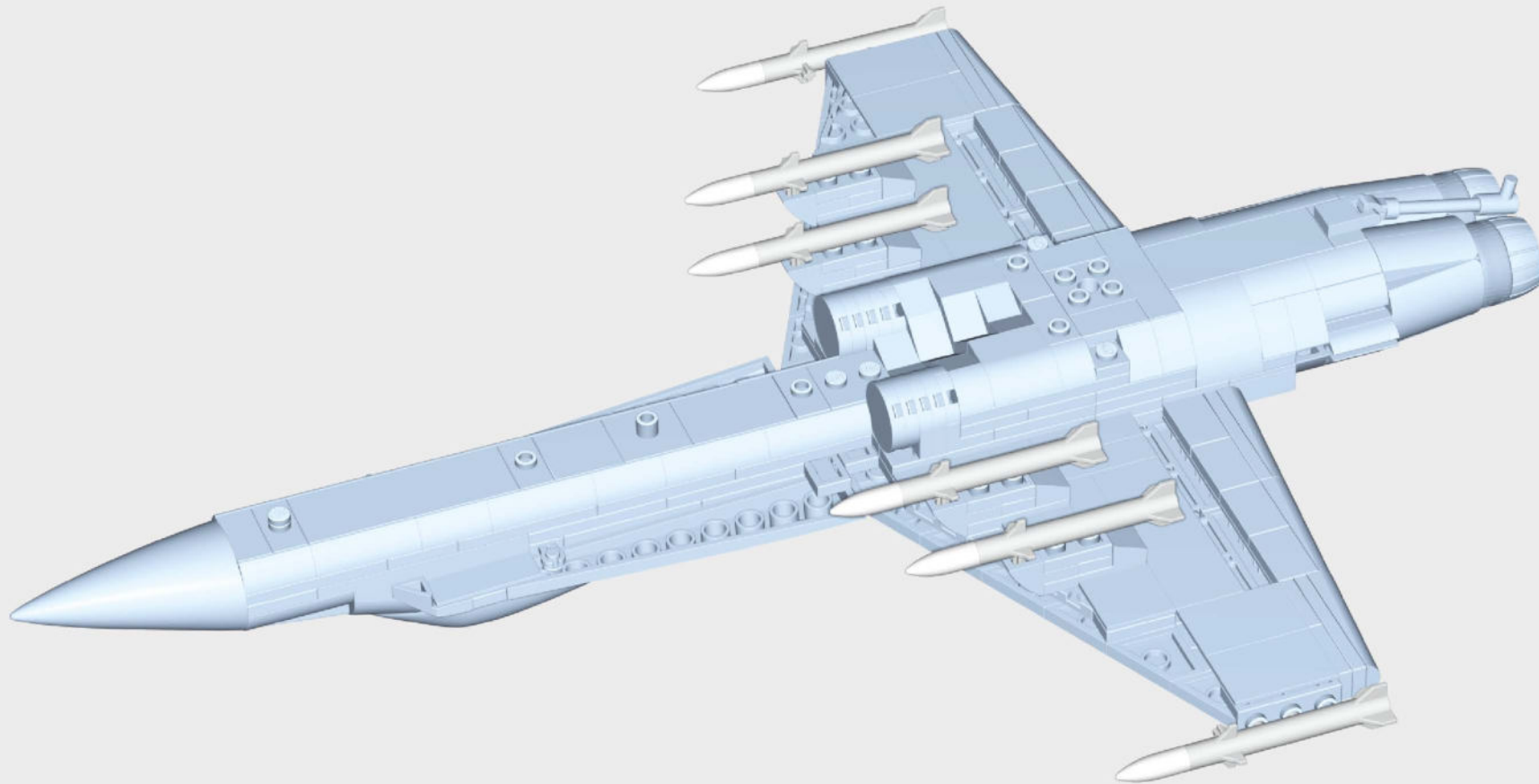

94



x1



x1



x1

95

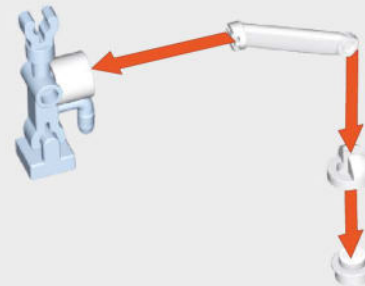

x1



x1



x1



x1

96



x2



x2



x1

97

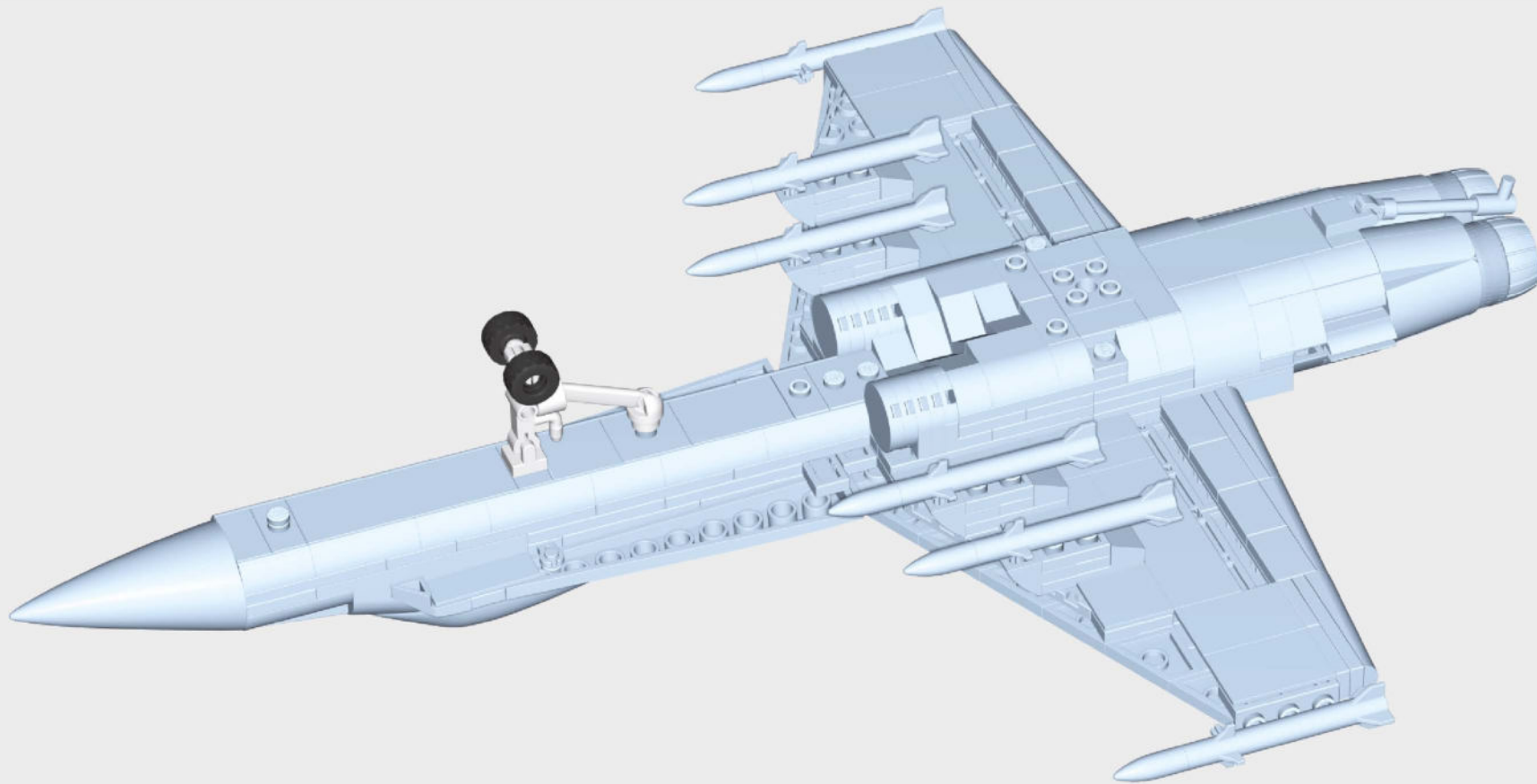

98

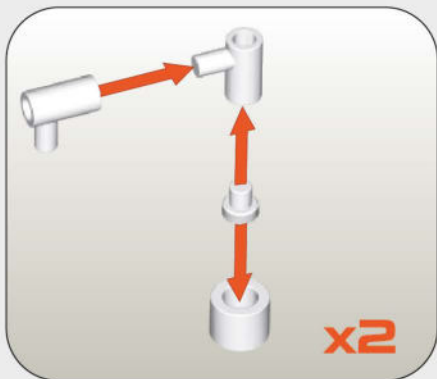

99

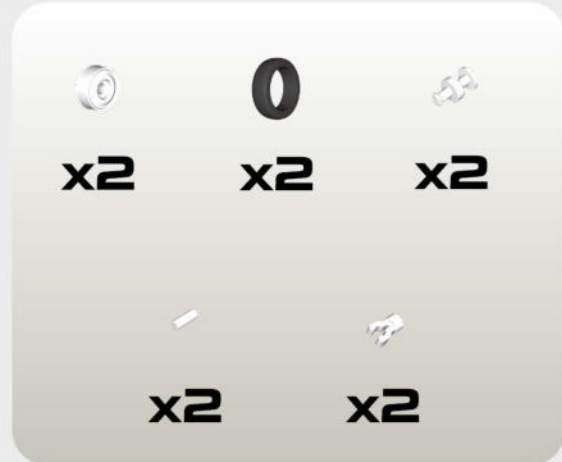

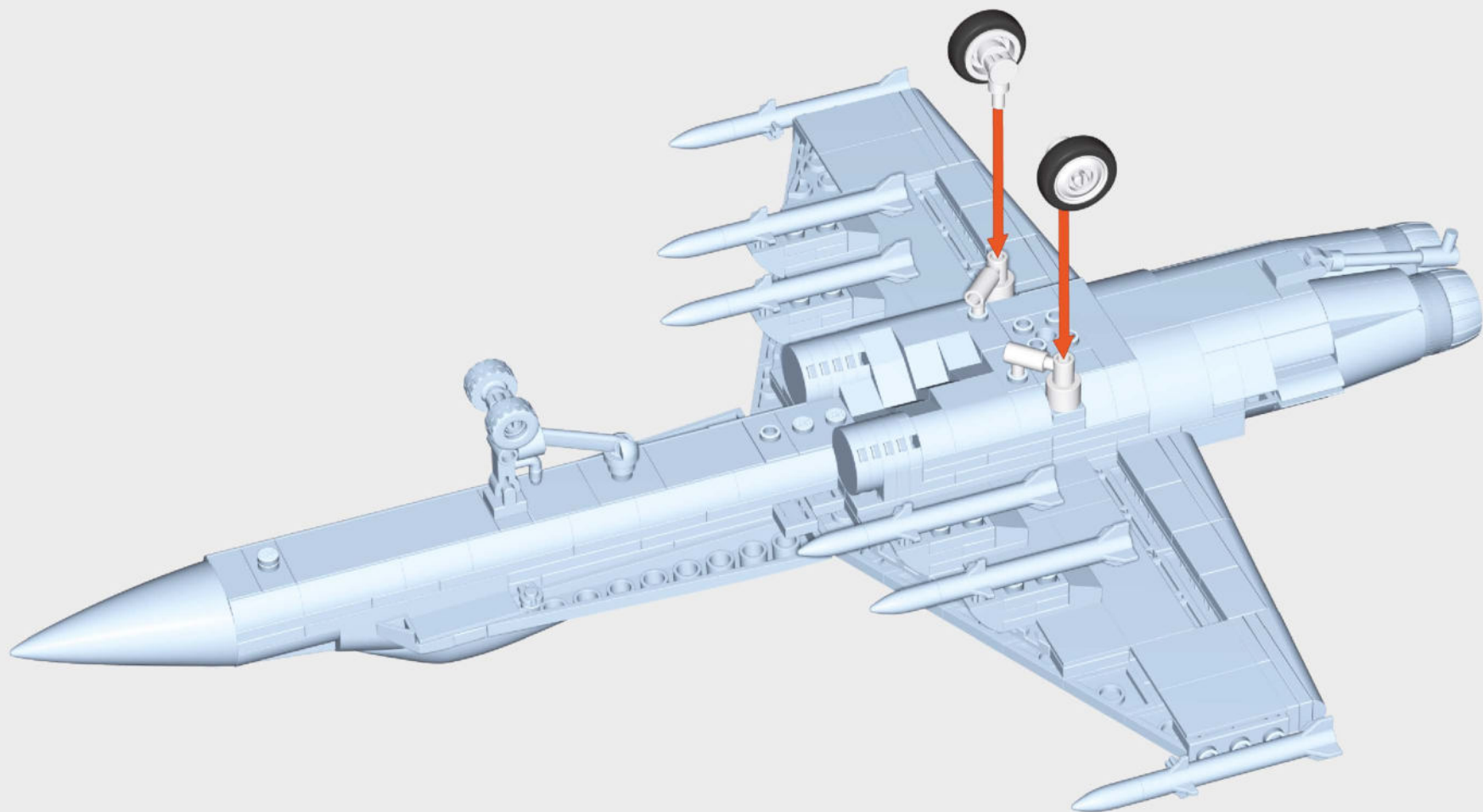

101

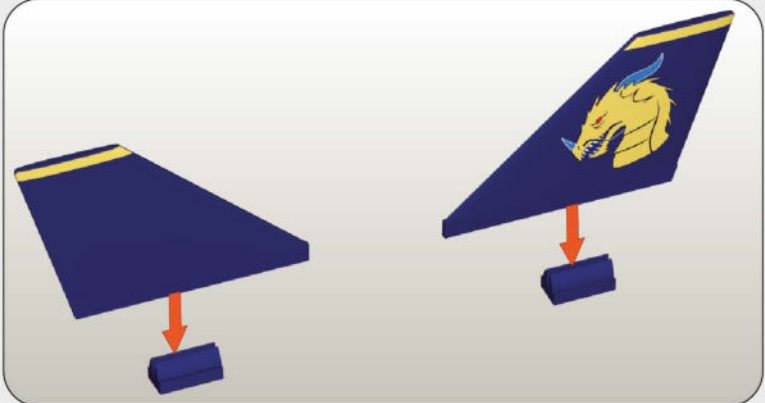
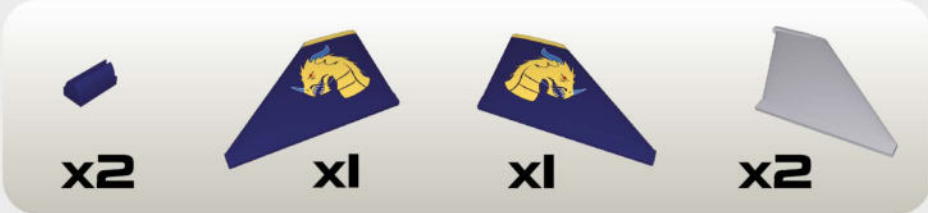
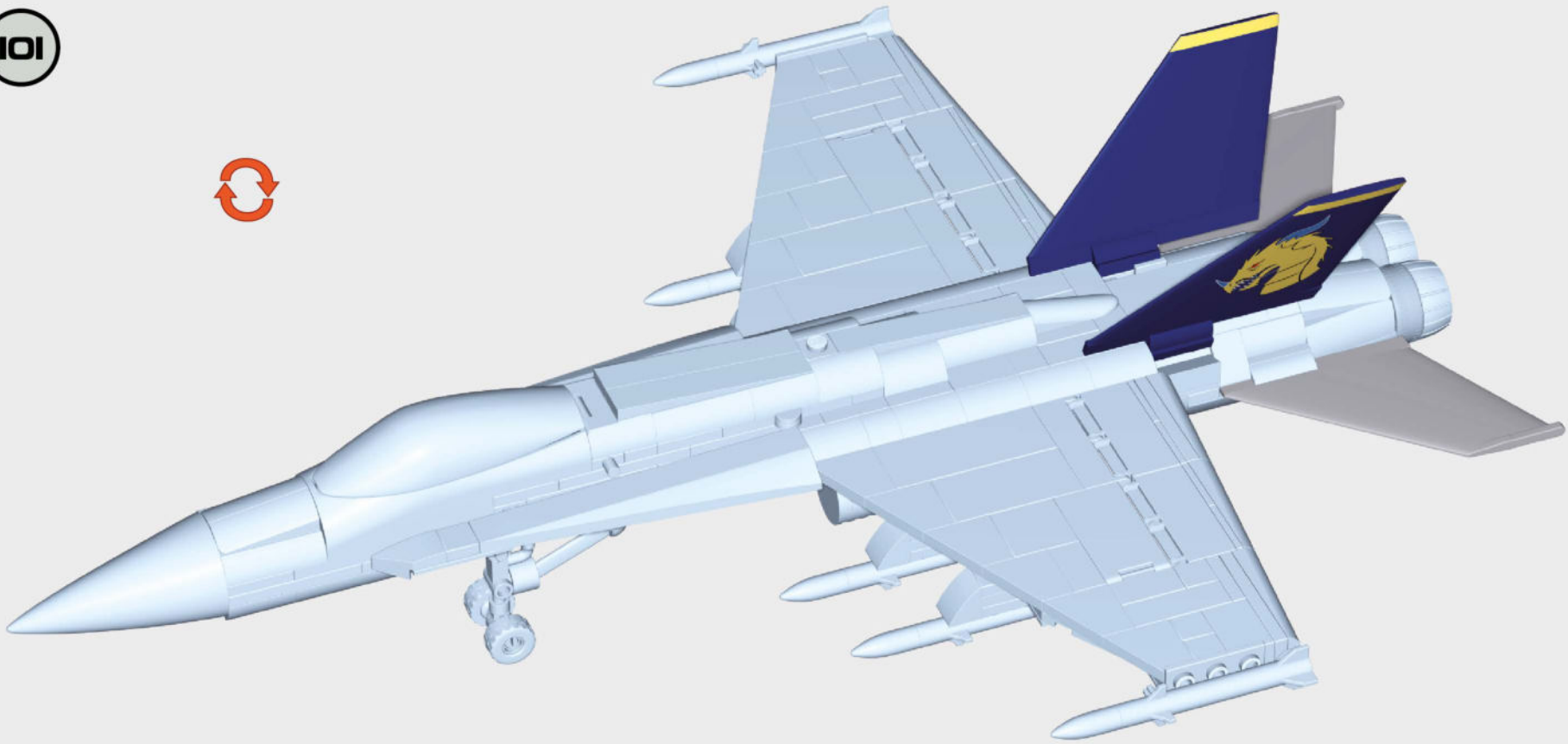

102

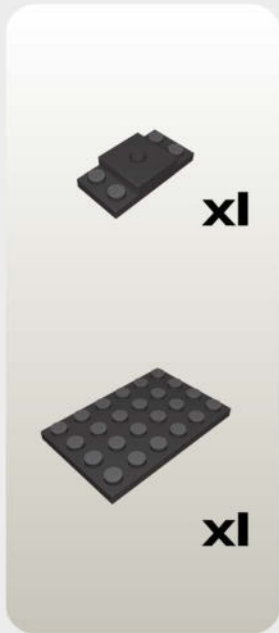

103

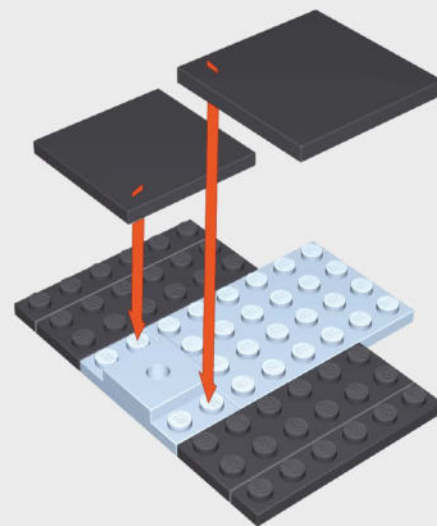

104

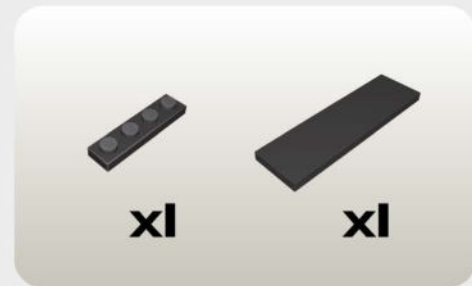
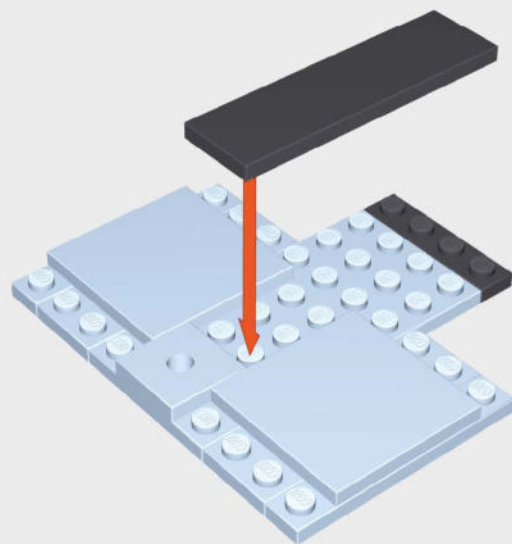

105

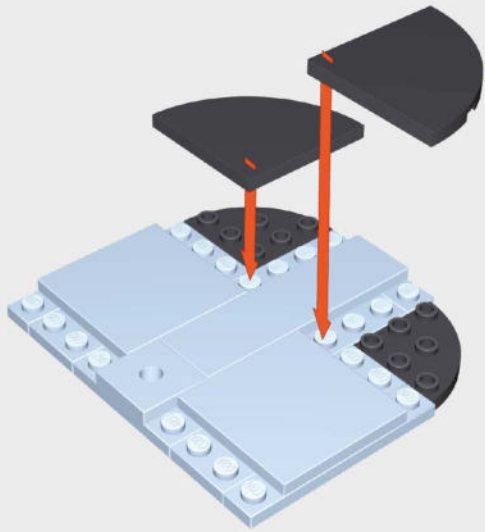

106

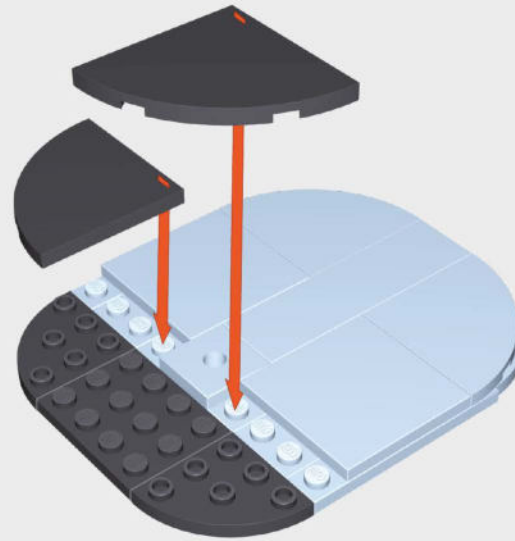

107

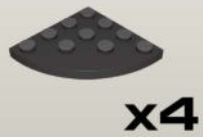
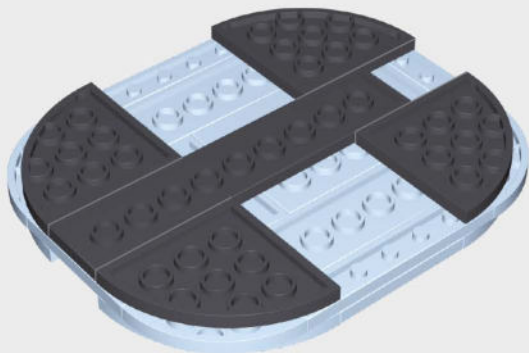

108

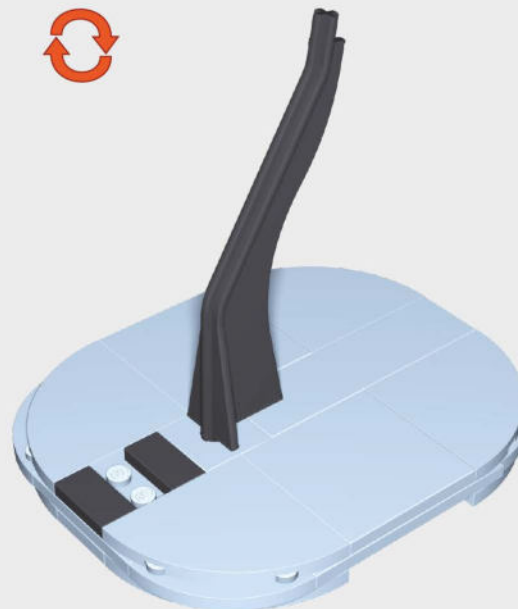

1:1

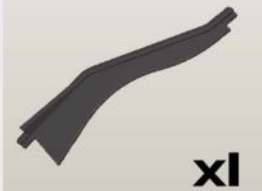



x2



x1



x1

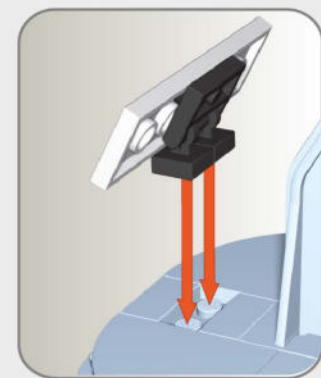
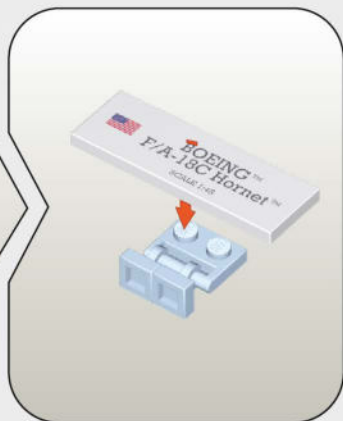
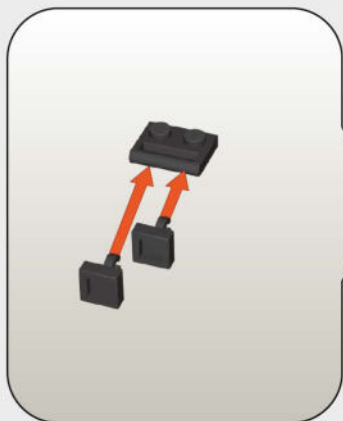
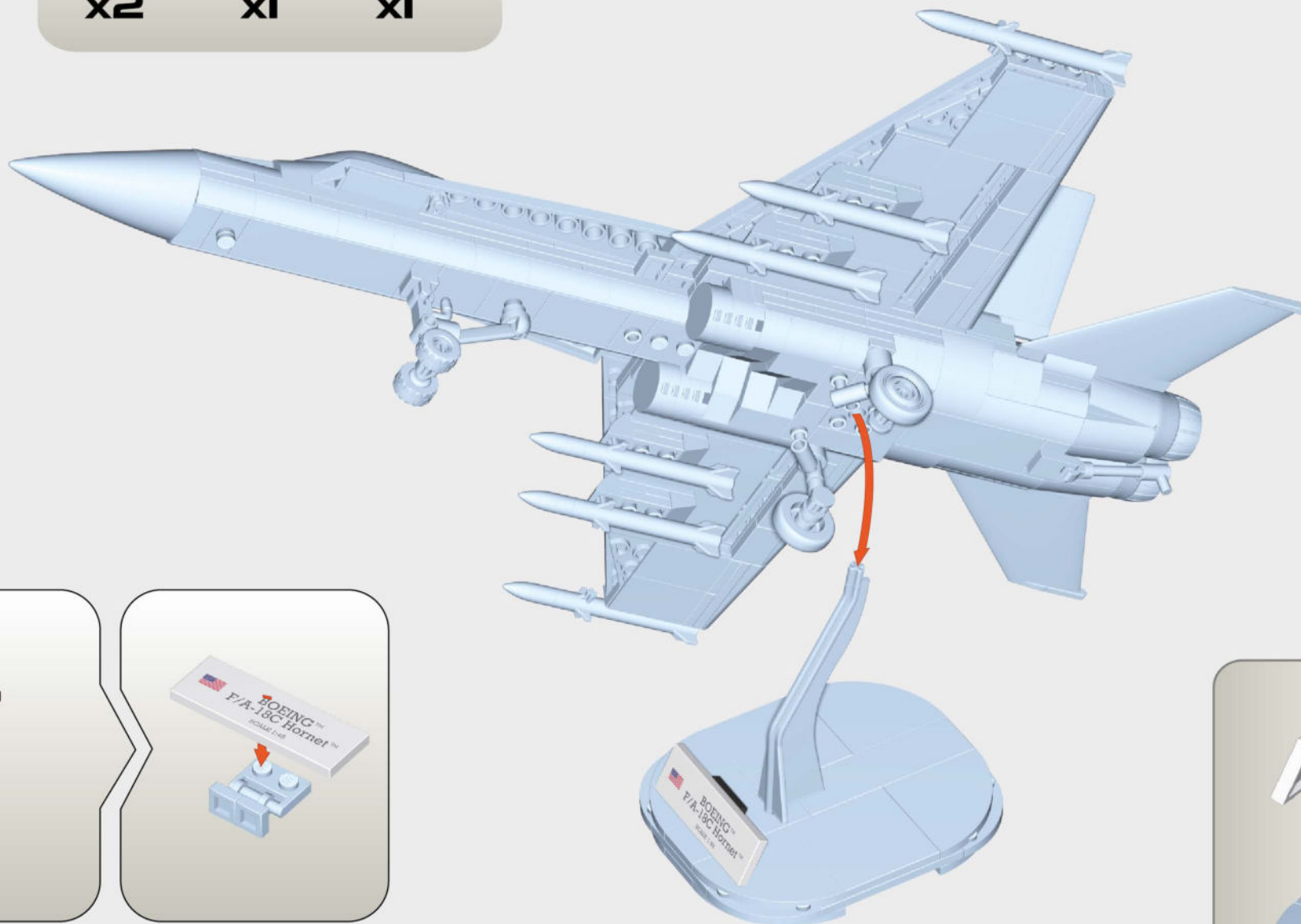

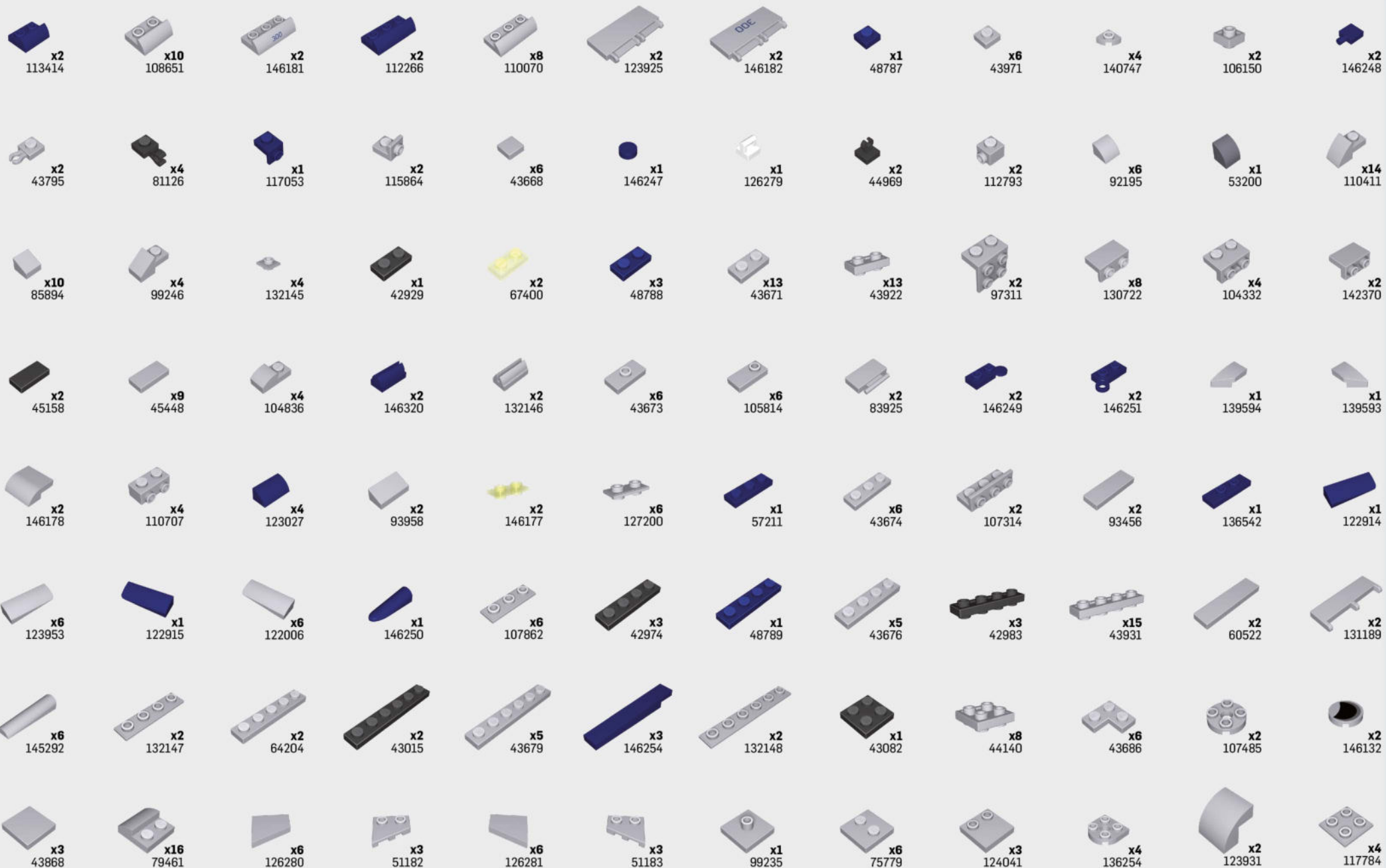





Produced under license from Boeing. Boeing and F/A-18 Hornet are trademarks of The Boeing Company.



F/A-18C HORNET™
5819



F-16®C FIGHTING FALCON®
5814



LOCKHEED MARTIN®, F-16®C Fighting Falcon®, associated emblems and logos, and body designs of vehicles are either registered trademarks or trademarks of Lockheed Martin Corporation in the USA and/or other jurisdictions, used under license by COBI.



LOCKHEED MARTIN®, F-16®D Fighting Falcon®, associated emblems and logos, and body designs of vehicles are either registered trademarks or trademarks of Lockheed Martin Corporation in the USA and/or other jurisdictions, used under license by COBI.



F-16®D FIGHTING FALCON®
5815

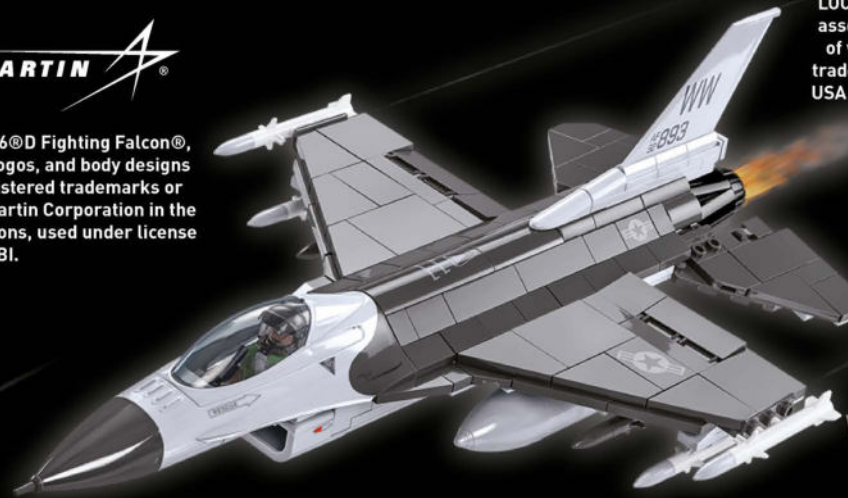

F-16®C FIGHTING FALCON®
5813

WWW.COBI.EU

For news and special deals

Find us on:



03-05810-534