

HISTORICAL COLLECTION

COLD WAR



MIG-17 NATO CODE "FRESCO"

IN SERVICE - 1952 - EARLY 1970s
PLACE OF ORIGIN - SOVIET UNION
NATO DESIGNATION - FRESCO
ROLE - FIGHTER
WINGSPAN - 9,63m (31' 7")
LENGTH - 11,36m (37' 3")
HEIGHT - 3,80m (12' 6")
ENGINE - 1x KLIMOV WK-1F TURBOJET
MAXIMUM RANGE - 1930KM (1199MI)
RATE OF CLIMB - 65M/S (12795FT/MIN)
MAXIMUM FLIGHT LEVEL - 16600M (54461FT)
SPEED - 1145KM/H (711MPH)
ARMAMENT - 1x N-37D KAL. 37MM GUN,
2x NR-23 KAL. 23MM GUNS, BOMBS, ROCKETS (MAX 500KG)
OR FUEL TANKS (2x 400L)
CREW - 1 PILOT



5823

PAD PRINTED
NO STICKERS

Printed in EU



WARNING: CHOKING HAZARD-
Toy contains small parts.
Not for children under 3 years.

568  1 

MIG-17 NATO CODE **"FRESCO"**

SCALE 1:32



1

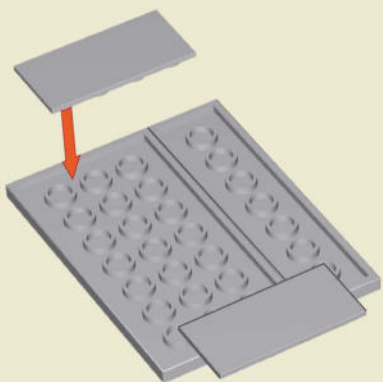

x1



x1



x2

2

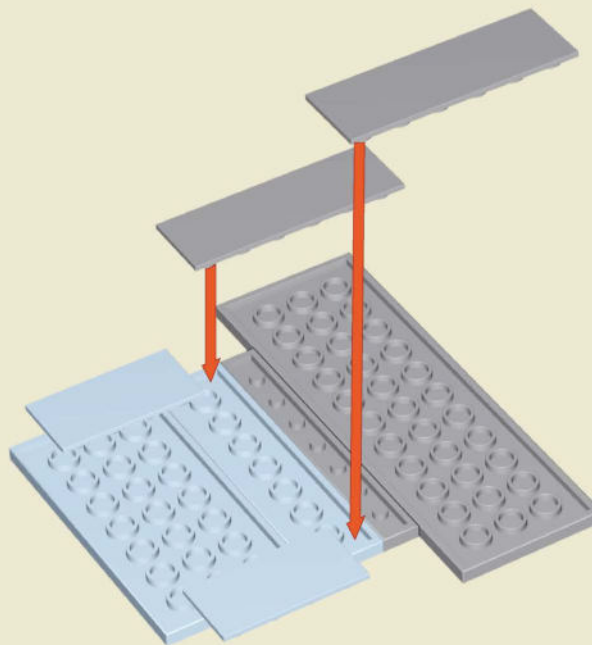

x1

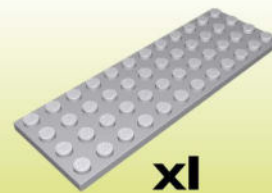

x1



x2

3

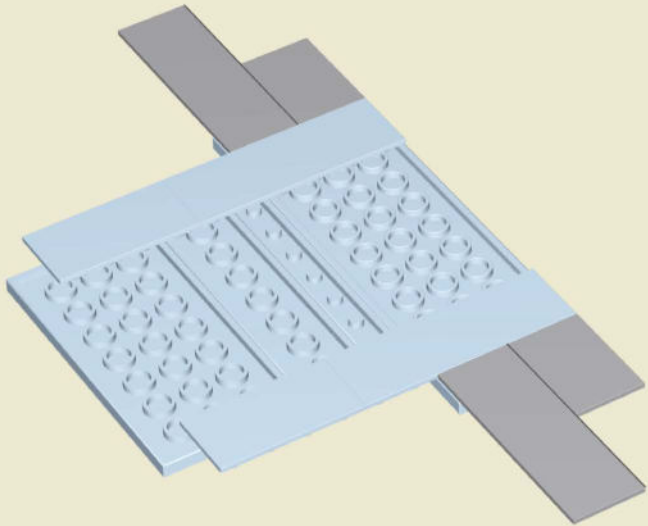

x2



x2

4

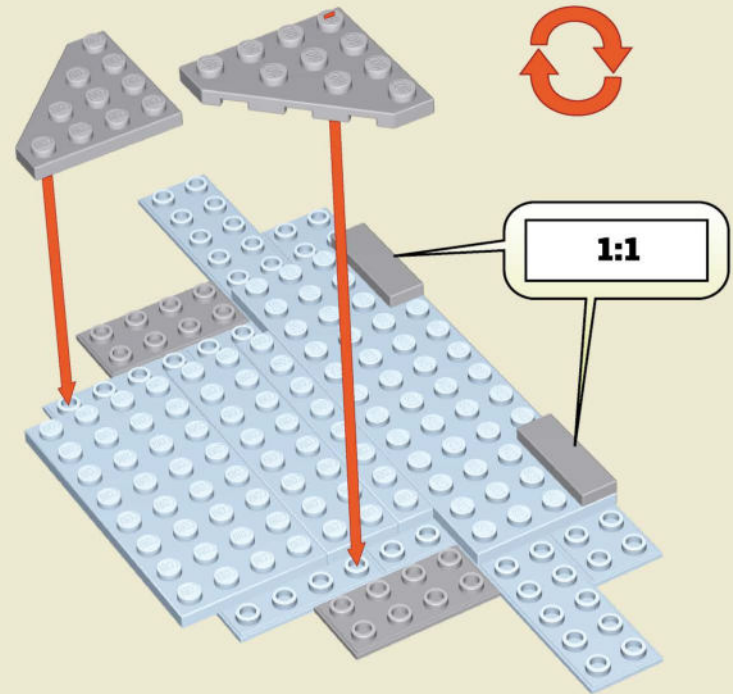

x2



x2



x2

5

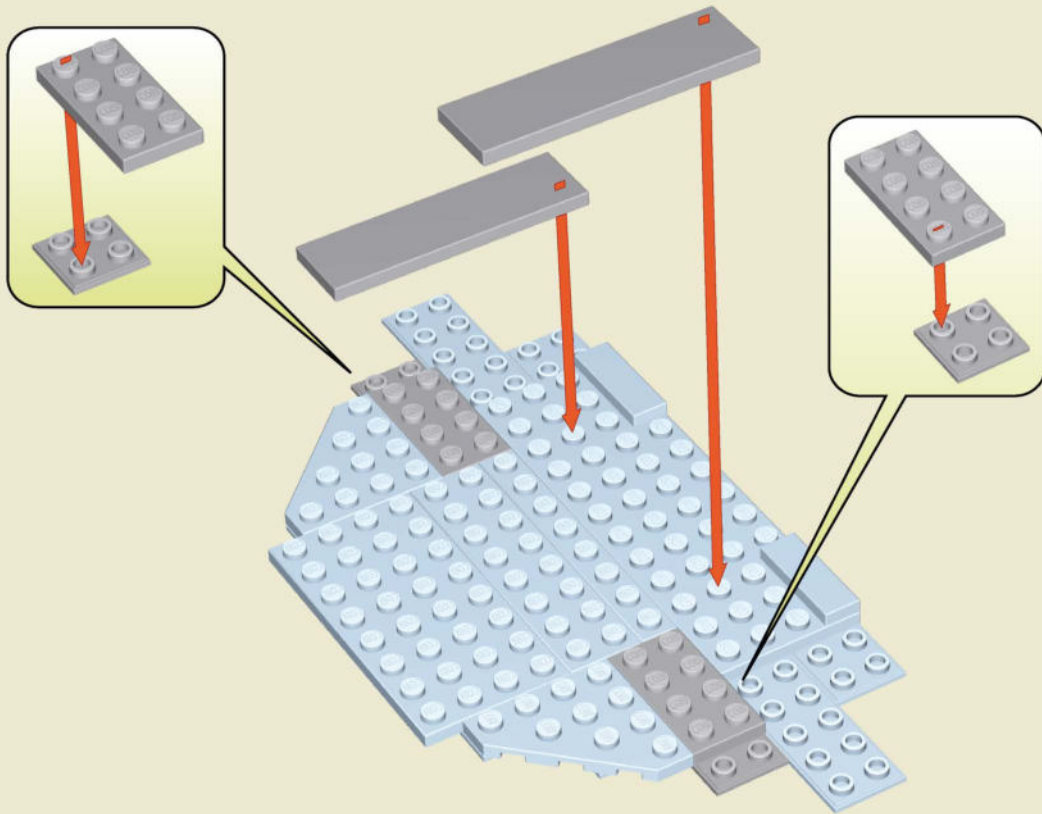

x2



x2

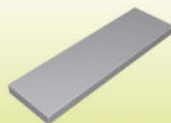

x2

6

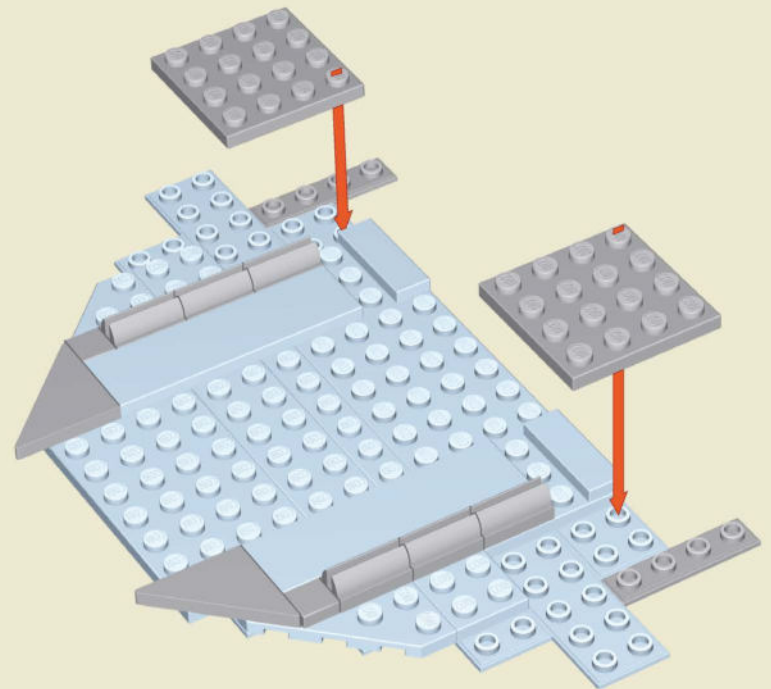

x2



x2



x6



x2



x2

7

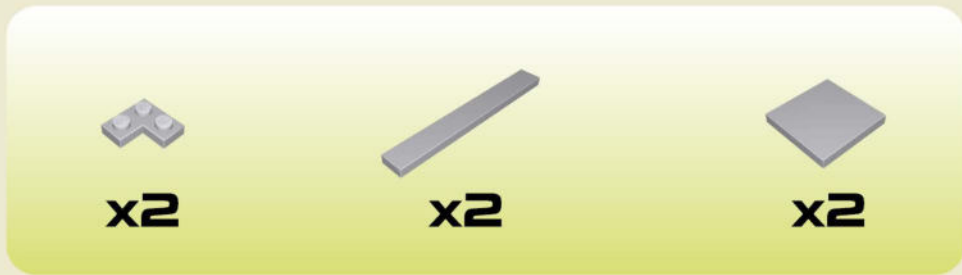
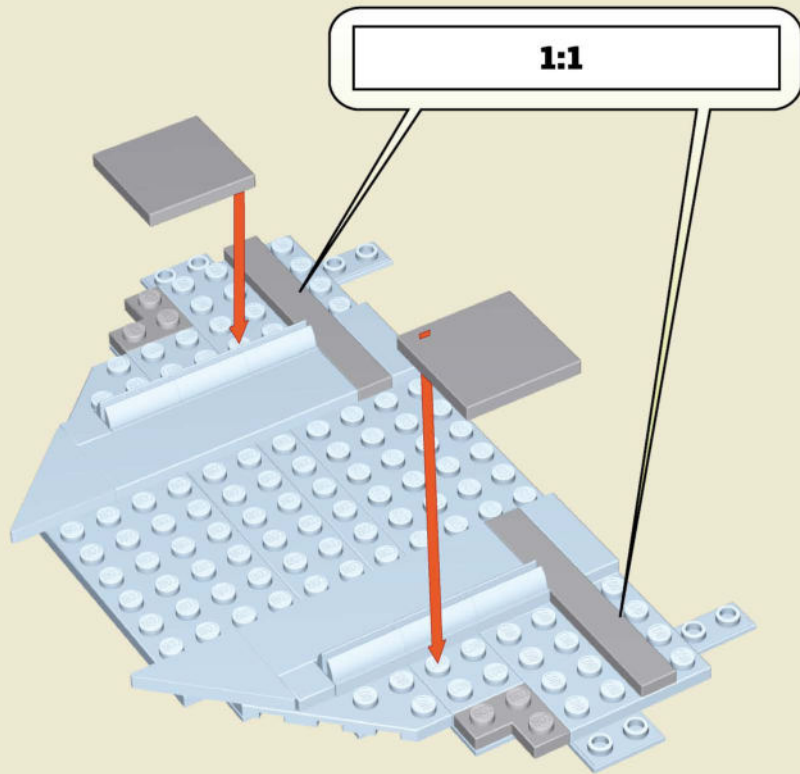

8

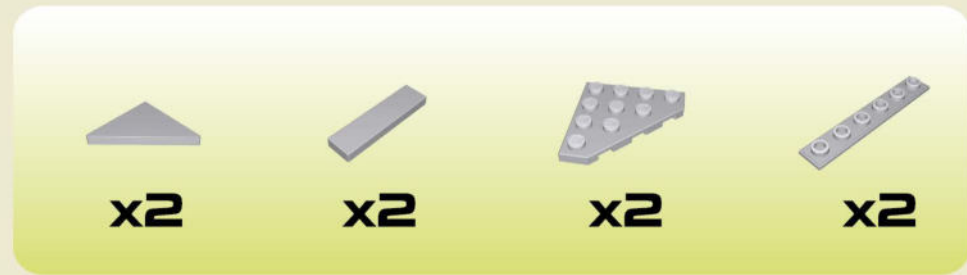
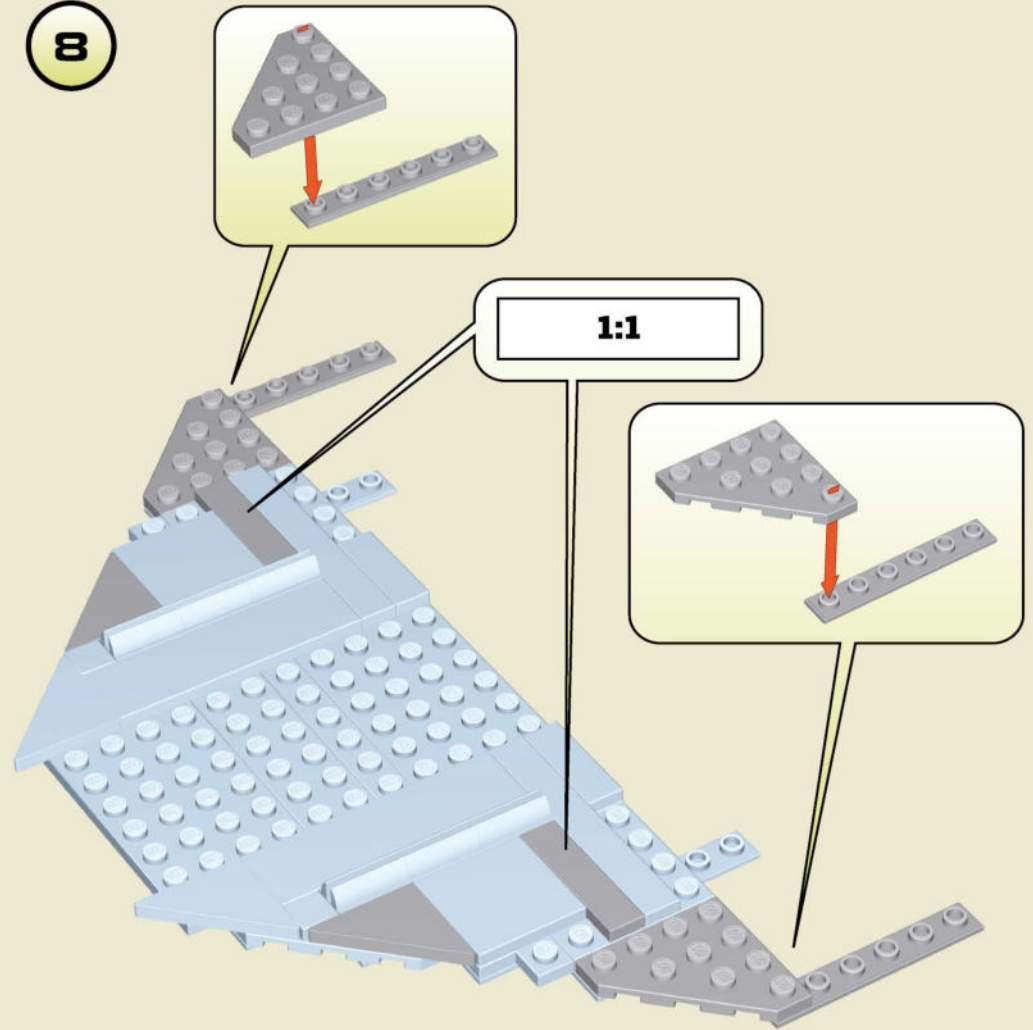



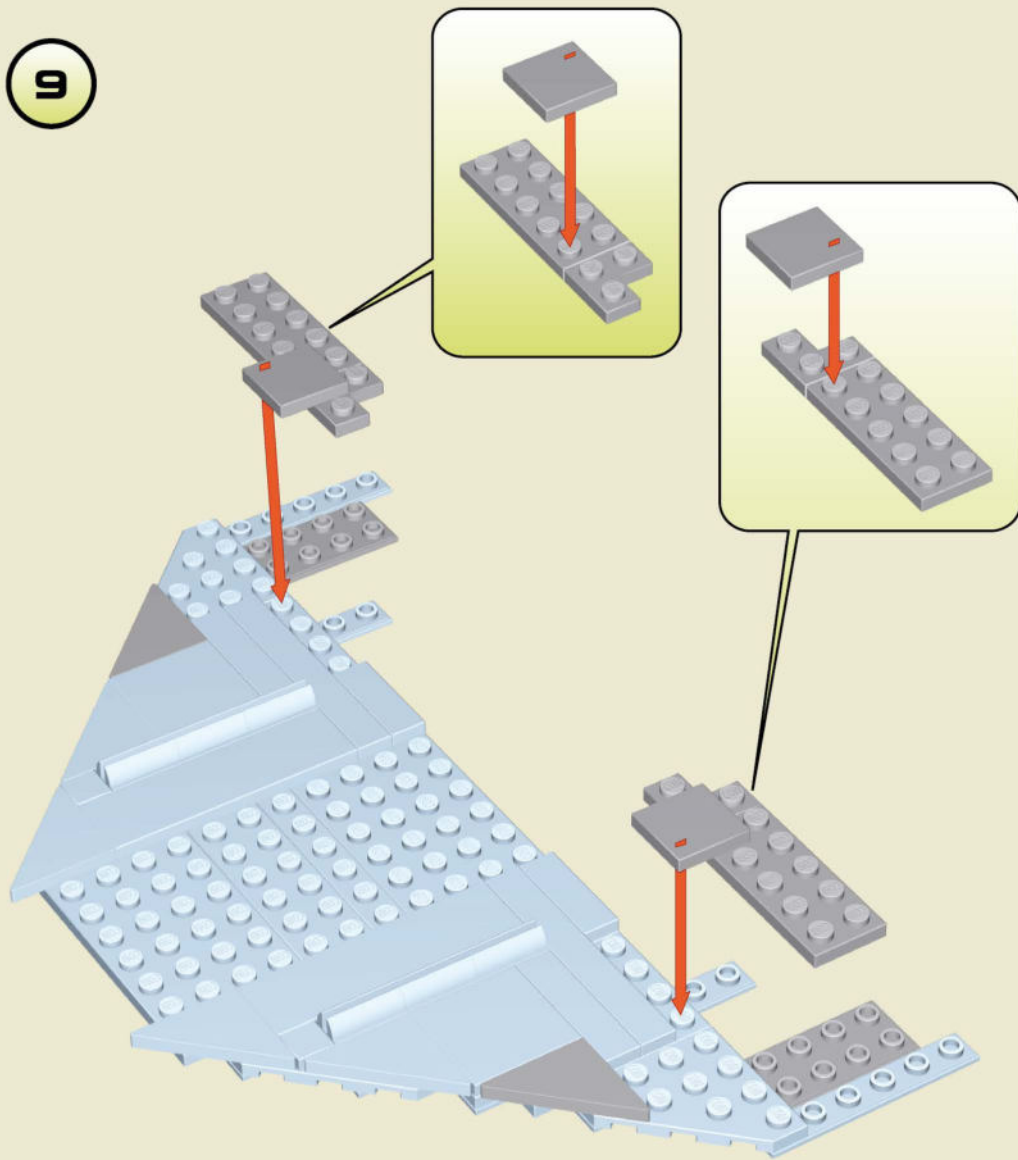



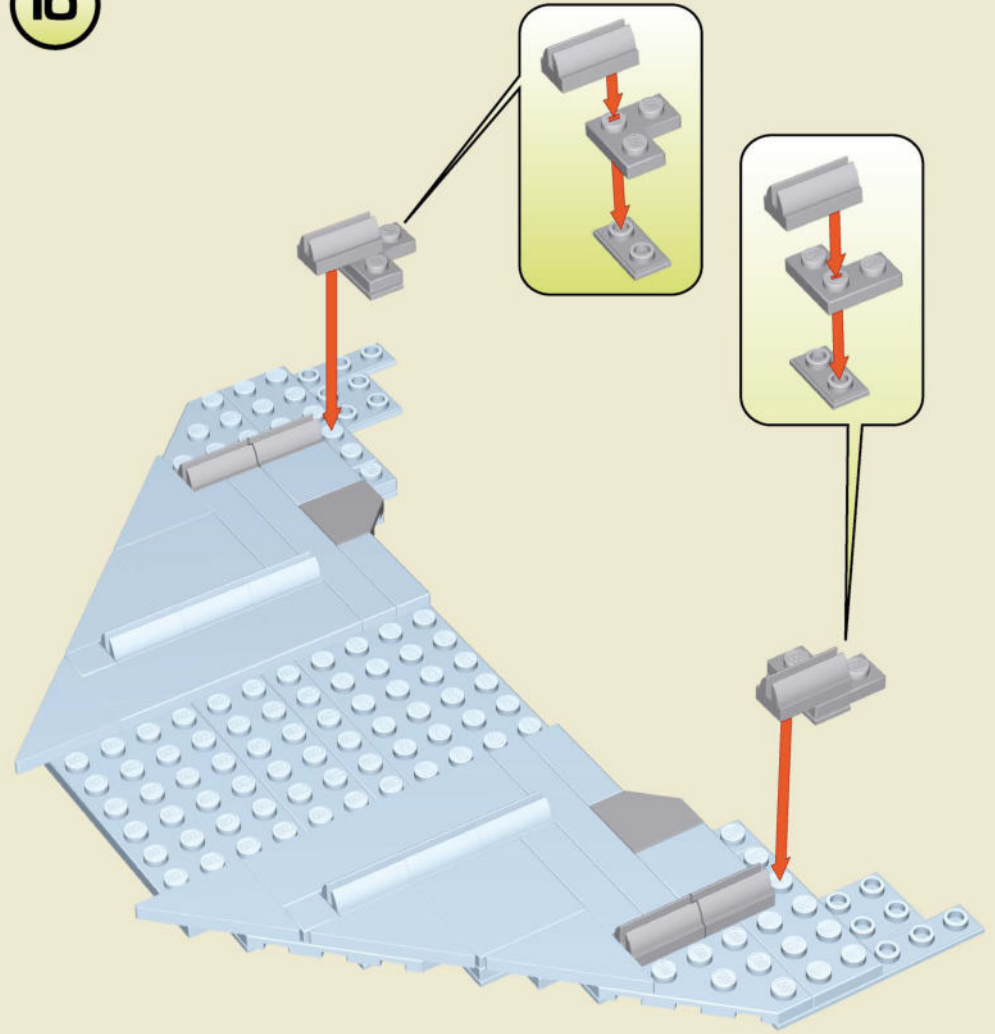

9



10





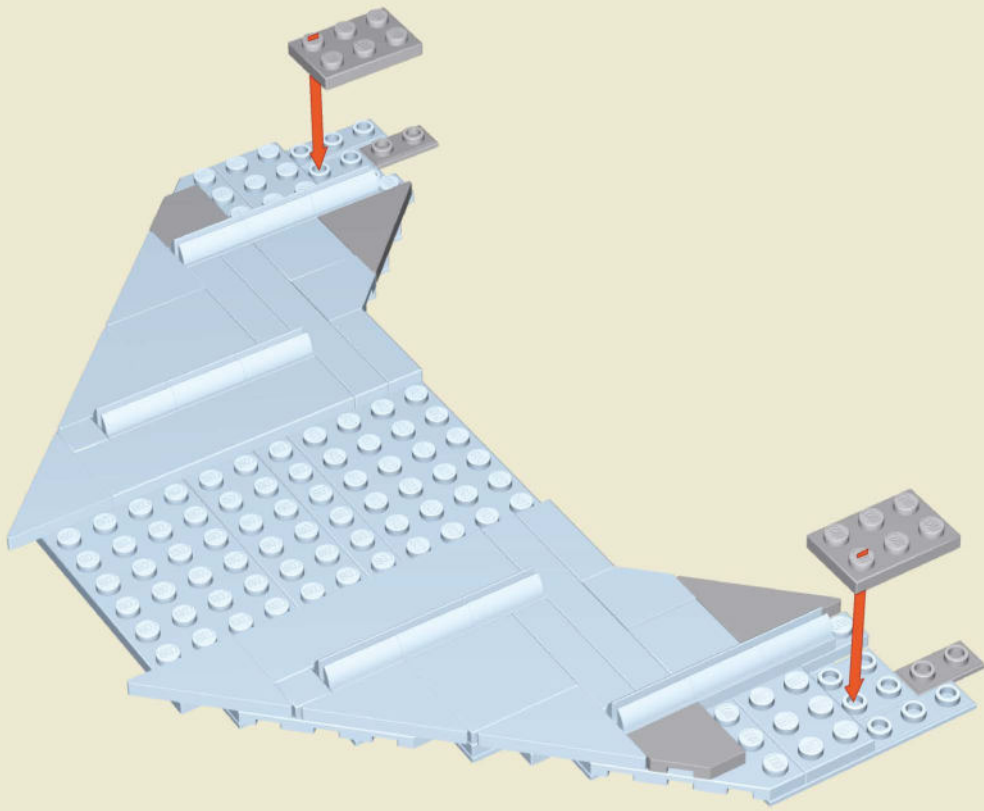

- 
x2
- 
x2
- 
x2
- 
x2
- 
x2

- 
x6
- 
x2
- 
x2
- 
x2





11

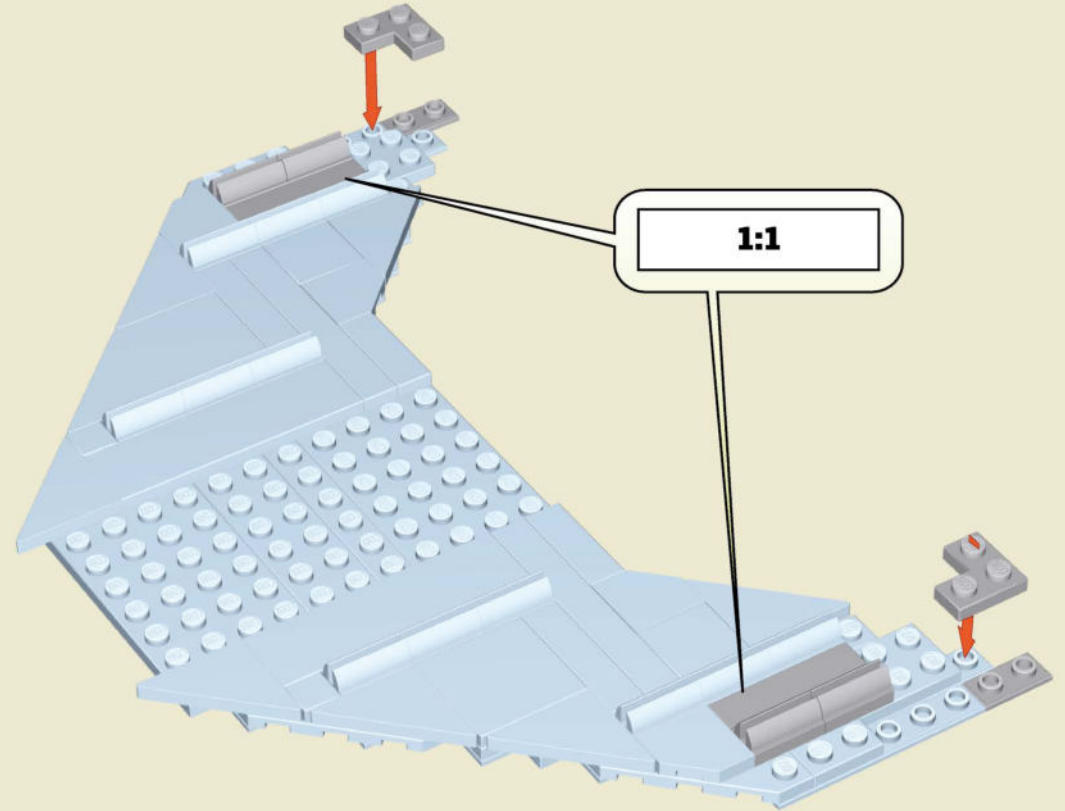

- 
x2
- 
x2
- 
x2
- 
x2

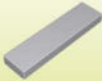
12



- 
x2
- 
x4
- 
x2
- 
x2

13

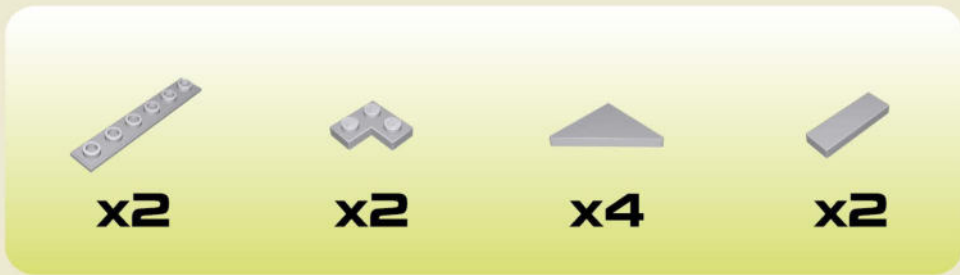
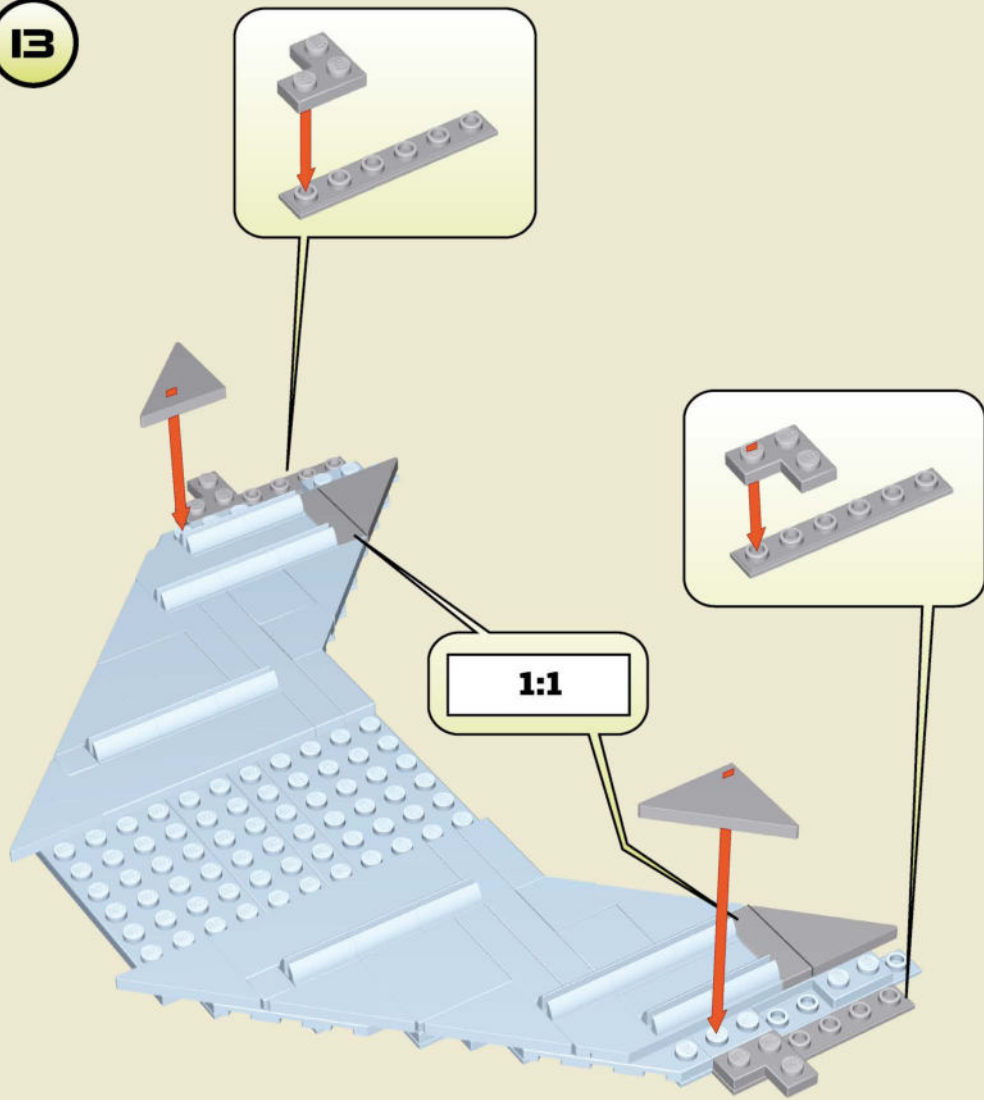

14

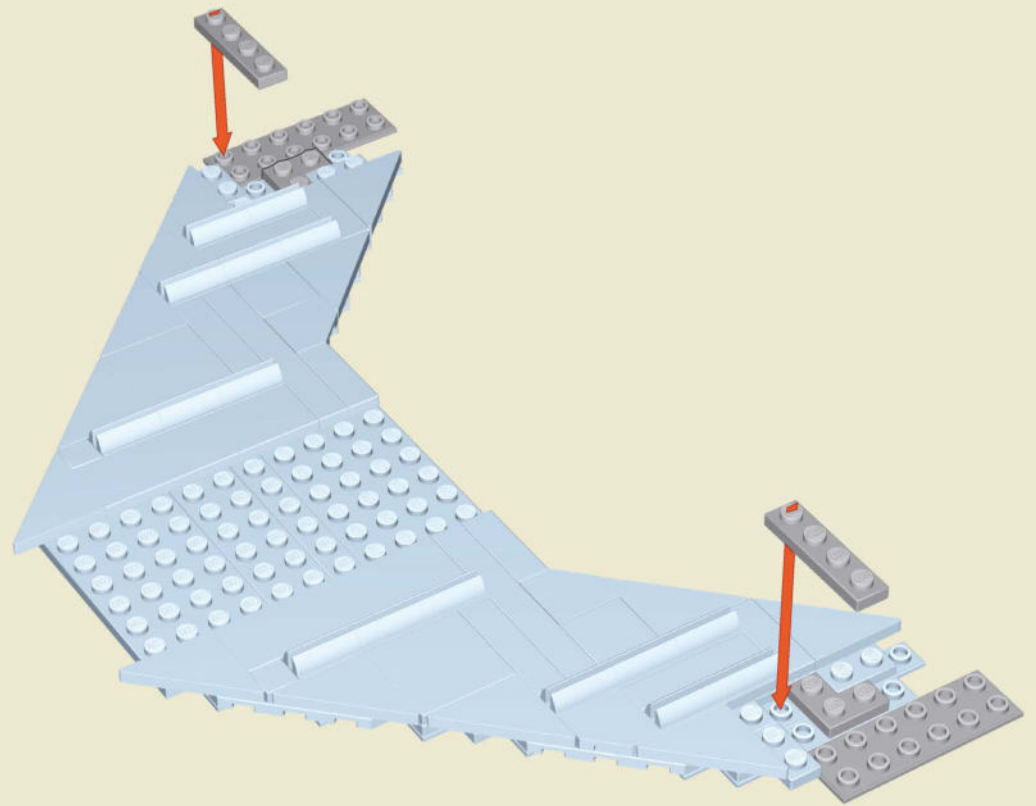

15

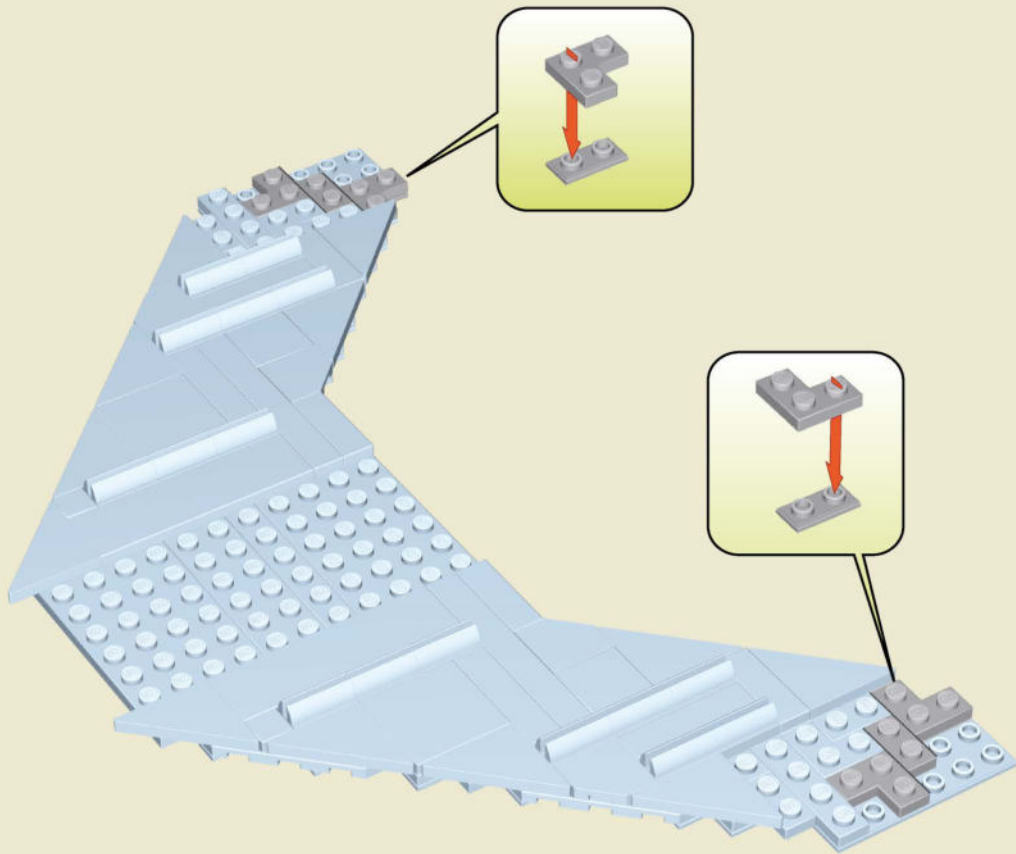

x4



x2



x2

16

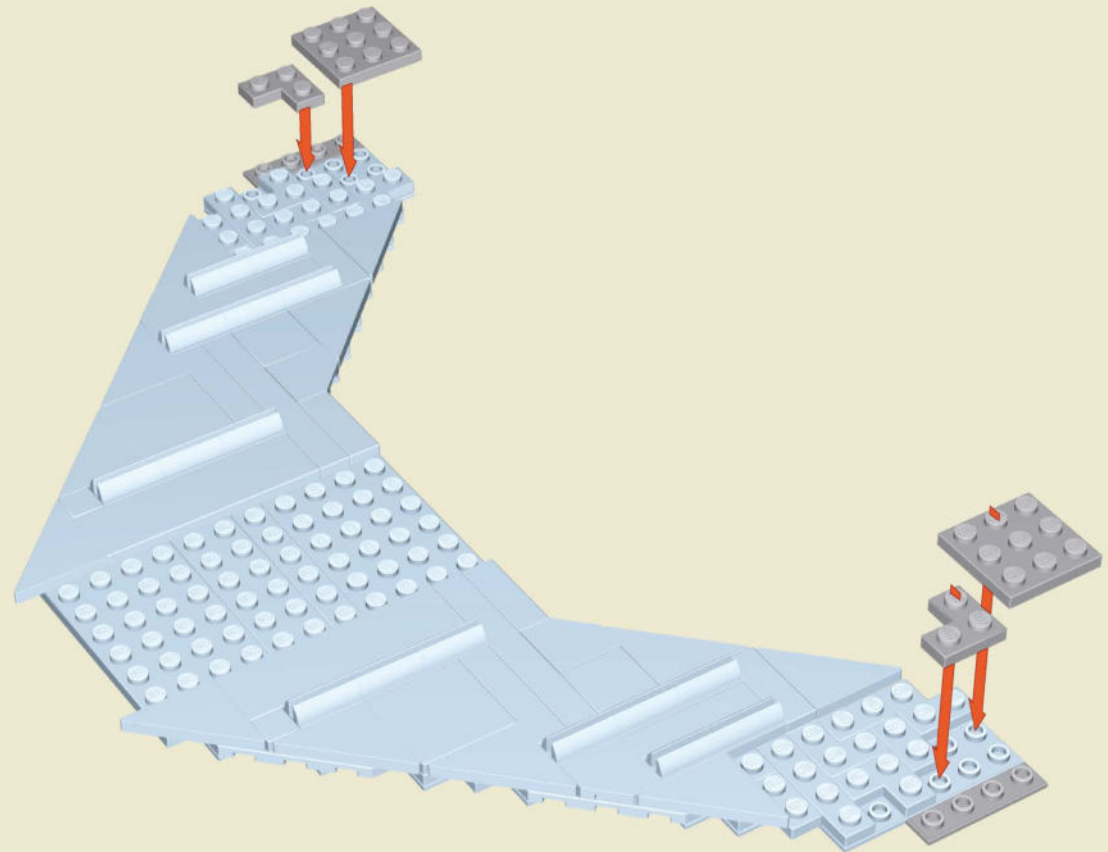

x2



x2



x2

17

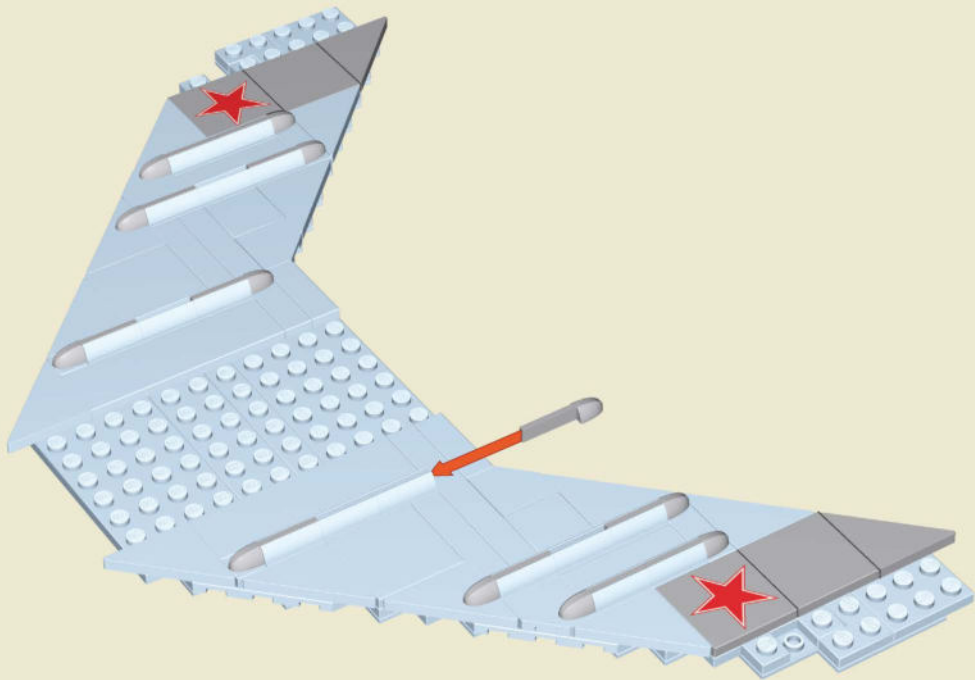

x2



x2



x2



x12

18

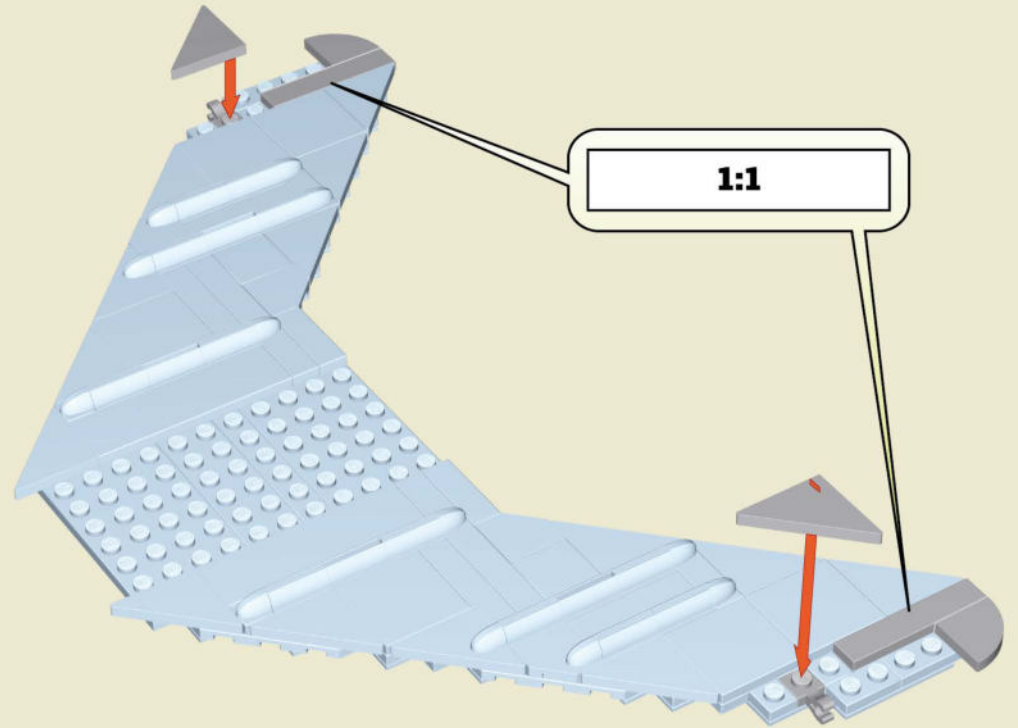

x2



x2

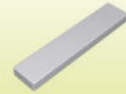

x2



x2

19

20

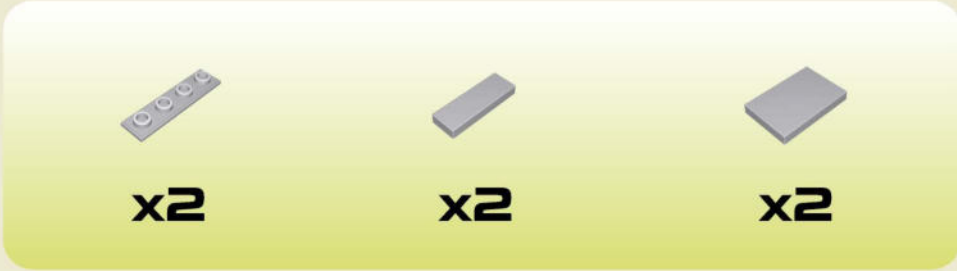
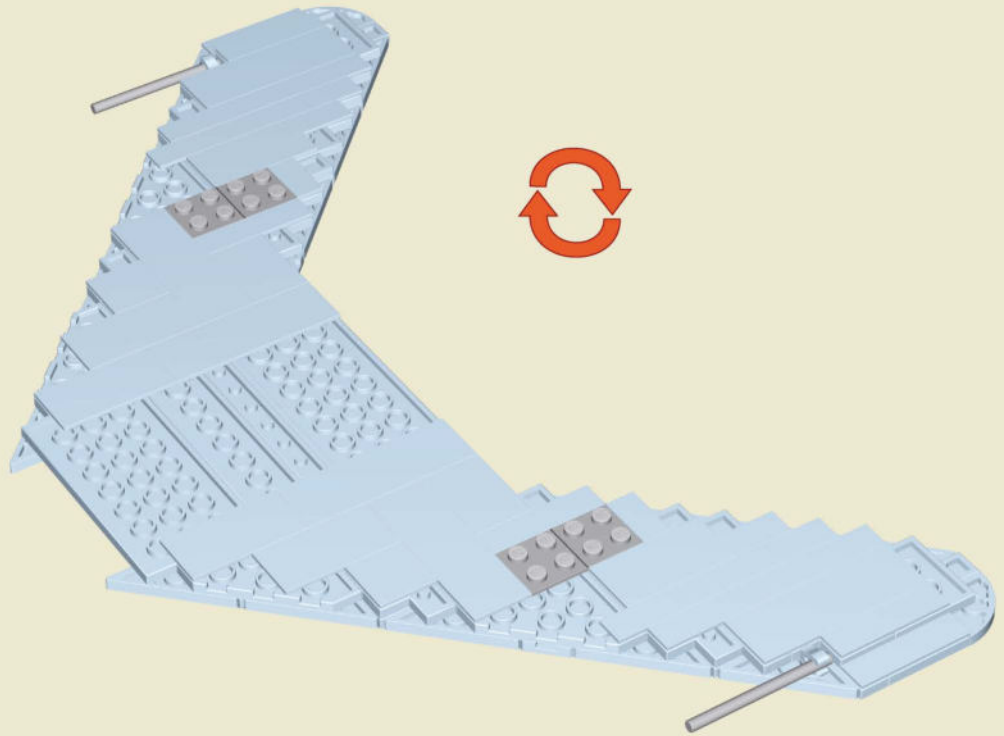
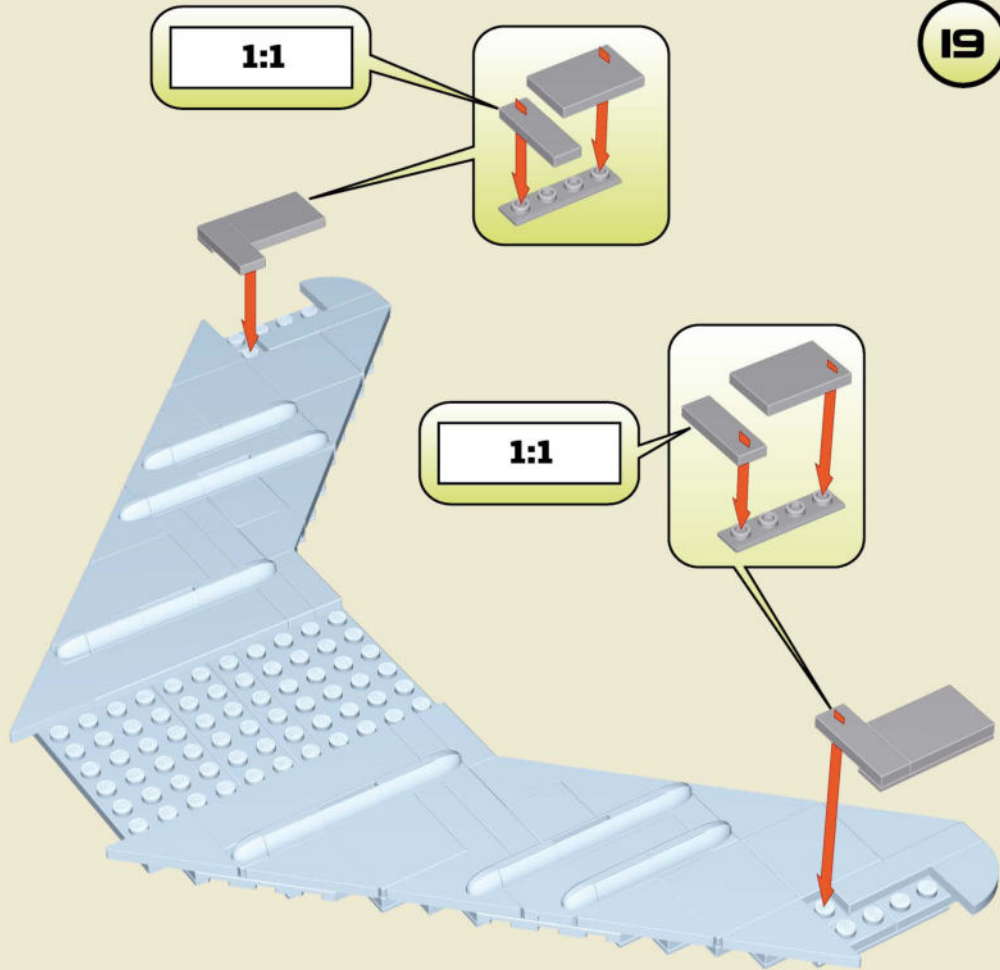

21

1:1

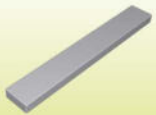
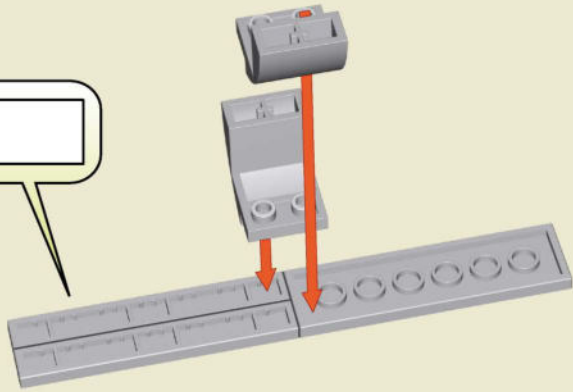

x2

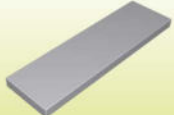

x1



x2

22

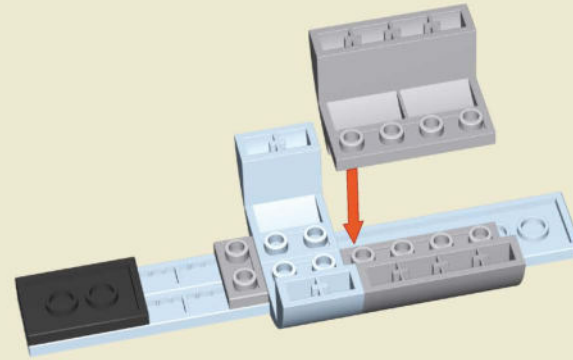

x1



x1

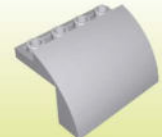

x2

23

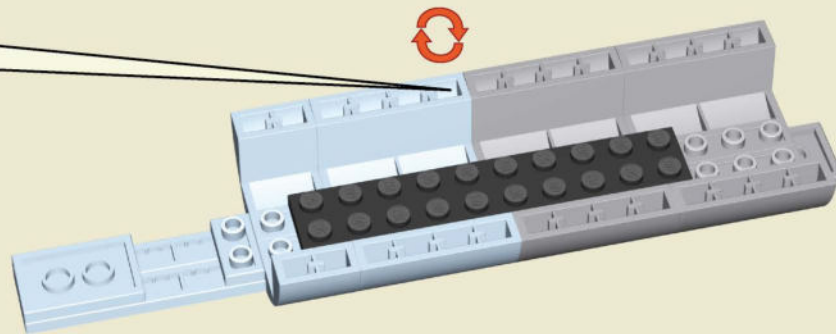
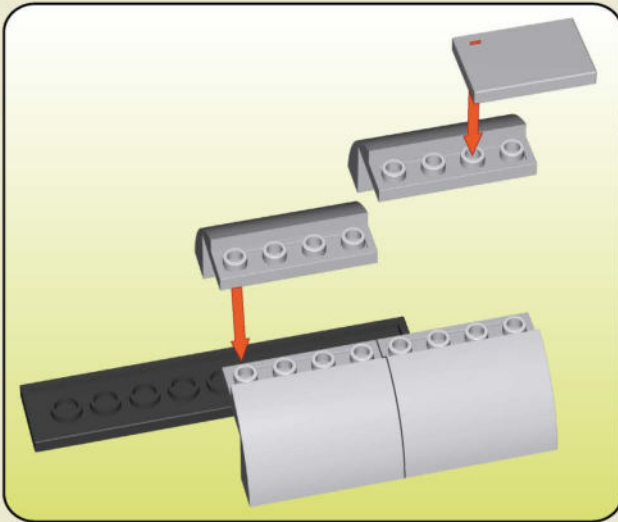

x1

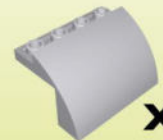

x4

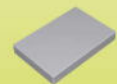

x1

24

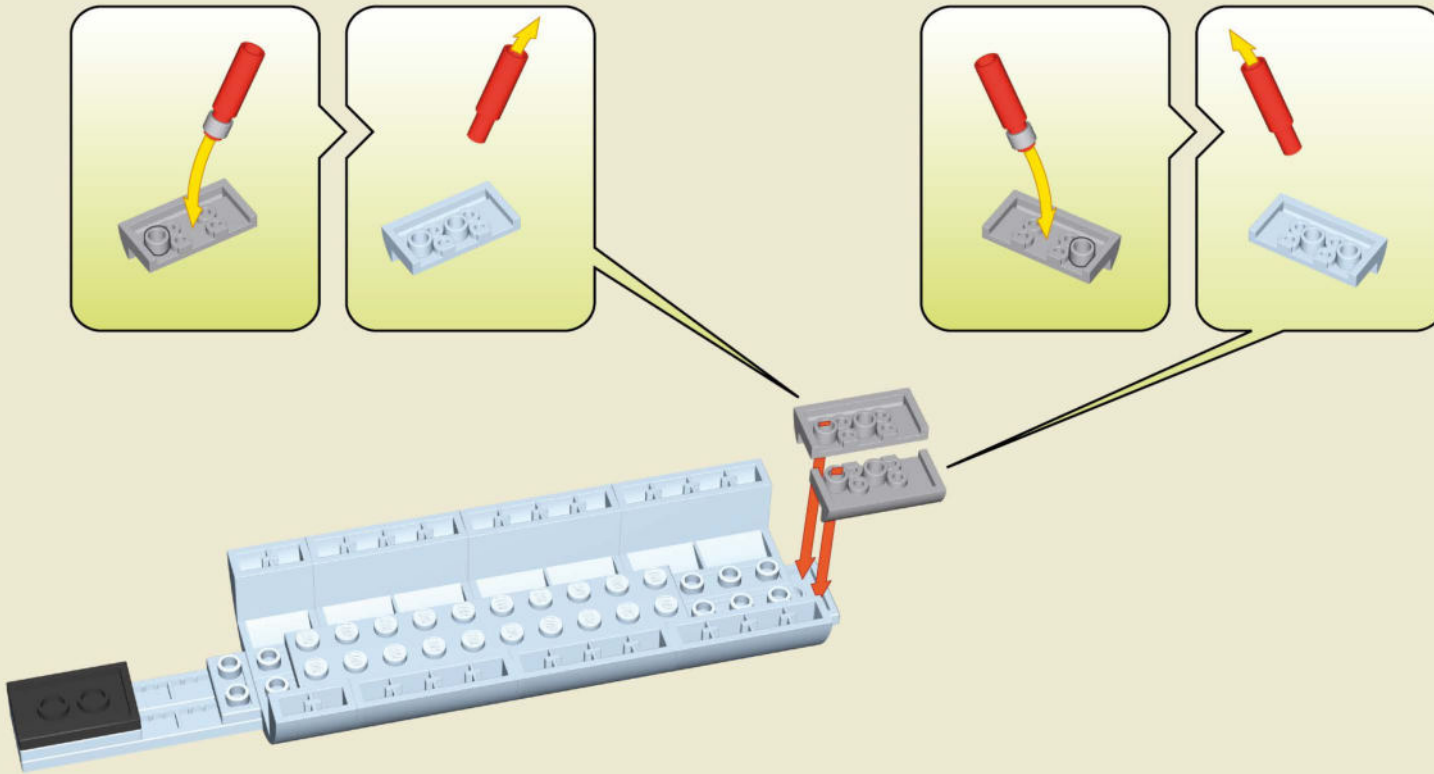

 x2

 x4

 x1

25

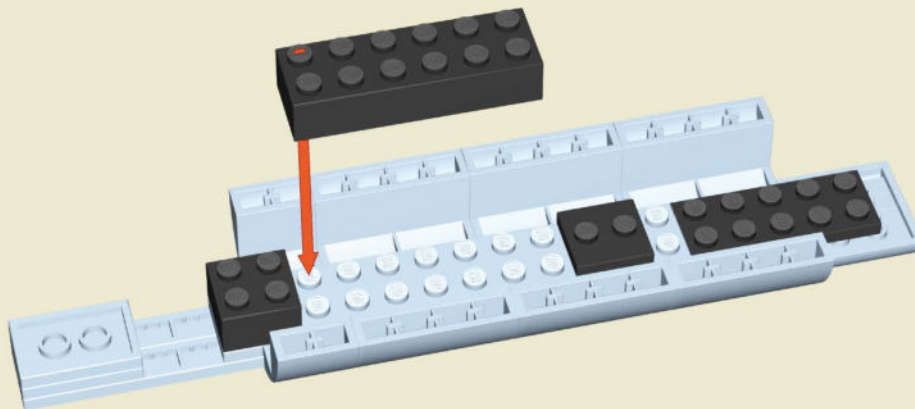

 x1

 x1

 x1

 x1

26

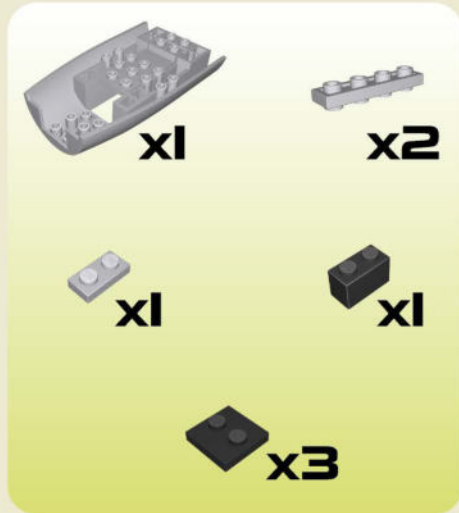
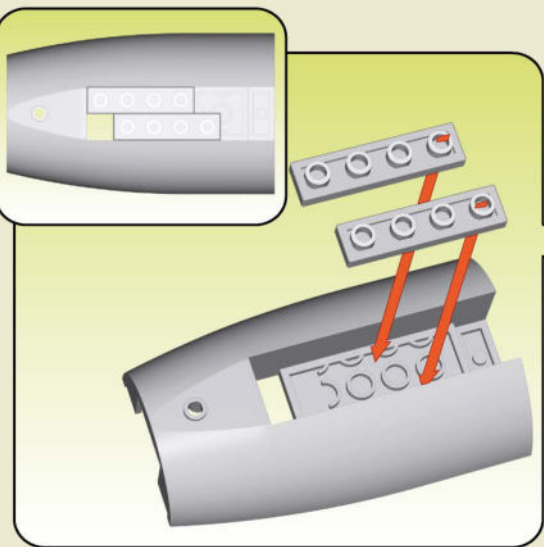

27

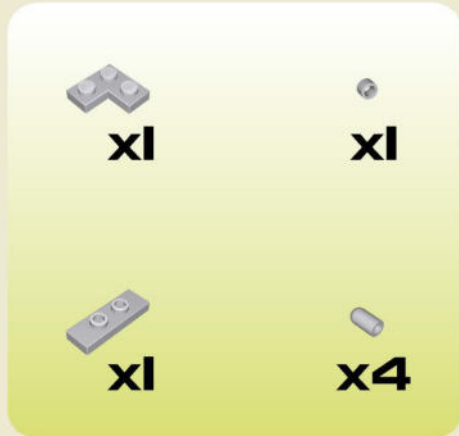
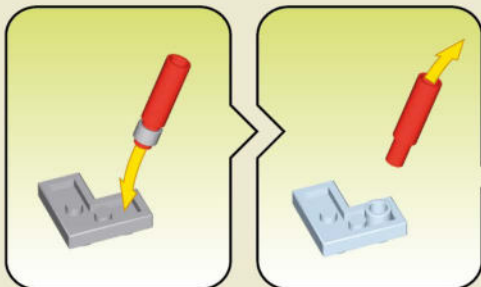

28

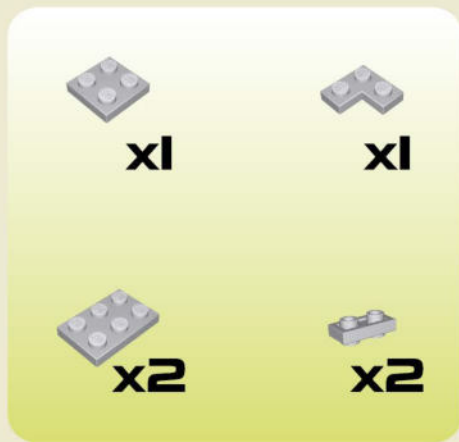

29

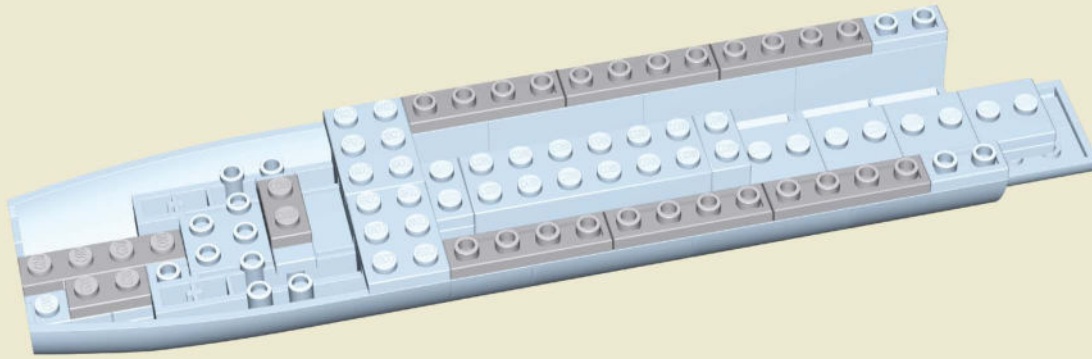

30

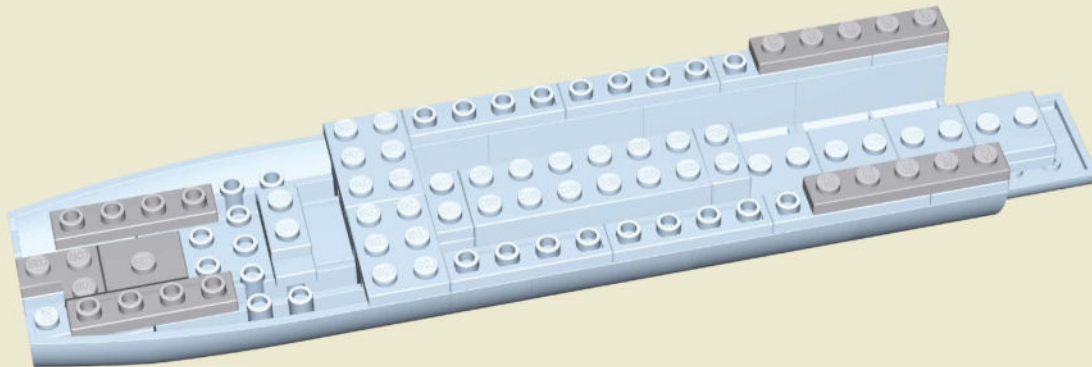

31

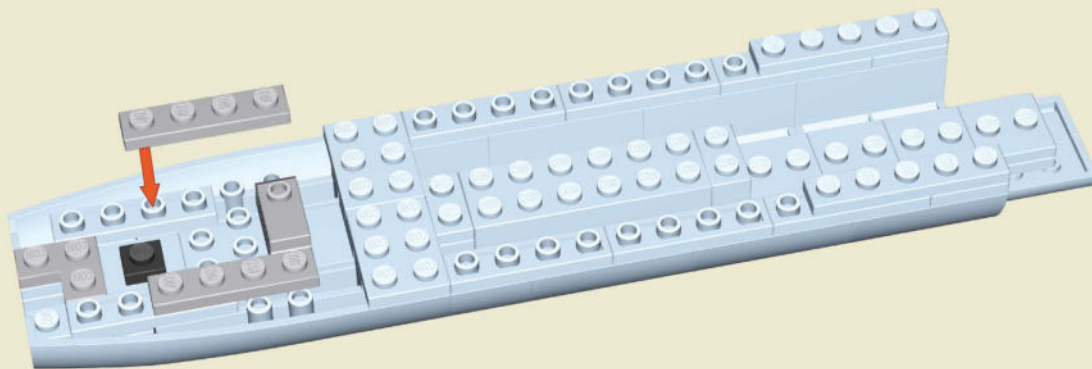

32

1:1

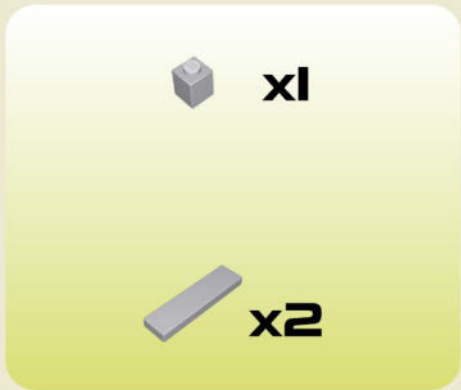
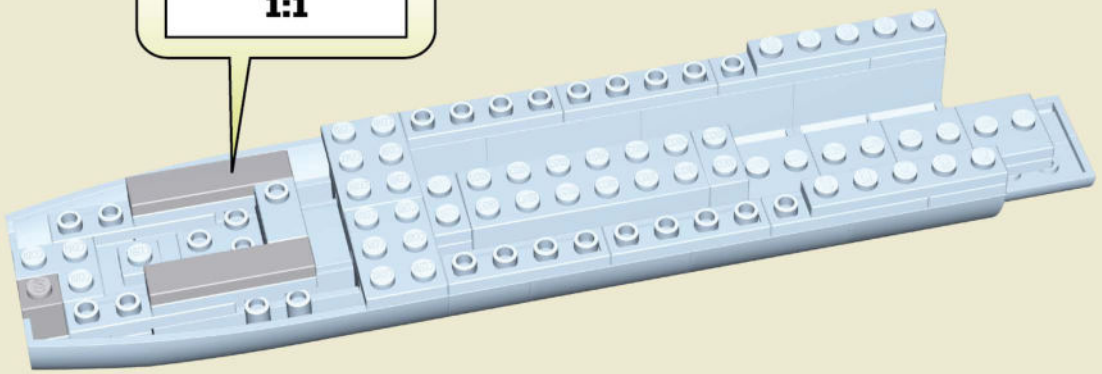

33

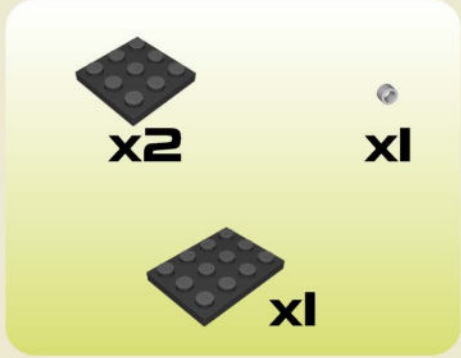
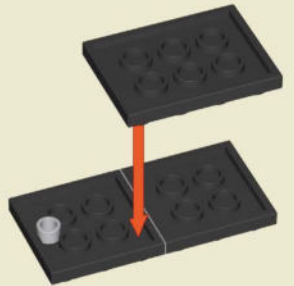
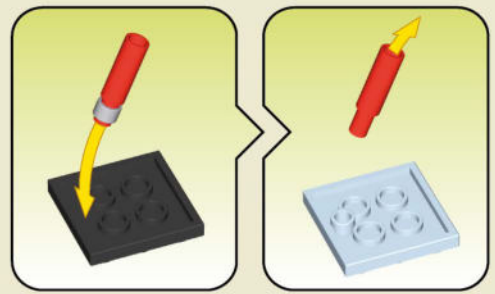

34

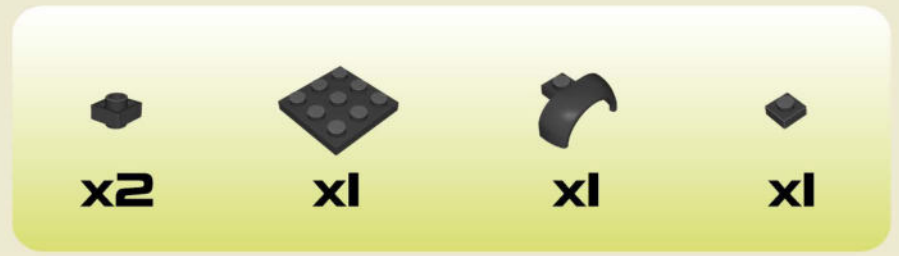
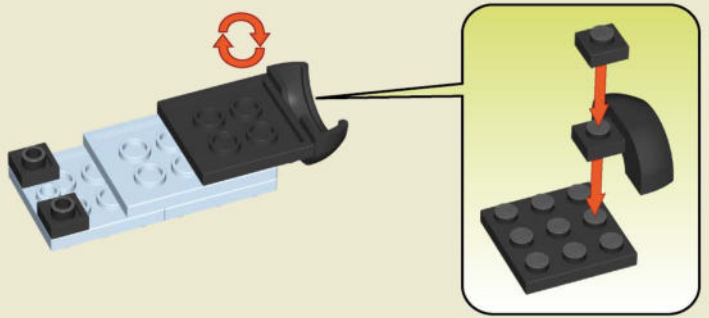

35

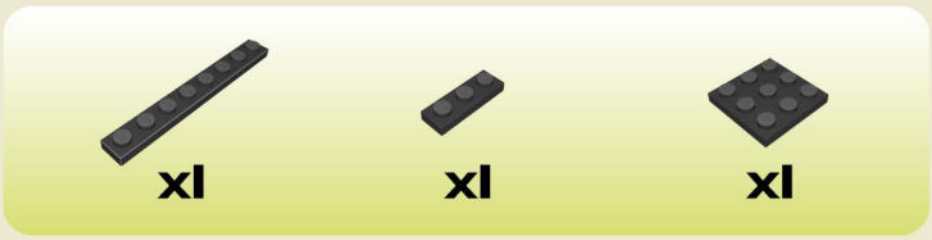
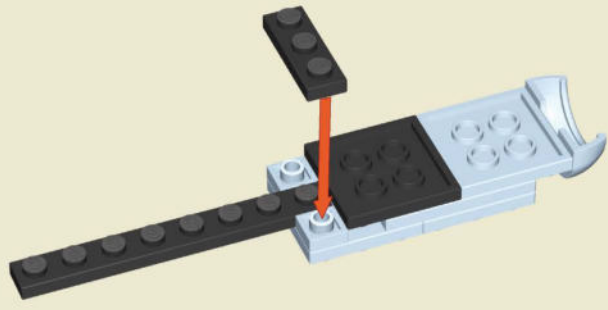

36

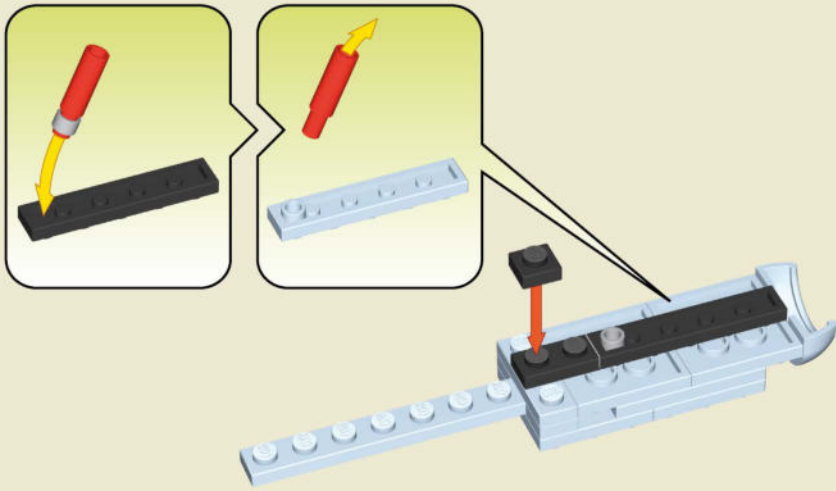

37

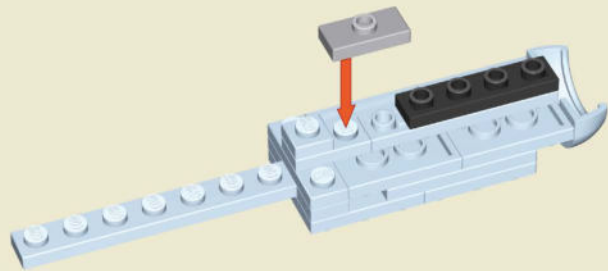

38

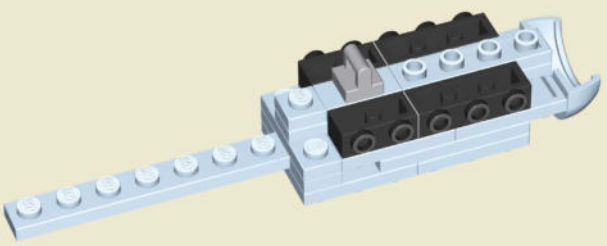

39

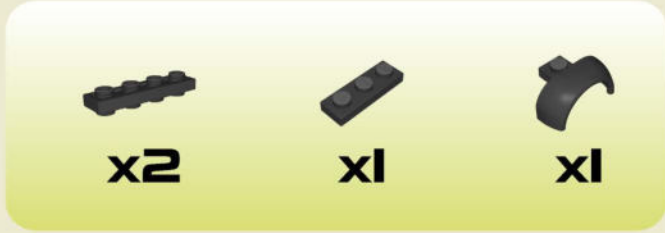
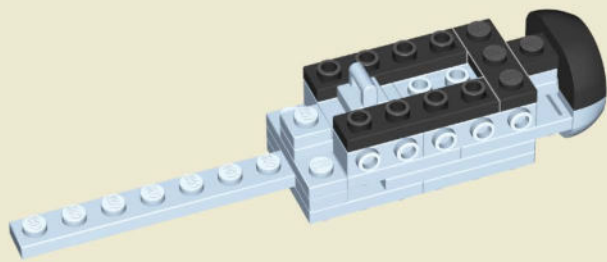

40

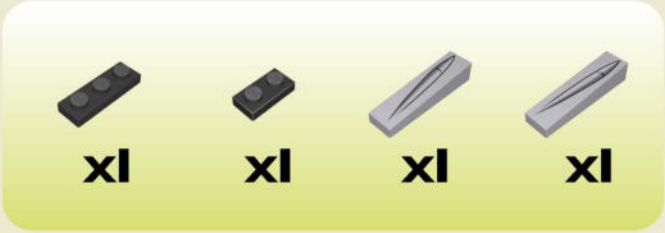
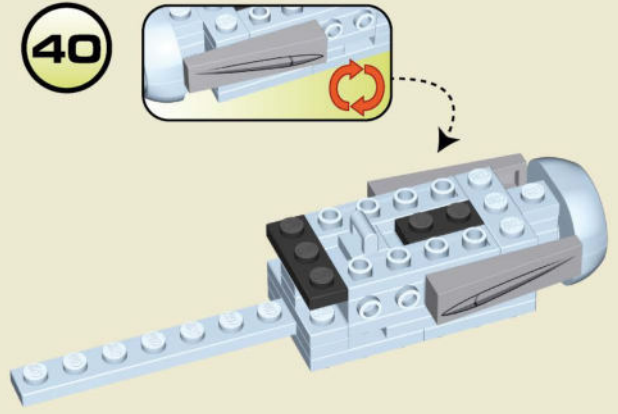

41

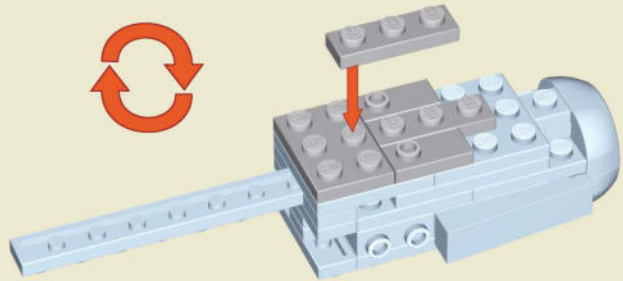

x1



x2



x2

42

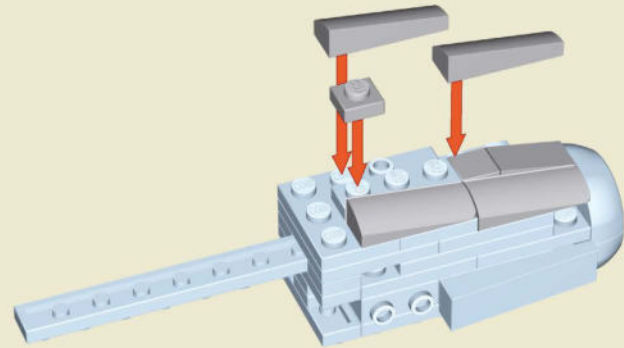

x2



x2



x1



x1



x1

43

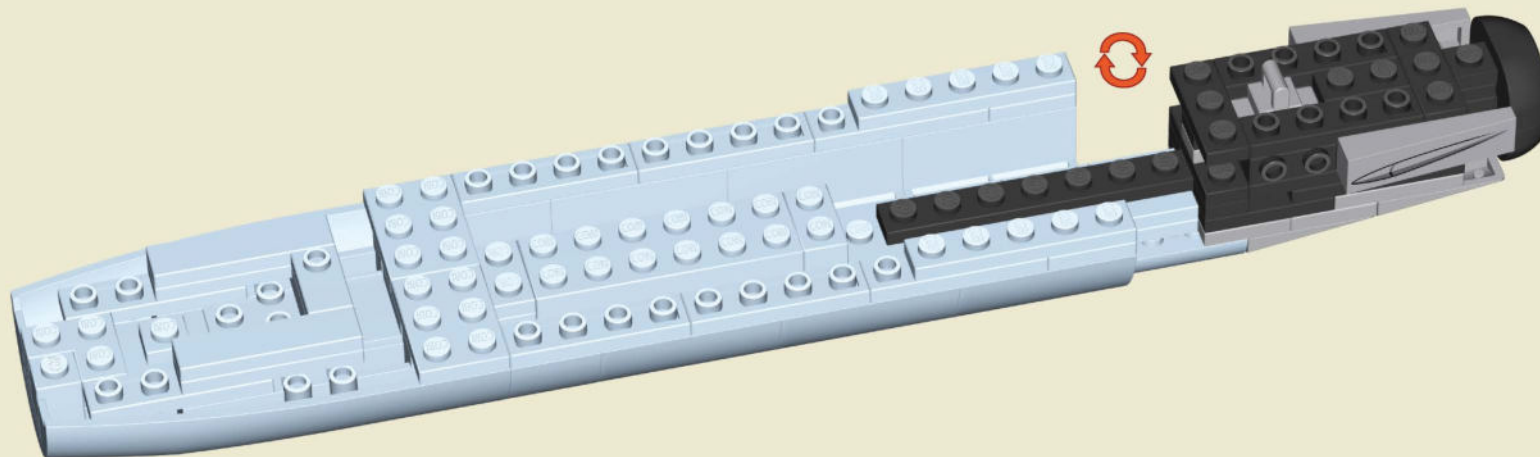

44

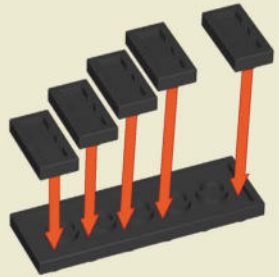

x1



x5

45

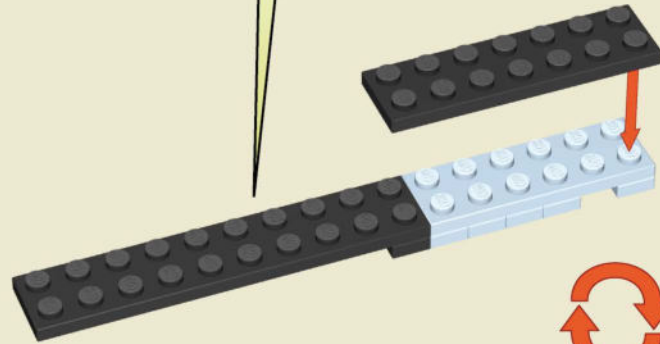
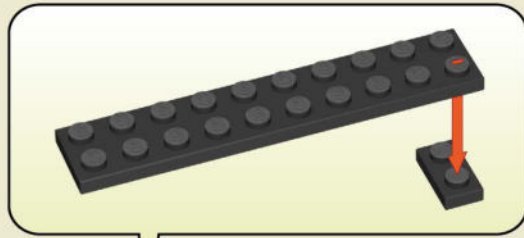

x1



x1



x1

46

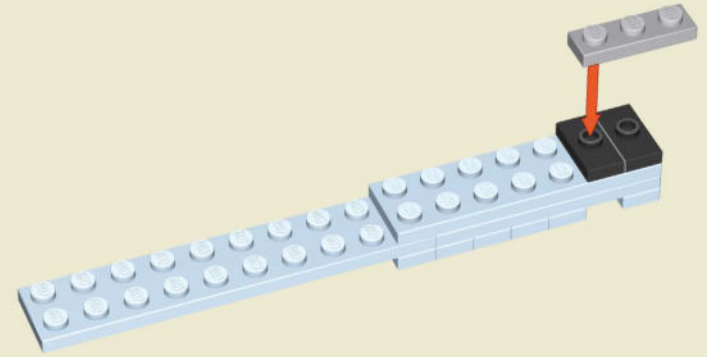

x2



x1

47

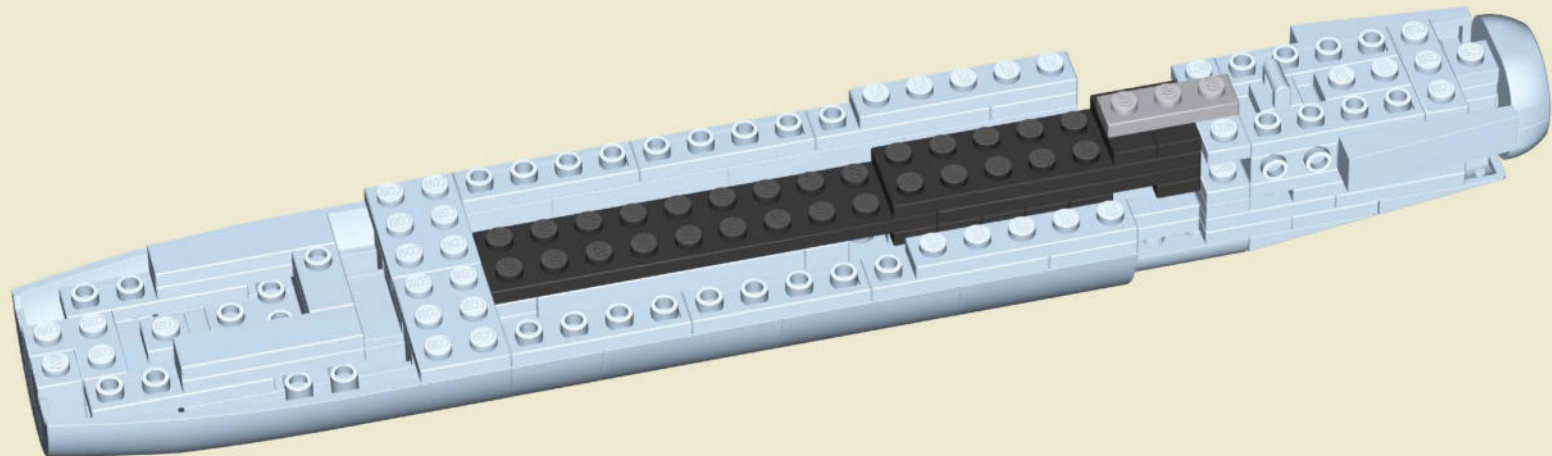



48

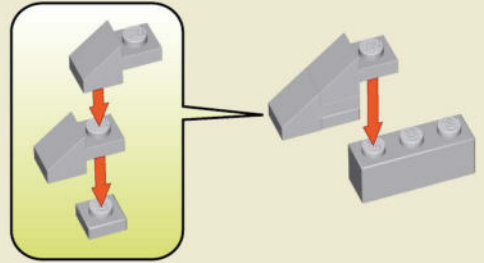

- x1
- x2
- x1

49

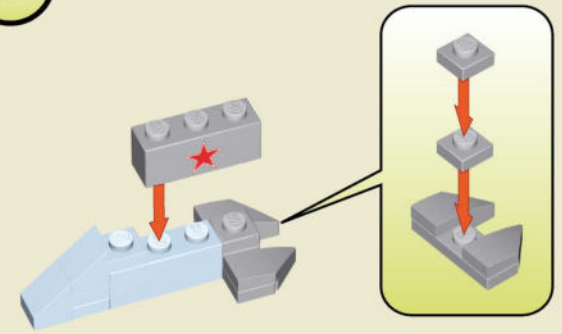

- x1
- x1
- x1
- x2
- x1

50

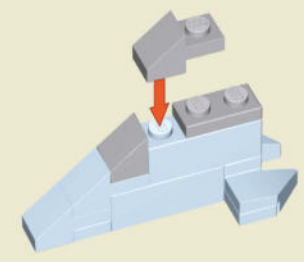

- x1
- x1
- x1

51

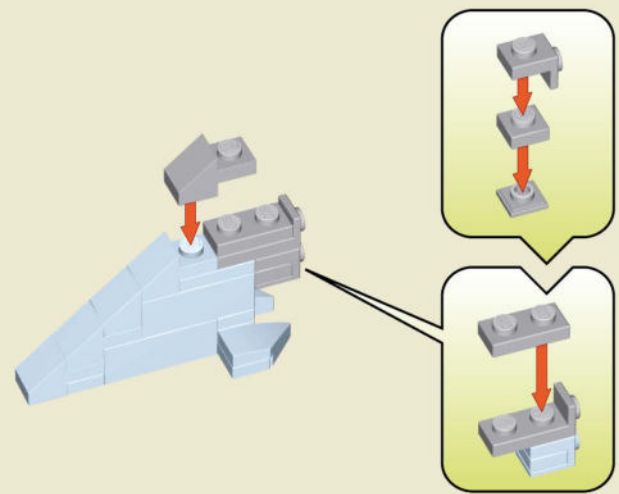

- x1
- x1
- x1
- x1
- x1
- x1

52

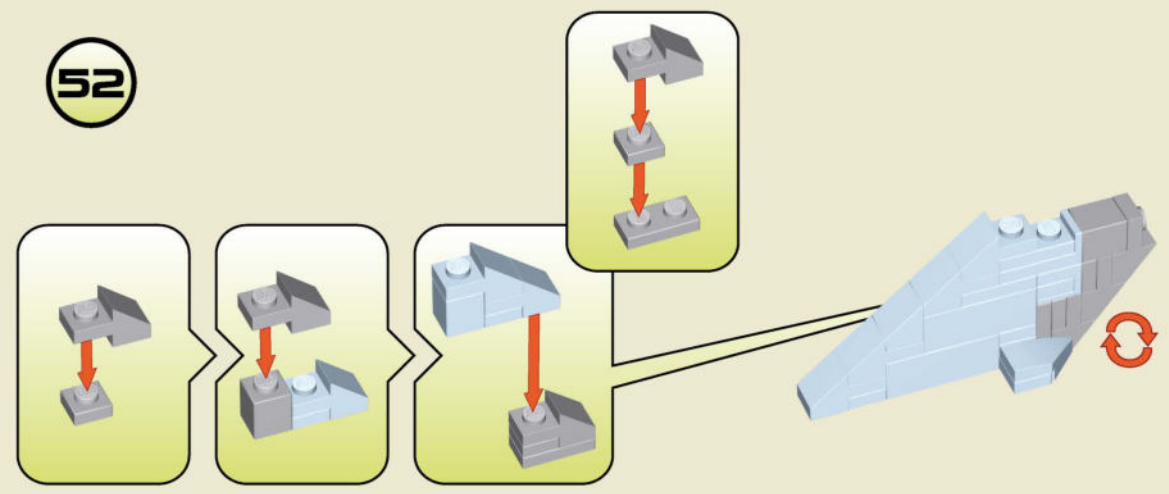

- x2
- x3
- x1
- x1

53

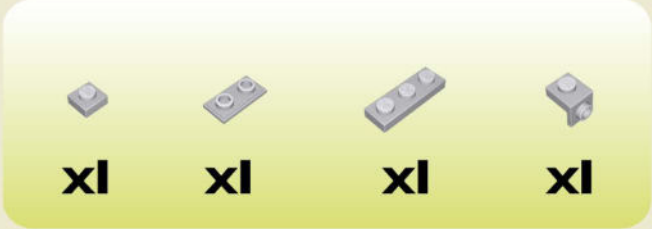
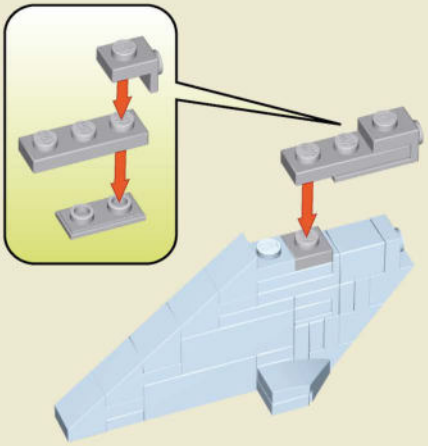

54

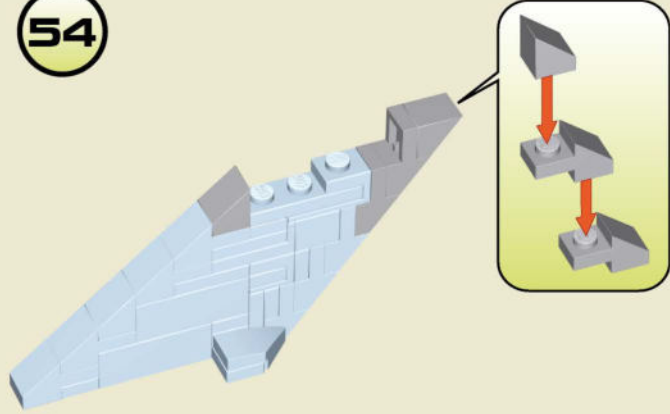

55

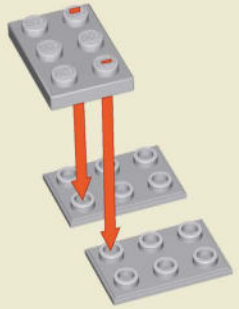

56

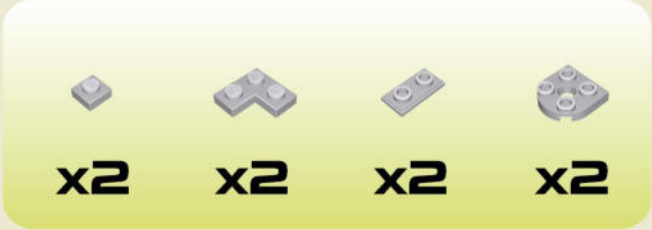
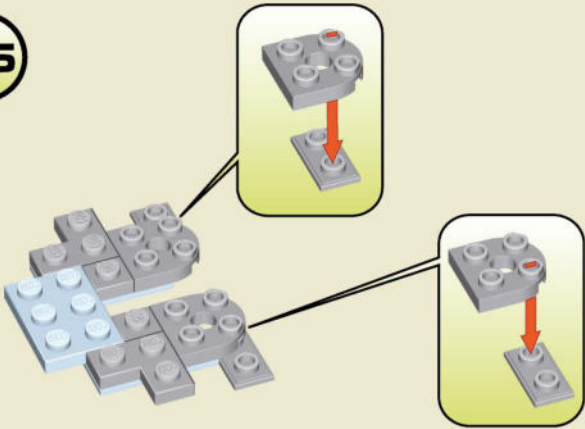

57

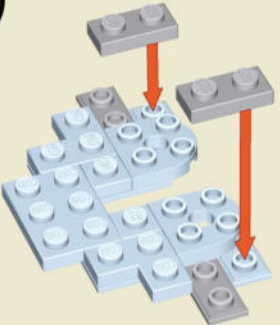

58

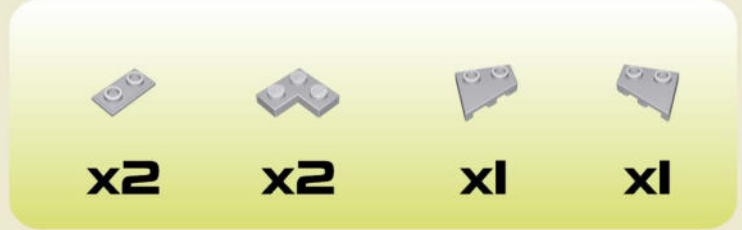
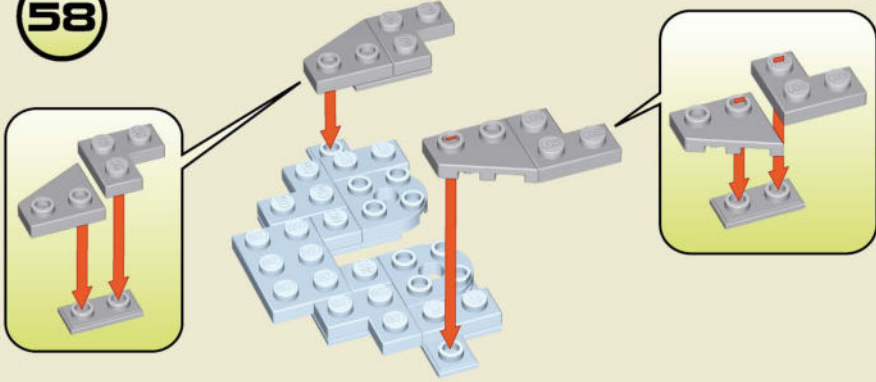

59

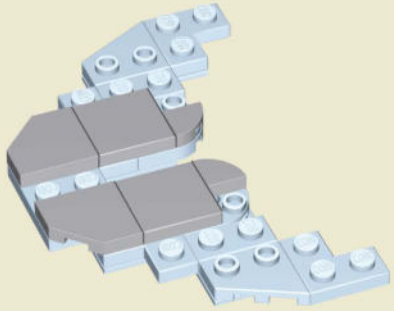

60

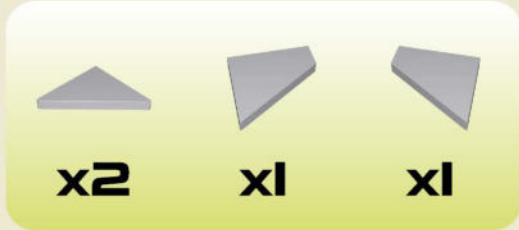
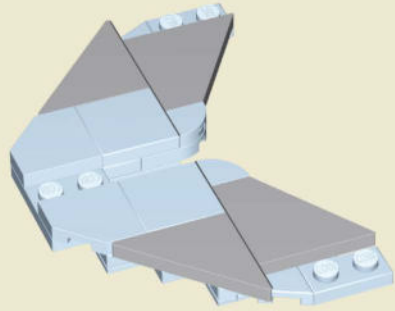

61

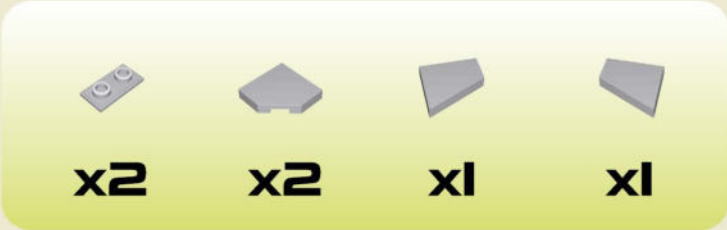
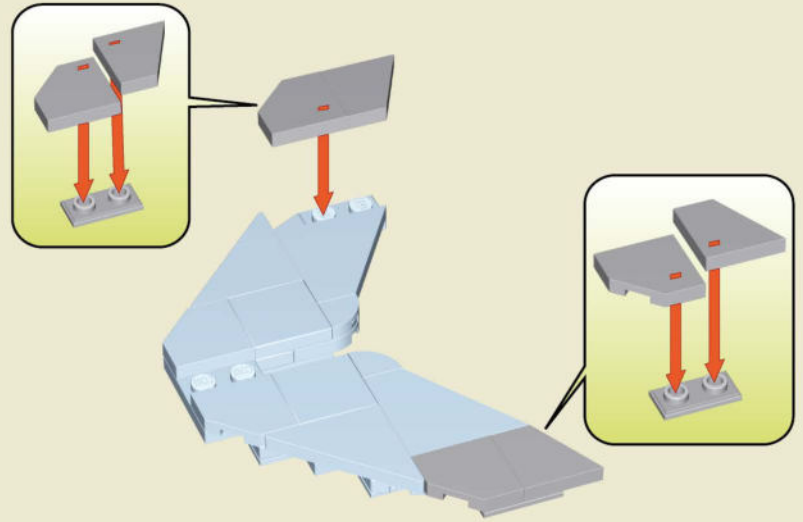

62

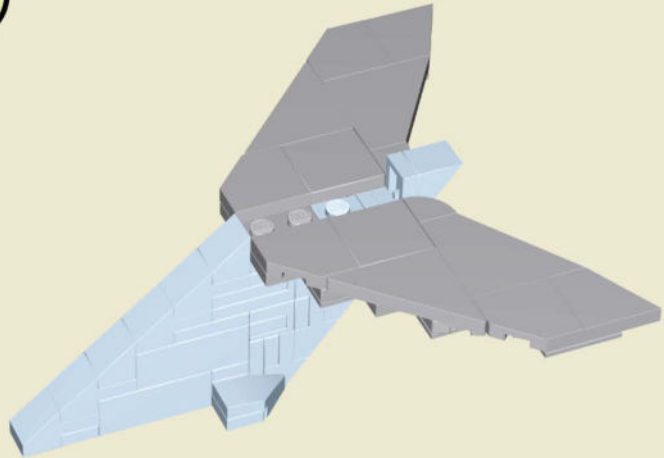

63



64

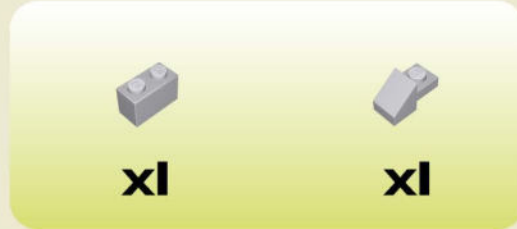
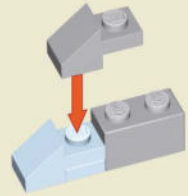

65

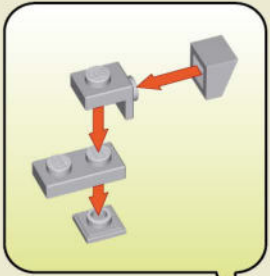



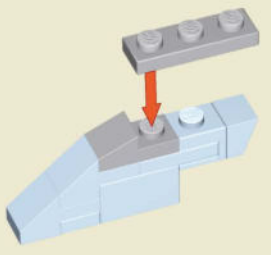

66

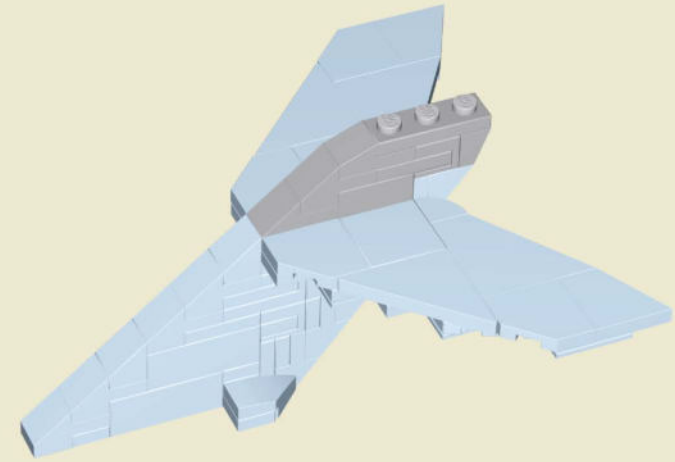



67











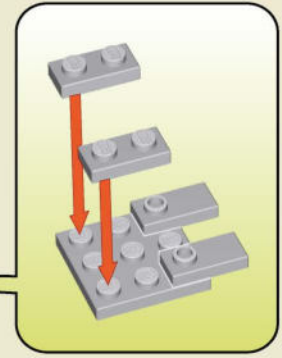
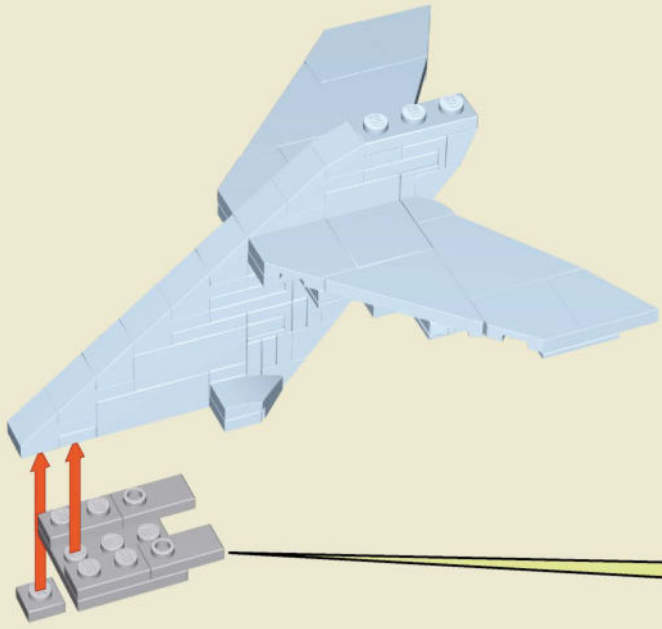

x1 **x1** **x1** **x1**

x1 **x1**

68



x1 **x1** **x2** **x2**

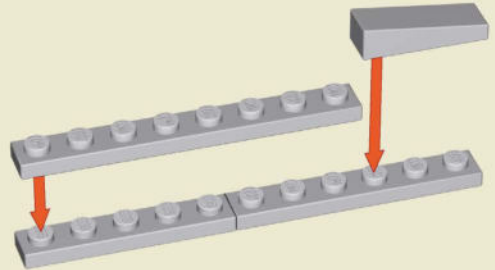
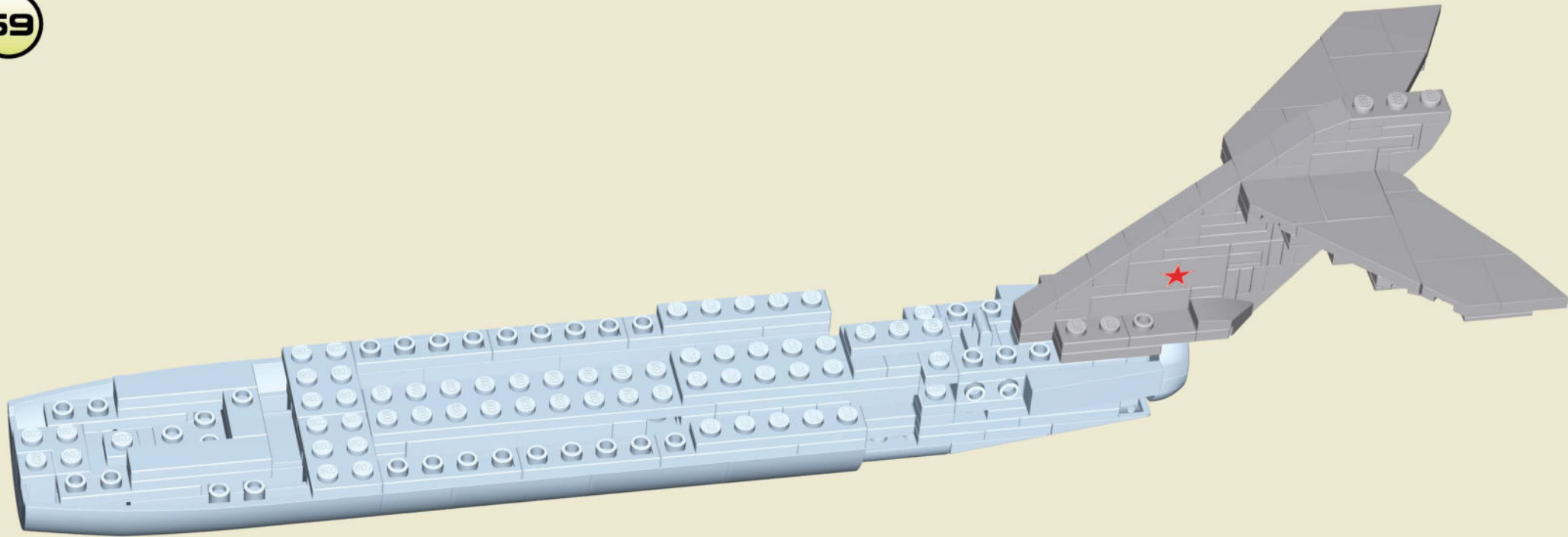

- 1x6 Technic Technonut x1
- 1x6 Technic Technonut x1
- 1x6 Technic Technonut x1
- 1x6 Technic Technonut x1

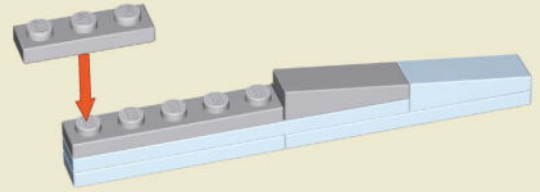

- 1x6 Technic Technonut x1
- 1x6 Technic Technonut x1
- 1x6 Technic Technonut x1

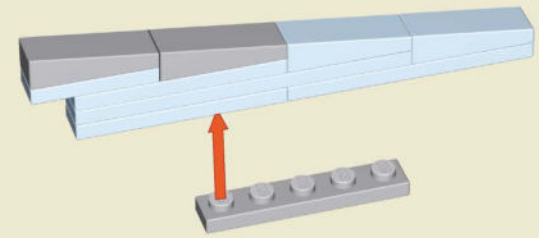

- 1x6 Technic Technonut x2
- 1x6 Technic Technonut x1

73

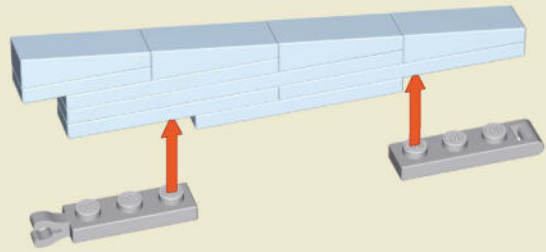

74

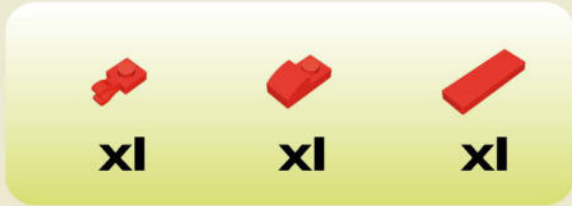
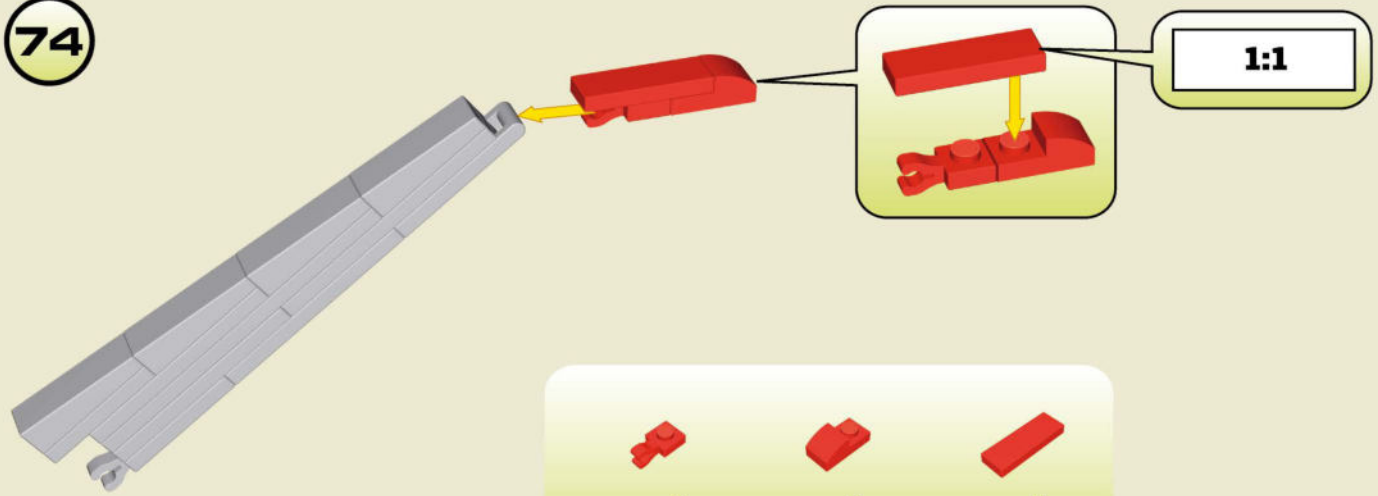

75

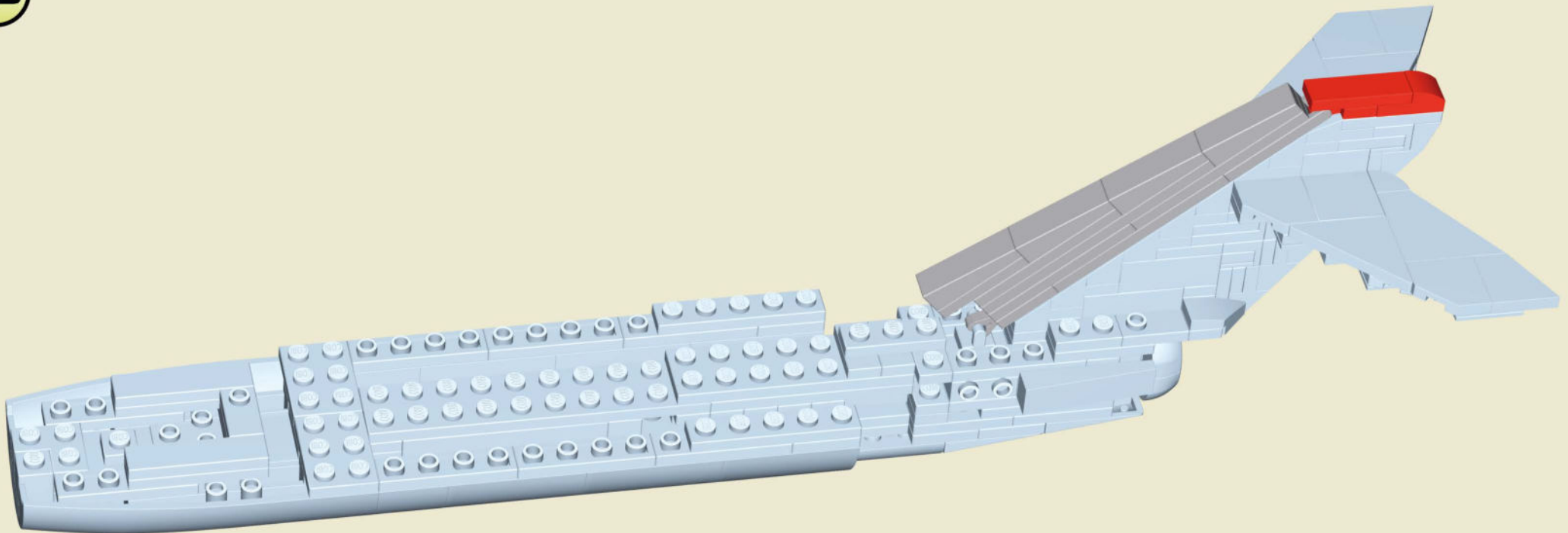

76

 **x1**  **x1**

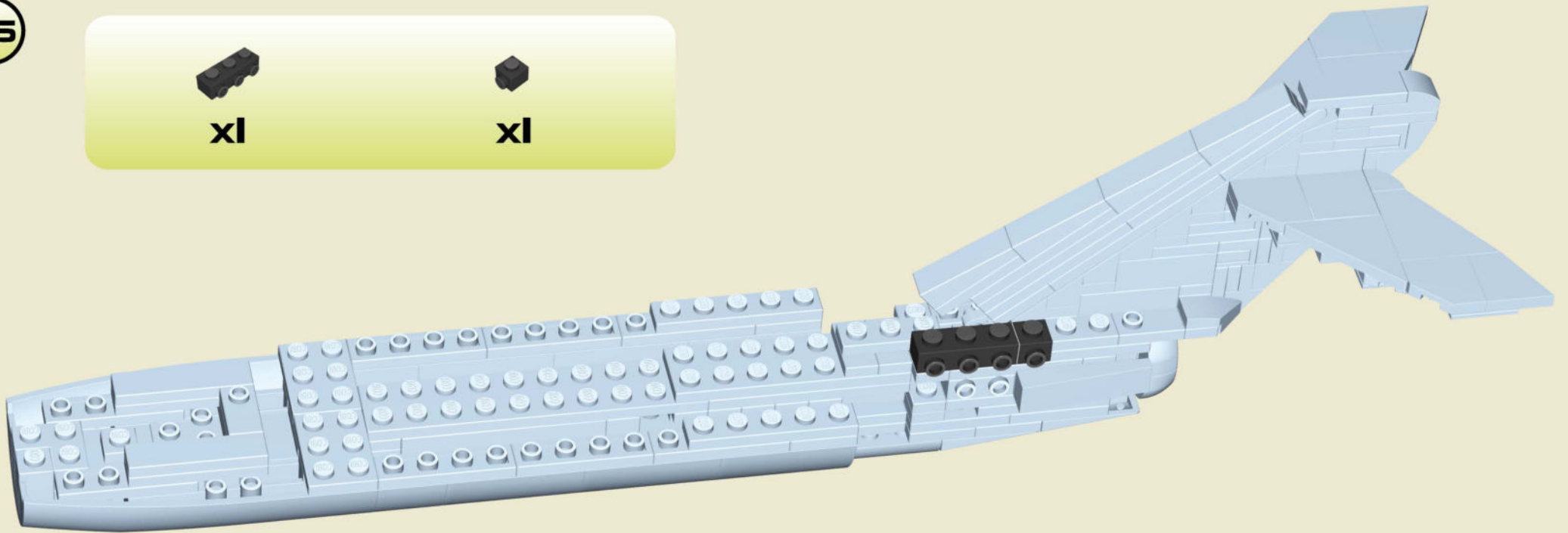

77

 **x1**  **x1**  **x1**

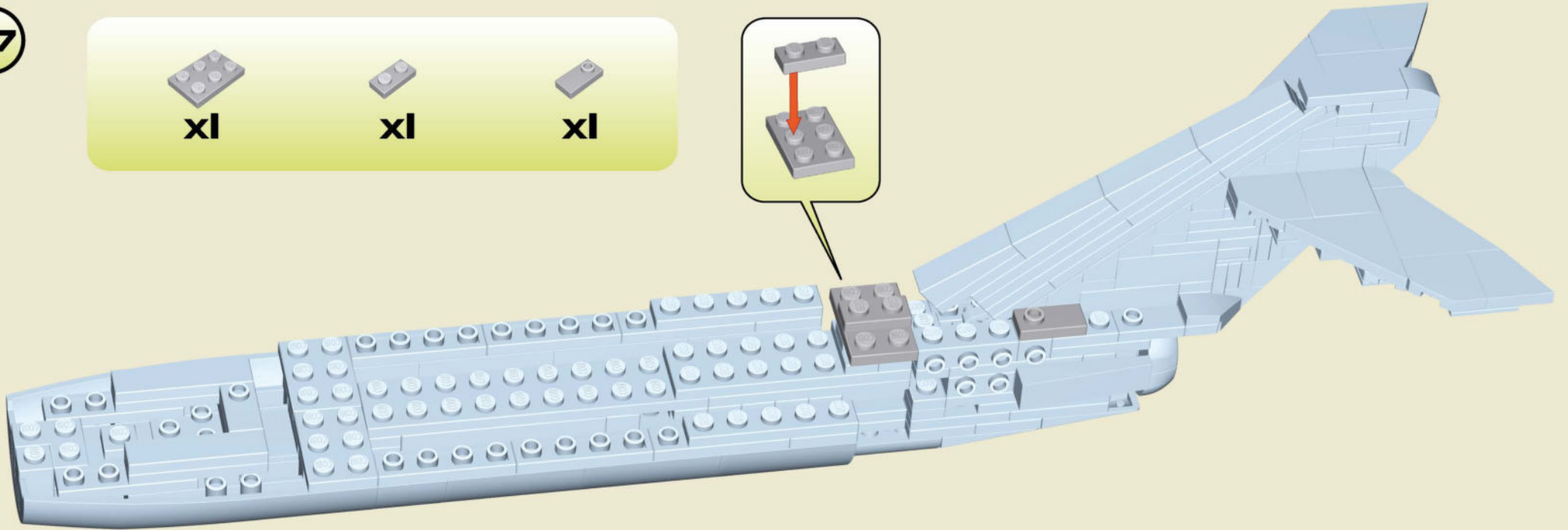
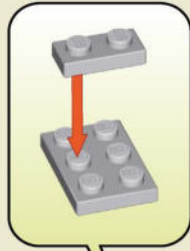

78

x1 x1 x1 x2

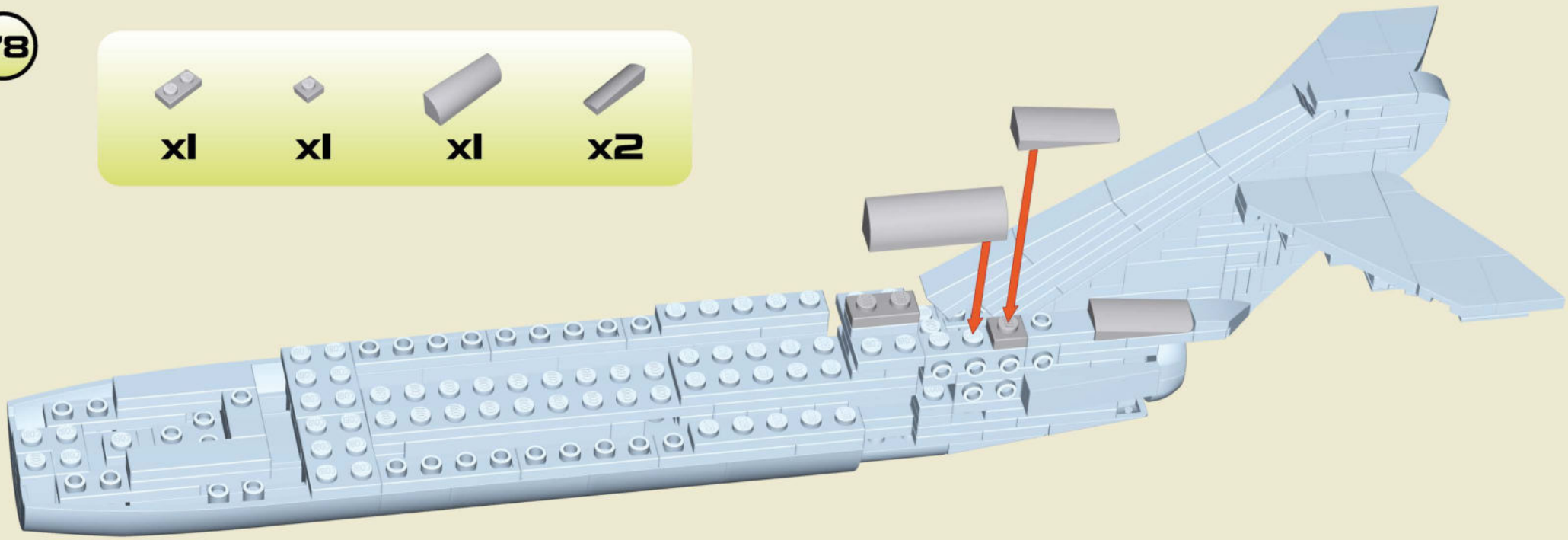

79

x1 x1 x1



1:1

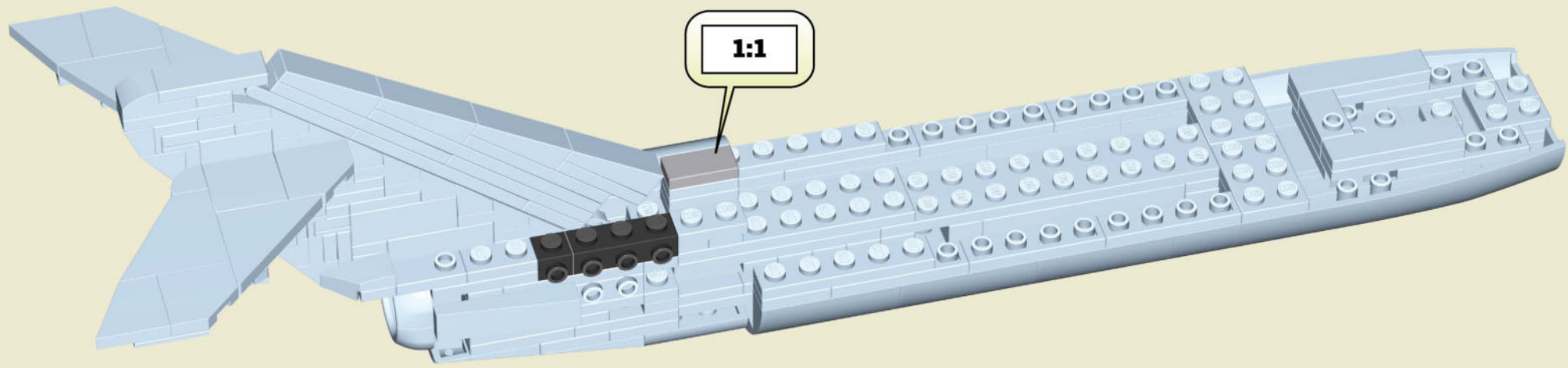

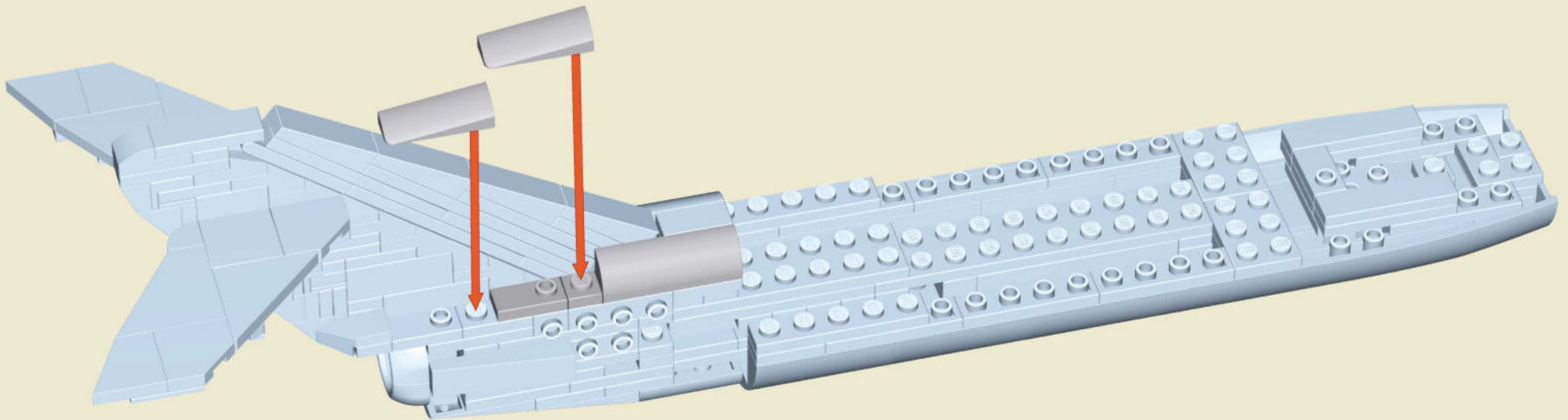

x1



x1

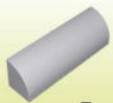

x1



x2

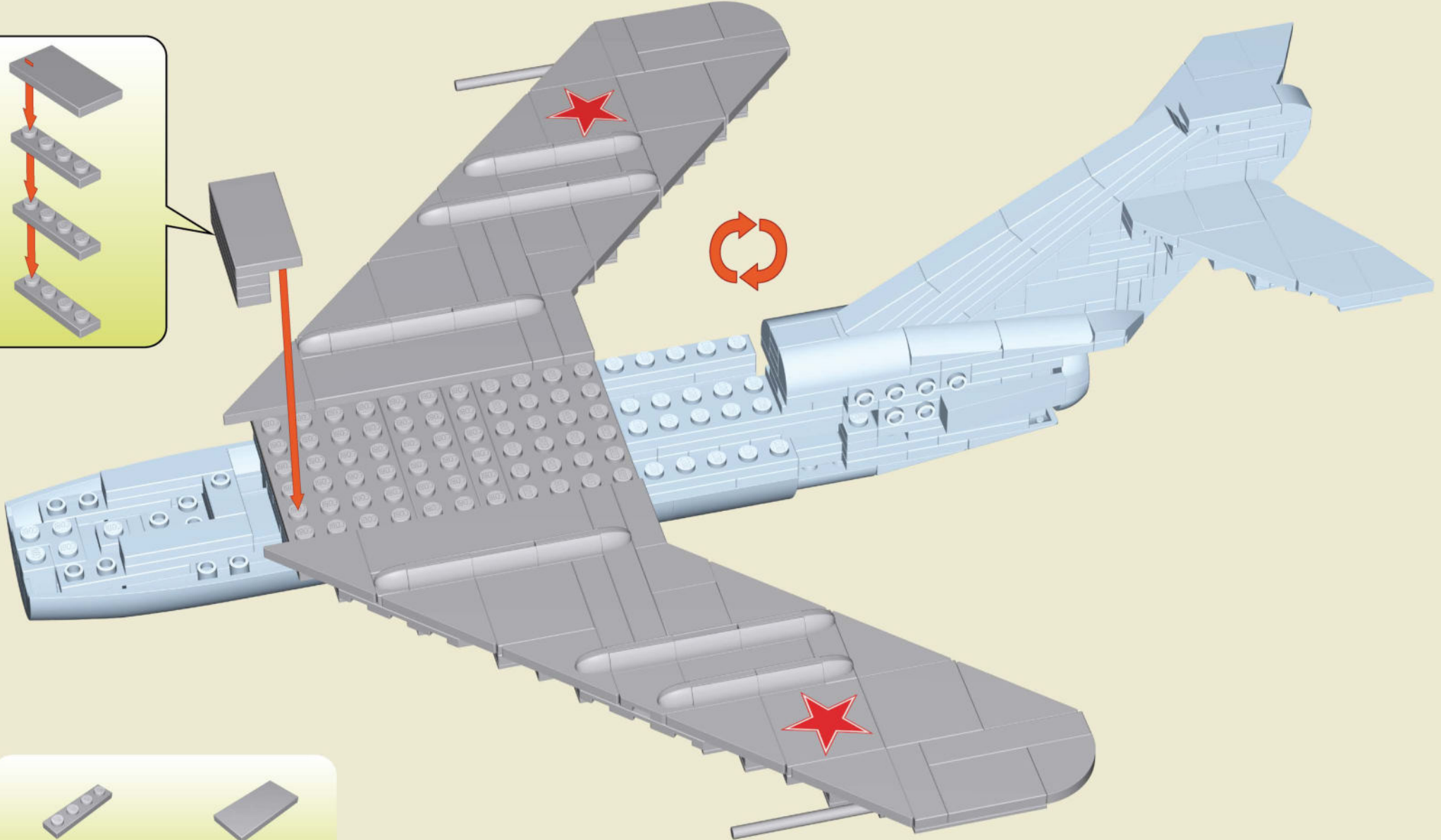
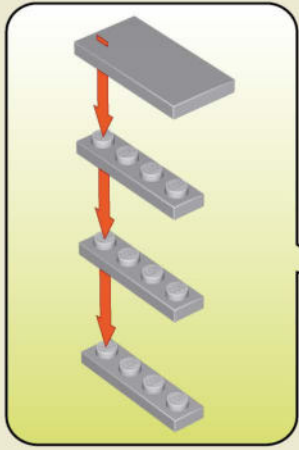

x3

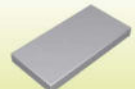

x1

82

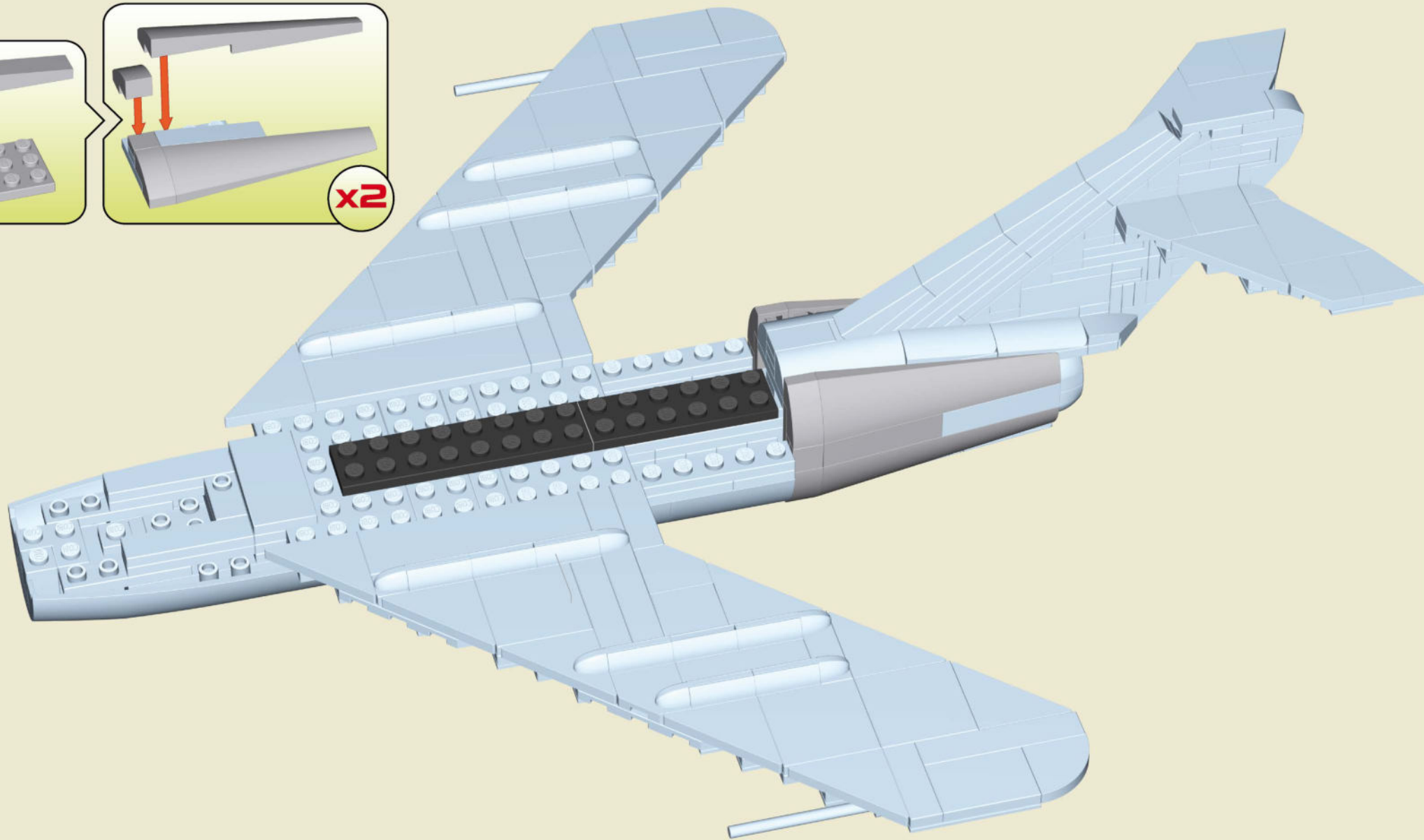
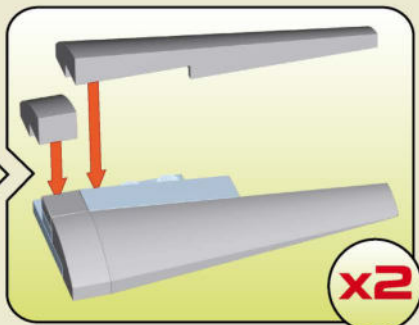
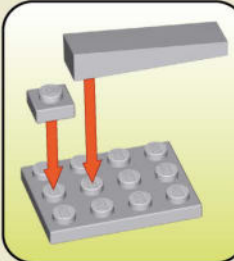

x1



x1



x2



x2

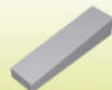

x2



x4



x2

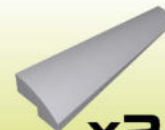



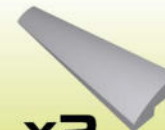

x2

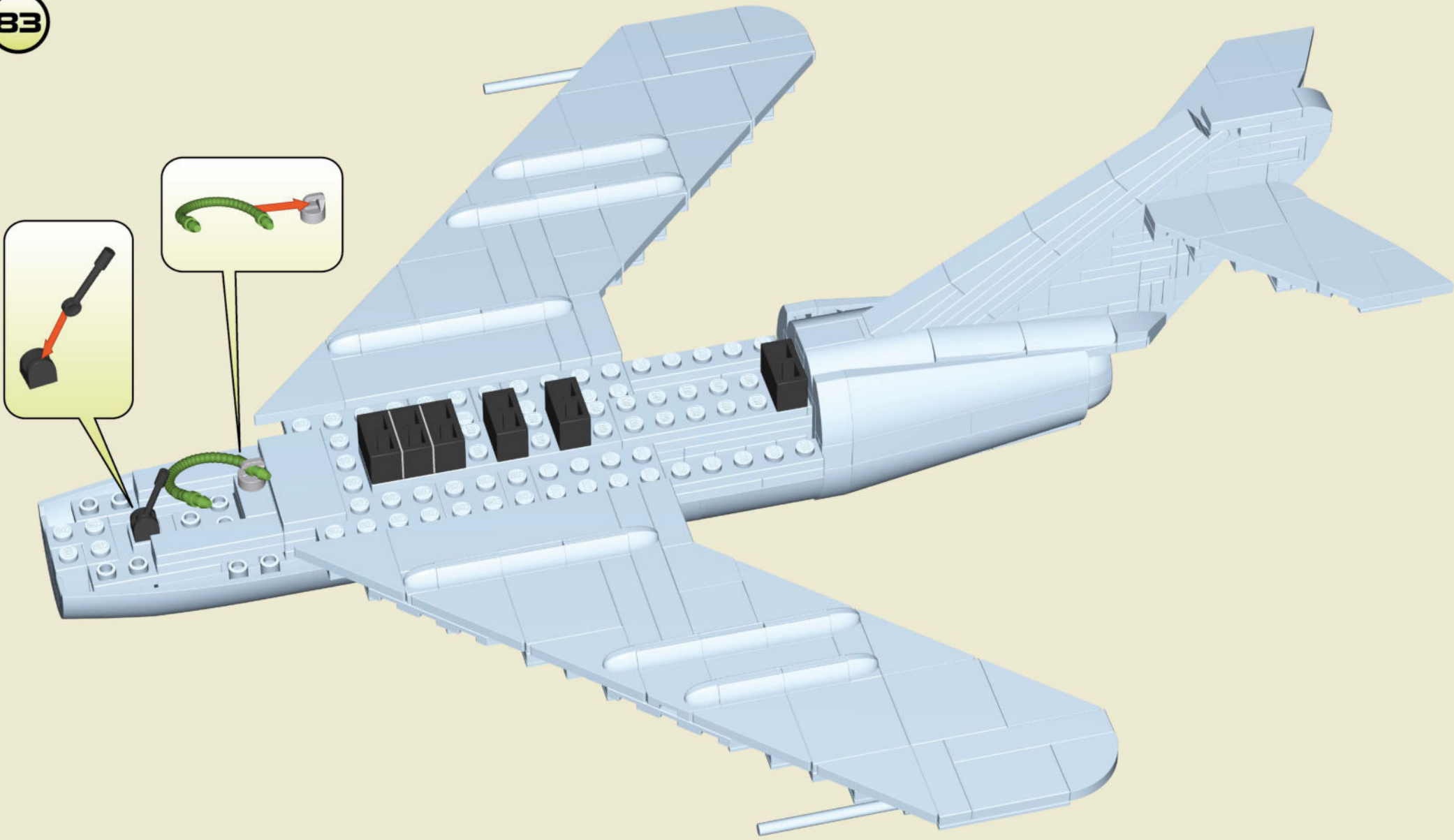

x2



-  **x1**
-  **x1**
-  **x1**
-  **x1**
-  **x6**



-  x1
-  x1
-  x2
-  x1

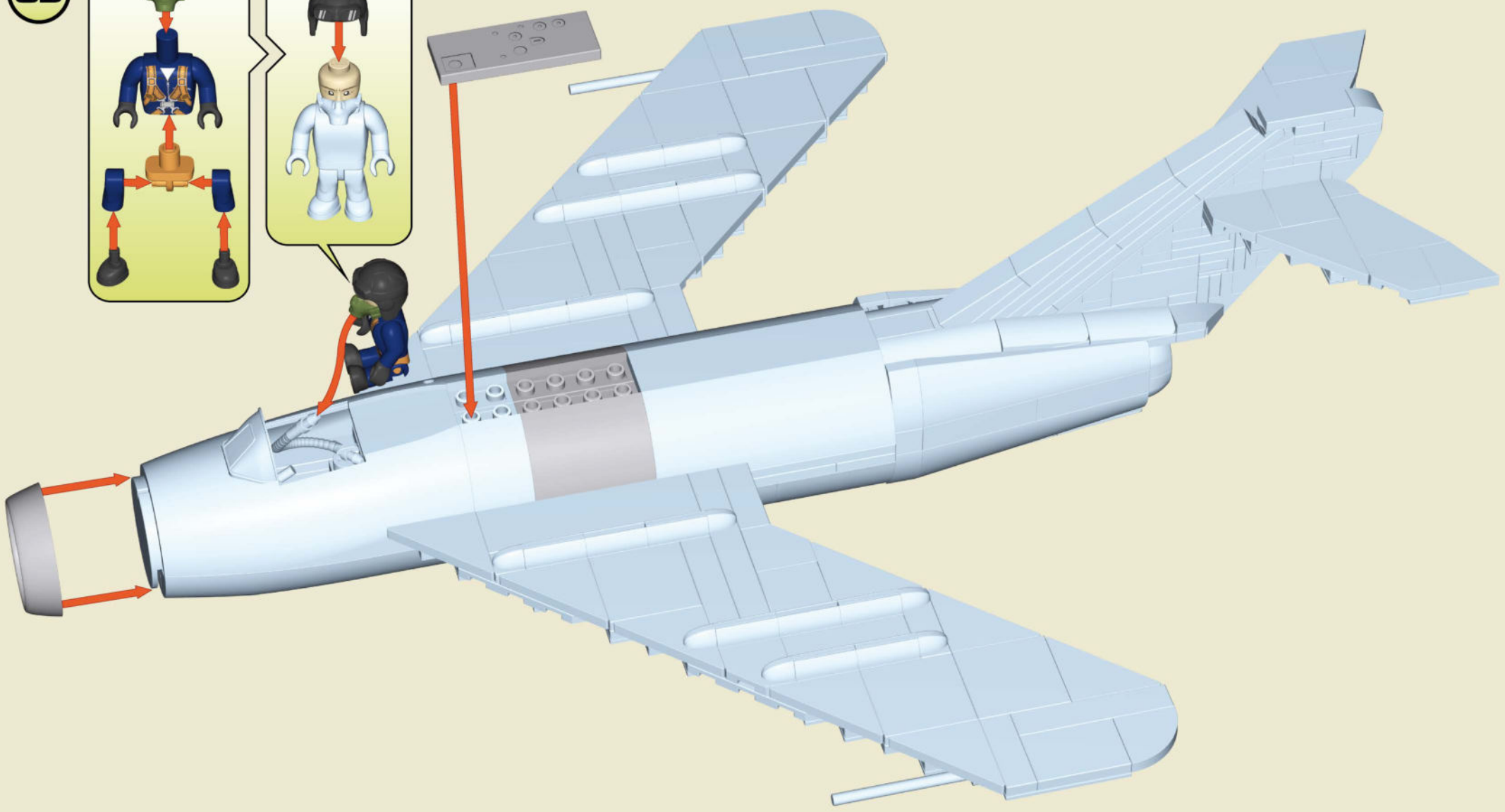
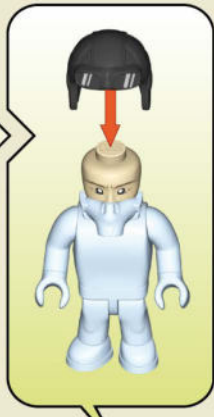
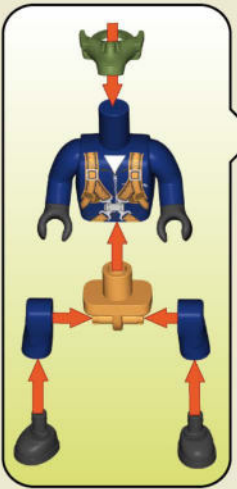

x1

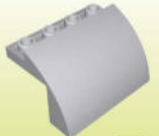

x2



x1



x1



x1



x1



x1



x2



x1



x1



x1

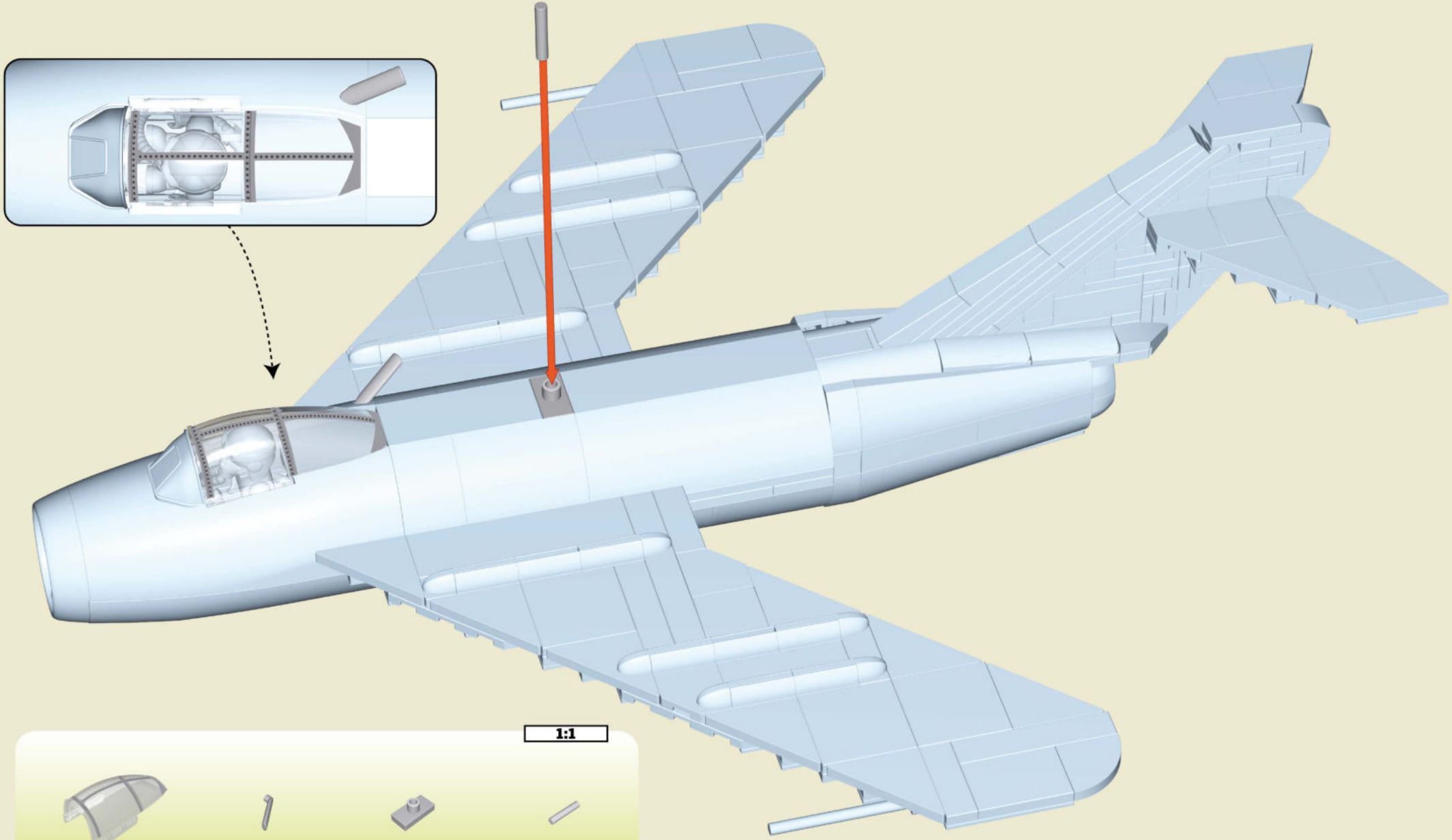

1:1



x1



x1



x1



x1

87

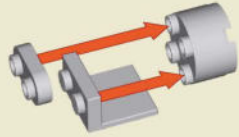

87 □ 90 x2

88



x1



x1



x1



x2

89

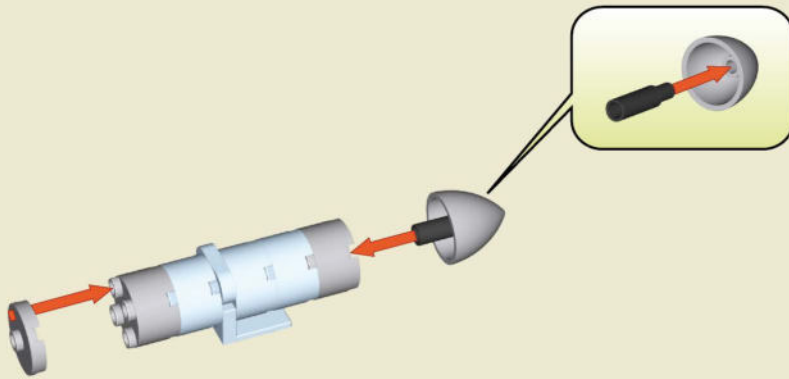

x2



x1



x1



x1

90

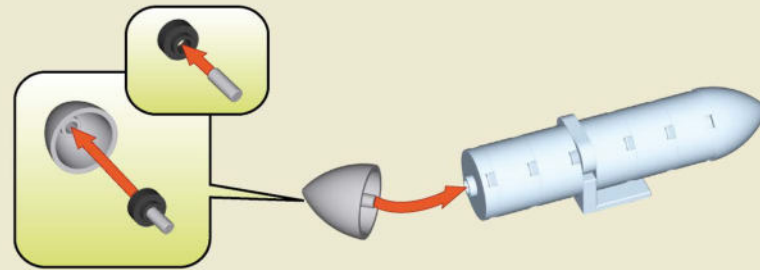

1:1



x1



x1



x1

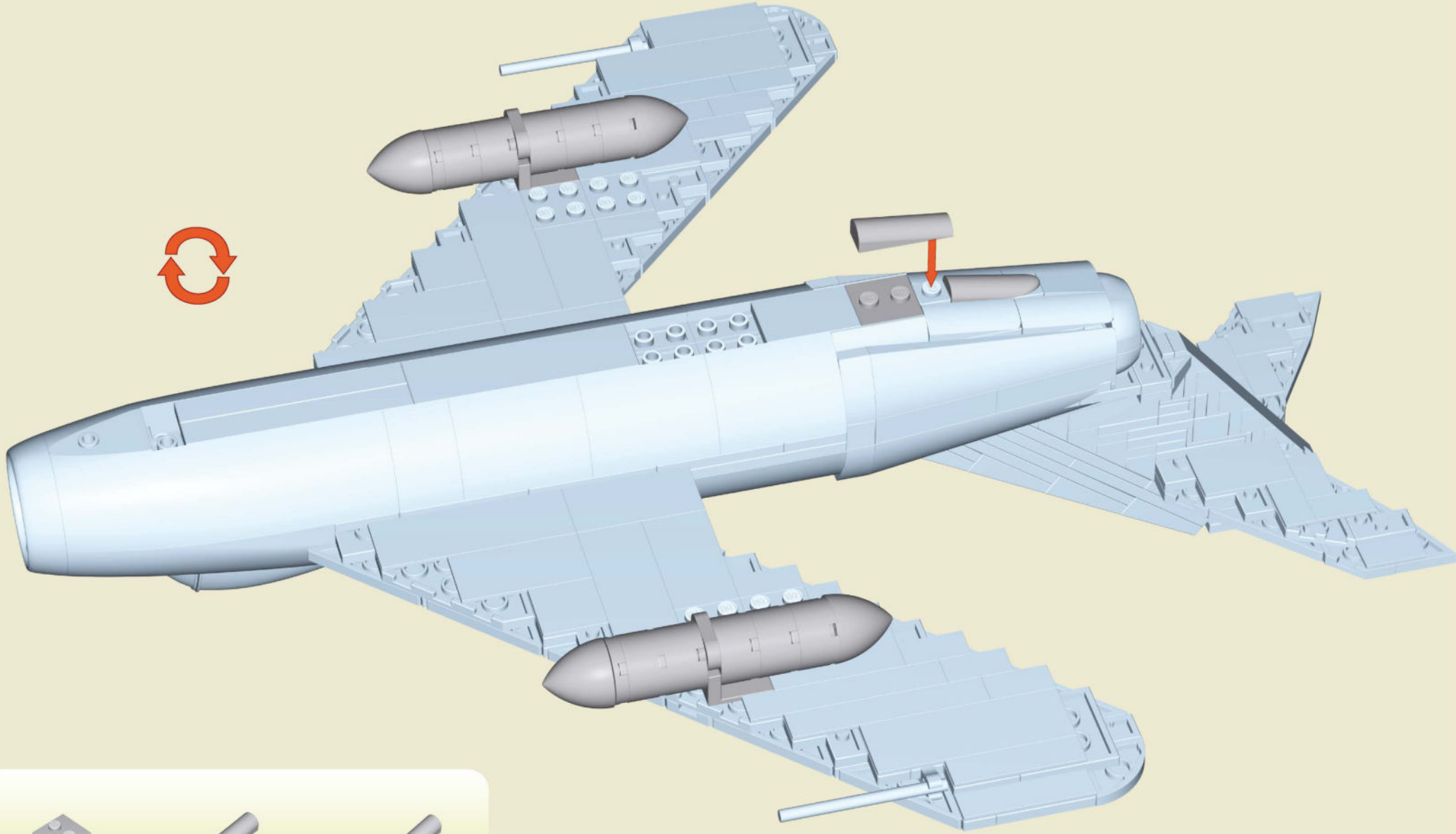

x1







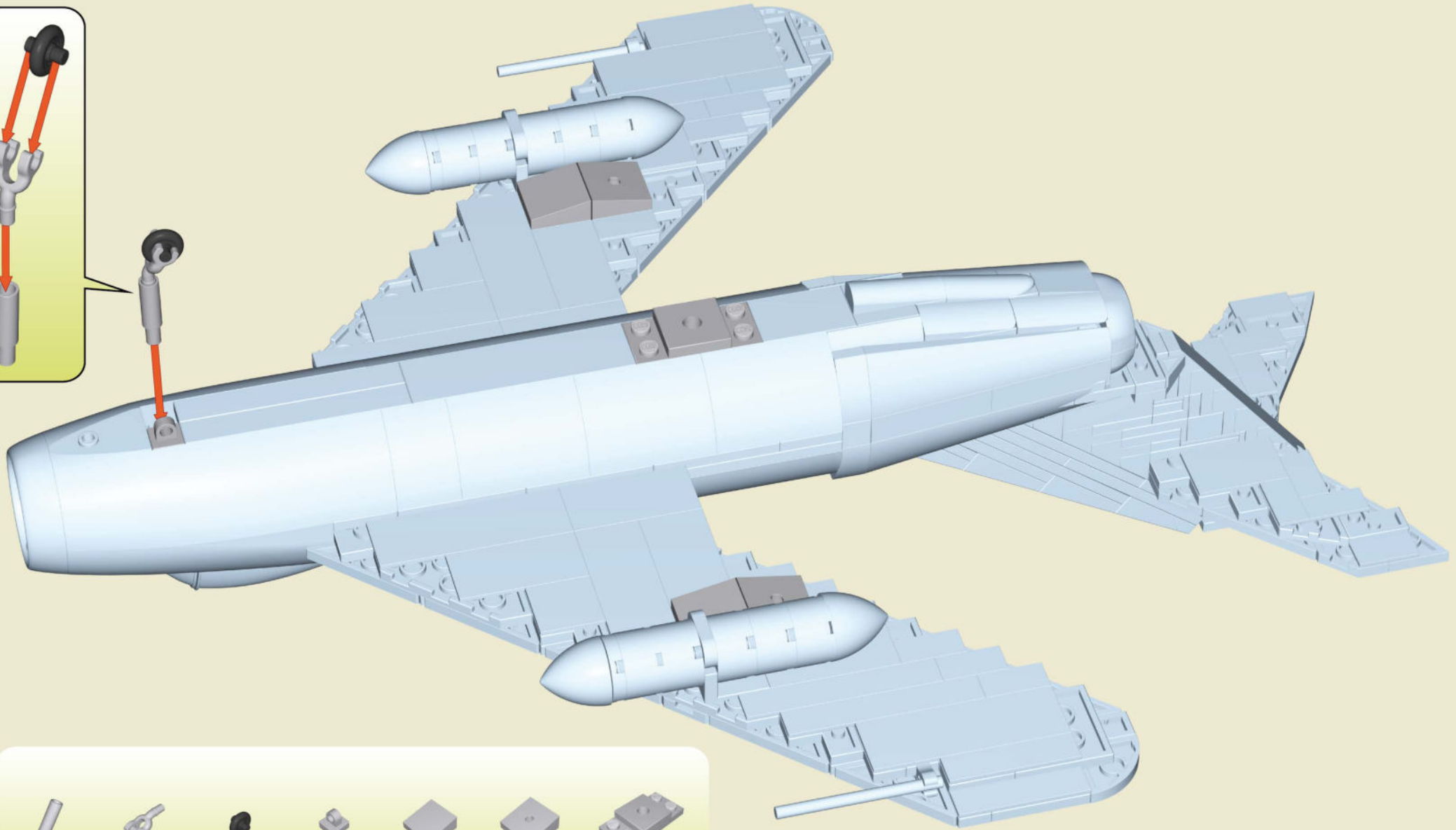
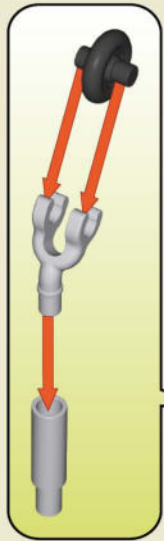

x1









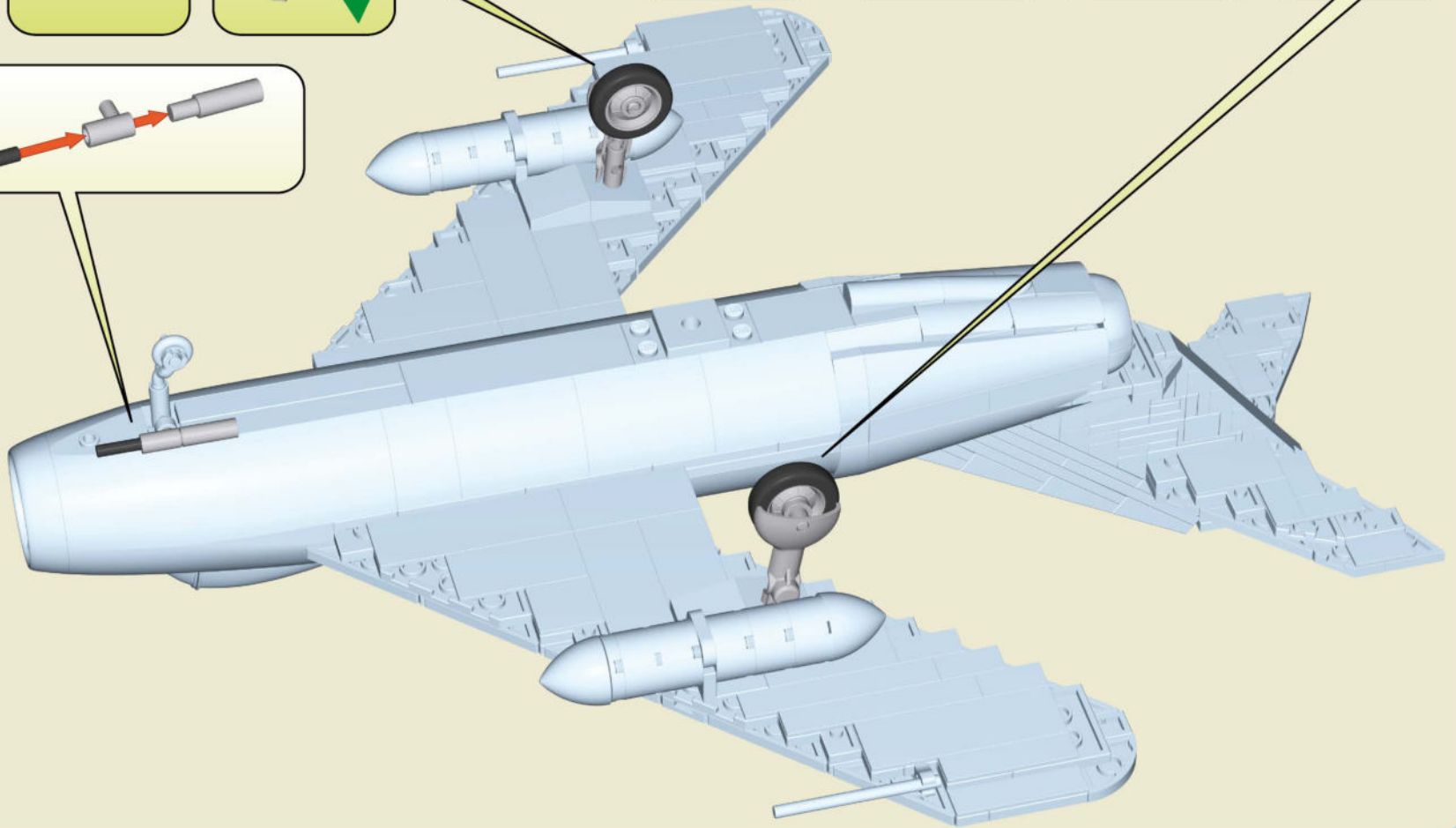
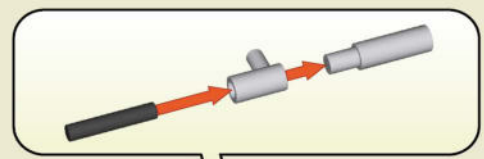
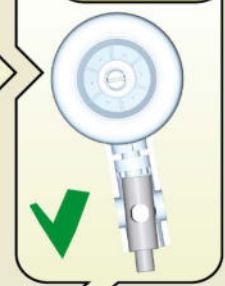
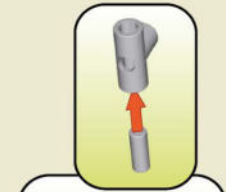
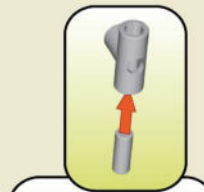
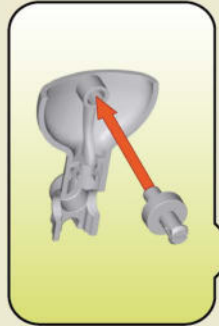

x1





-  x1
-  x1
-  x1
-  x1
-  x2
-  x2
-  x1

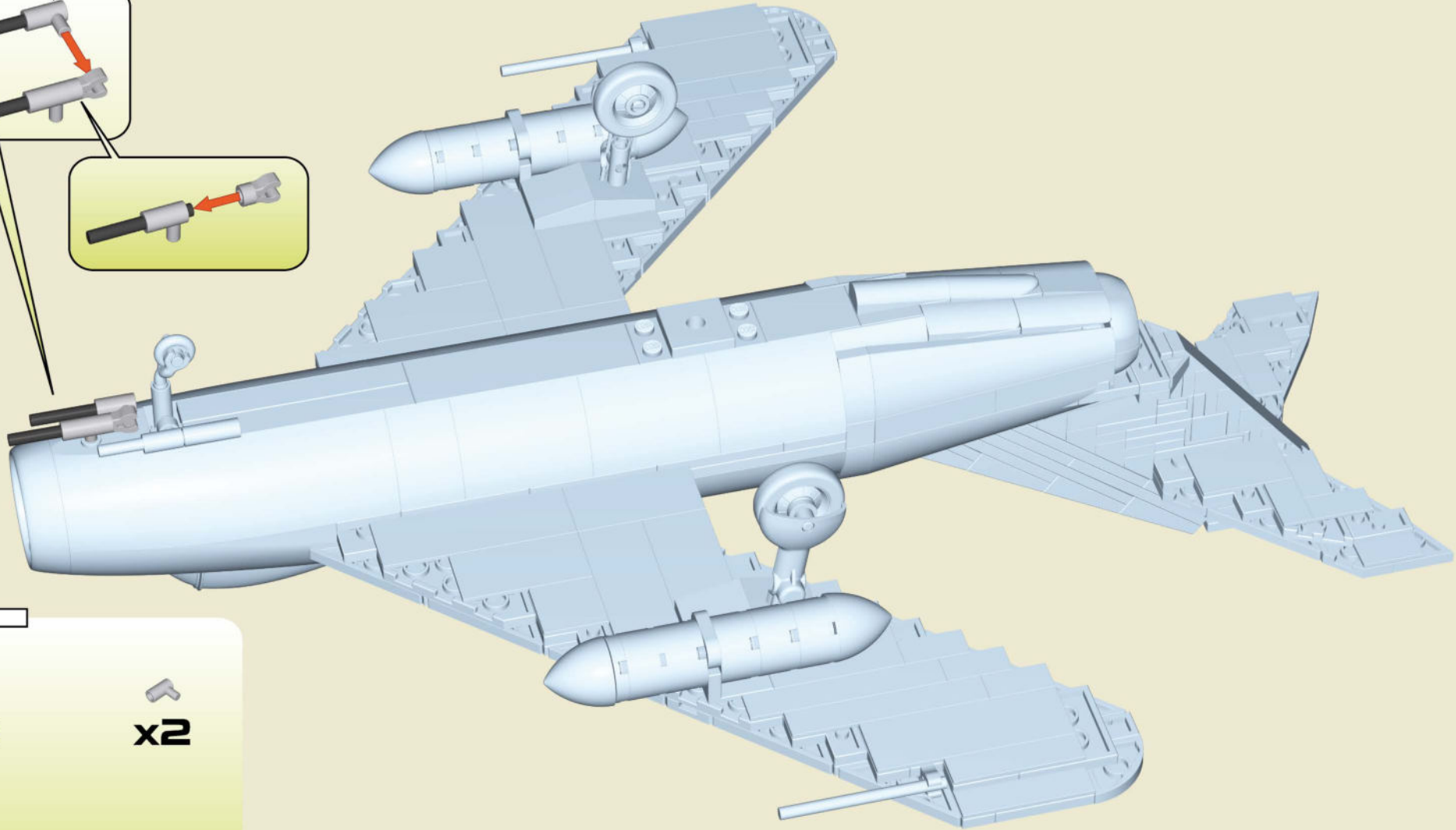
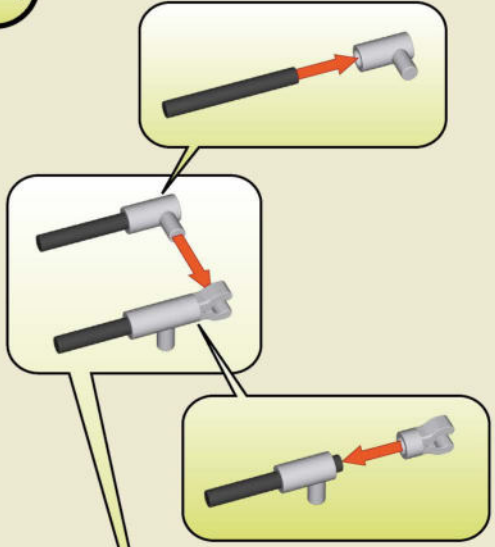

-  x2
-  x2
-  x2
-  x2
-  x2
-  x2
-  x1
-  x1
-  x1



1:1

 x2	 x2
 x1	

95

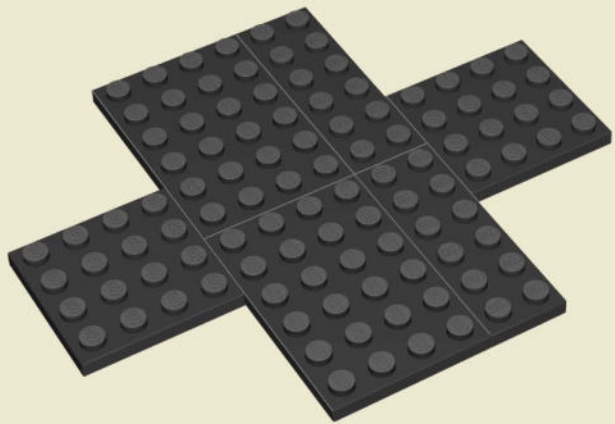

x2



x2

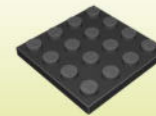

x2

96

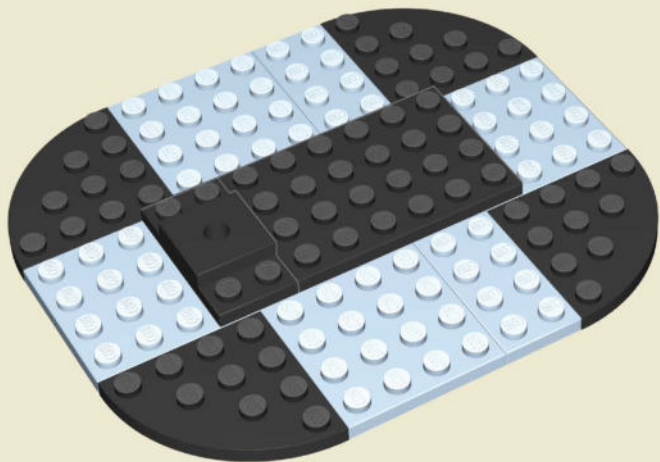

x1



x1



x4

97

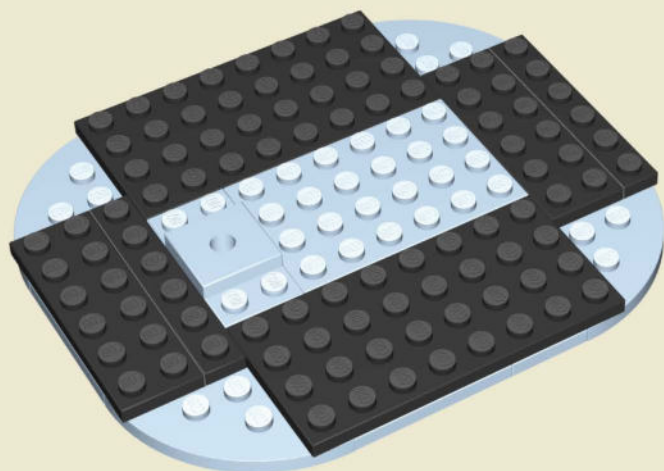

x2



x2



x2

98

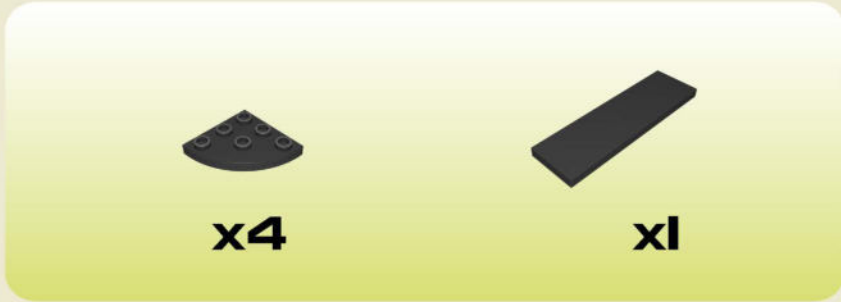
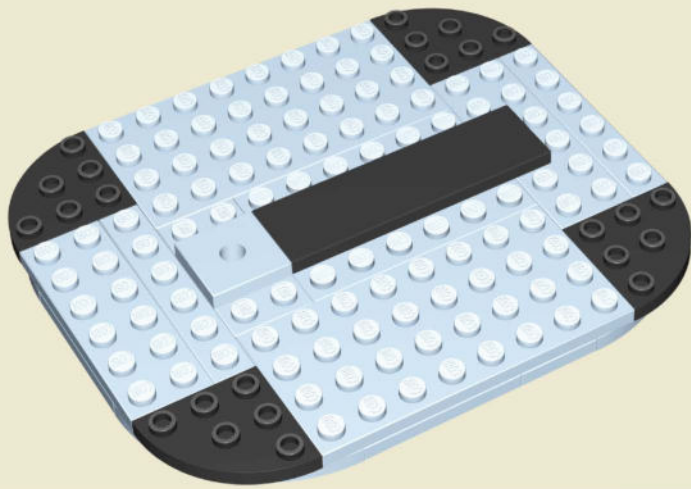

x4



x1

99

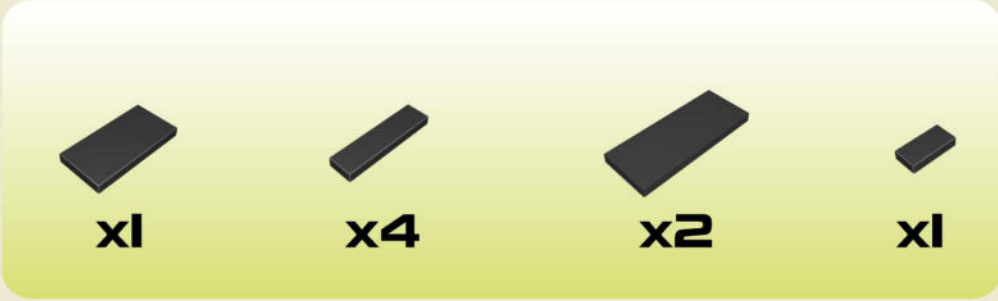
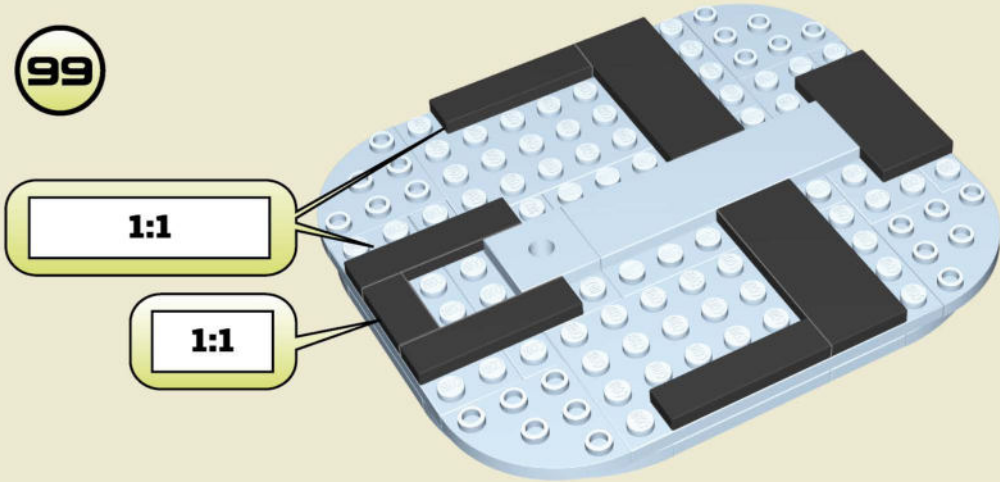

x1



x4



x2



x1

100

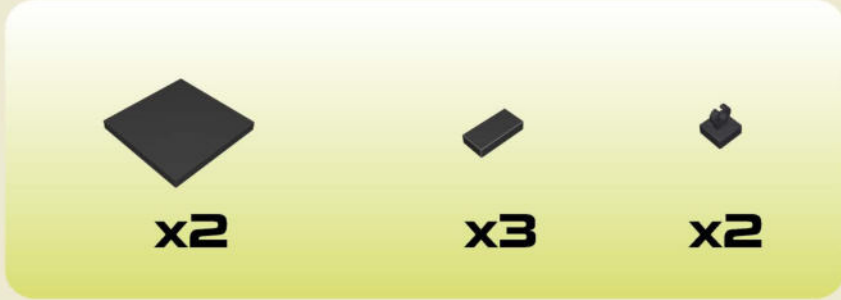
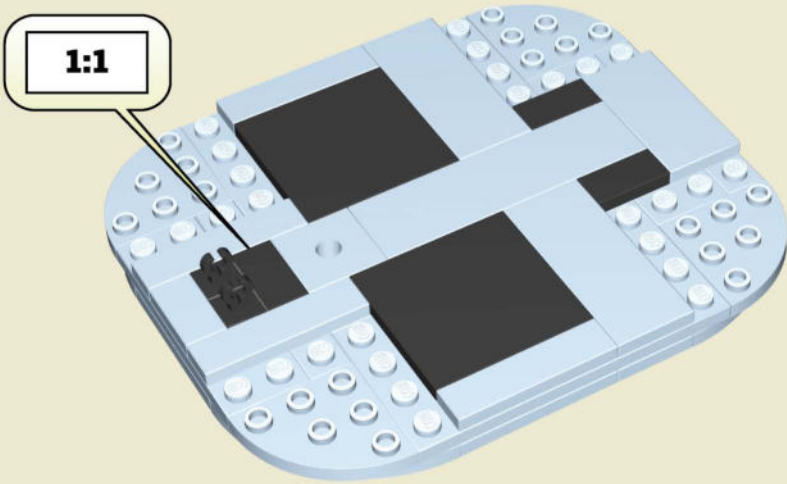

x2



x3



x2



x4



x1



x1



x1

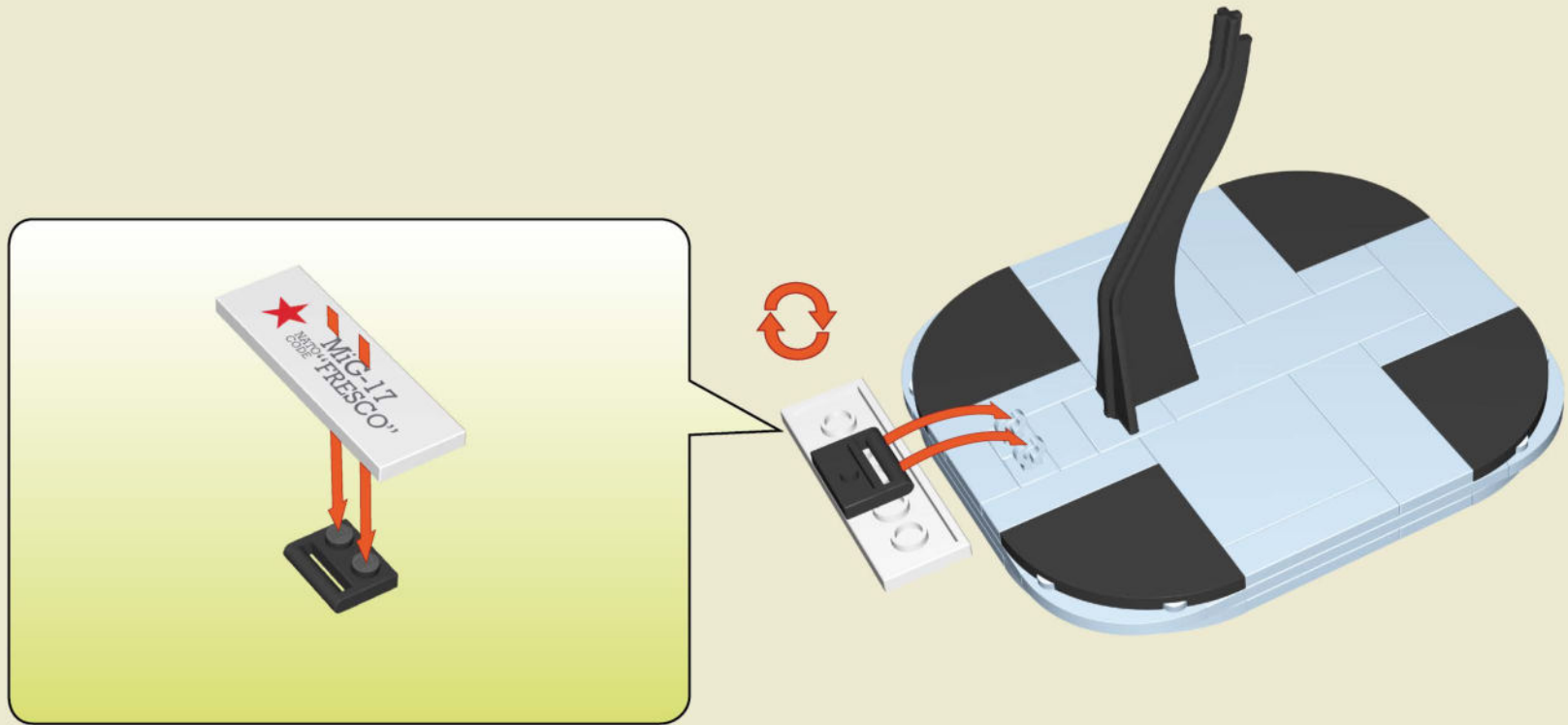

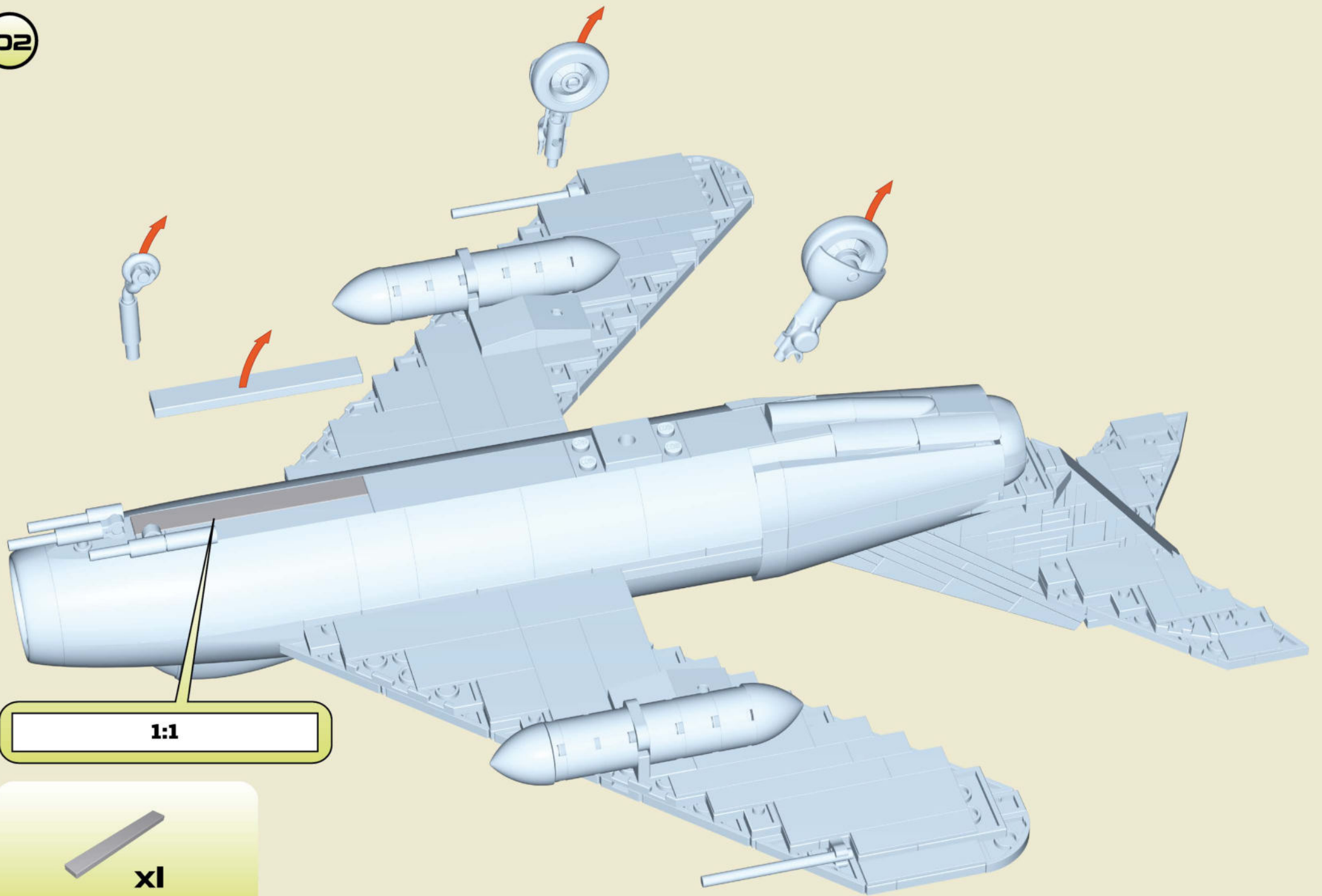

1:1

x1

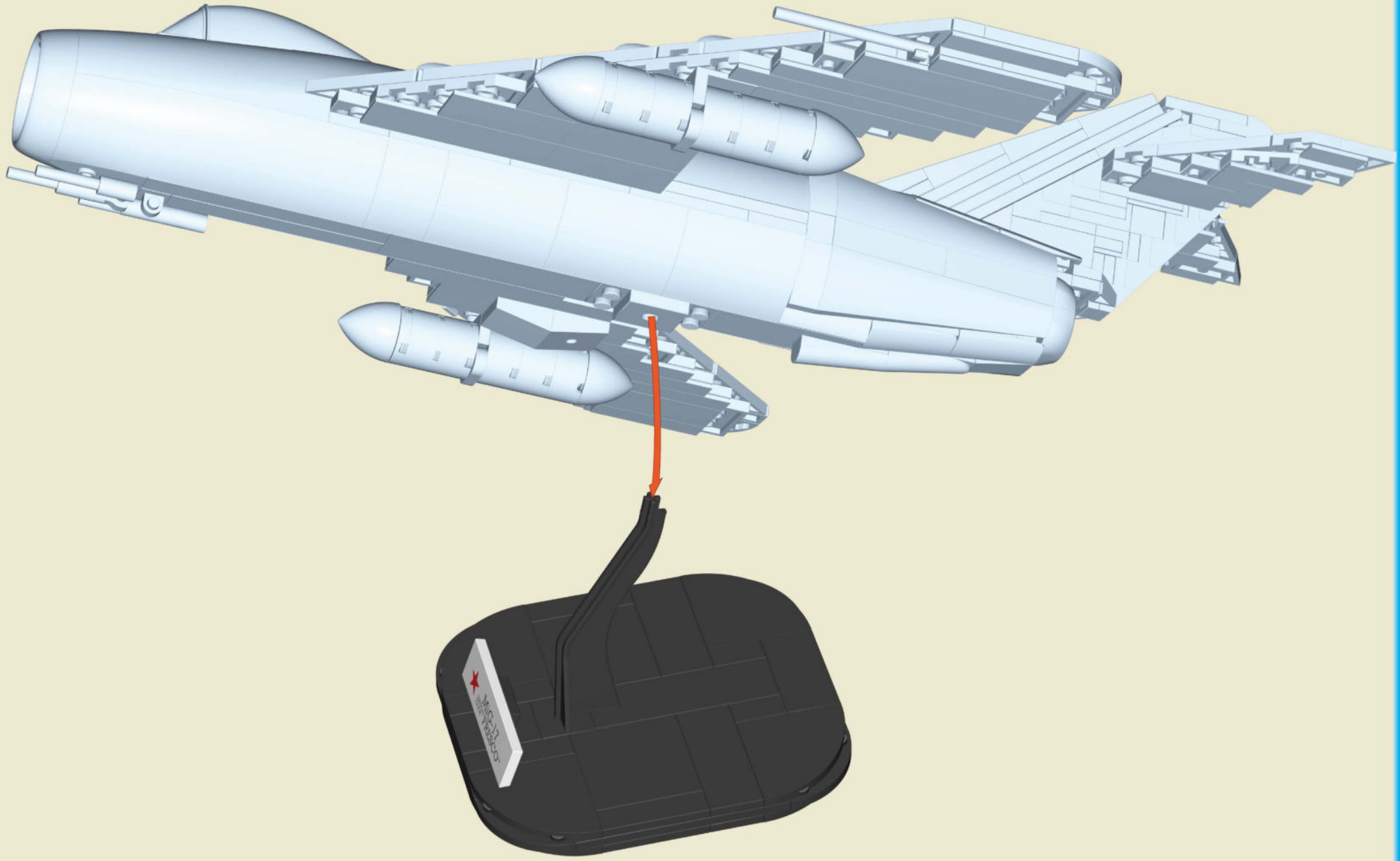

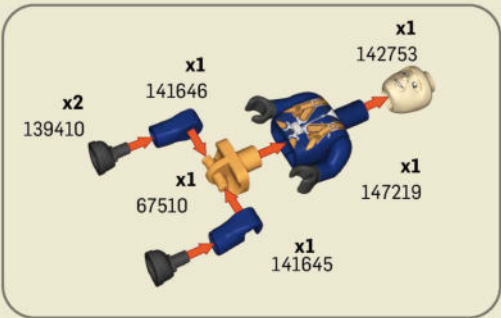

- | | | | | | | | | | | | |
|--|--|--|---|---|---|---|---|--|---|--|---|
|  x3
43969 |  x16
43971 |  x2
140748 |  x2
124771 |  x2
88328 |  x5
43668 |  x2
97311 |  x3
77142 |  x3
107100 | | | |
|  x1
119720 |  x1
118380 |  x2
44969 |  x2
118461 |  x2
43667 |  x1
76865 |  x2
111183 |  x1
85894 |  x3
44366 | | | |
|  x2
132144 |  x8
42929 |  x15
43671 |  x3
43922 |  x1
45448 |  x4
45158 |  x1
107343 |  x16
132146 |  x1
93014 | | | |
|  x1
96778 |  x2
42950 |  x1
43673 |  x7
105814 |  x2
110070 |  x1
139594 |  x1
139593 |  x1
42893 |  x1
43834 |  x6
42903 | x2
111184 | x4
142978 |
|  x1
82096 |  x17
108368 |  x3
42957 |  x1
74334 |  x1
103169 |  x6
93456 |  x1
113420 |  x1
44117 |  x1
142948 |  x4
98979 | x4
123953 | x4
122006 |
|  x2
117319 |  x1
137449 |  x1
123954 |  x8
43676 |  x3
42983 |  x10
43931 |  x4
61577 |  x6
60522 |  x2
64203 |  x2
110387 | x1
143324 | x1
143325 |
|  x6
132147 |  x5
64204 |  x1
64212 |  x2
85379 |  x8
120186 |  x2
43015 |  x4
132148 |  x1
43679 |  x1
124036 |  x4
110412 | x1
43031 | x2
43680 |
|  x1
67219 |  x1
43685 |  x2
127904 |  x26
43686 |  x4
43868 |  x1
126280 |  x1
51182 |  x1
126281 |  x1
51183 |  x1
77560 | x4
77542 | x1
75779 |
|  x2
136254 |  x2
142316 |  x1
43073 |  x10
110701 |  x2
61499 |  x2
117784 |  x4
124558 |  x2
43152 |  x7
43690 |  x3
86068 | x4
117785 | x2
45569 |
|  x1
43172 |  x1
43697 |  x6
124047 |  x1
109915 |  x2
112257 |  x4
142191 |  x2
118323 |  x1
143326 |  x6
43192 |  x1
143327 | x1
43183 | x6
124005 |





HISTORICAL COLLECTION



STURMPANZERWAGEN A7V

2989



SOLDIERS OF THE GREAT WAR

2051



MARK V (Male)

2984



SOPWITH CAMEL F.1

2987



FOKKER DR.1 "RED BARON"

2986



ROLLS ROYCE ARMOURD CAR

2988





HISTORICAL COLLECTION



MIG-15 NATO "FAGOT"
★ 2416



MITSUBISHI A6M2 "ZERO-SEN"
☘ 5729



LIM-5 POLISH AIR FORCE 1959
🇵🇱 5824



Produced under license from Boeing. Boeing and the P-51 Mustang are trademarks of The Boeing Company.



P-51D MUSTANG™
★ 5719



For news and special deals

Find us on:



WWW.COBI.EU

03-05823-563