

**ARMED
FORCES**

LOCKHEED MARTIN



F-35^B LIGHTNING II^{*}
 FIRST FLIGHT - JUNE 11, 2008
 PLACE OF ORIGIN - USA
 ROLE - MULTIROLE FIGHTER, AIR SUPERIORITY
 WINGSPAN - 10.7m (35')
 LENGTH - 15.6m (51' 2")
 HEIGHT - 4.36m (14' 3")
 MAXIMUM TAKE-OFF WEIGHT - 60,000LB CLASS
 ENGINE - F135-PW-600
 COMBAT RADIUS (INTERNAL FUEL) - 450km (833km)
 DESIGN LOAD FACTOR - 7g
 MAXIMUM FLIGHT LEVEL - 50,000ft
 SPEED - MACH 1.6
 ARMAMENT - AIM-120 AMRAAM,
 GBU-32 JDAM 1000 LB, AIM-9X, GUN POD
 CREW - 1



5830

**PAD PRINTED
NO STICKERS**

Printed in EU

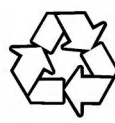

**UK
CA**

CE



WARNING: CHOKING HAZARD-
 Toy contains small parts.
 Not for children under 3 years.

594 1  

F-35^B LIGHTNING II[®]

SCALE 1:48

1

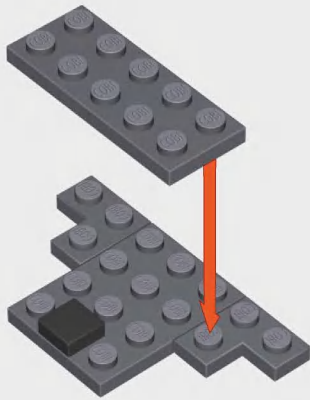

2

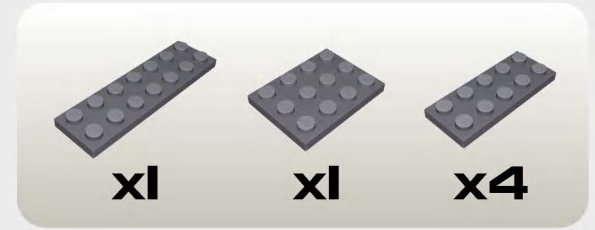
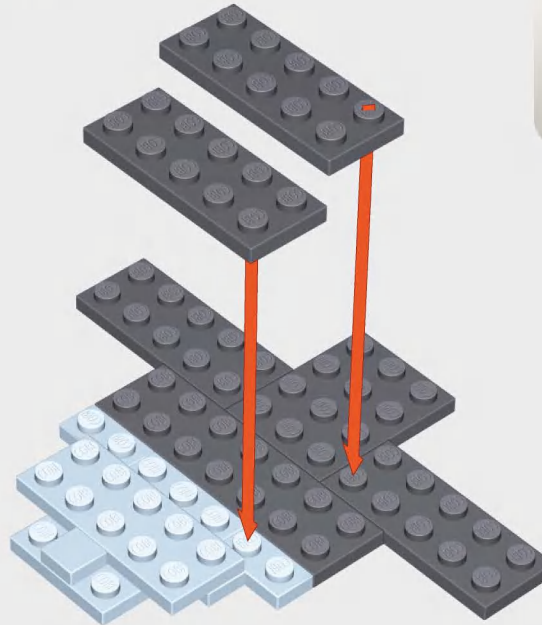

3

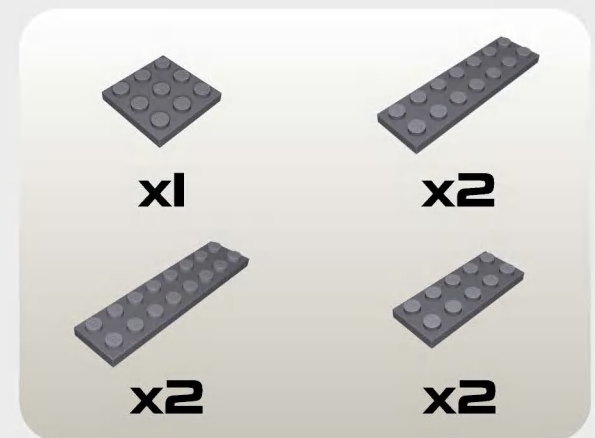
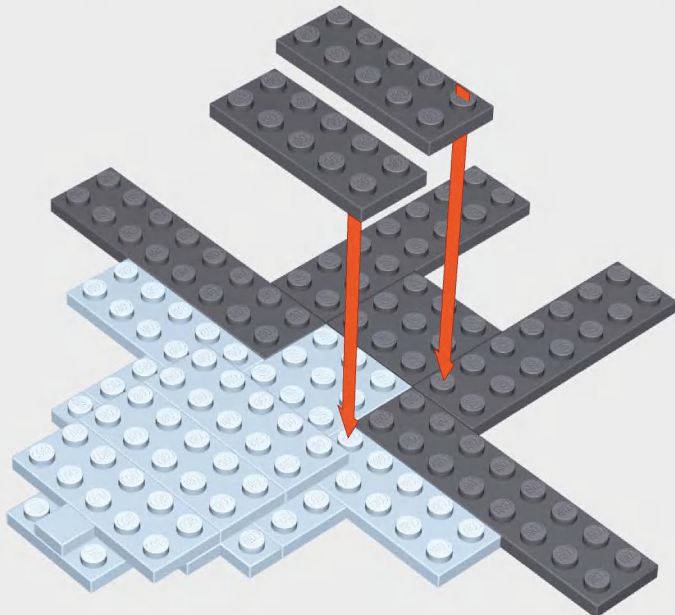



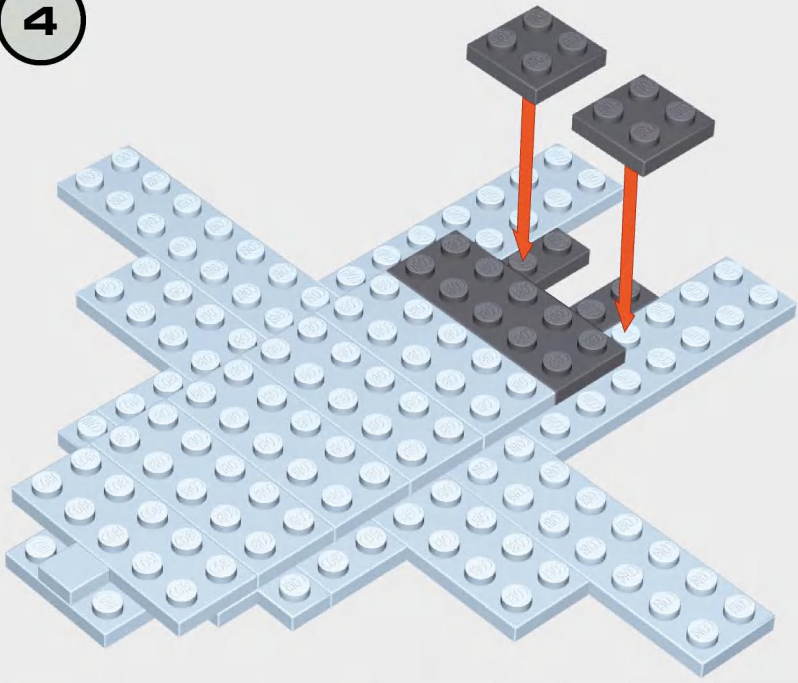

4

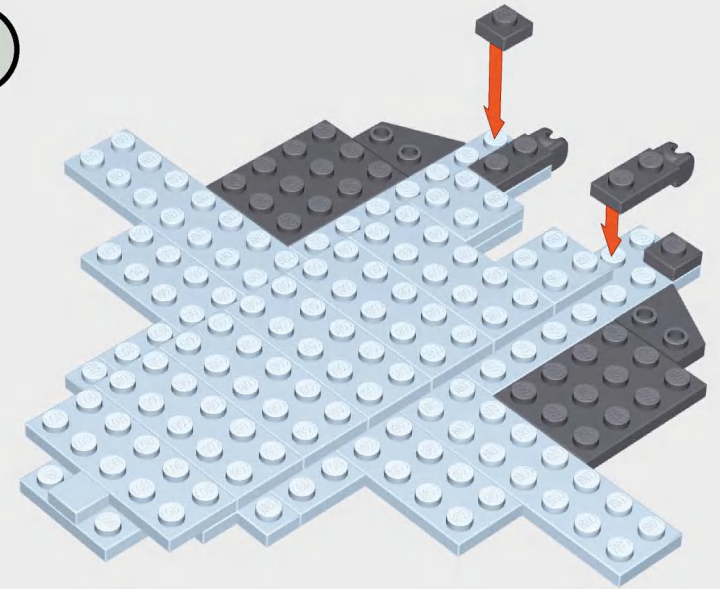

-  x1
-  x2
-  x2

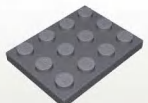



5

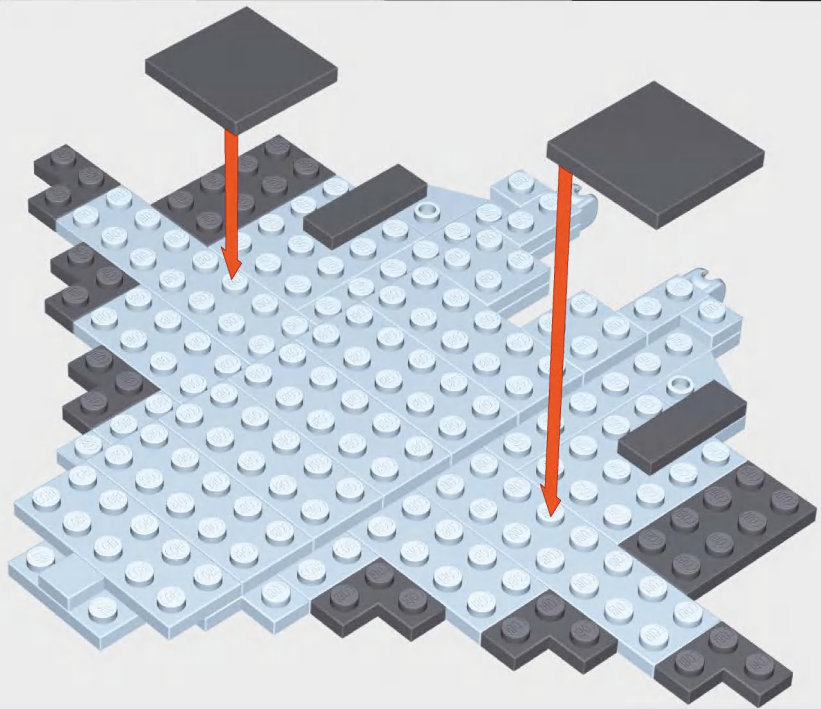

-  x2
-  x1
-  x1
-  x2
-  x2

6

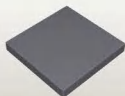

-  1:1
-  x6
-  x2
-  x2
-  x2

7

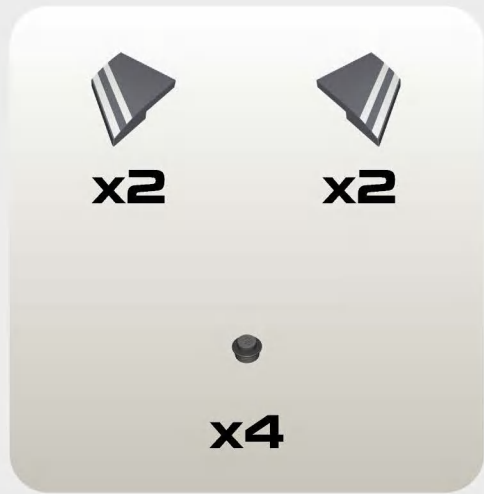
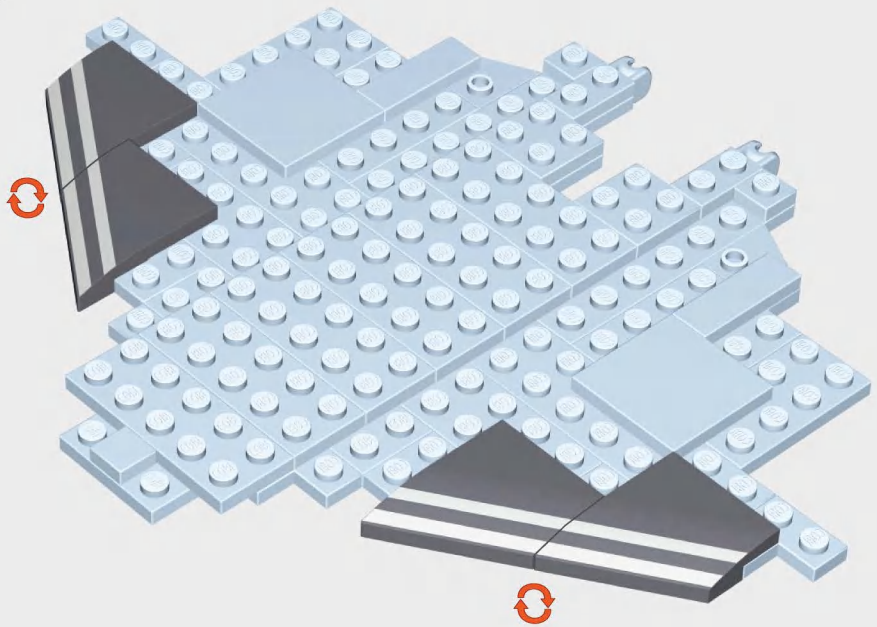



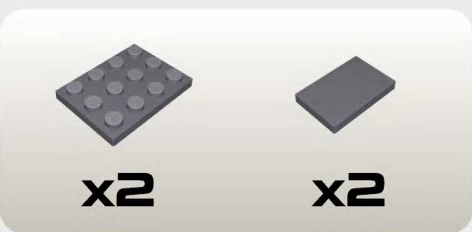
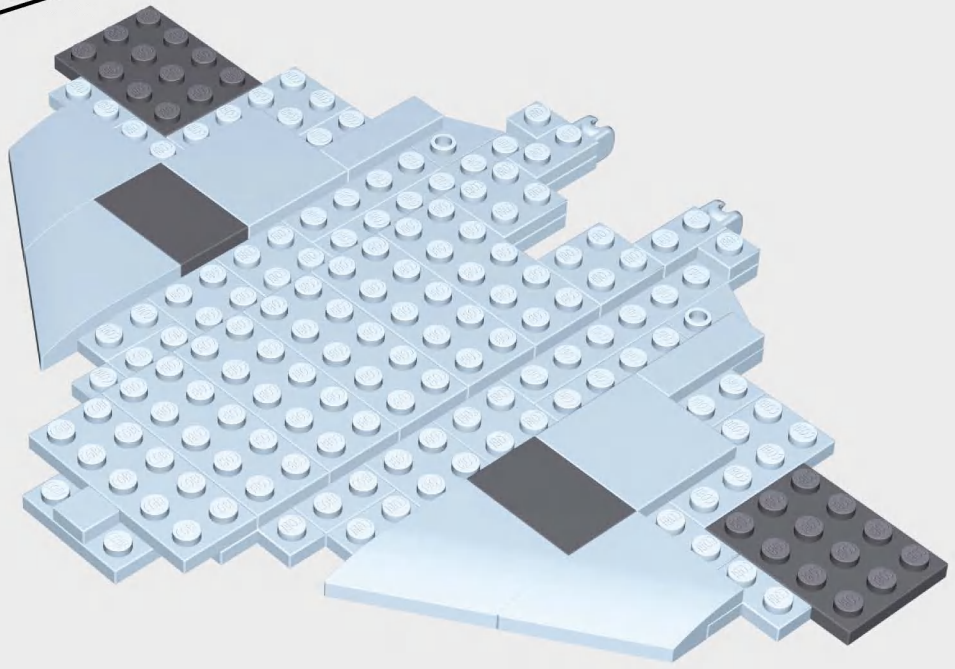

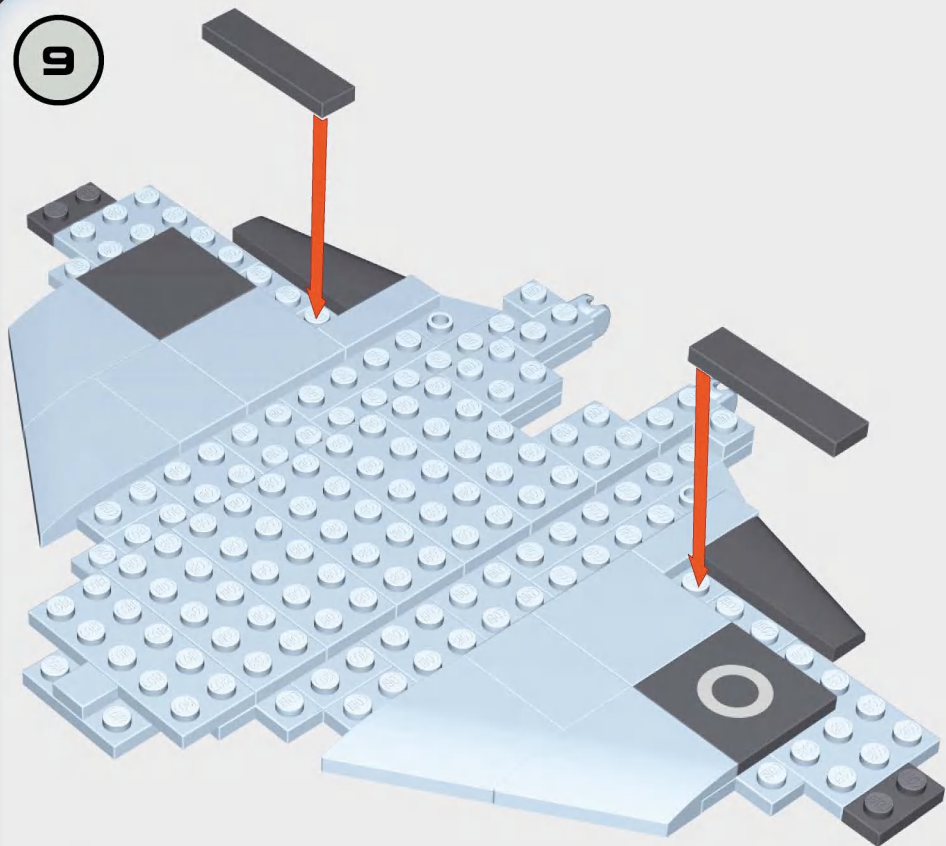

8



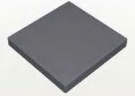



9

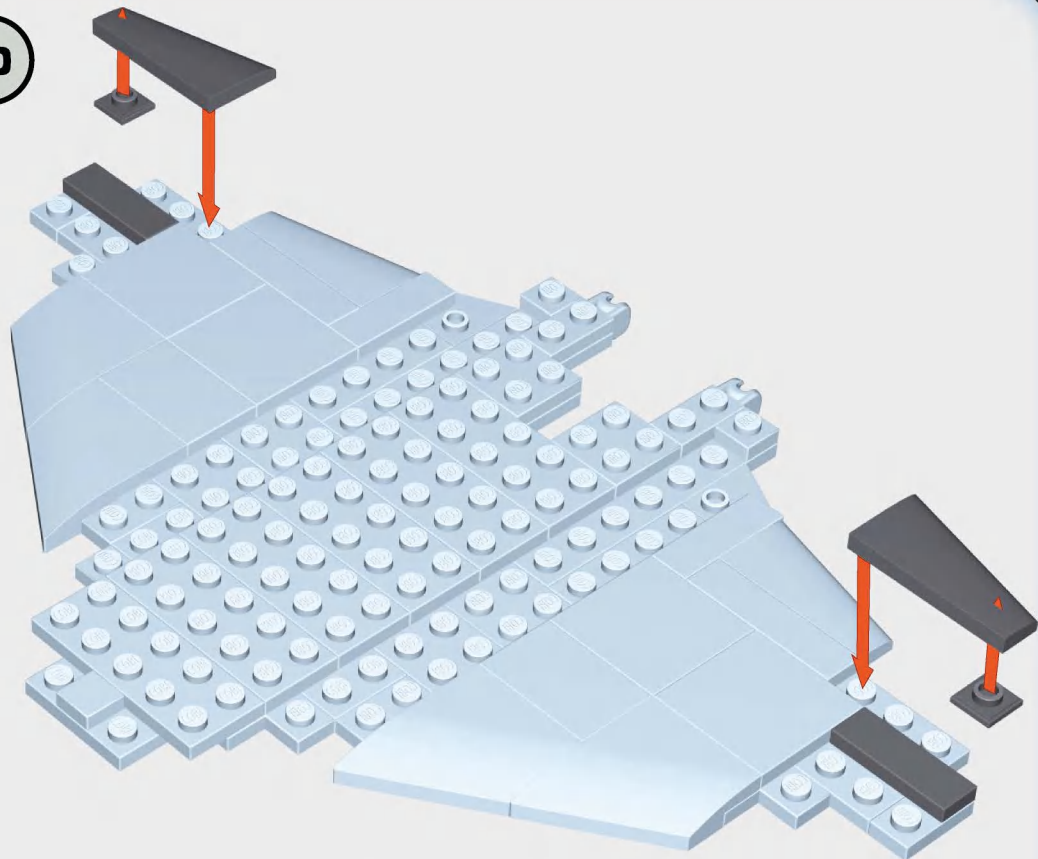

		
x1	x1	x1
		
x1	x2	x2
1:1		

10



1:1	
	
x2	x2
	
x1	x1

11

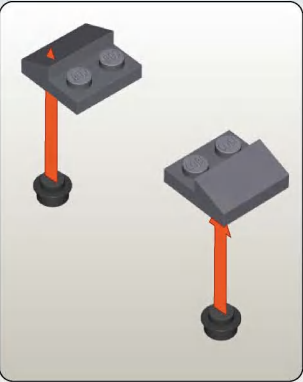
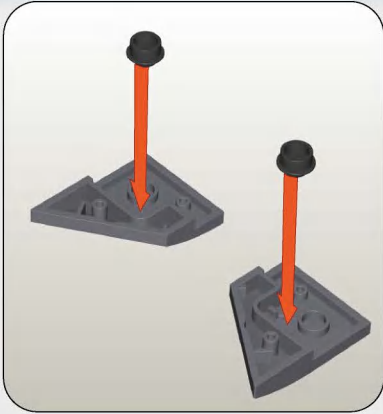
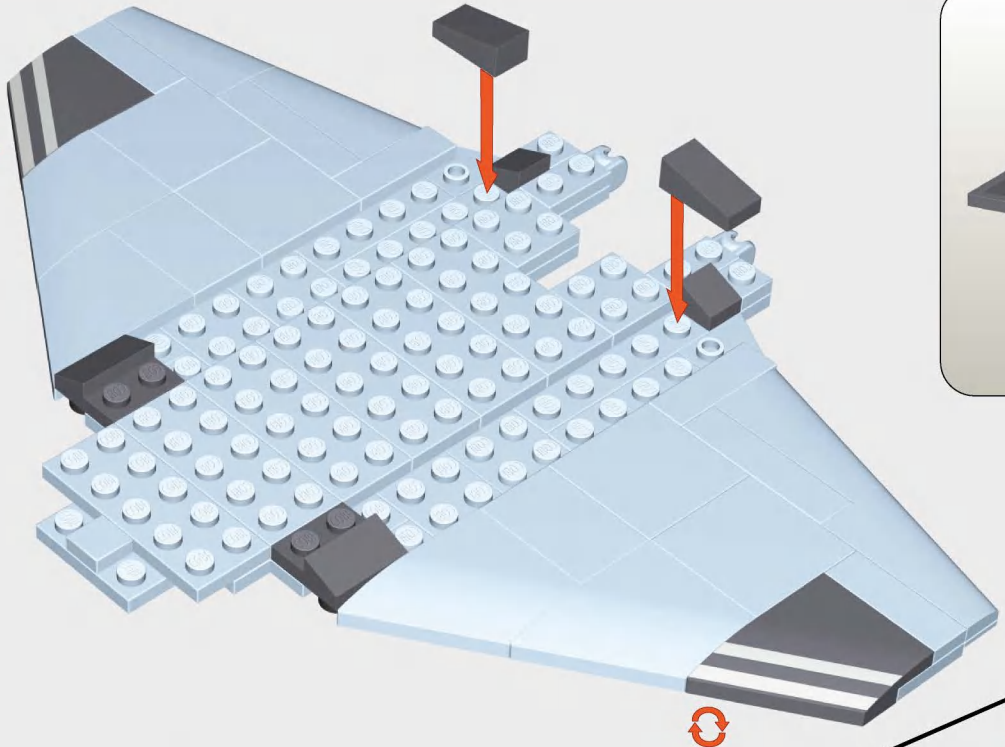

- 
x1
- 
x1
- 
x4
- 
x2
- 
x2
- 
x2

12

- 
x8
- 
x2

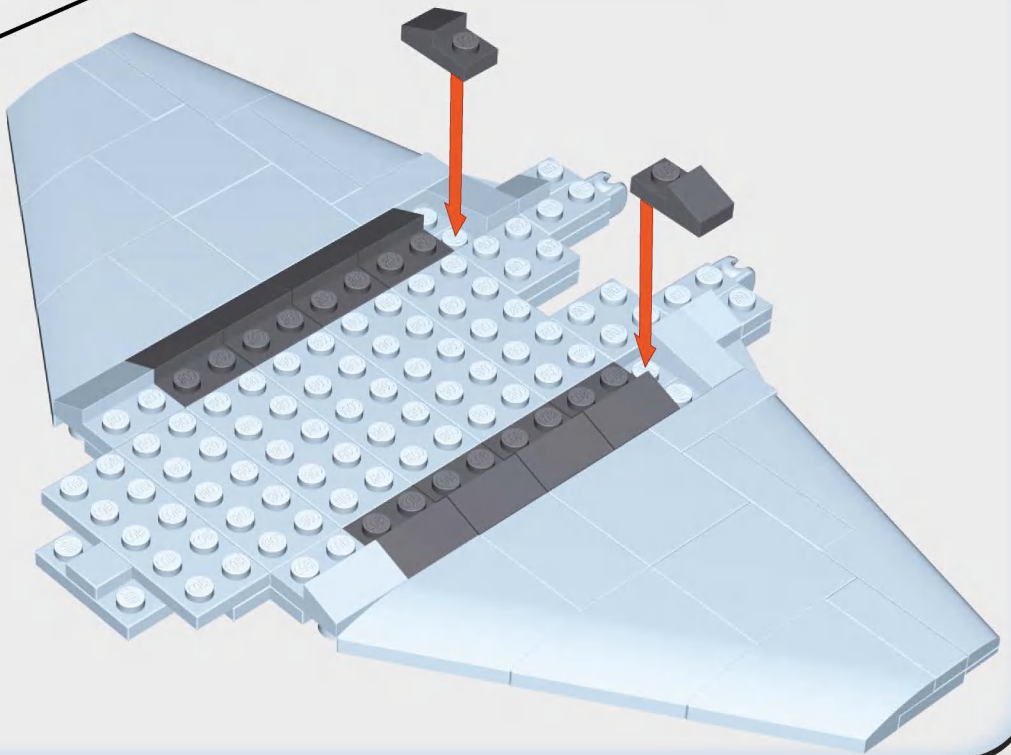

13

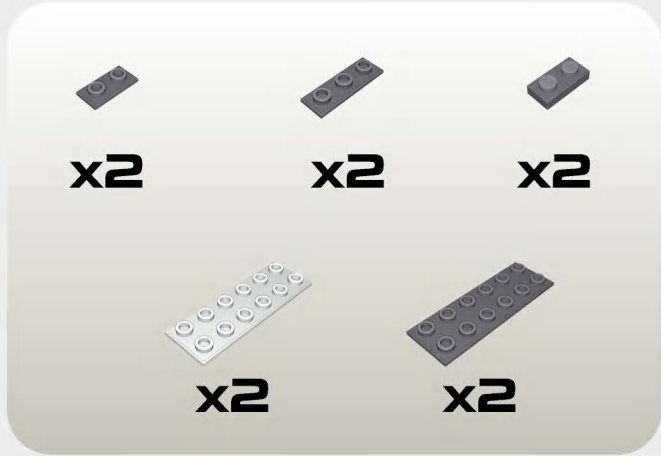
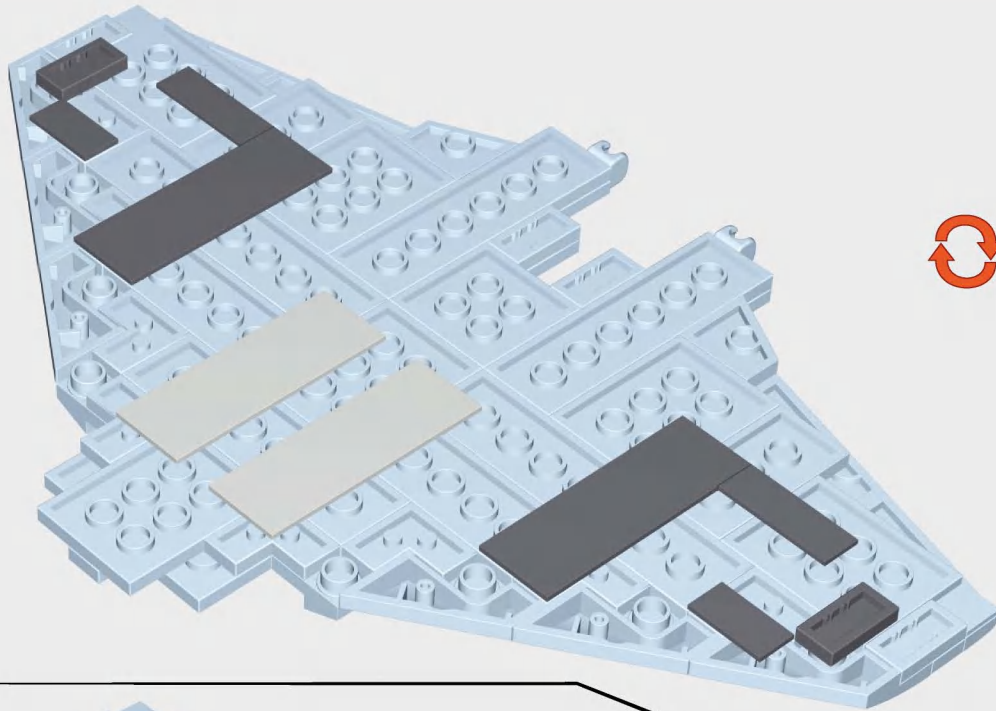



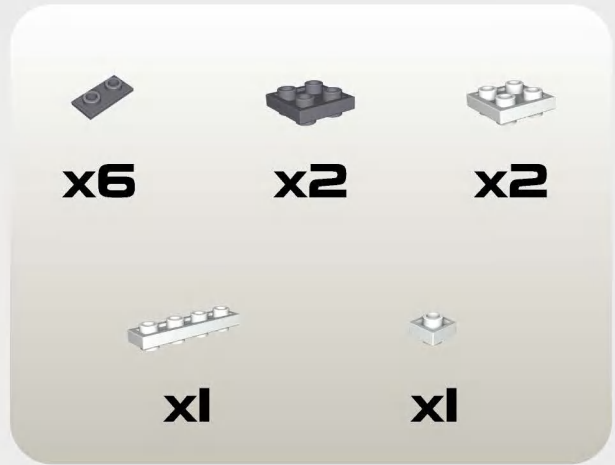
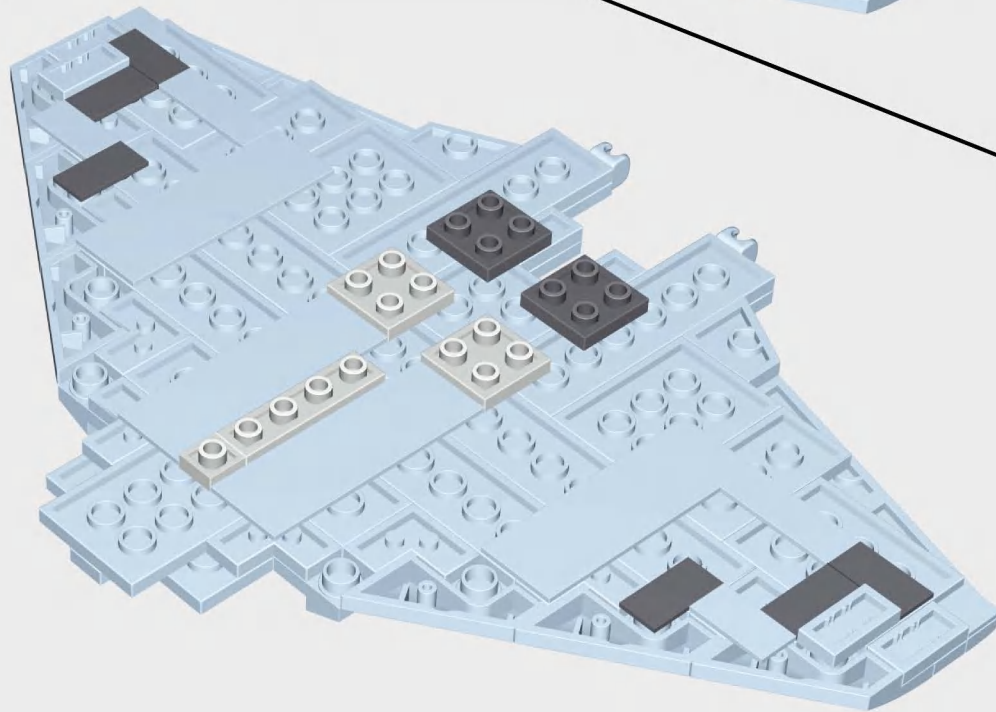

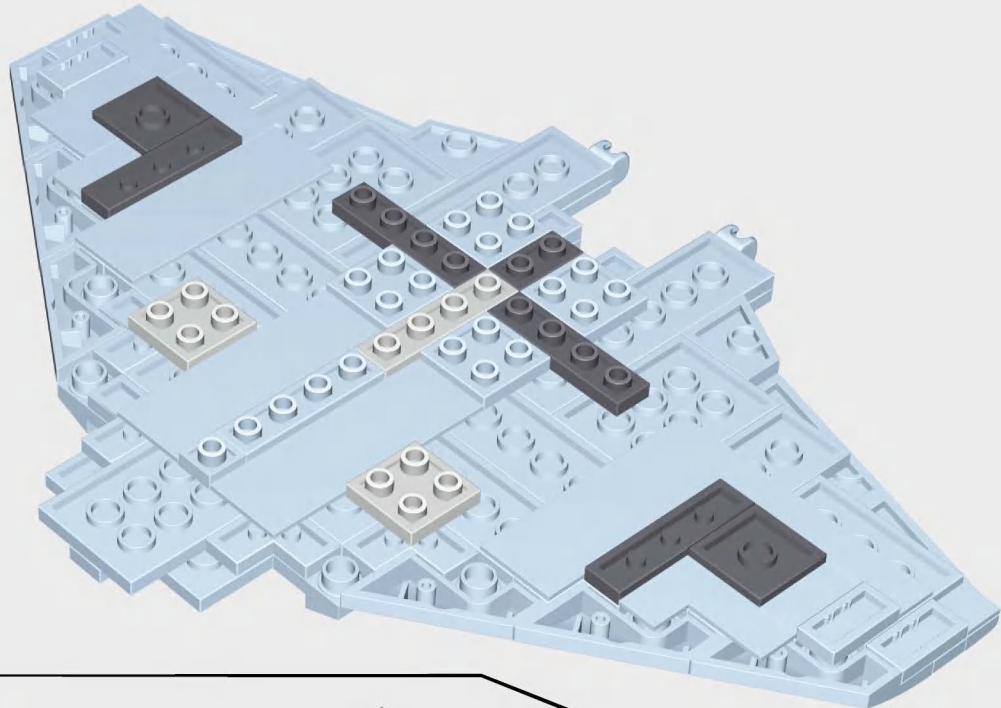

14



15



- | | | |
|---|---|---|
|  |  |  |
| x1 | x2 | x1 |
|  |  |  |
| x2 | x2 | x2 |

16

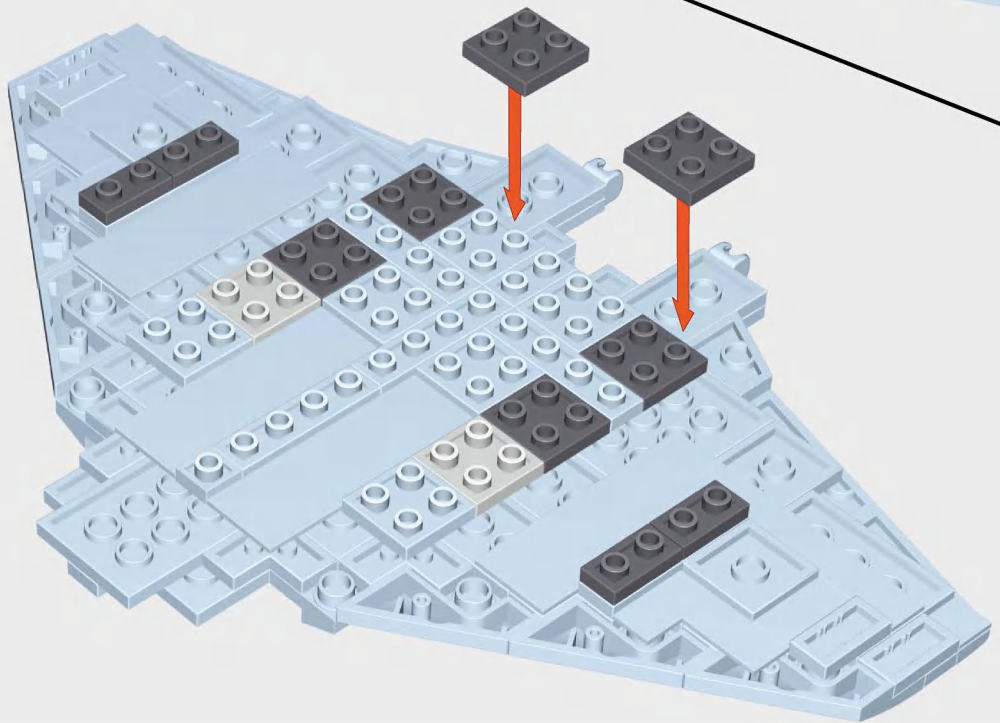

- | | | |
|---|---|---|
|  |  |  |
| x4 | x2 | x6 |

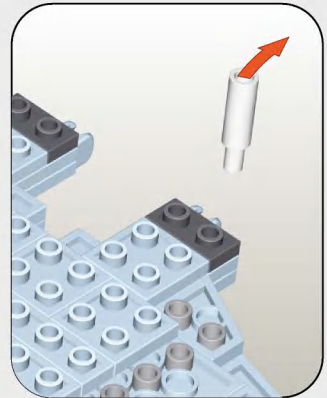
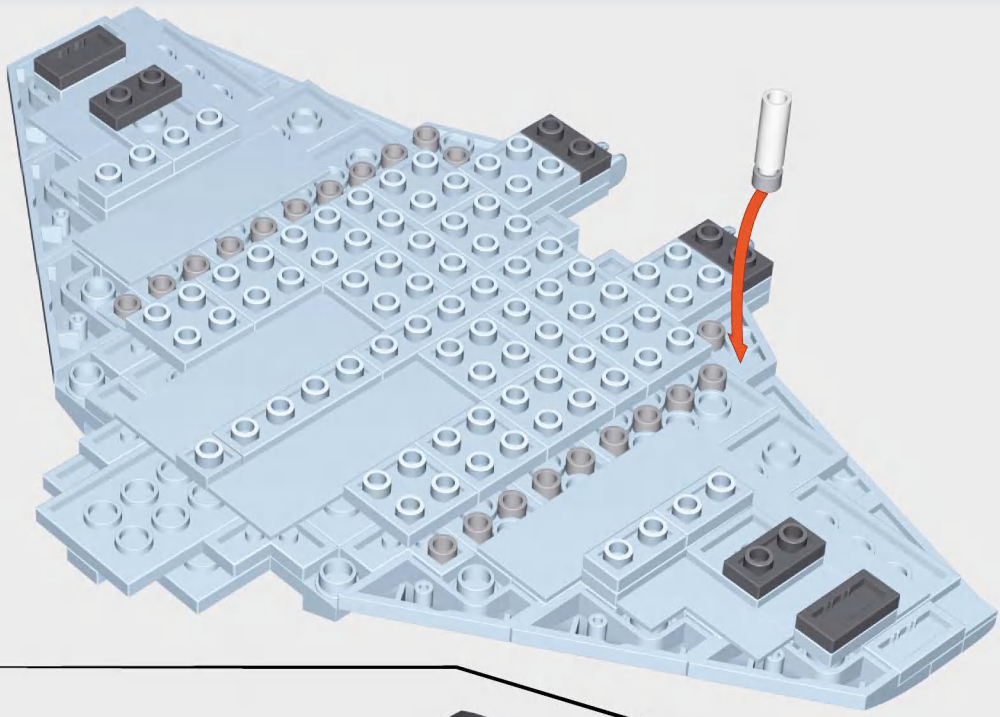

17





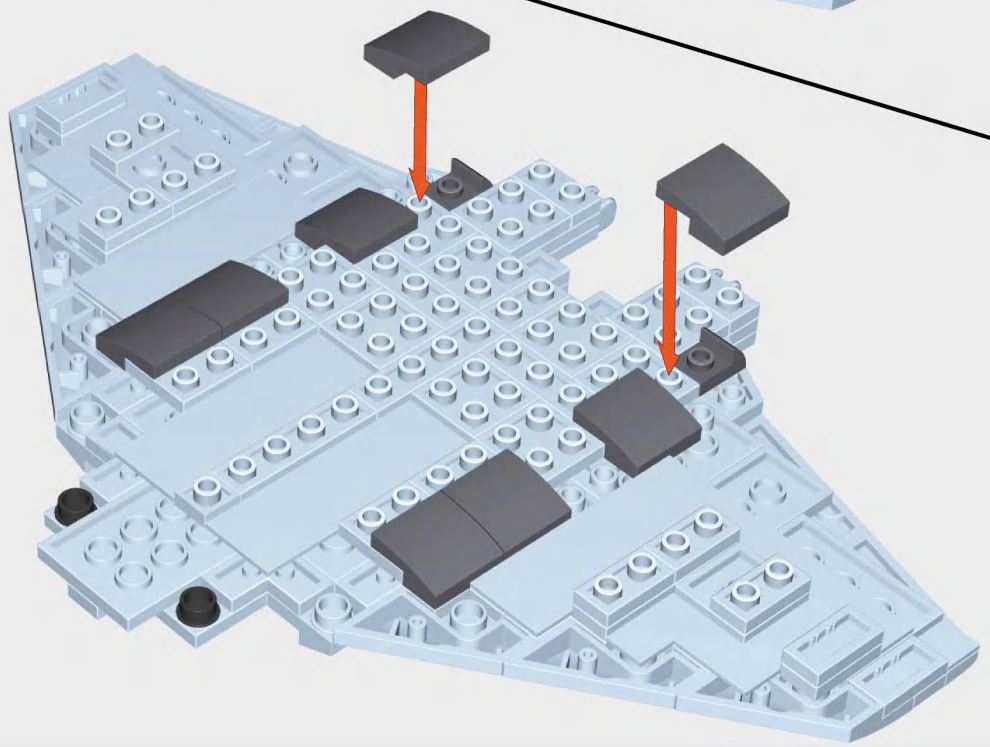



	
x4	x2
	
x22	

18



	
x2	x8
	
x2	



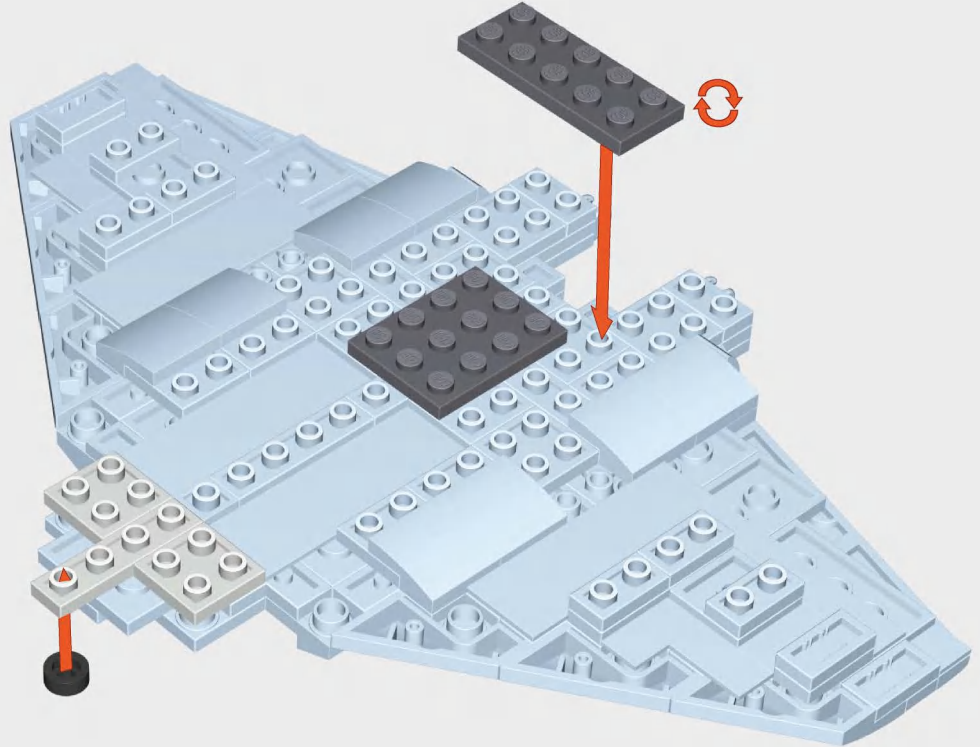
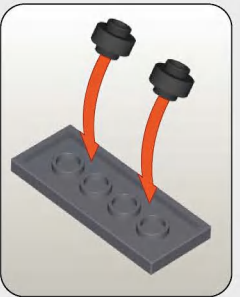

19

		
x1	x2	x1
		
x1	x1	x2

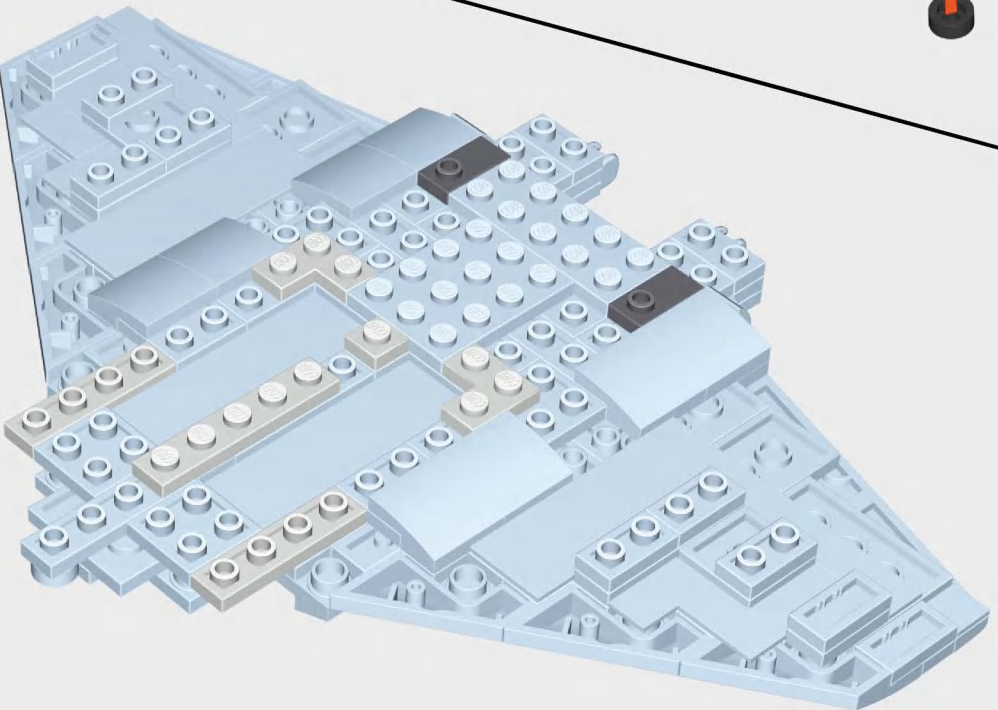

20



		
x2	x2	x2
		
x1	x1	

21



x2



x2



x2



x2



x2

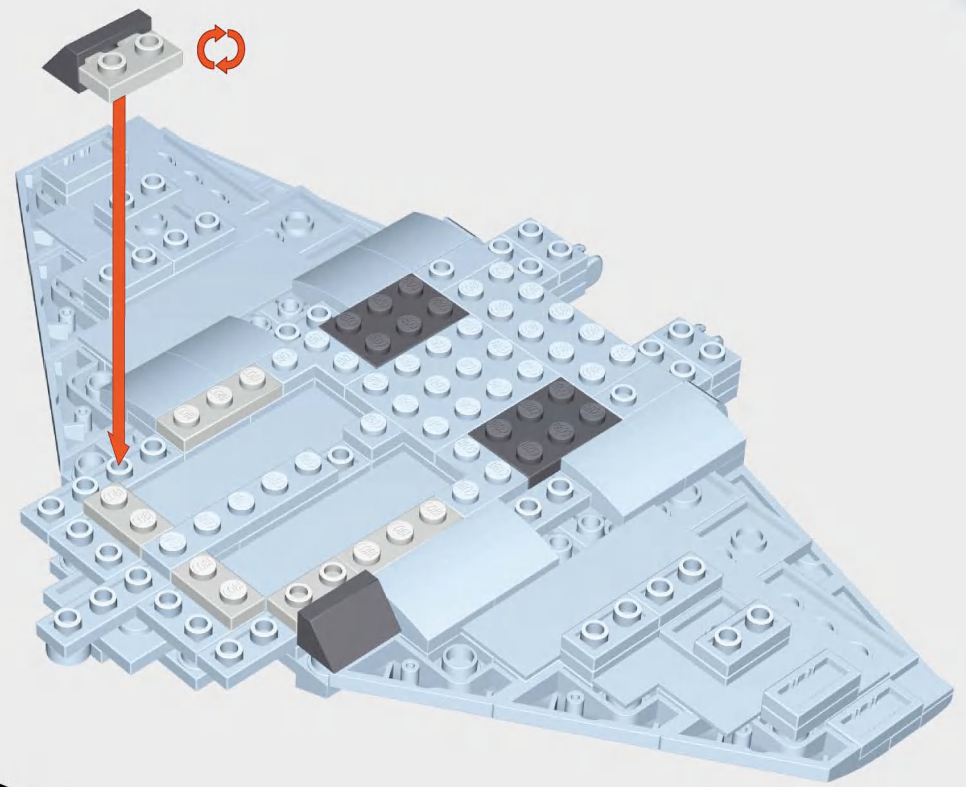
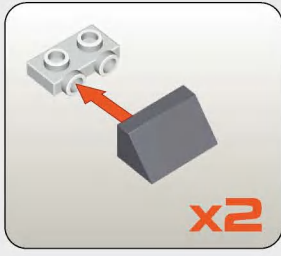

22

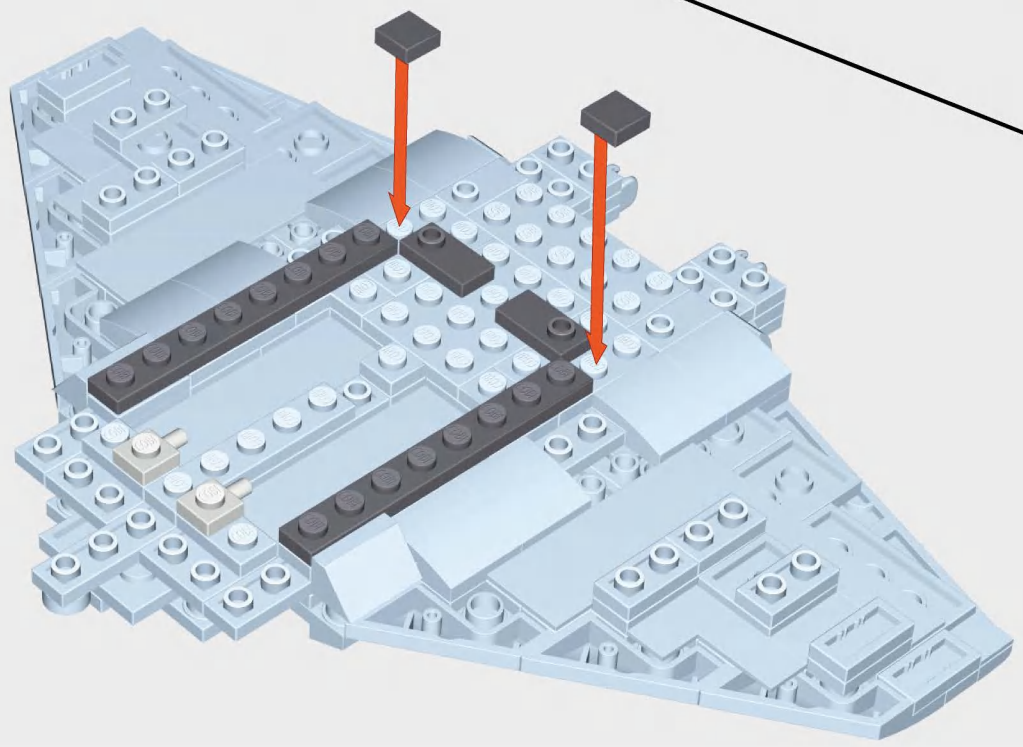

x2



x2



x2



x2





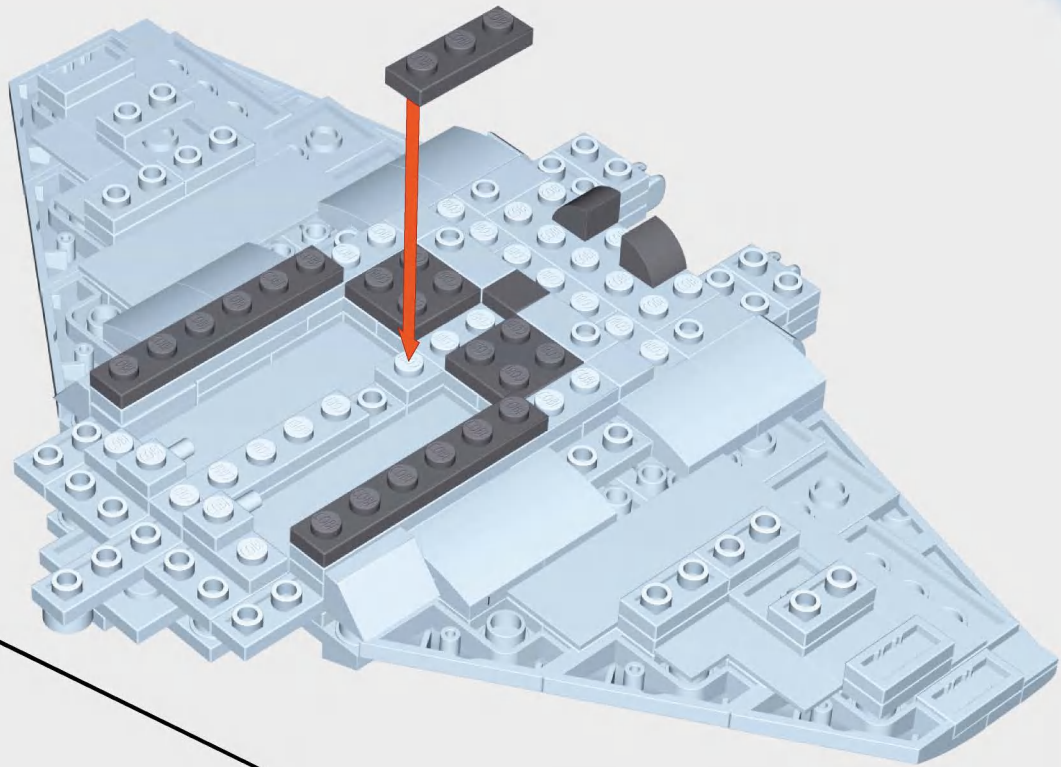
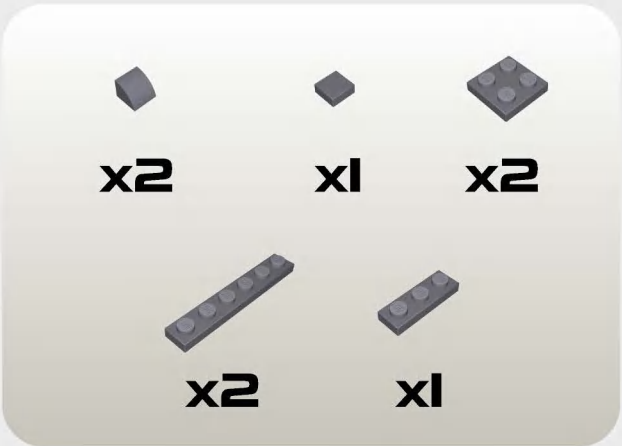

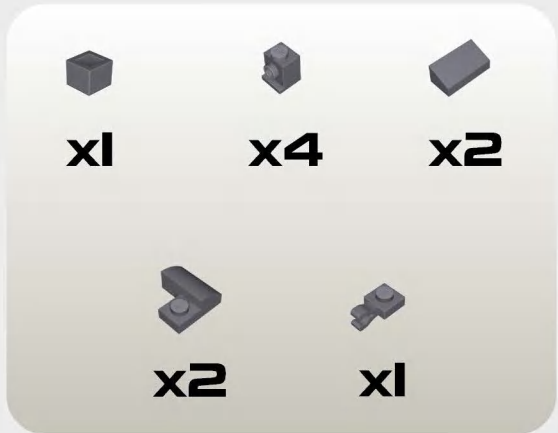
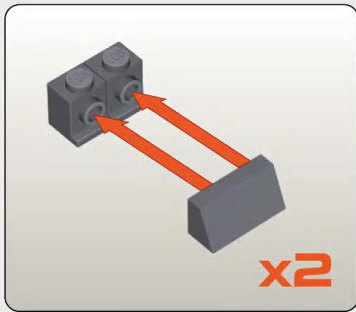
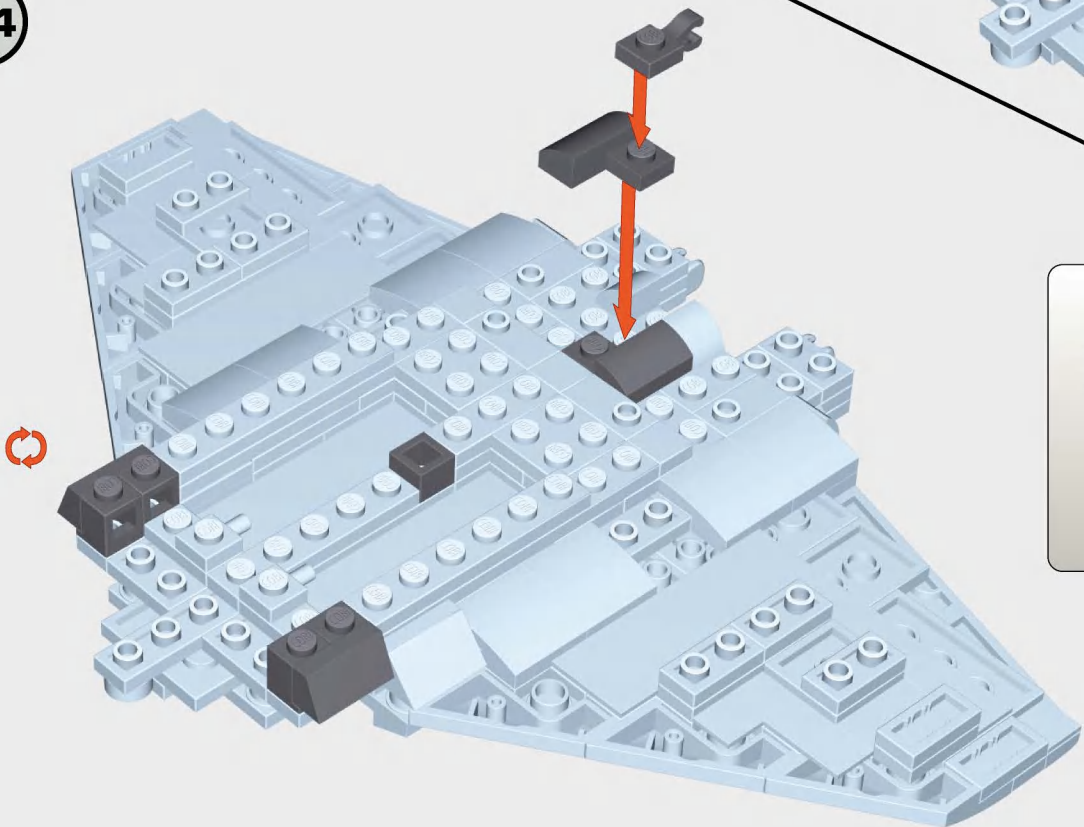

23

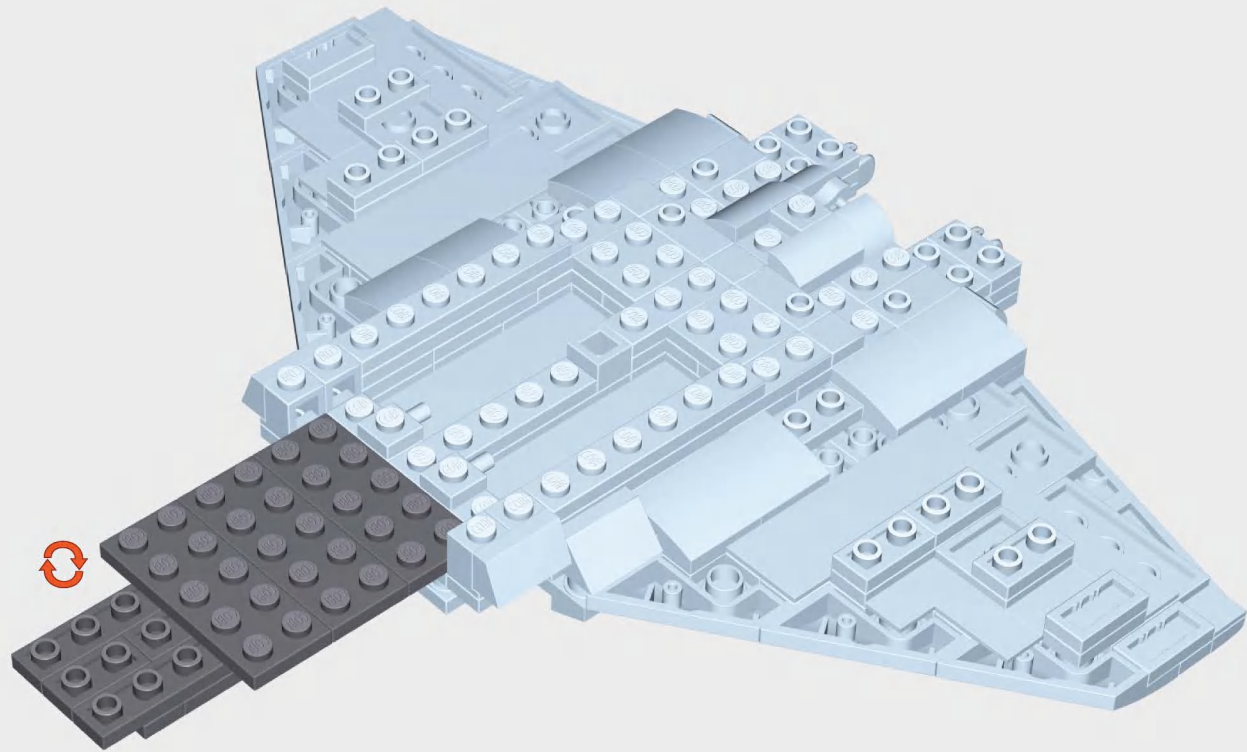
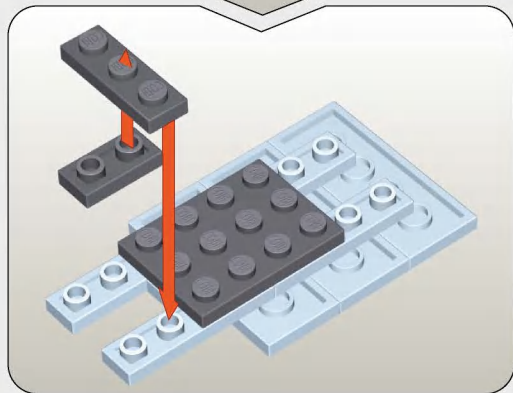
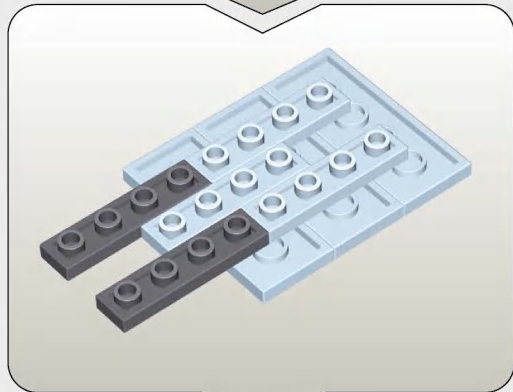
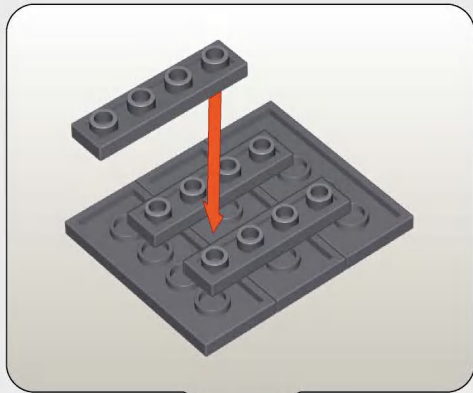







24

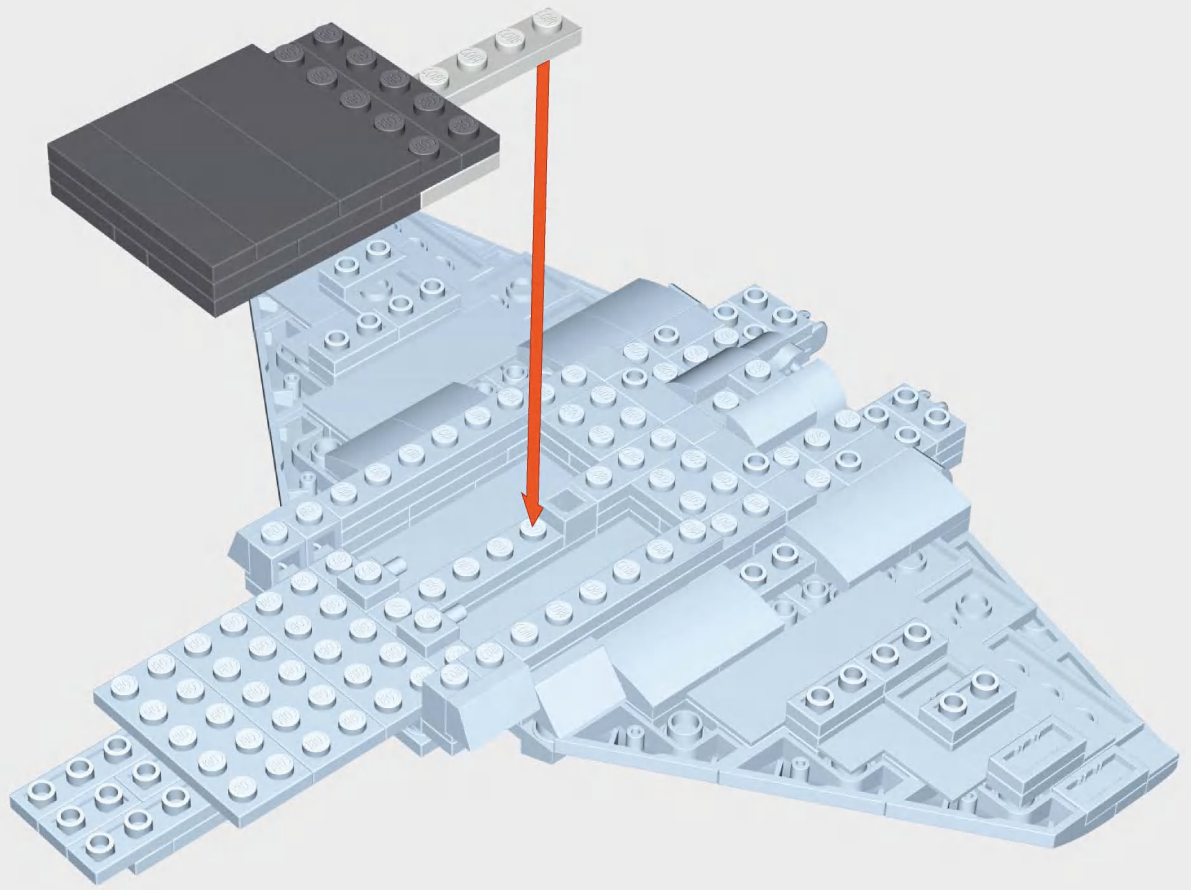
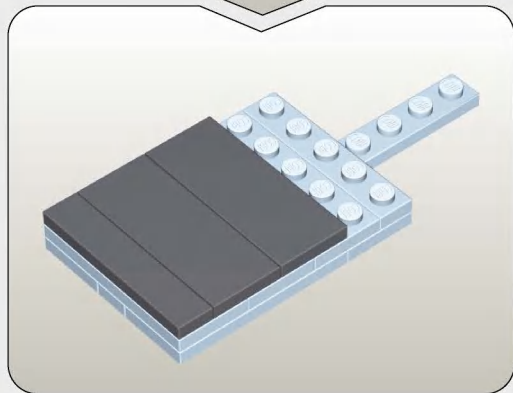
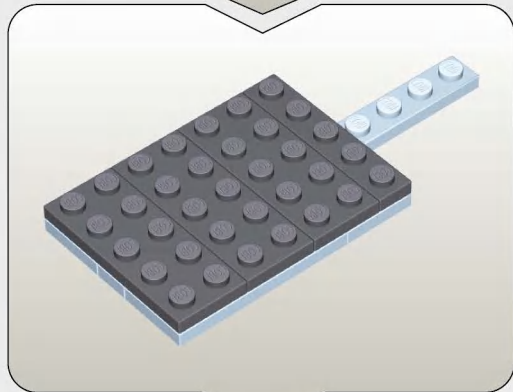
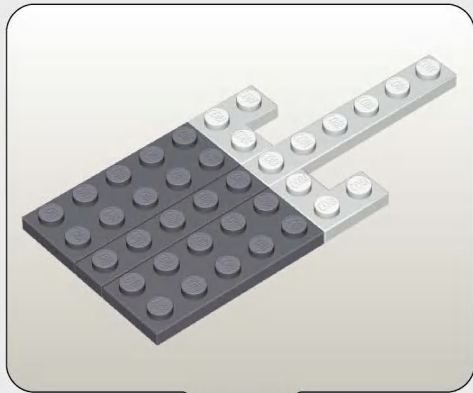



-  **x3**
-  **x5**
-  **x1**
-  **x1**
-  **x1**

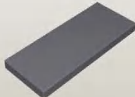

- | | | |
|--|--|--|
| 
x1 | 
x2 | 
x2 |
| 
x5 | 
x2 | 
x1 |
| 1:1 | | |

27

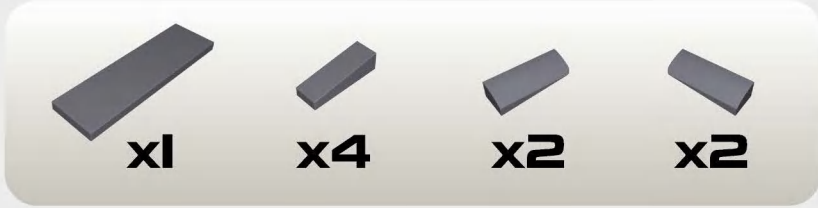
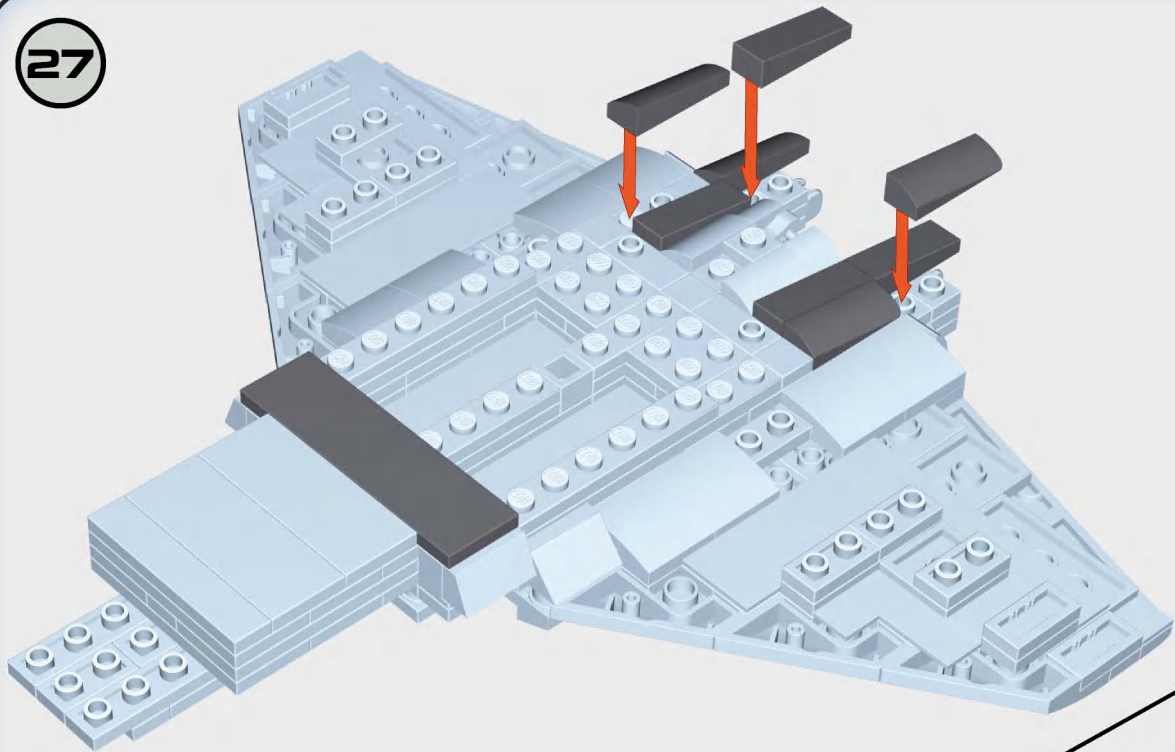

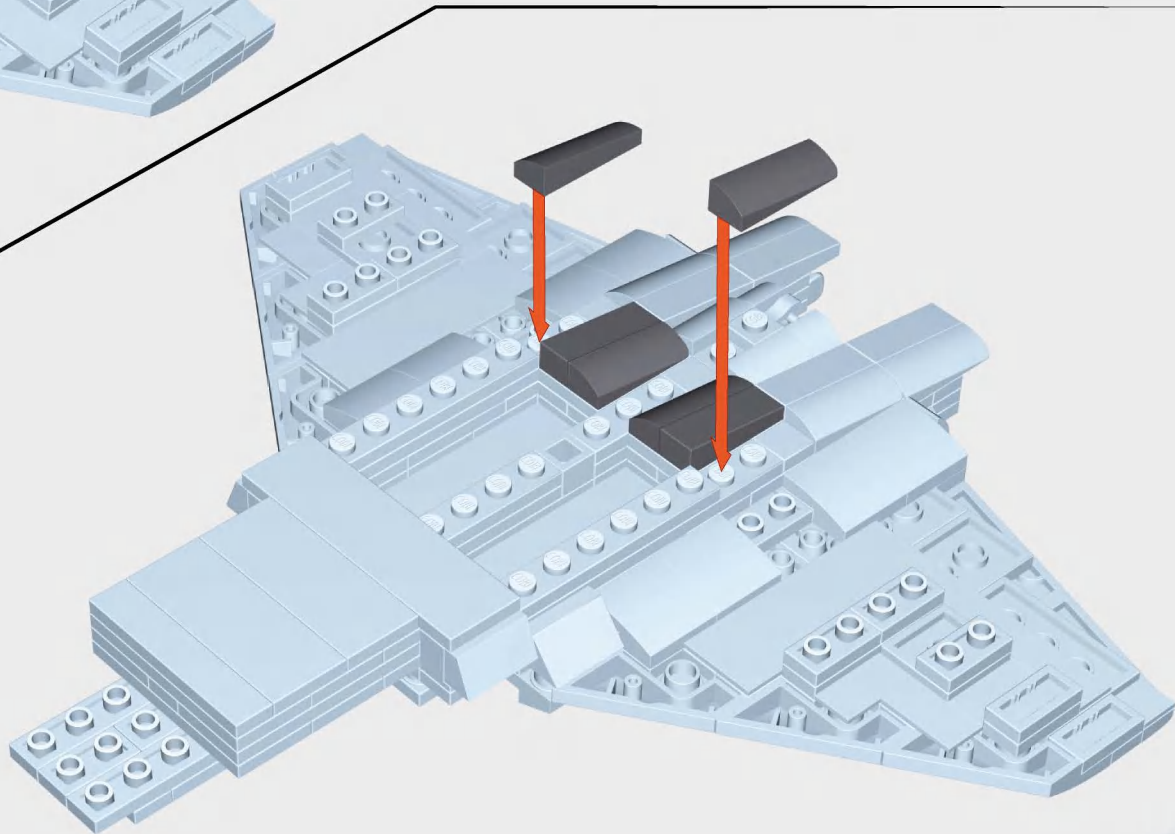

28



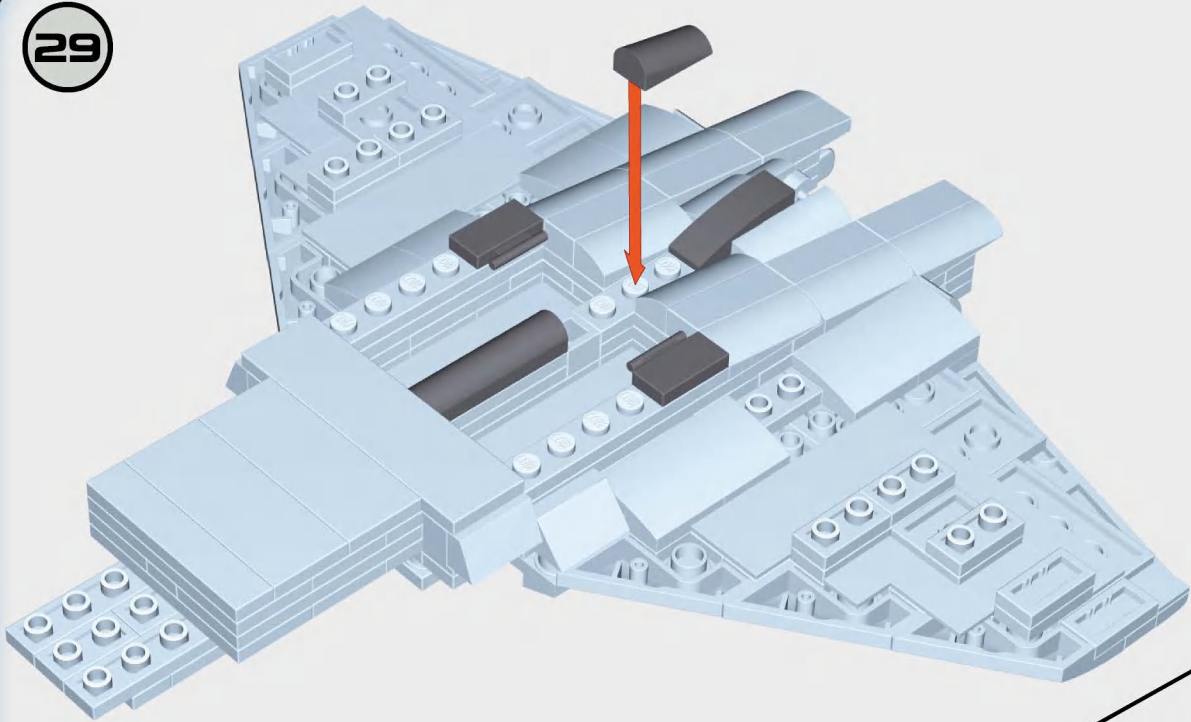



29



- 
x1
- 
x2
- 
x1
- 
x1

30

1:1

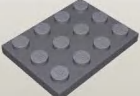
- 
x2
- 
x3
- 
x1
- 
x1
- 
x1
- 
x2

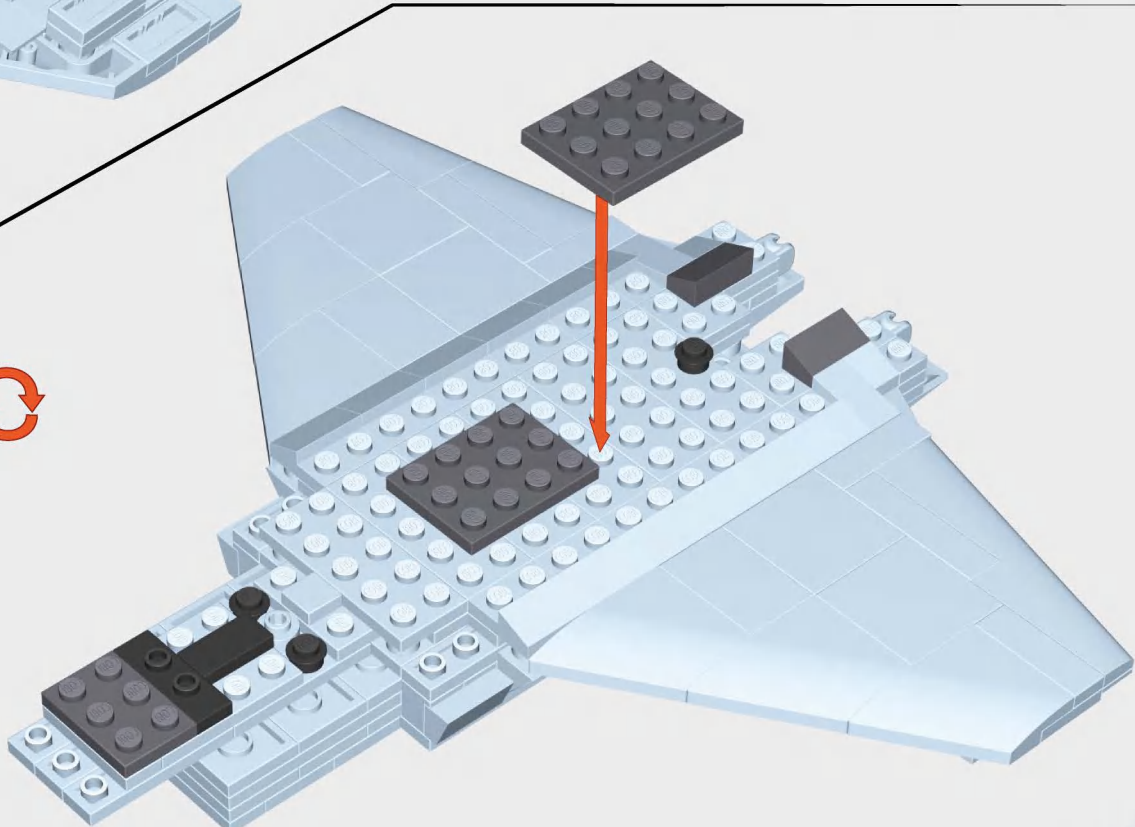

31

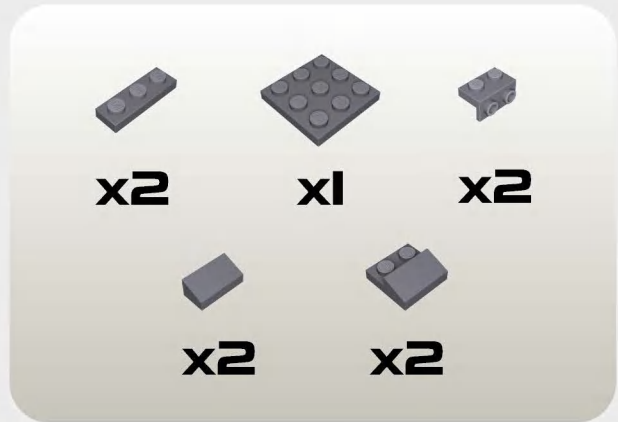
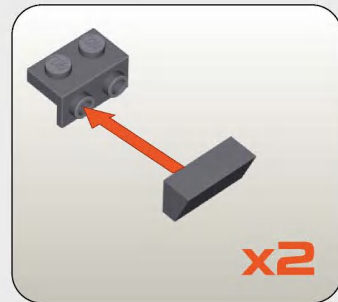
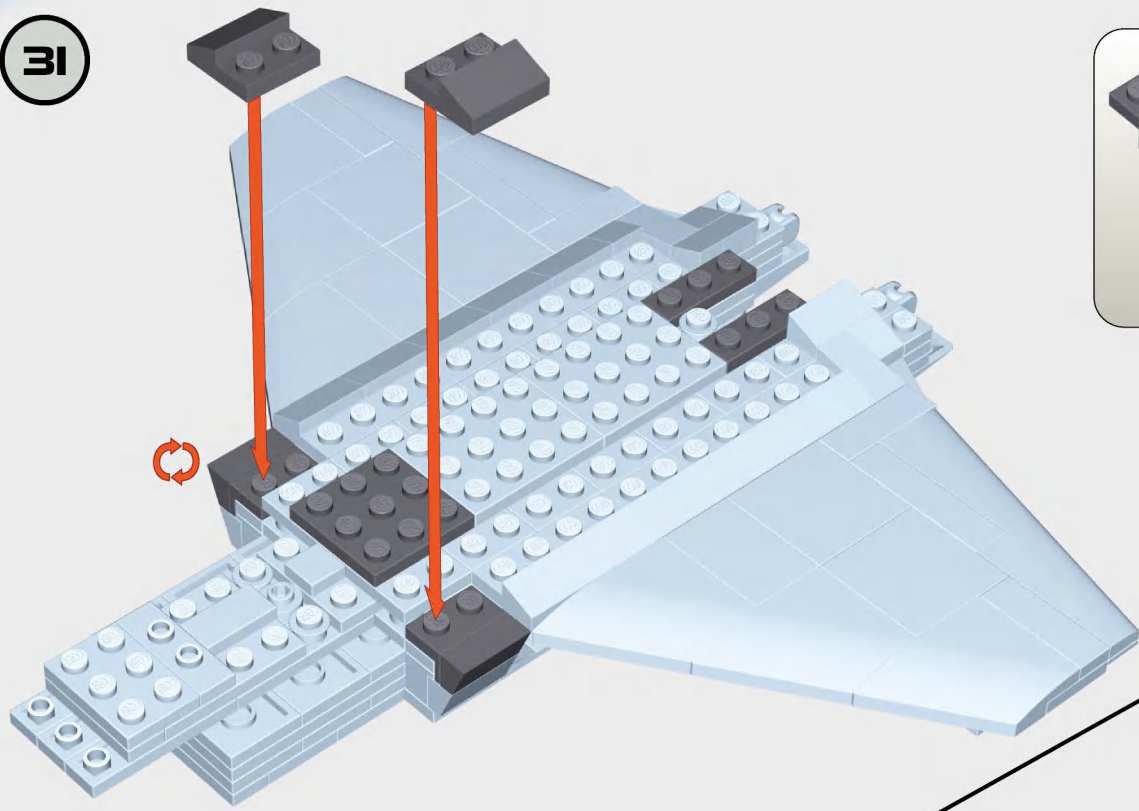

32

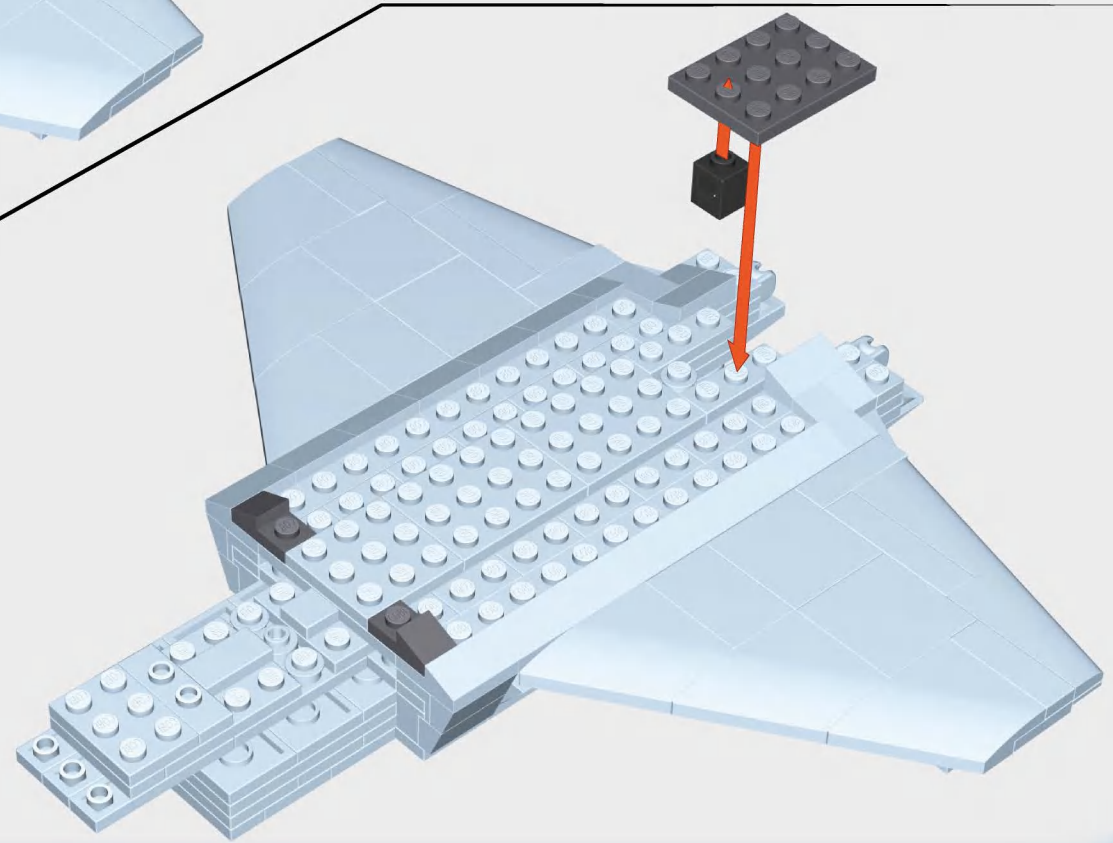

33

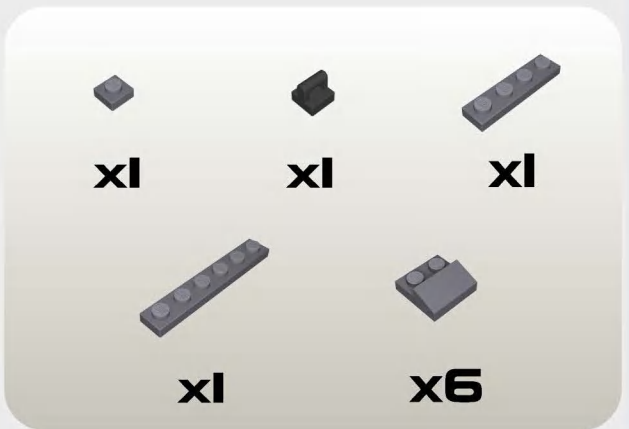
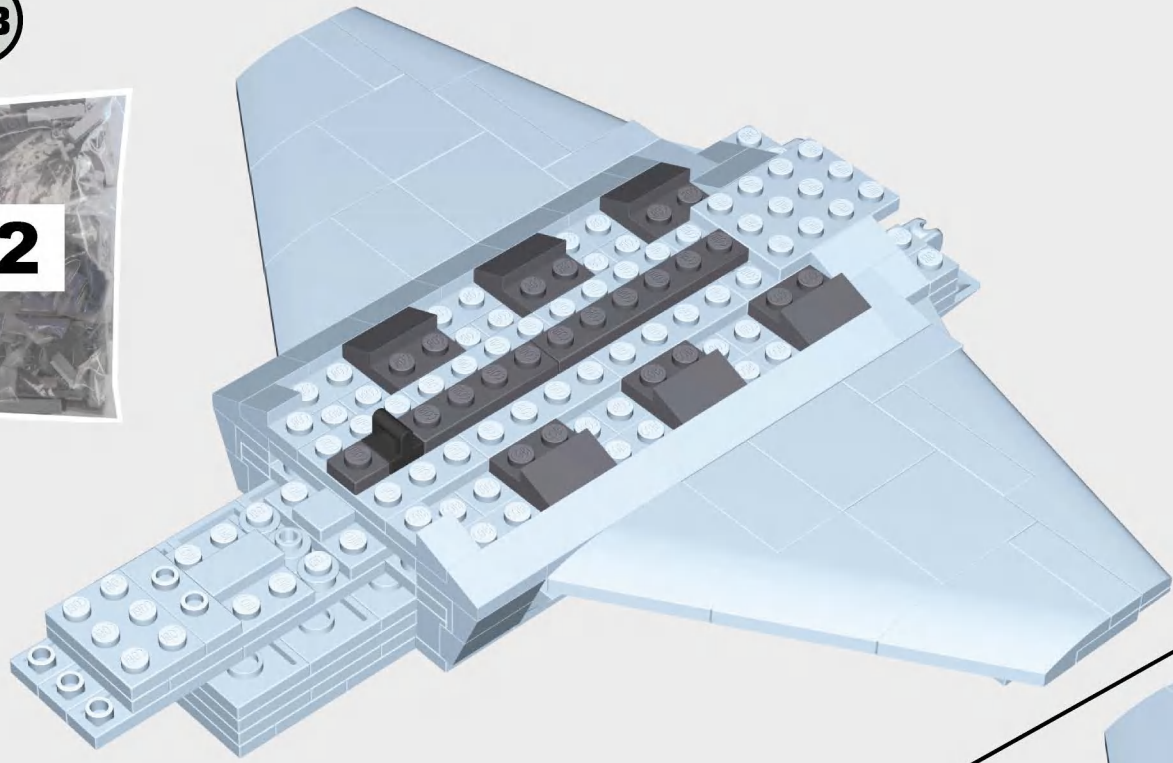

34

1:1

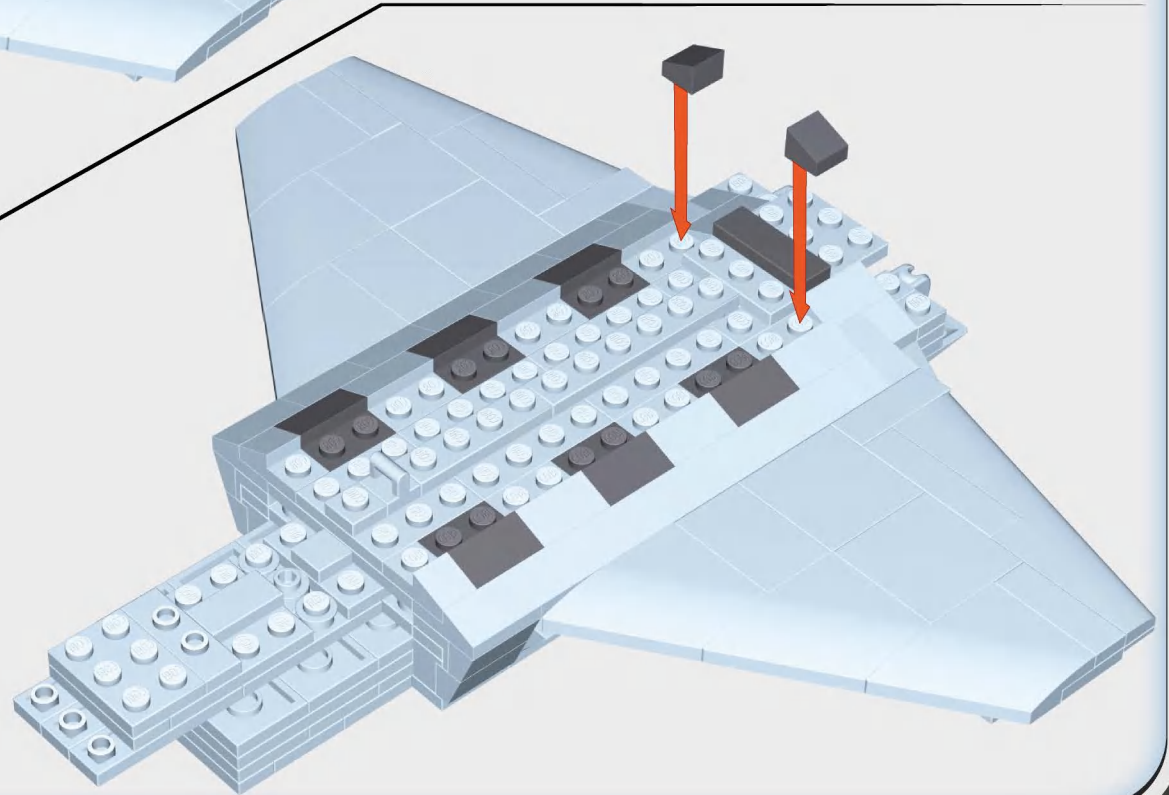
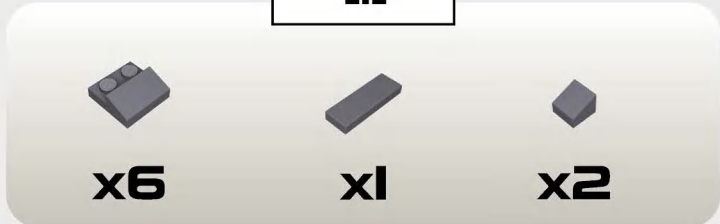

35

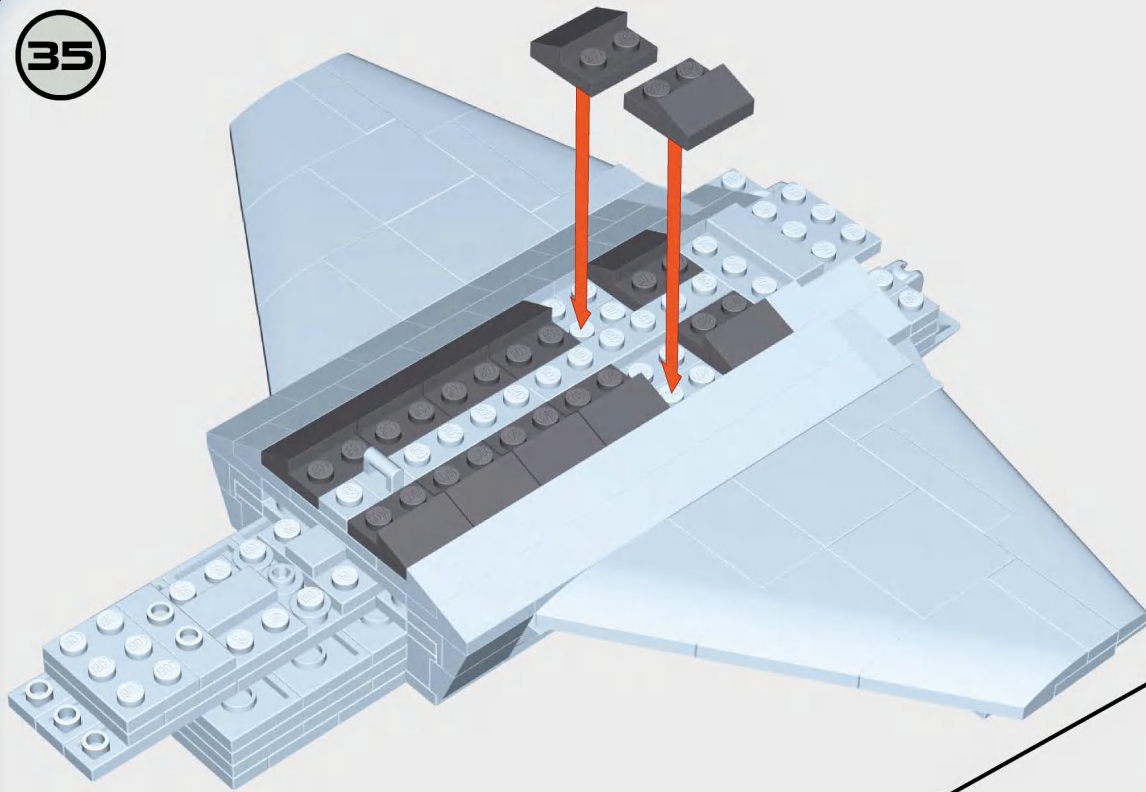

36

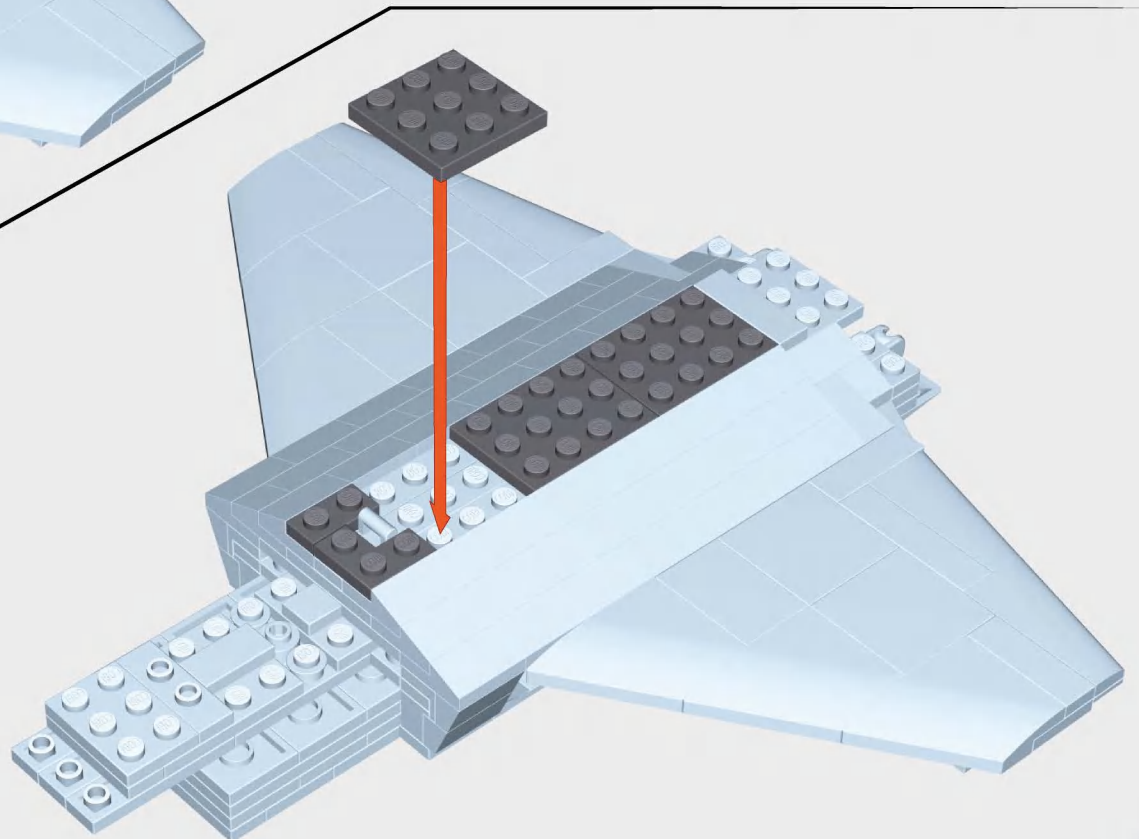
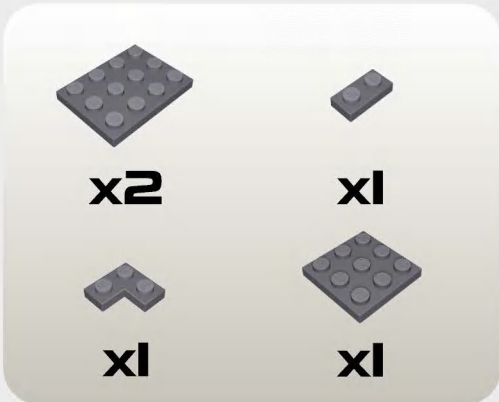

37

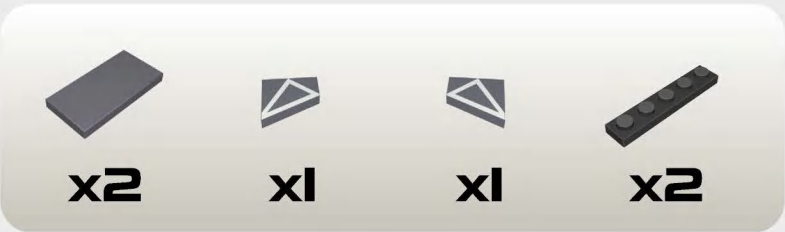
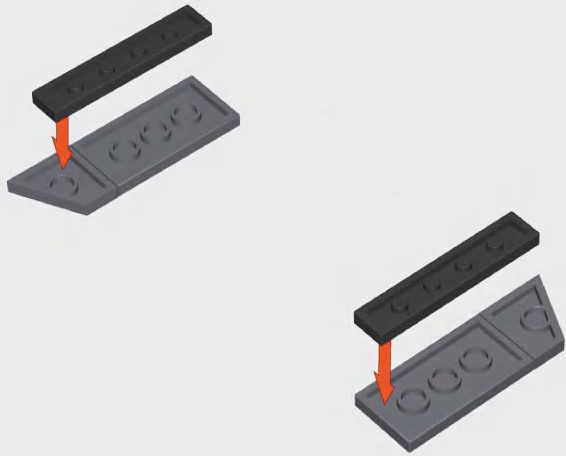

38

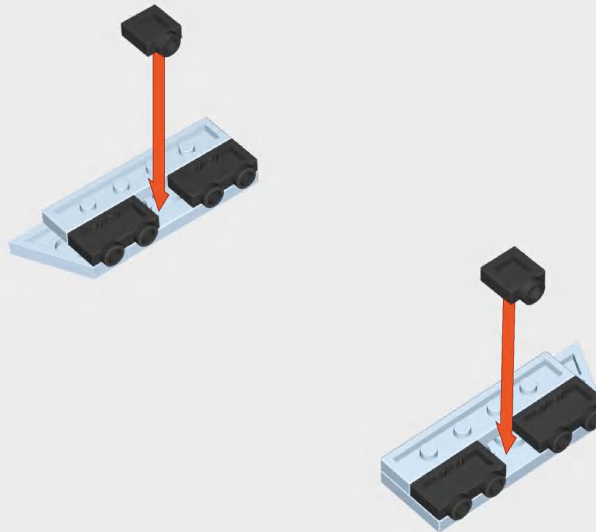

39

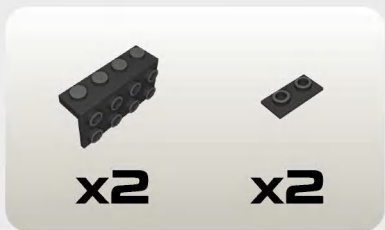
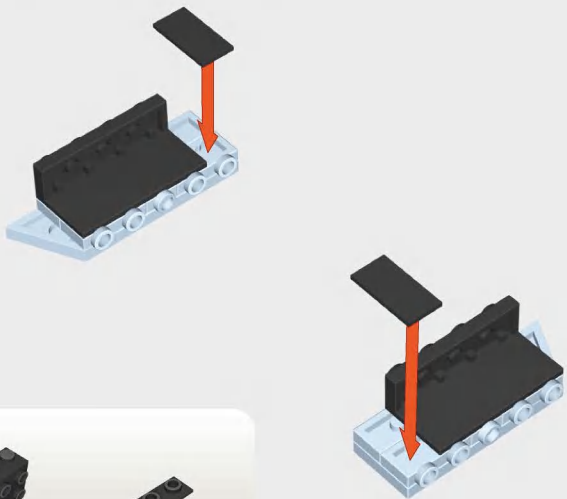

40

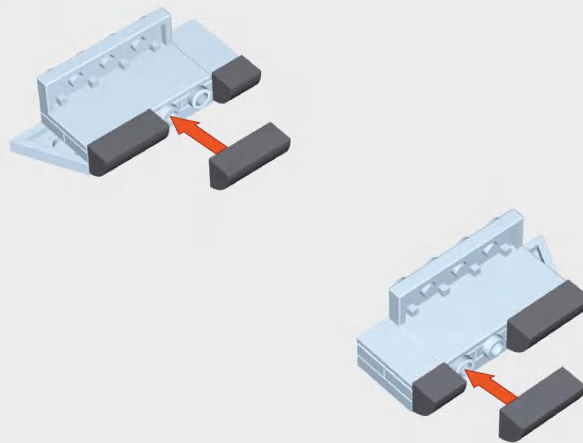

41

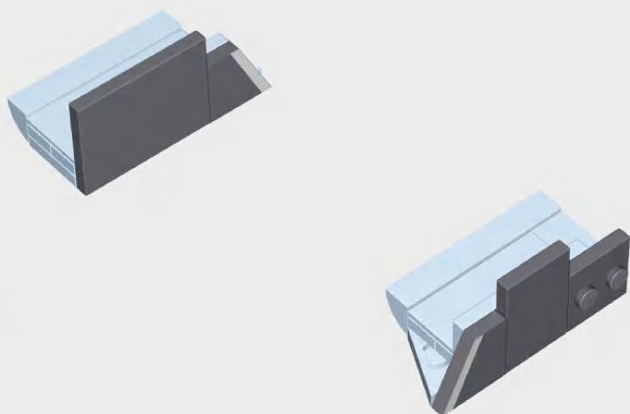

- x1
- x1
- x1
- x1
- x1

42

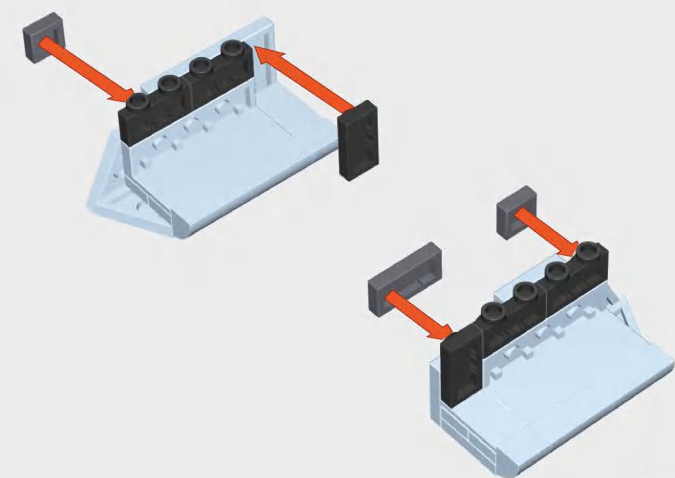

- x4
 - x2
 - x2
 - x1
- 1:1**

43

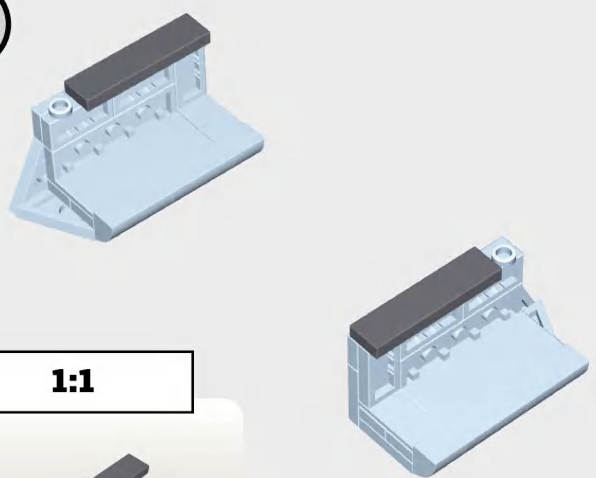

1:1

- x2

44

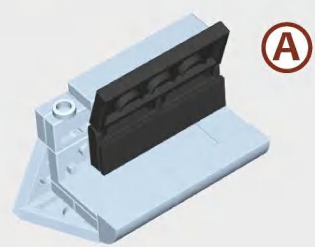

A

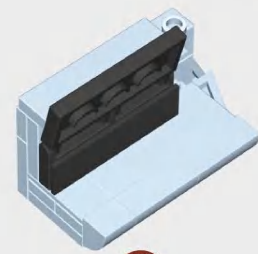

B

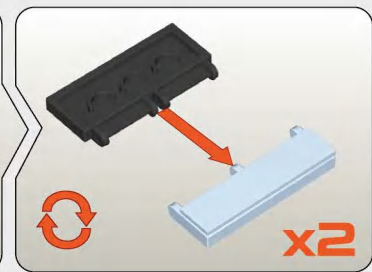
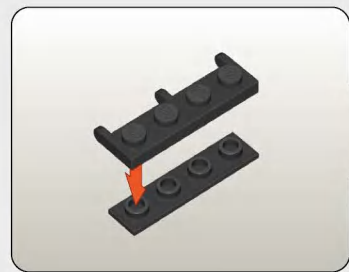

- x2
- x2
- x2

45

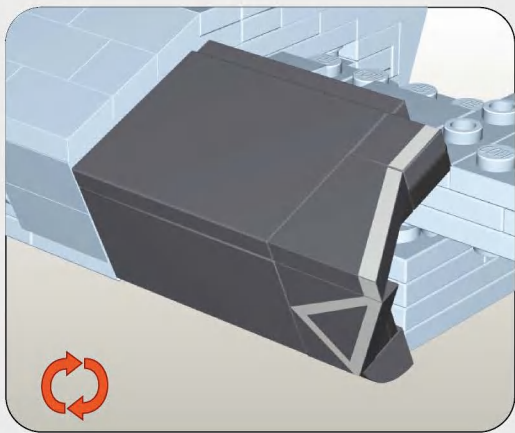
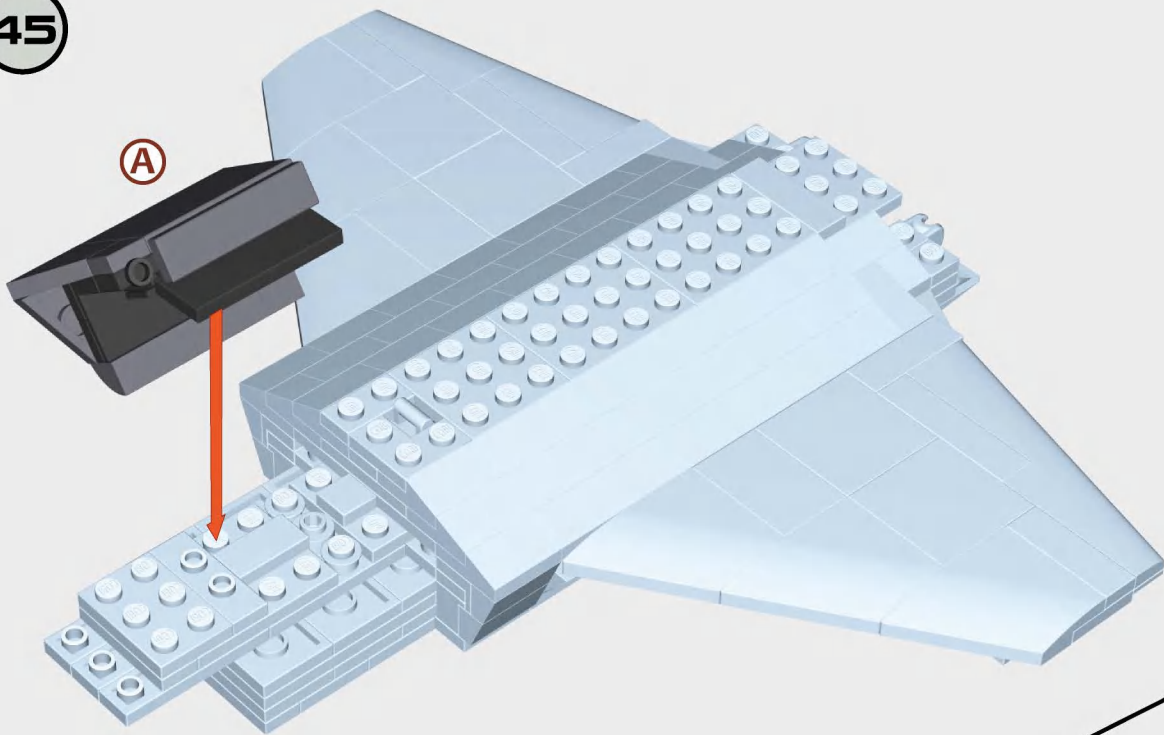

46

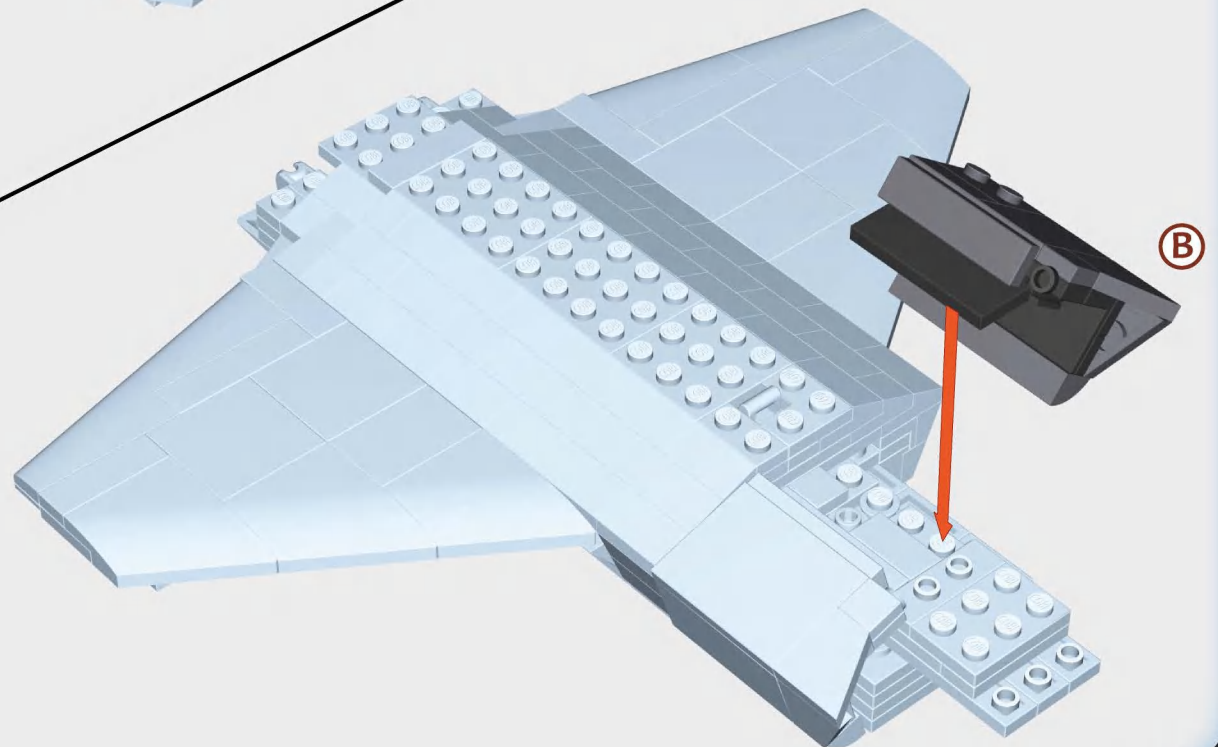
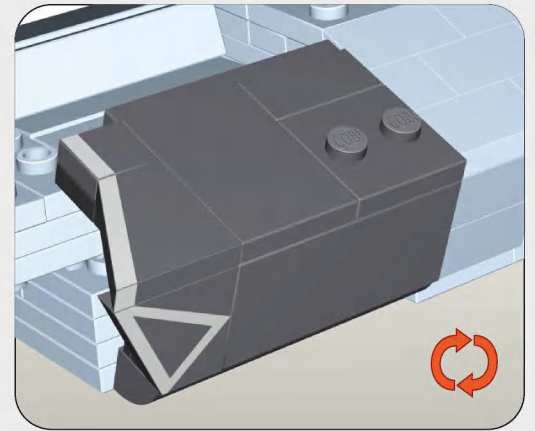

47

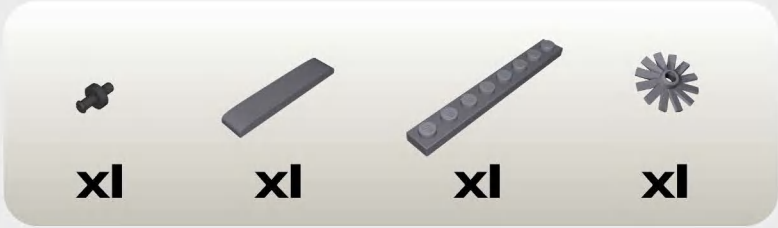
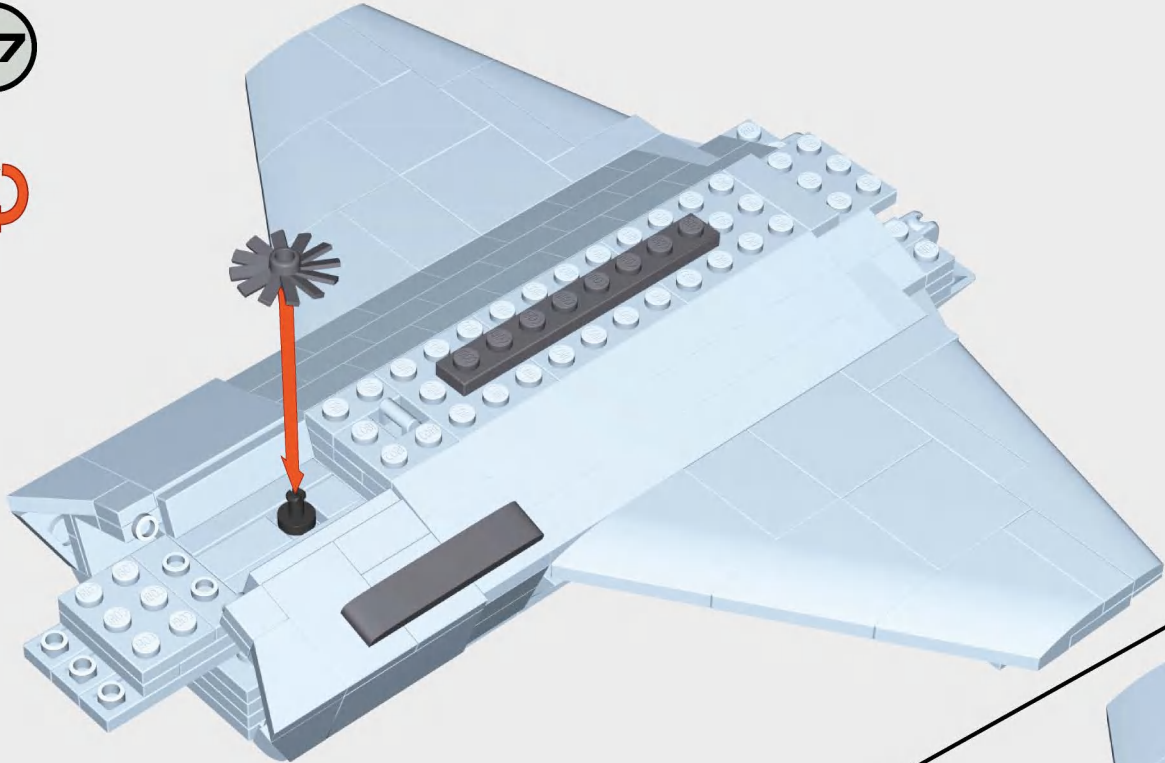



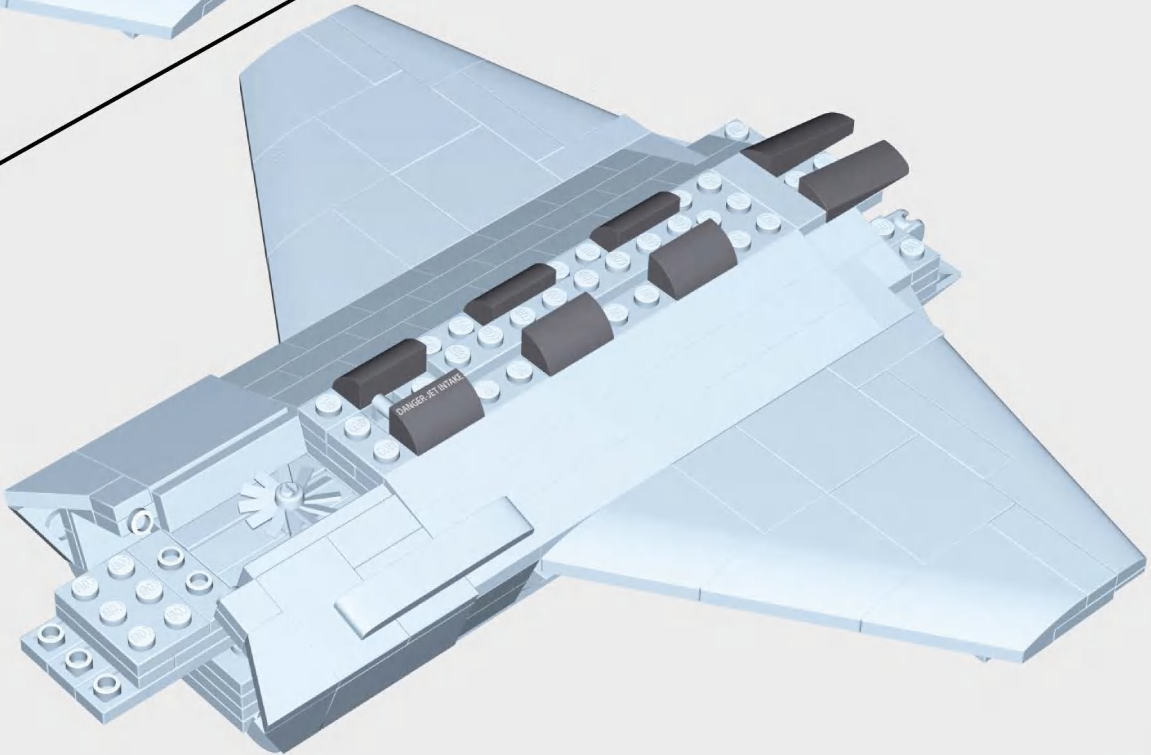
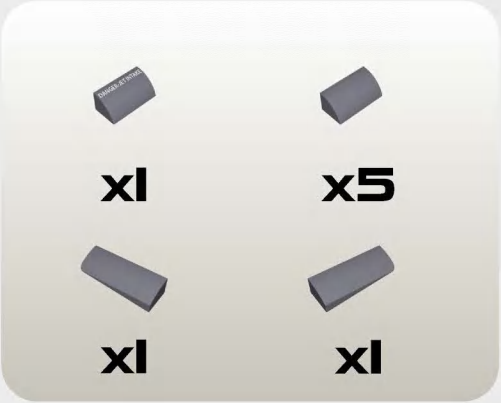

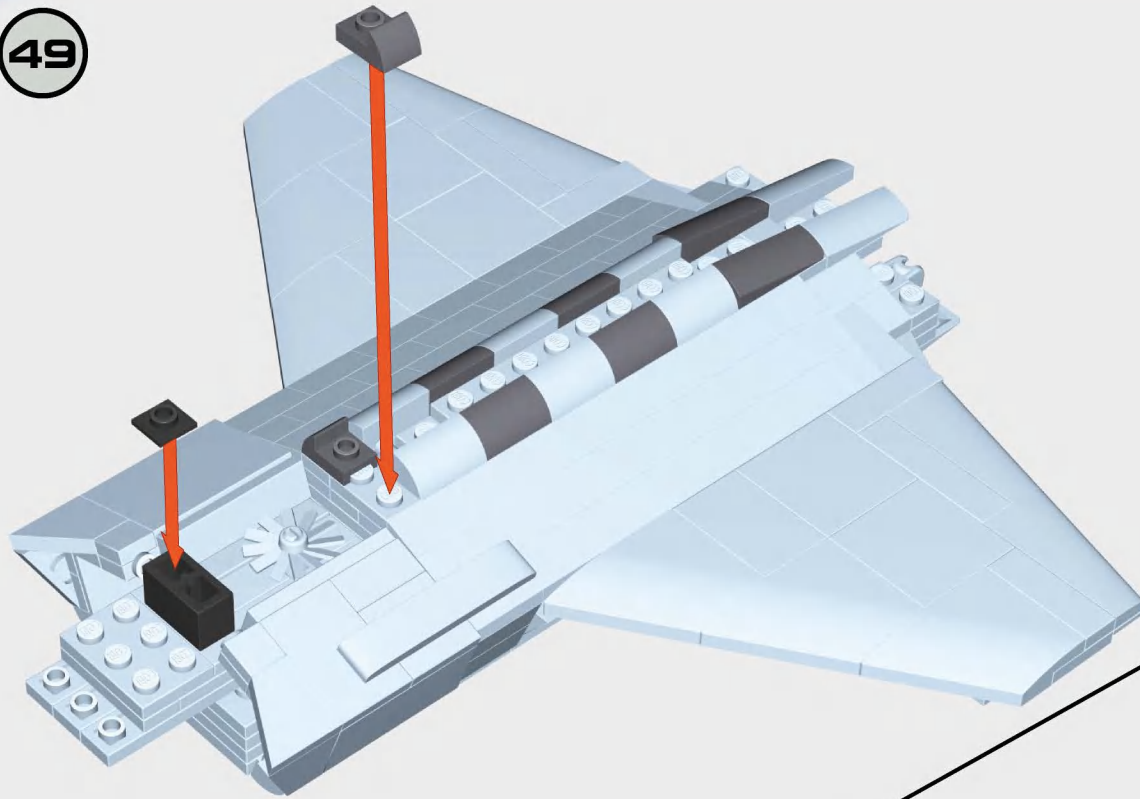

48









49



		
x1	x1	x4
		
x1	x1	x2

50

1:1

		
x1	x1	x2
		
x1	x1	x1

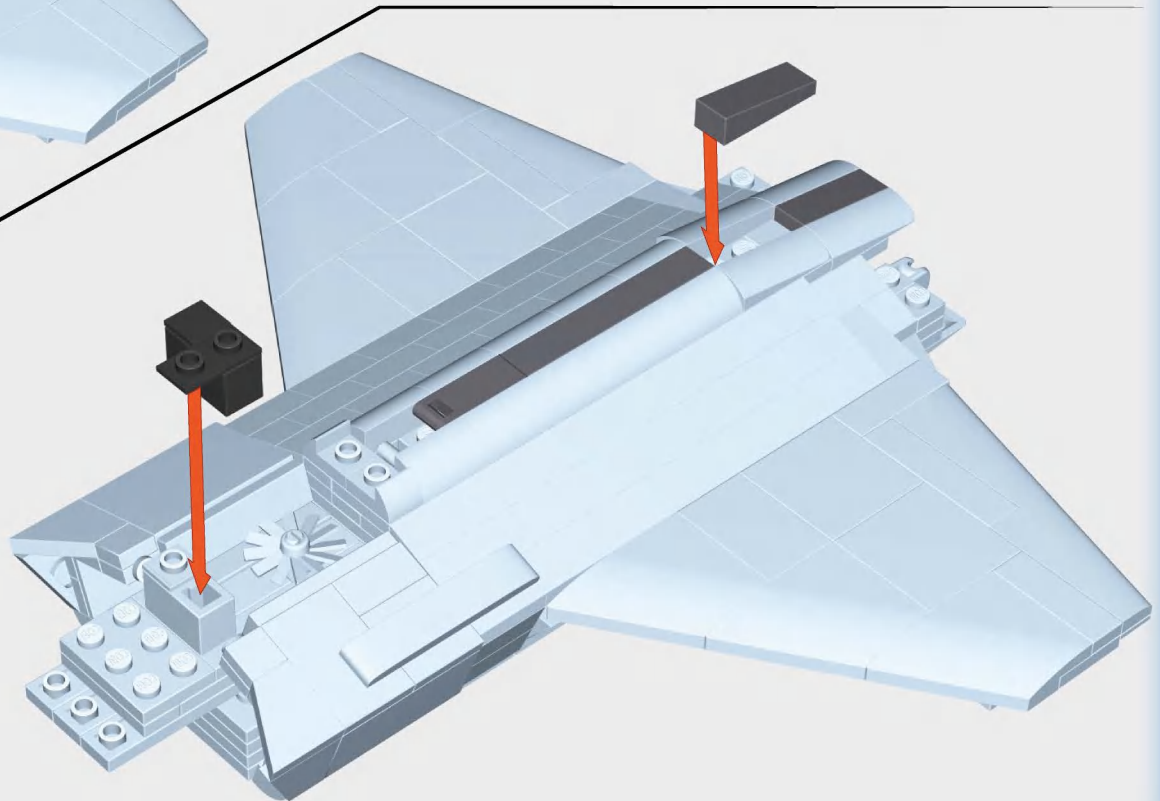
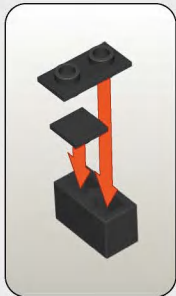

51

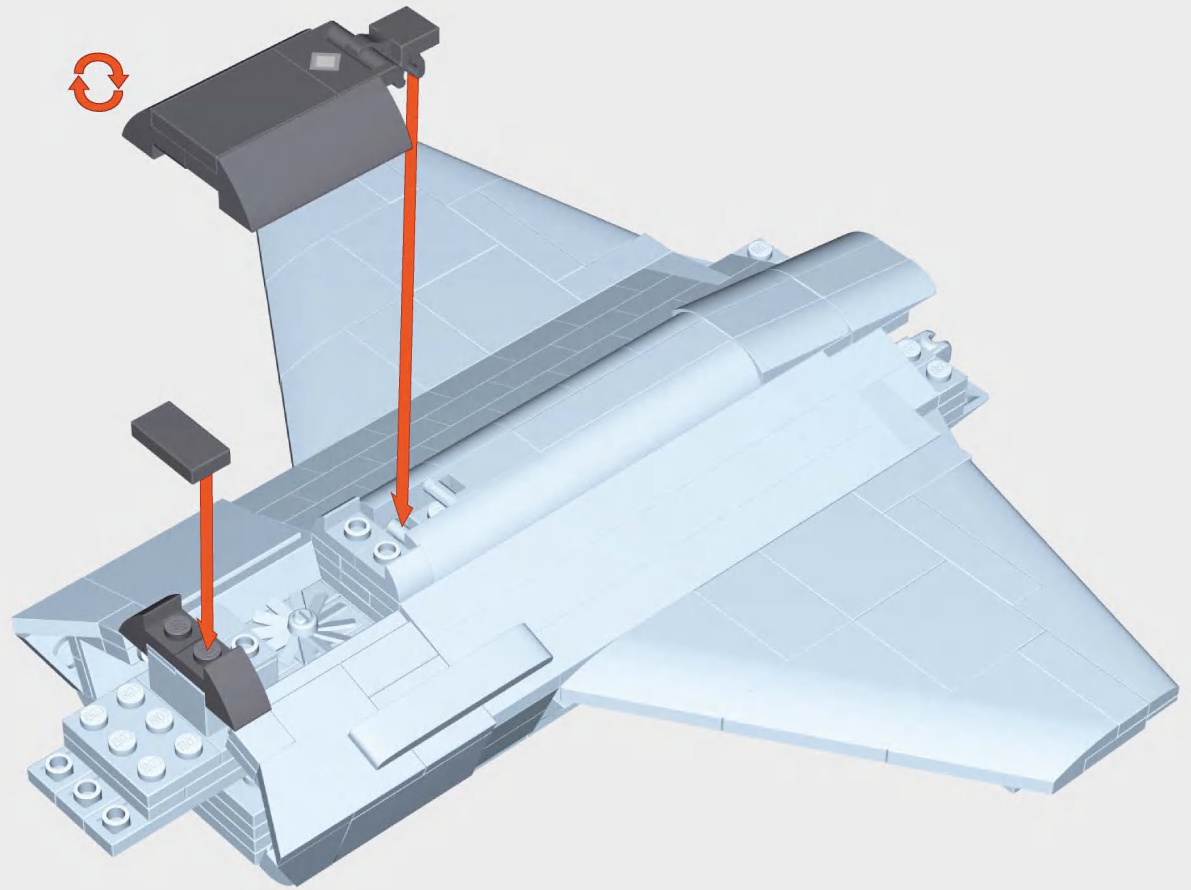
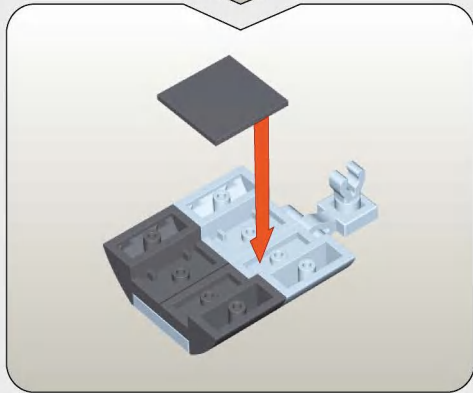
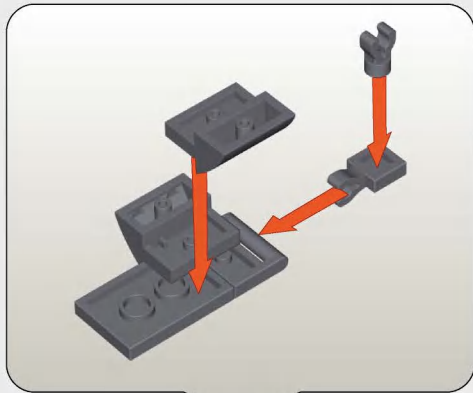

1:1



x2



x1

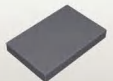

x1



x1



x4



x1





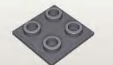



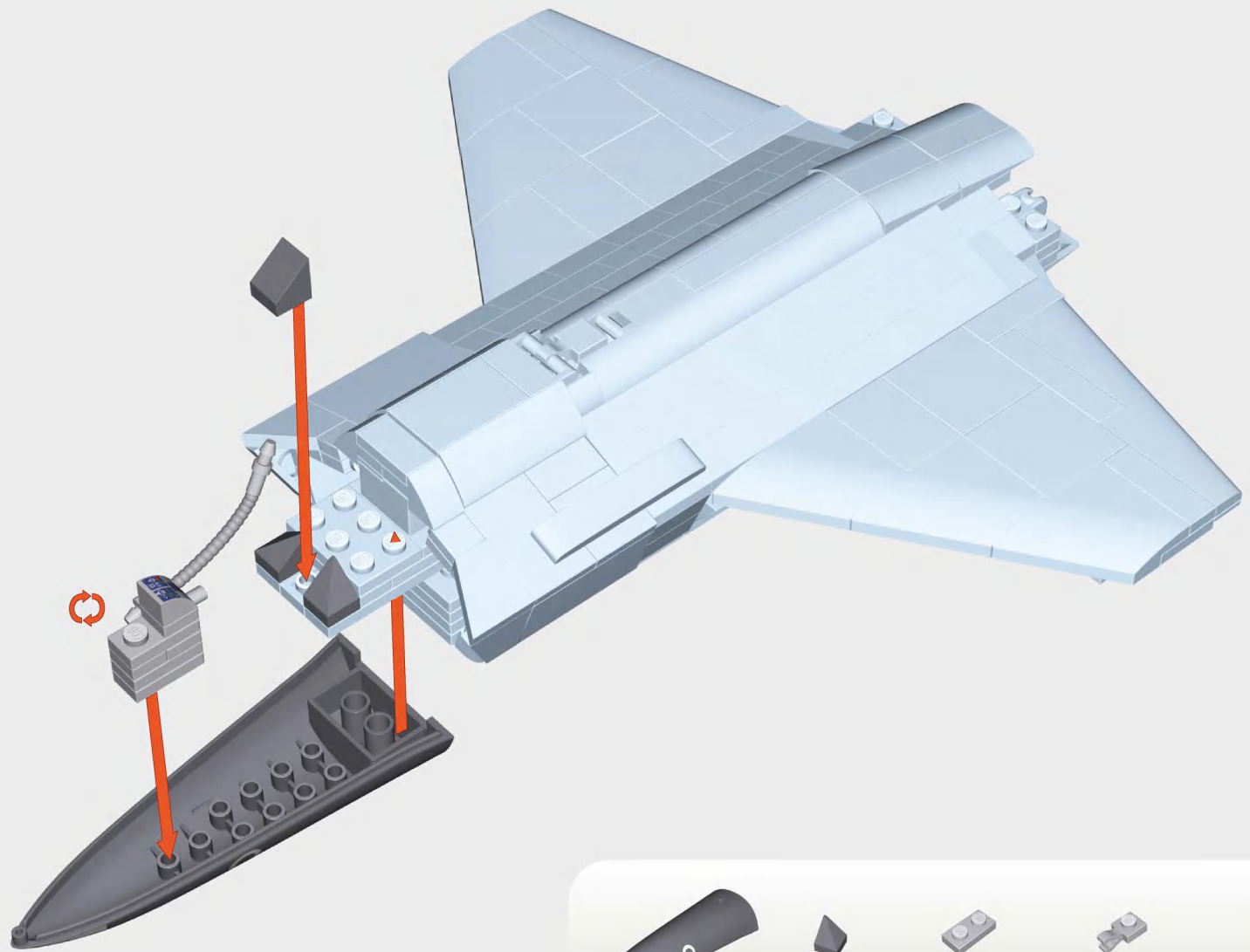
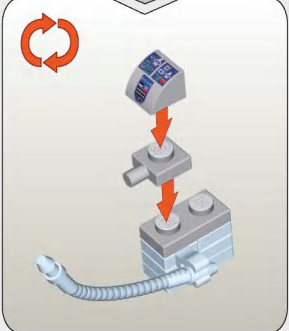
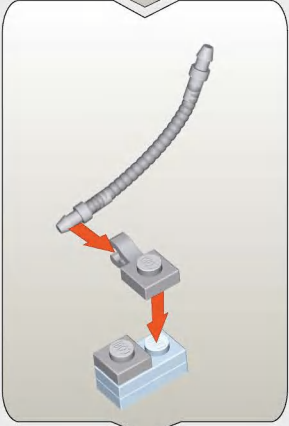
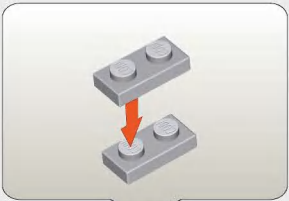

x1



x1



- | | | | | |
|---|---|---|---|---|
|  |  |  |  |  |
| x1 | x2 | x3 | x1 | x1 |
|  |  |  |  | |
| x1 | x1 | x1 | x1 | |

53

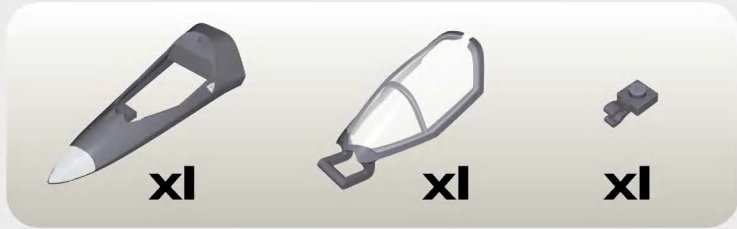
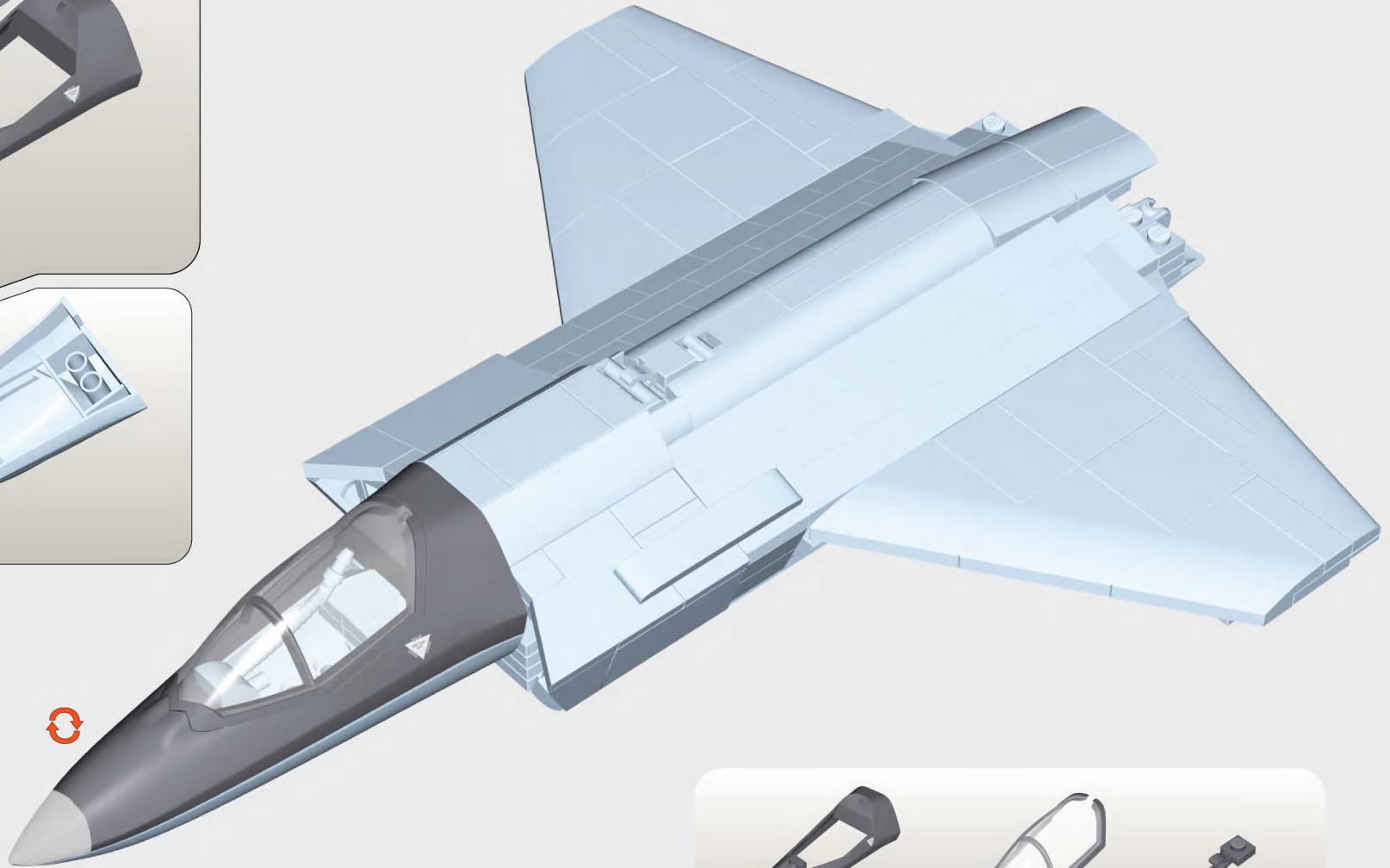
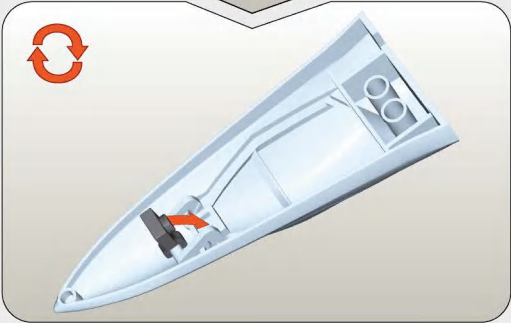

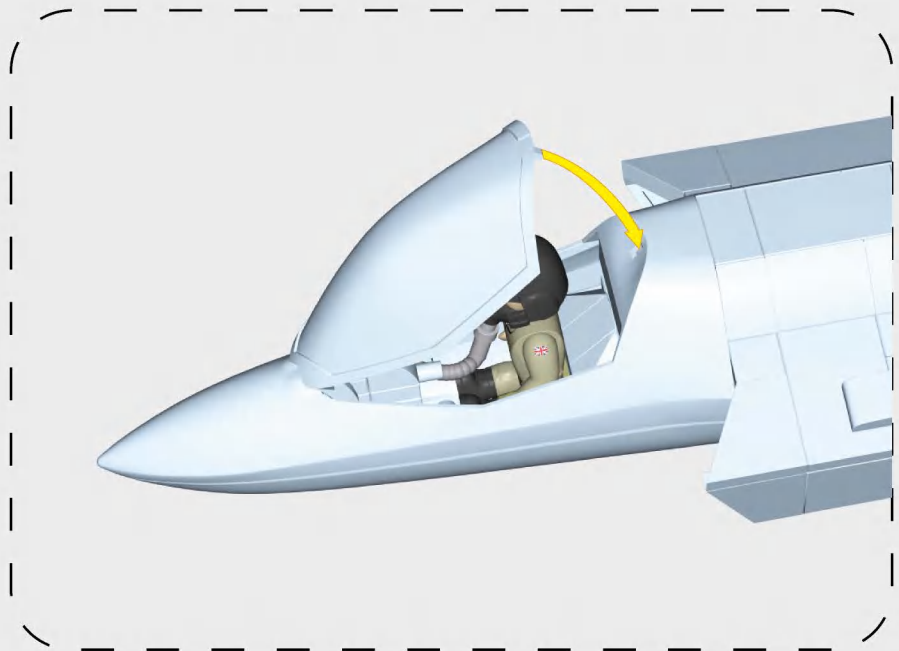
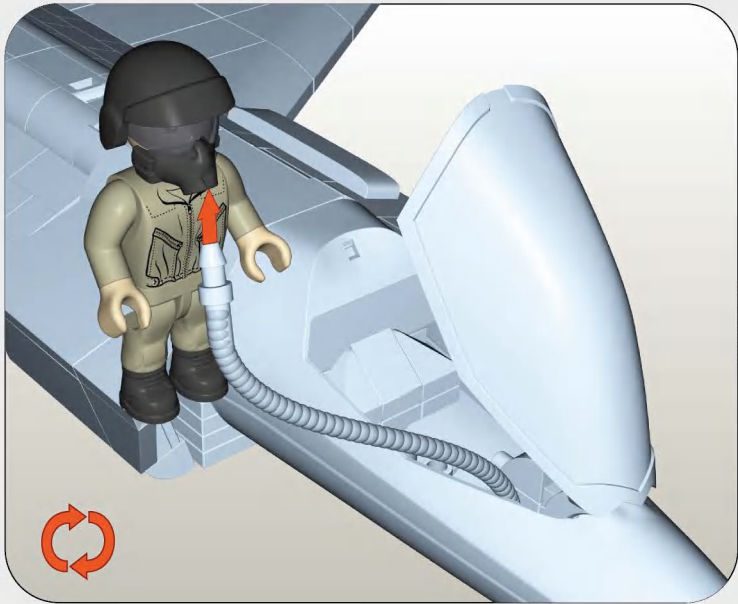
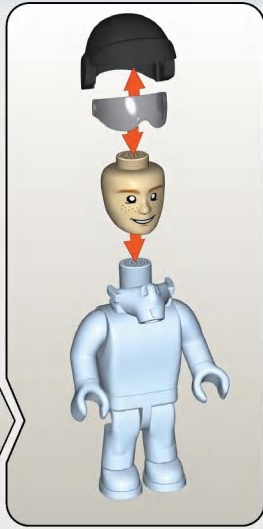
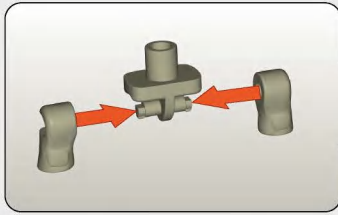

x1



x1



x1



x1



x2



x1



x1



x1



x1

55

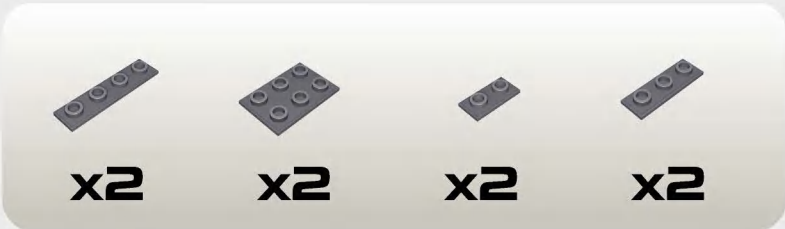
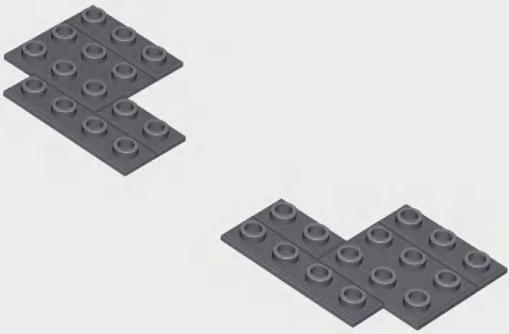

56

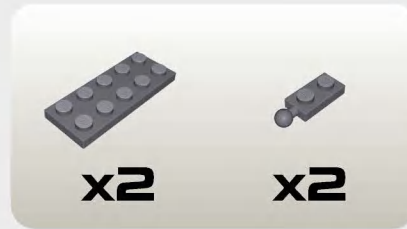
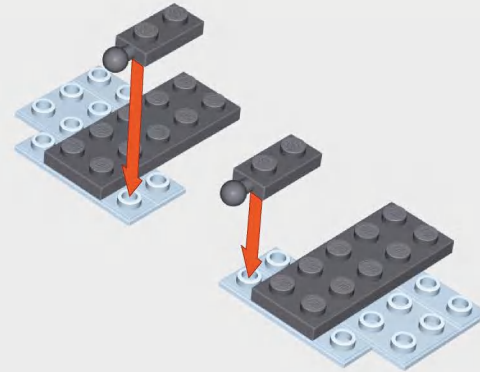

57

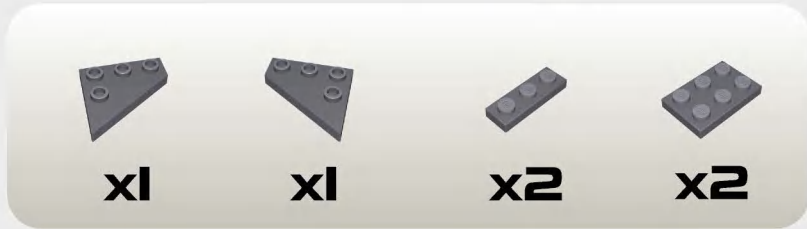
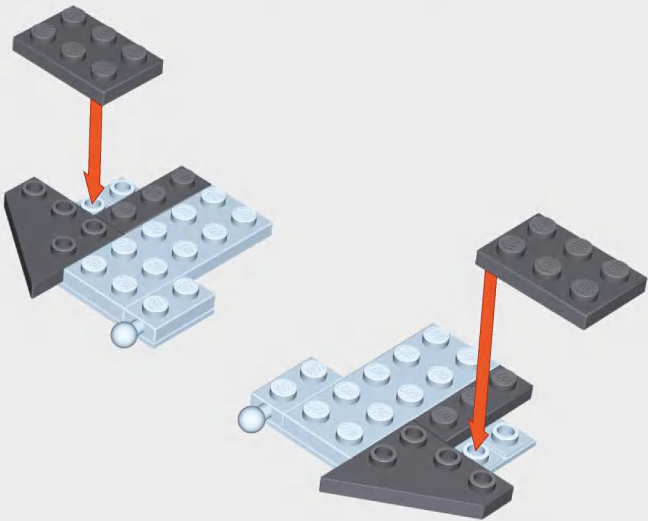

58

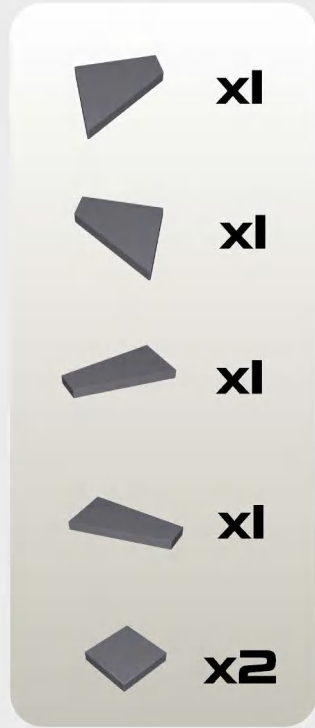
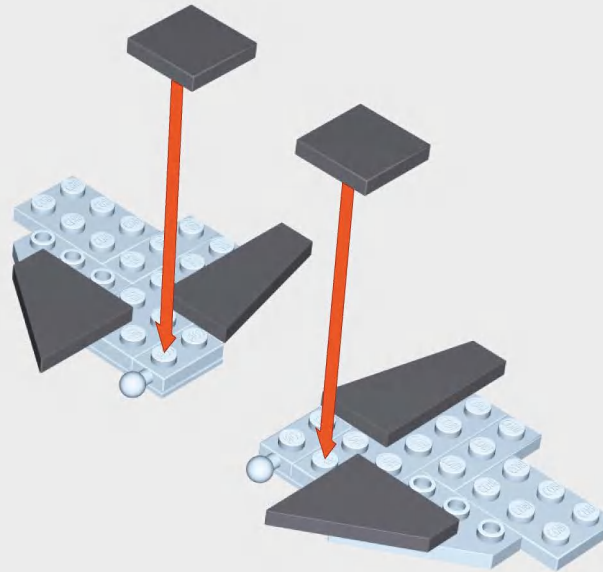

59

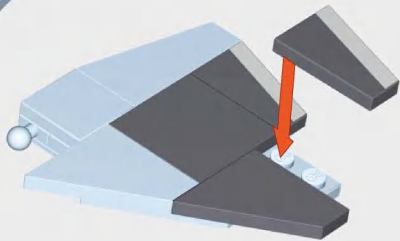
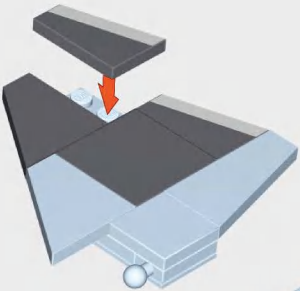

x1



x1

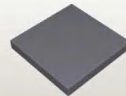

x2



x2



x2

60

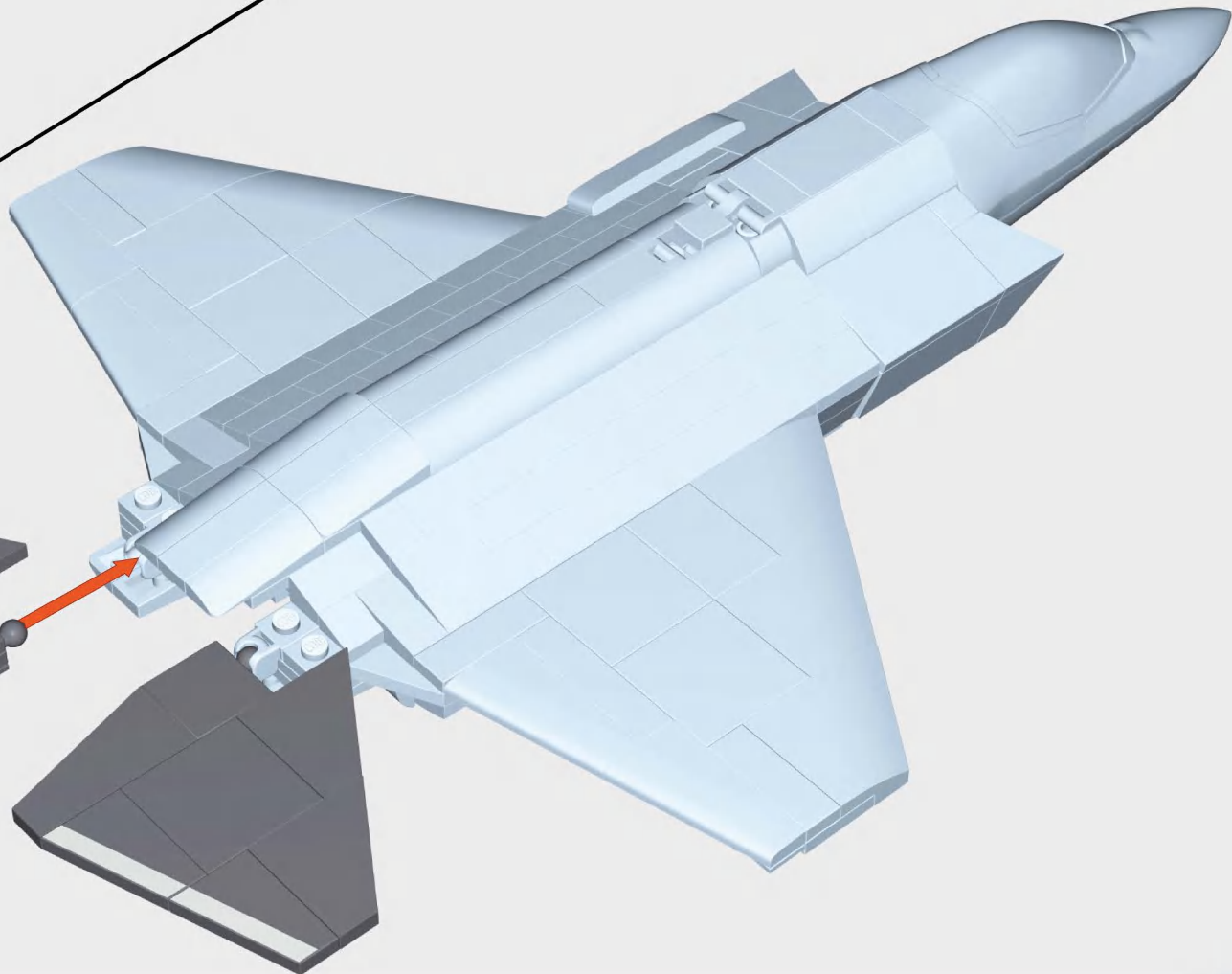
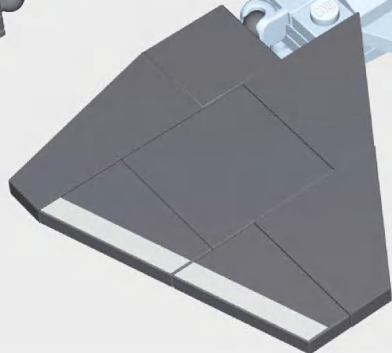
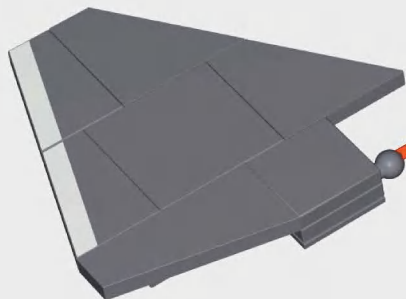

61

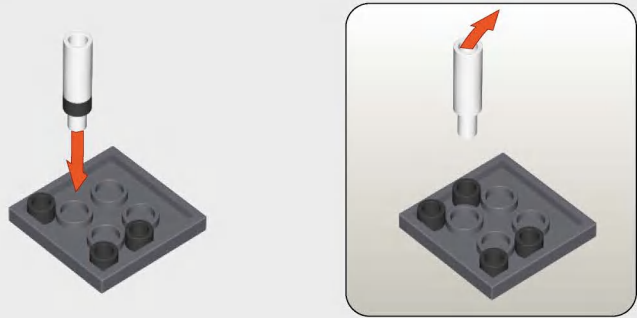

62

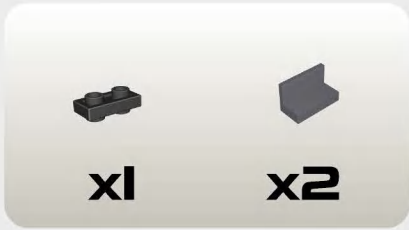
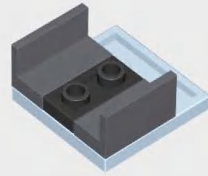

63

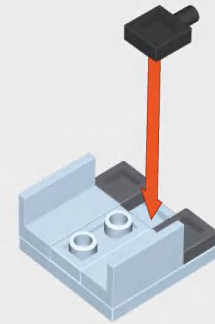

64

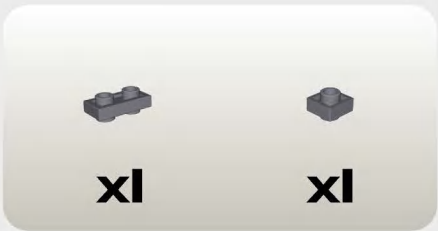
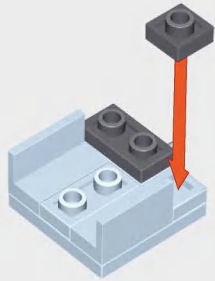

65

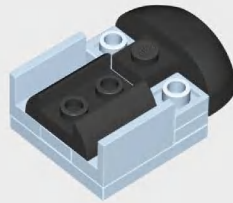

66

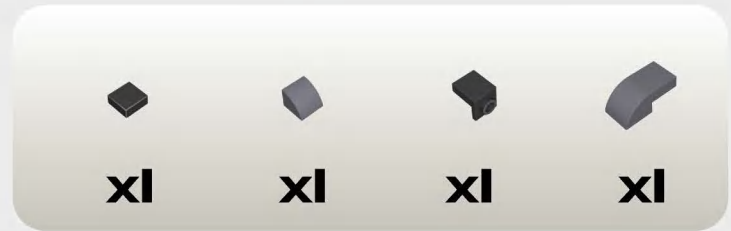
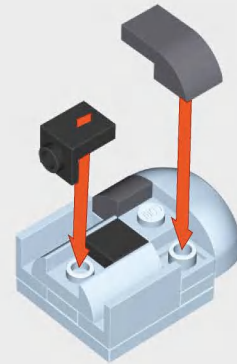

67

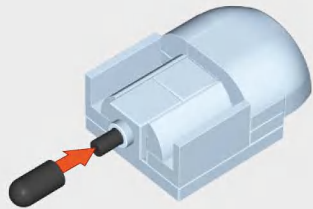

x1 x1

68

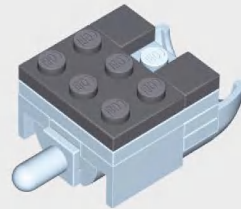

x1 x2

69



x1 x1

70

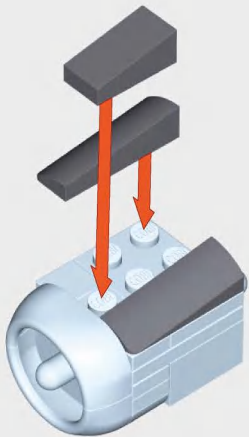

x1 x1 x1



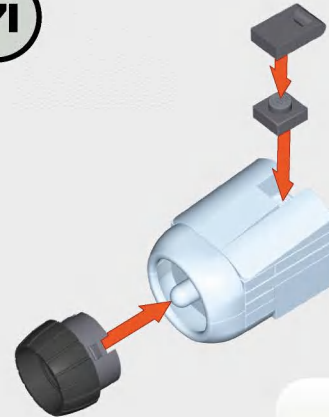

71

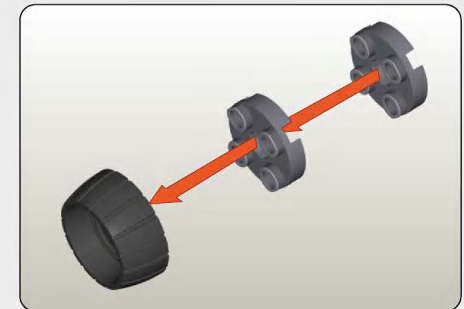

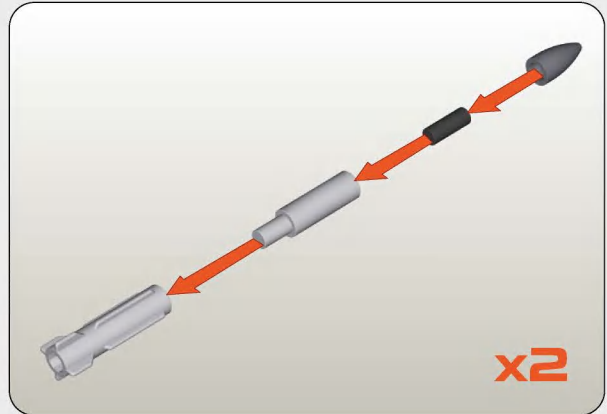
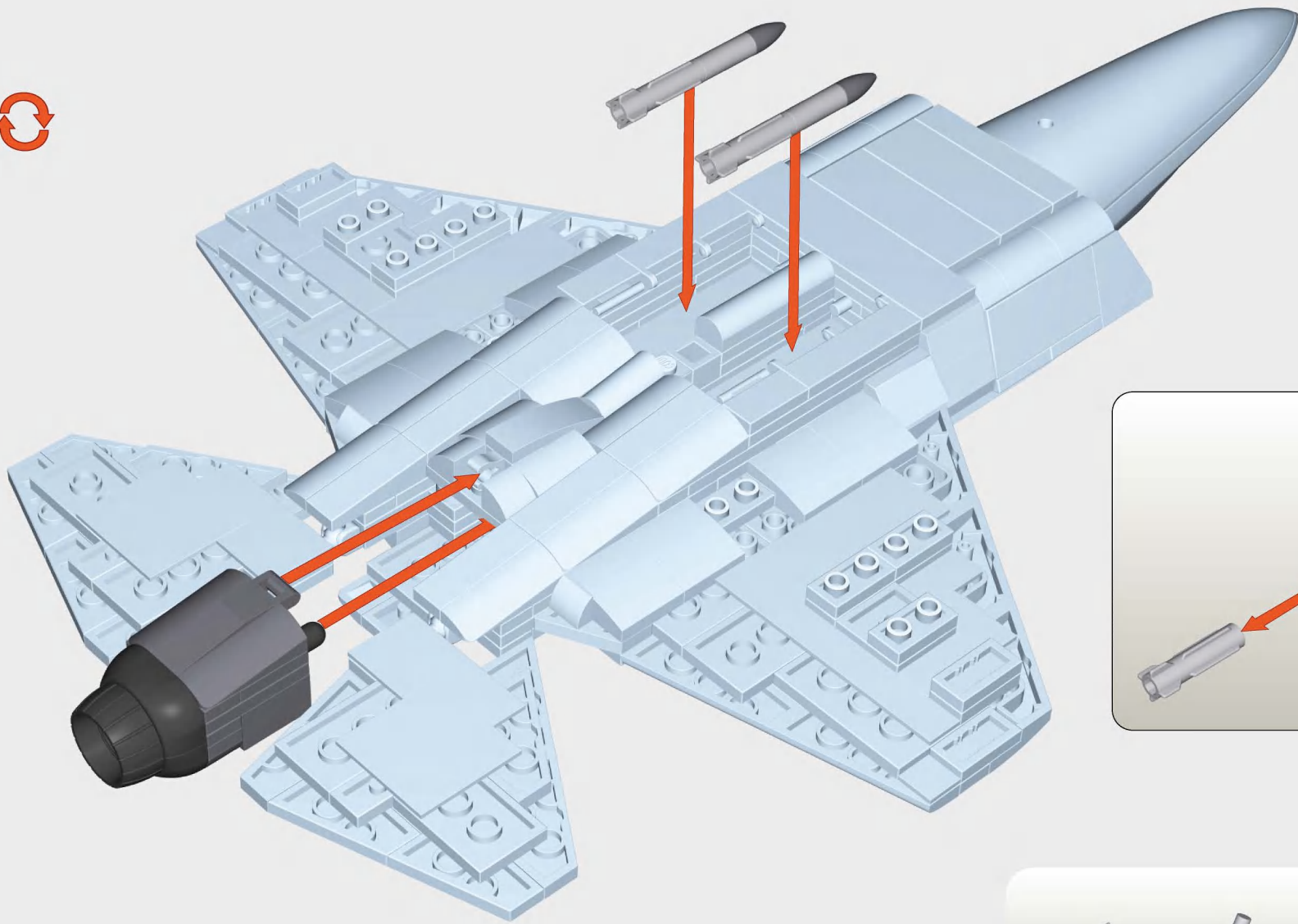





x2 x1 x1 x1

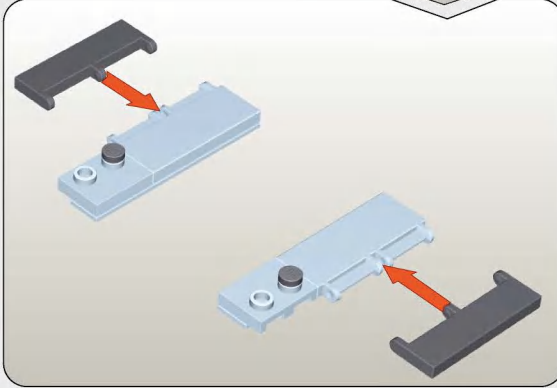
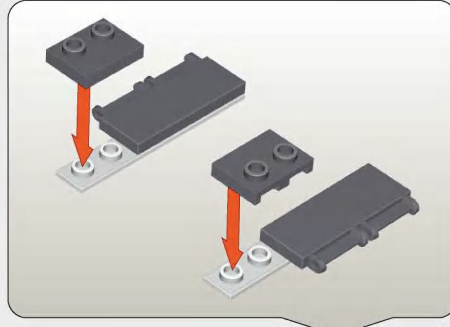
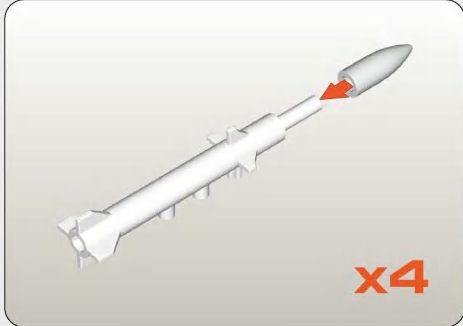
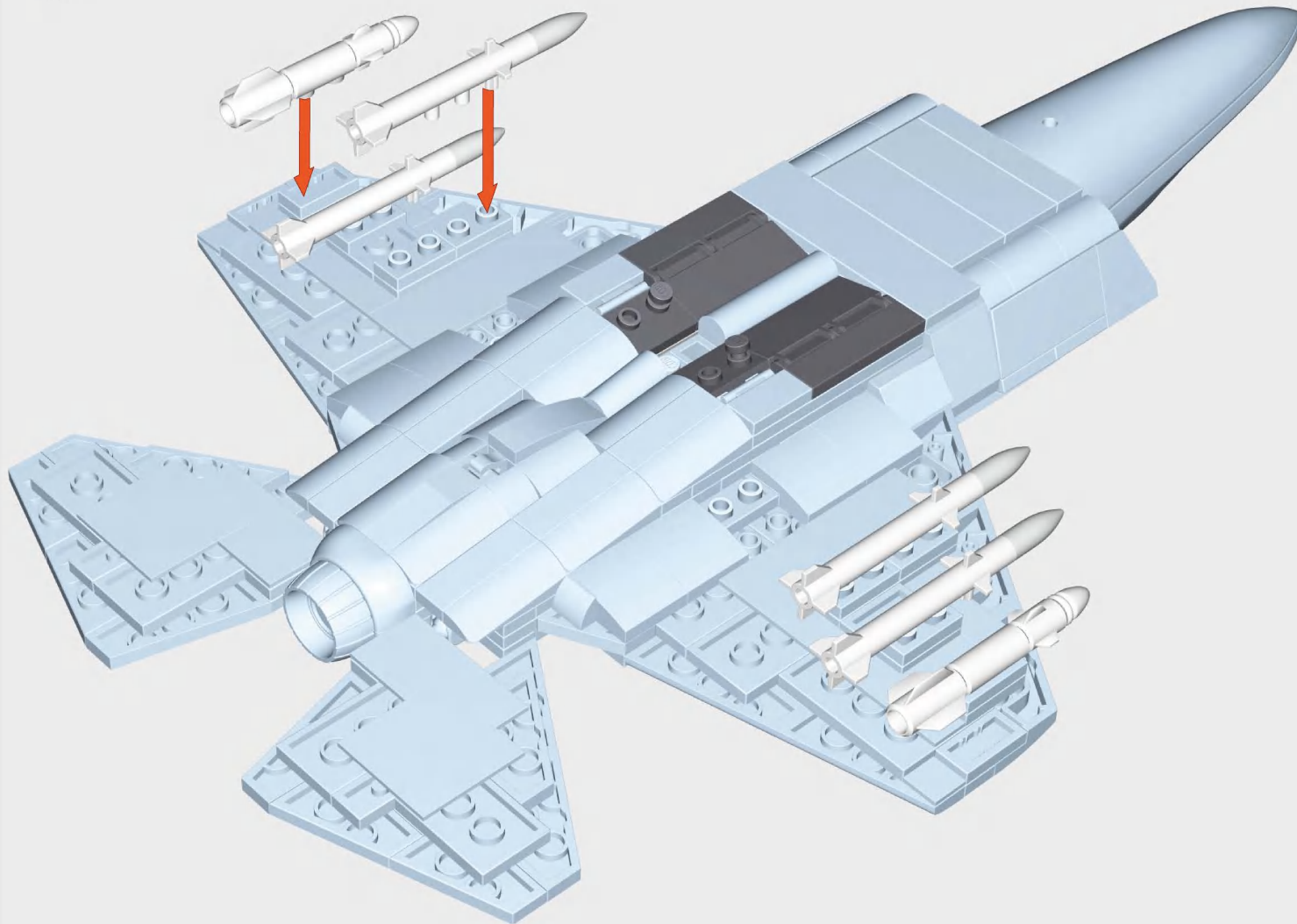



-  x2
-  x2
-  x2
-  x2



-  **x4**
-  **x4**
-  **x2**
-  **x2**
-  **x2**
-  **x2**
-  **x2**
-  **x2**

74

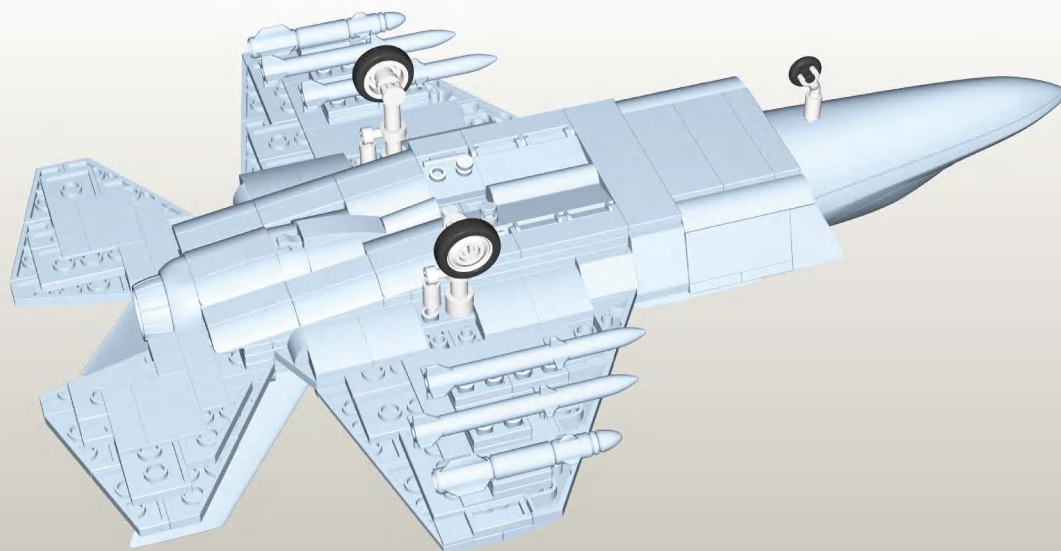

A



75

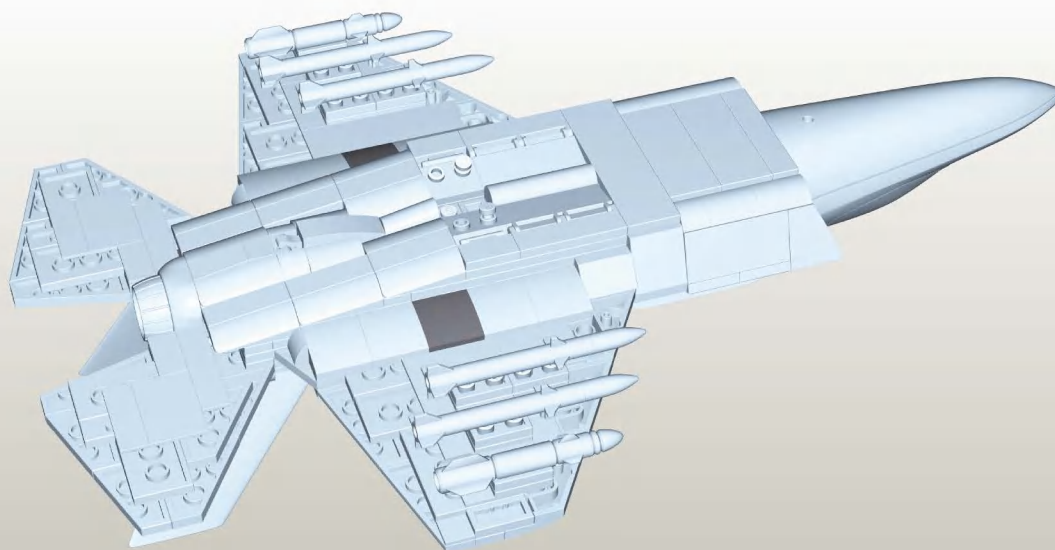

B

74 - A

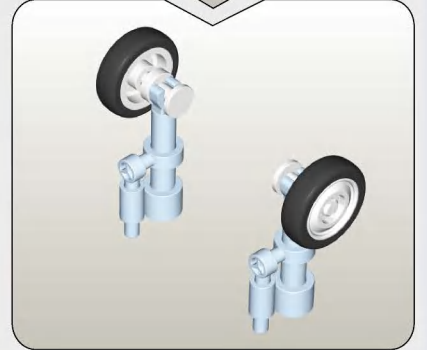
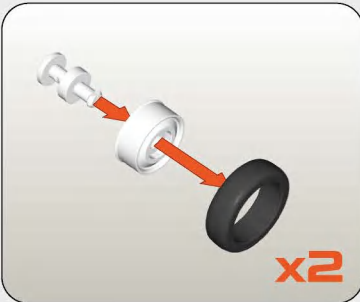
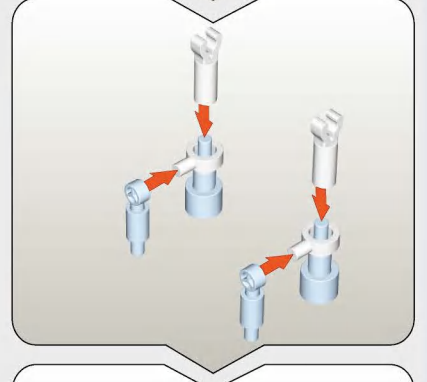
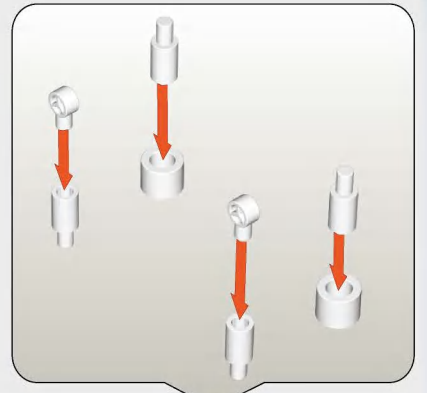
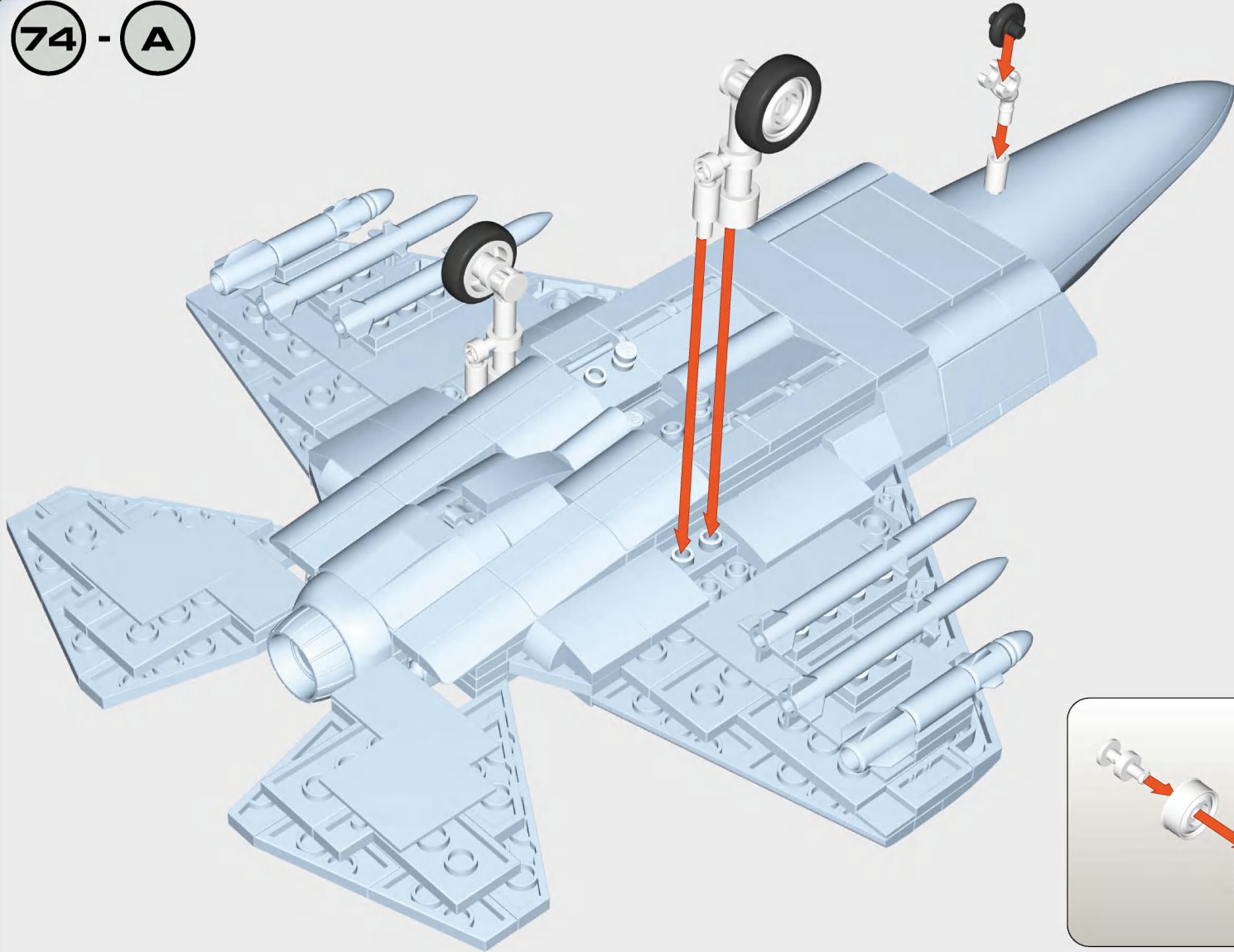

- | | | | | | | | | | |
|---|---|---|---|---|---|---|---|---|---|
|  |  |  |  |  |  |  |  |  |  |
| x1 | x1 | x5 | x2 | x2 | x2 | x2 | x2 | x2 | x2 |

75 - B

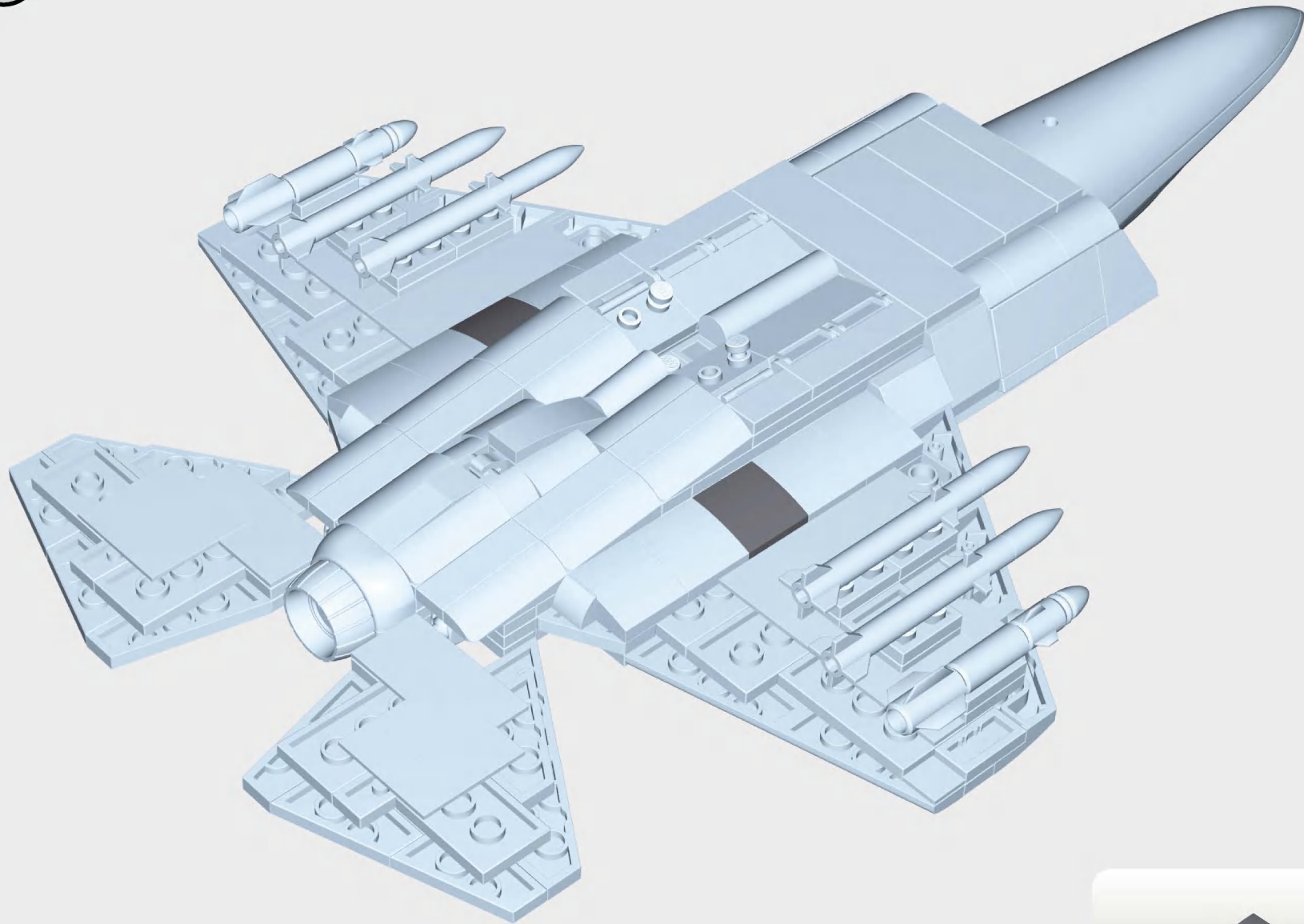

x2

76

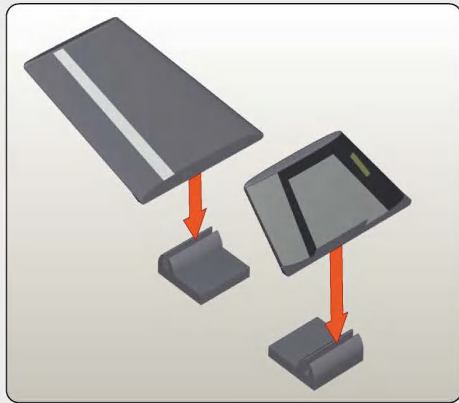
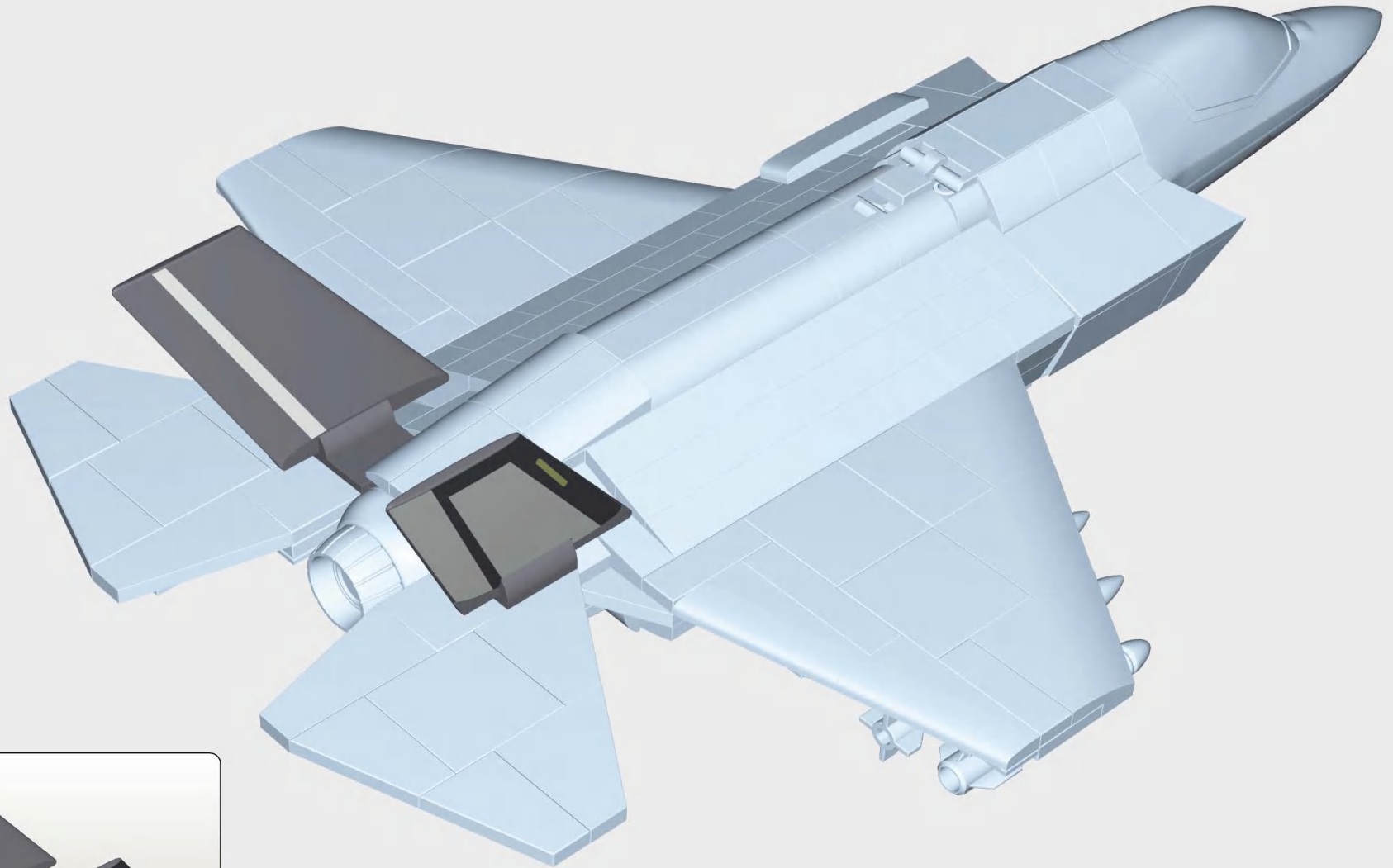

77

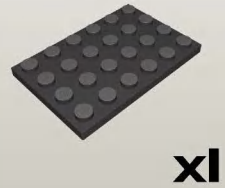

78

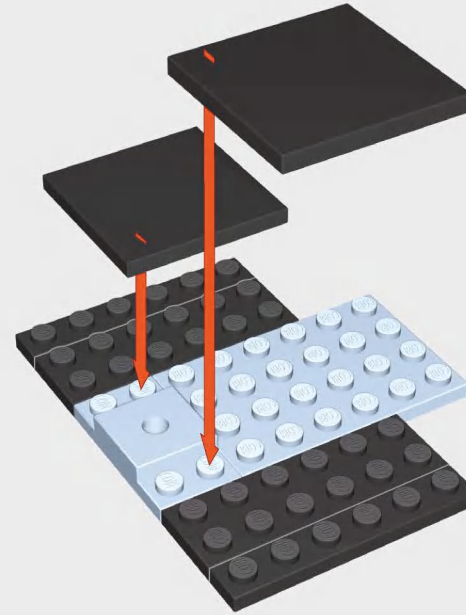

79

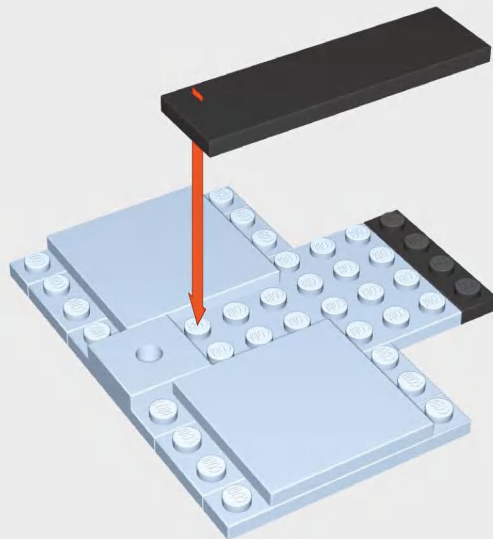

80

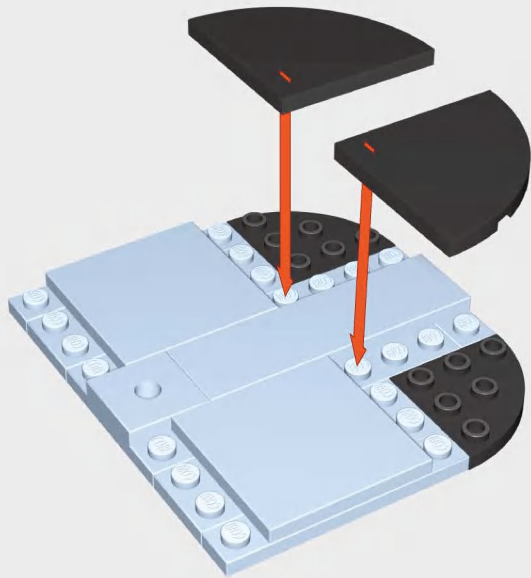

x2



x2

81

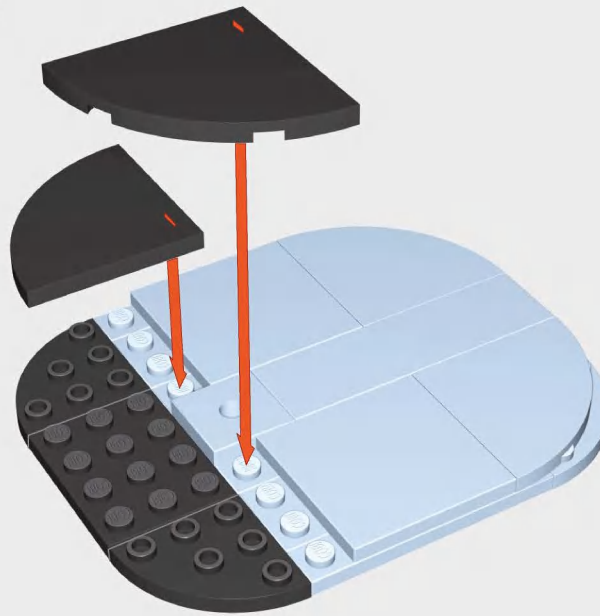

x1



x2



x2

82

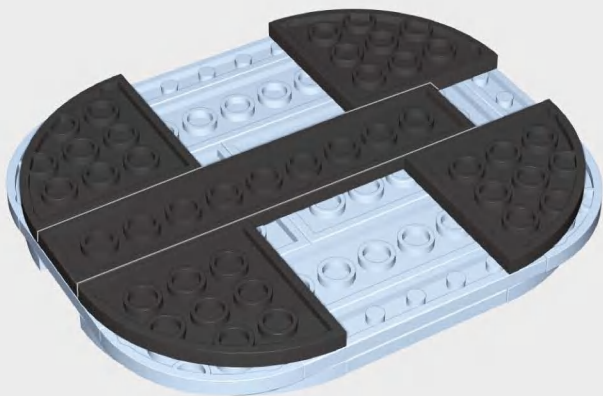

x1



x4

83



1:1

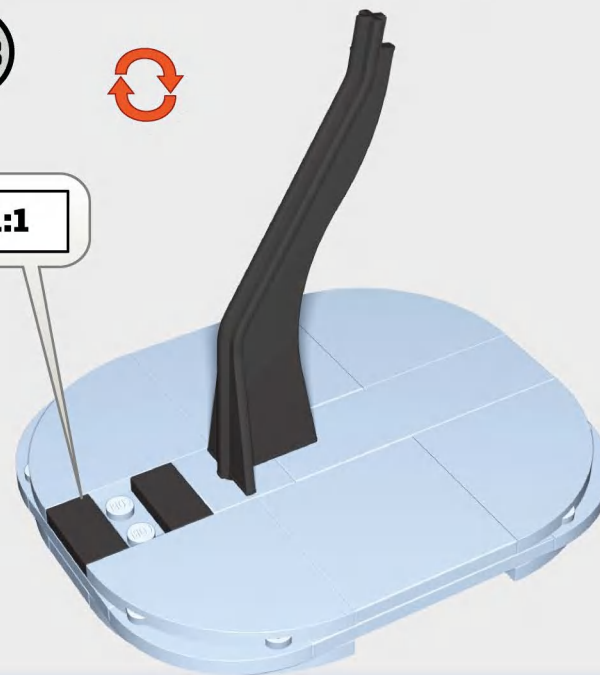

x2



x1

84 - B

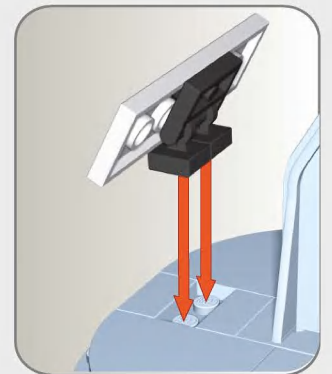
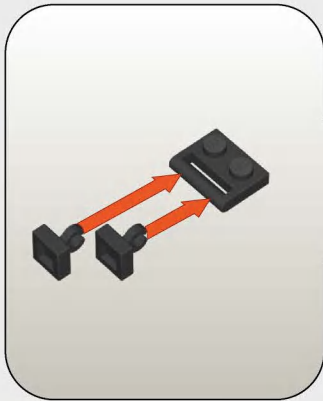
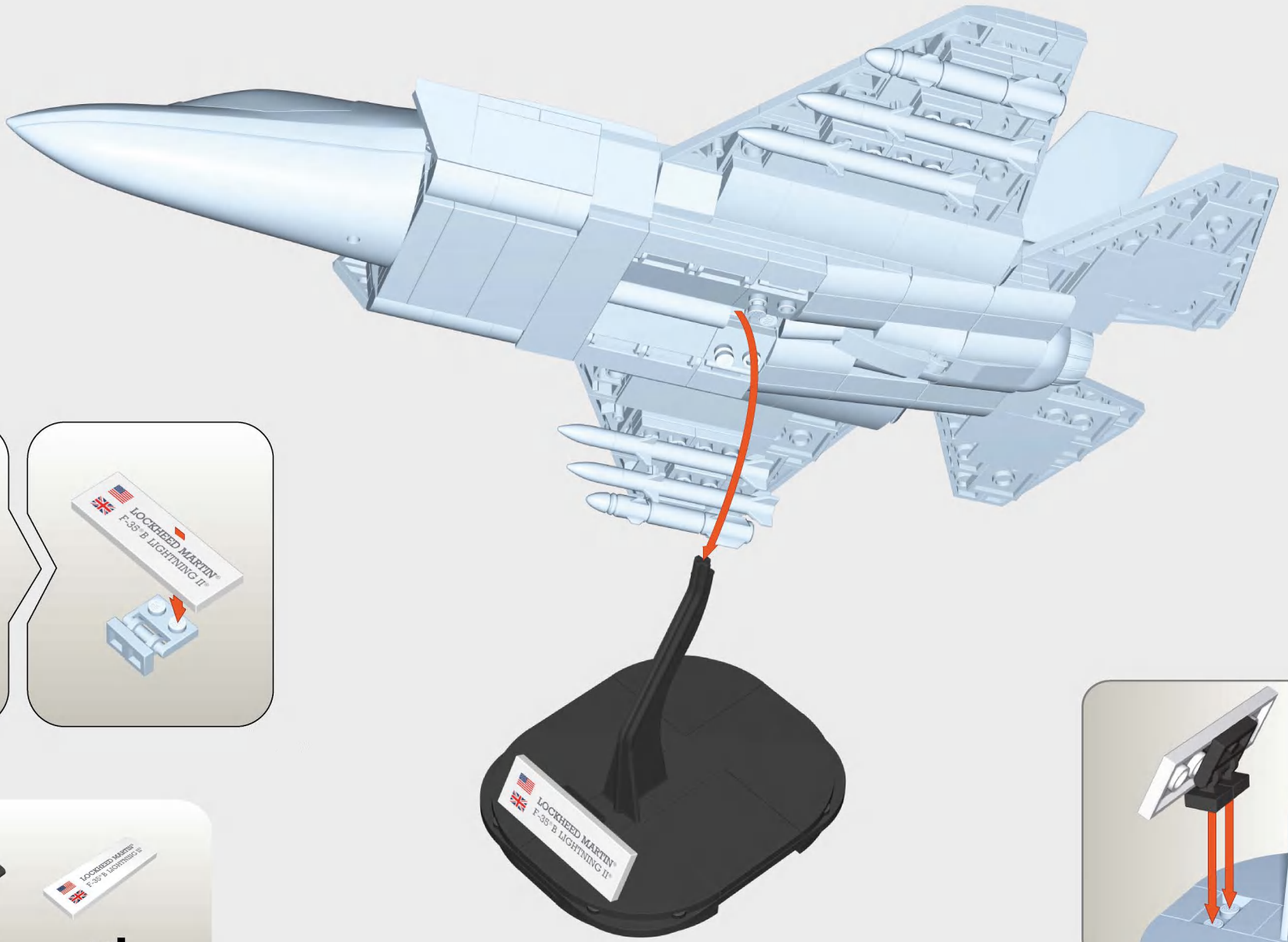

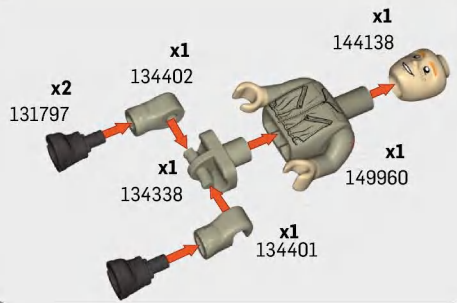

x4 140810	x2 136415	x2 138457	x2 133318	x6 54631	x1 92879	x1 43971	x2 42869	x1 101911			
x1 114598	x1 109854	x2 110966	x1 104128	x2 77422	x1 77142	x1 130711	x1 150114	x1 124771			
x2 150118	x2 42880	x5 52994	x1 131060	x2 150125	x2 44969	x2 150129	x1 110977	x5 98243	x1 150073	x1 129132	x2 129133
x4 85912	x1 57535	x1 135568	x2 132727	x1 139897	x1 112978	x2 42929	x9 51554	x2 92647	x3 43671	x1 42911	x11 57219
x2 51555	x3 45158	x2 51590	x4 100922	x2 125069	x2 141879	x8 129451	x2 131381	x2 131771	x4 111106	x2 127064	x2 42903
x1 150074	x13 112151	x4 144334	x6 97277	x2 51592	x1 140767	x3 84308	x2 109024	x10 109698	x1 133043	x6 57130	x2 92652
x5 94600	x1 115501	x7 120189	x7 120190	x1 134110	x4 108984	x1 42974	x3 51558	x7 63852	x5 93279	x2 99625	x4 64409
x2 44061	x2 128274	x1 104716	x2 134106	x2 129130	x2 64212	x2 67314	x1 92887	x1 118618	x1 89055	x2 43015	x3 51561
x1 92654	x1 85120	x2 134794	x3 51594	x6 51597	x8 53205	x8 92662	x2 117620	x9 53201	x4 92884	x2 106154	x2 112618





Produced under license from Boeing. Boeing and F/A-18 Hornet are trademarks of The Boeing Company.



F/A-18C HORNET™
5819



F-16® D FIGHTING FALCON®
5815



LOCKHEED MARTIN®, F-16®D Fighting Falcon®, F-35®B Lightning II®, associated emblems and logos, and body designs of vehicles are either registered trademarks or trademarks of Lockheed Martin Corporation in the USA and/or other jurisdictions, used under license by COBI.



F-16®C FIGHTING FALCON®
5814



LOCKHEED MARTIN®, F-16®C Fighting Falcon®, associated emblems and logos, and body designs of vehicles are either registered trademarks or trademarks of Lockheed Martin Corporation in the USA and/or other jurisdictions, used under license by COBI.



F-35®B LIGHTNING II®
5829

WWW.COBI.EU

For news and special deals

Find us on:
f cobricks
cobi.klocki
COBI SA

17-05830-592

