

HISTORICAL COLLECTION

WORLD WAR II

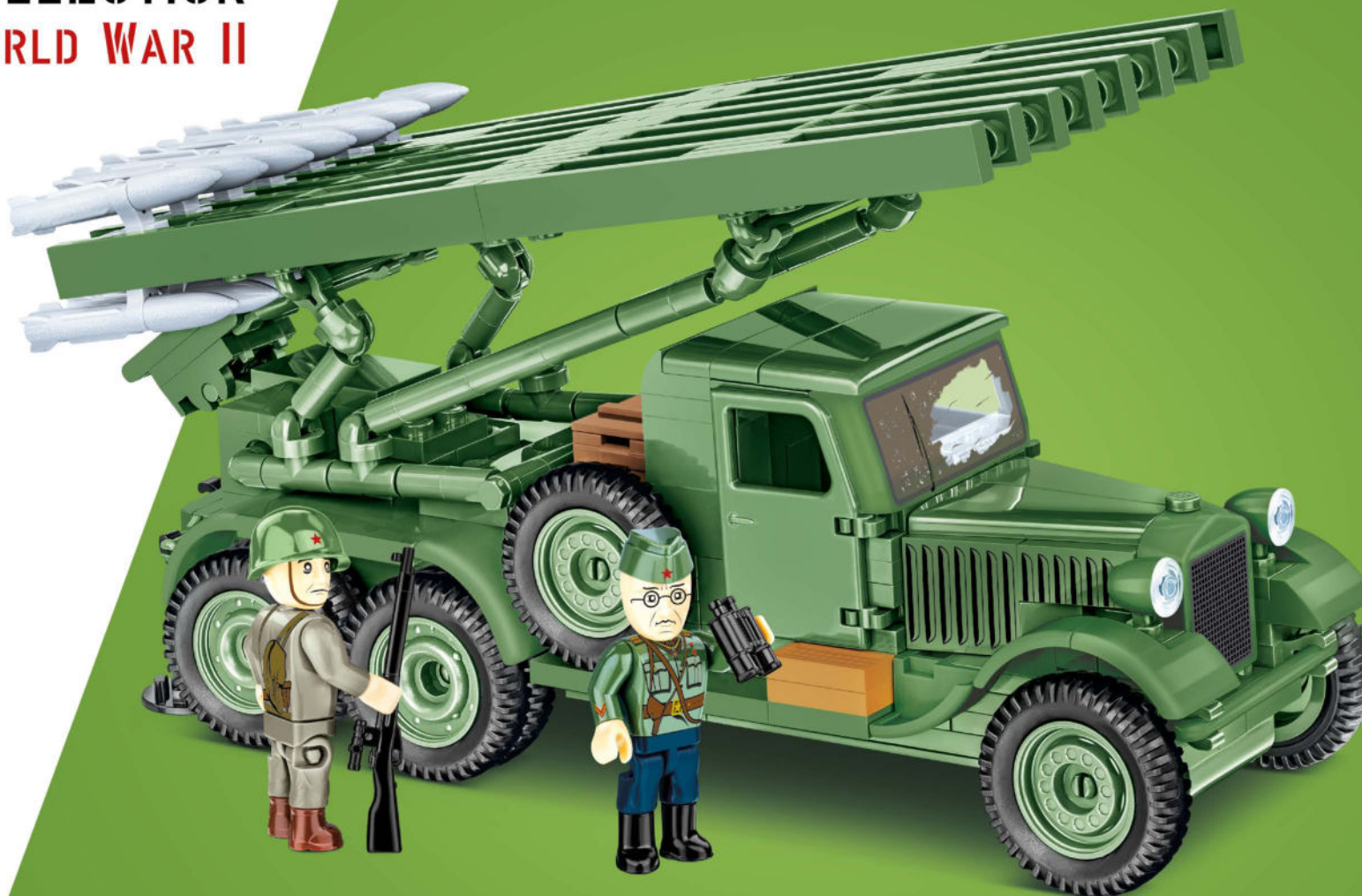

BM-13 KATYUSHA
 IN SERVICE - 1941 - 1945
 PLACE OF ORIGIN - SOVIET UNION
 TYPE - MULTIPLE ROCKET LAUNCHER
 AMMUNITION - 16x 132mm (5.2") M-13 ROCKET

ZIS-6
 IN SERVICE - 1933 - 1940s
 PLACE OF ORIGIN - SOVIET UNION
 TYPE - TRUCK
 LENGTH - 6,06m (19' 10")
 WIDTH - 2,23m (7' 4")
 WEIGHT - 4230kg (9325LB)
 ENGINE - SIX-CYLINDER ZIS-5, 54kW (73HP)
 MAXIMUM SPEED - 55KM/H (34MPH) ★

2280

PAD PRINTED
NO STICKERS

Printed in EU



WARNING: CHOKING HAZARD-
 Toy contains small parts.
 Not for children under 3 years.

440 2

BM-13 KATYUSHA (ZIS-6)

SCALE 1:35

1

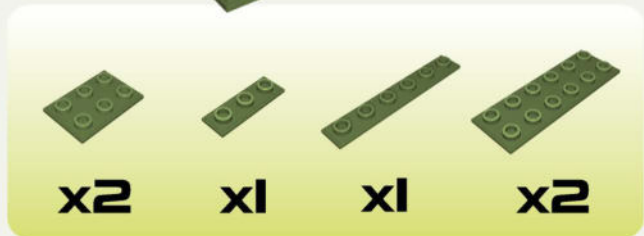
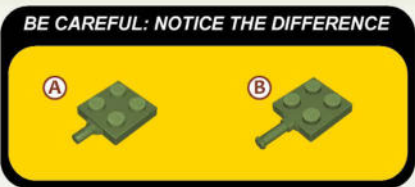
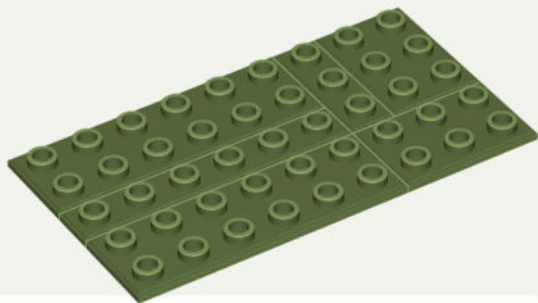

2

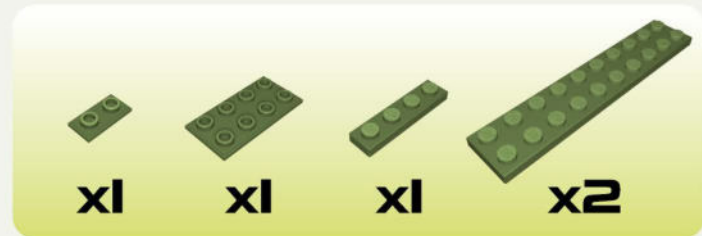
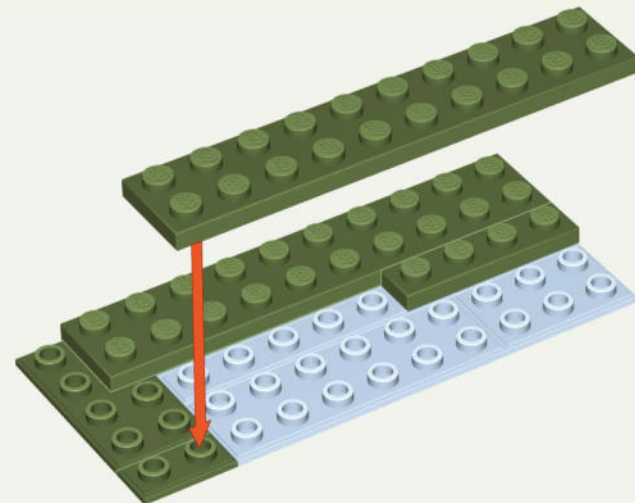

3

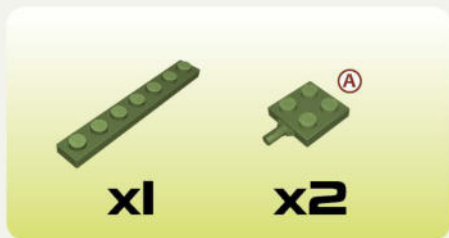
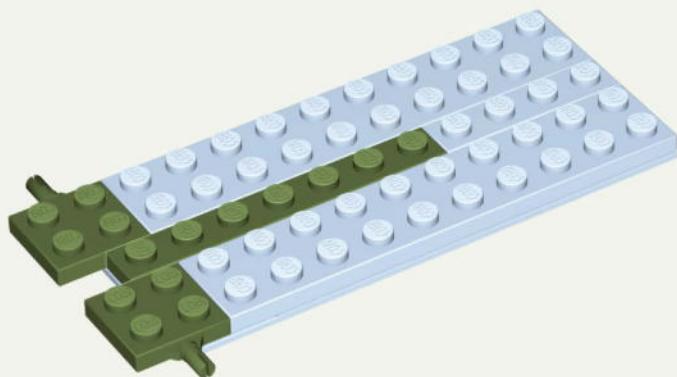

4

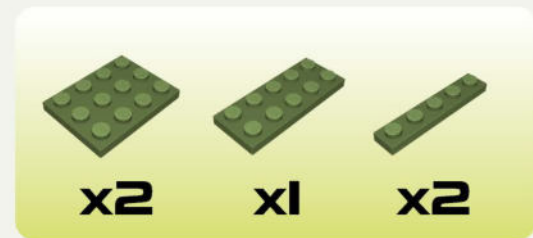
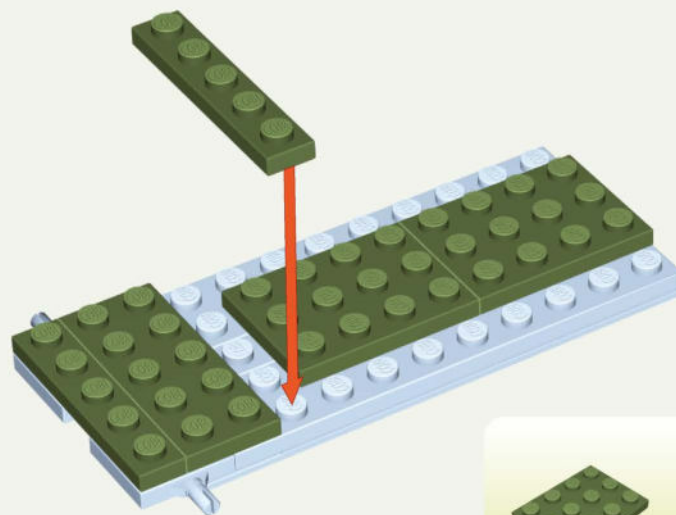

5

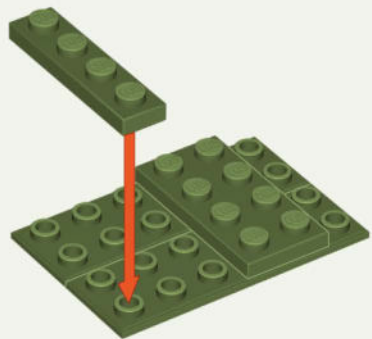

x2



x1



x1

6

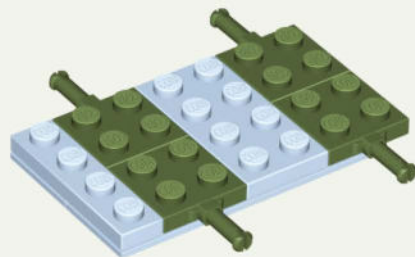

x4

7

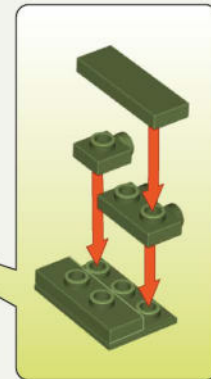
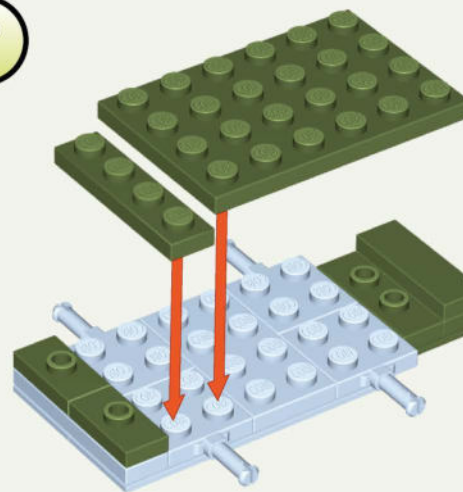

x1



x1



x1



x1



x1



x1



x2



x1

1:1

8

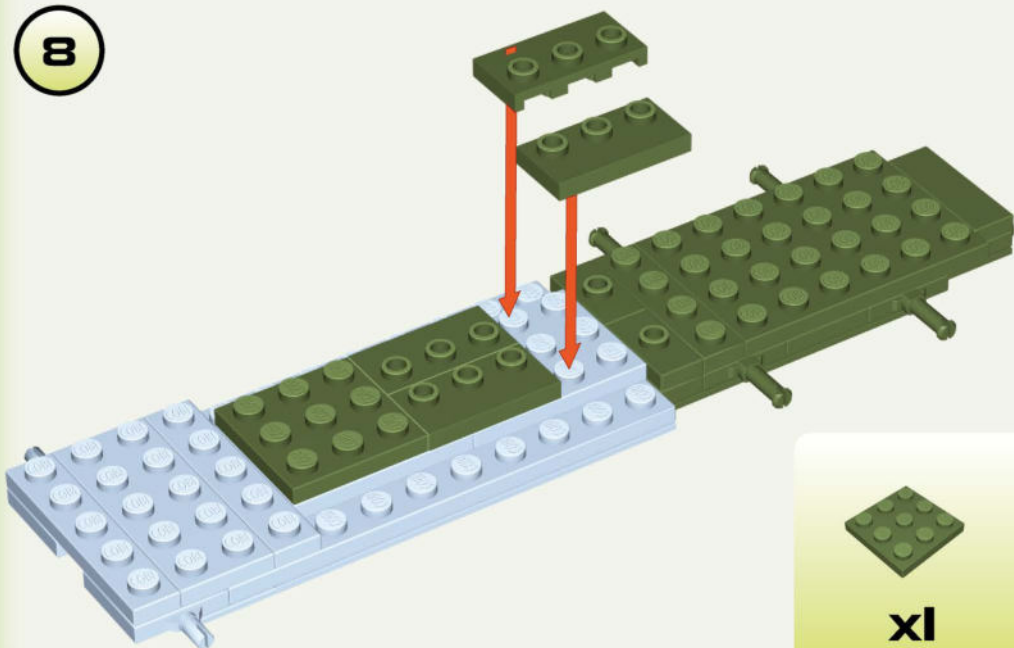

x1



x4

9

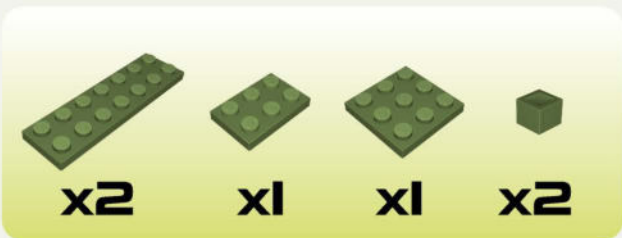
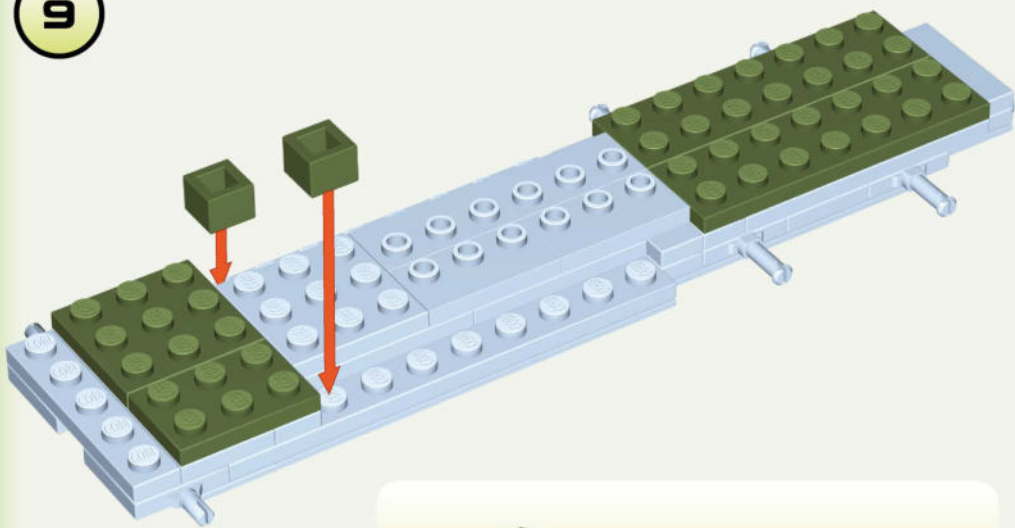

10

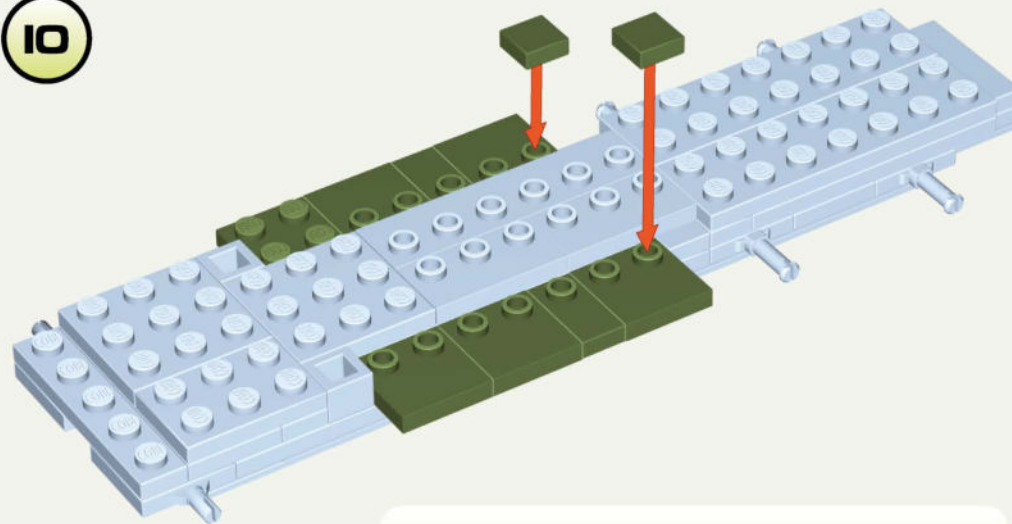



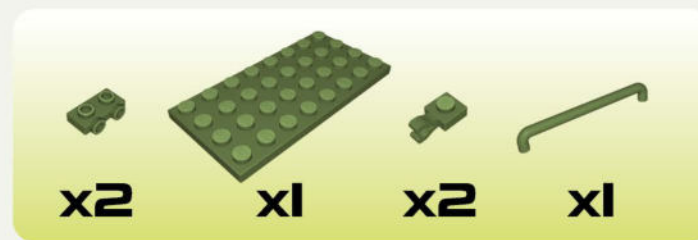
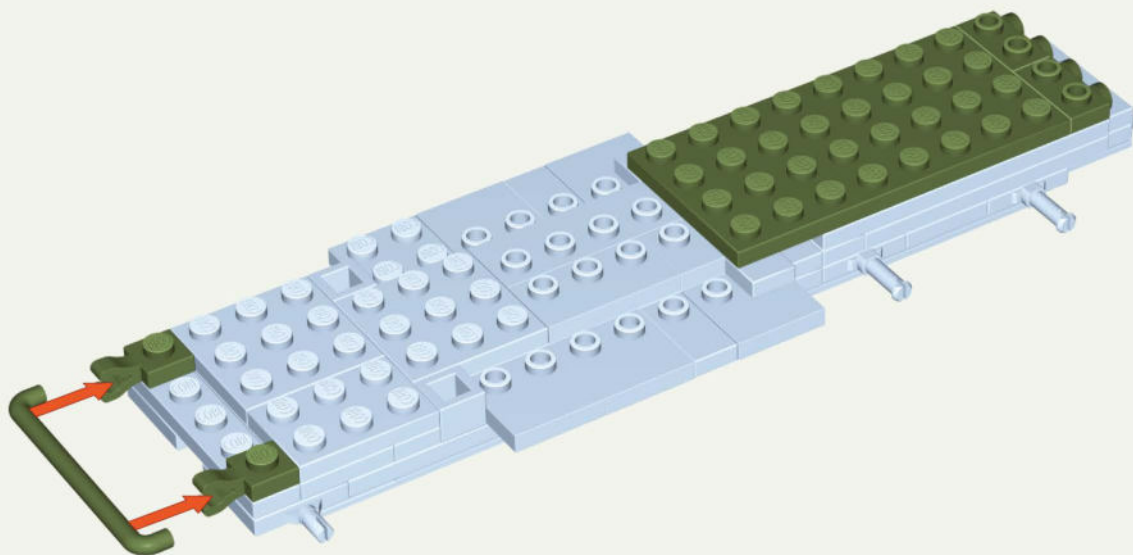

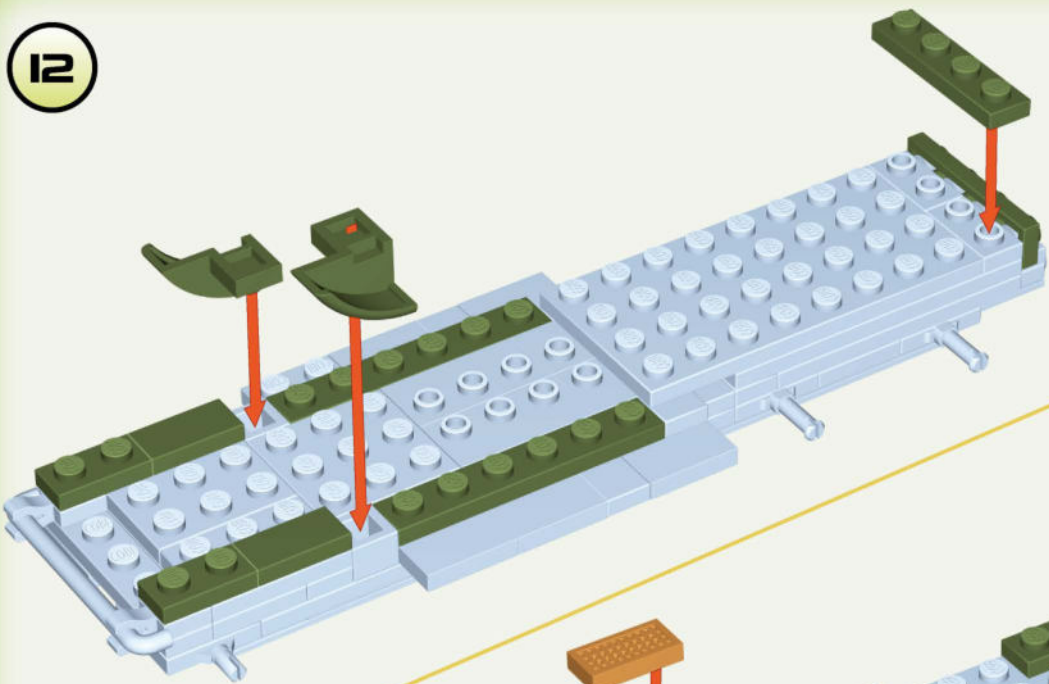

11



12







1:1

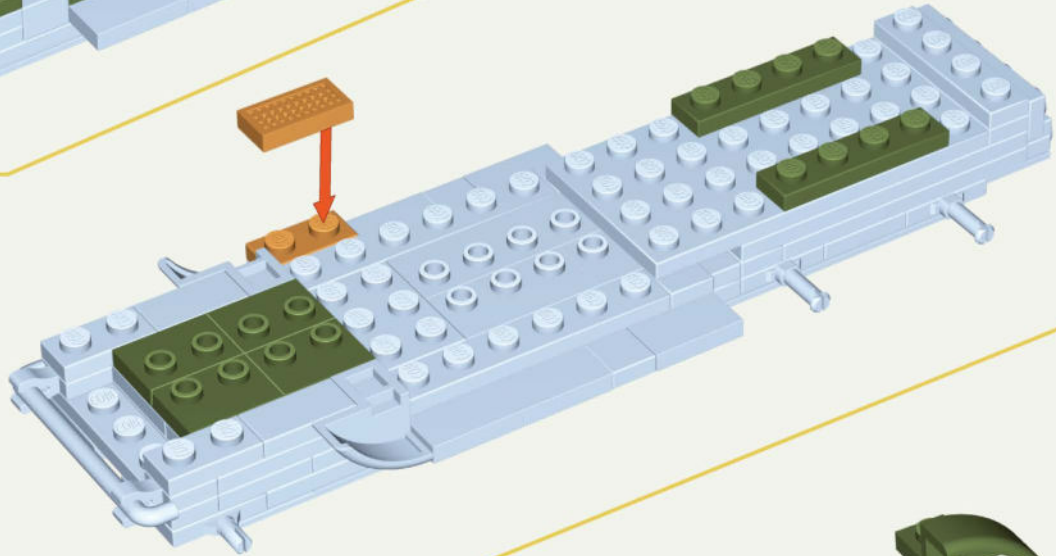







					
x2	x2	x2	x2	x1	x1

13



			
x2	x4	x1	x1

14

			
x2	x2	x1	x2
			
x1	x1	x1	x1

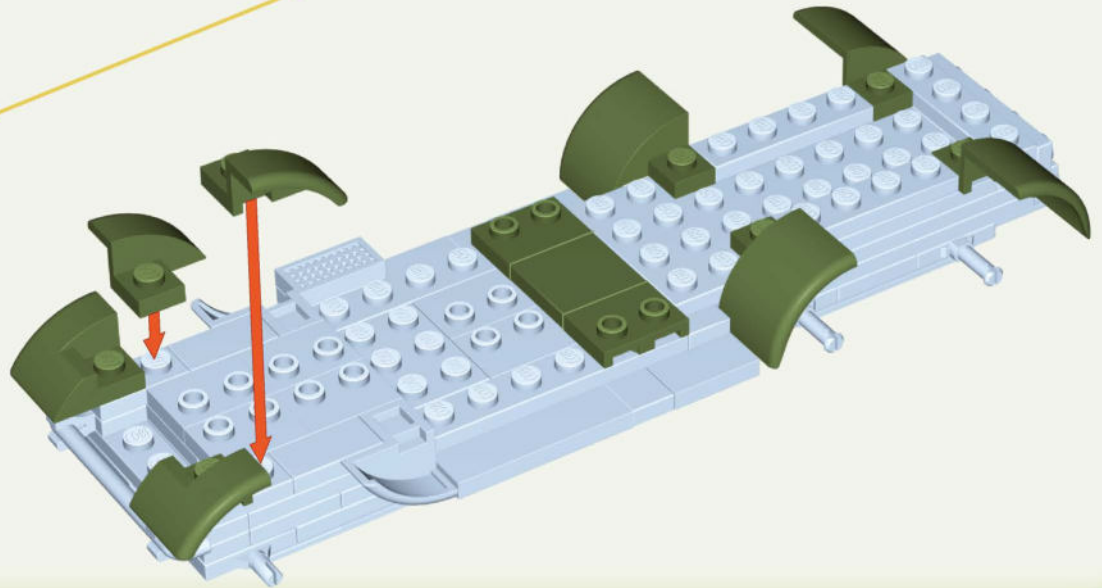

15

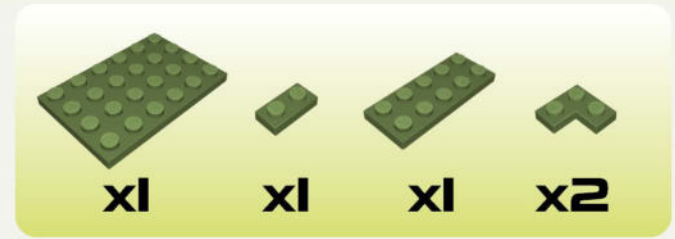
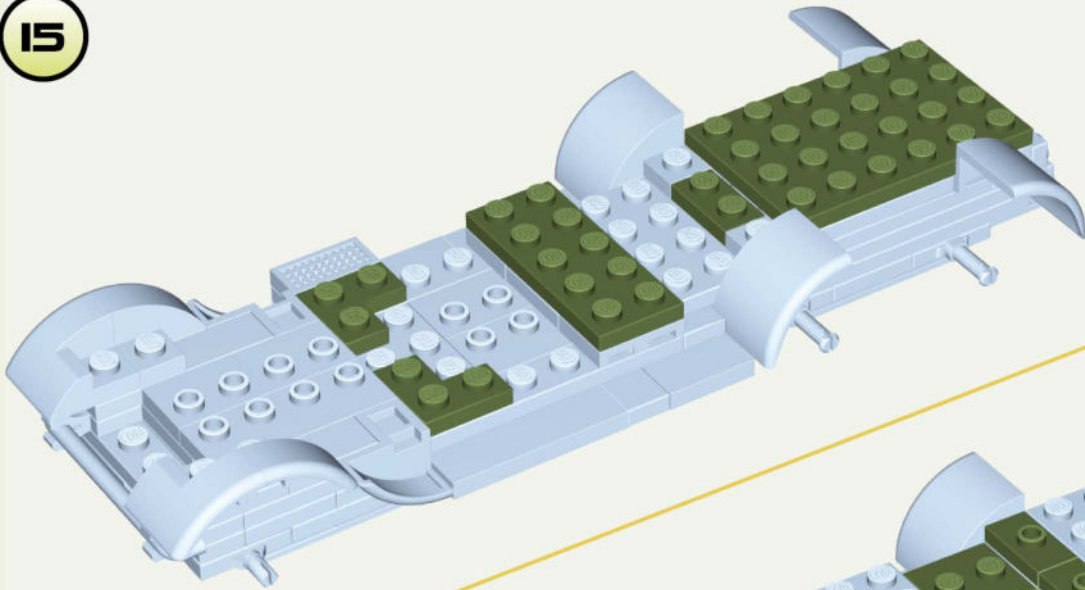

16

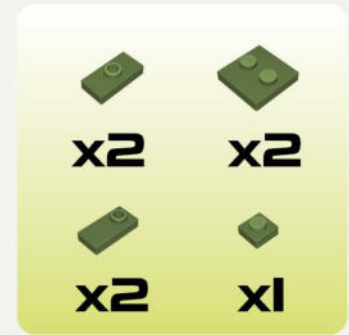
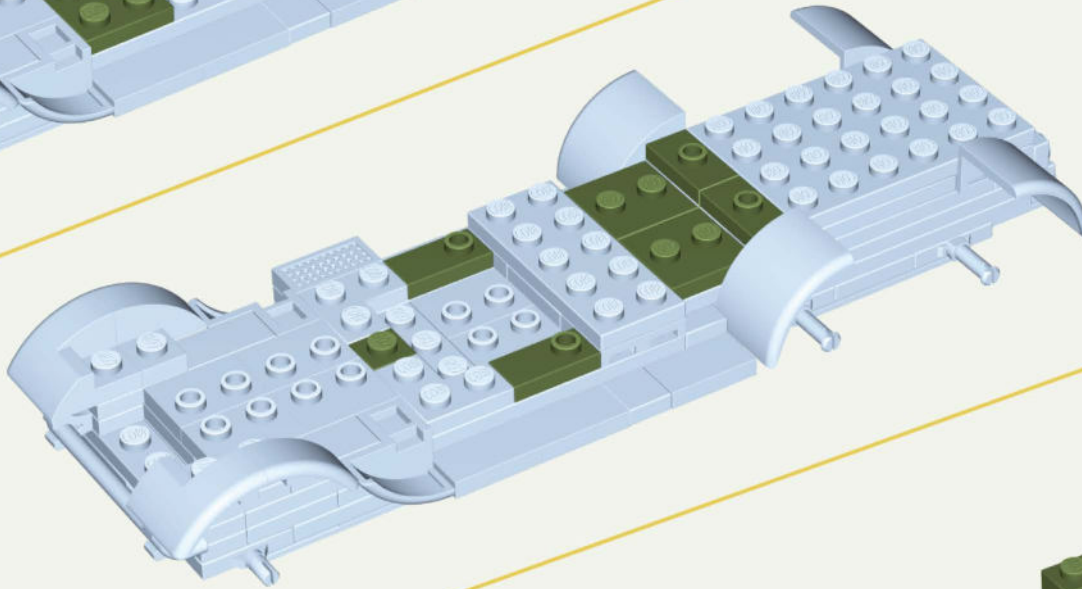

17

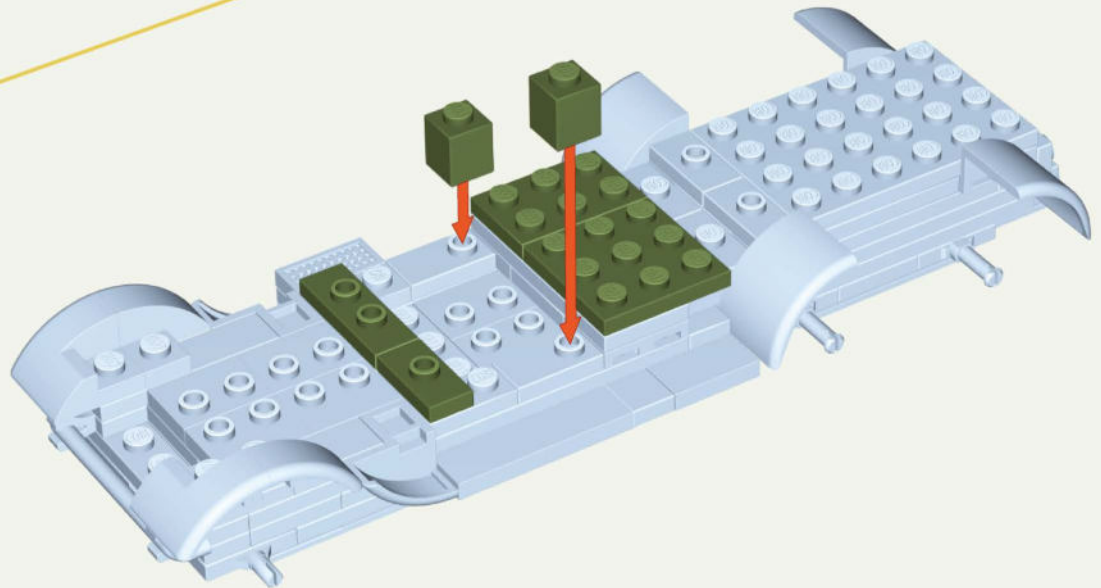
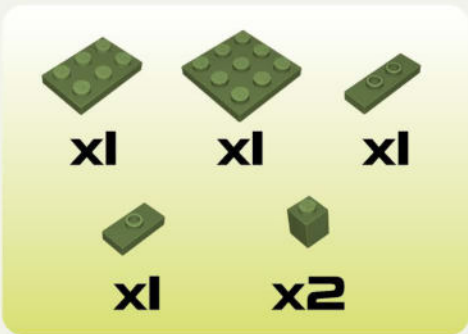

18

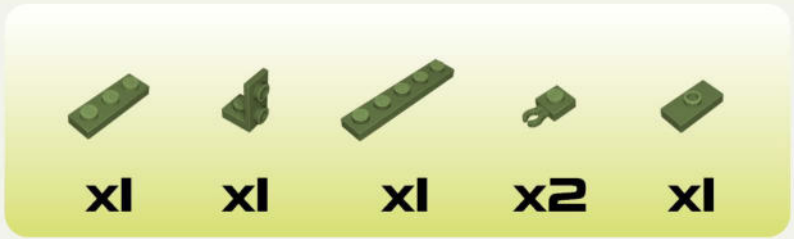
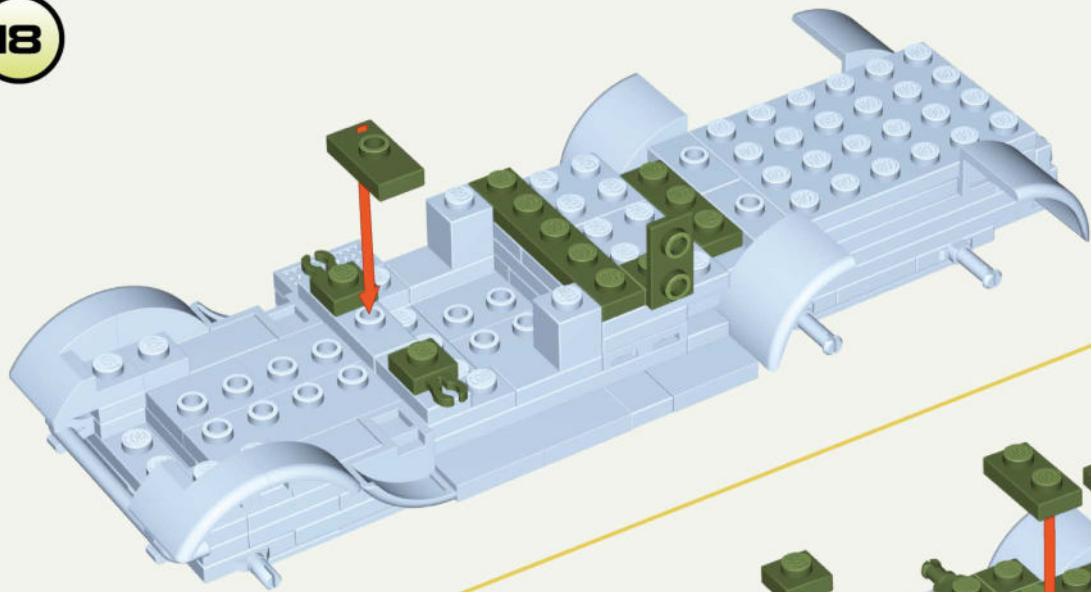

19

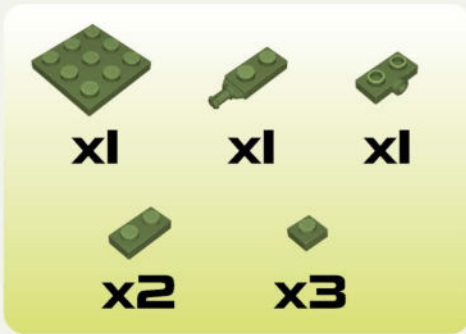
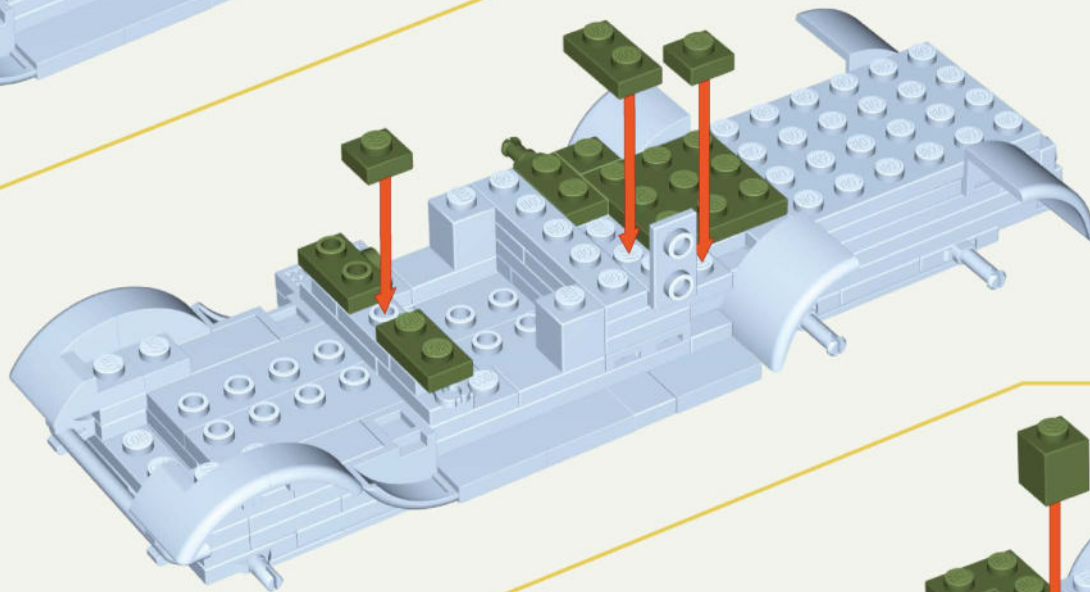

20

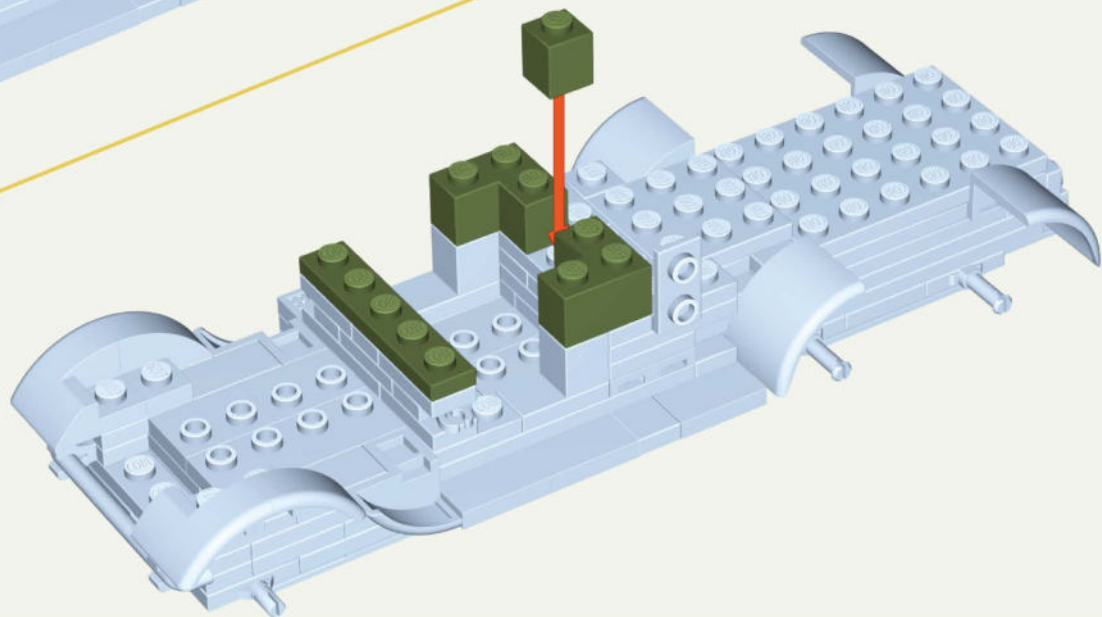

21

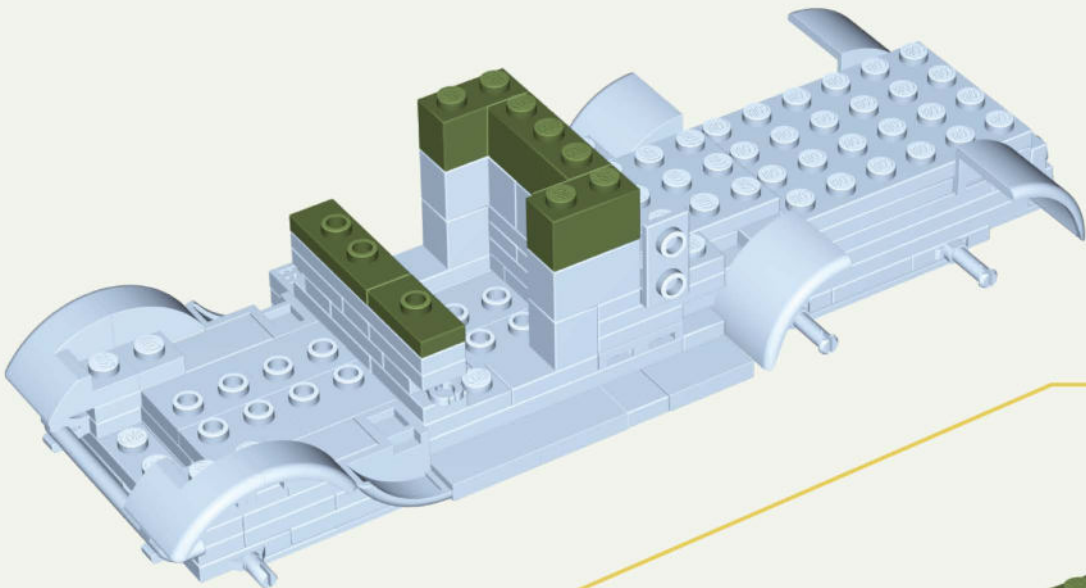
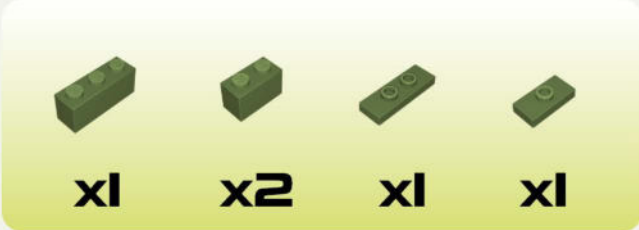



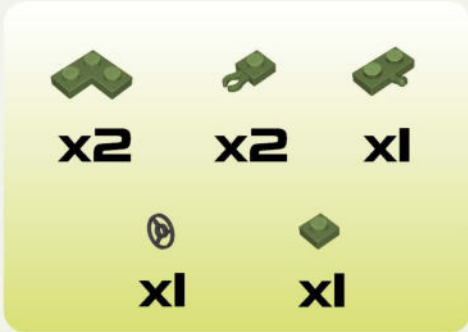
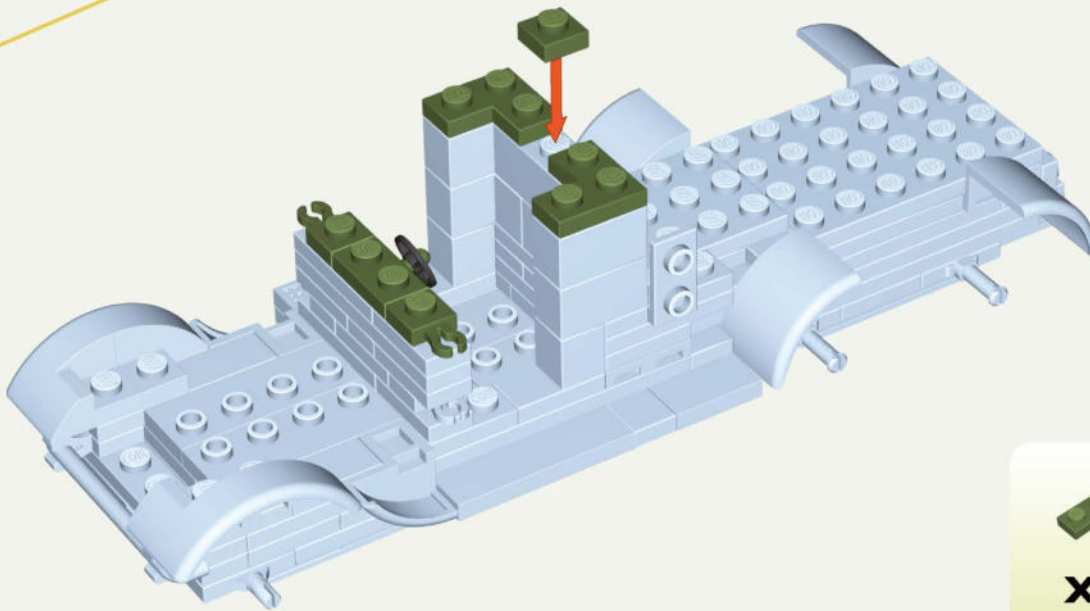



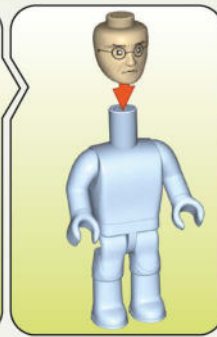
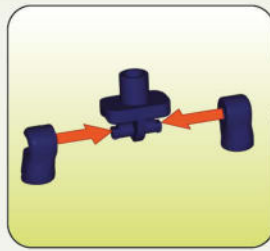

22



23



 x1	 x1	 x1	 x2
 x1	 x1	 x1	 x1
 x2			

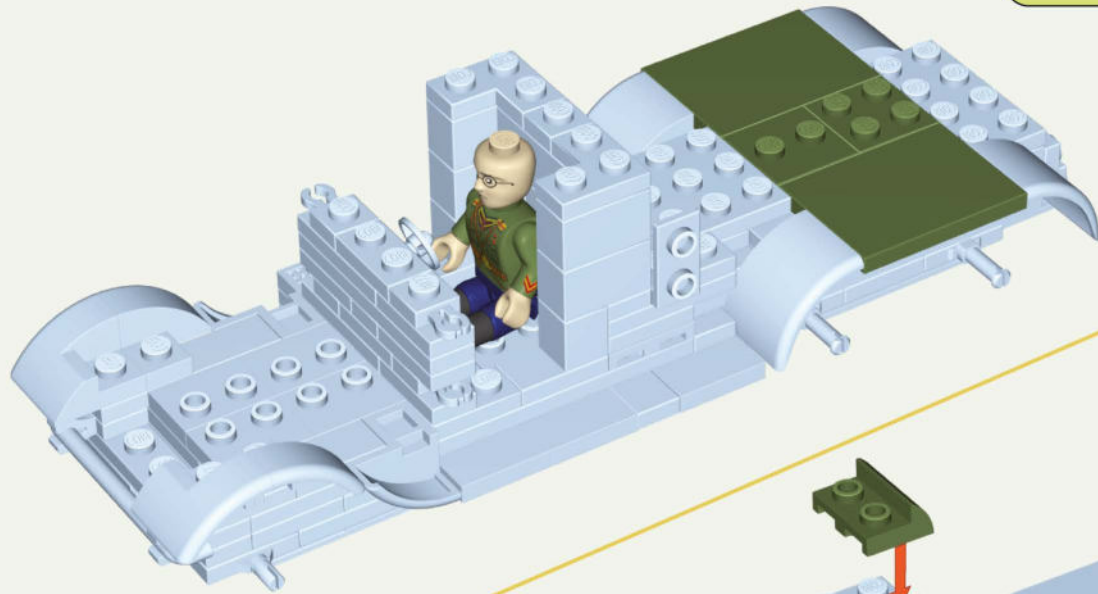

24

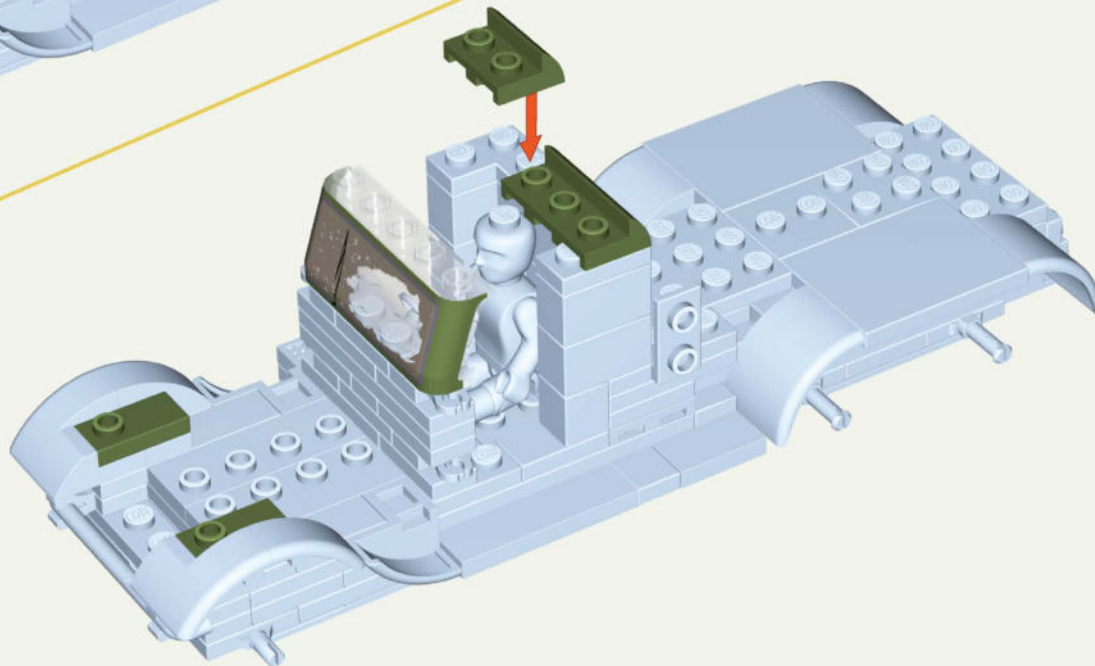

 x2	 x1
 x1	 x1

25

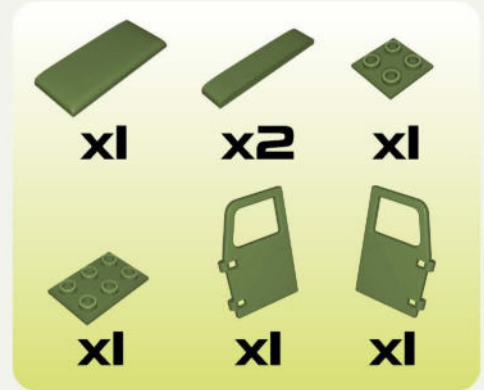
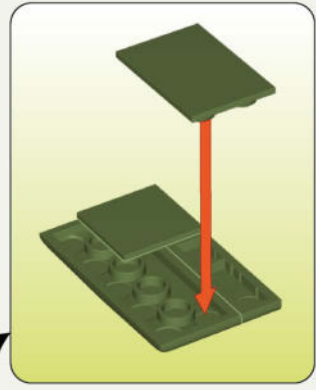
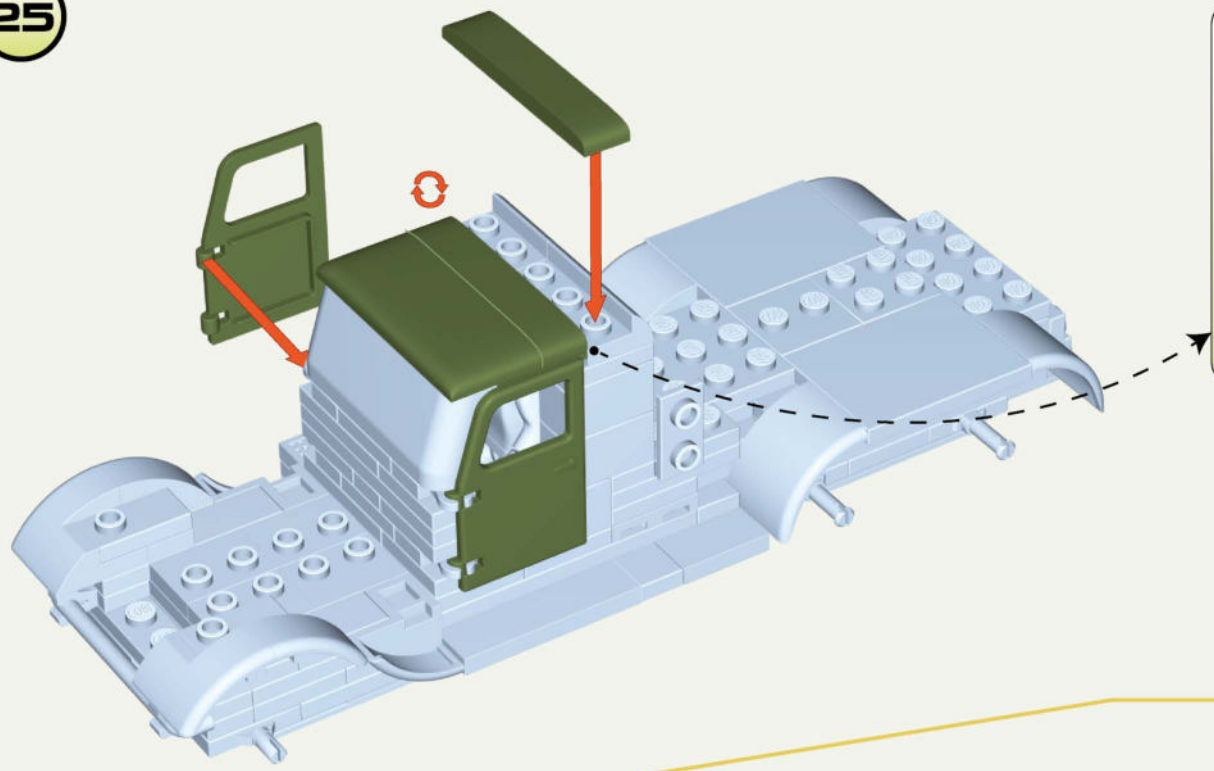

26

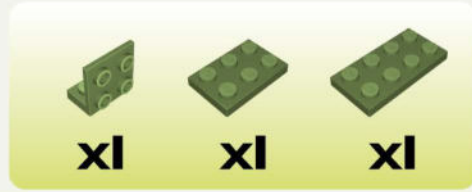
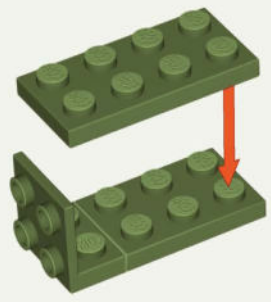

27

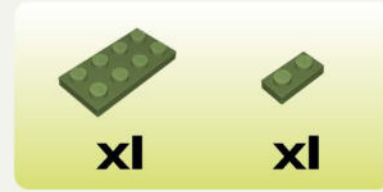
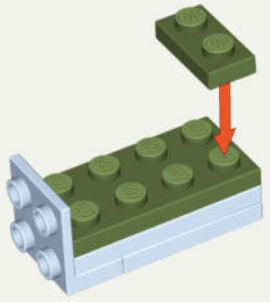

28

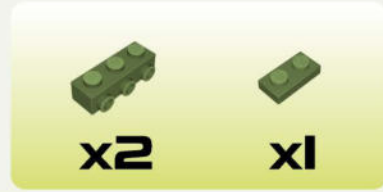
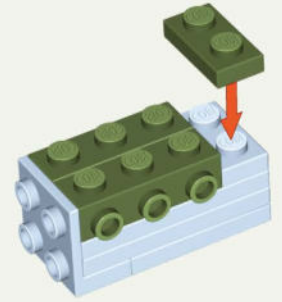

29

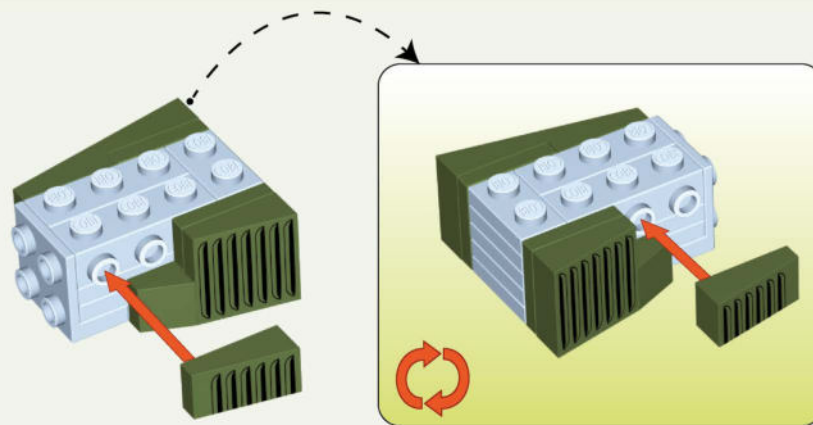
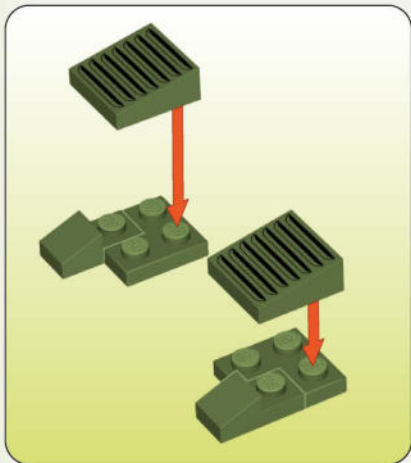

30

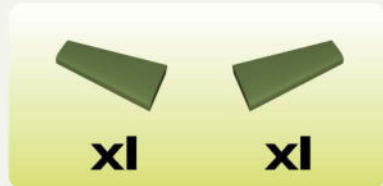
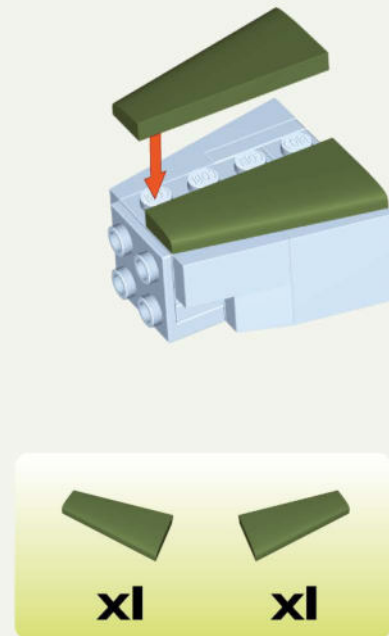

31

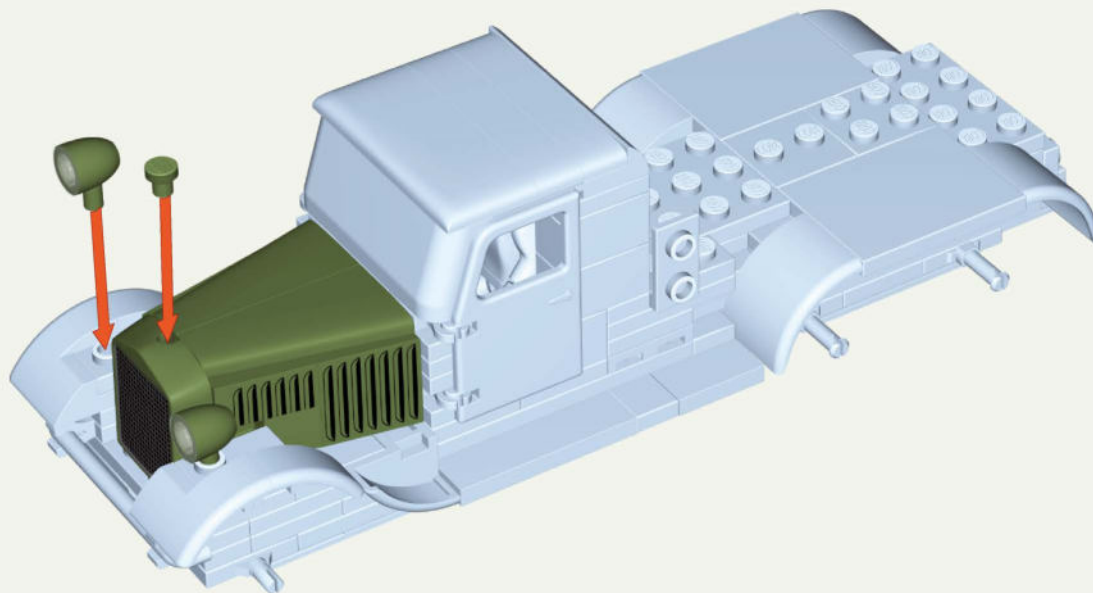

32

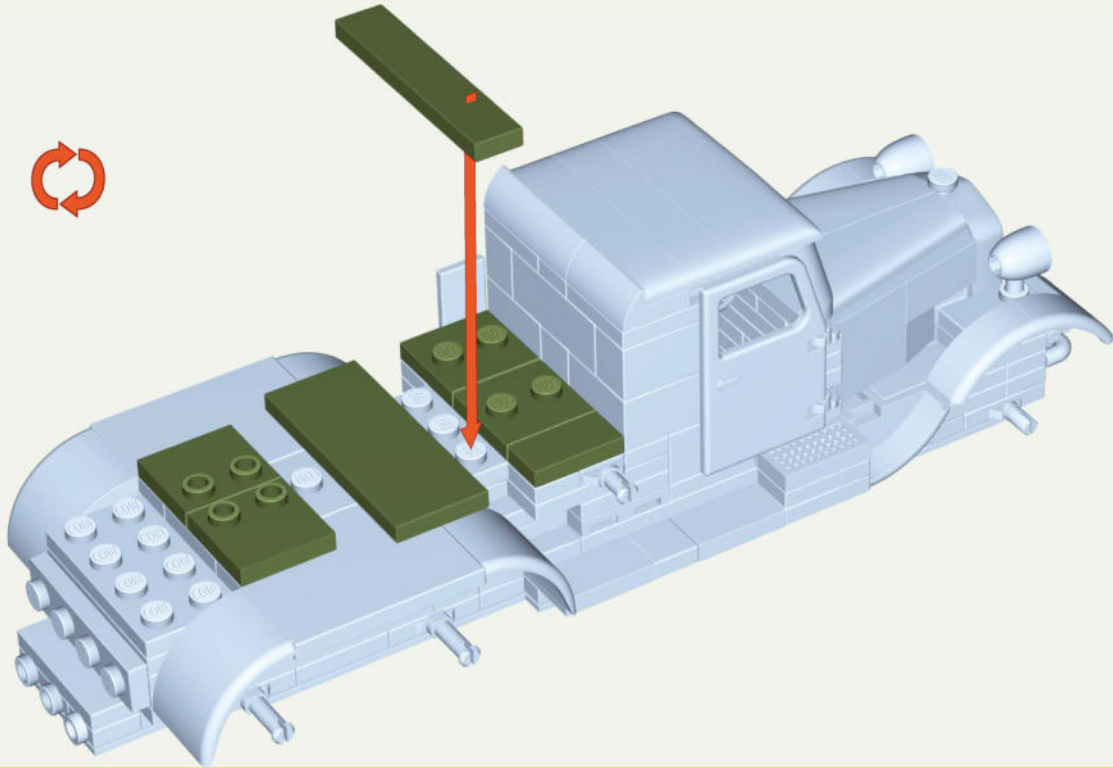





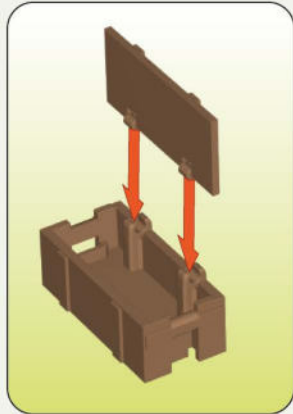
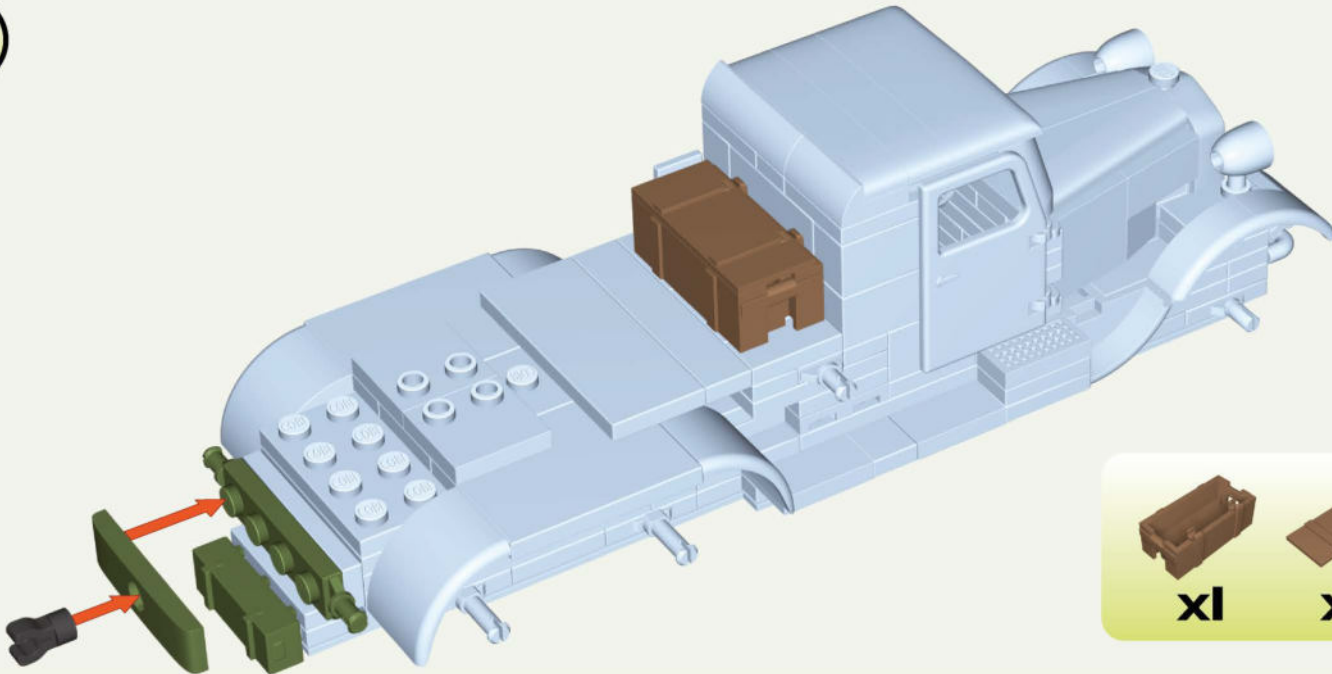

1:1		1:1		
x2	x1	x1	x2	x1

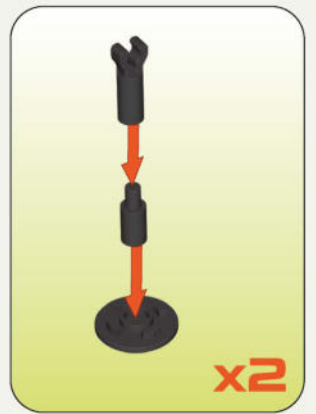
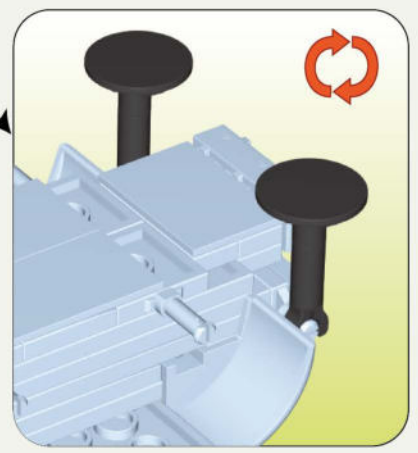
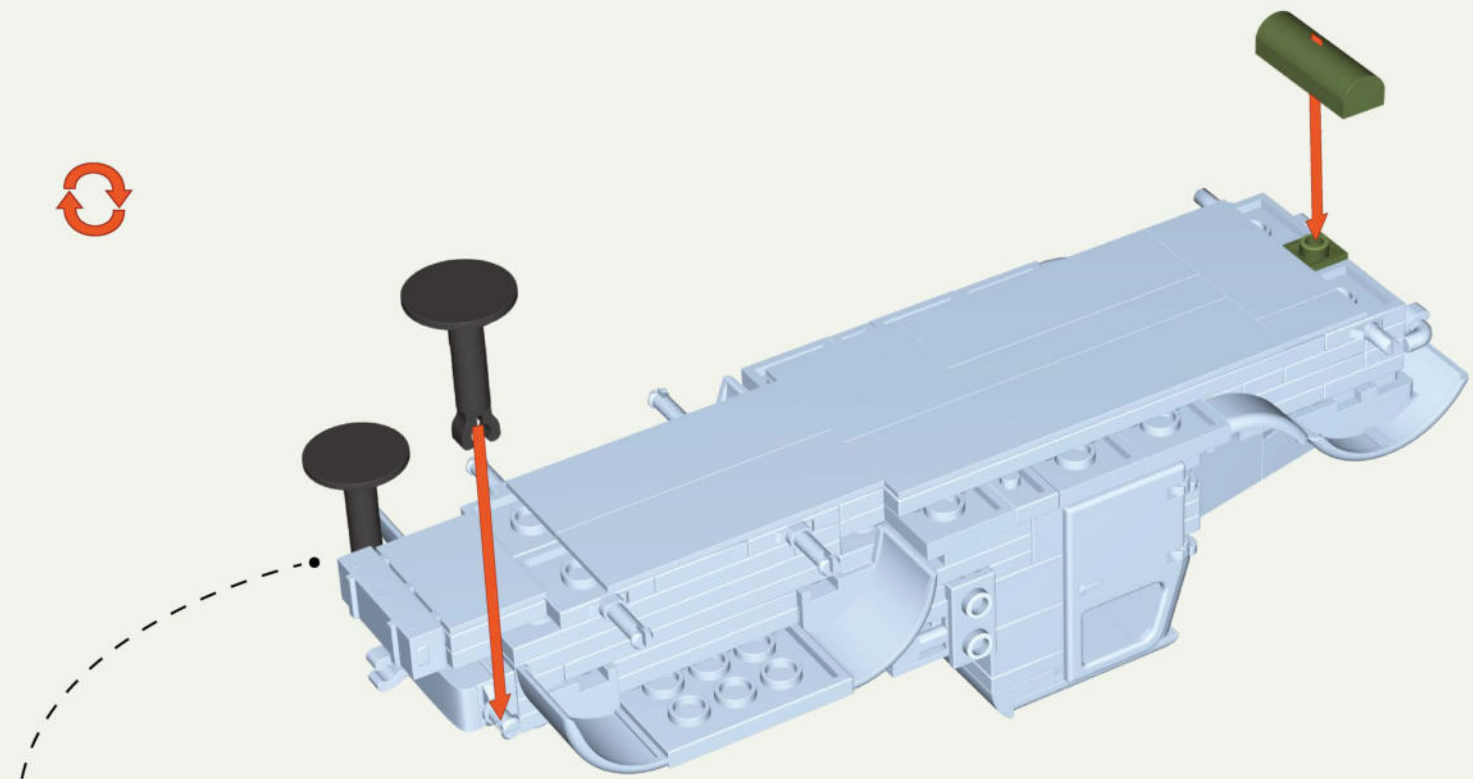
33



x1	x1	x1	x1	x1	x1



-  x1
-  x1
-  x2
-  x2
-  x2

35

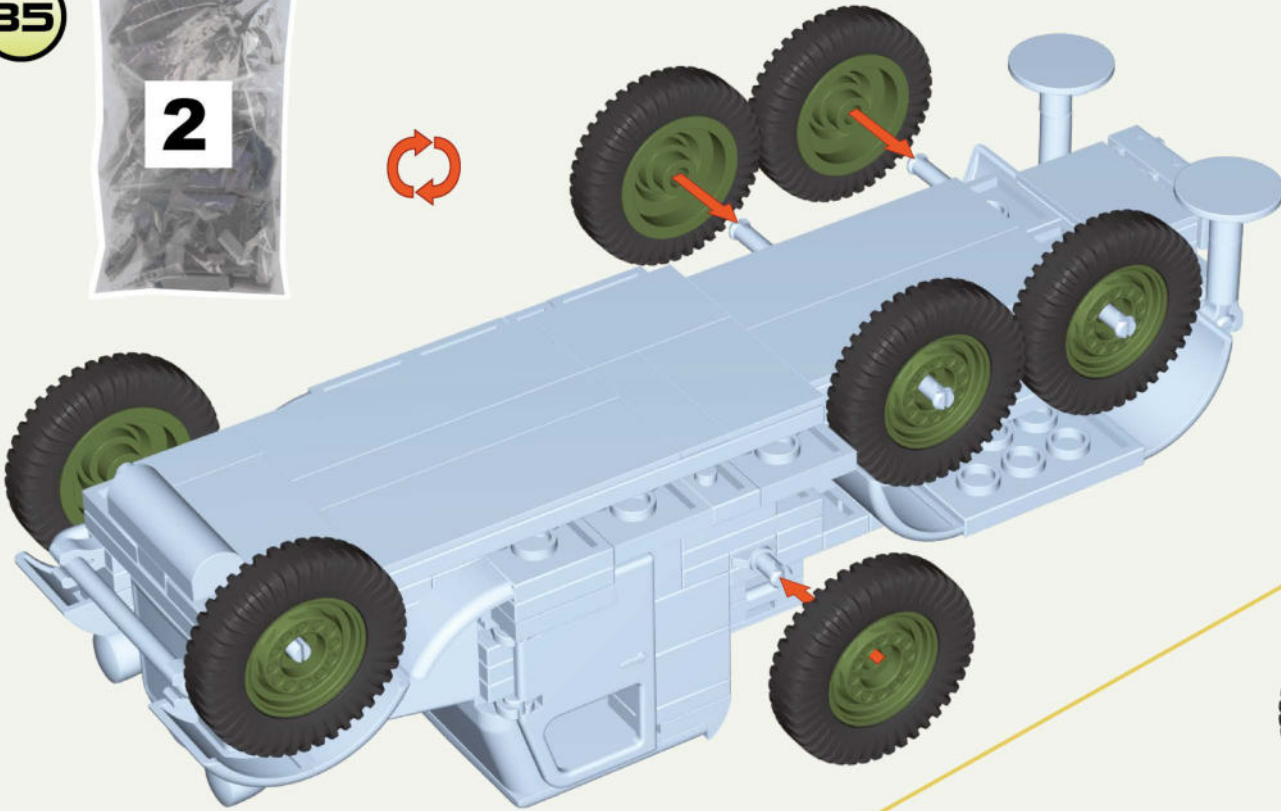

36

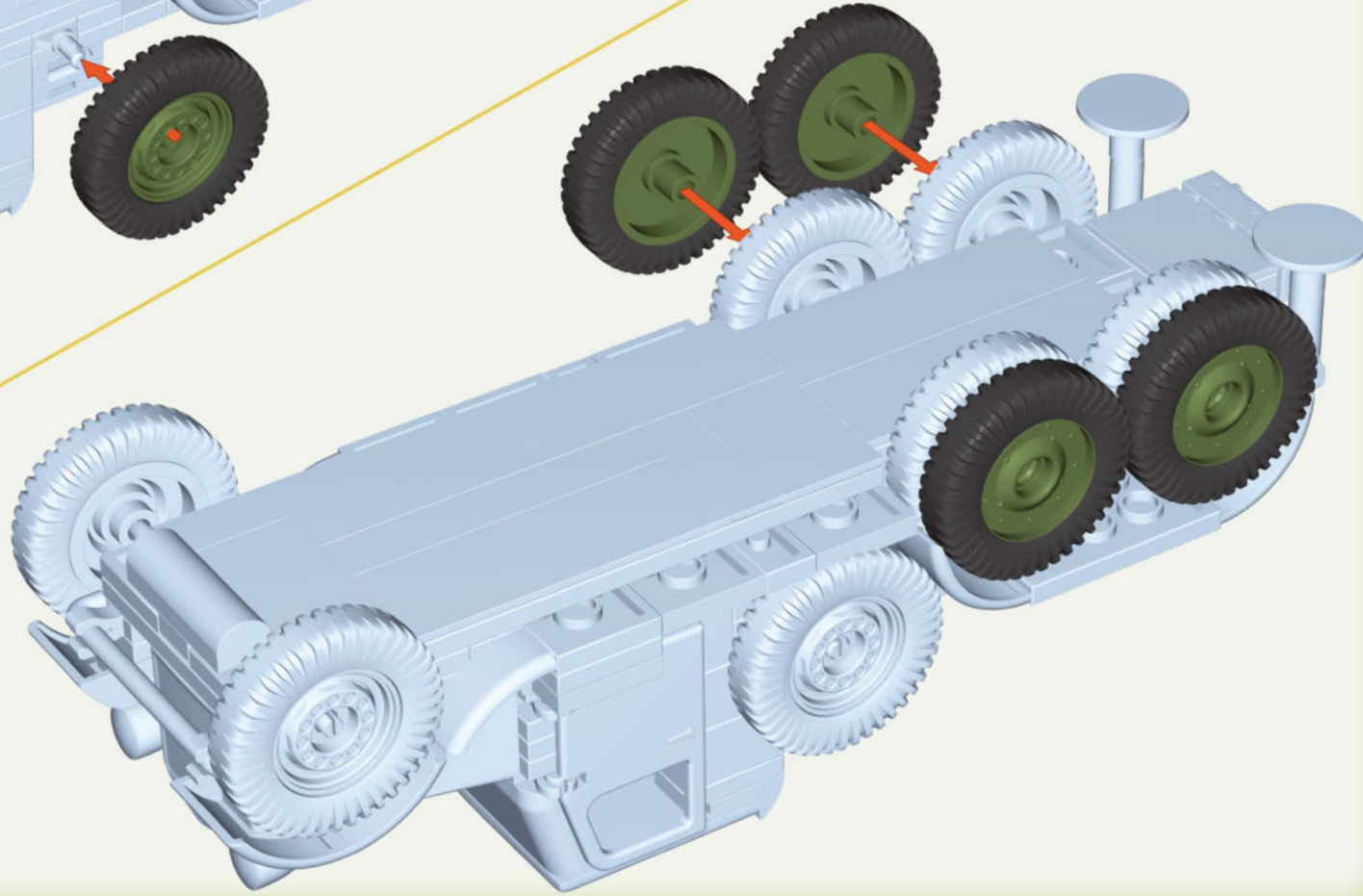

37

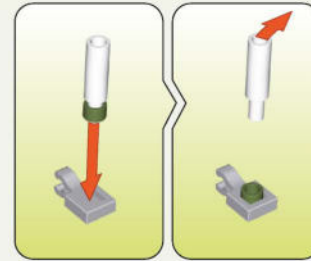
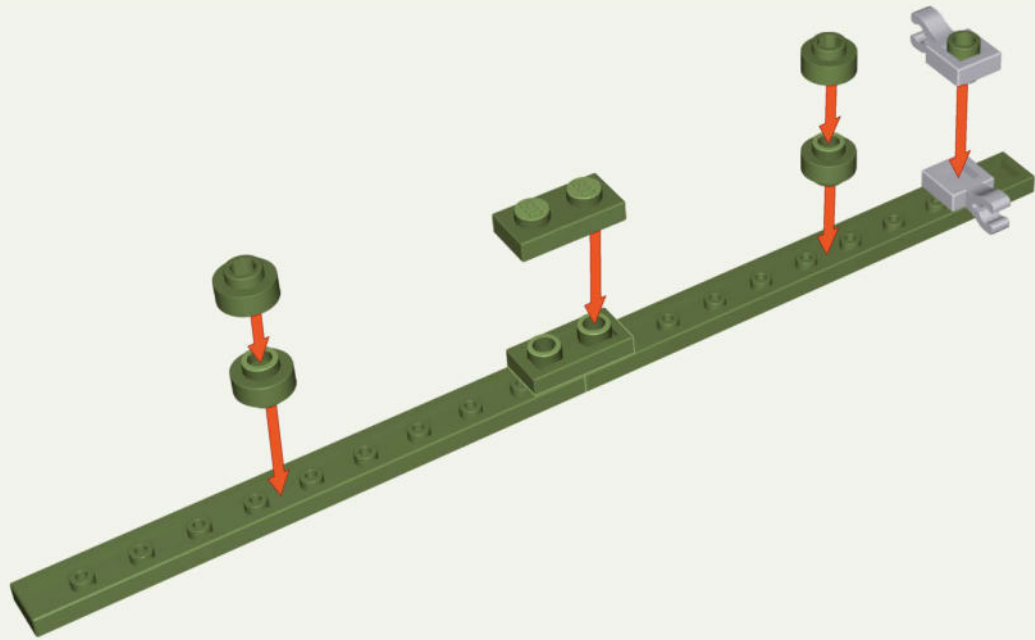

1:1

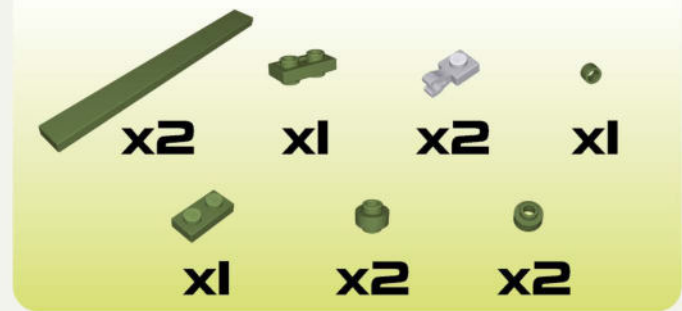

38

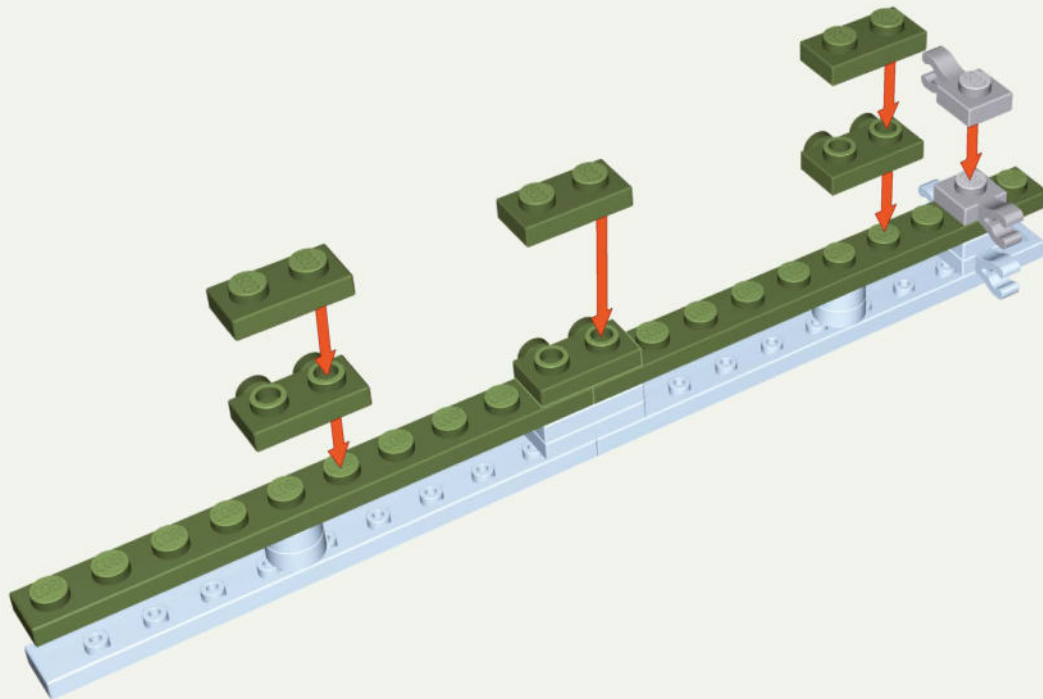

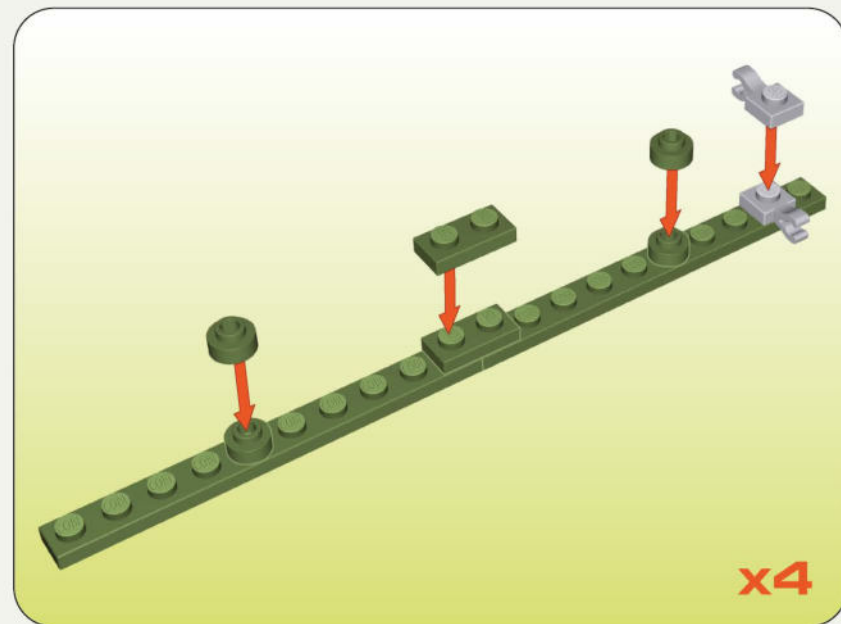
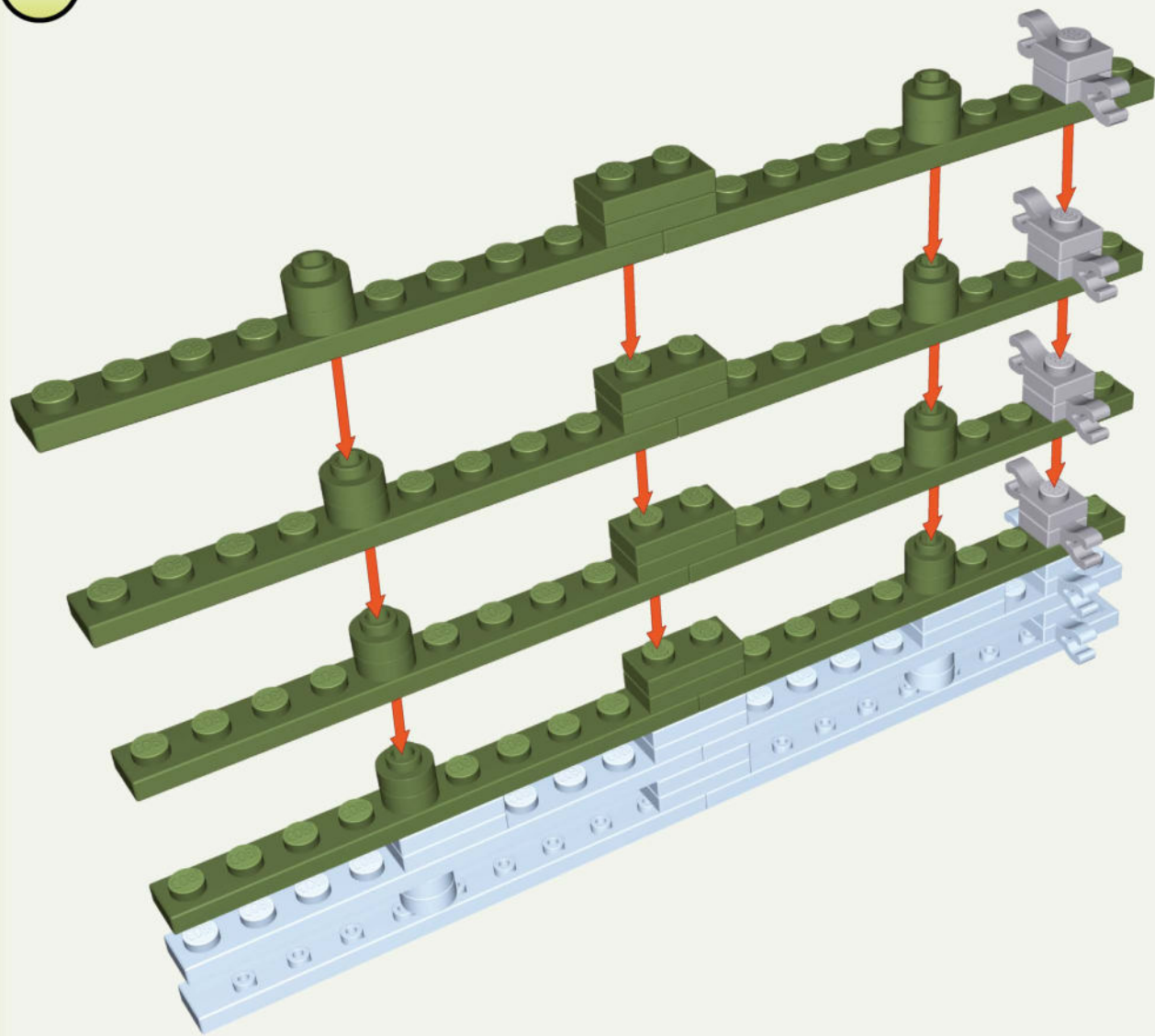

-  x8
-  x16
-  x8
-  x8

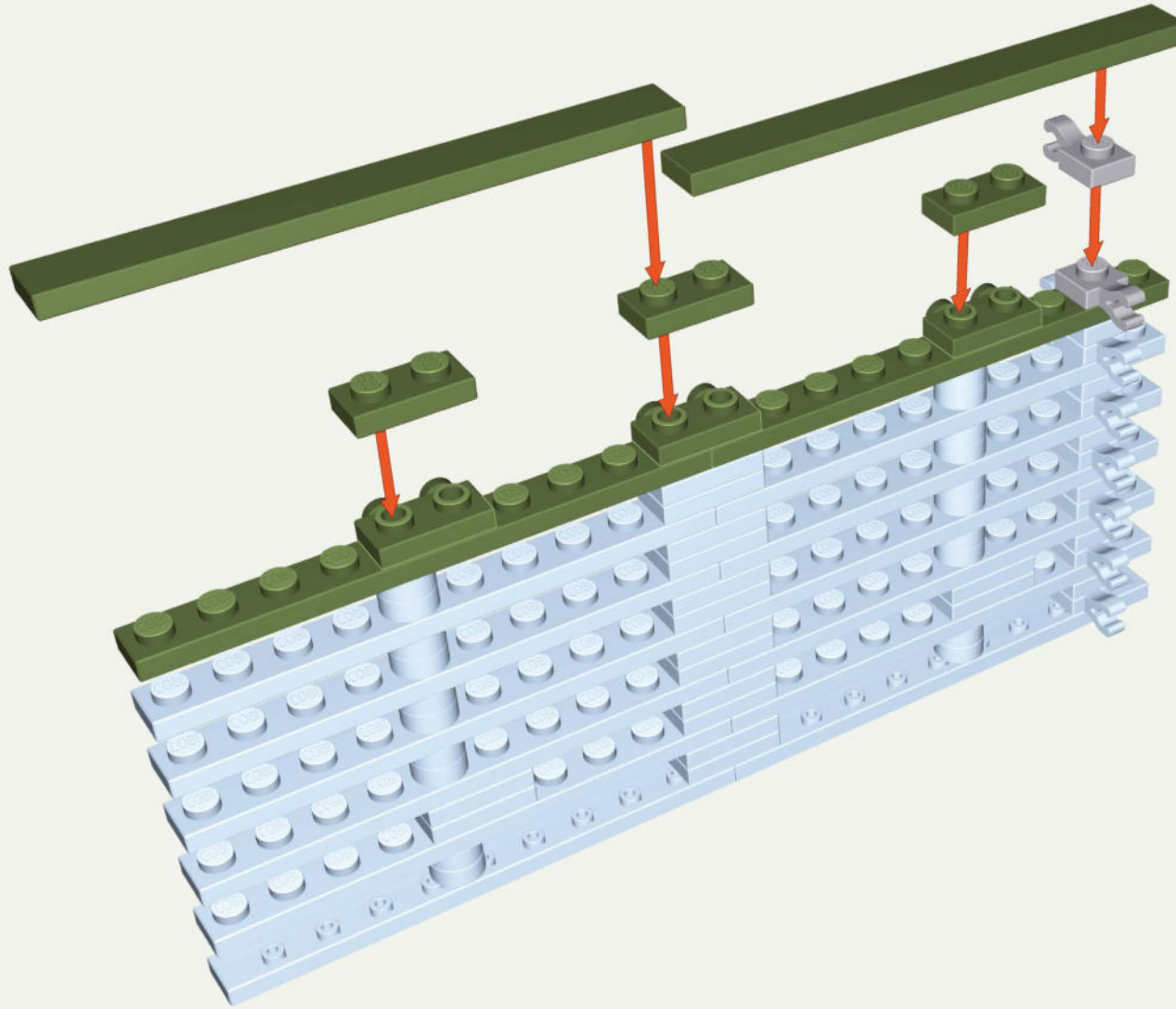

1:1

- x2
- x3
- x2
- x3
- x2

41

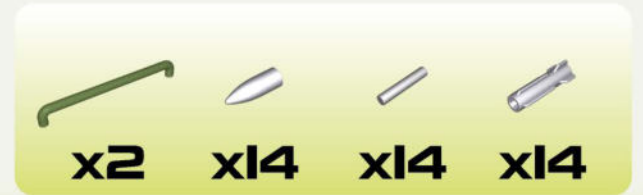
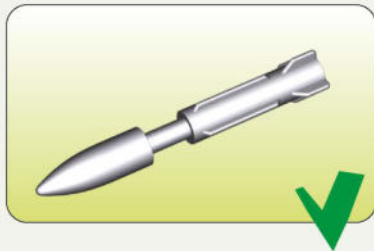
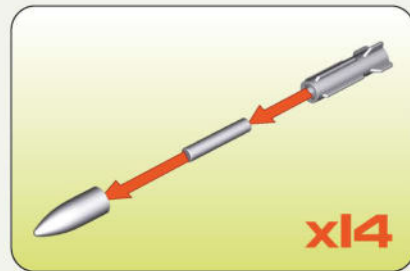
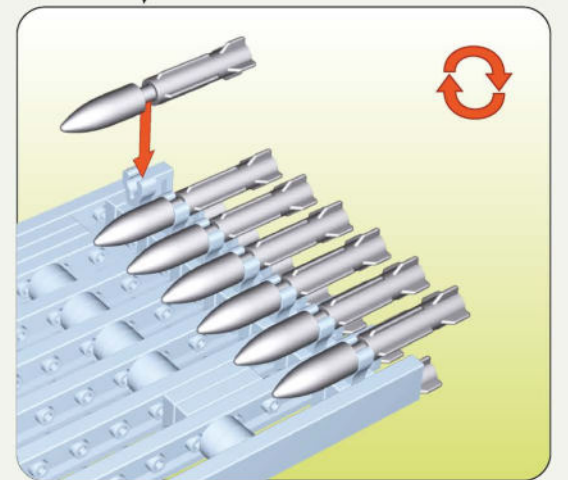
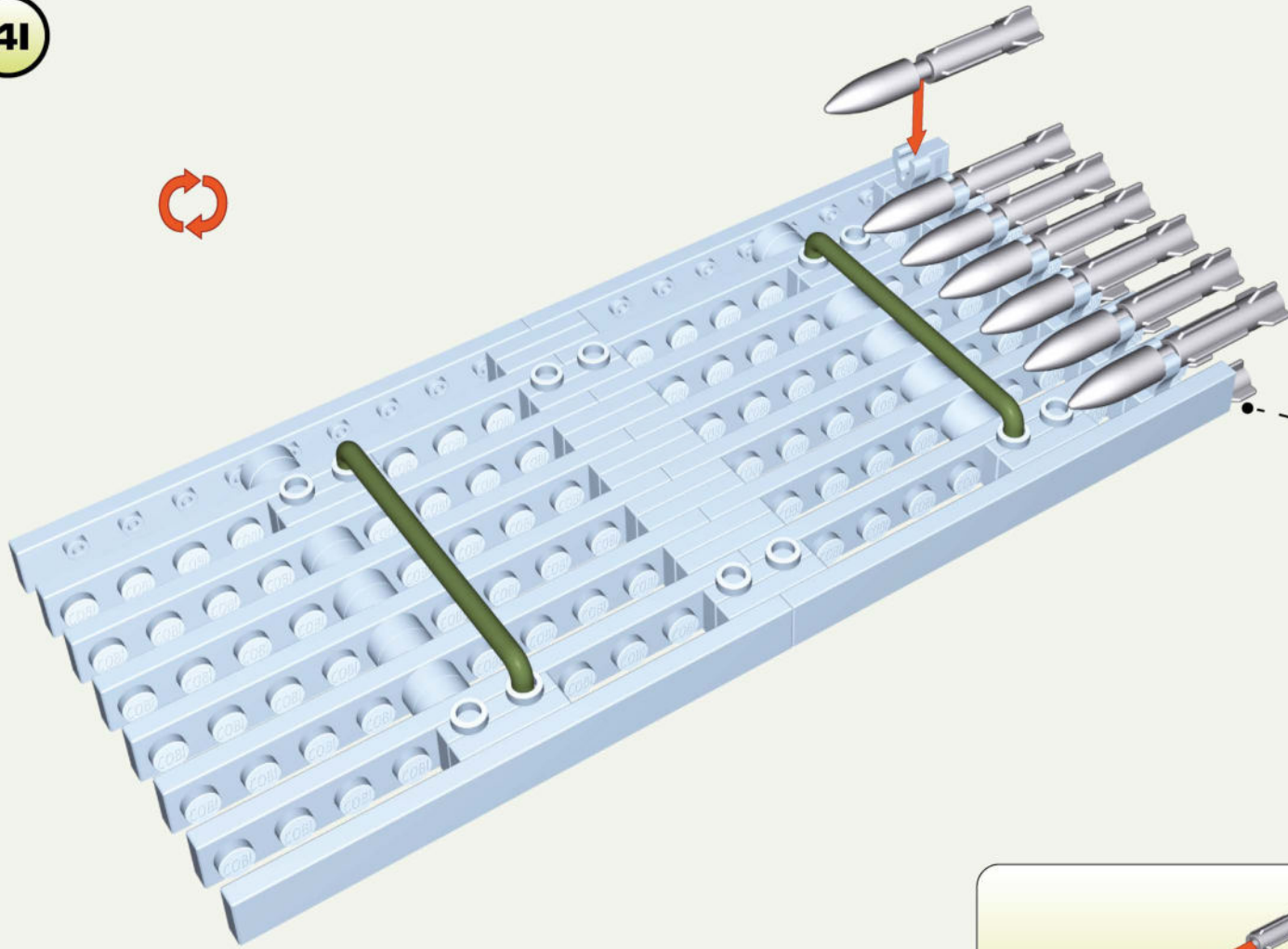

42

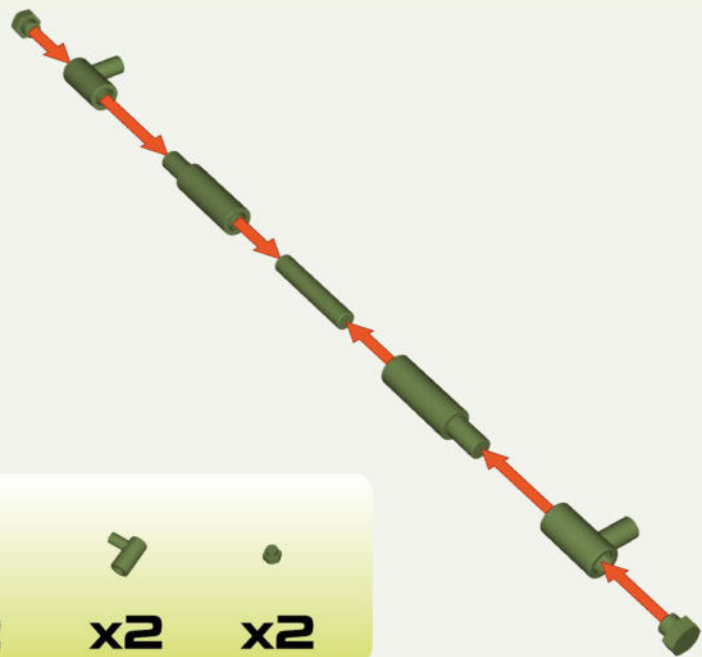

- x1
- x2
- x2
- x2

43

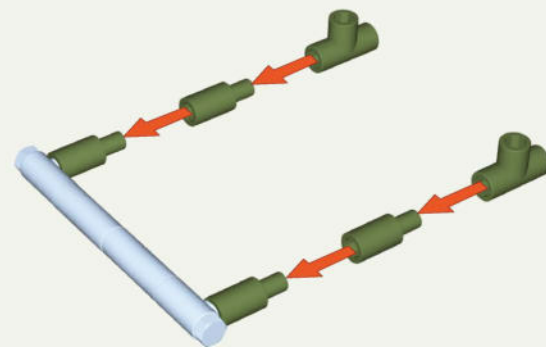

- x4
- x2

44

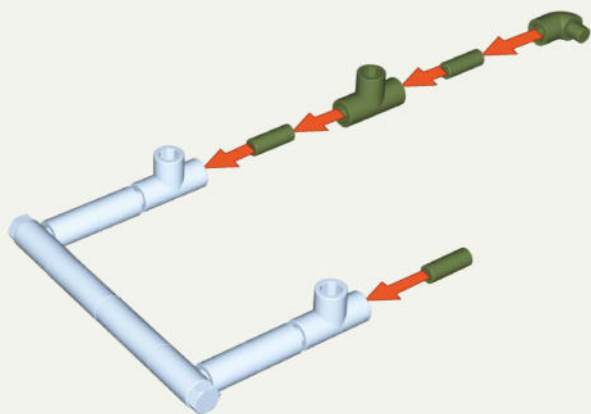

- x3
- x1
- x1

45

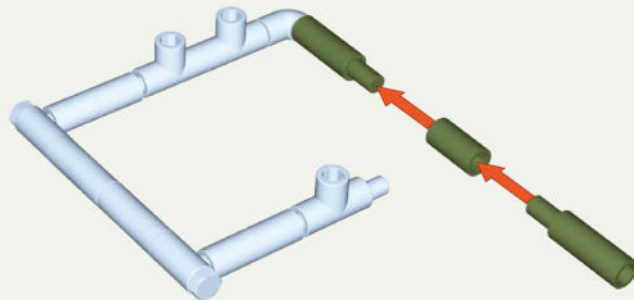

- x2
- x1

46

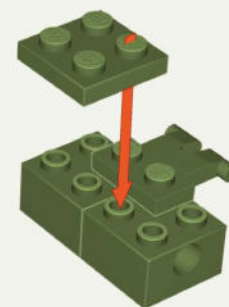

- x2
- x1
- x1

47

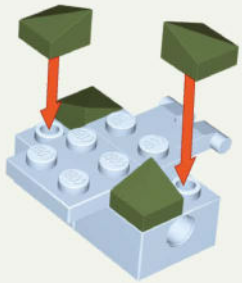

48

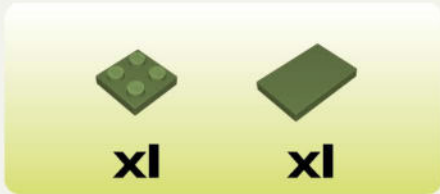
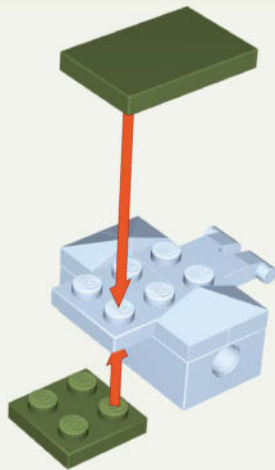

49

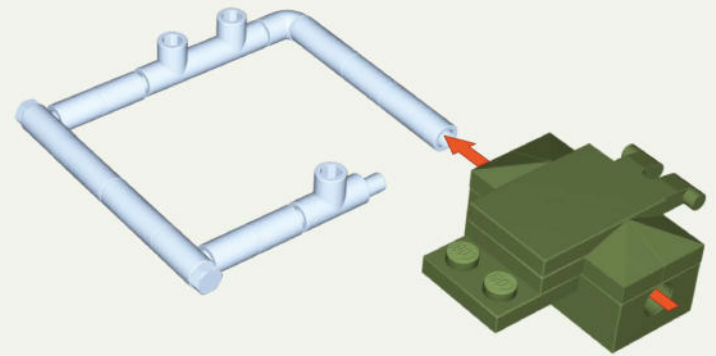

50

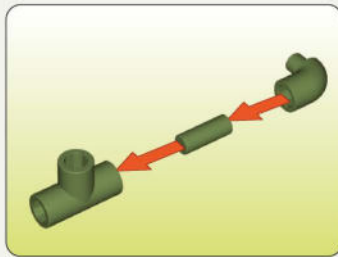
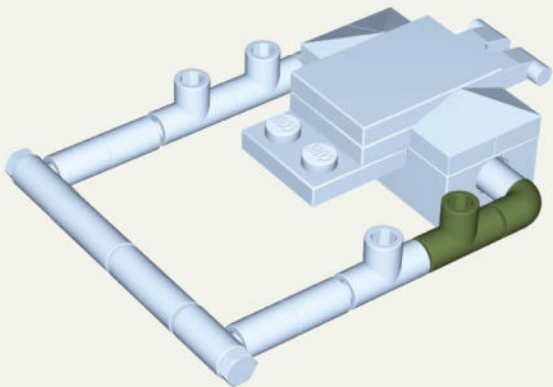

51

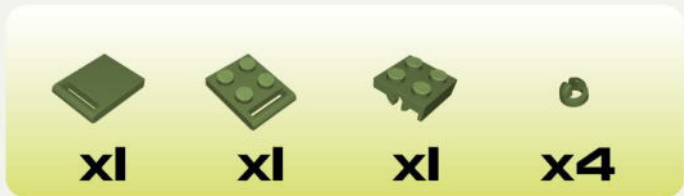
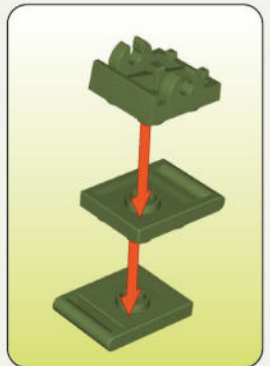
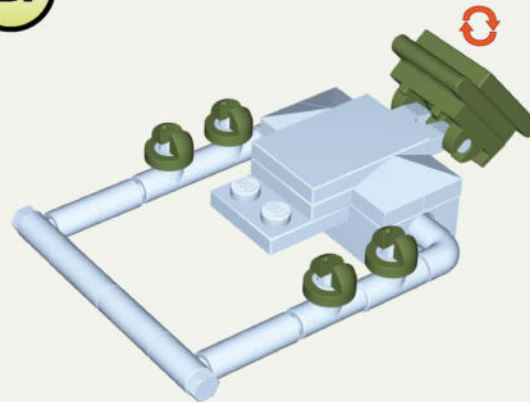

52

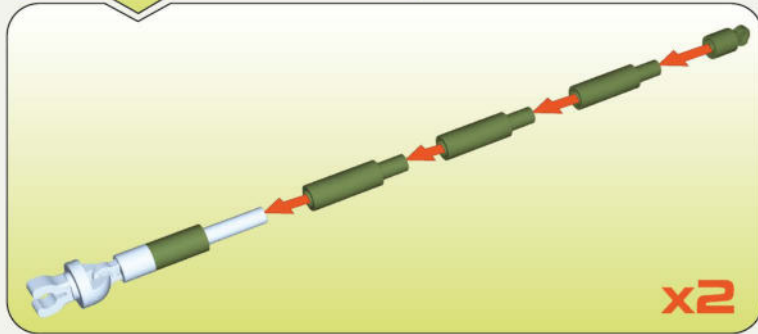
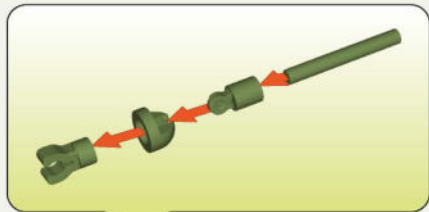

x2



x2



x2



x4



x2



x2



x6

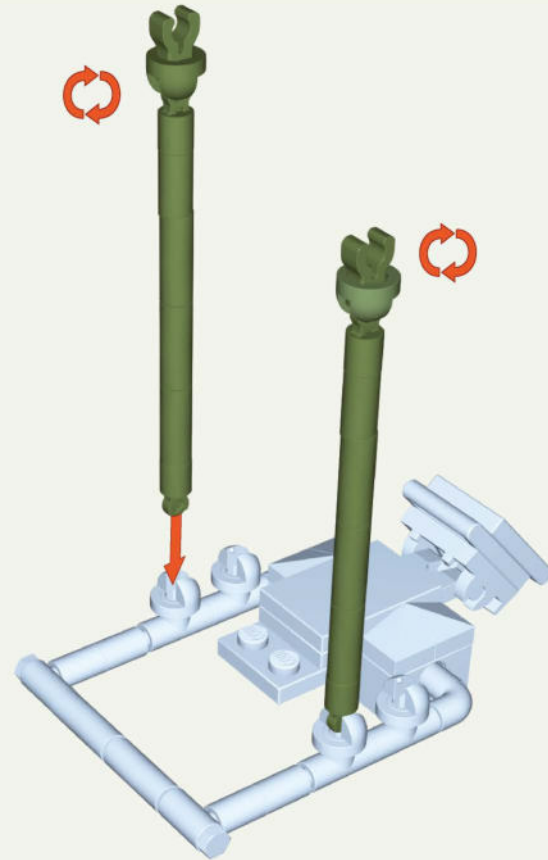

53

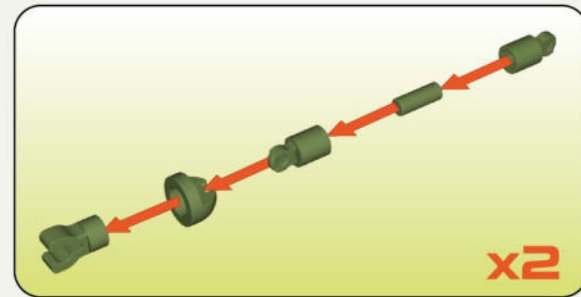
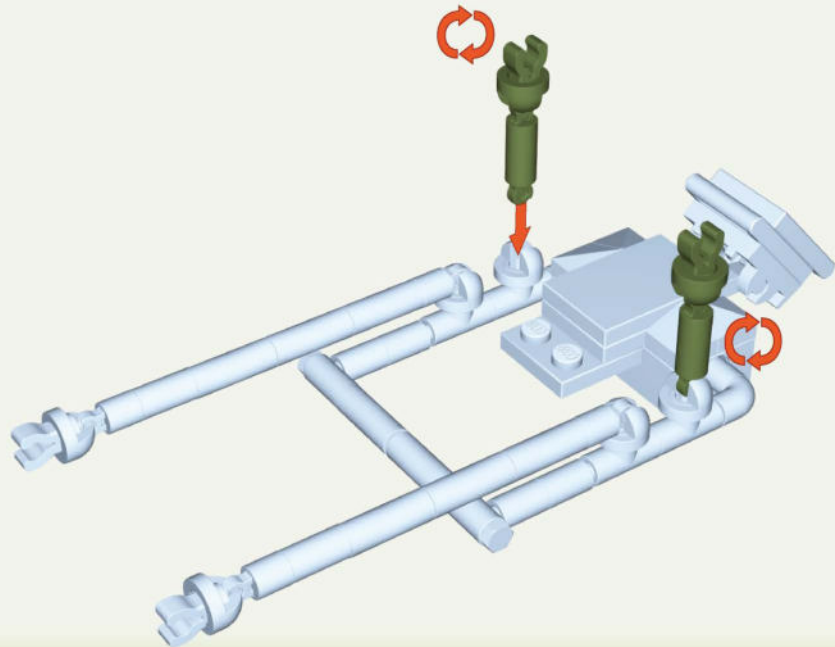

x2



x2



x2



x4



x2

54

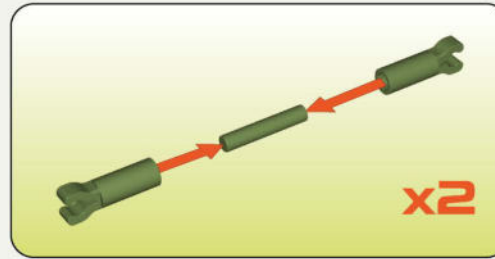
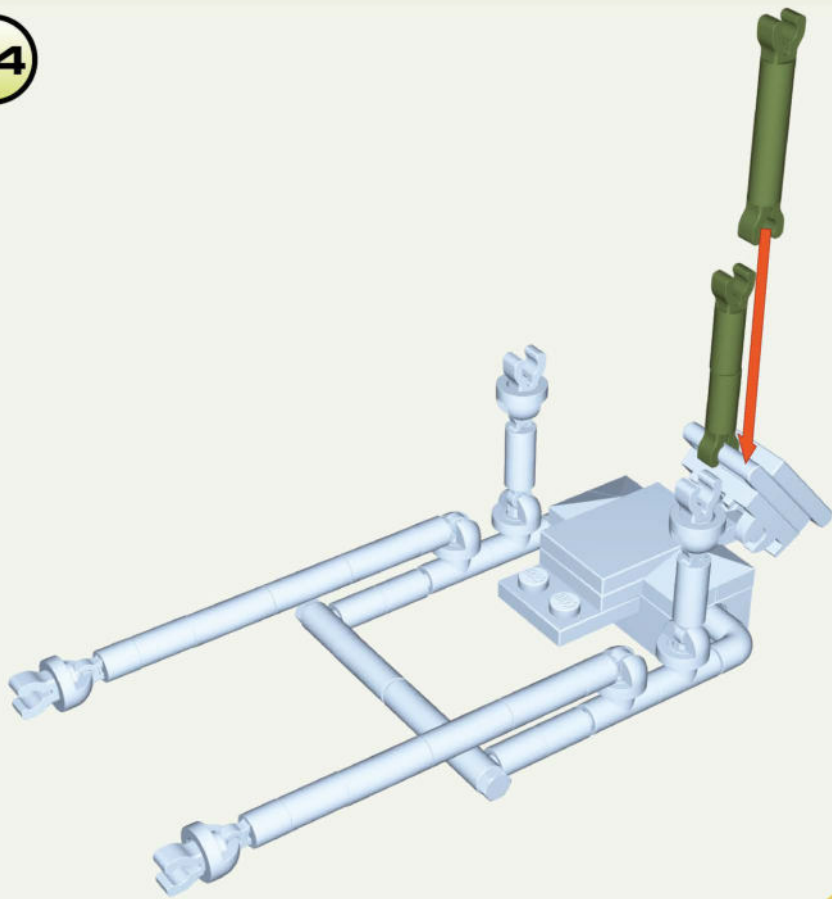

55

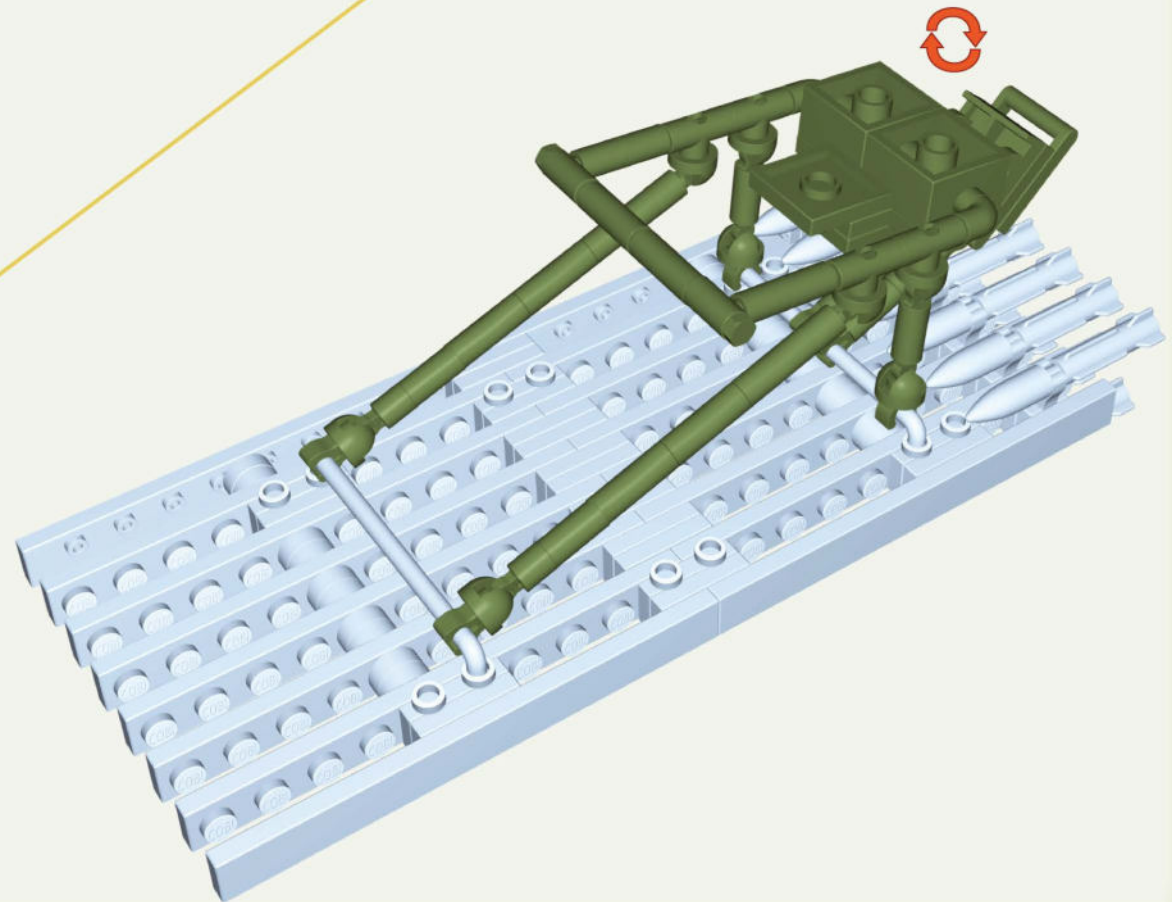
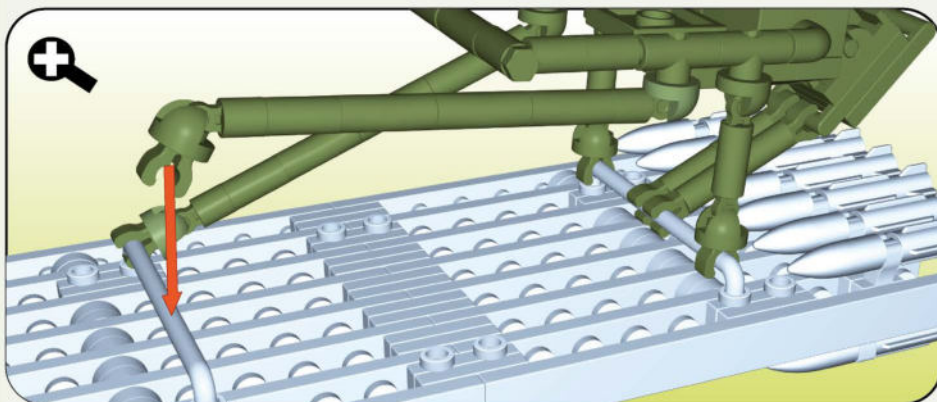

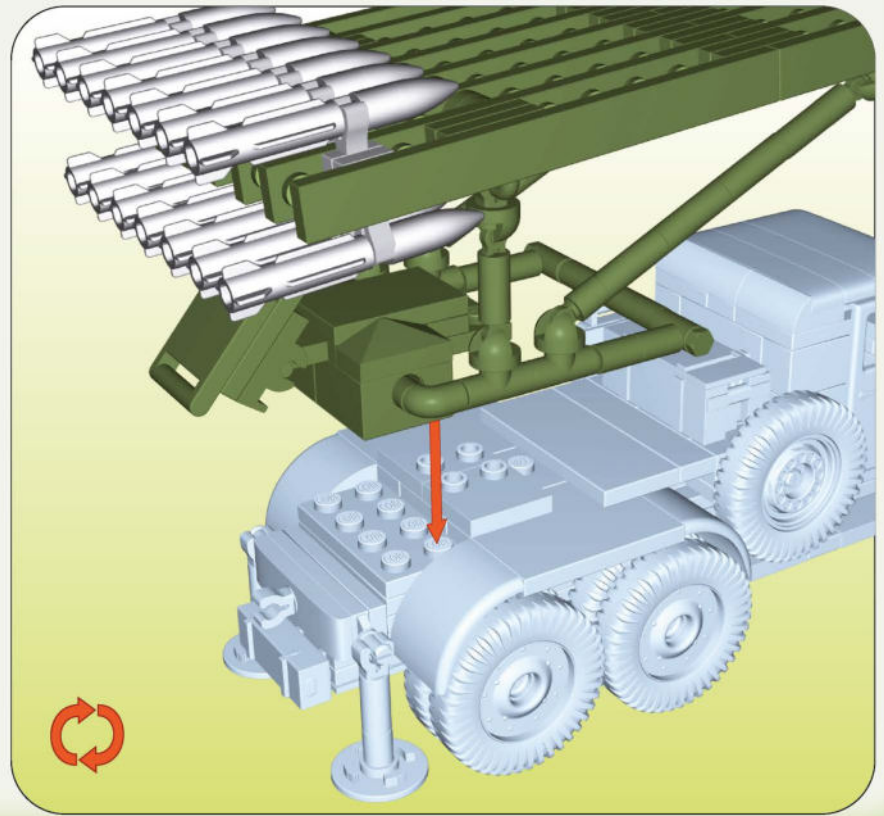
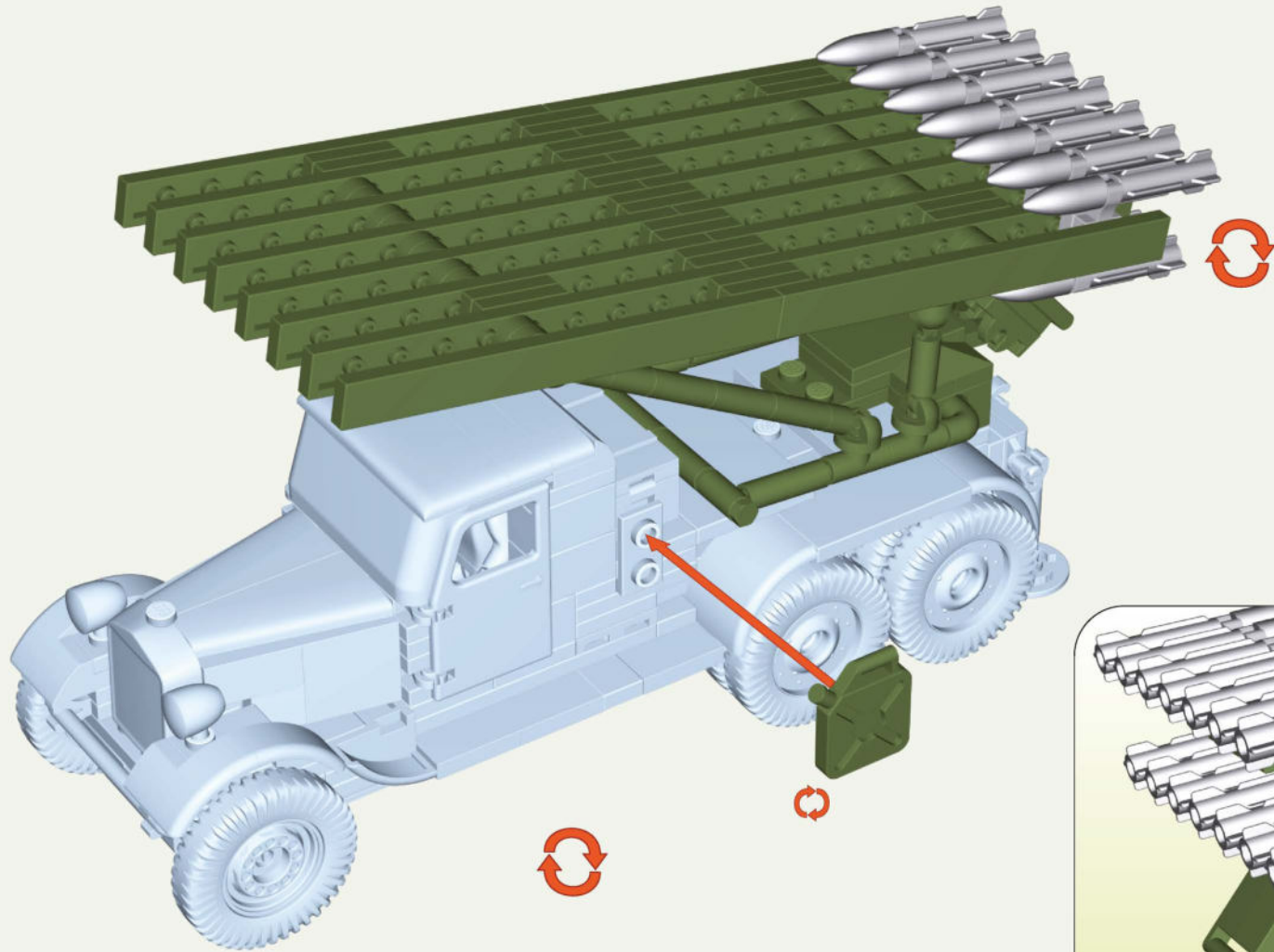

	
x1	x1

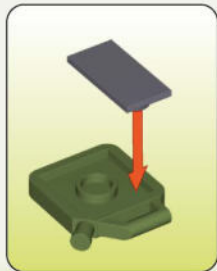

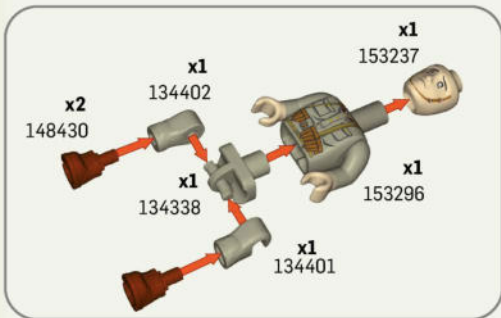
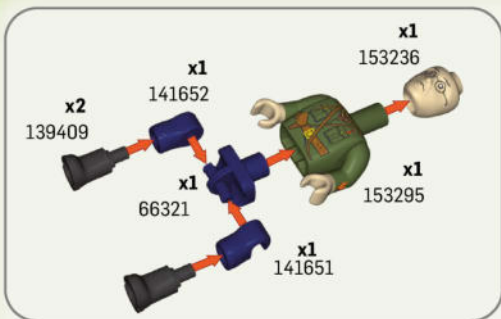





COMPANY OF HEROES 3

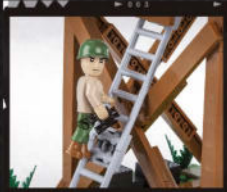

US AIR SUPPORT CENTER

★ 3042



GERMAN FIGHTING POSITION

⊕ 3043



PANZER III Ausf. J
+ 2562



M4A3 SHERMAN
+ 2570



Sd. Kfz. 9/1 „FAMO“
+ 2281



CHURCHILL MK. IV
SCALE 1:48
+ 2717

HISTORICAL COLLECTION

2280

BM-13 KATYUSHA (ZIS 6)



TABLE POINT

1.	➔	23 cm	11.		0
2.	➔	10 cm	12.		0
3.	↔	-5 cm	13.		0
4.	↕	-15 cm	14.		4
5.	➔	+10 cm	15.		-
6.	🎯	5-6	16.		2
7.	↻	6	17.		1
8.	🎲	14	18.		1
9.	💣	8+	19.		120
10.		0	20.		* Available 1941

* -1 to hit with Gun, 'small Target



2280



CROMWELL MK.IV
2269



HISTORICAL COLLECTION



H.M.C M8 SCOTT
2279



Sd.Kfz.7 HALF-TRACK
2275



SHERMAN IC FIREFLY HYBRID
2276

WWW.COBIGAMES.COM

BN-13 KATYUSHA (ZIS 6)



WWW.COBI.EU

For news and special deals

Find us on:
f cobr.bricks
i cobr.klocki
y COBI SA

01-02280-426