

# HISTORICAL COLLECTION WORLD WAR II



**PANZER III AUSF. J (SD.KFZ 141)**  
 IN SERVICE - 1941 - 1945  
 PLACE OF ORIGIN - GERMANY  
 TYPE - MEDIUM TANK  
 WEIGHT - 21,5t (47,399Lb)  
 ARMOUR - 57mm (2.2") MAX AT THE FRONT  
 ENGINE - MAYBACH HL 120 TRM  
 ARMAMENT - 5cm (2") KWK 39 L/60 GUN  
 or 5cm (2") KWK 38 L/42 GUN,  
 2x 7,92mm (.312") MG 34  
 SPEED - 40km/h (24,9MPH)  
 CREW - 5

Panzer III Ausf. J

**PAD PRINTED  
NO STICKERS**

**Printed in EU**

2562



**WARNING: CHOKING HAZARD-**  
 Toy contains small parts.  
 Not for children under 3 years.

780 2

**Panzer III Ausf. J**

**SCALE 1:28**

BE CAREFUL: NOTICE THE DIFFERENCE

A



B



C



D



E



F



G



H



1

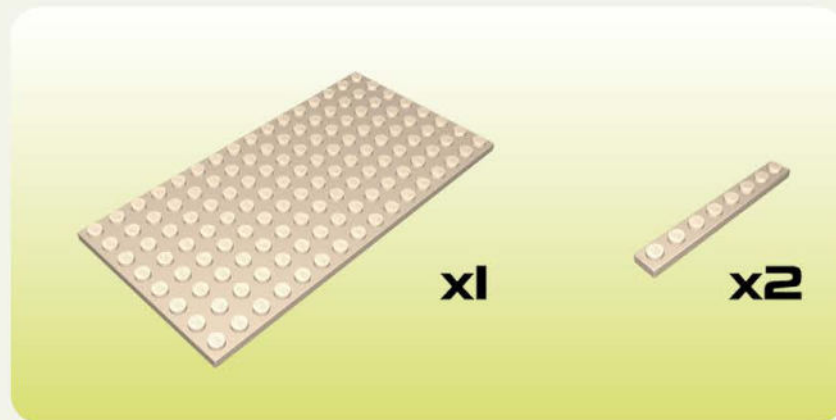
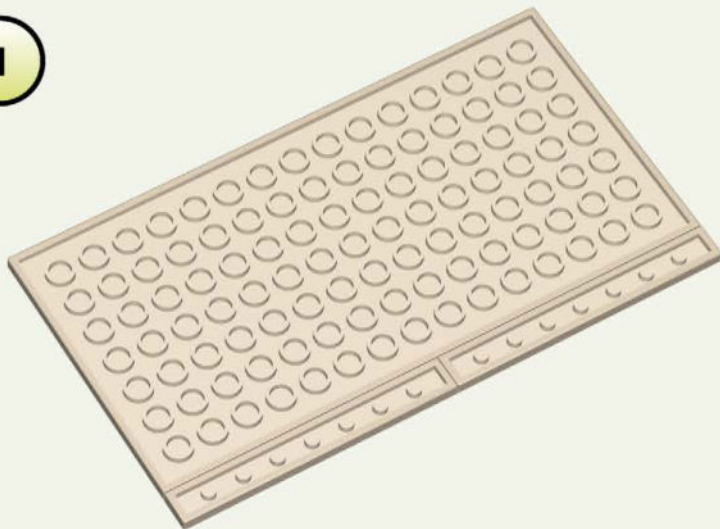

2

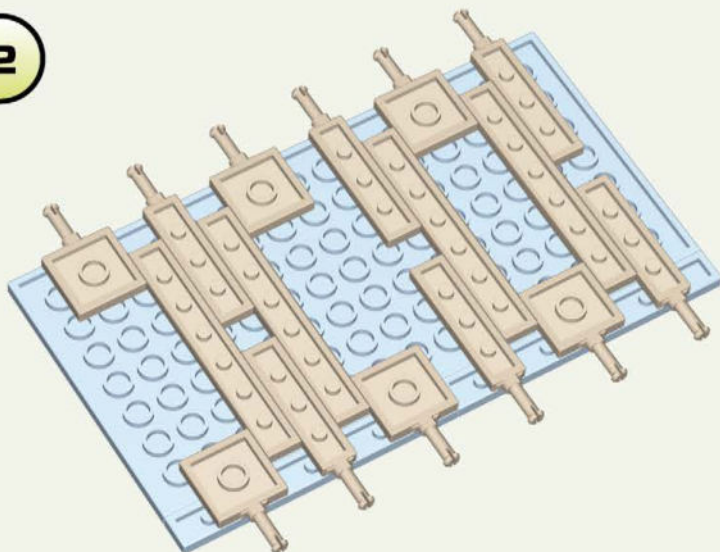

3

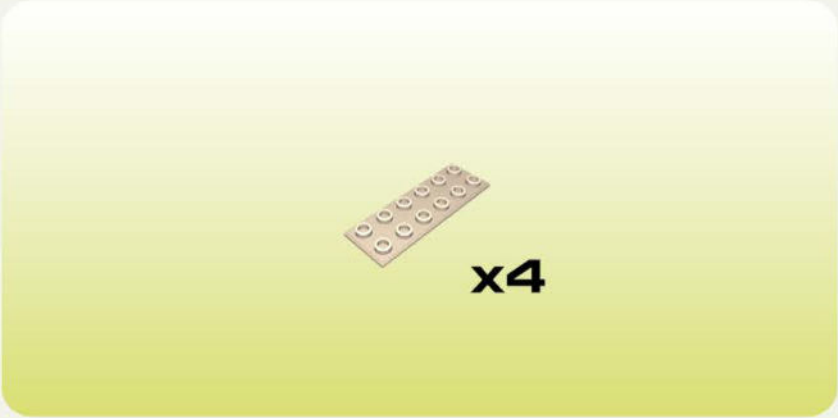
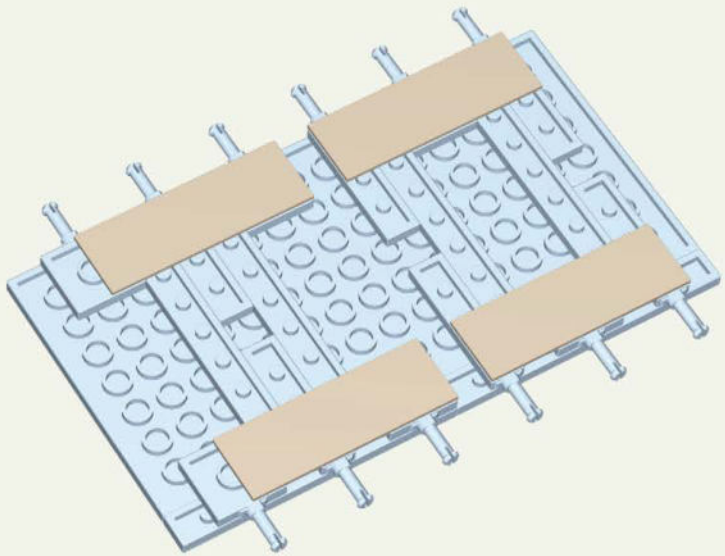

4

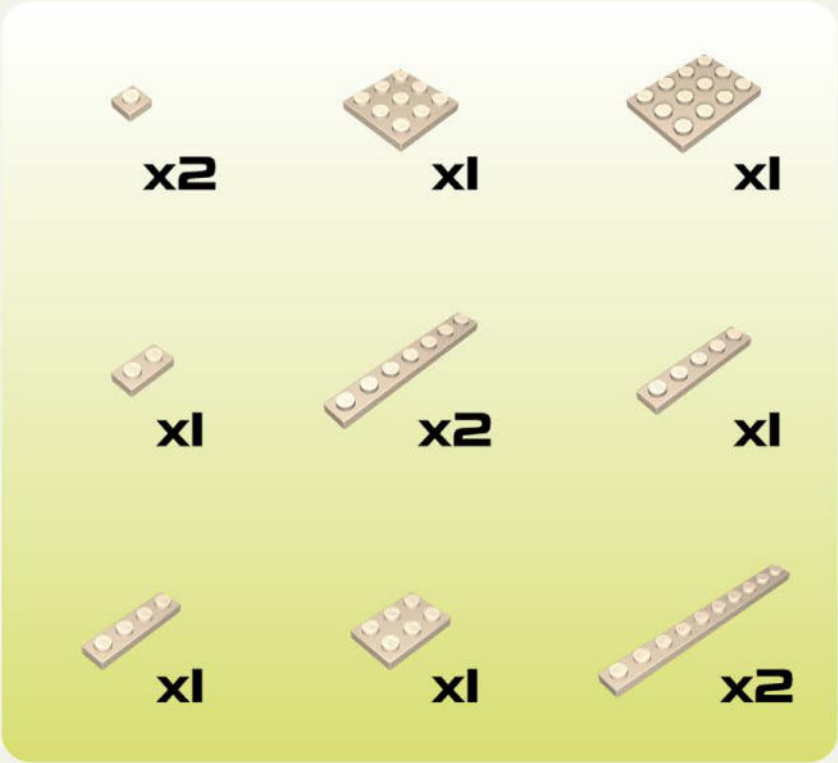
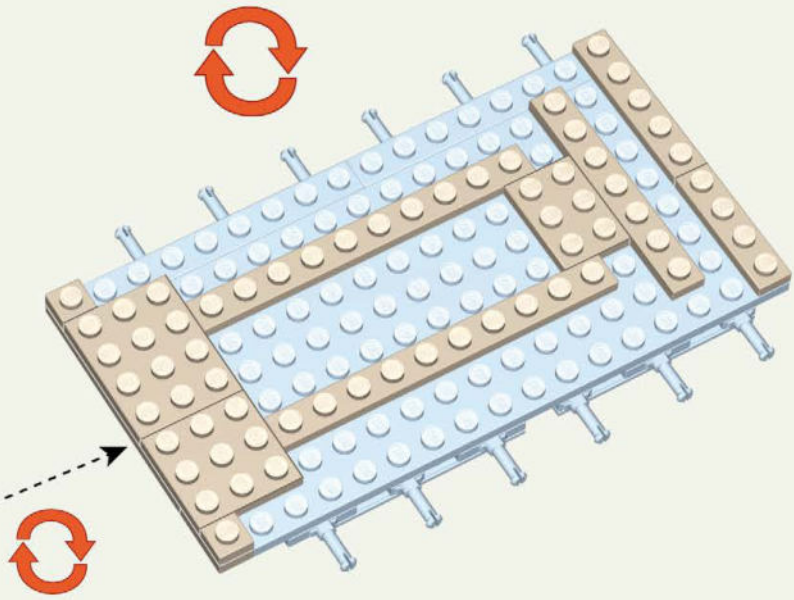
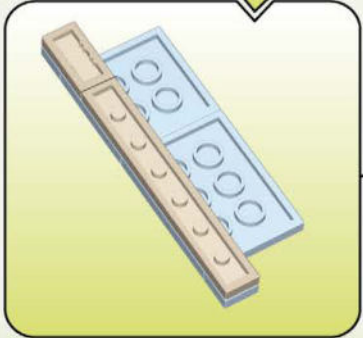
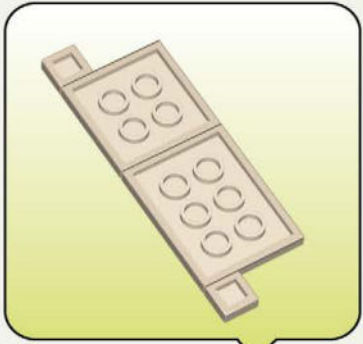

5

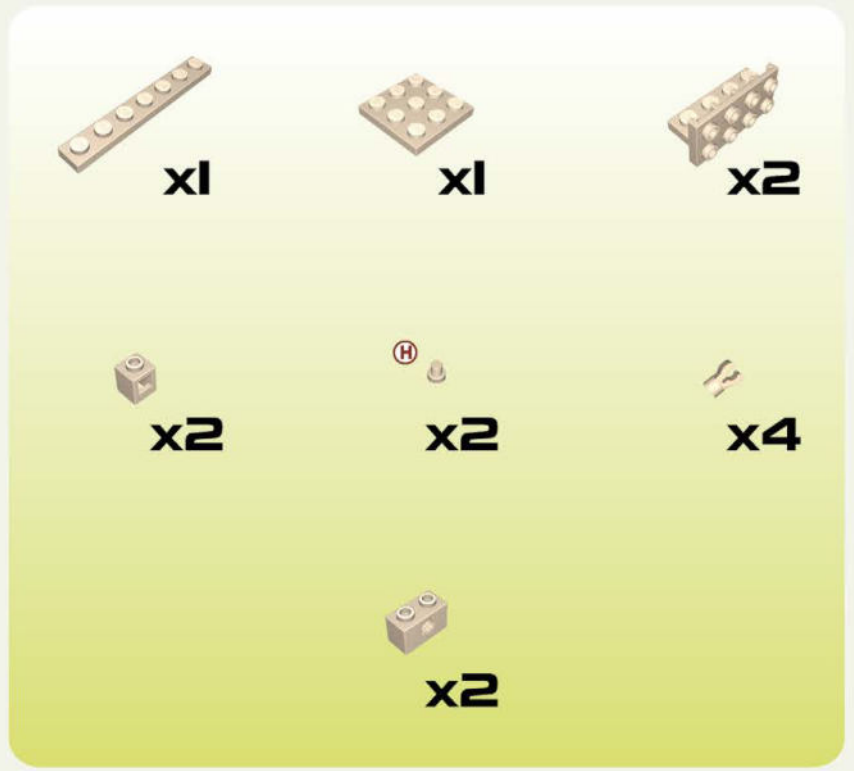
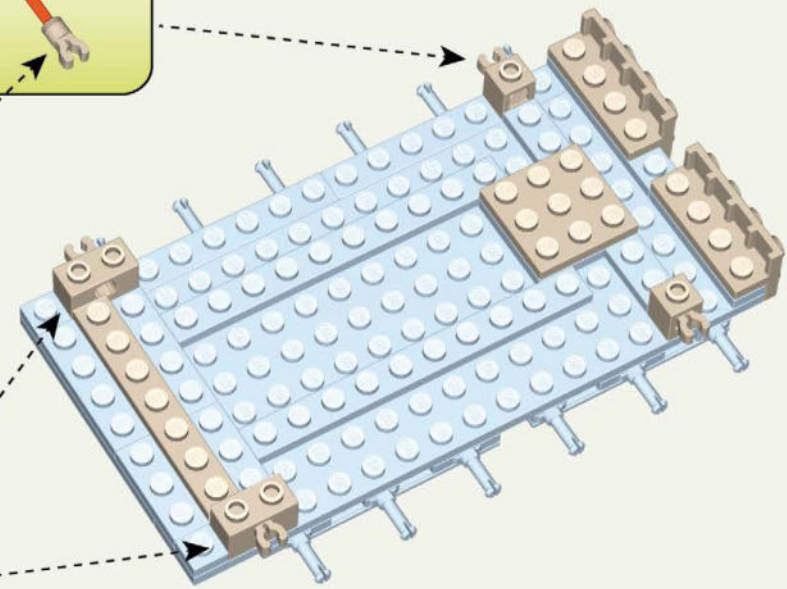
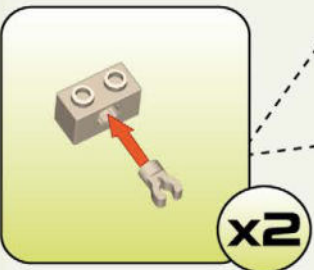
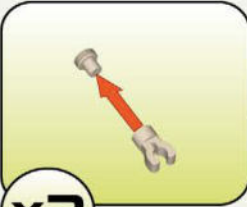
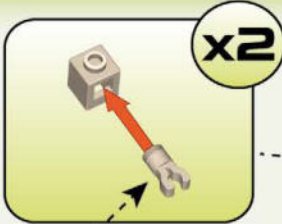

6

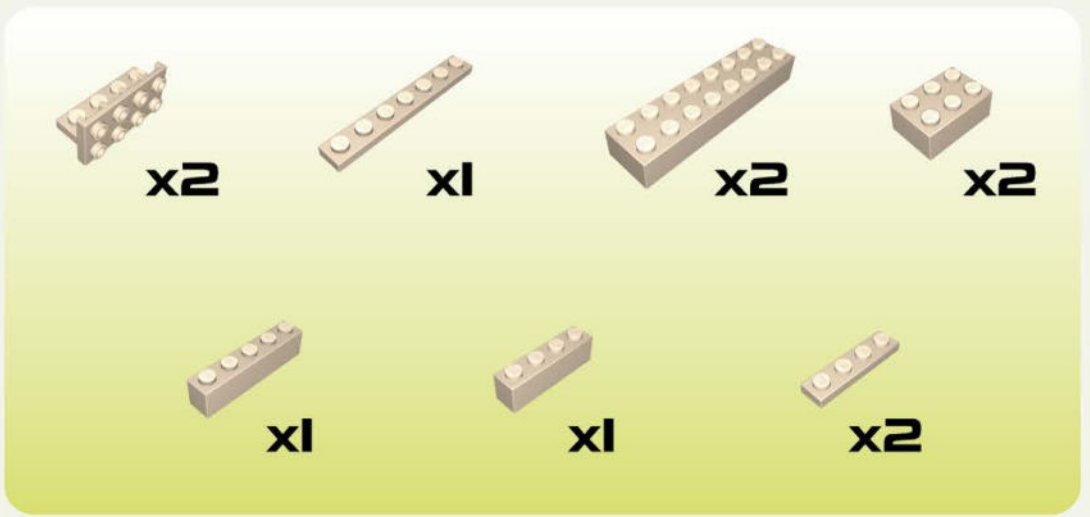
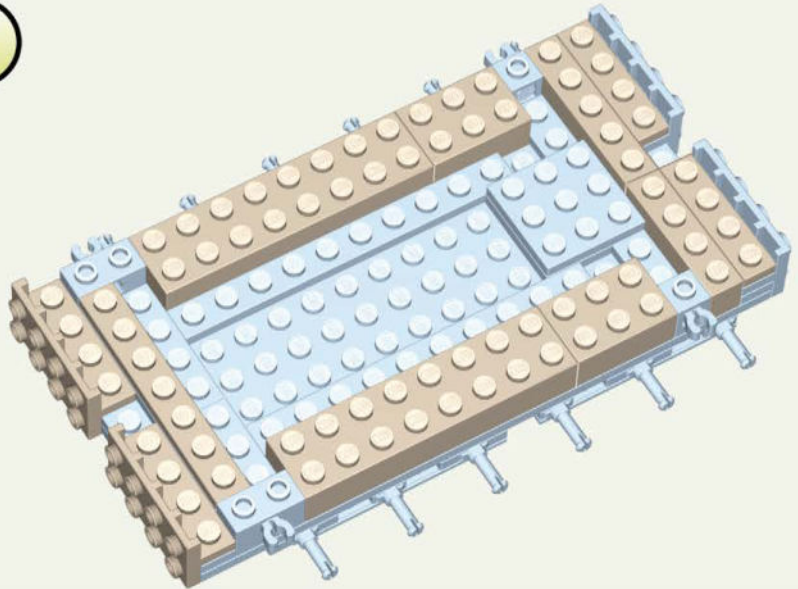



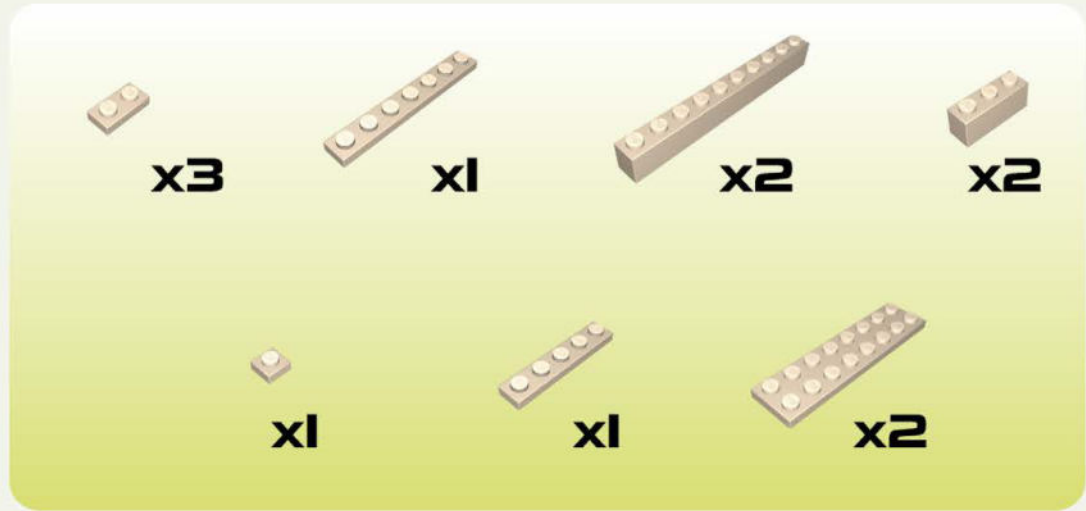
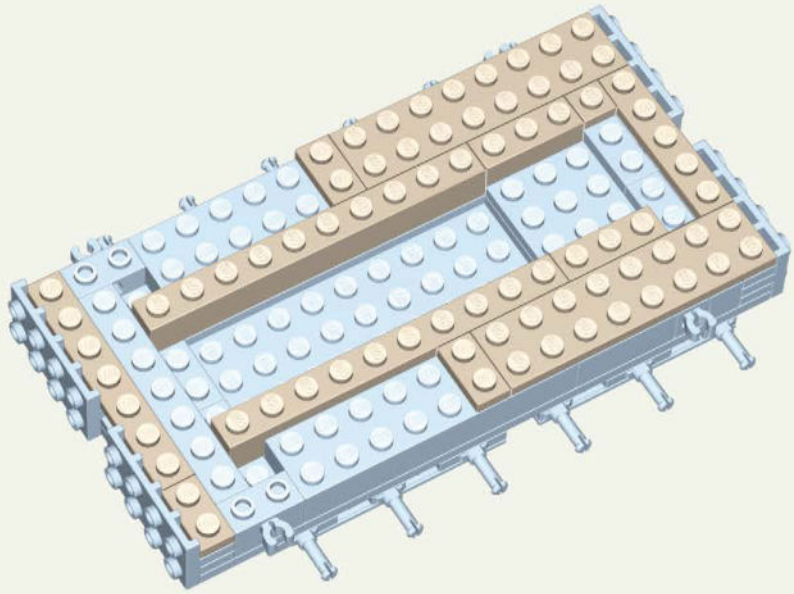



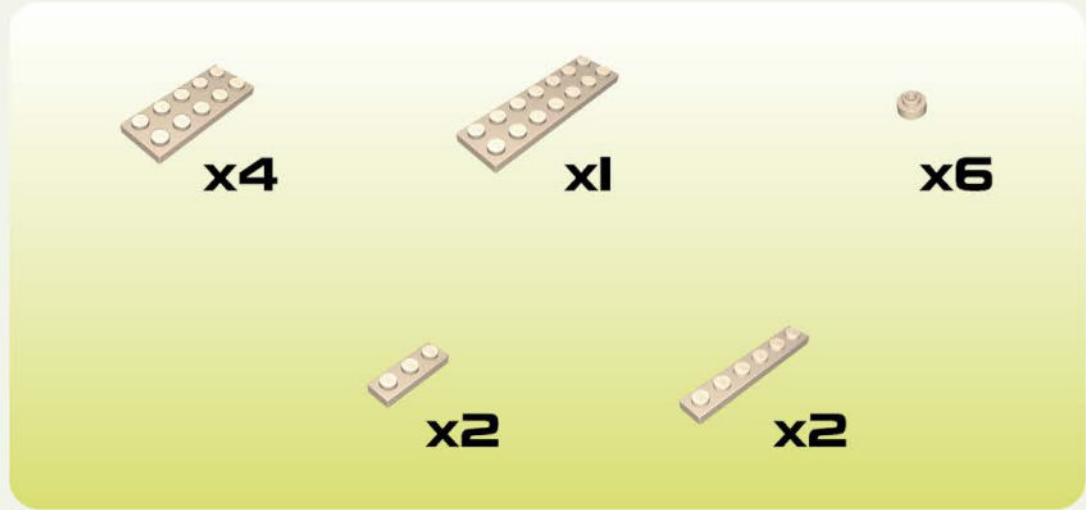
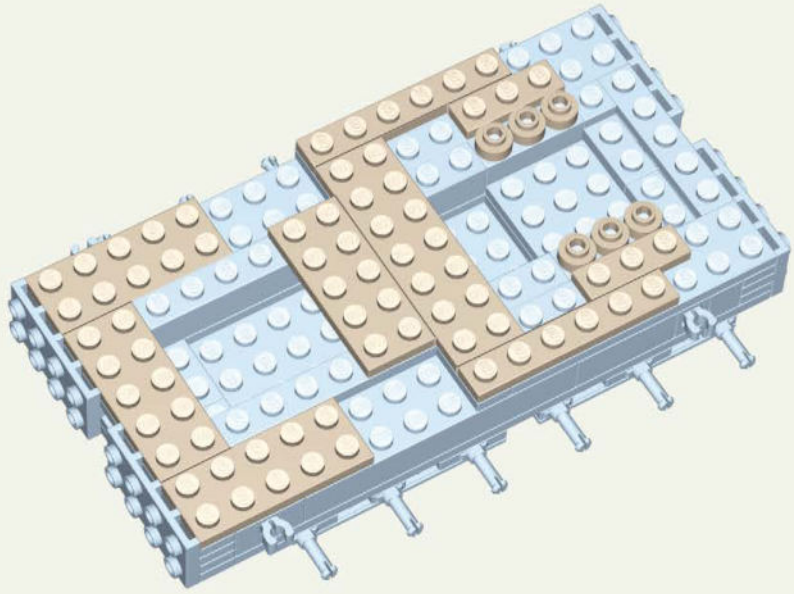

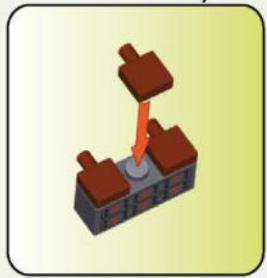
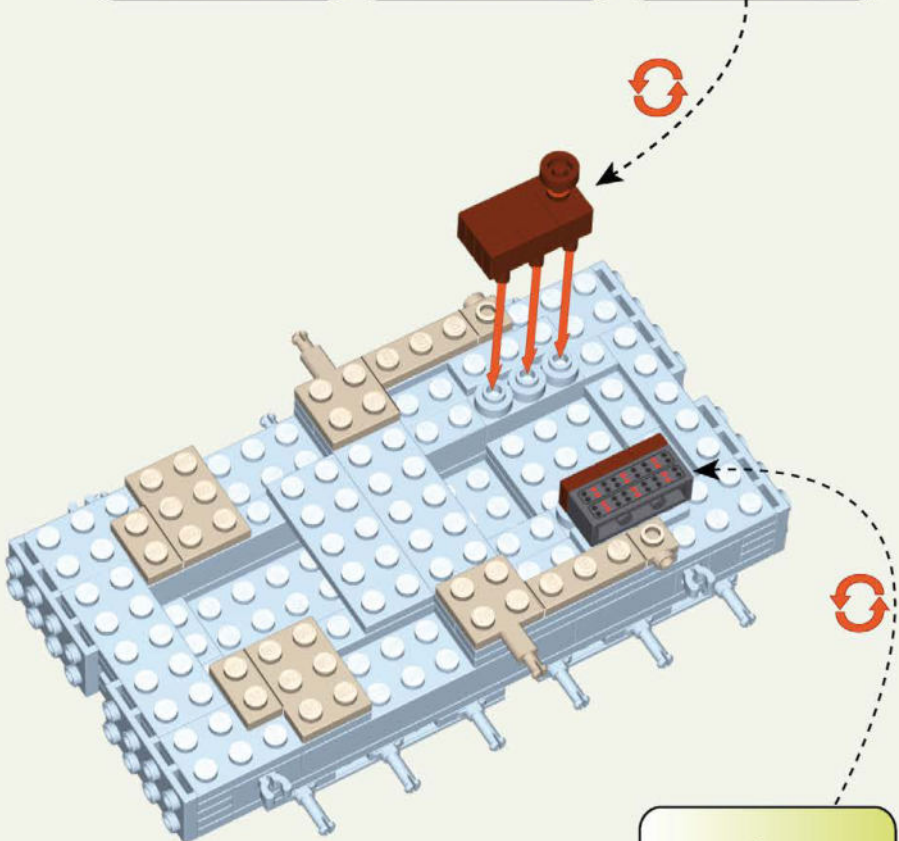



7



8





- |   |   |
|---|---|
| <br>x2   | <br>x2   |
| <br>x2   | <br>x2   |
| <br>x2   | <br>x1   |
| <br>x1   | <br>x2   |
| <br>x6 | <br>x1 |
| <br>x1 | <br>x1 |

10

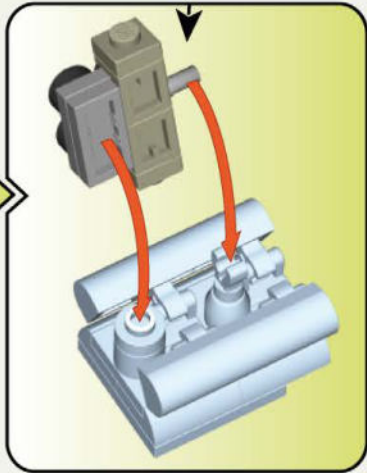
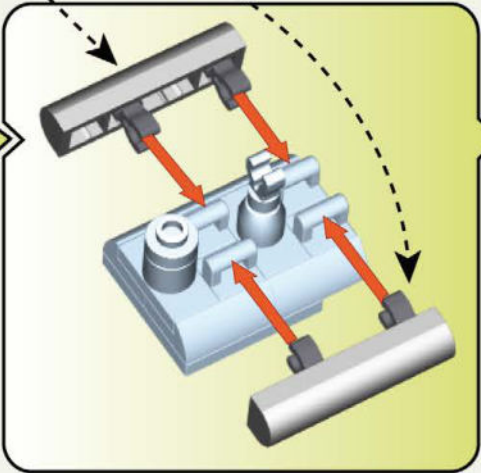
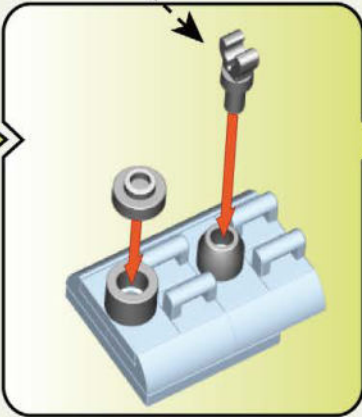
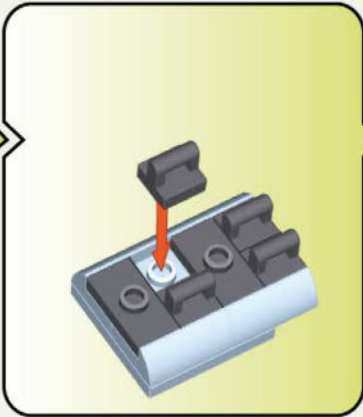
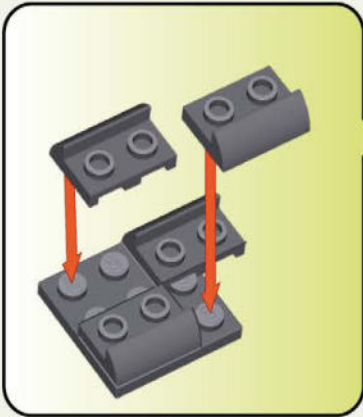
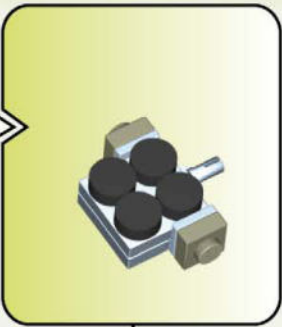
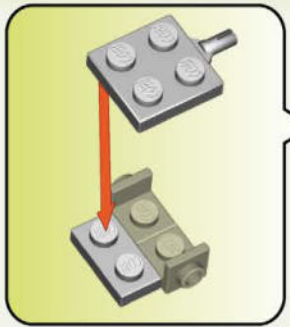
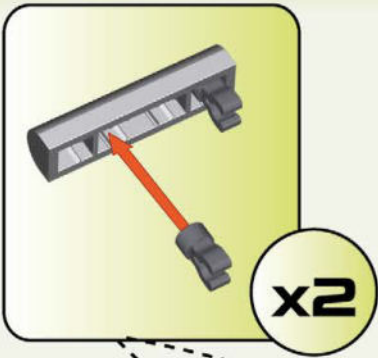
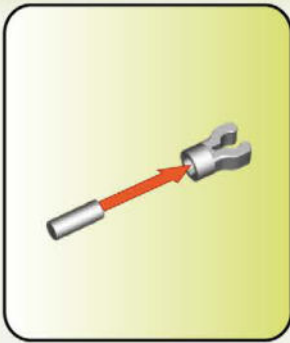

II

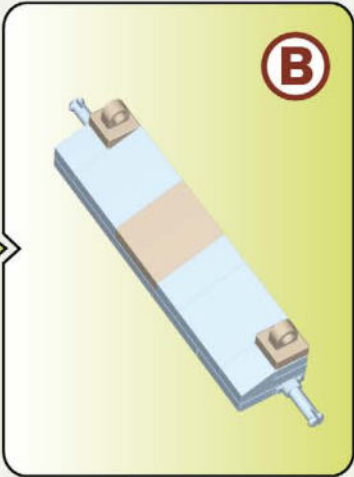
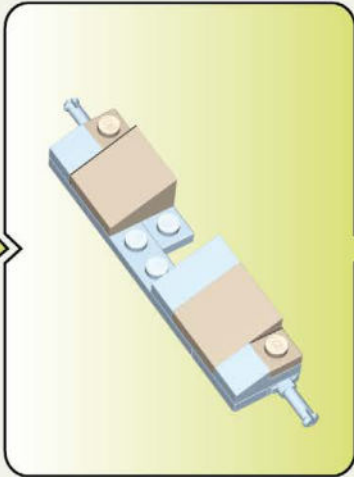
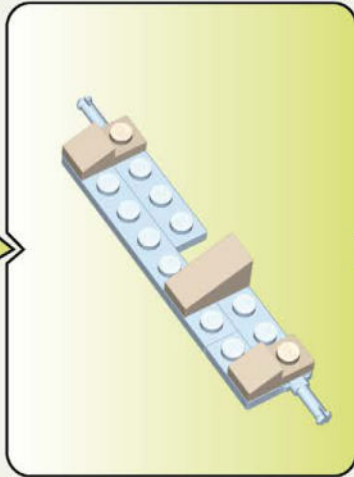
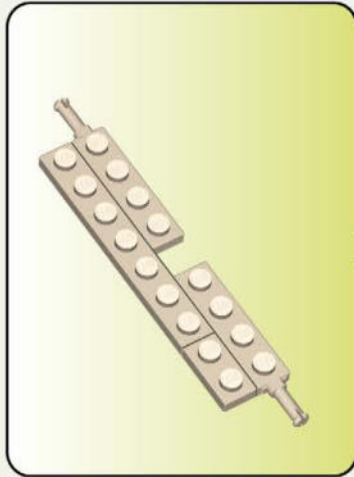
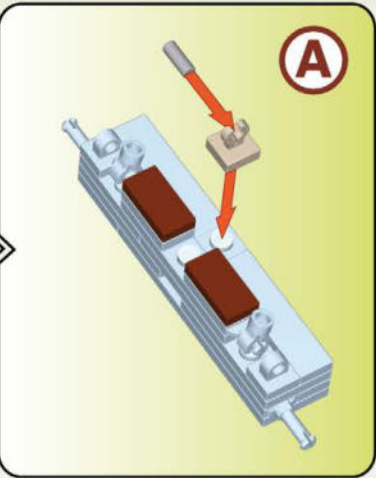
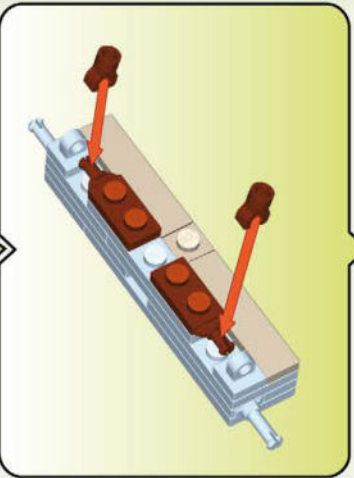
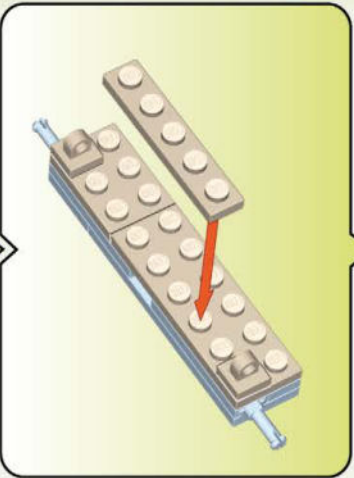
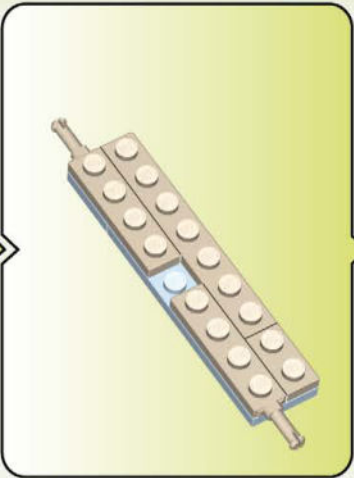
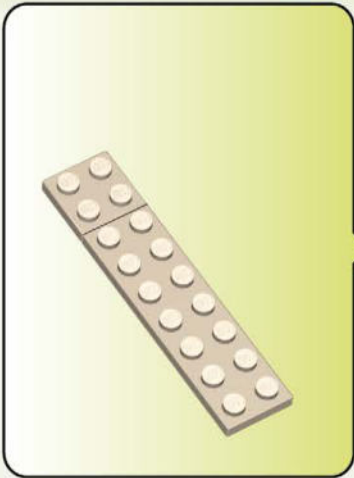

x1



x1



x4



x2



x2



x1



x1



x4



x1



x2



x3



x2



x2



x2



x2

Ⓓ



x1

Ⓑ



x3



x1



x1

1:1

1:1



12

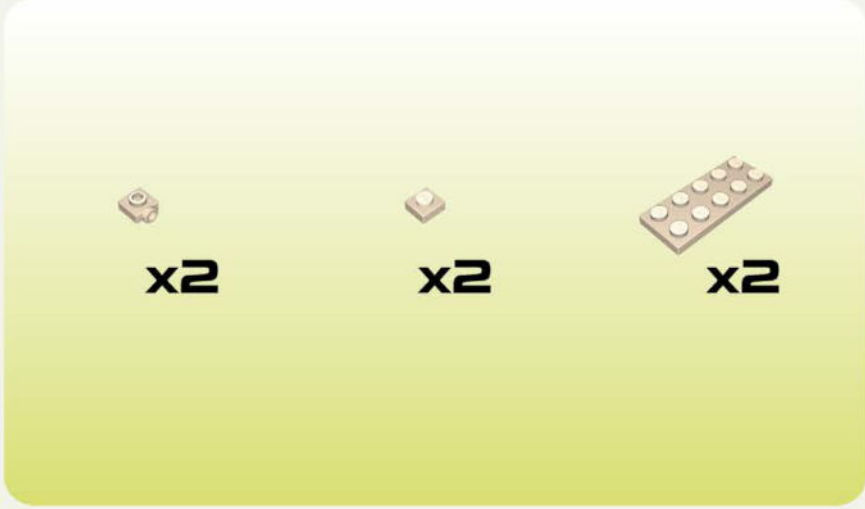
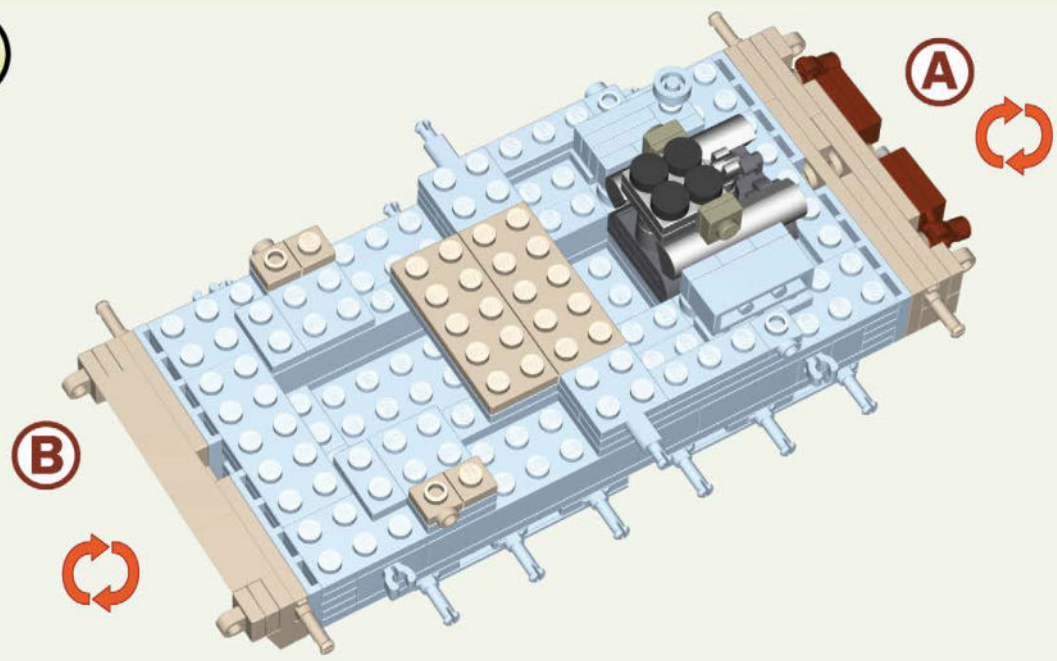

13

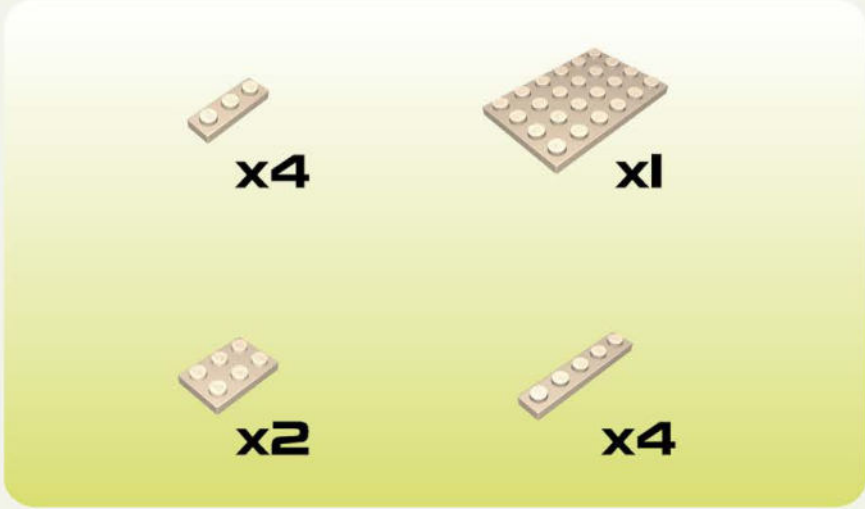
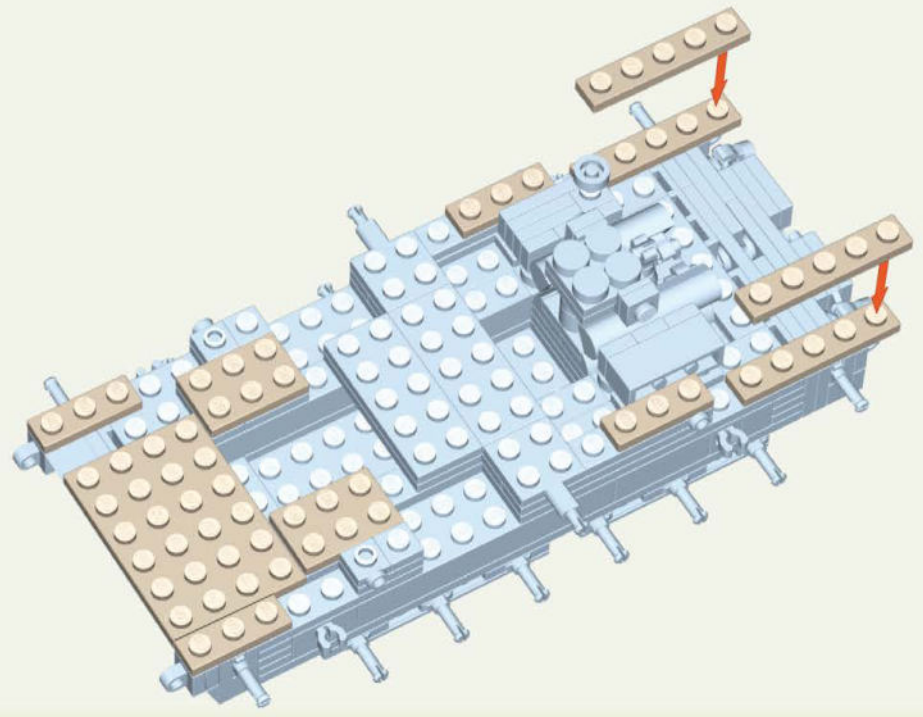

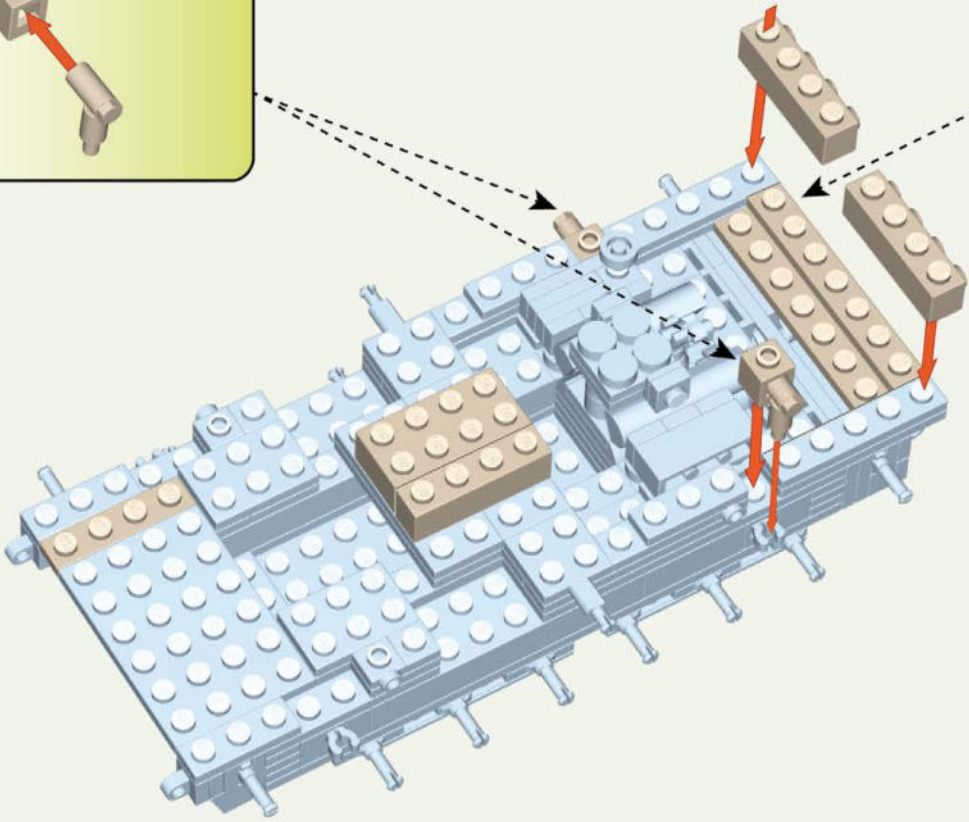
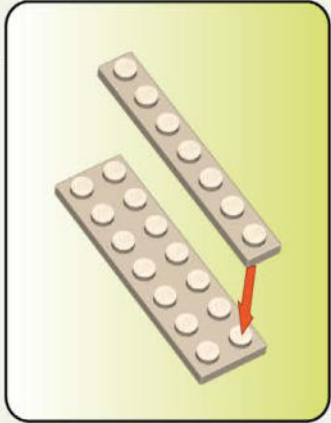
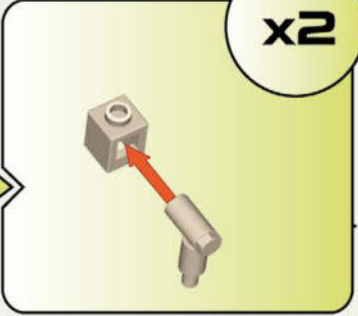
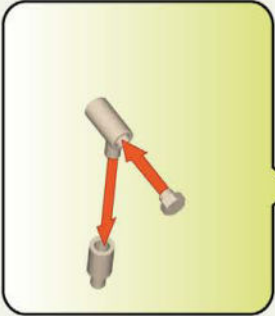

x1



x1



x1



x2



x2



x2



x2



x1



x1



x2

15

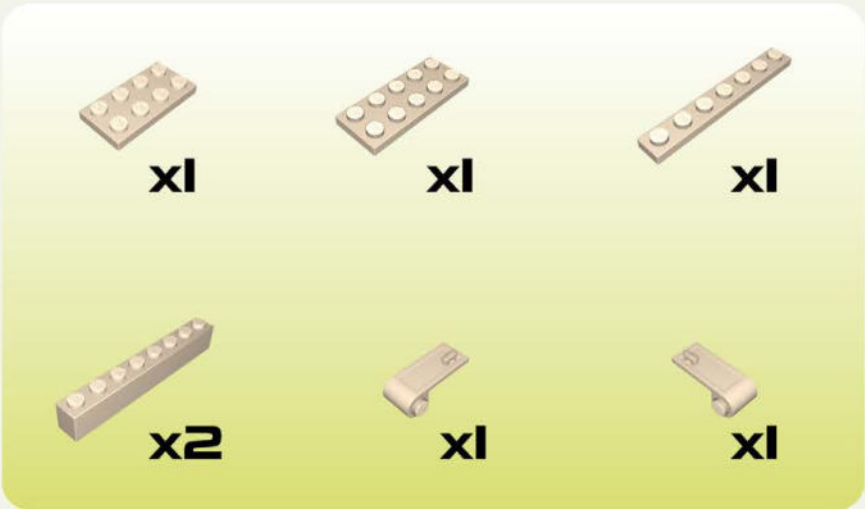
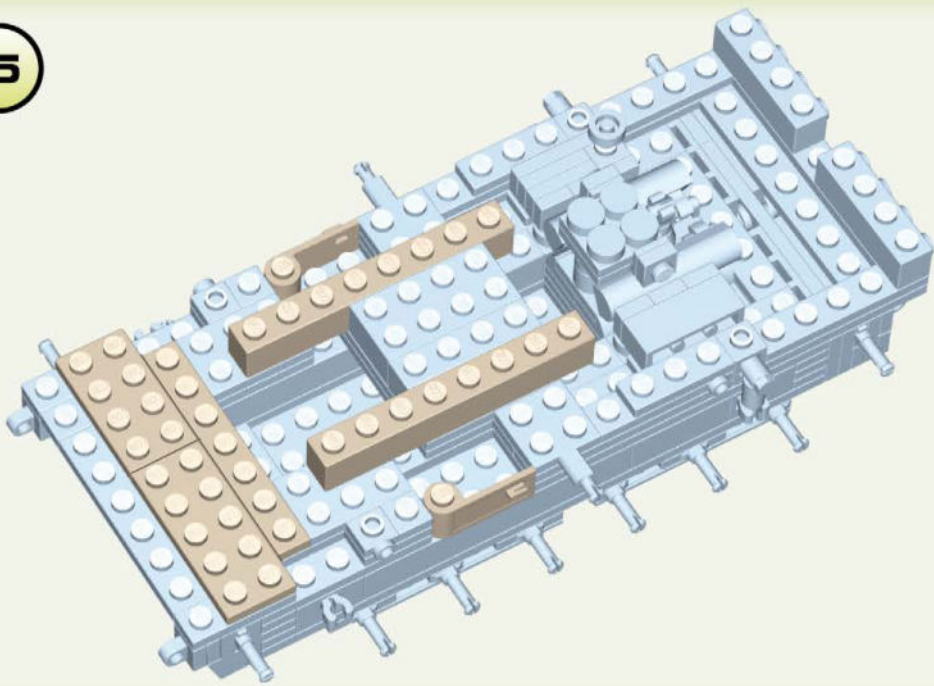

16

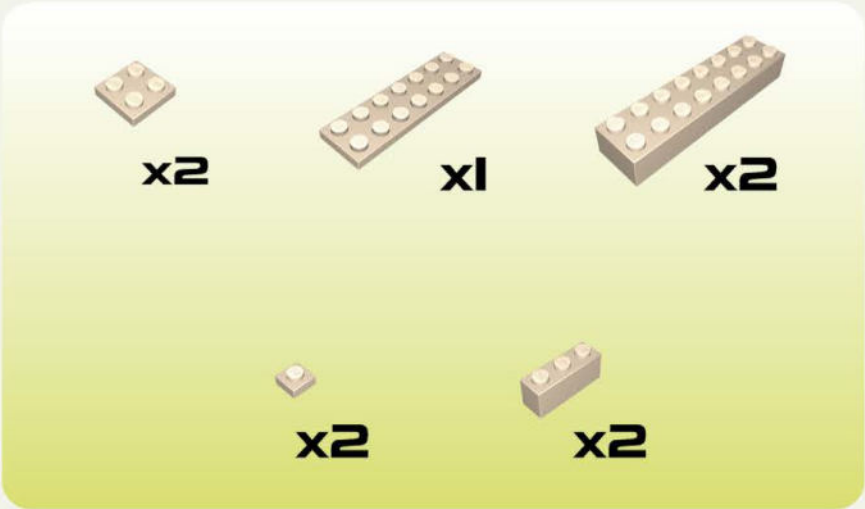
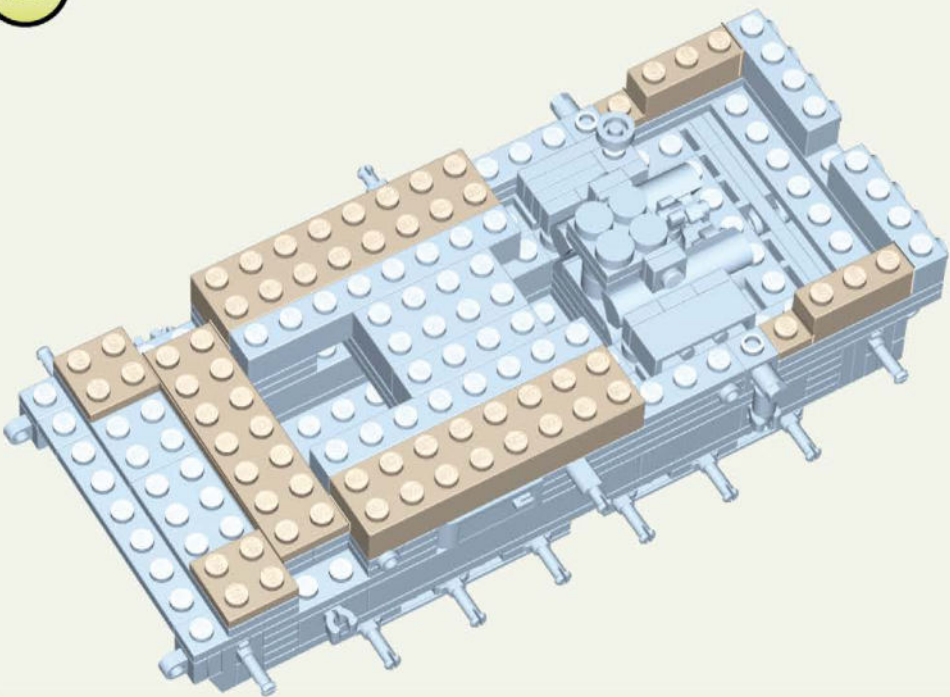

17

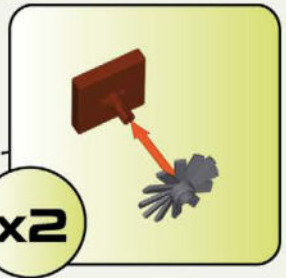
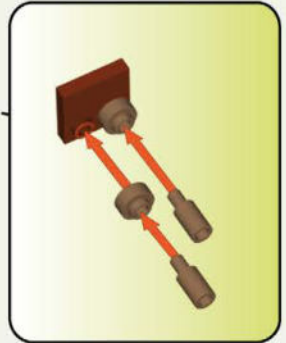
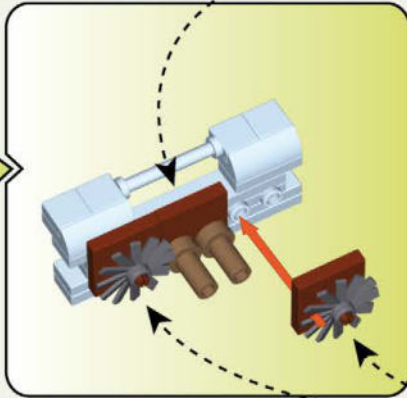
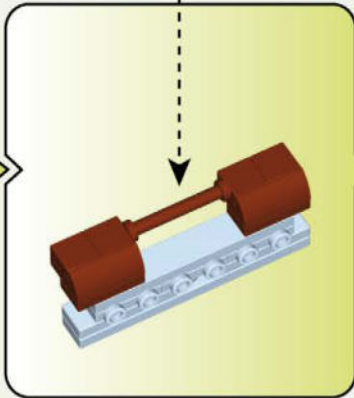
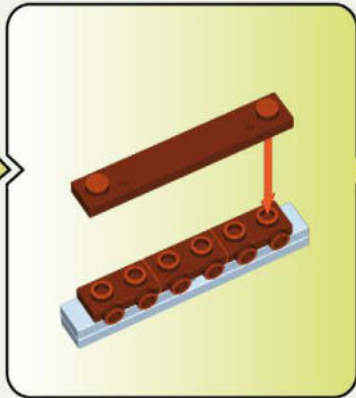
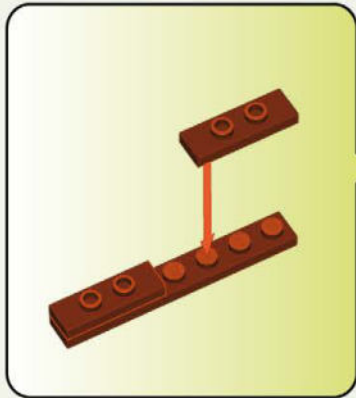
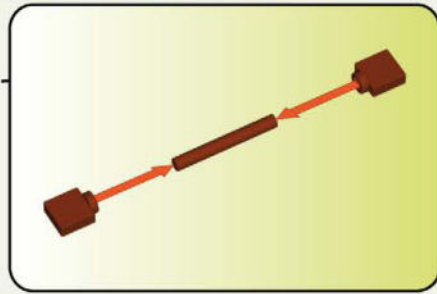
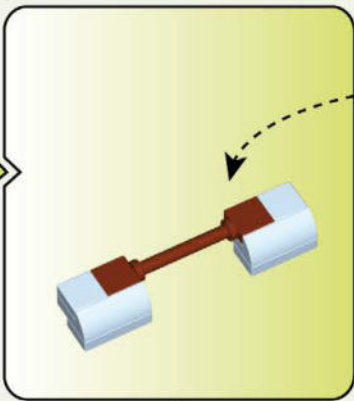
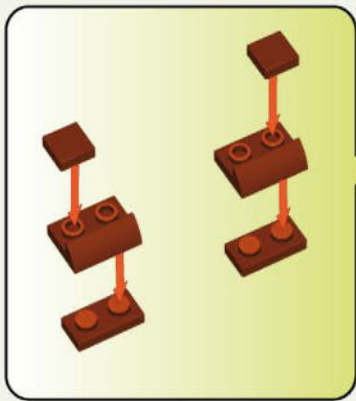

x2



x1



x2



x3



x1



x2



x2



x2



x2



x1



x1



x2



x2



x2



x2

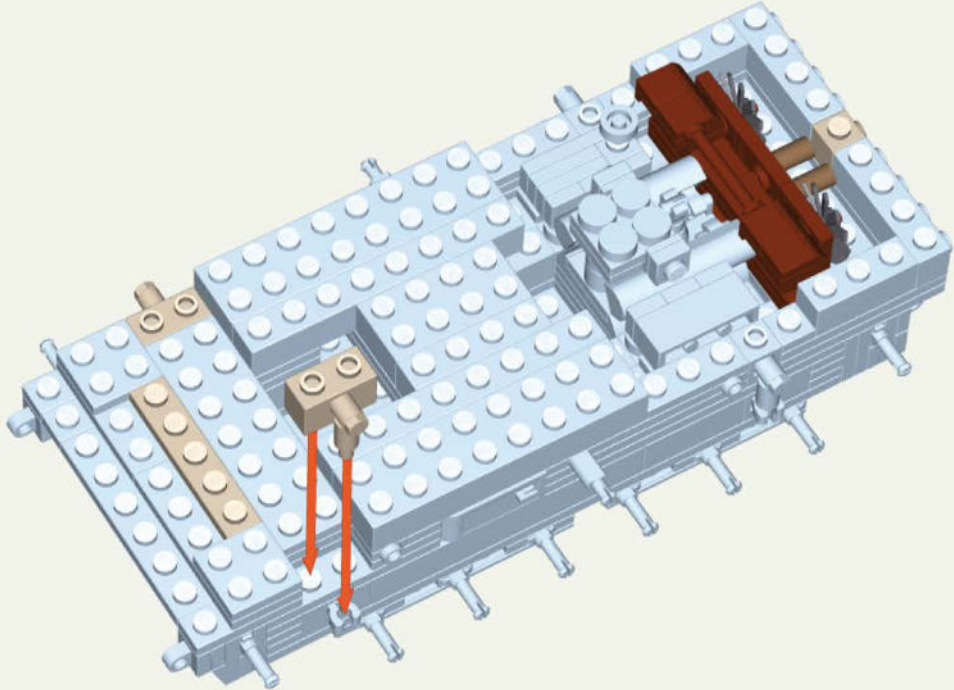
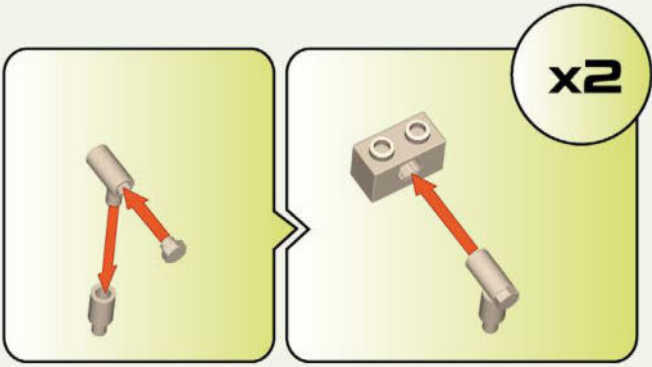

x1



x1



x2



x2



x2



x2

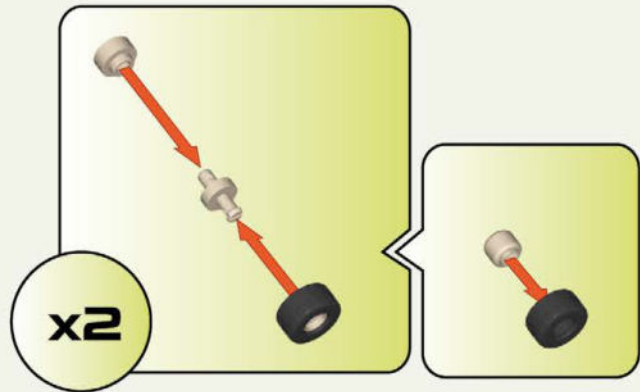
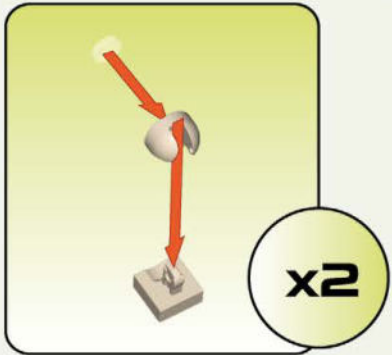
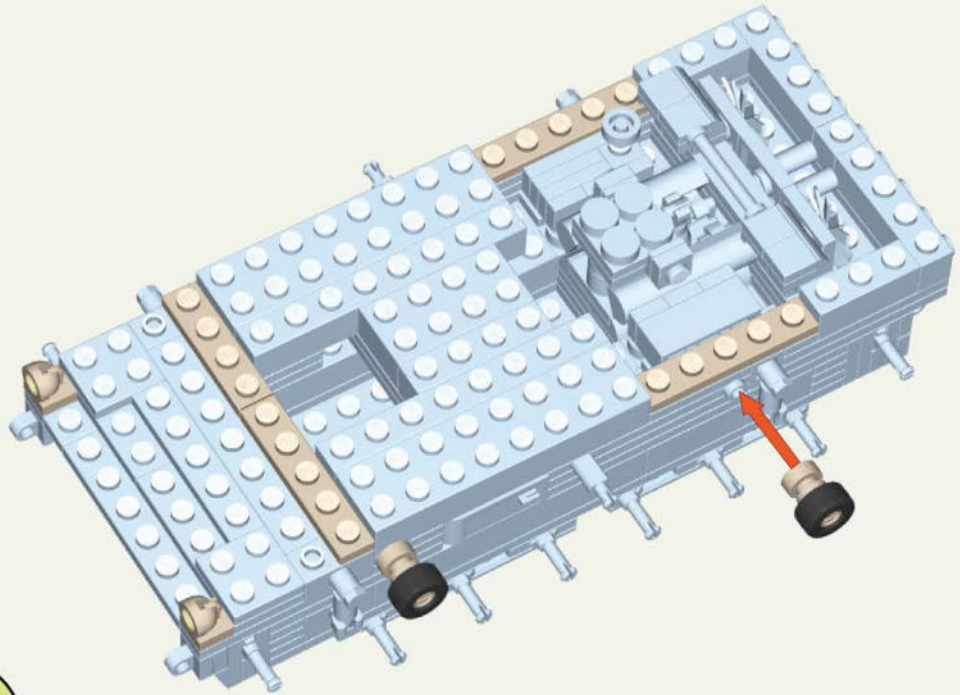

x3



x1



x2



x2



x2



x2



x2



x2



x2

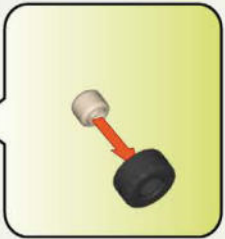
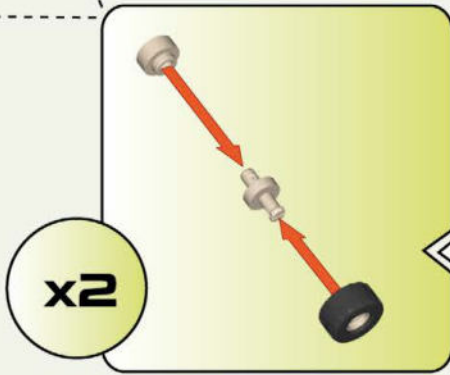
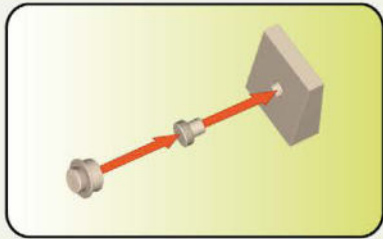
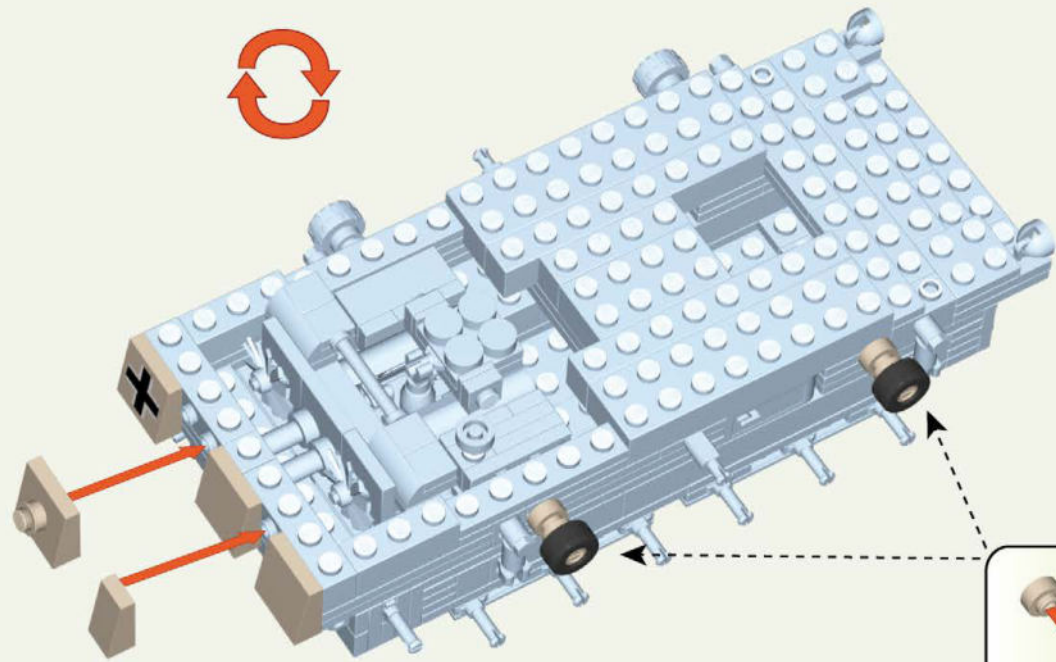

- x1
- x1
- x1
- x2
- x1
- x1
- x2
- x2
- x2
- x2

21

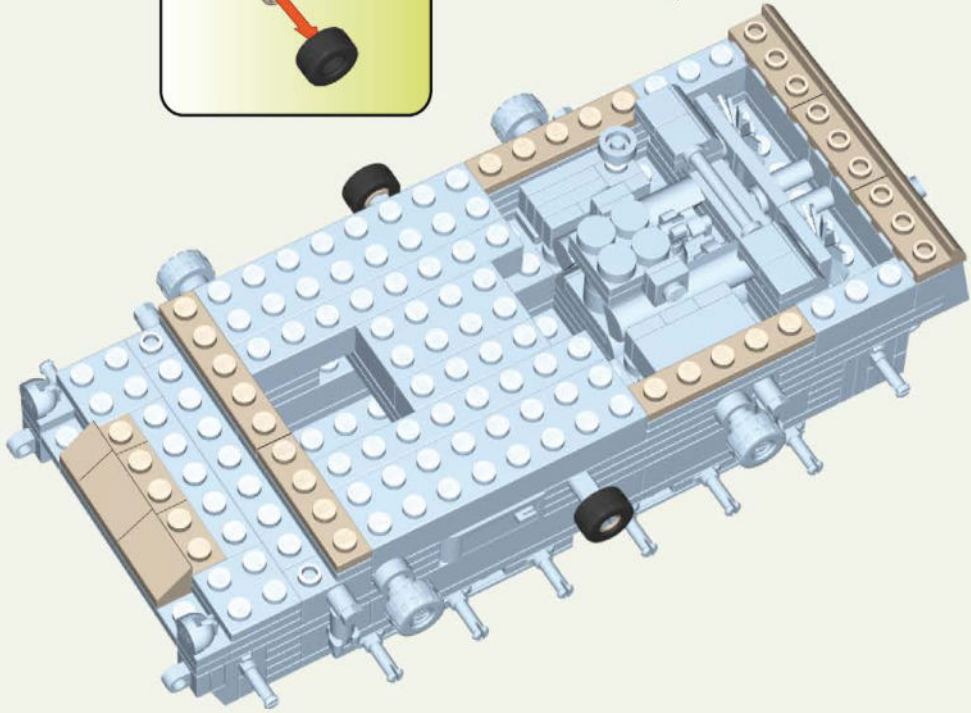
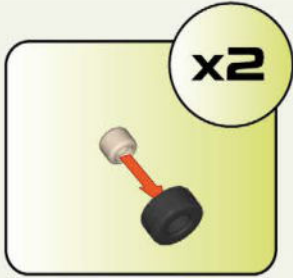

22

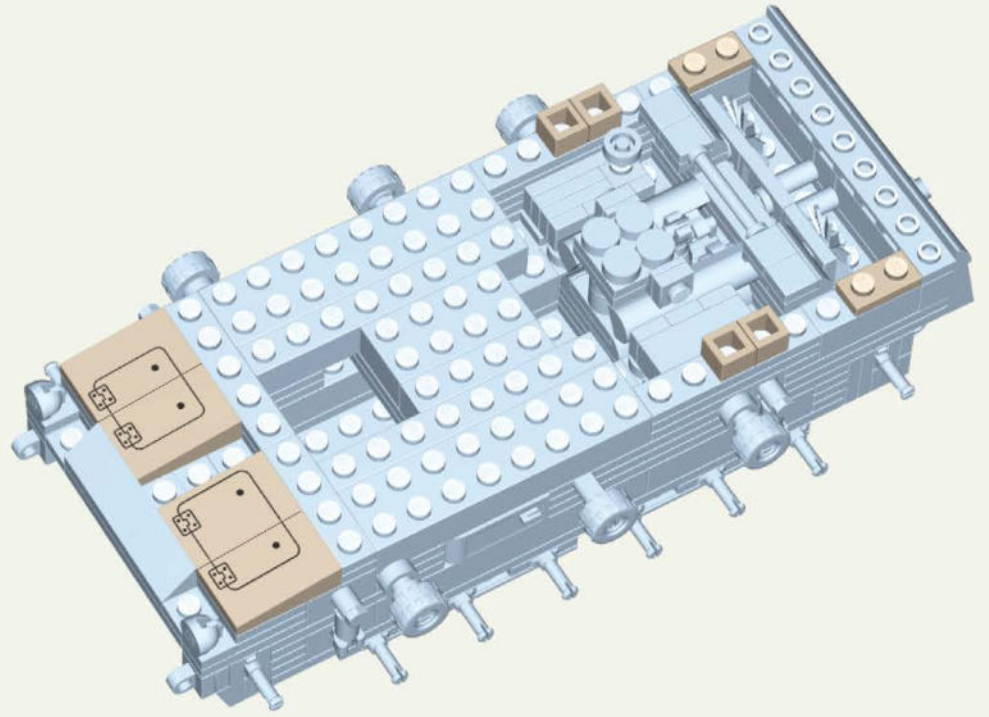

x3



x3



x1



x2



x1



x2



x2



x2



x4



x1



x1



x1



x1



23

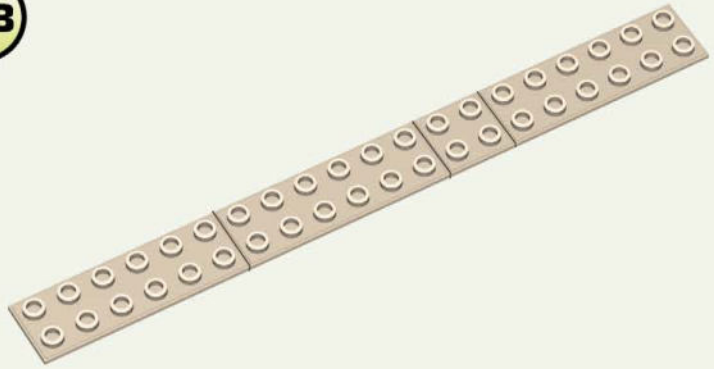

x3



x1

24

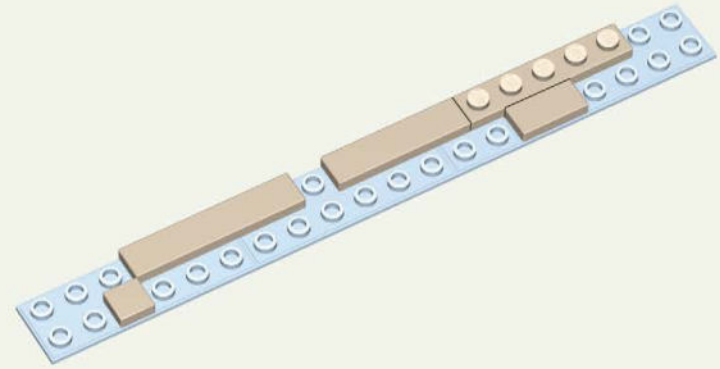

1:1

1:1

1:1



x1



x1



x1



x1



x1

25

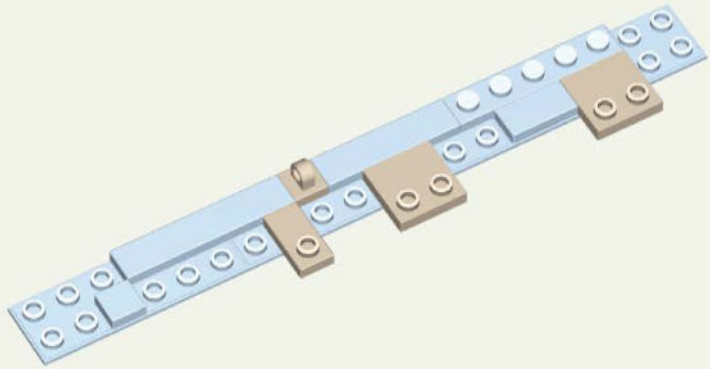

x1



x1



x2

26

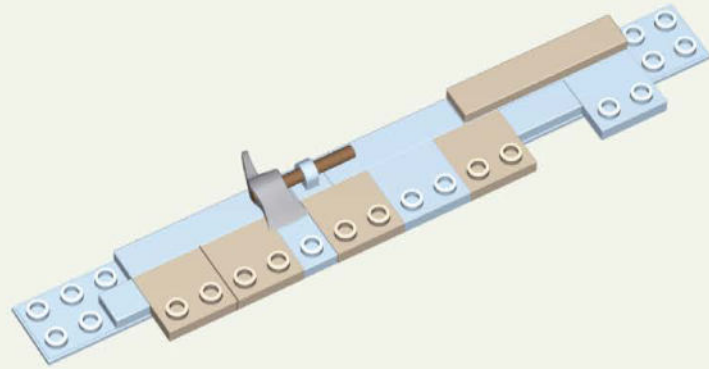
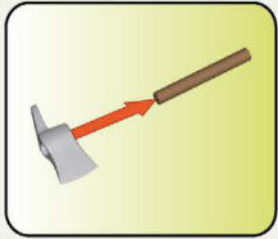

1:1

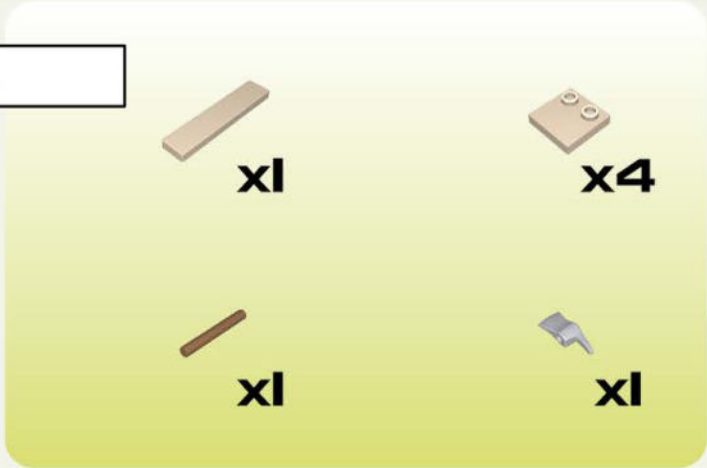

27

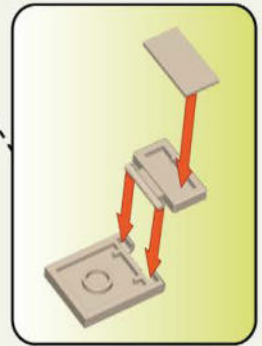
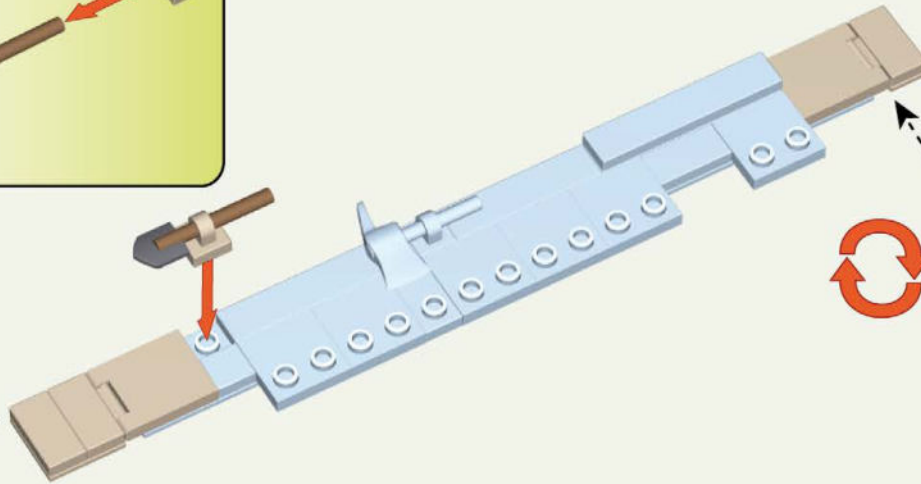
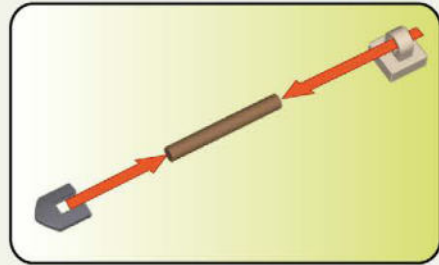
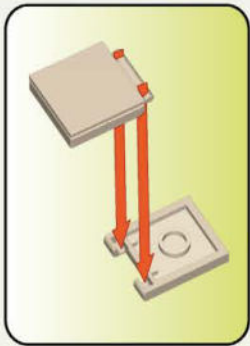

1:1



28

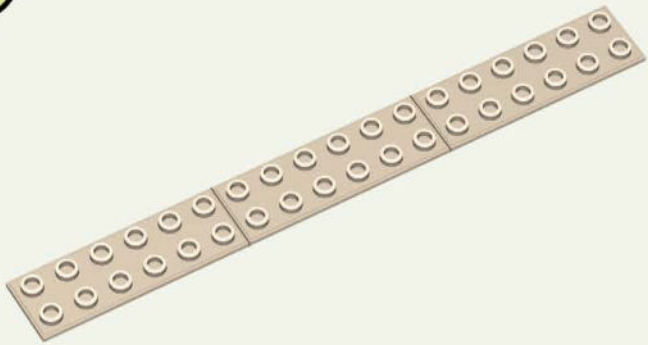

x3

29

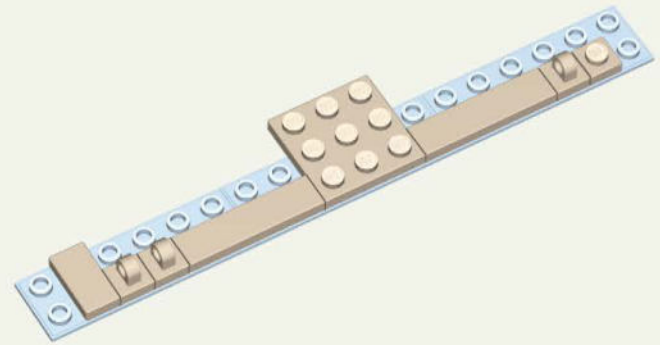

1:1

1:1



x2



x1



x3



x1



x1

30

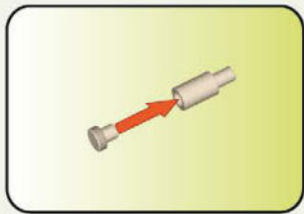
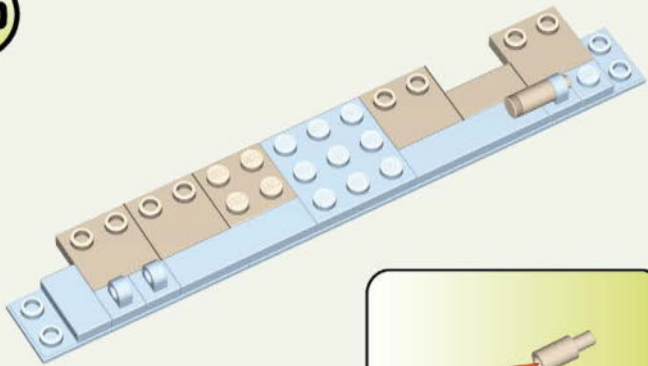

1:1



x4



x1



x1



x1



x1

31

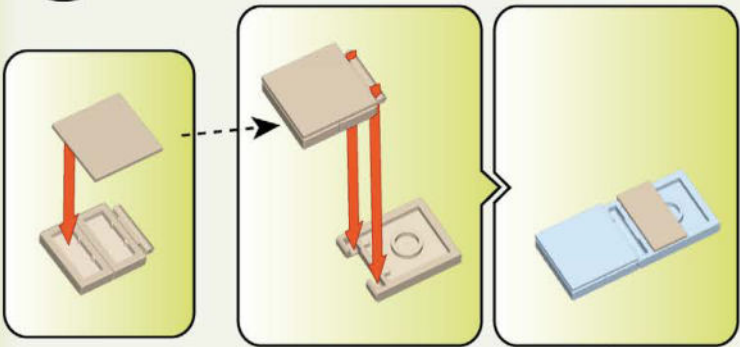

1:1



x1



x2



x1



x2



x3

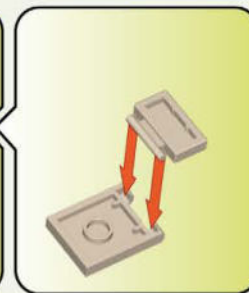
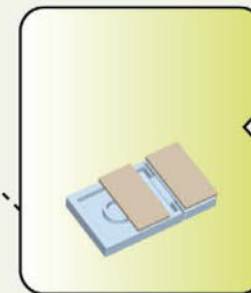
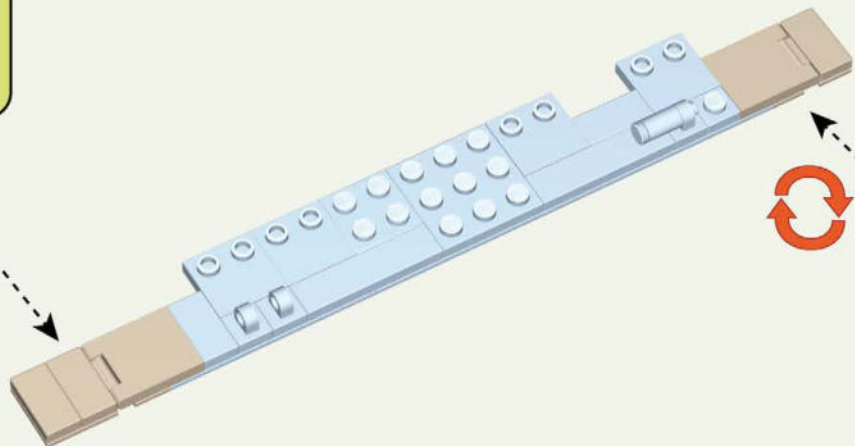

32

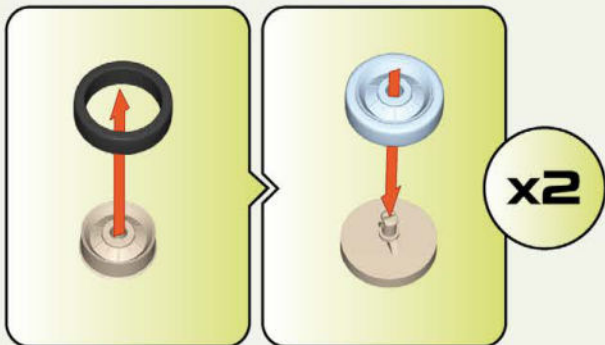

x2

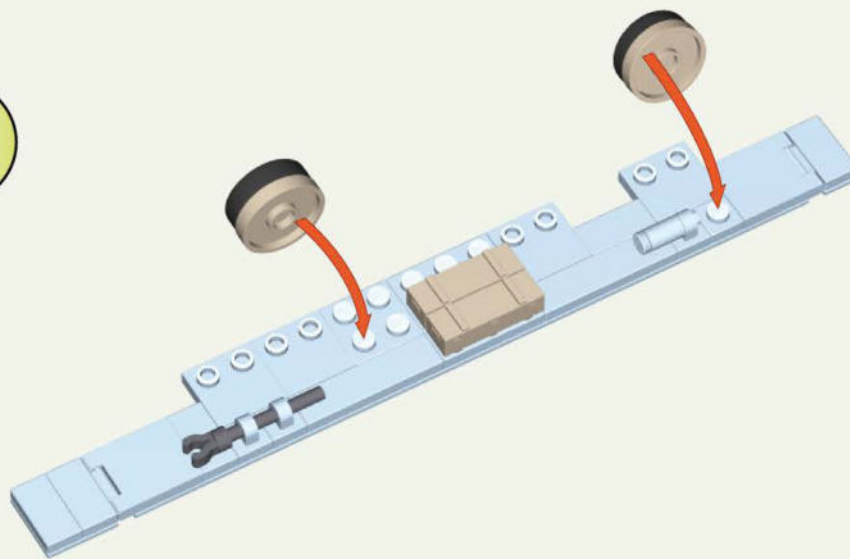
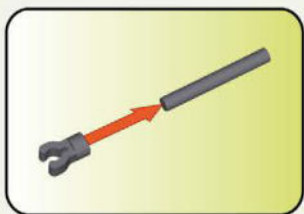

0

x2



x2



x2



x1



x1







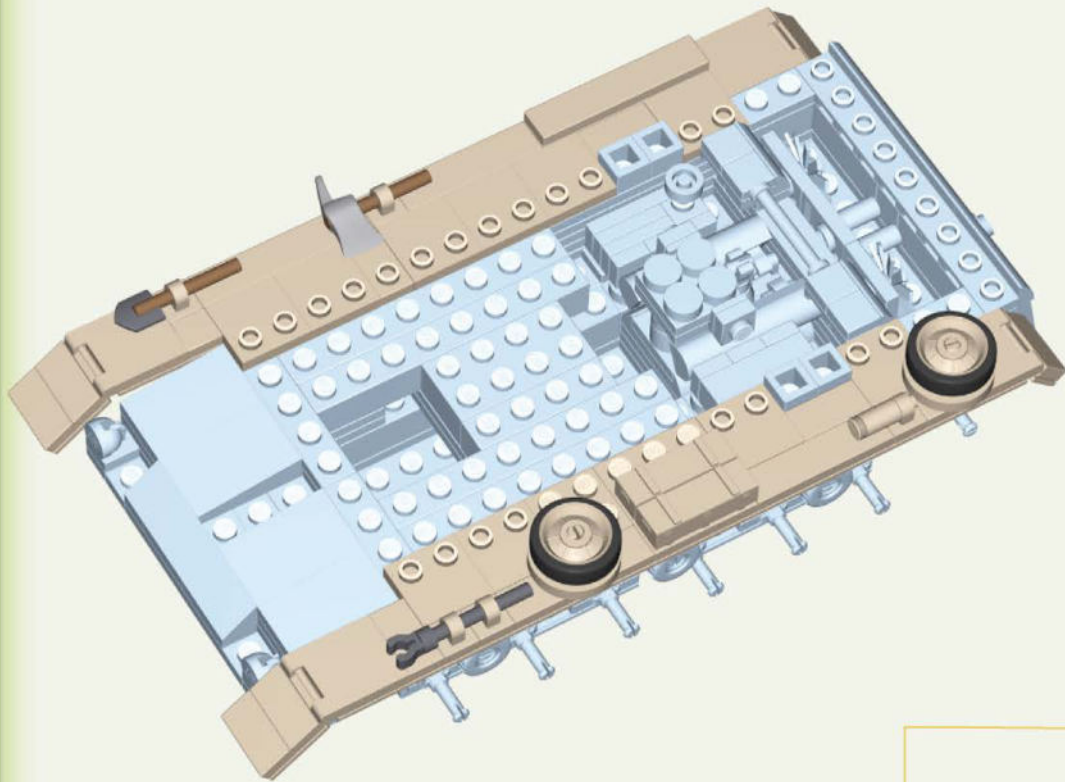

x2

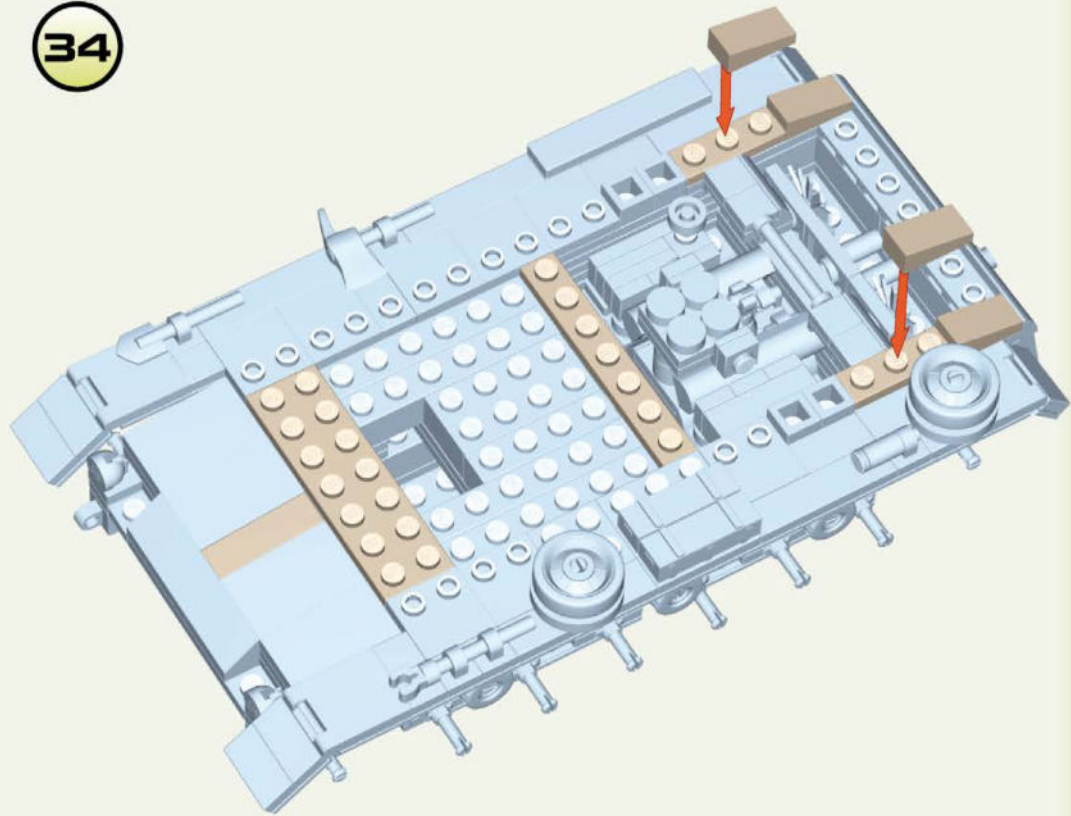
33



34



E  **x1**    
  **x1**    
  **x1**    
  **x2**    
 C  **x4**

35

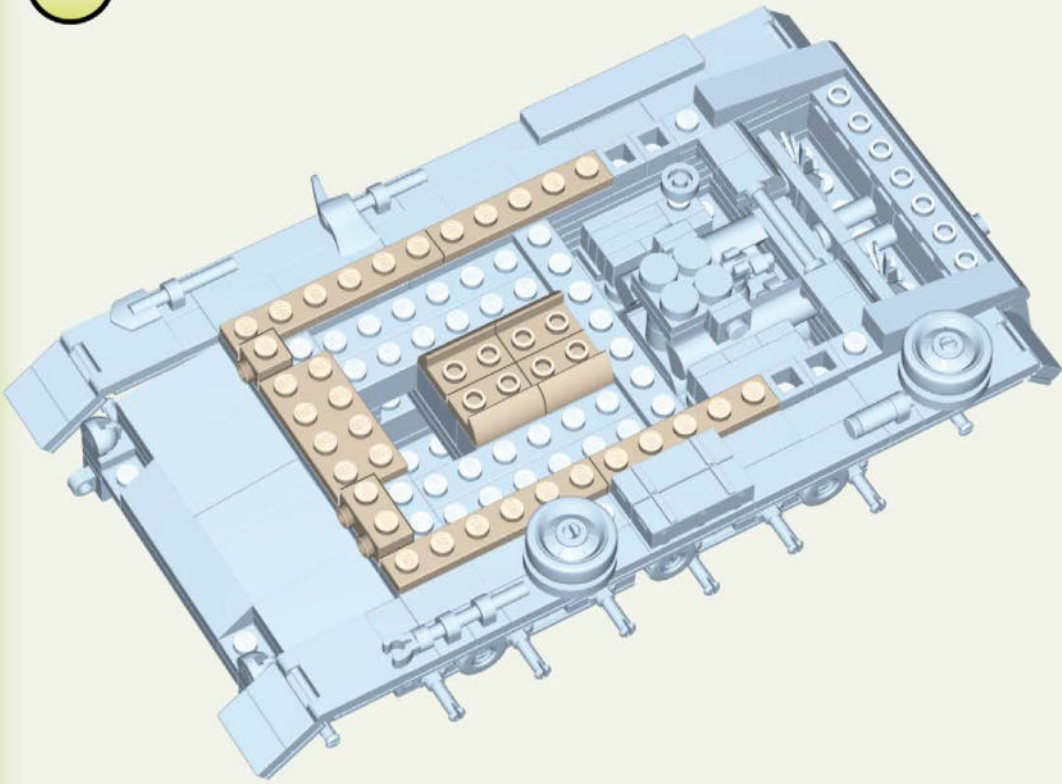

36

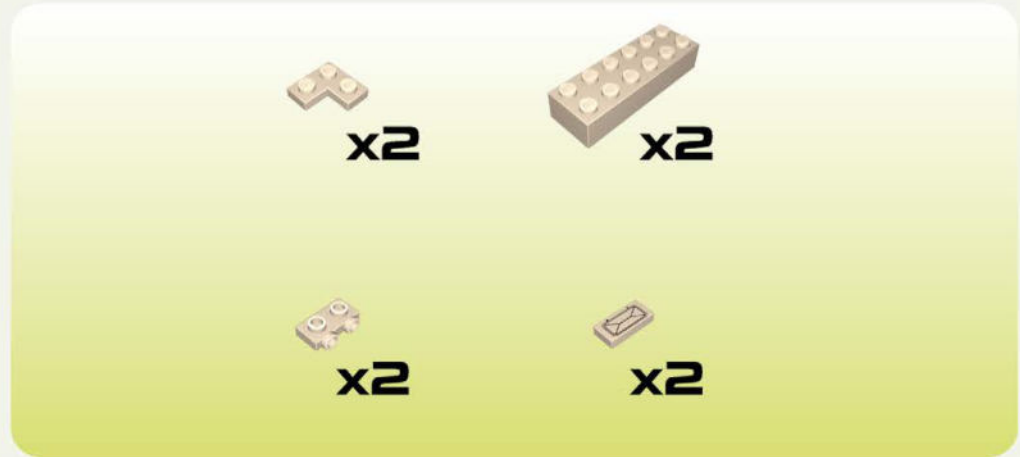
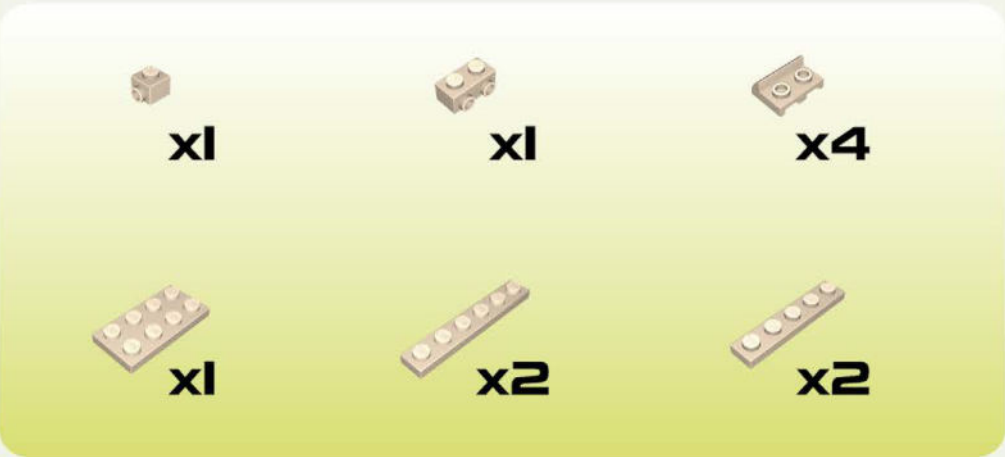
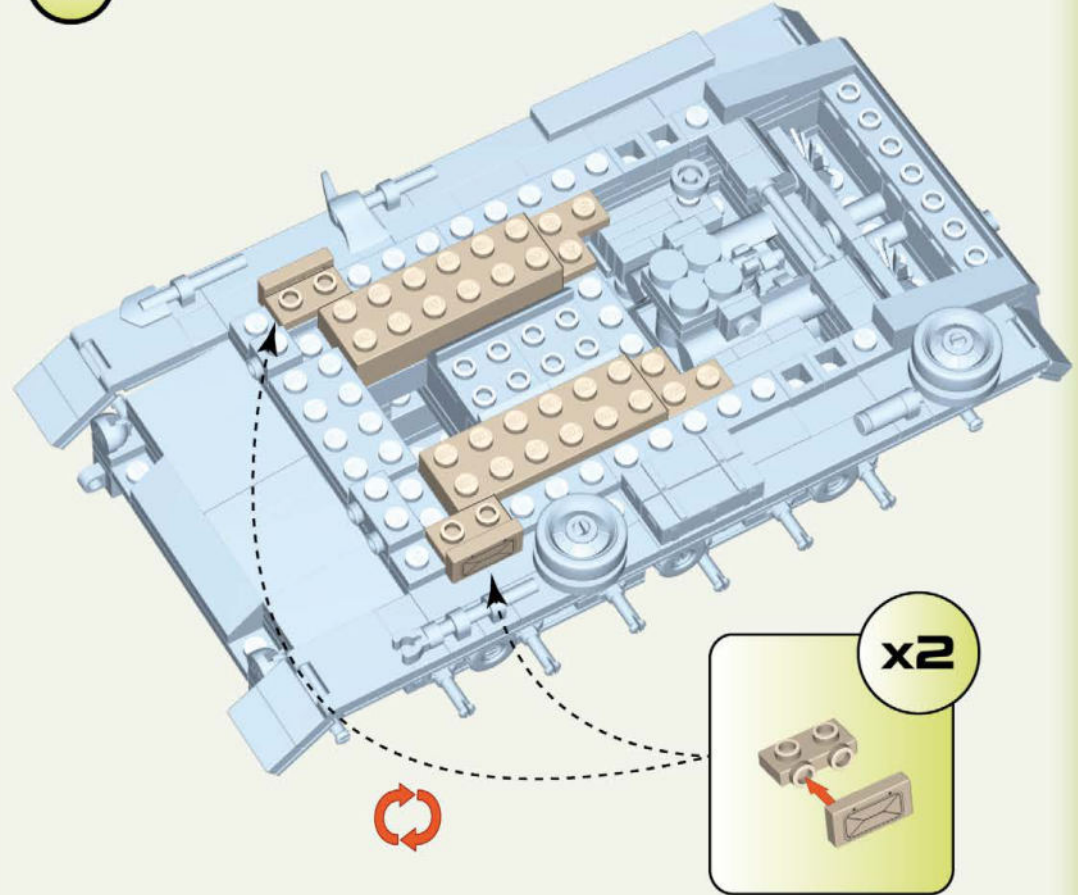

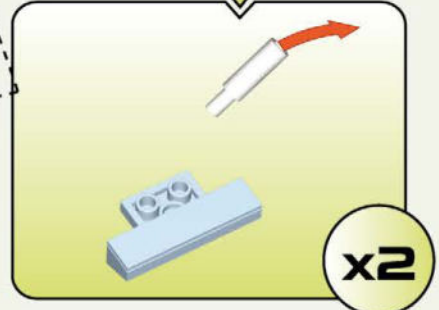
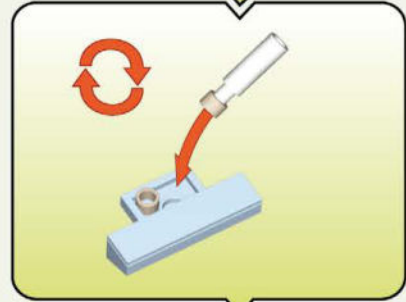
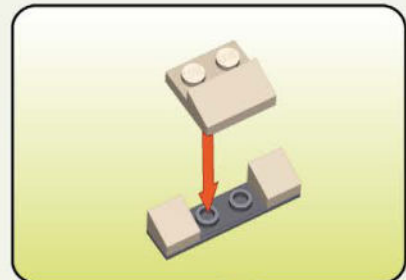
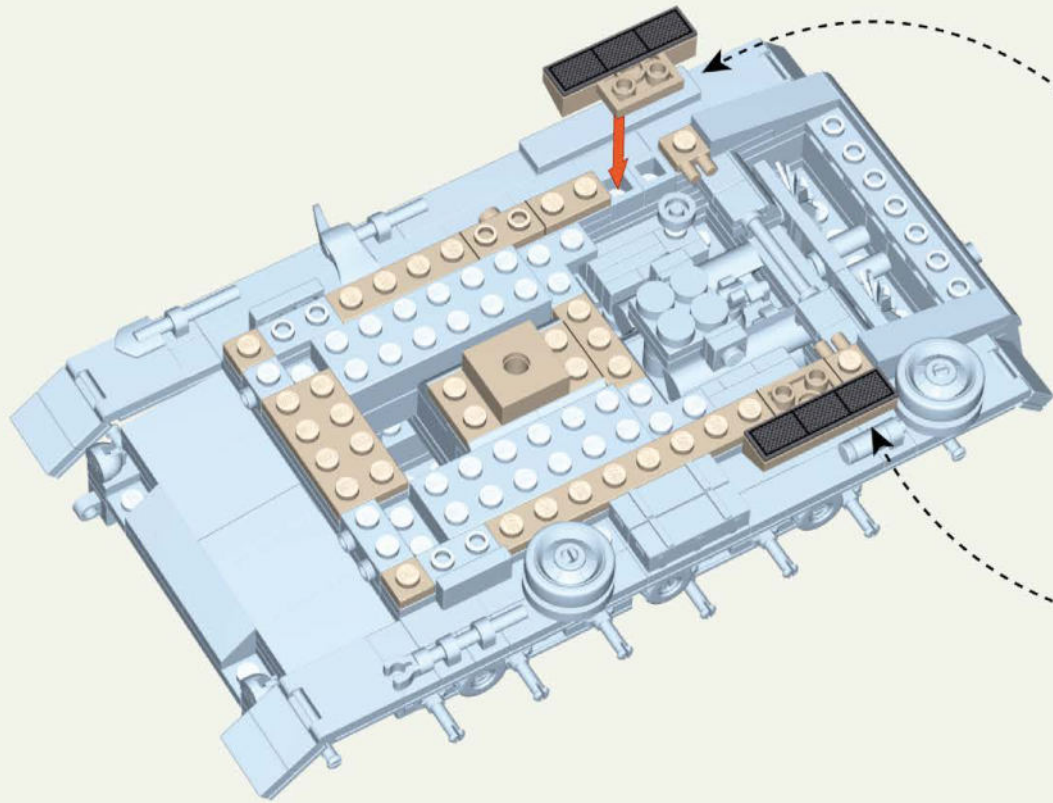

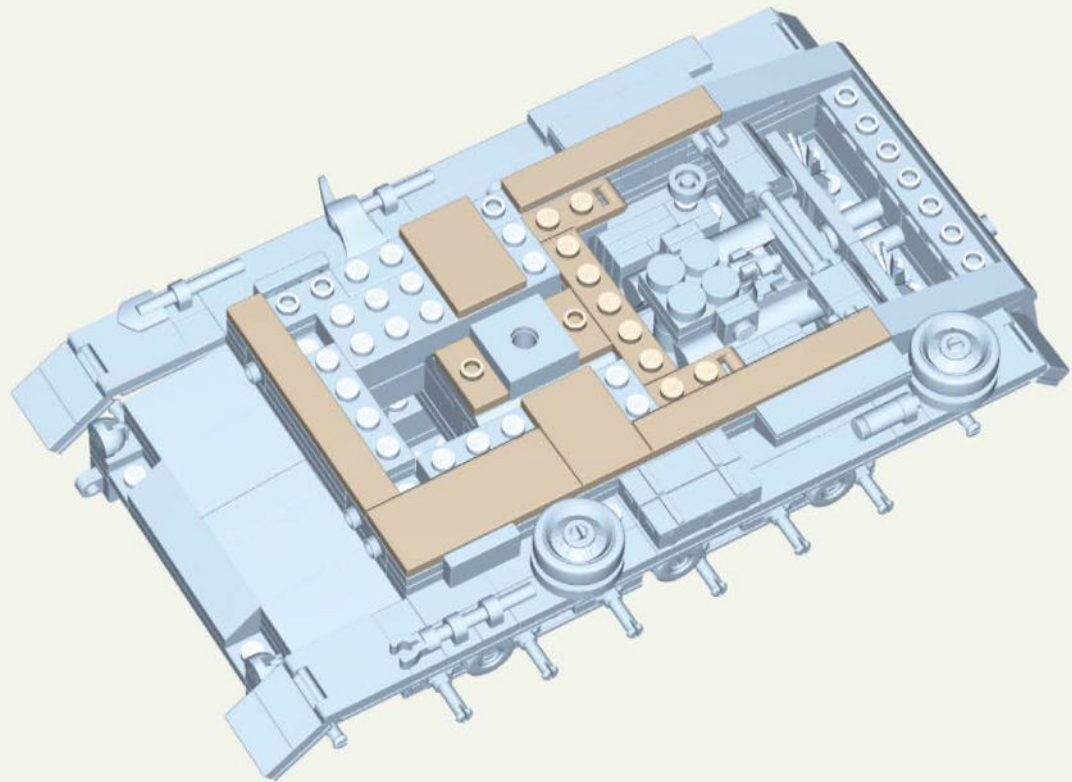

1:1

1:1



x2

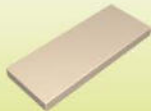

x1



x2



x2



x1



x2



x1



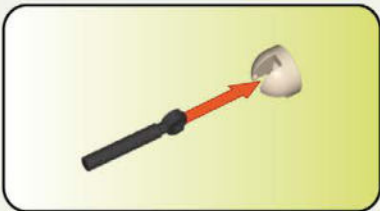
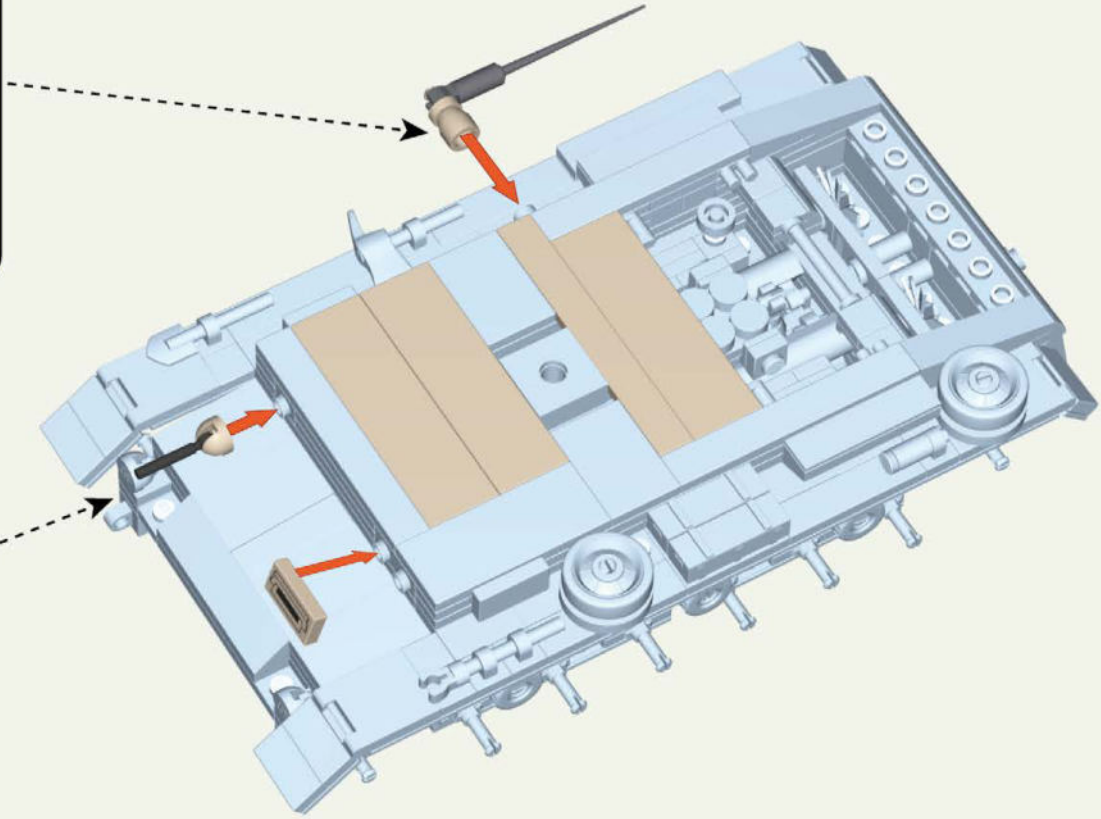
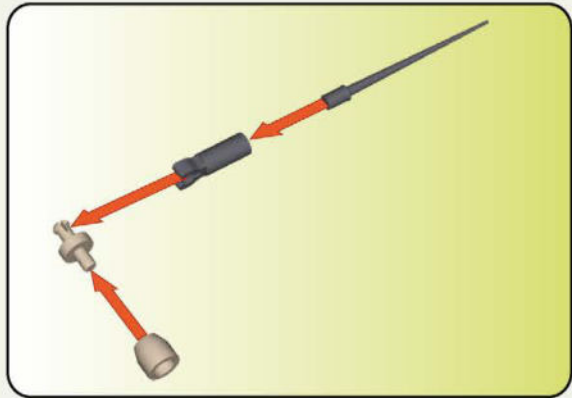

1:1

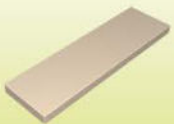

x3

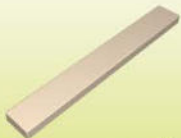

x1



x1



x1



x1



x1



x1



x1



x1

40

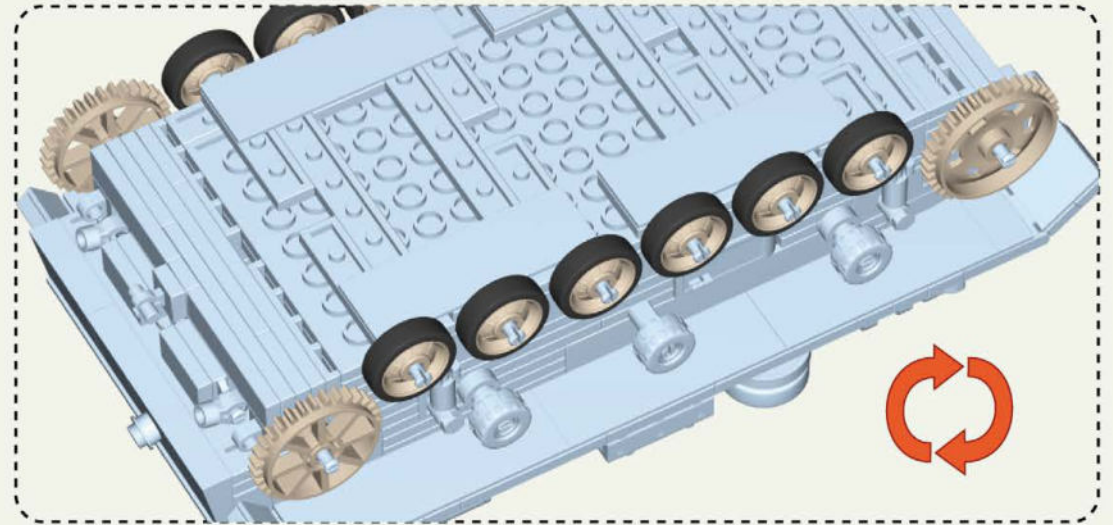
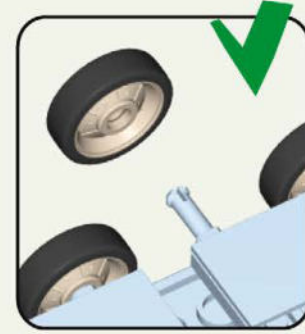
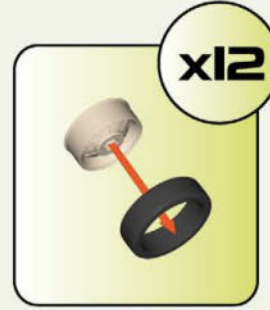
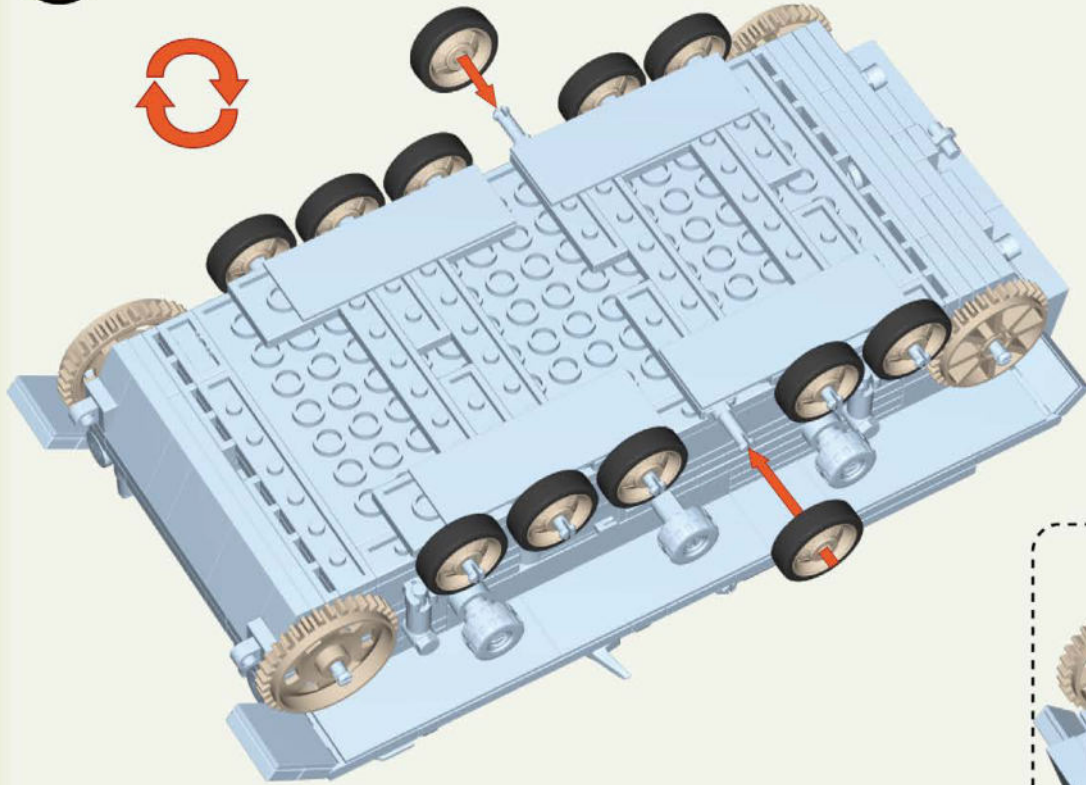

0

x12



x12





x2

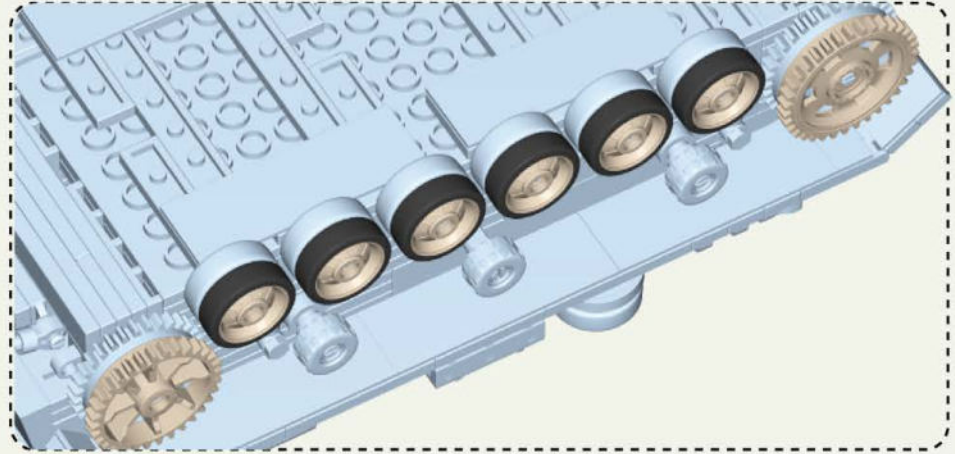
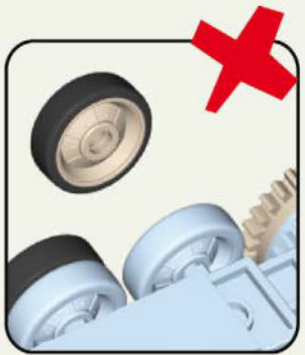
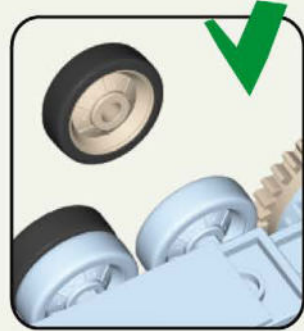
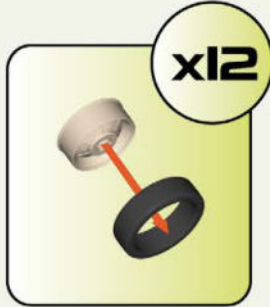
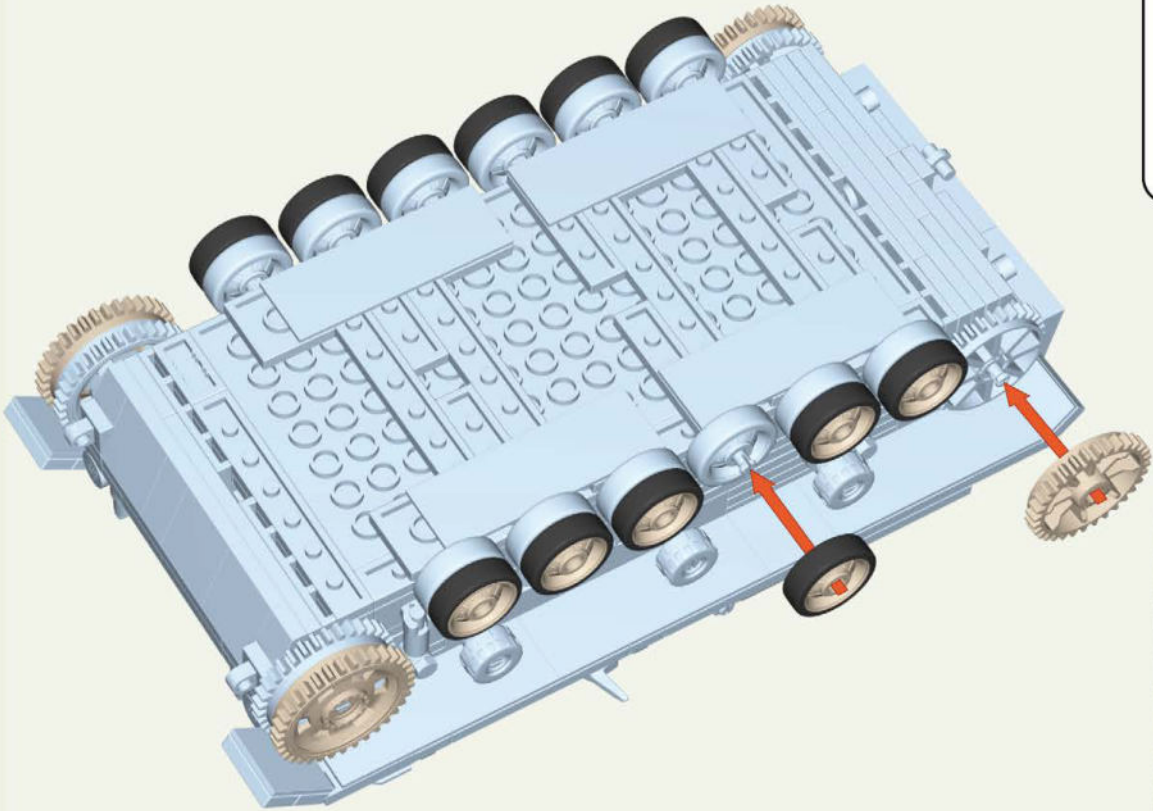

x2



- 0**  
**x12**
-   
**x12**
-   
**x2**
-   
**x2**

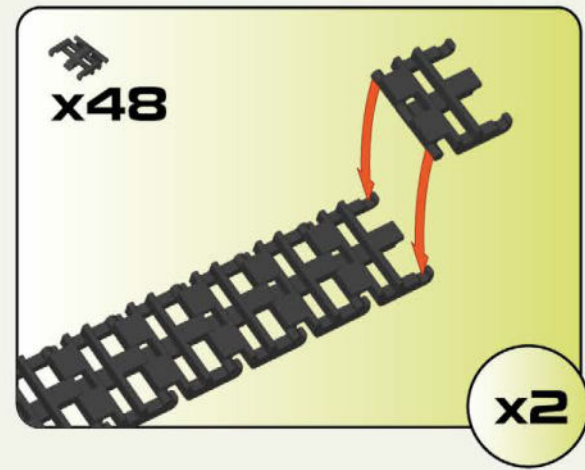
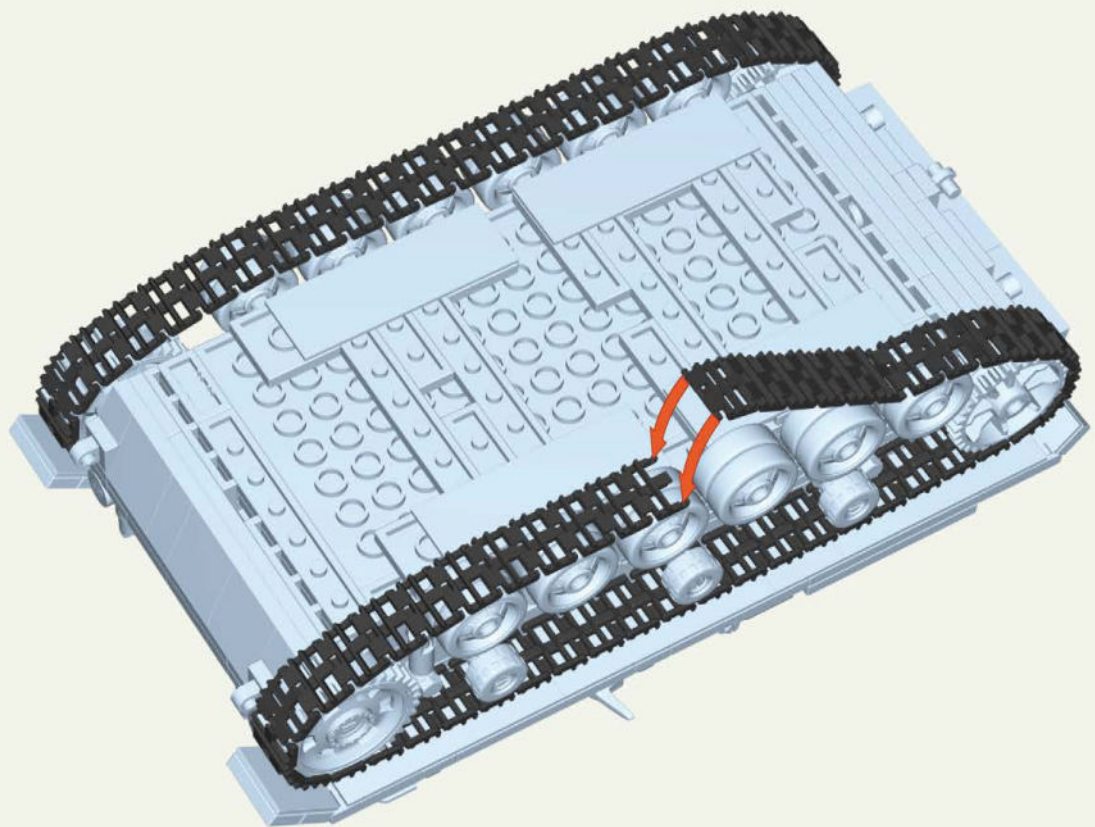

43

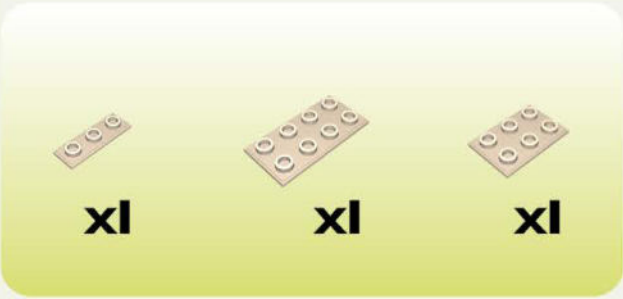
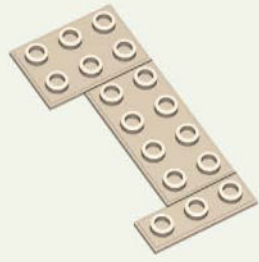

44

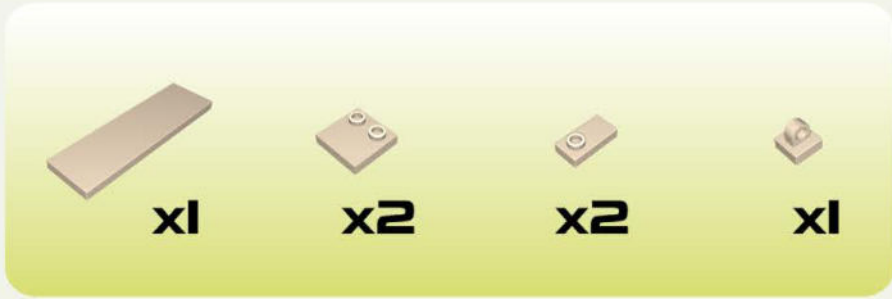
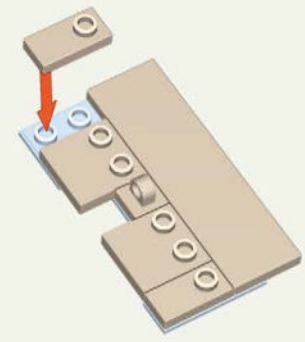

45

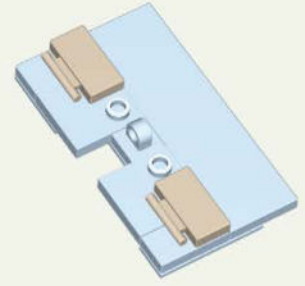

46

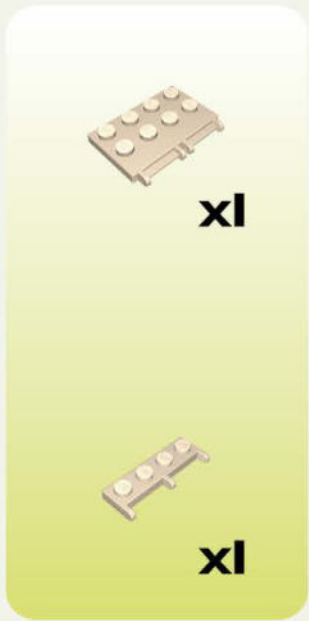
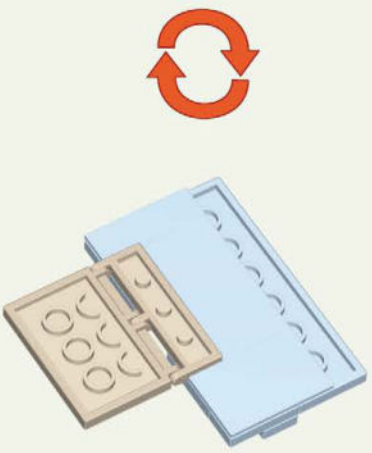
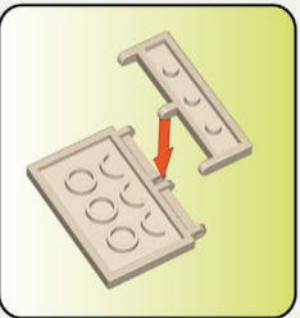

47

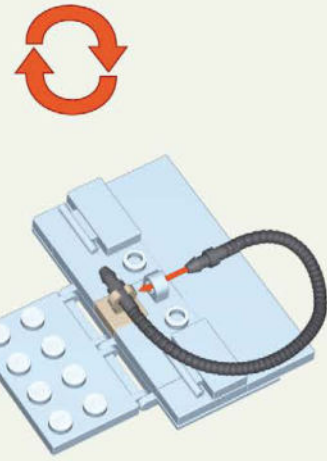

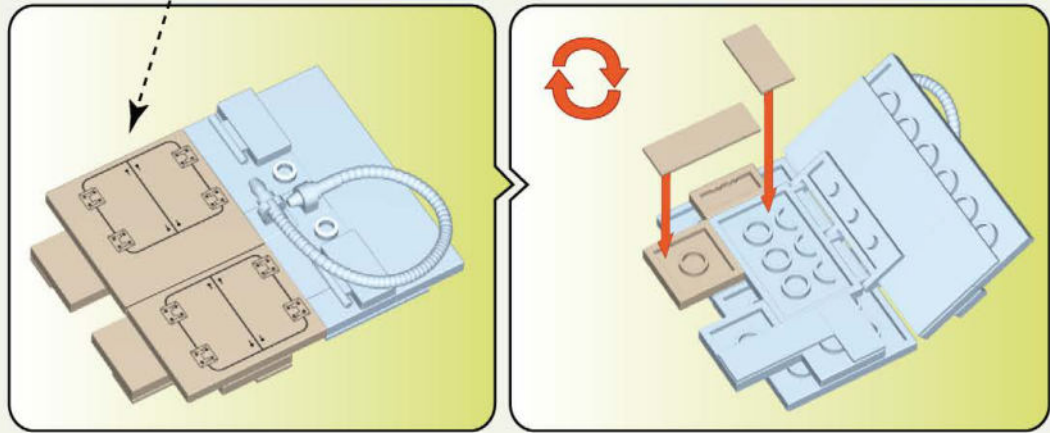
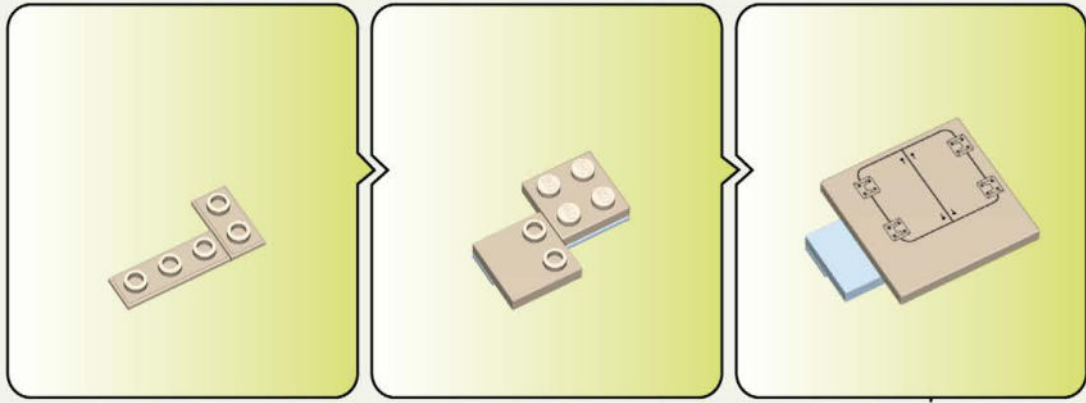

-  x2
-  x2
-  x1
-  x2
-  x1
-  x1
-  x1

49

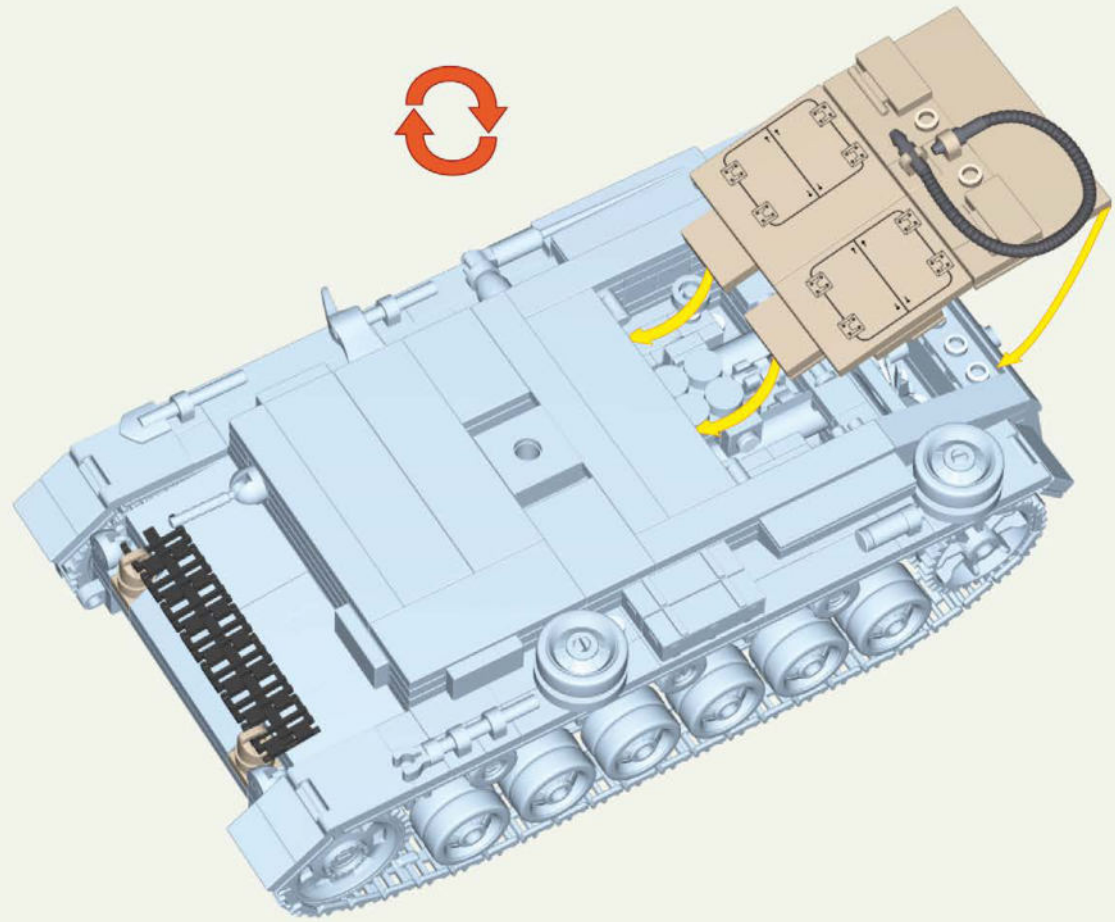
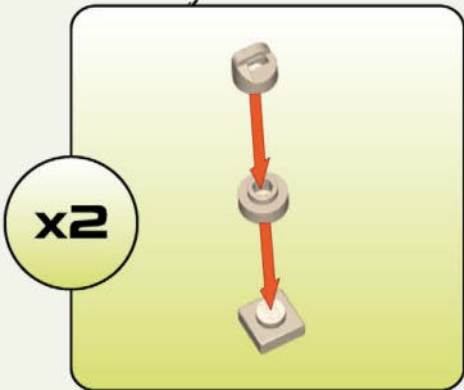
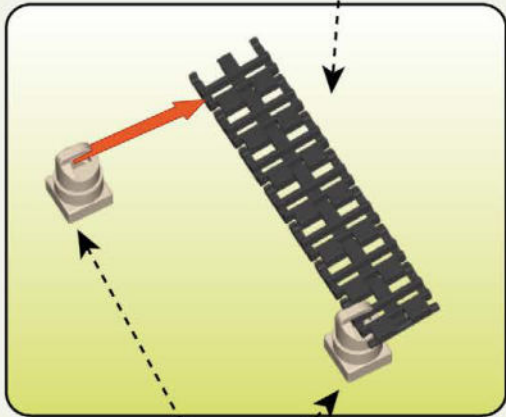
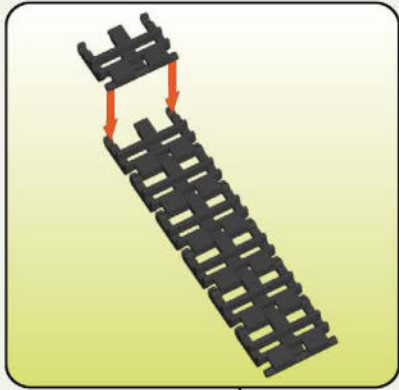

-  x2
-  x2
-  x2
-  x7

50

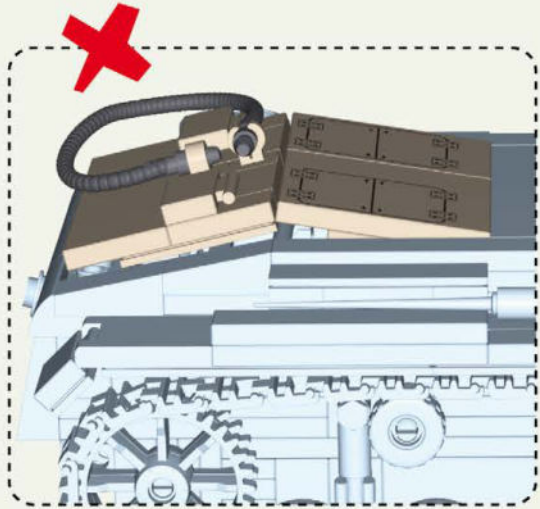
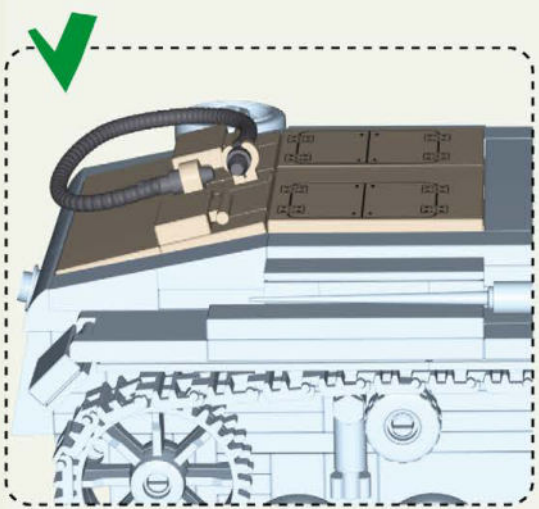
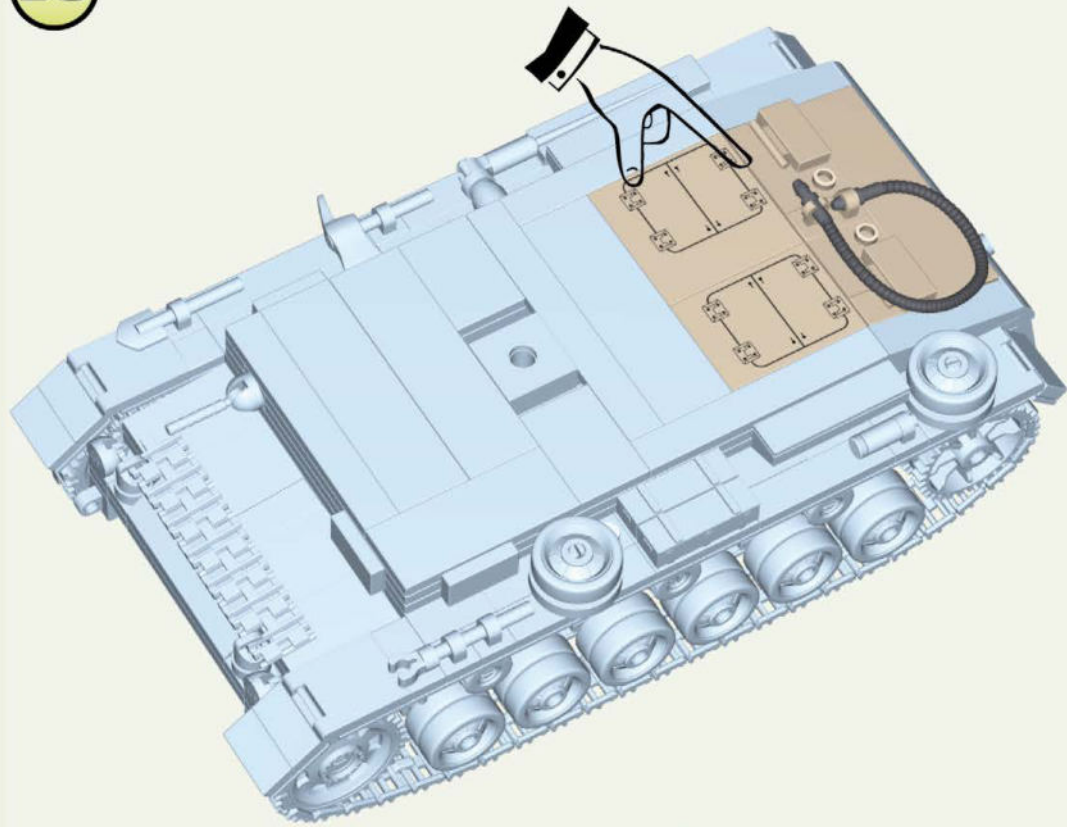

51



52

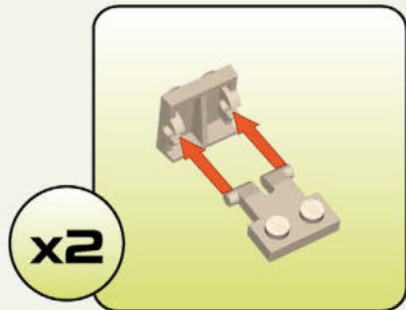
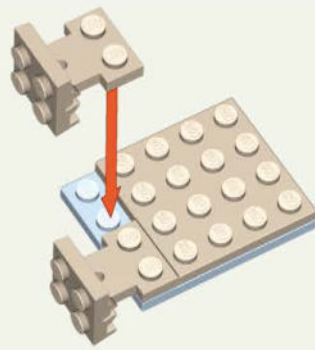

53

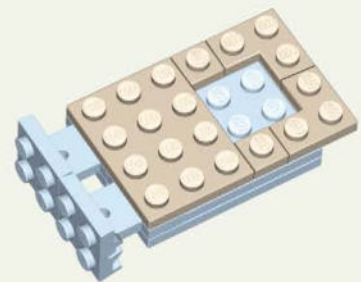



54

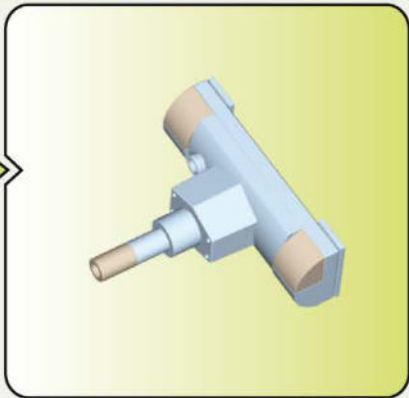
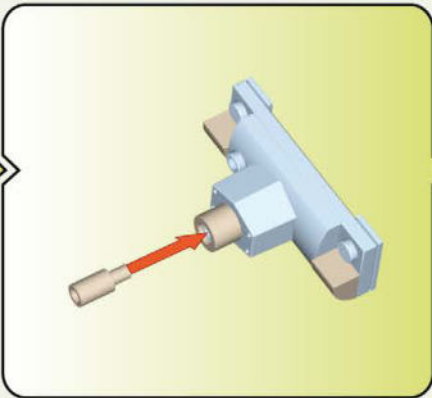
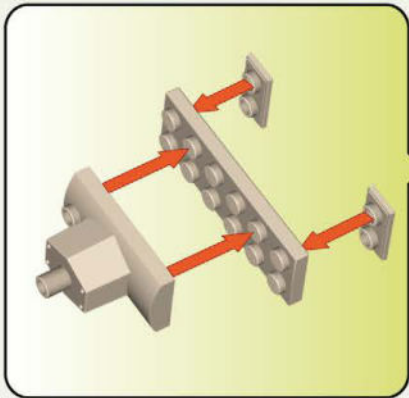

x1



x1



x2



x4



x1



x2

55

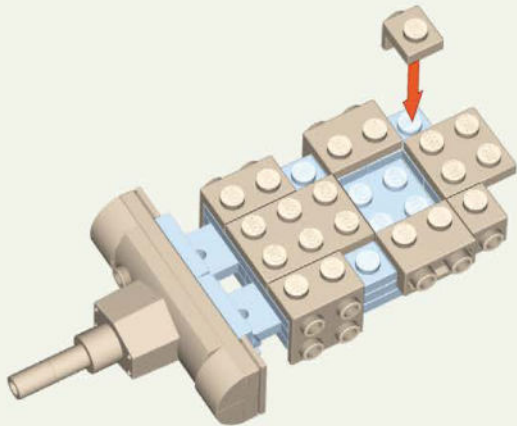

x1



x1



x2



x2



x2

56

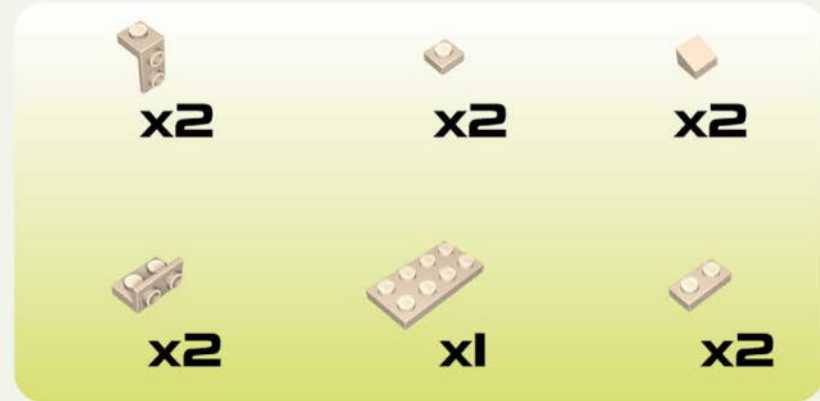
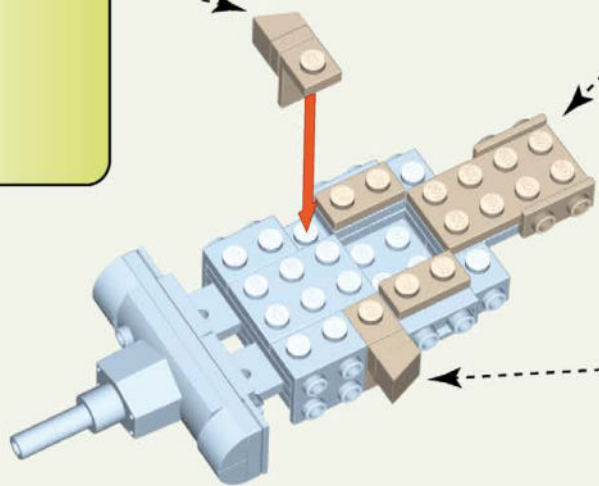
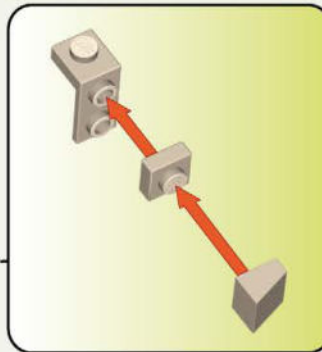
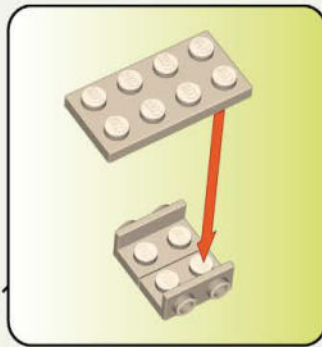
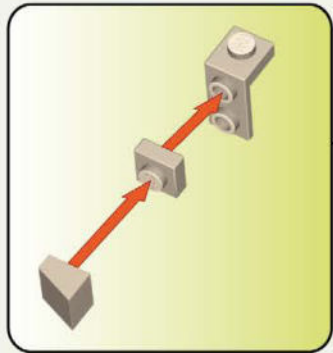

57

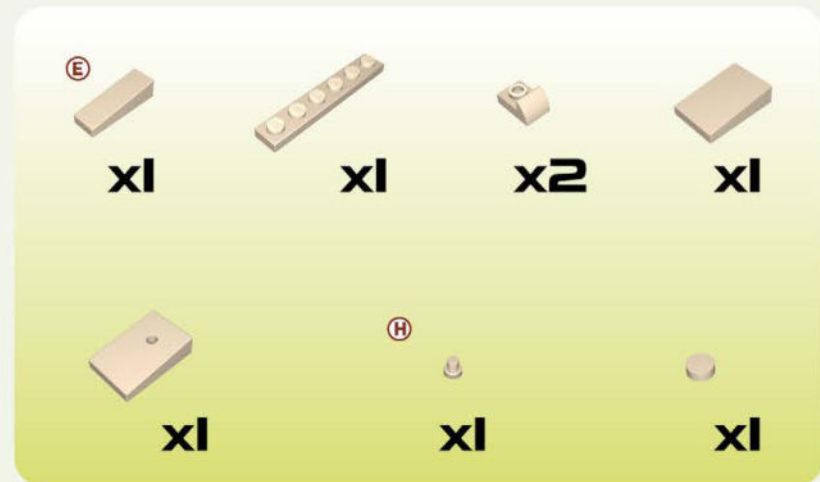
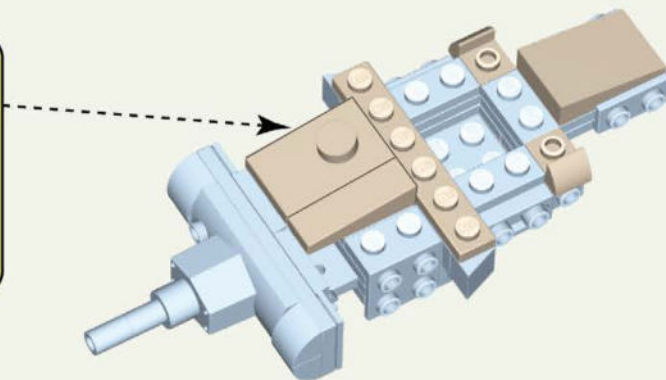
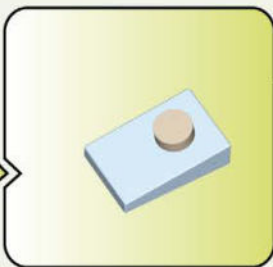

58

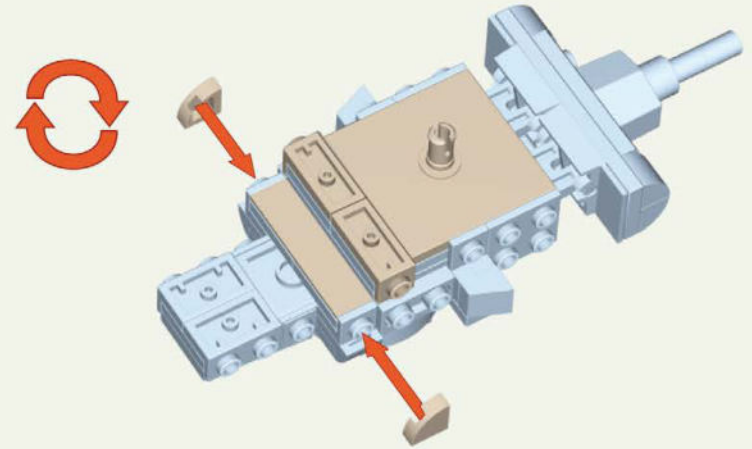
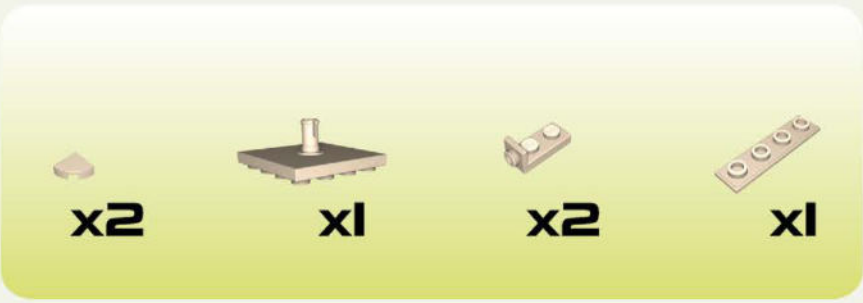

59

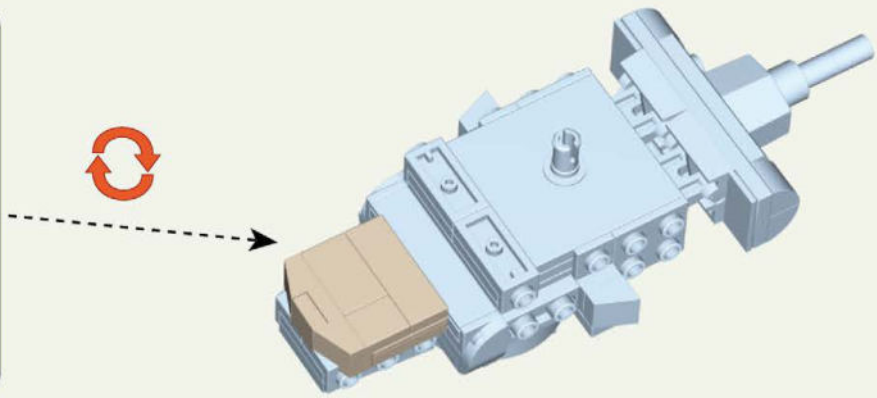
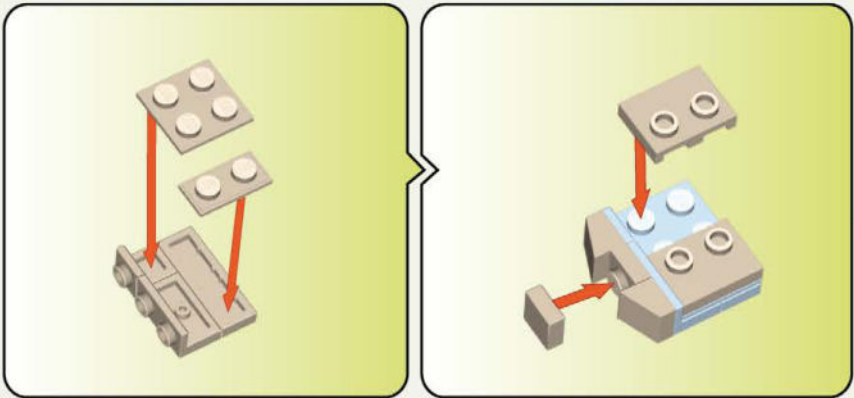

1:1



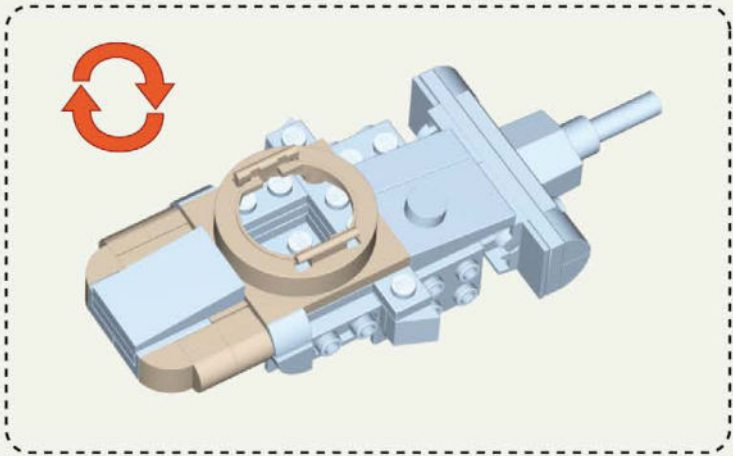
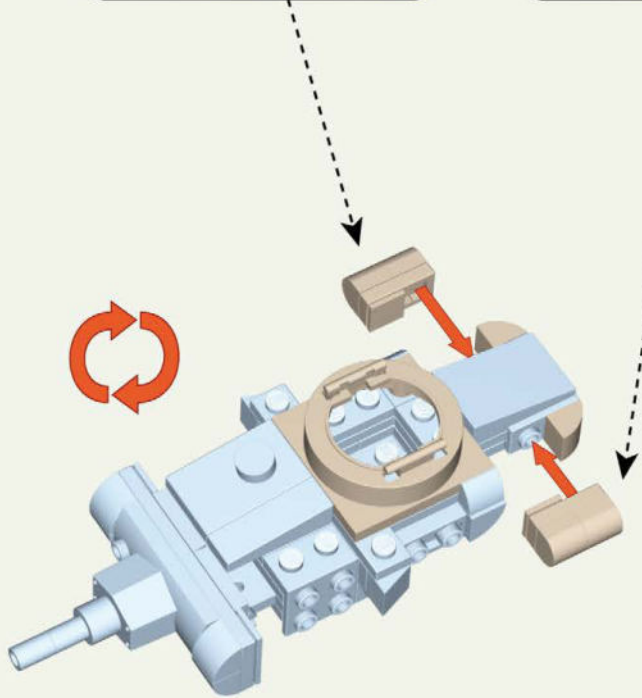
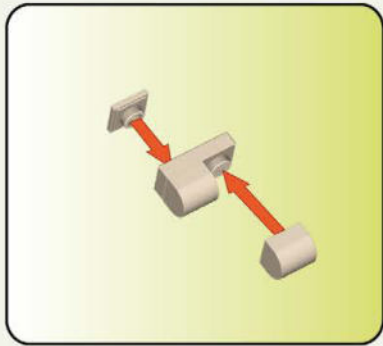
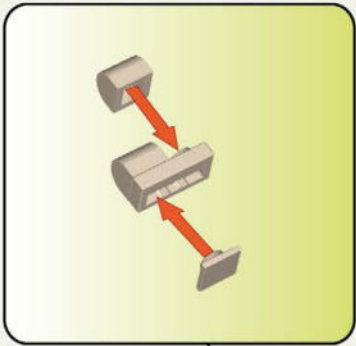

x1



x2



x2



x4



x2

61

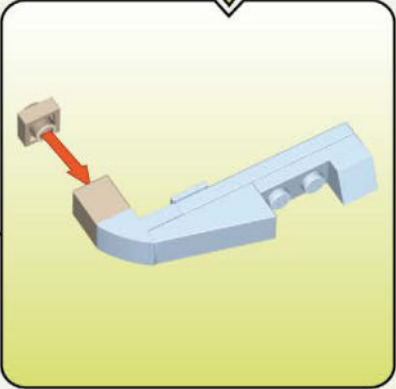
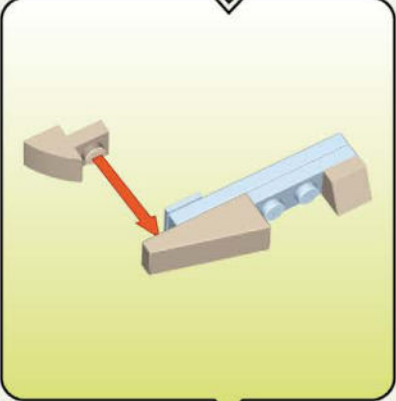
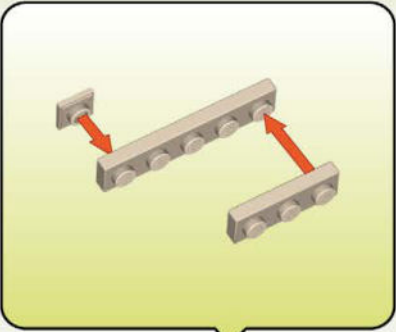
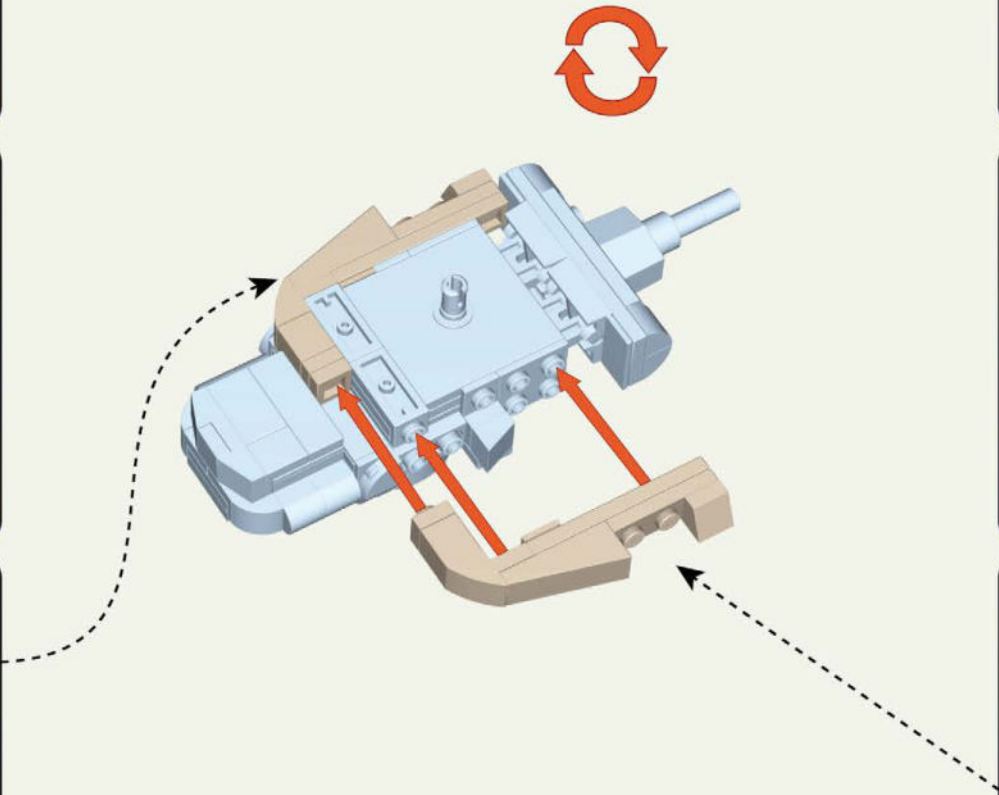
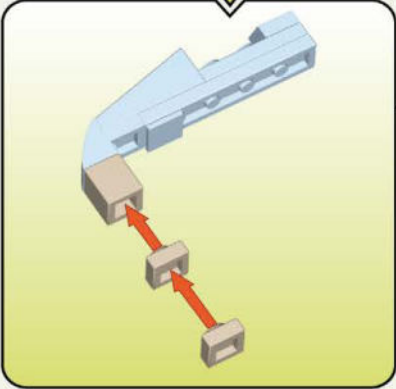
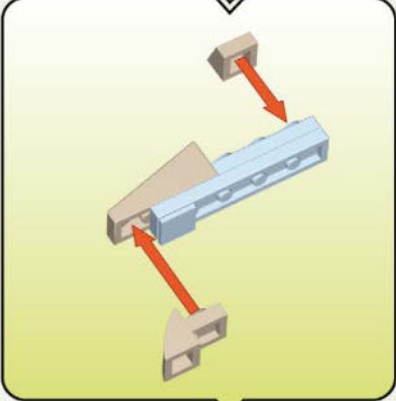
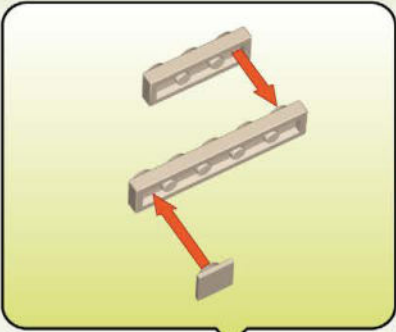

x2



x2



x2



x2



x2



x2



x2



x2



x1

62

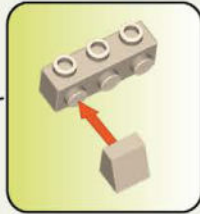
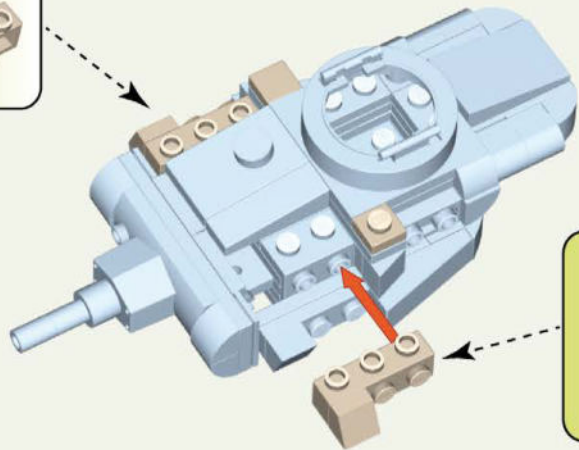
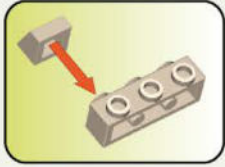

63

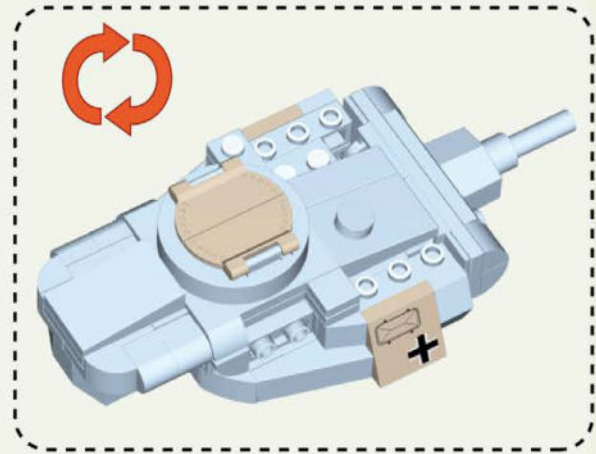
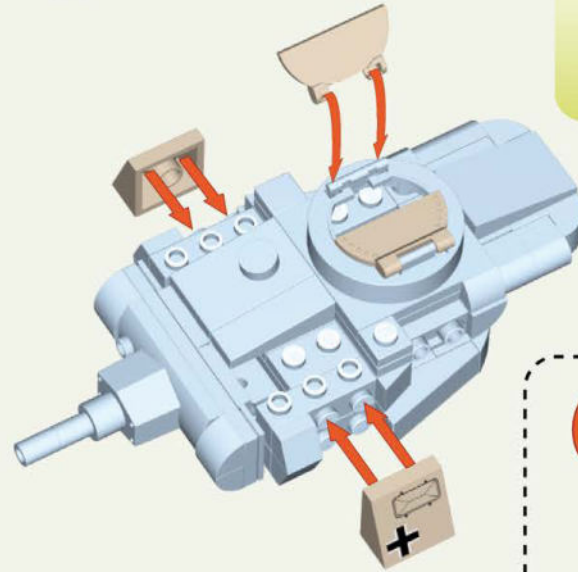
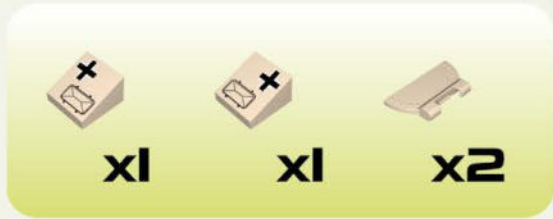

64

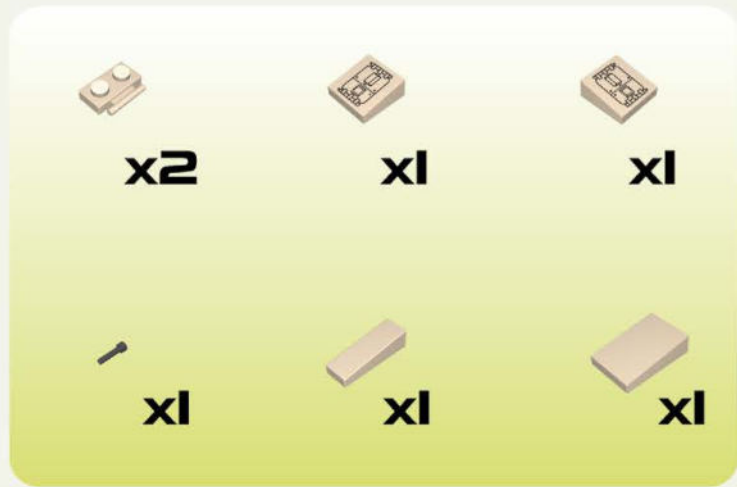
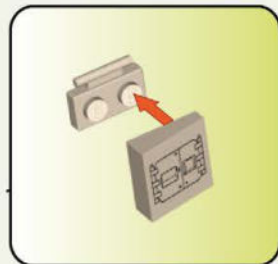
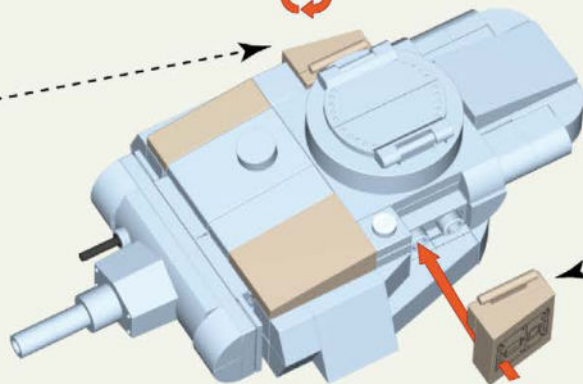
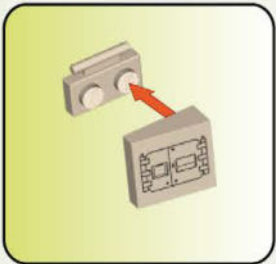

65

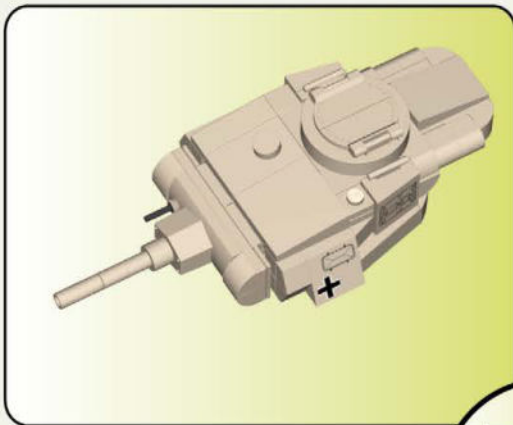

66

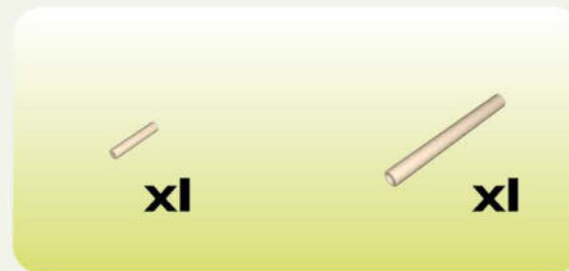
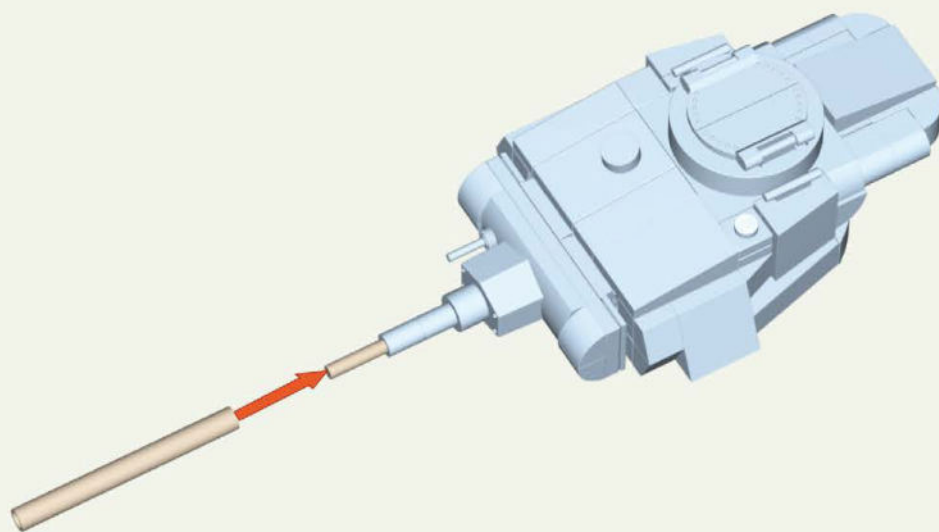
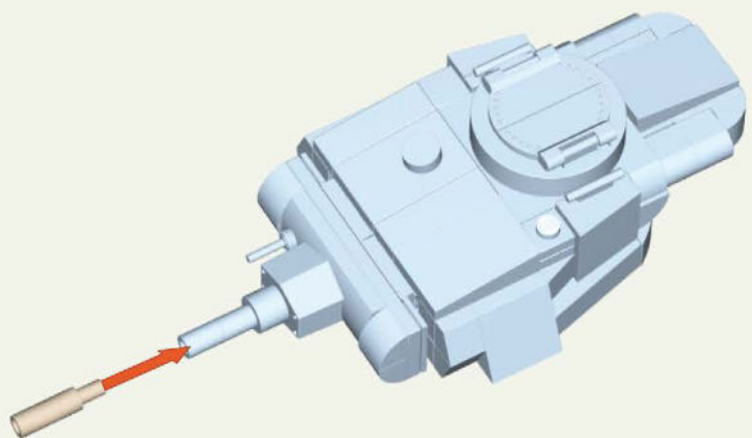
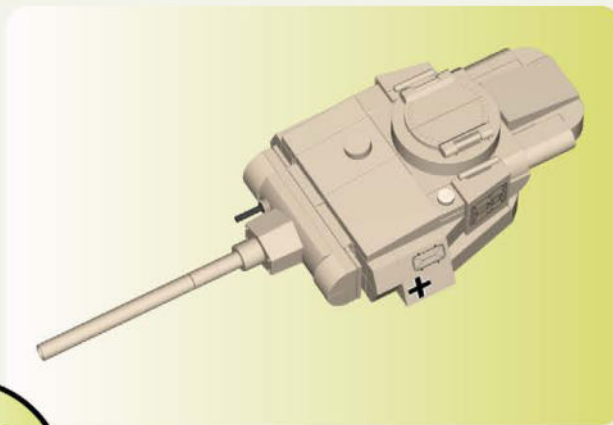

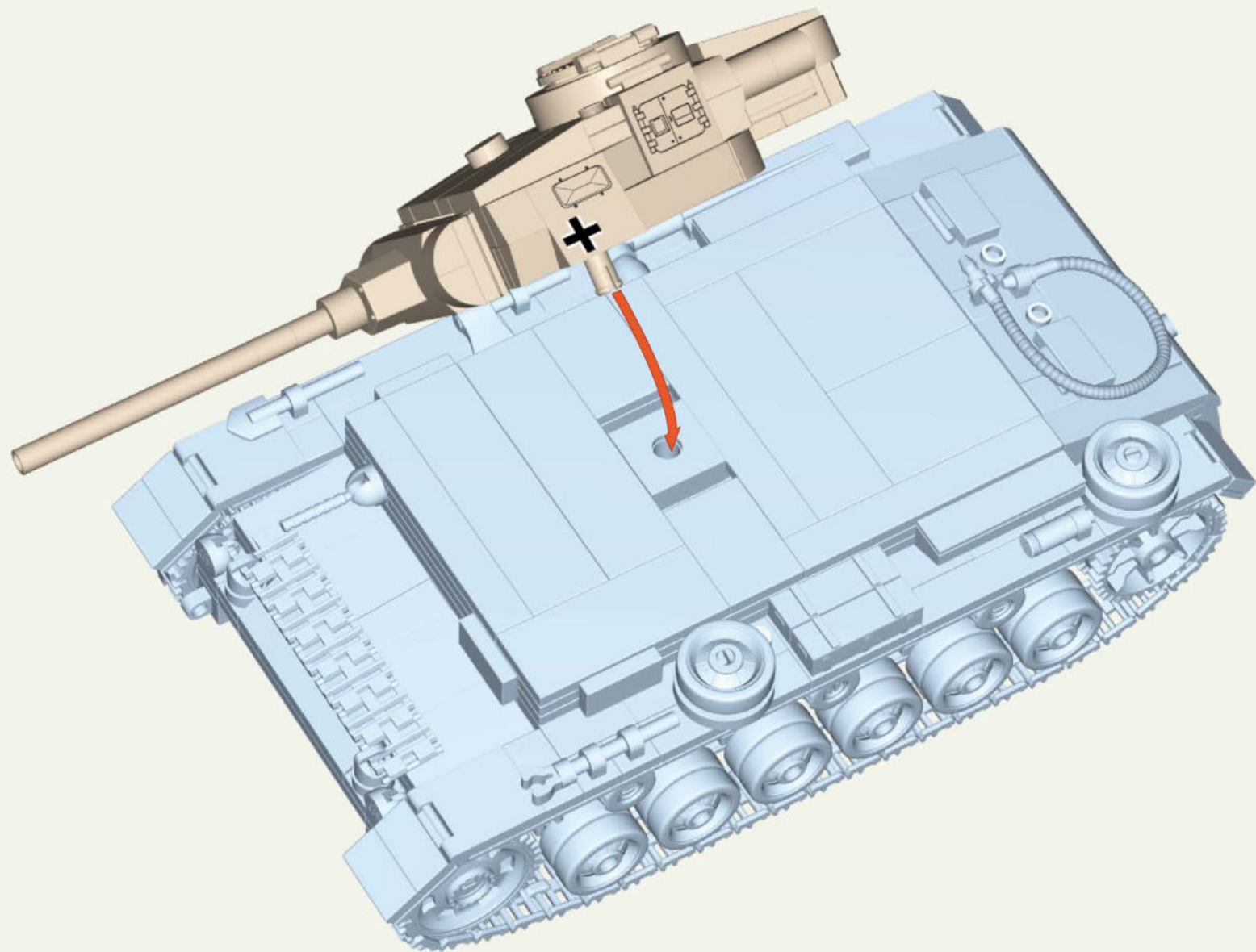



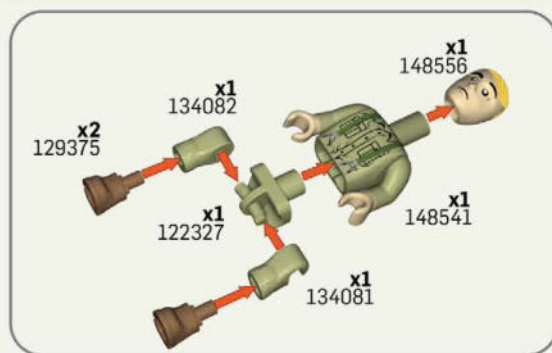
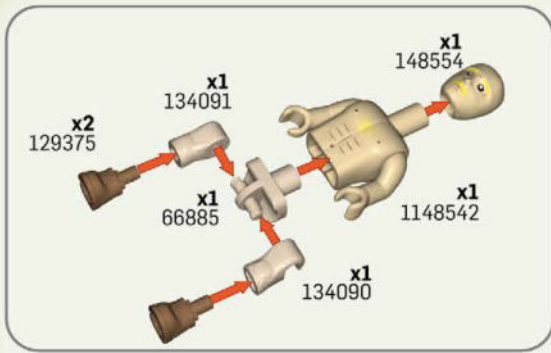

- |           |  |           |           |           |           |           |           |           |           |            |           |           |
|-----------|--|-----------|-----------|-----------|-----------|-----------|-----------|-----------|-----------|------------|-----------|-----------|
| x1 128409 | x12 127736                             | x2 96797  | x3 42877  | x1 101860 | x4 98923  | x4 124637 | x2 144525 | x2 144504 | x2 116836 | x4 105892  | x4 111104 | x3 105844 |
| x2 42858  | x4 128473                              | x1 148830 | x1 108073 | x1 74129  | x6 93970  | x2 111910 | x22 44497 | x2 129722 | x2 143737 | x1 102459  | x1 93971  | x2 117340 |
| x1 97247  | x2 99565                               | x2 105399 | x1 133024 | x2 104584 | x2 97447  | x5 45525  | x6 127517 | x2 107019 | x1 143568 | x2 107020  | x2 129727 | x2 130793 |
| x2 148826 | <b>Panzer III Ausf. J</b><br>x1 148780 | x2 42947  | x2 51591  | x3 107036 | x2 54704  | x2 80534  | x2 144505 | x4 148828 | x2 148832 | x10 119996 | x2 55285  | x4 90513  |
| x1 132188 | x4 127872                              | x1 97496  | x13 42954 | x1 93968  | x2 148820 | x4 44971  | x11 86037 | x1 99566  | x4 132172 | x4 107860  | x4 97495  | x16 42926 |
| x10 99624 | x1 51167                               | x2 42962  | x2 148819 | x2 73986  | x1 133049 | x2 148713 | x1 131599 | x2 148709 | x3 95191  | x1 148846  | x3 148827 | x2 128232 |
| x1 97506  | x14 65475                              | x2 107037 | x2 120256 | x6 43079  | x2 123035 | x4 43095  | x6 88303  | x1 108074 | x2 115529 | x5 86670   | x1 51105  | x8 110524 |
| x2 148829 | x2 80466                               | x4 148821 | x1 142692 | x2 69121  | x1 74367  | x1 148714 | x1 148711 | x2 104043 | x2 148823 | x3 112636  | x7 42971  | x5 69119  |
|           |  |           |           |           |           |           | x20 65653 | x2 86040  | x1 144507 | x5 43012   | x1 82235  | x1 97465  |
|           |  |           |           |           |           |           | x1 148824 | x2 112635 | x1 148825 | x14 123601 | x6 114361 | x2 148822 |
|           |  |           |           |           |           |           | x1 148716 | x3 59252  | x1 148718 | x1 148719  | x3 117449 | x1 119022 |





# HISTORICAL COLLECTION



PzKpfw V PANTHER Ausf. G  
SCALE 1:48  
+ 2713

PzKpfw V PANTHER Ausf. G  
+ 2566



PANZER IV AUSF. G  
SCALE 1:48  
+ 2714



PzKpfw V PANTHER „PUDEL”  
+ 2568

2562

PANZER III  
AUSF. J

TABLE POINT



1.		22 cm	11.		4
2.		10 cm	12.		3
3.		-5 cm	13.		1
4.		-5 cm	14.		2
5.		+10 cm	15.		-
6.		3-6	16.		-
7.		5-6	17.		1
8.		9	18.		5
9.		2+	19.		80
10.		8	20.		Available 1941



2562



**SHERMAN M4A1**  
SCALE 1:48  
★ 2715



**PzKpfw VI TIGER "131"**  
SCALE 1:48  
+ 2710



# HISTORICAL COLLECTION

WWW.COBIGAMES.COM

## PANZER III AUSF. J



**CHURCHILL MK. IV**  
SCALE 1:48  
🇬🇧 2717



**PANZER II AUSF. A**  
SCALE 1:48  
+ 2718



**Sd.Kfz.7 HALF-TRACK**  
+ 2275

WWW.COBI.EU

12-02562-763

For news and special deals

Find us on:  
f cobr.bricks  
i cobr.klocki  
y COBI SA