

**ARMED
FORCES**

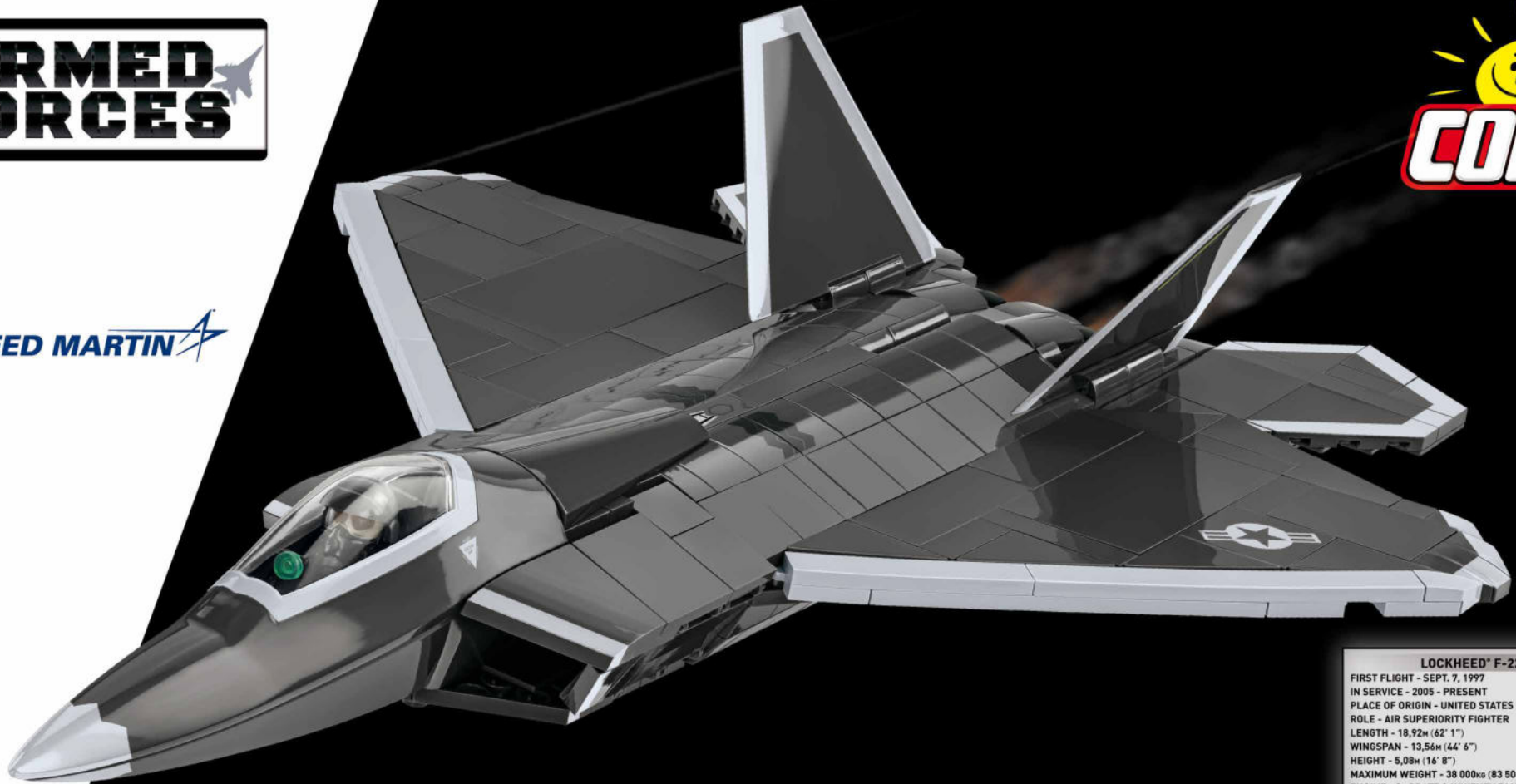

LOCKHEED MARTIN



LOCKHEED® F-22® RAPTOR®
 FIRST FLIGHT - SEPT. 7, 1997
 IN SERVICE - 2005 - PRESENT
 PLACE OF ORIGIN - UNITED STATES
 ROLE - AIR SUPERIORITY FIGHTER
 LENGTH - 18,92m (62' 1")
 WINGSPAN - 13,56m (44' 6")
 HEIGHT - 5,08m (16' 8")
 MAXIMUM WEIGHT - 38 000kg (83 500lb.)
 ENGINE - 2x PRATT & WHITNEY F119-PW-100 TURBOFANS, EACH 35 000lb THRUST
 RANGE - 3 000km (1 800mi, 1 600nm)
 OR MORE WITH 2 EXTERNAL FUEL TANKS
 MAXIMUM FLIGHT LEVEL - 20 000m (65 000ft)
 MAXIMUM SPEED - 2,25MACH (1 500MPH, 2 414km/h)
 ARMAMENT - 1x INTERNAL M61A2 20mm GUN (480-ROUNDS), 2x AIM-9 SIDEWINDERS INSIDE INTERNAL WEAPONS BAYS, 6x AIM-120 AMRAAMS (AIR-TO-AIR LOADOUT) OR 2x AIM-120S AND 2x GBU-32 JDAMS OR 8x SDBS (AIR-TO GROUND LOADOUT) IN MAIN INTERNAL WEAPONS BAY
 CREW - 1

5855

**PAD PRINTED
NO STICKERS**

Printed in EU



**UK
CA**



WARNING: CHOKING HAZARD-
 Toy contains small parts.
 Not for children under 3 years.

695  **1** 

LOCKHEED® F-22® RAPTOR®

SCALE 1:48

BE CAREFUL: NOTICE THE DIFFERENCE

1



2



3



4



UWAGA: RÓŻNE KLOCKI



1

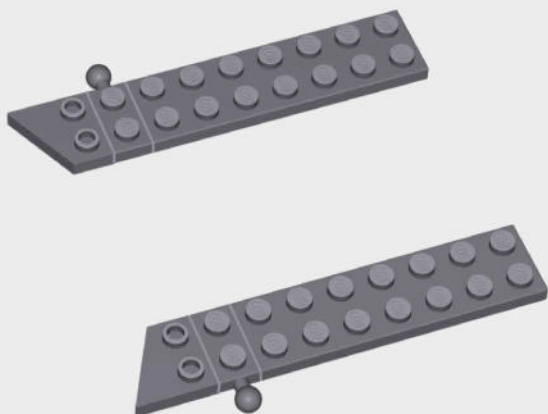

x1



x1



x2



x2

2

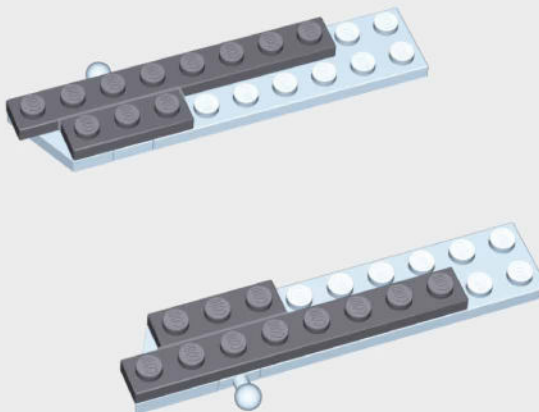

x2

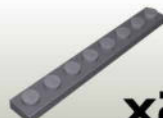

x2

3

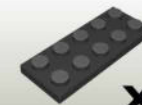
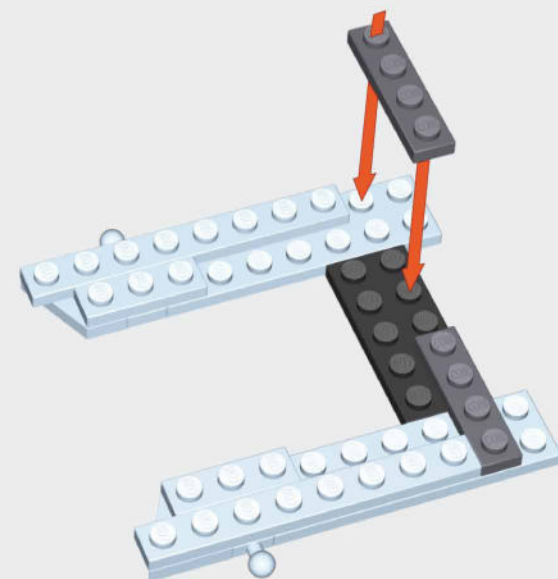

x1



x2

4

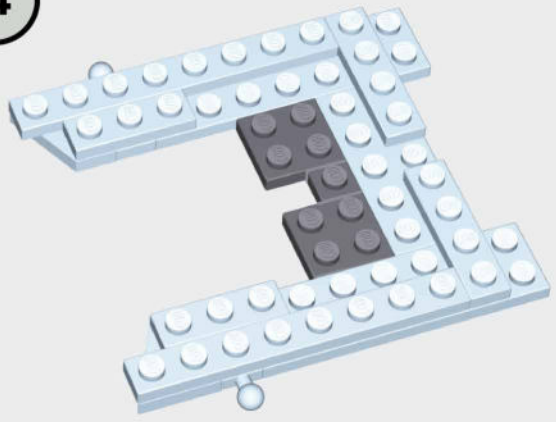

5

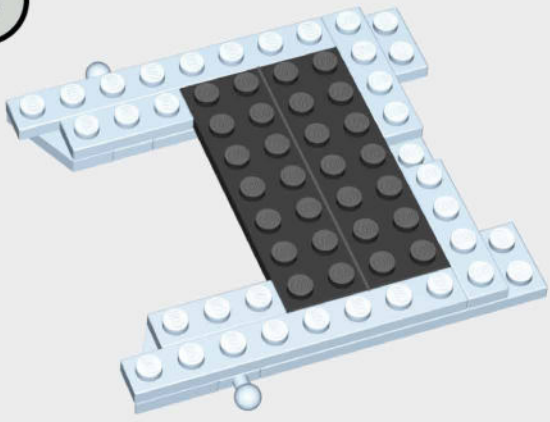

6

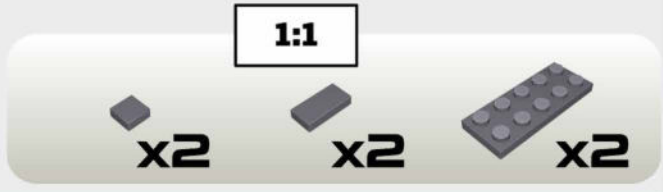
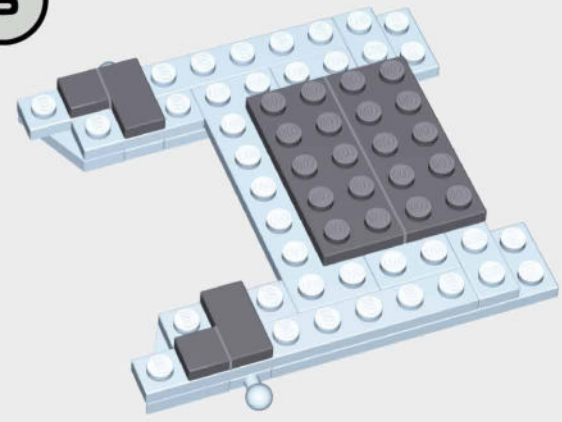

7

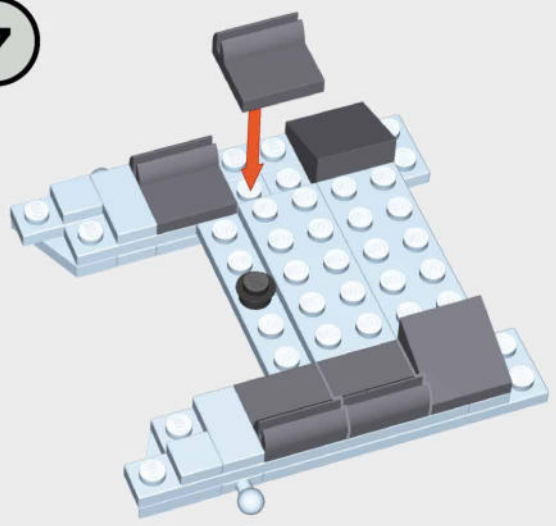

8

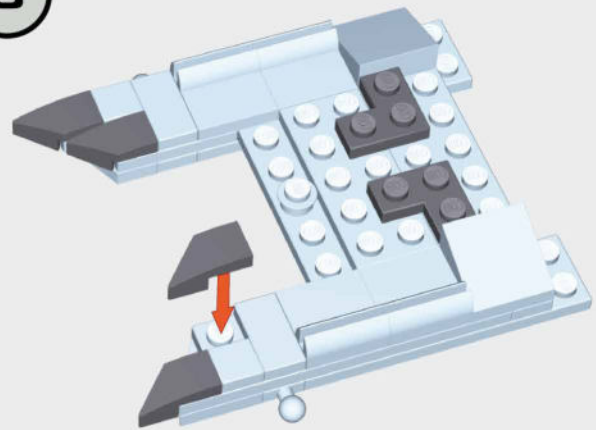

9

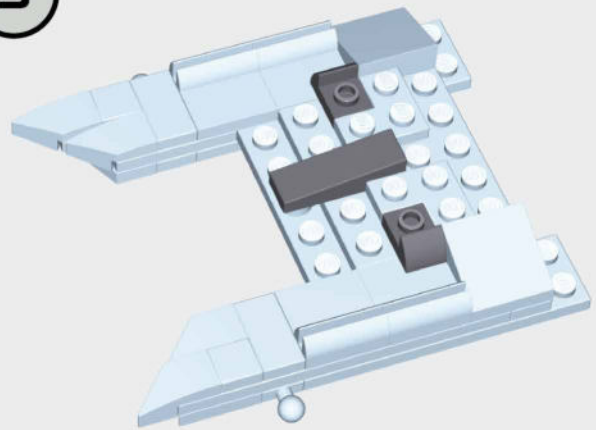

10

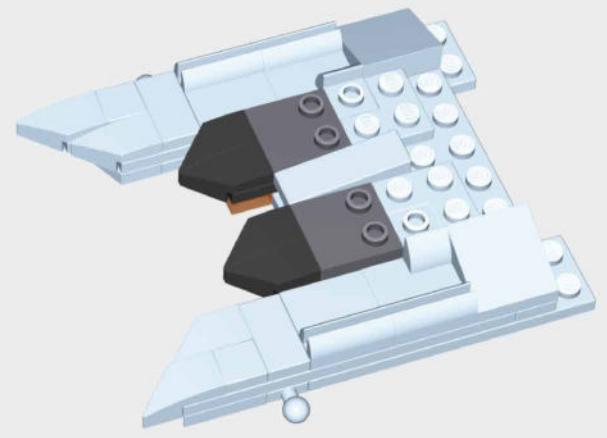
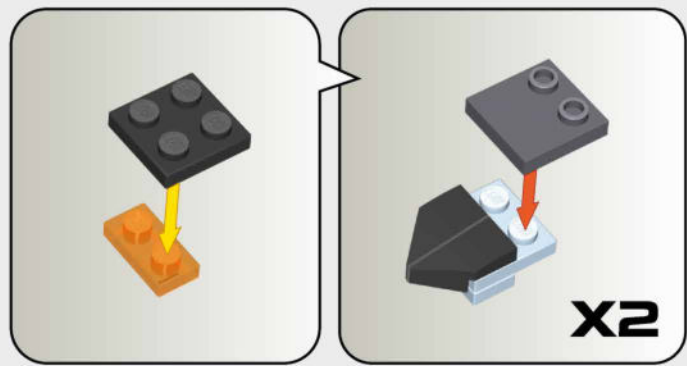

11

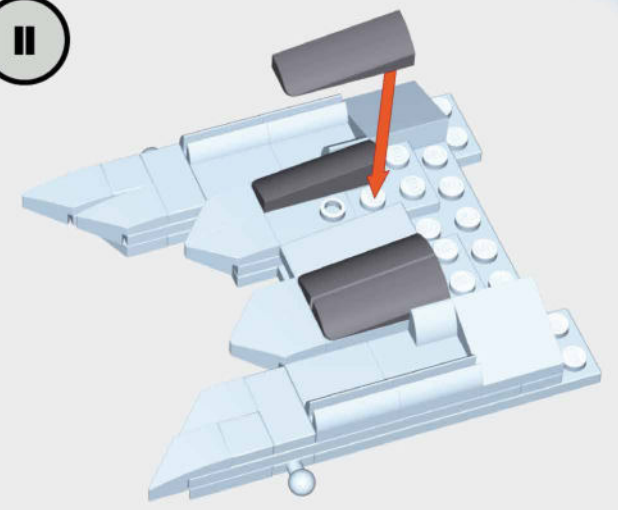

12

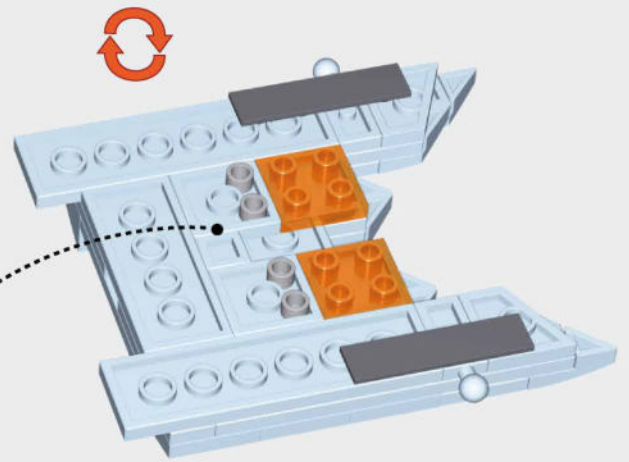
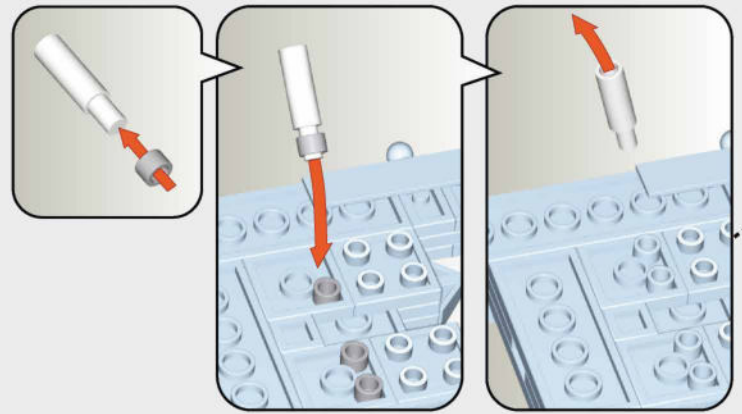

13

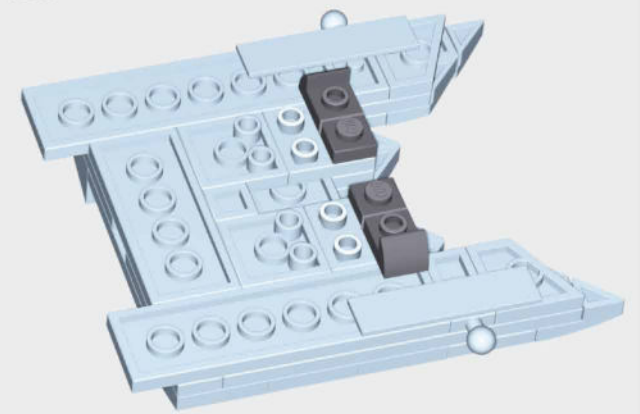

14

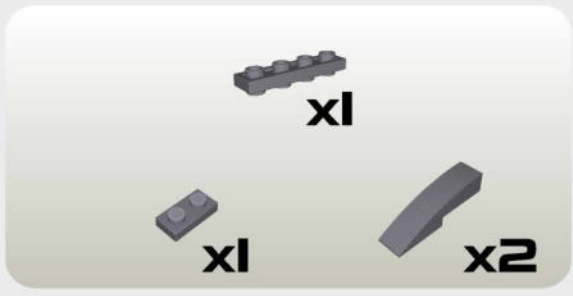
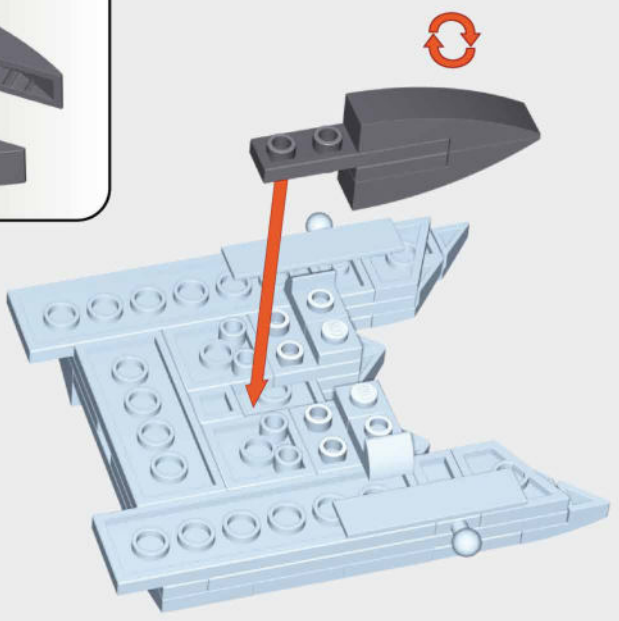
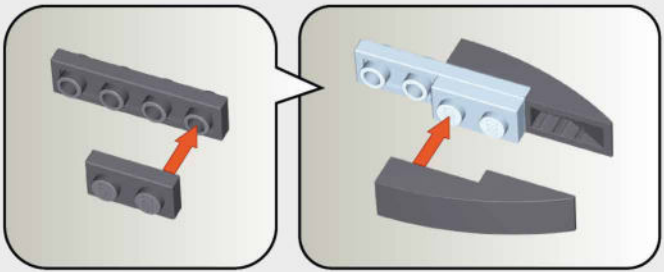

15

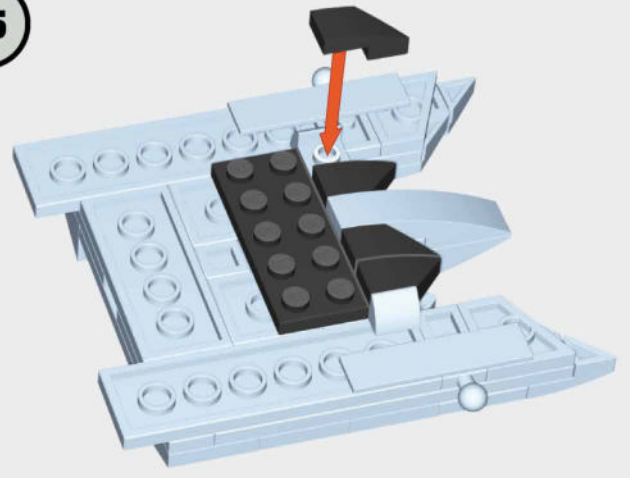

16

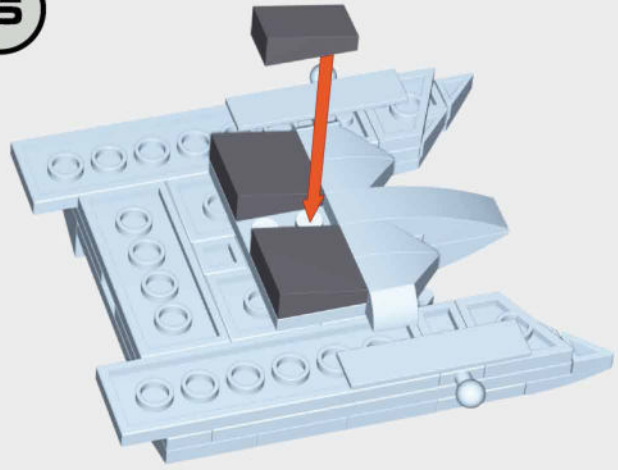

17



18

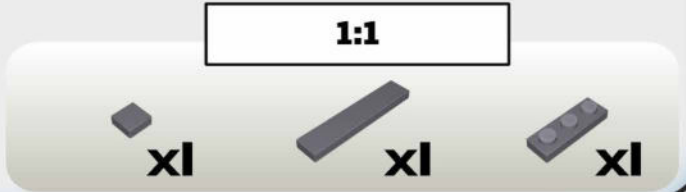
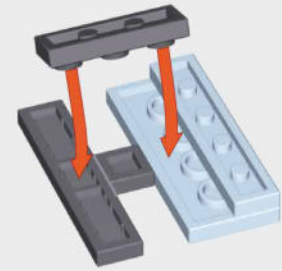

19

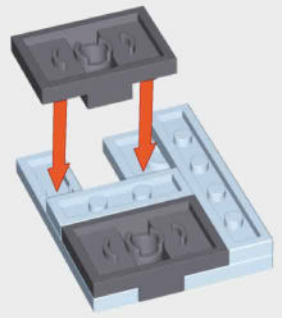

20



21

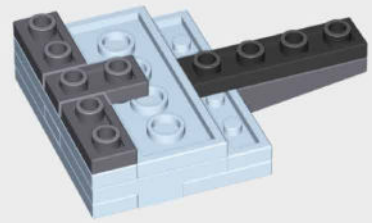

22

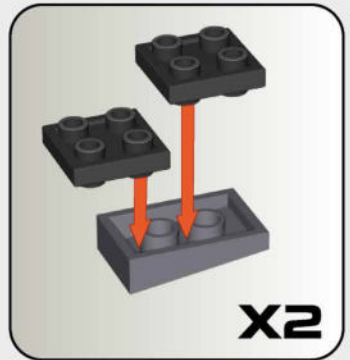
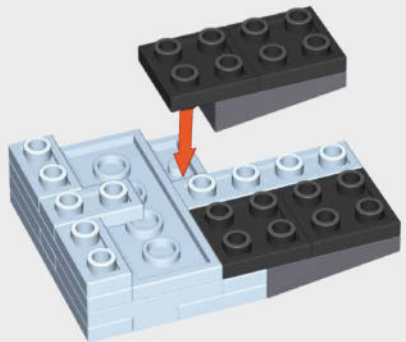

23

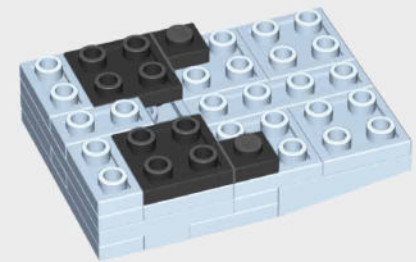

24

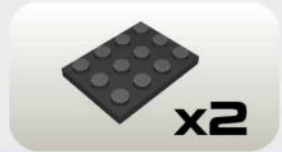
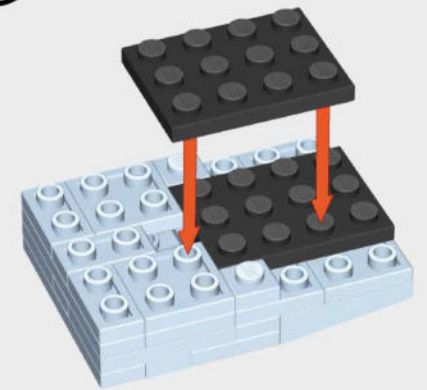

25

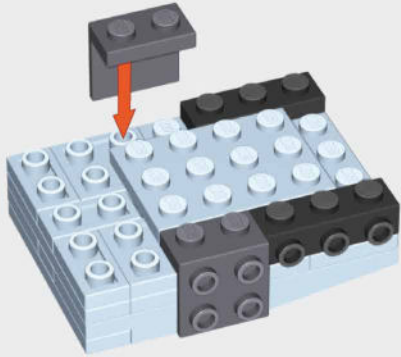

26

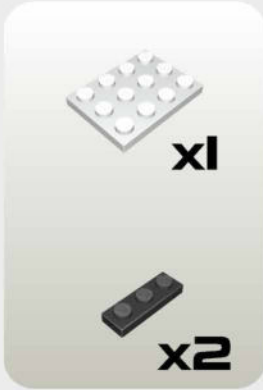

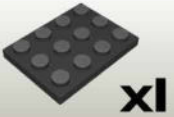
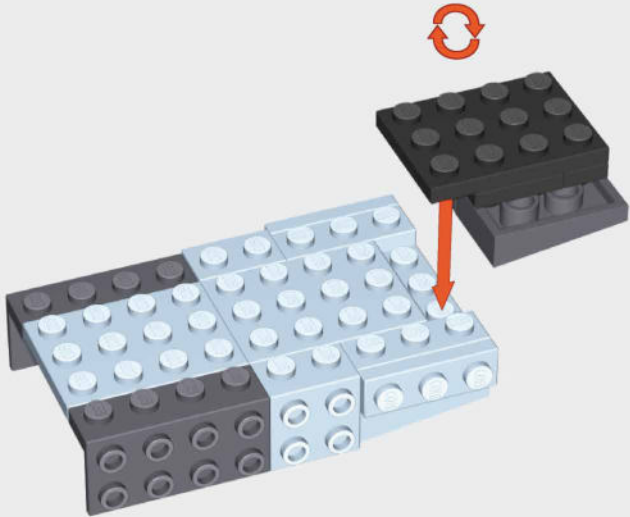
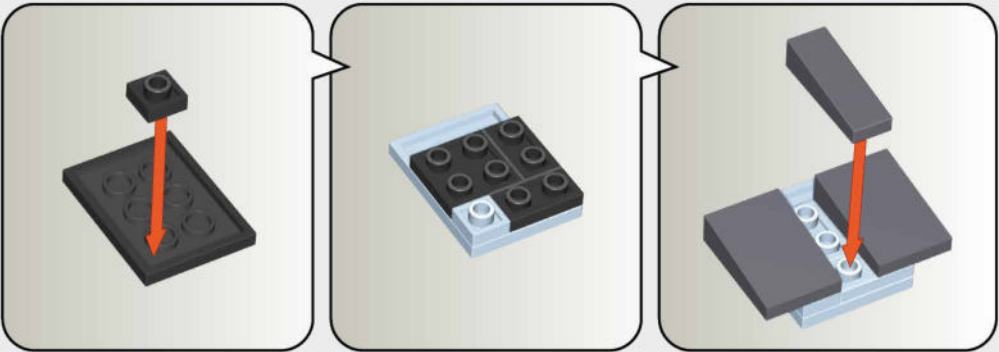

27

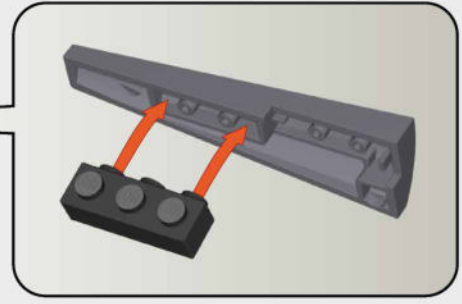
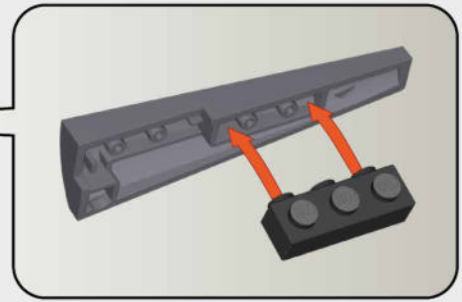
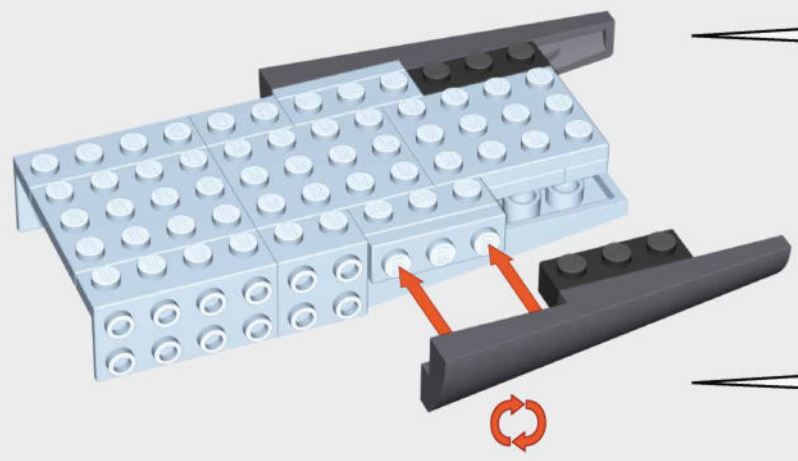

28



-  x1
-  x1
-  x2

29

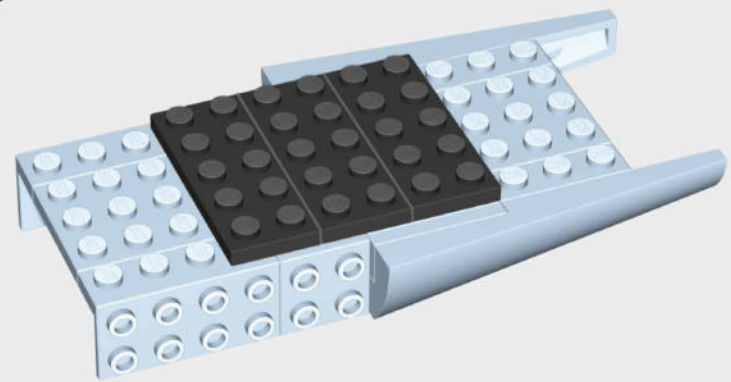

-  x3

30

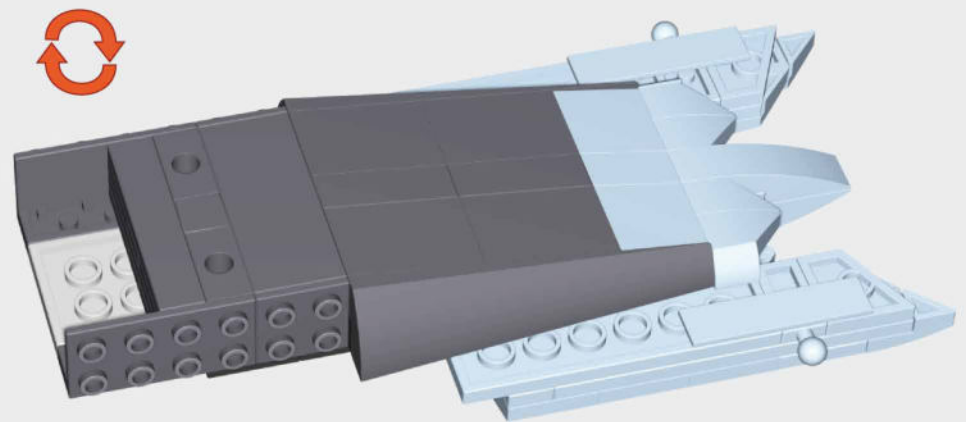

31

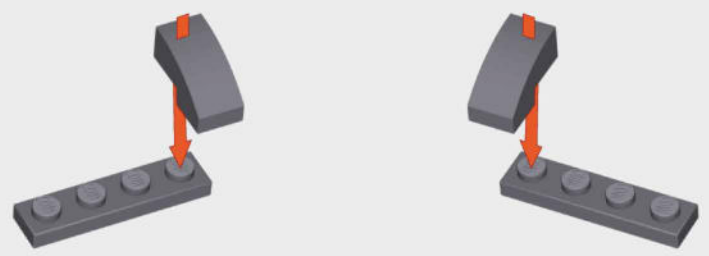

32

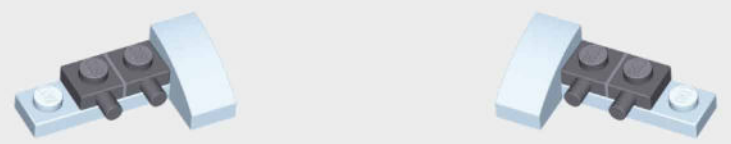

33

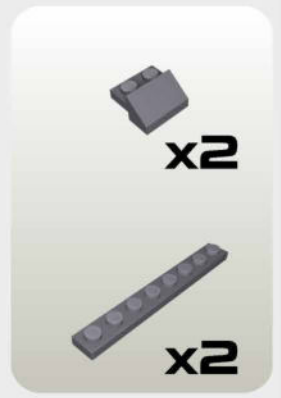
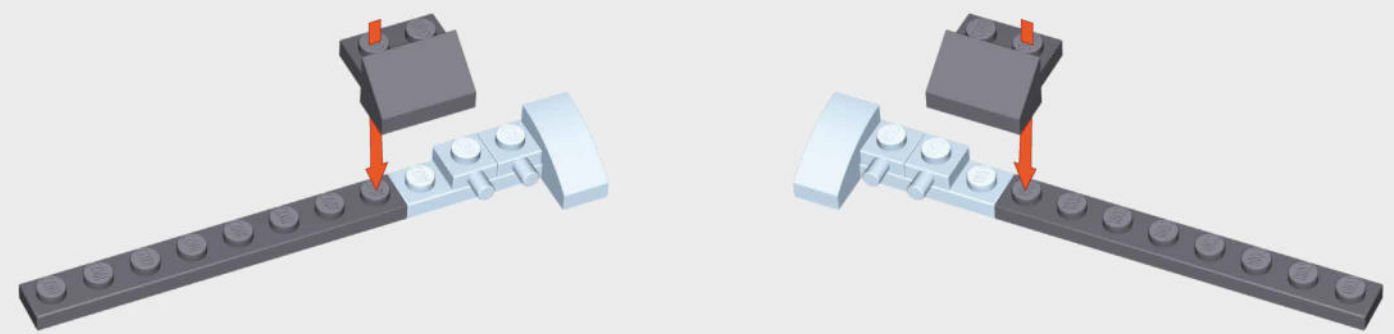

34

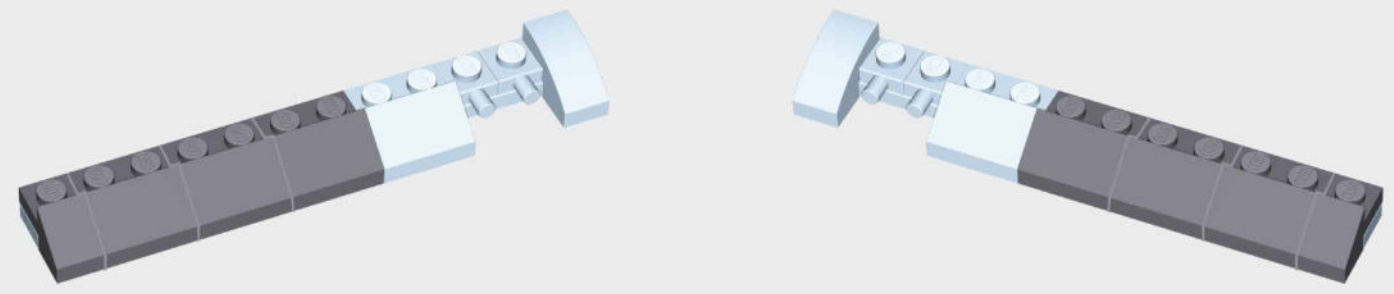

35

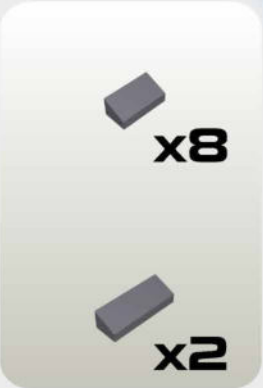
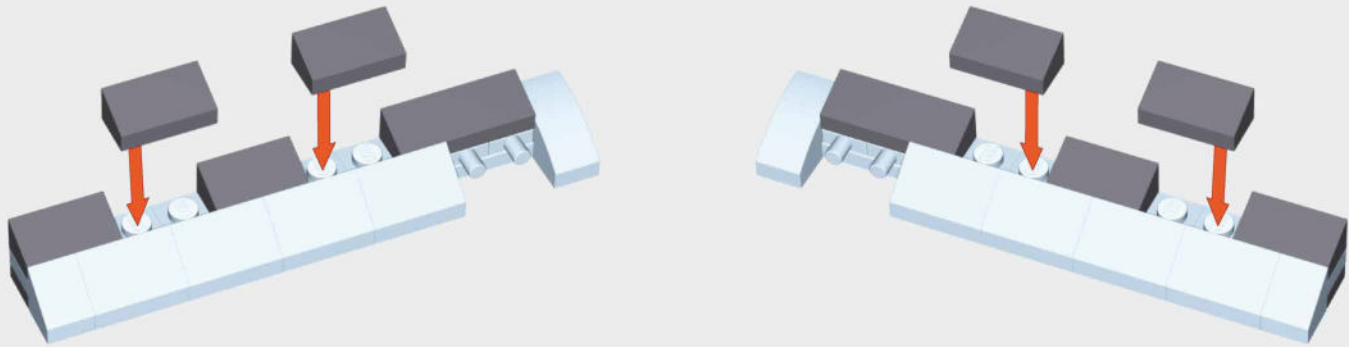

36



37

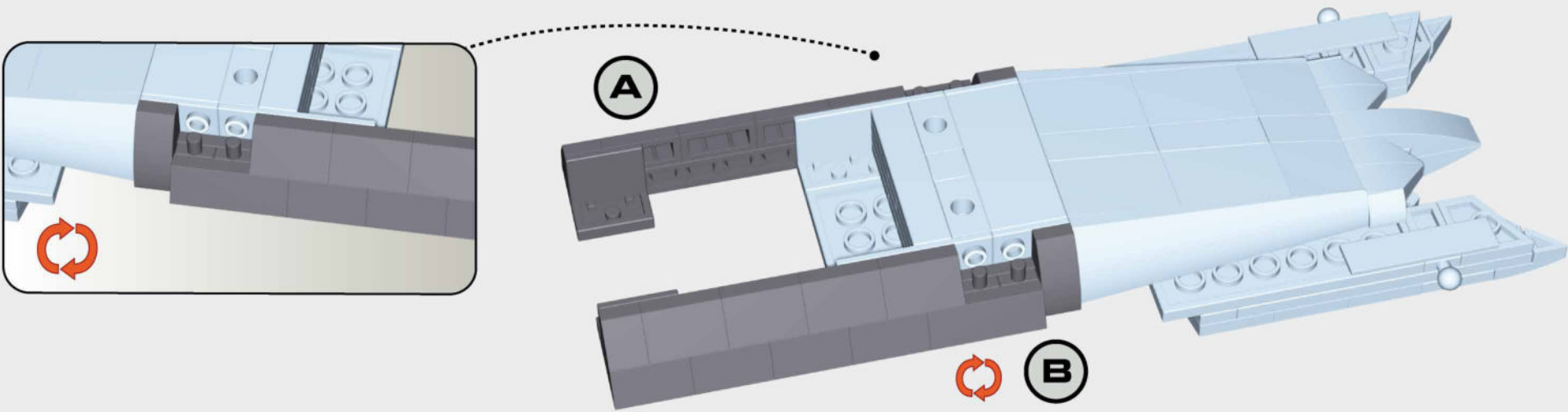

38



39

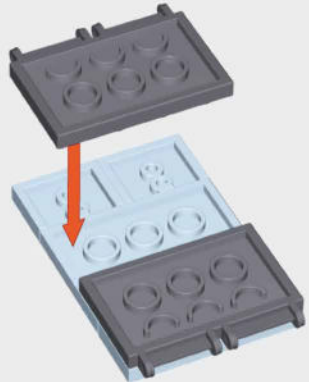

40



41

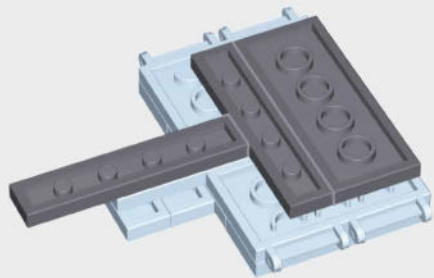

42

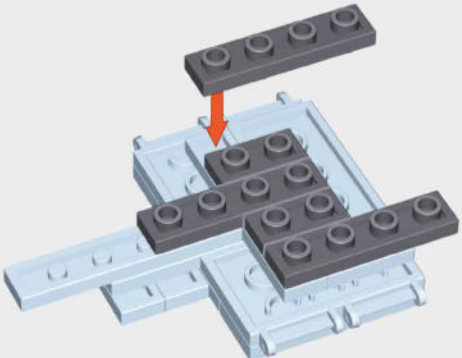

43

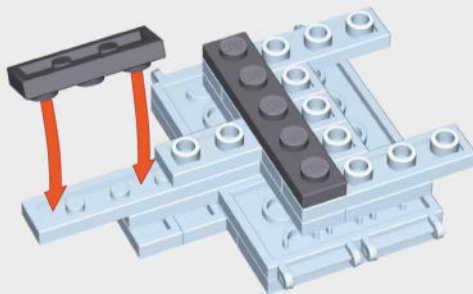

44

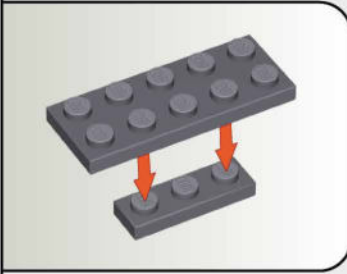
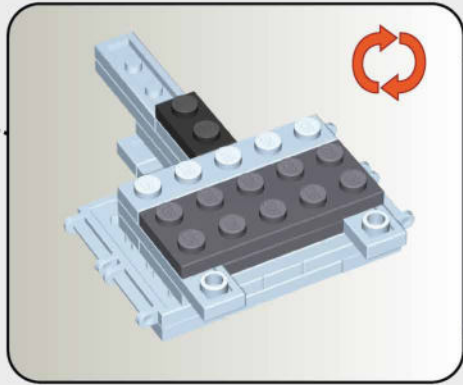
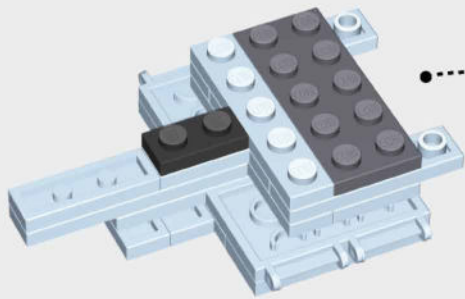

45

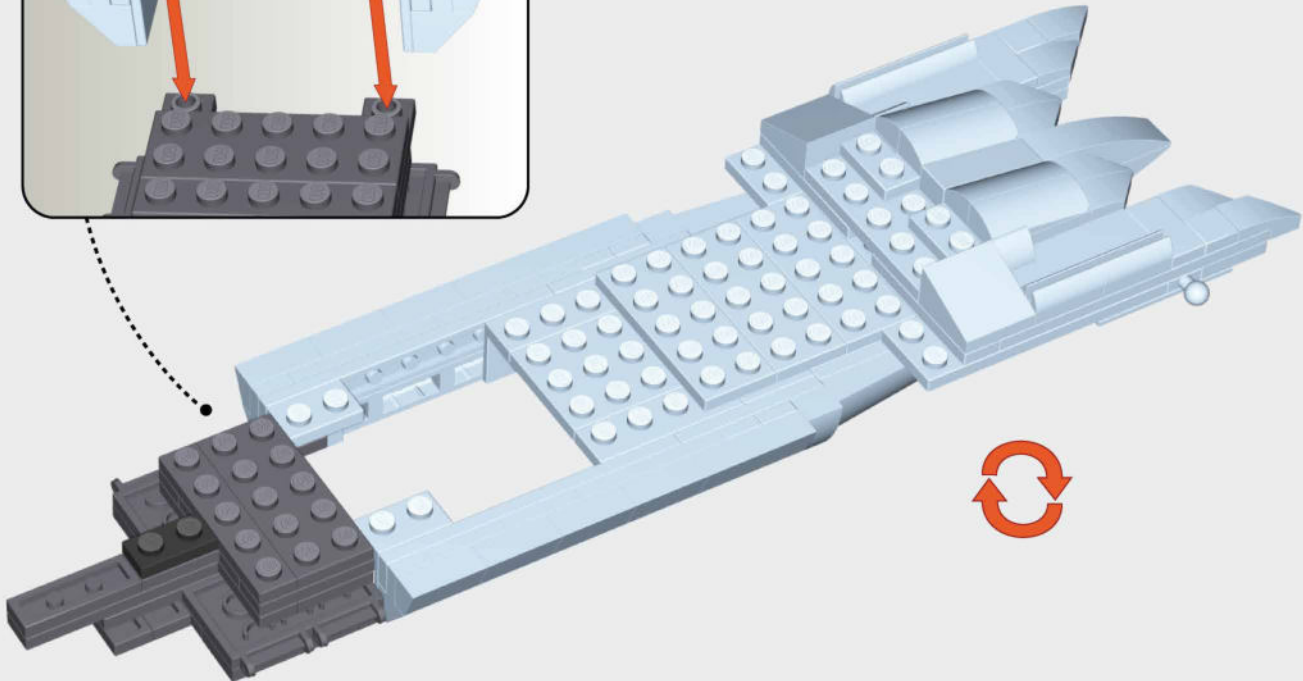
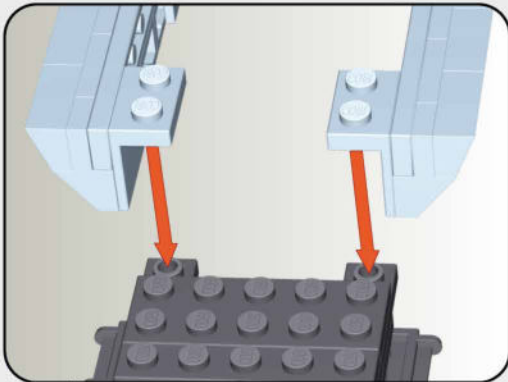

46

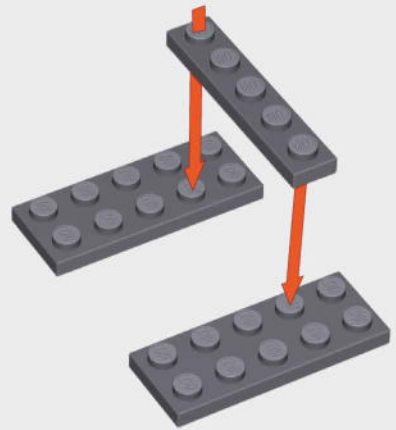

47

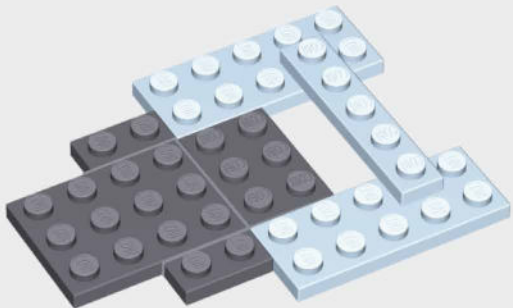

48

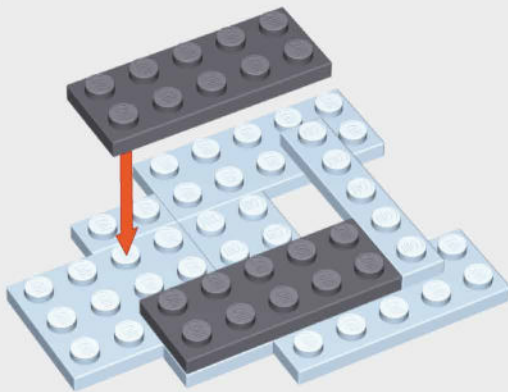

49

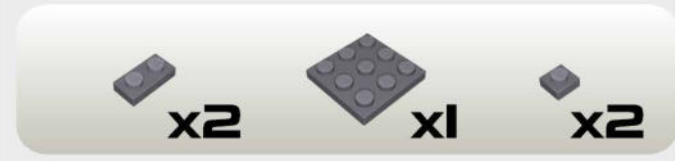
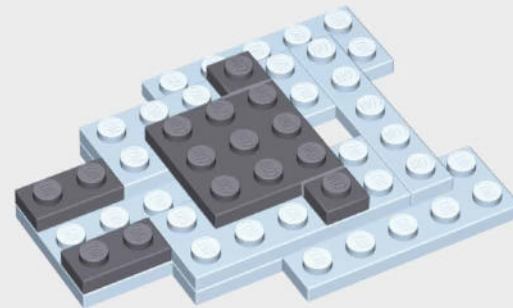

50



51

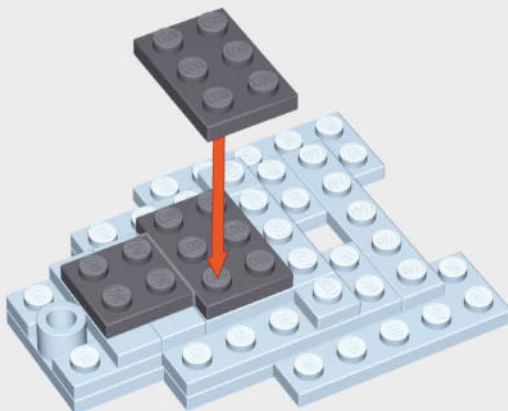

52

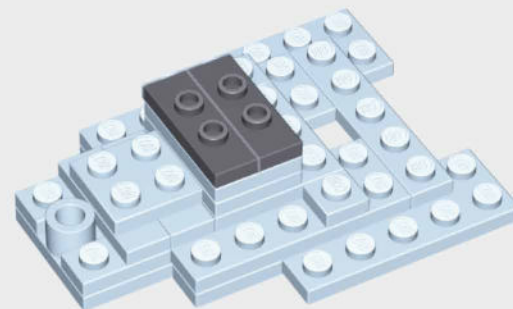

53

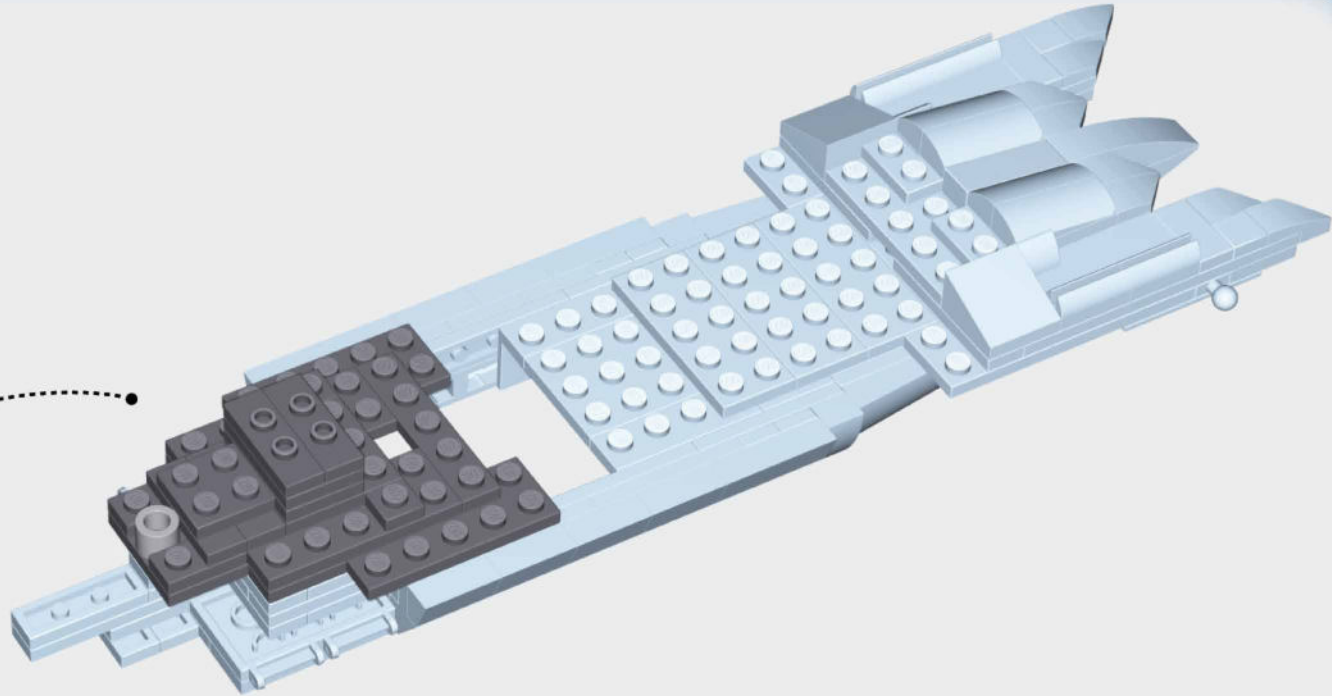
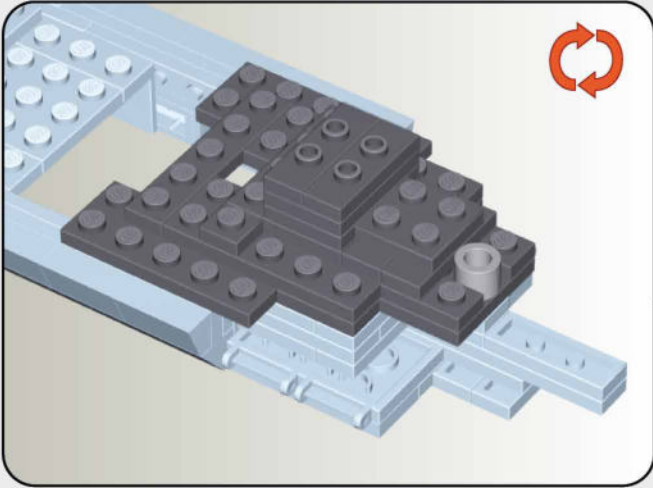

54

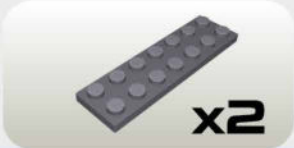
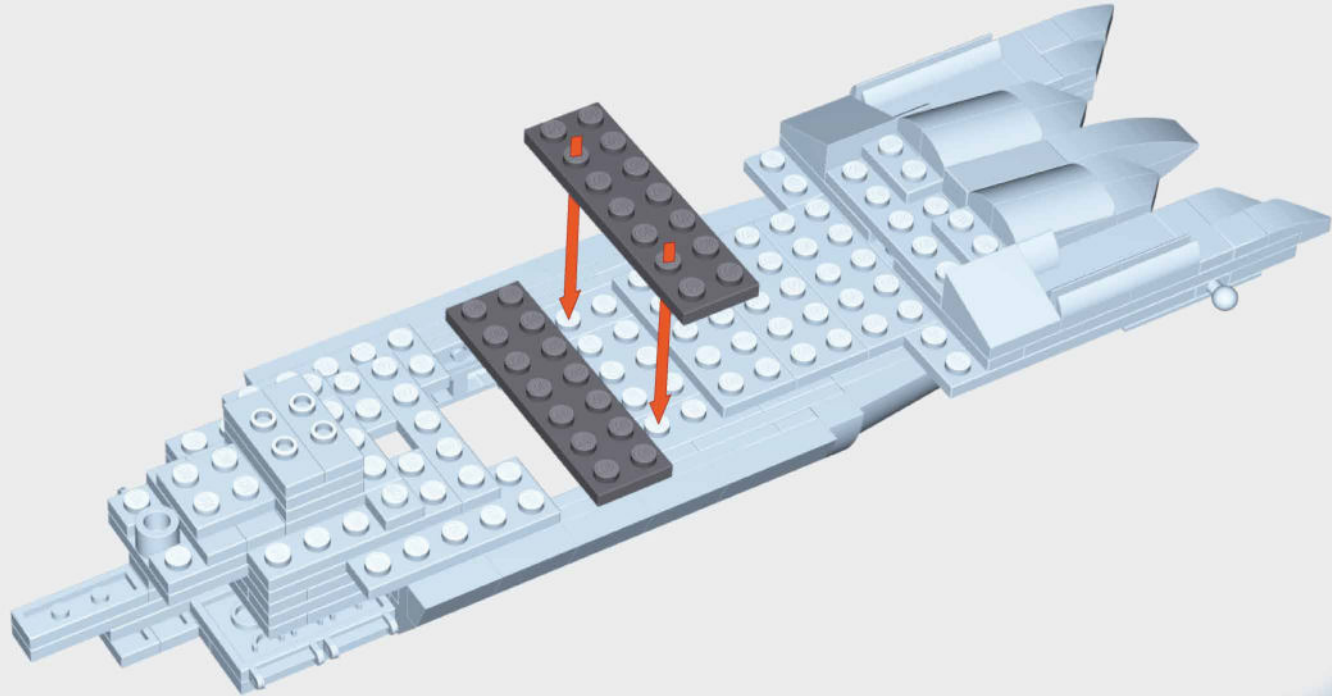

55



56



57

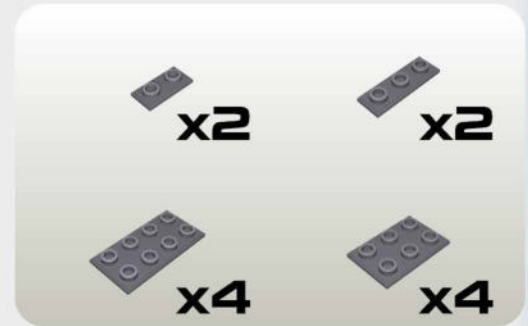

58



59

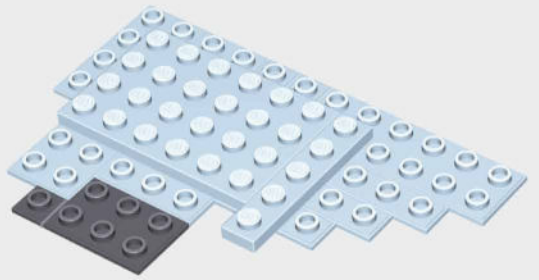

60

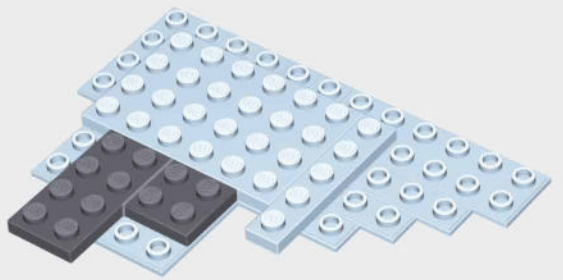

61

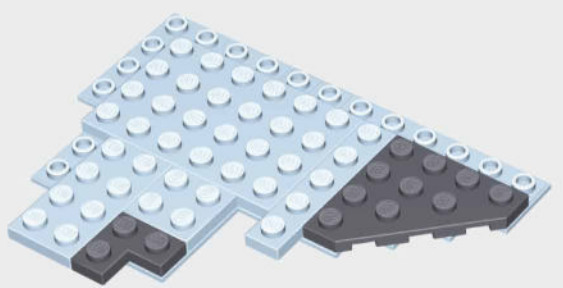
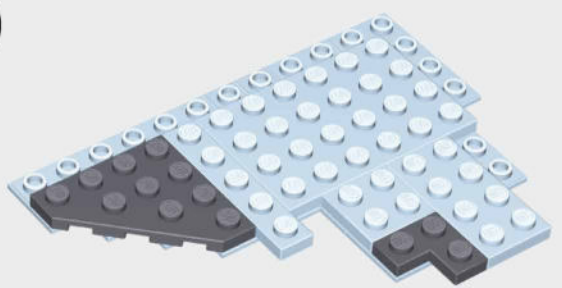

62

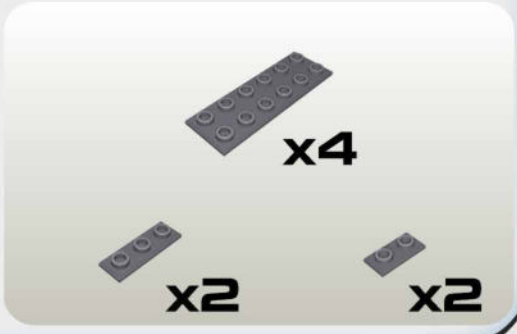
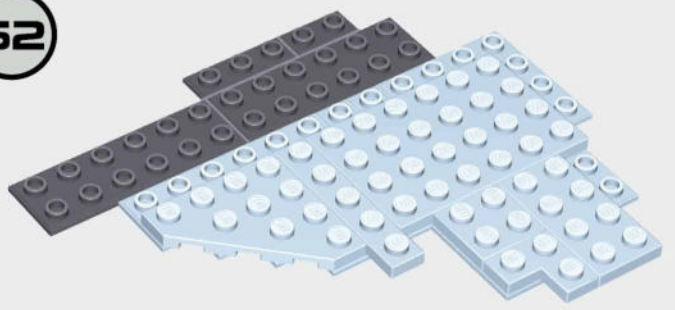

63

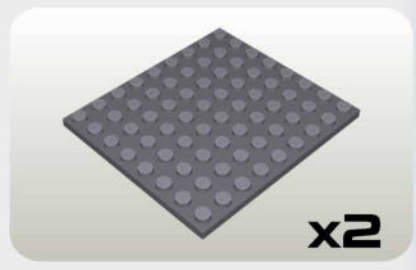
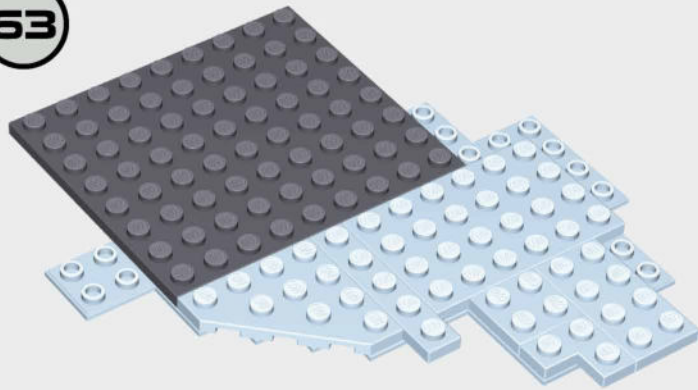

64

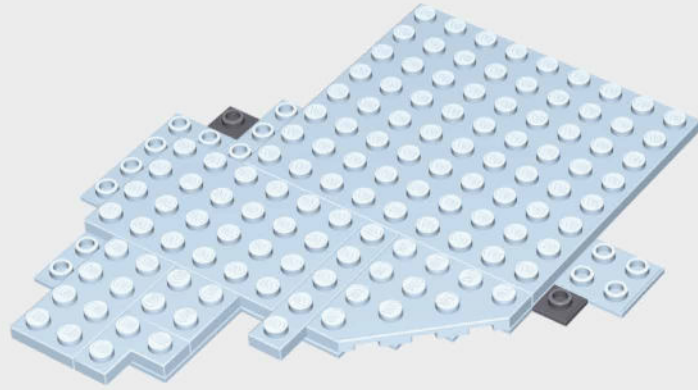
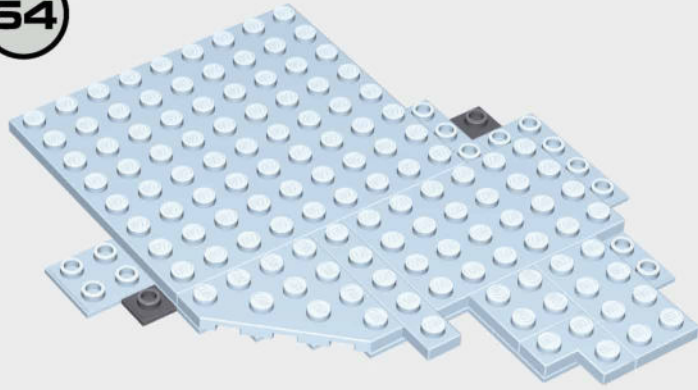

65

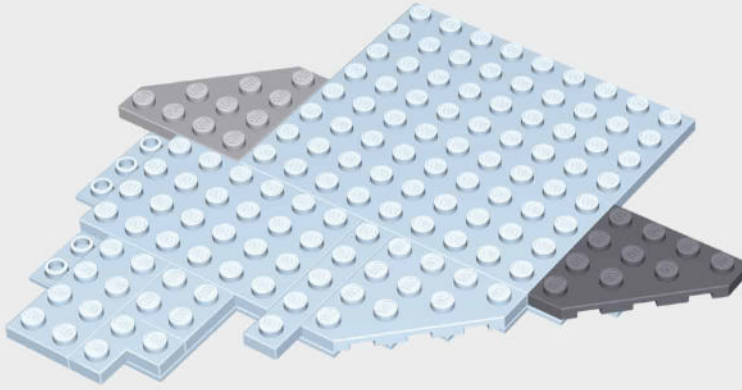
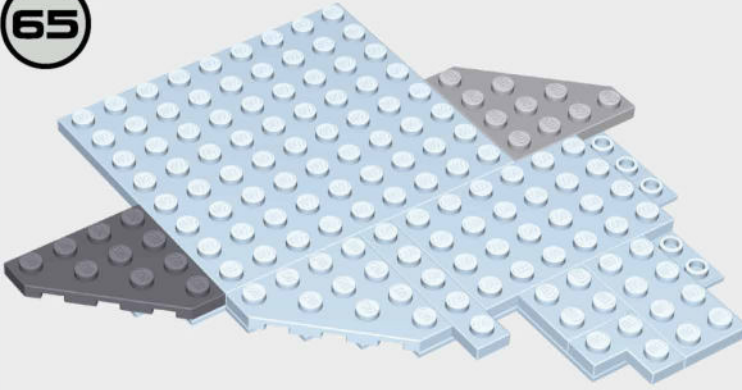

69

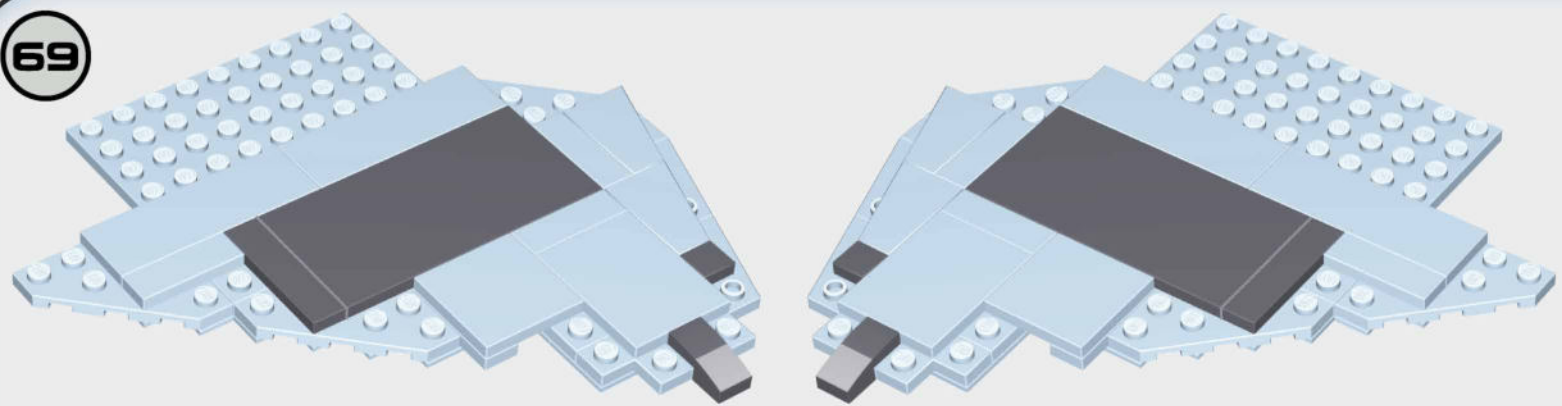

1:1

- Dark grey Technic plate (1x4) x2
- Light blue Technic pin (1x2) x2
- Light blue Technic pin (1x1) x2
- Dark grey Technic pin (1x1) x2

70

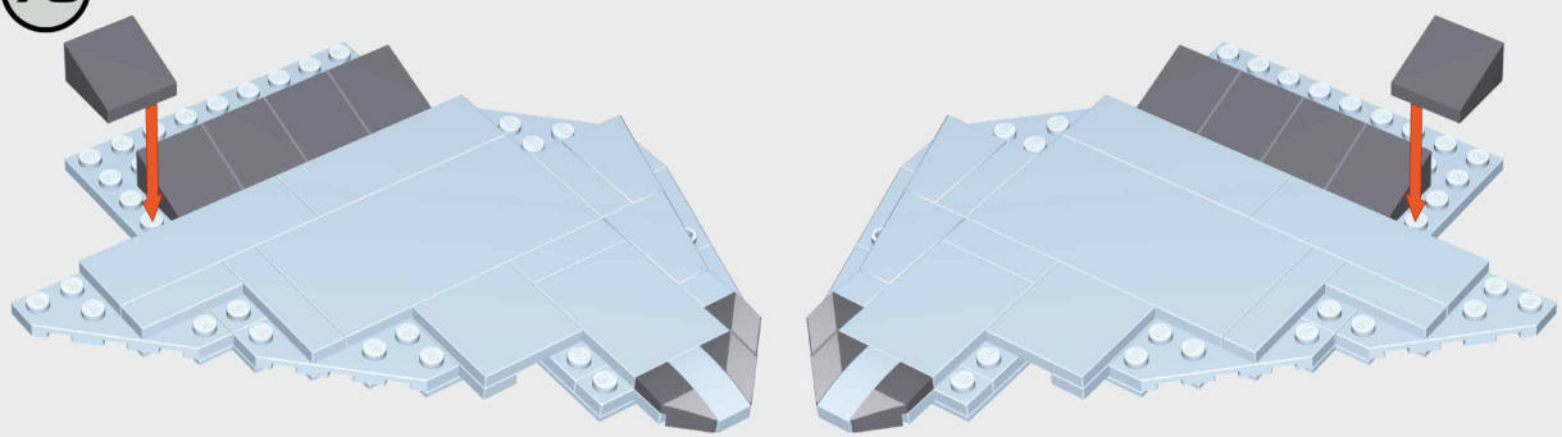

- Dark grey Technic pin (1x1) with a small circle containing the number 4 x10
- Light blue Technic pin (1x2) x2
- Light blue Technic pin (1x1) x2
- Dark grey Technic pin (1x1) x1
- Light blue Technic pin (1x1) x1

71

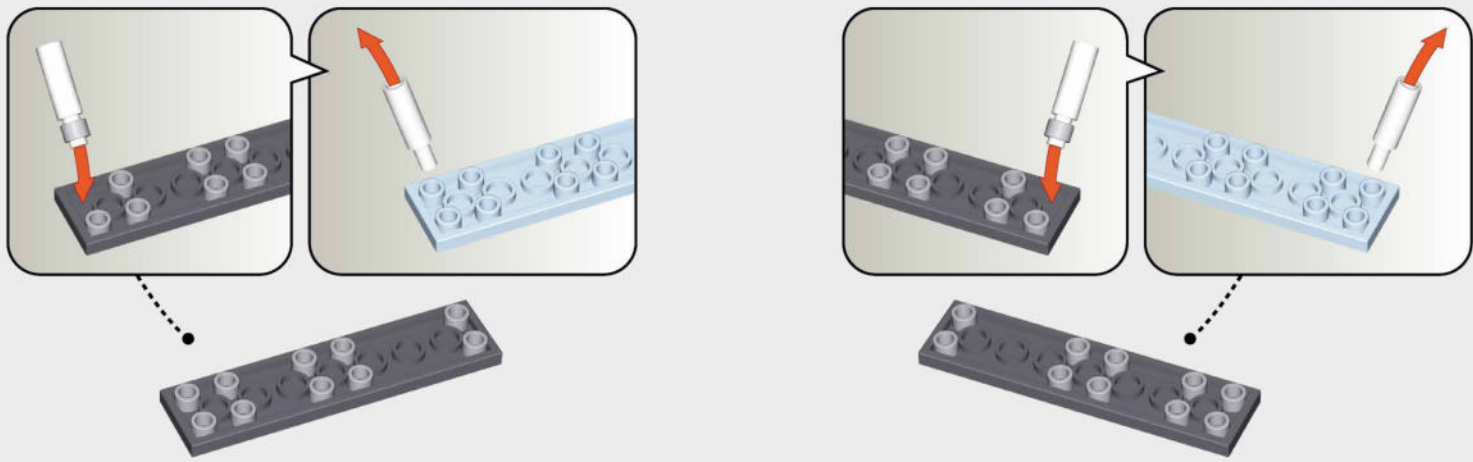

- Dark grey Technic Technic pin (1x4) x2
- Light blue Technic Technic pin (1x4) x20

72



73



74

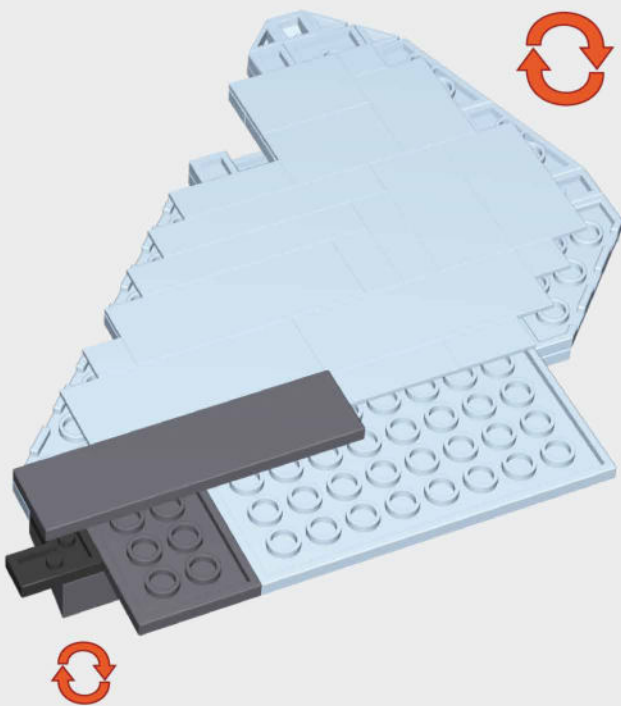

75

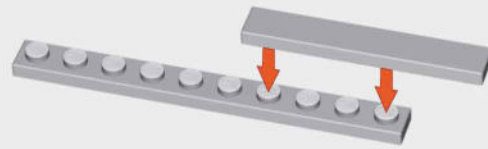
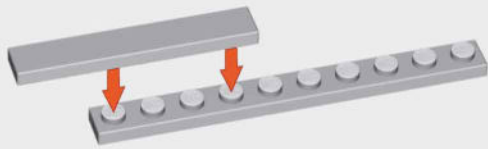

1:1

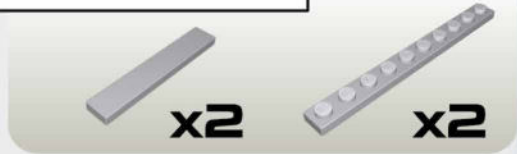

76

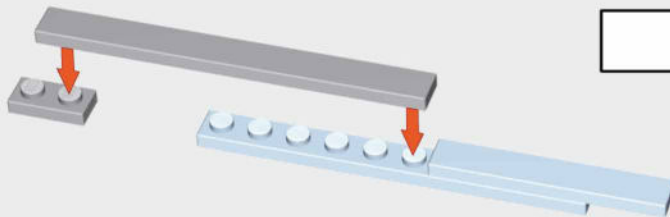
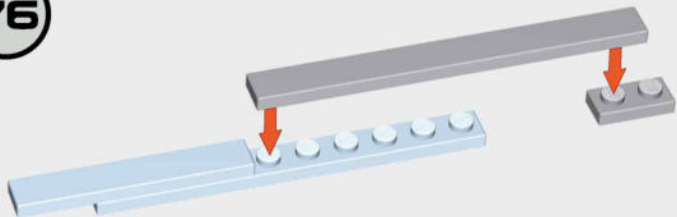

1:1



77



78

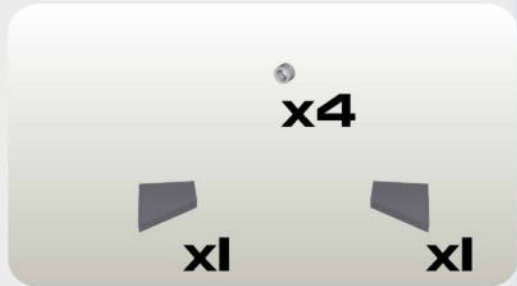
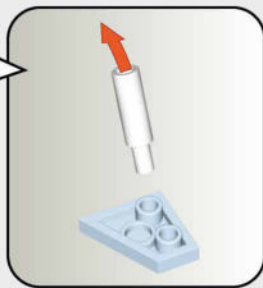
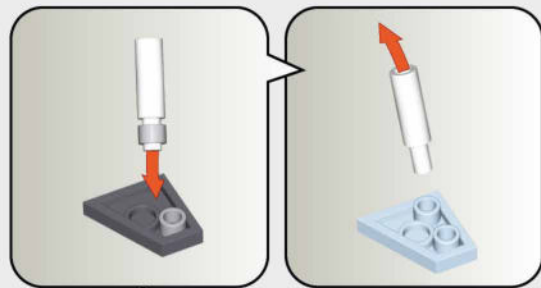
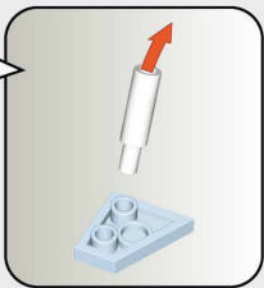
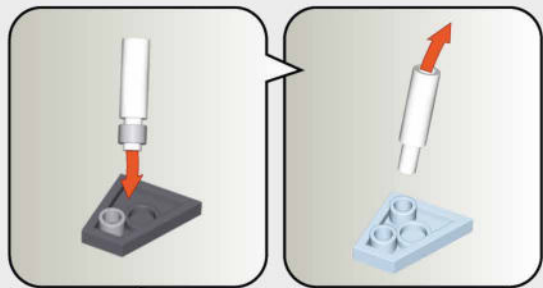

79



80

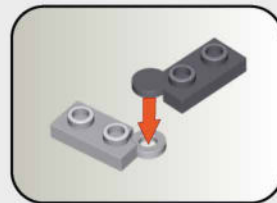
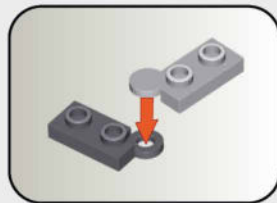

81

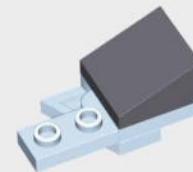
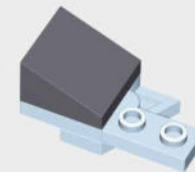

82



83

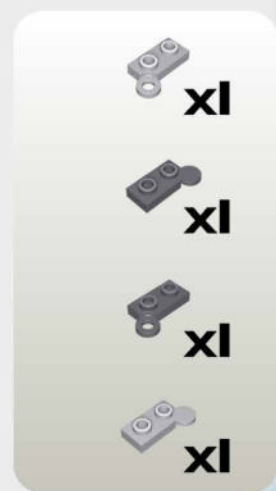
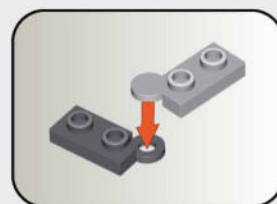
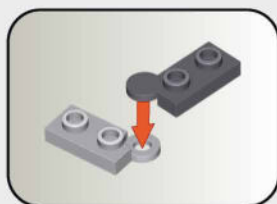
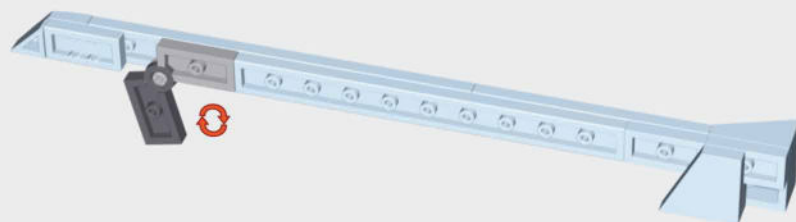
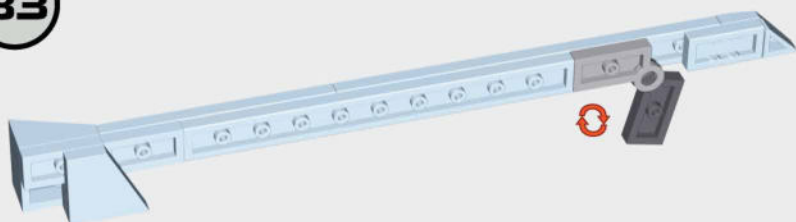

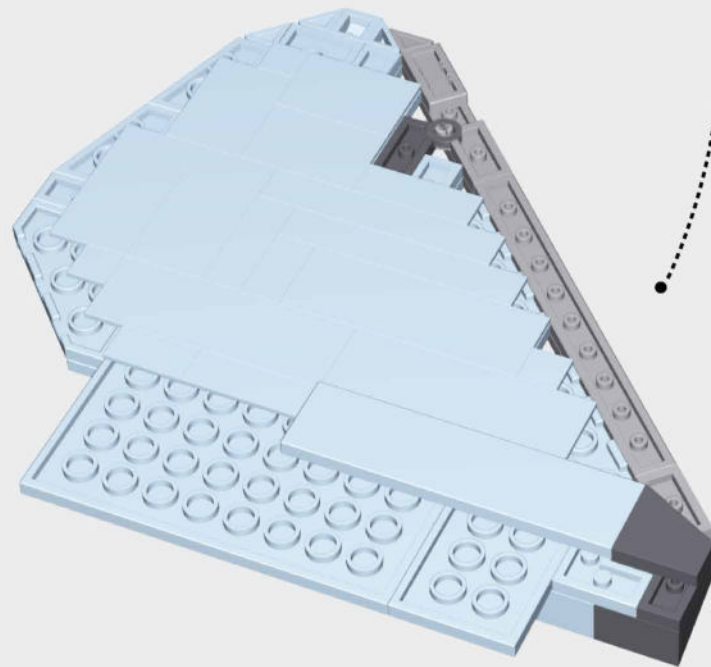
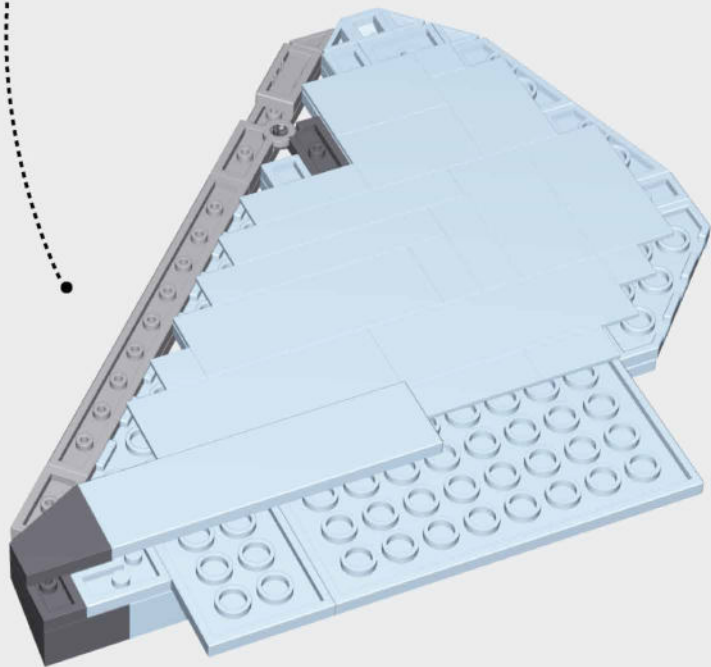
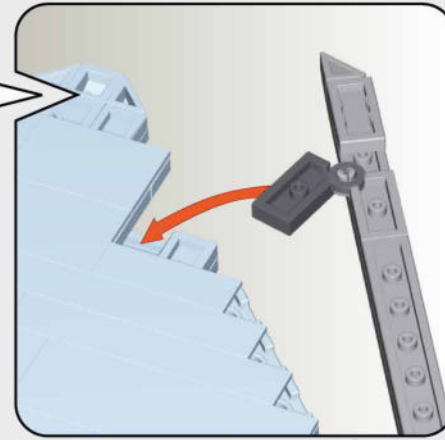
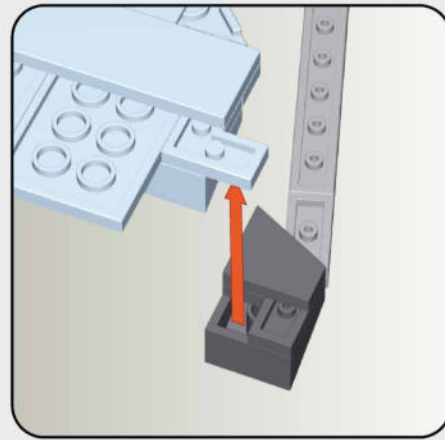
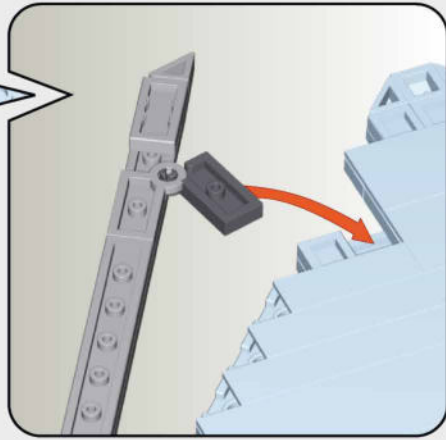
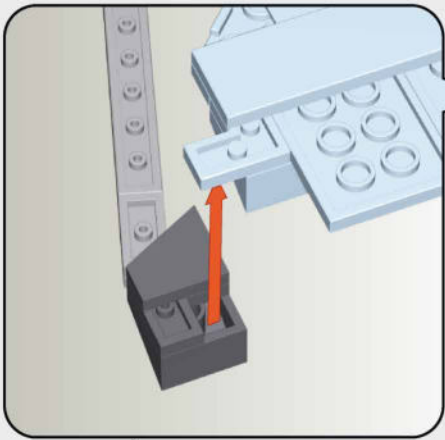

85

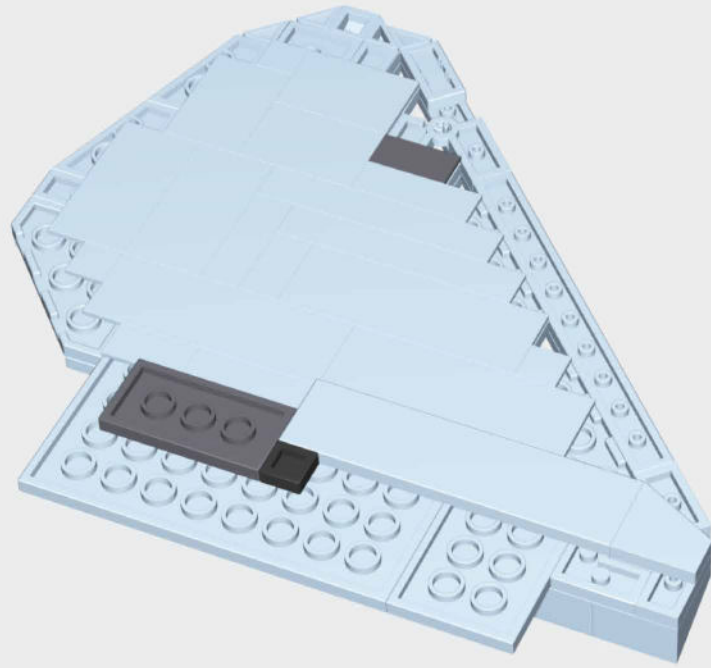
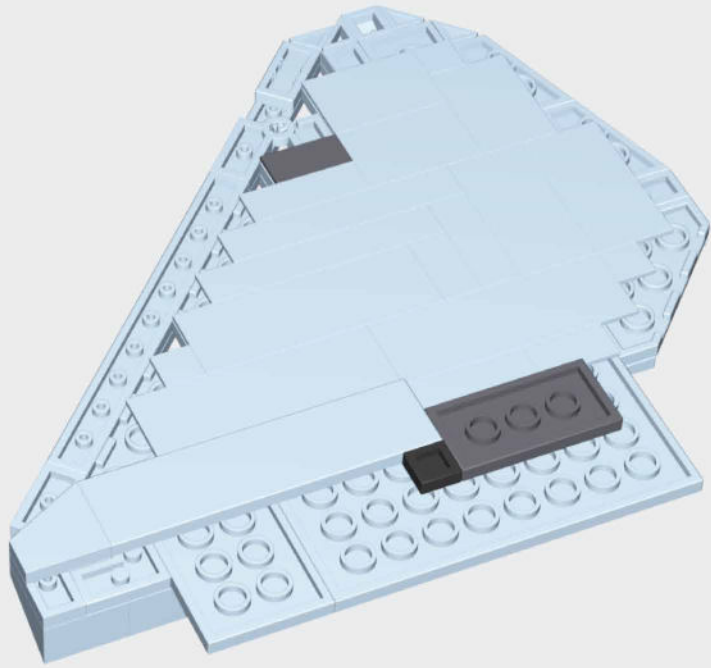

-  x2
-  x2
-  x2

86

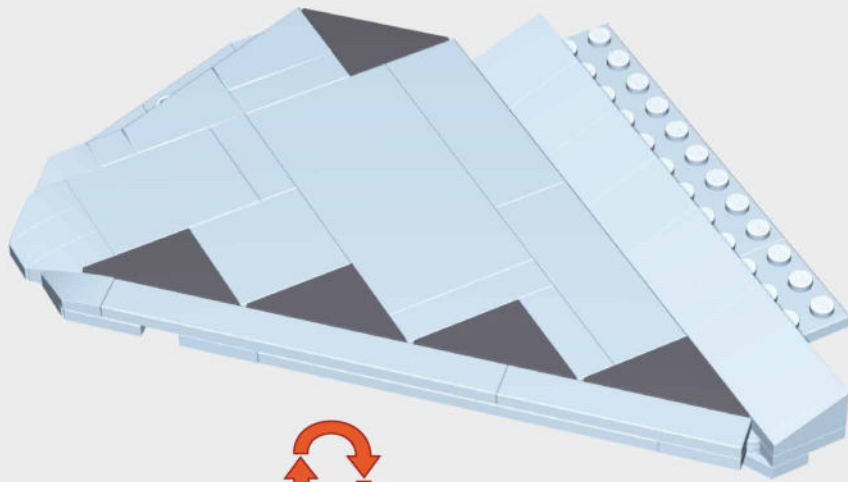
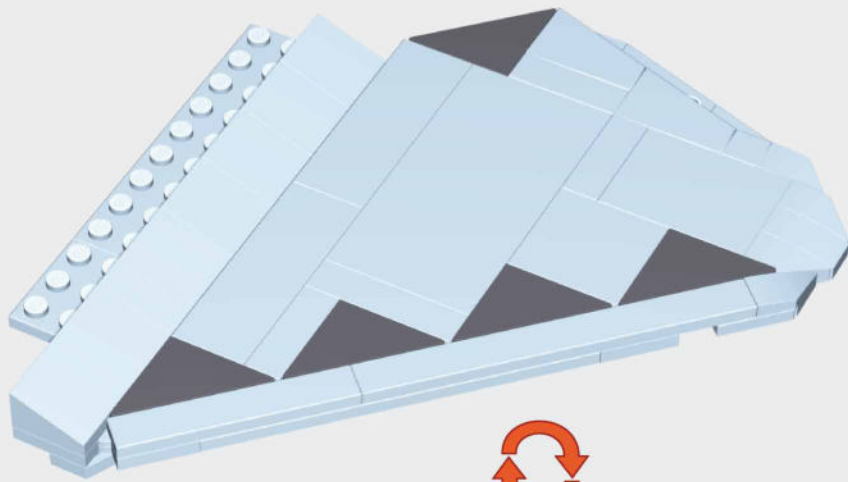

-  x10

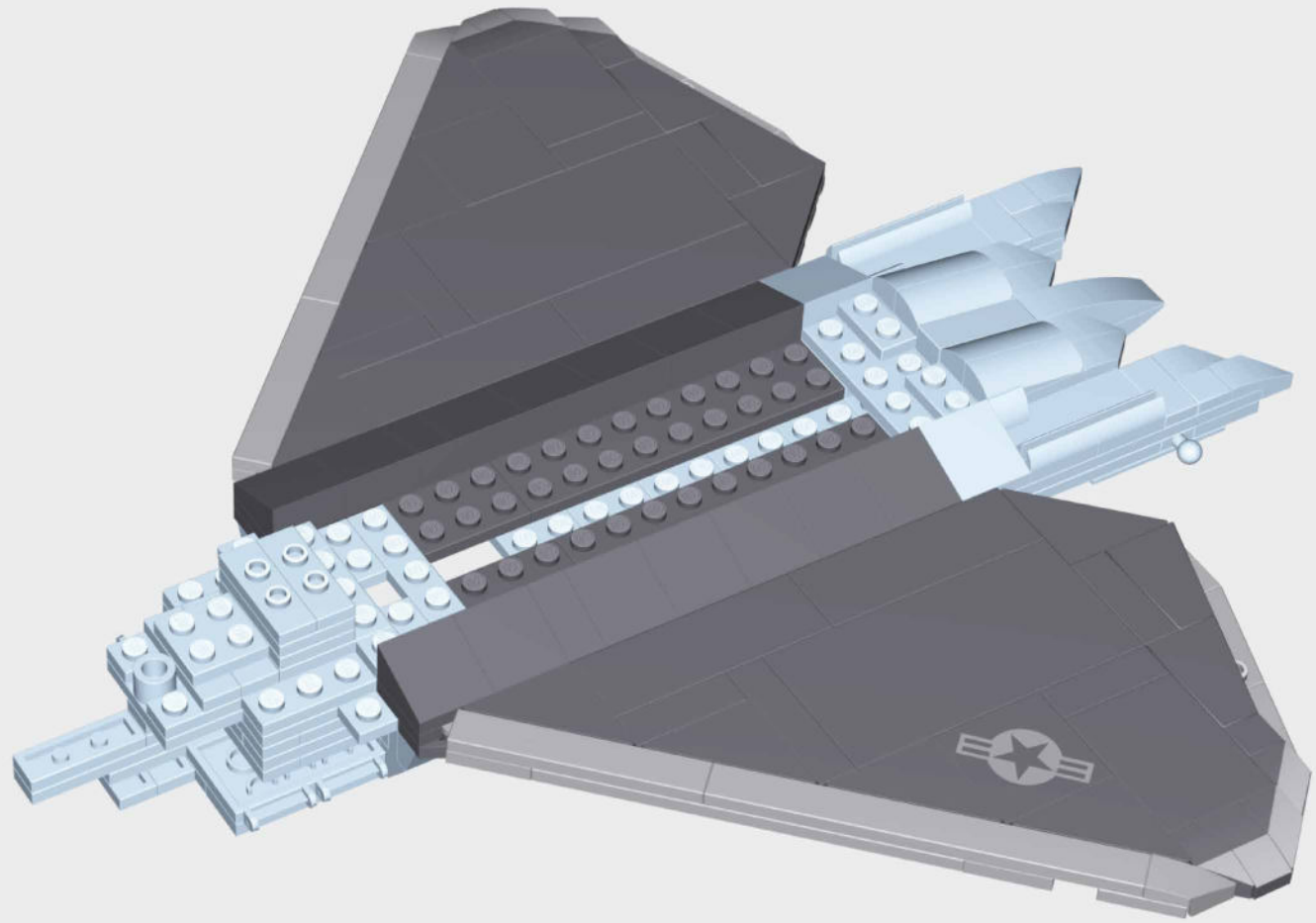

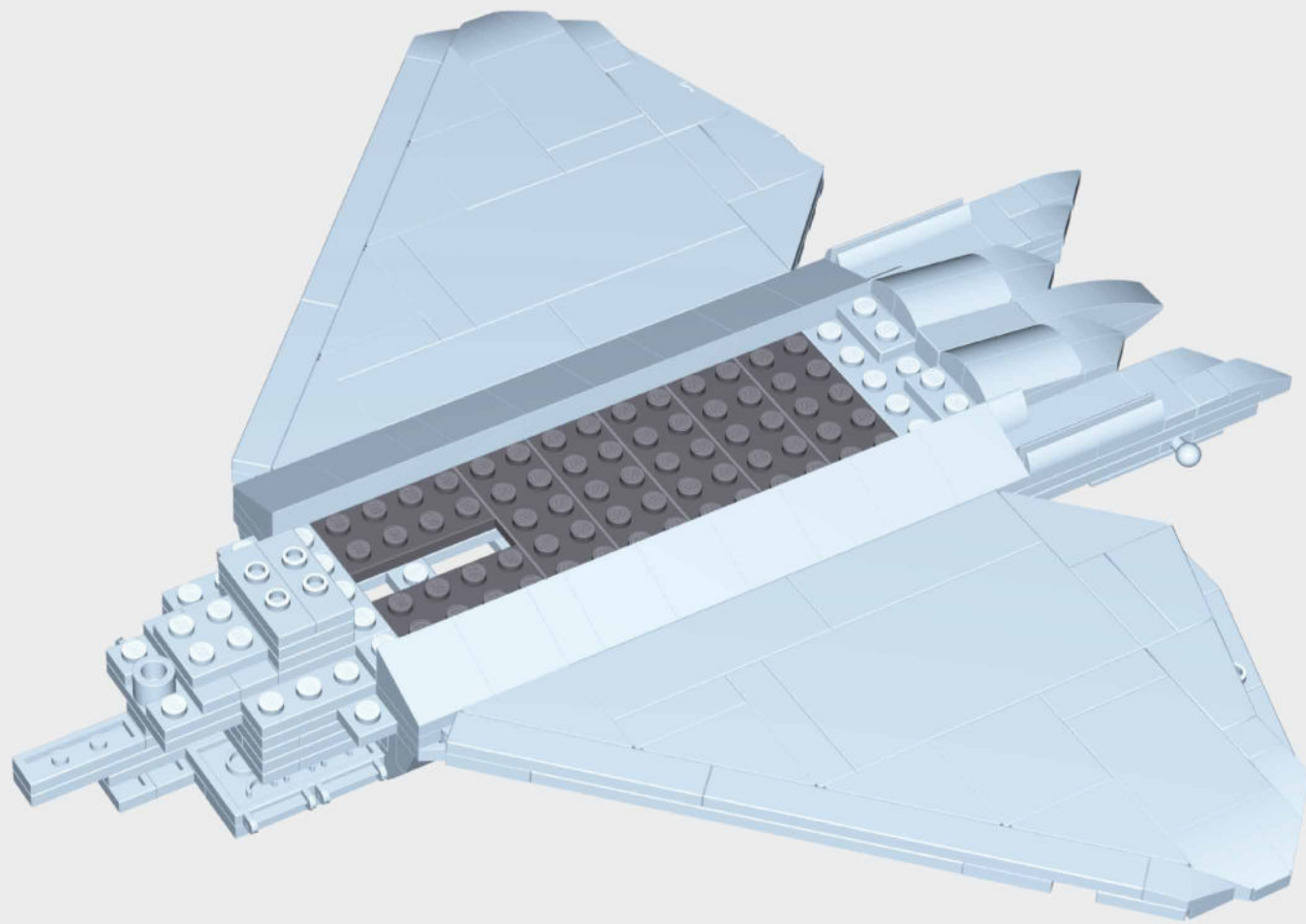

 x2



 x5

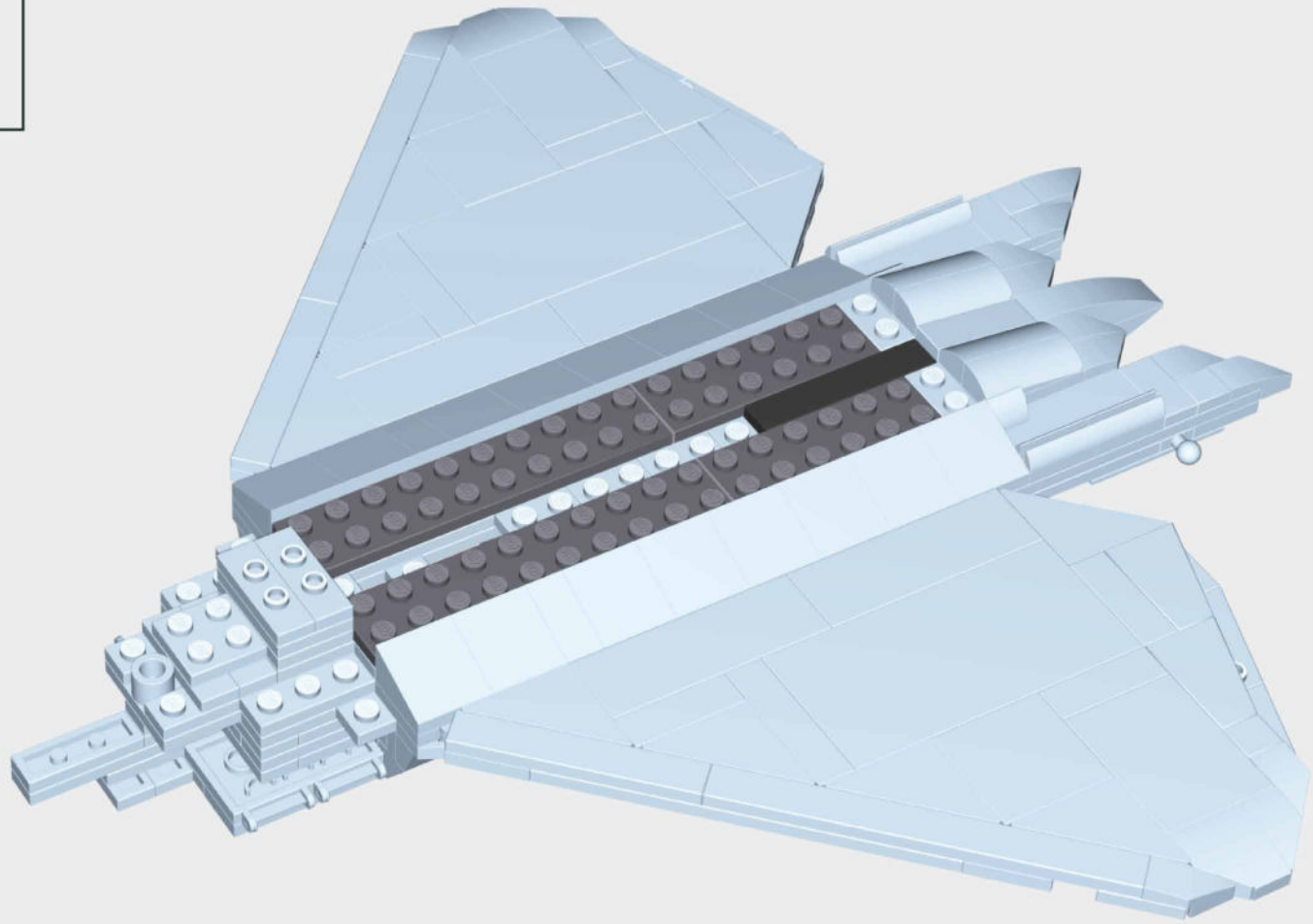

2

89

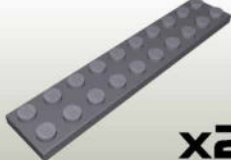

		
x2	x2	x1

1:1



91

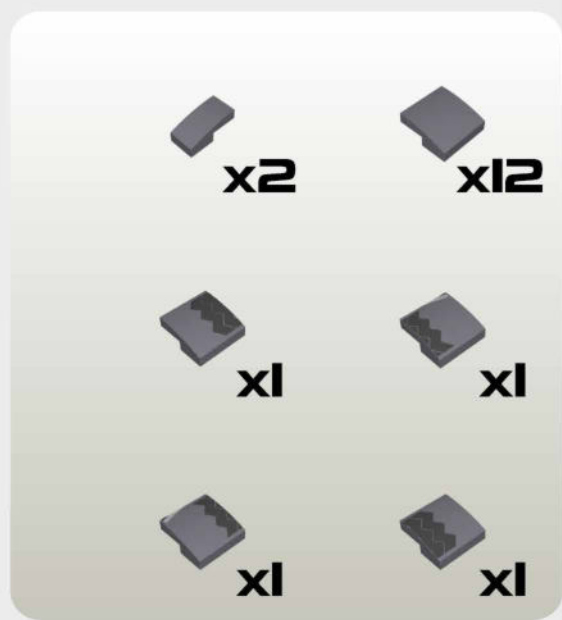
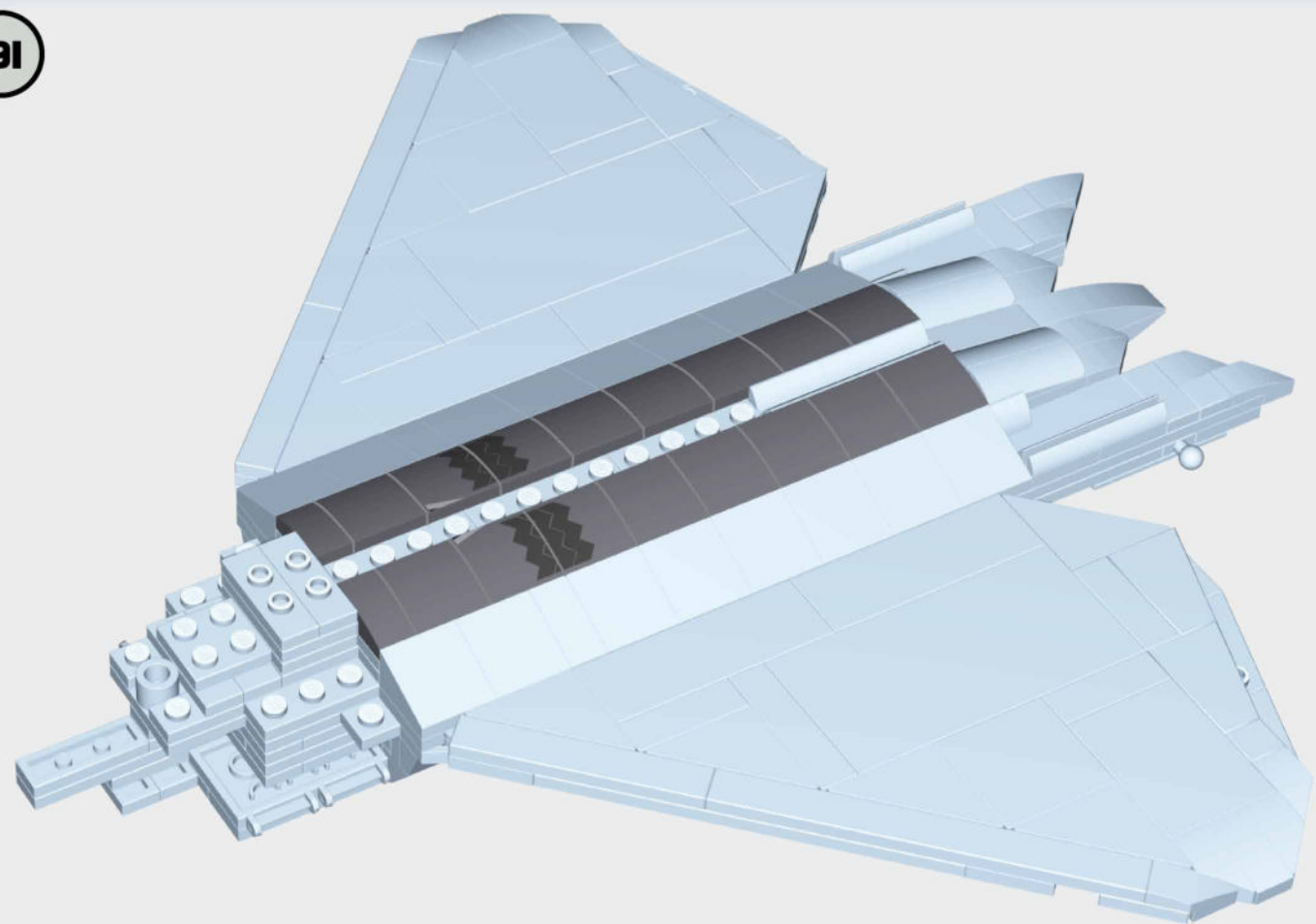

92

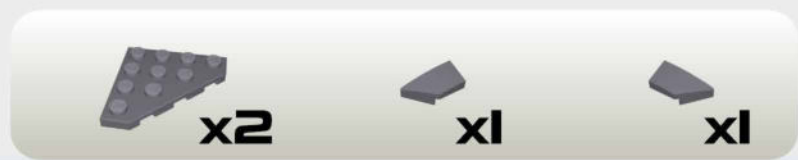

93

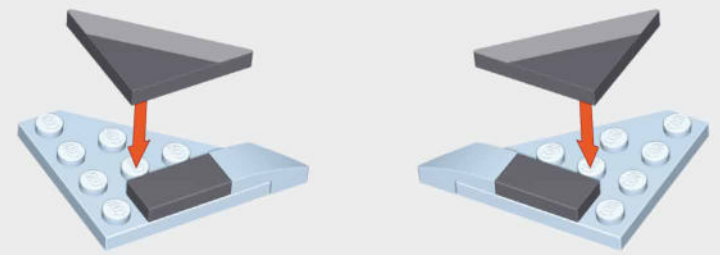

94

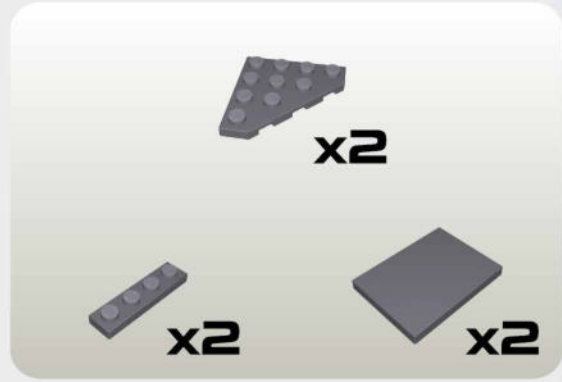
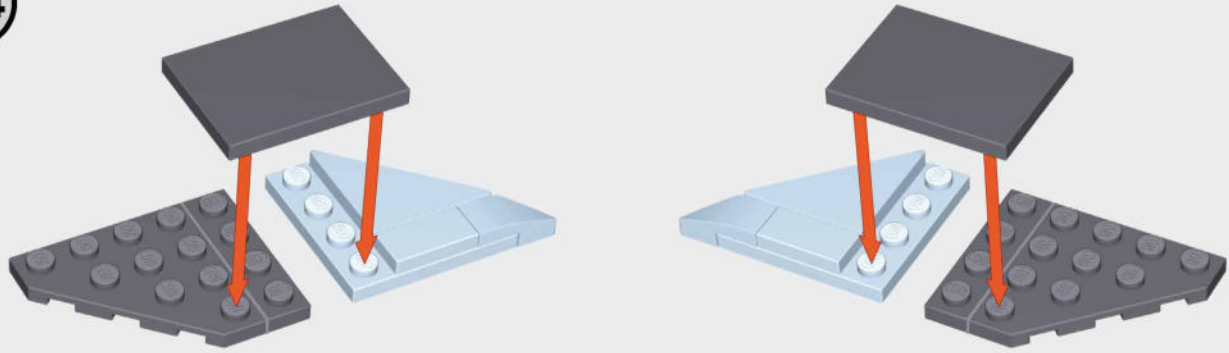

95

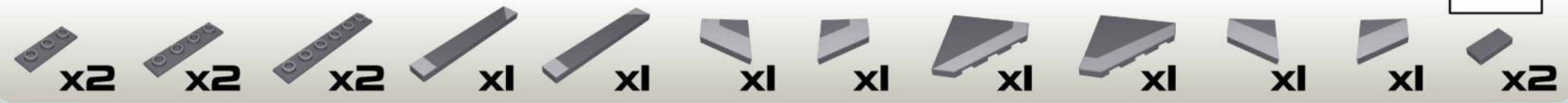
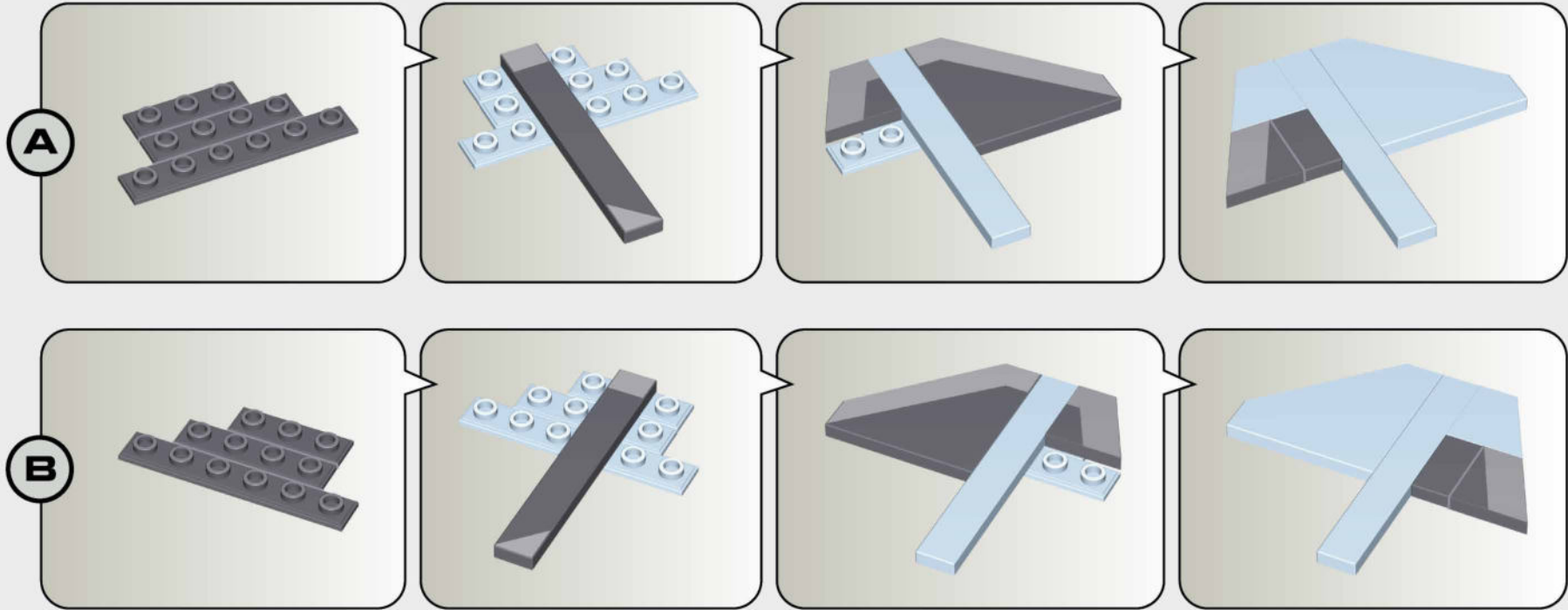

1:1

96

A

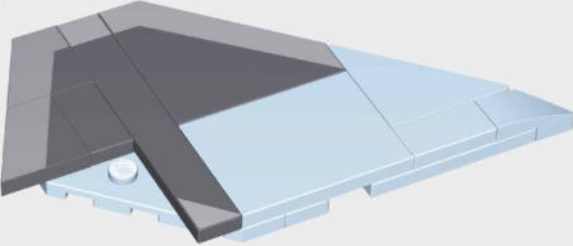

B

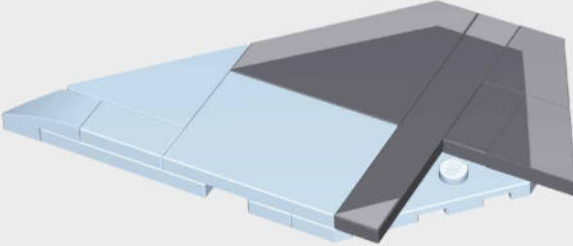

97

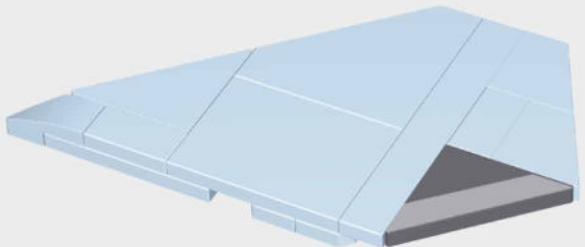
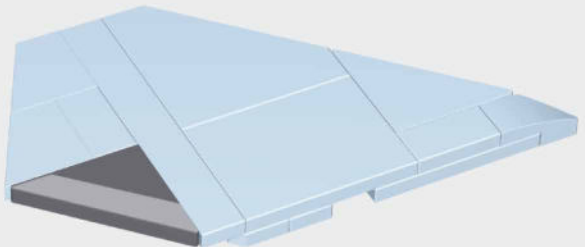

98

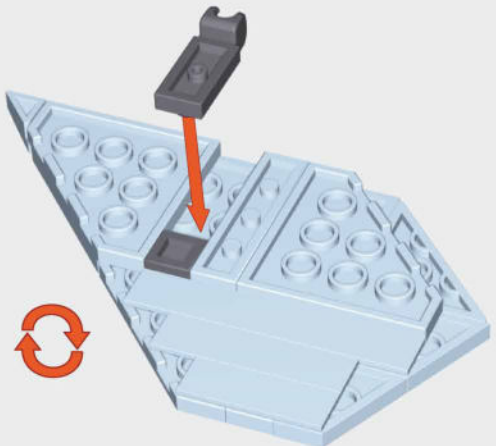
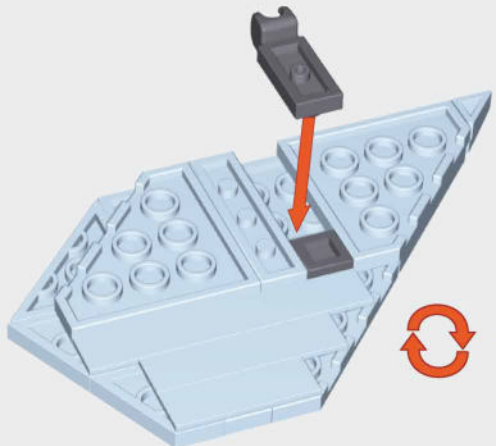

101

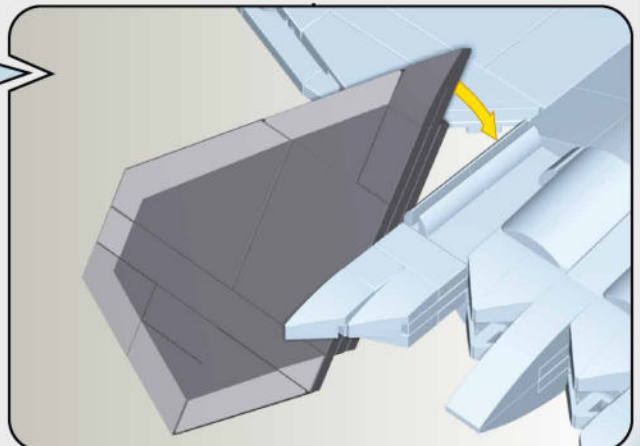
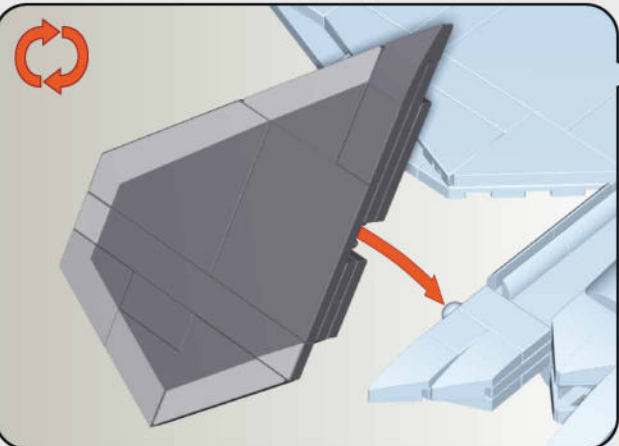
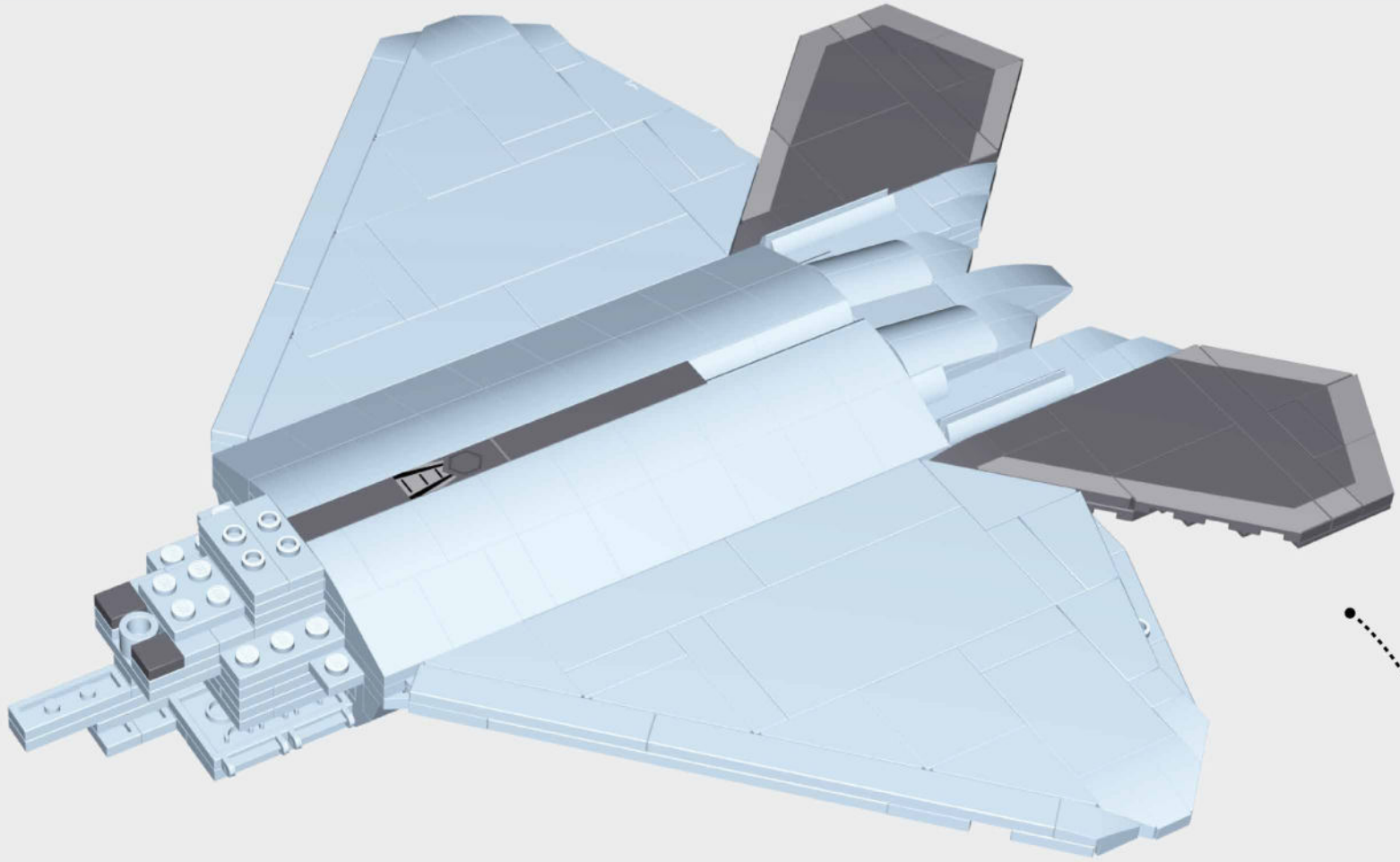

1:1

x2

x1

x1

102

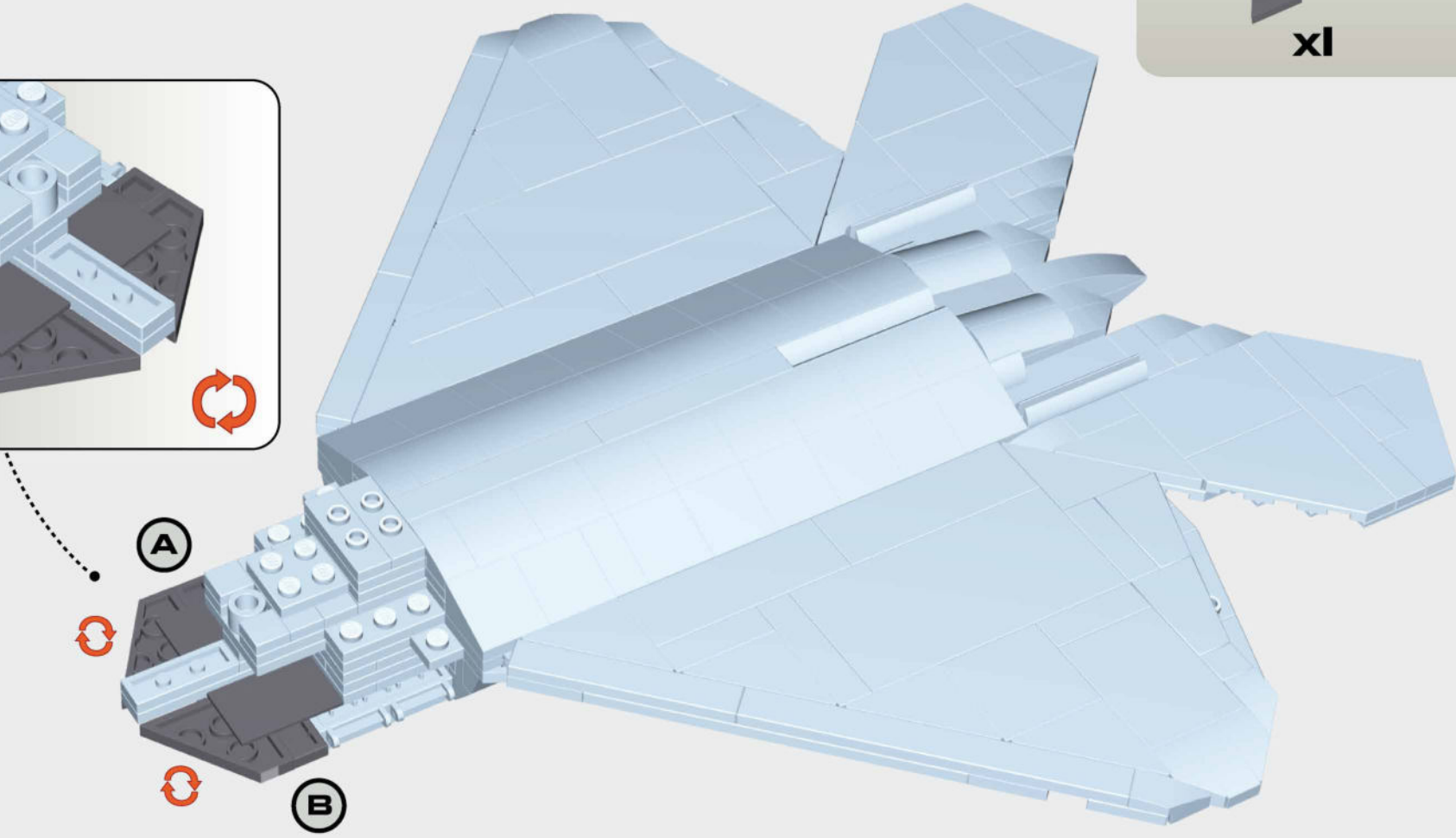
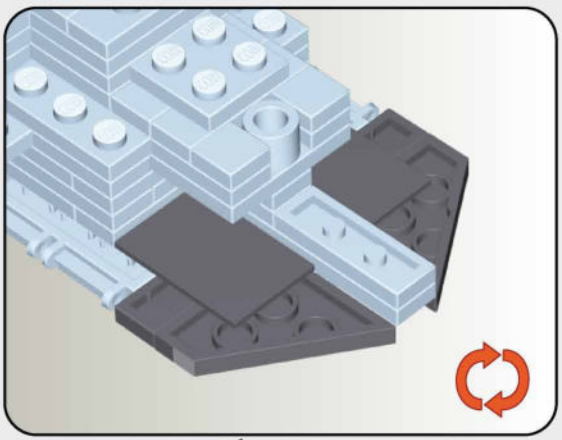
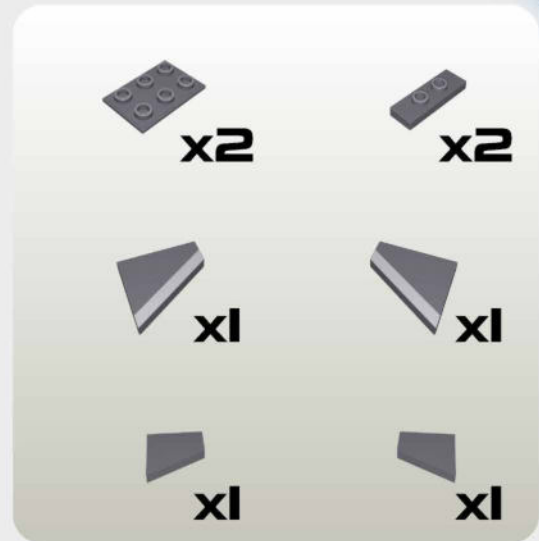
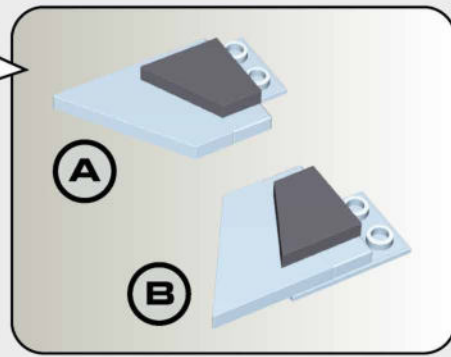
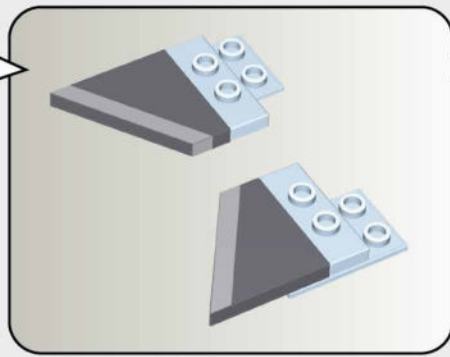
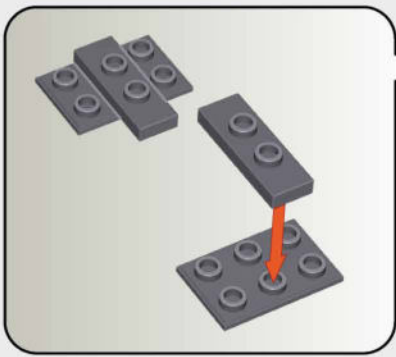

103



x2



x2

104

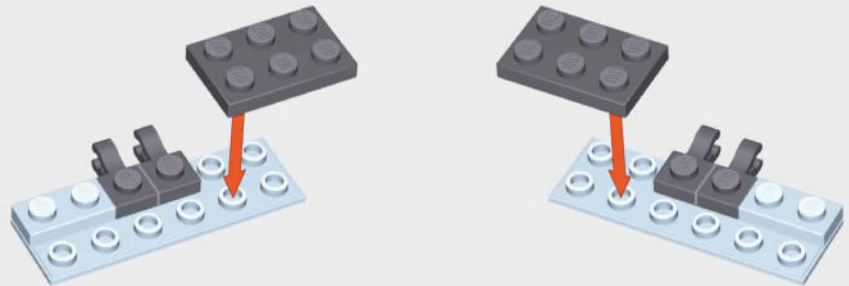

x4



x2

105

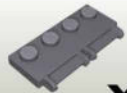

x2



x2

106



x2



x1



x1

107

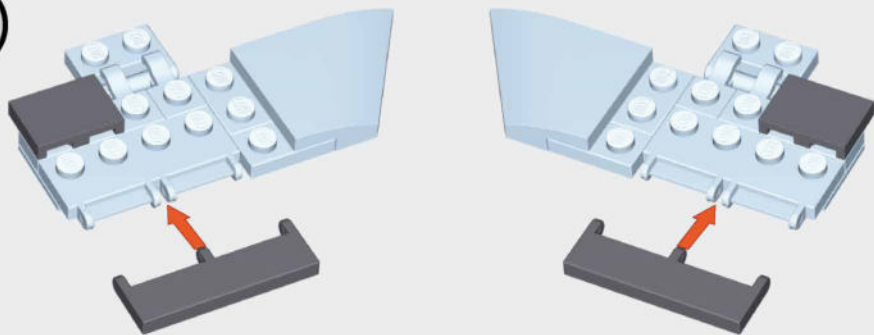

108

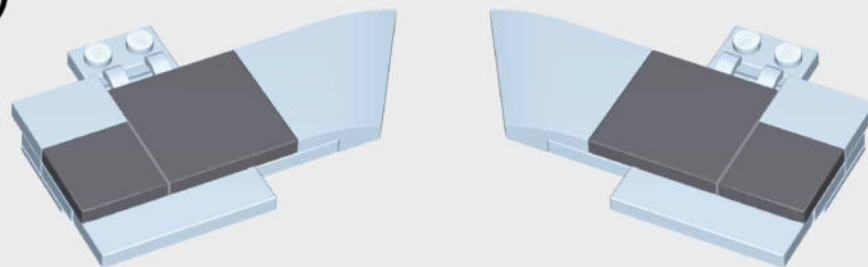

109

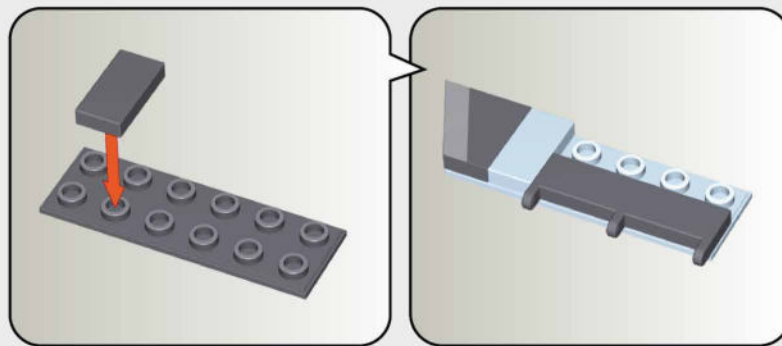
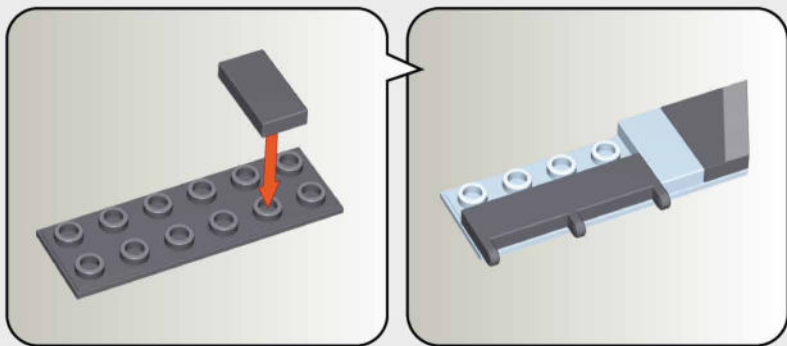
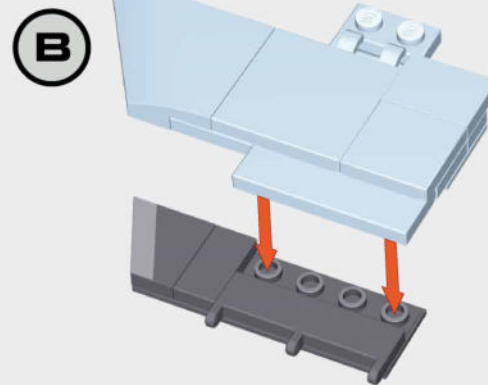
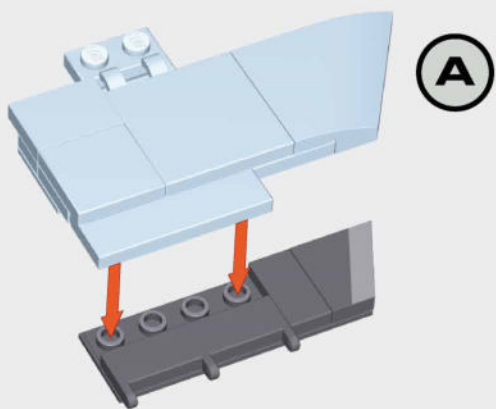

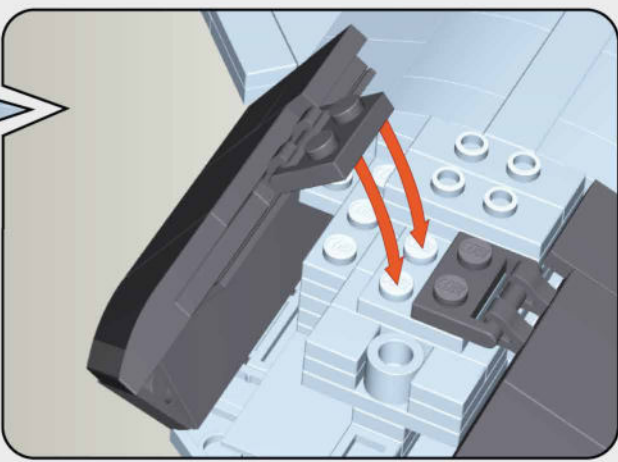
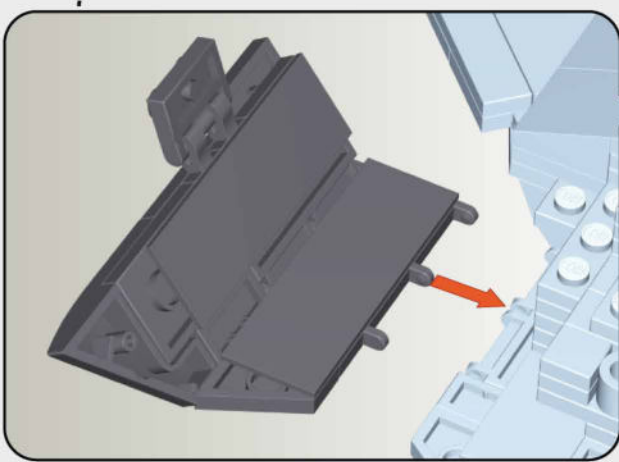
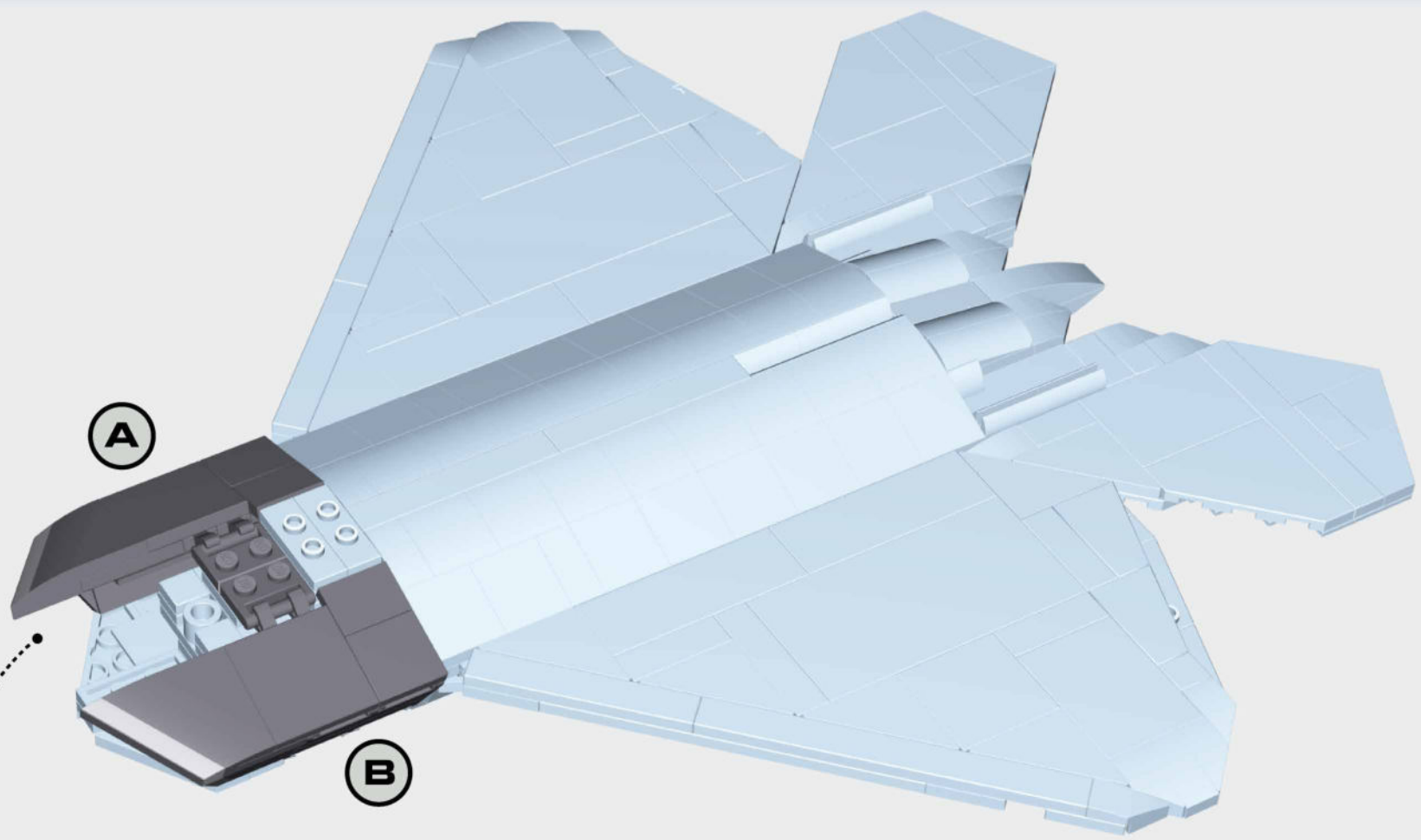

III

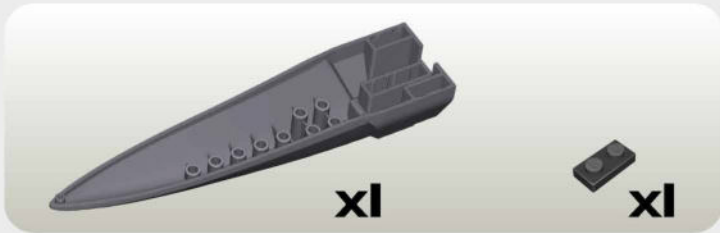
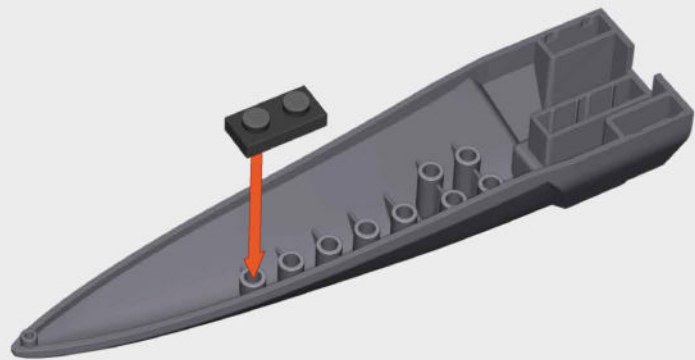

II2



II3

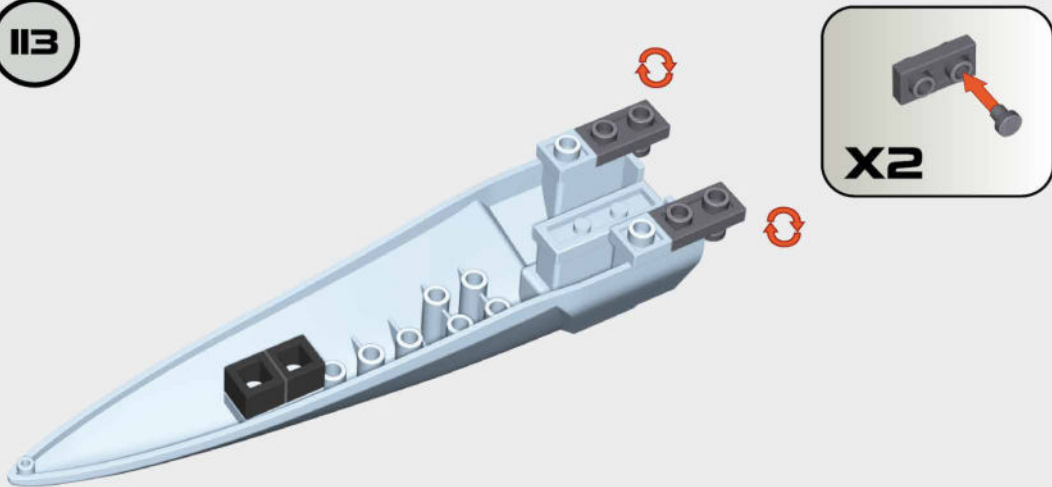

II4



II5



116

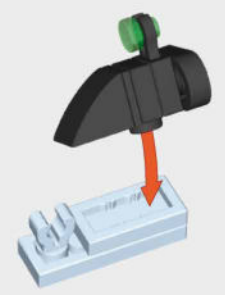
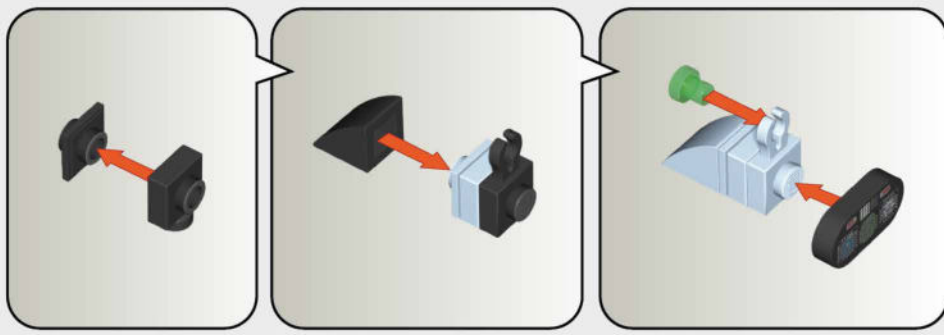

117

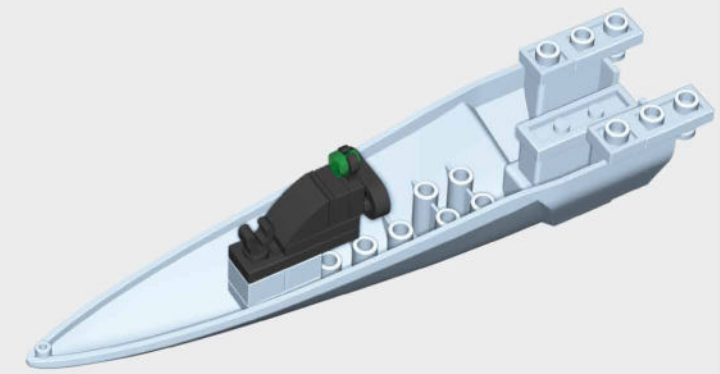

118



119

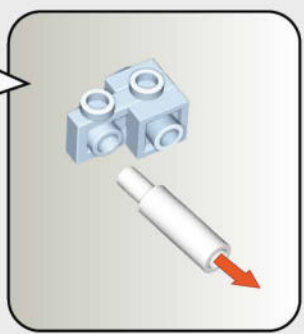
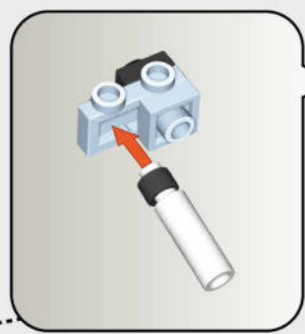
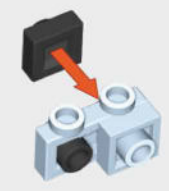

120



121

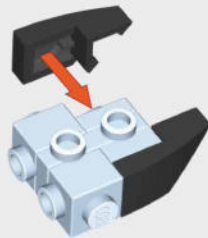

122

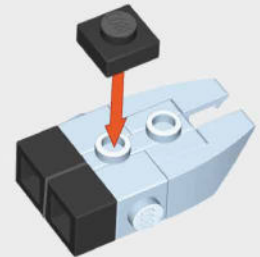

123

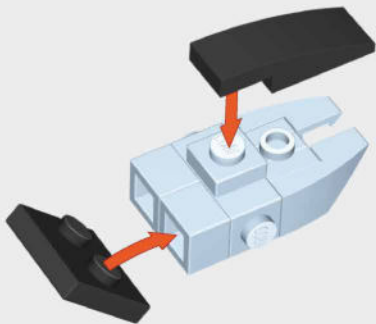

124

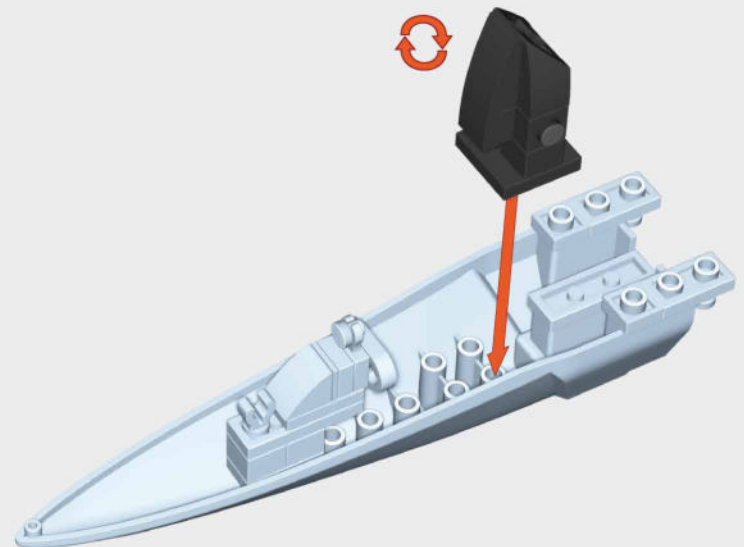



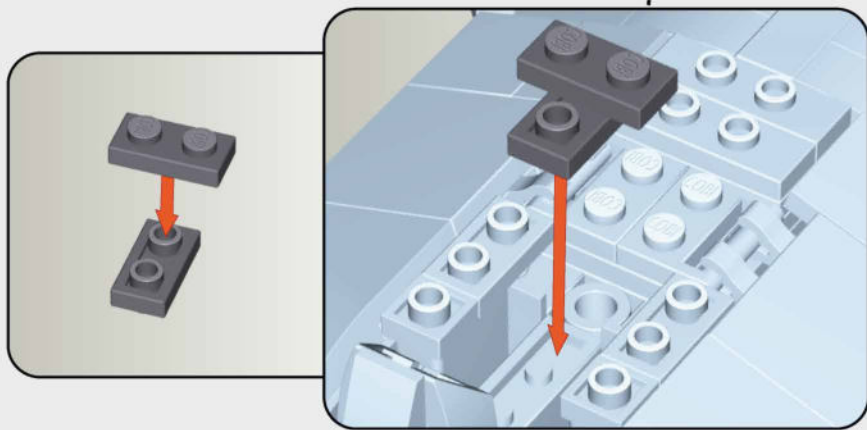
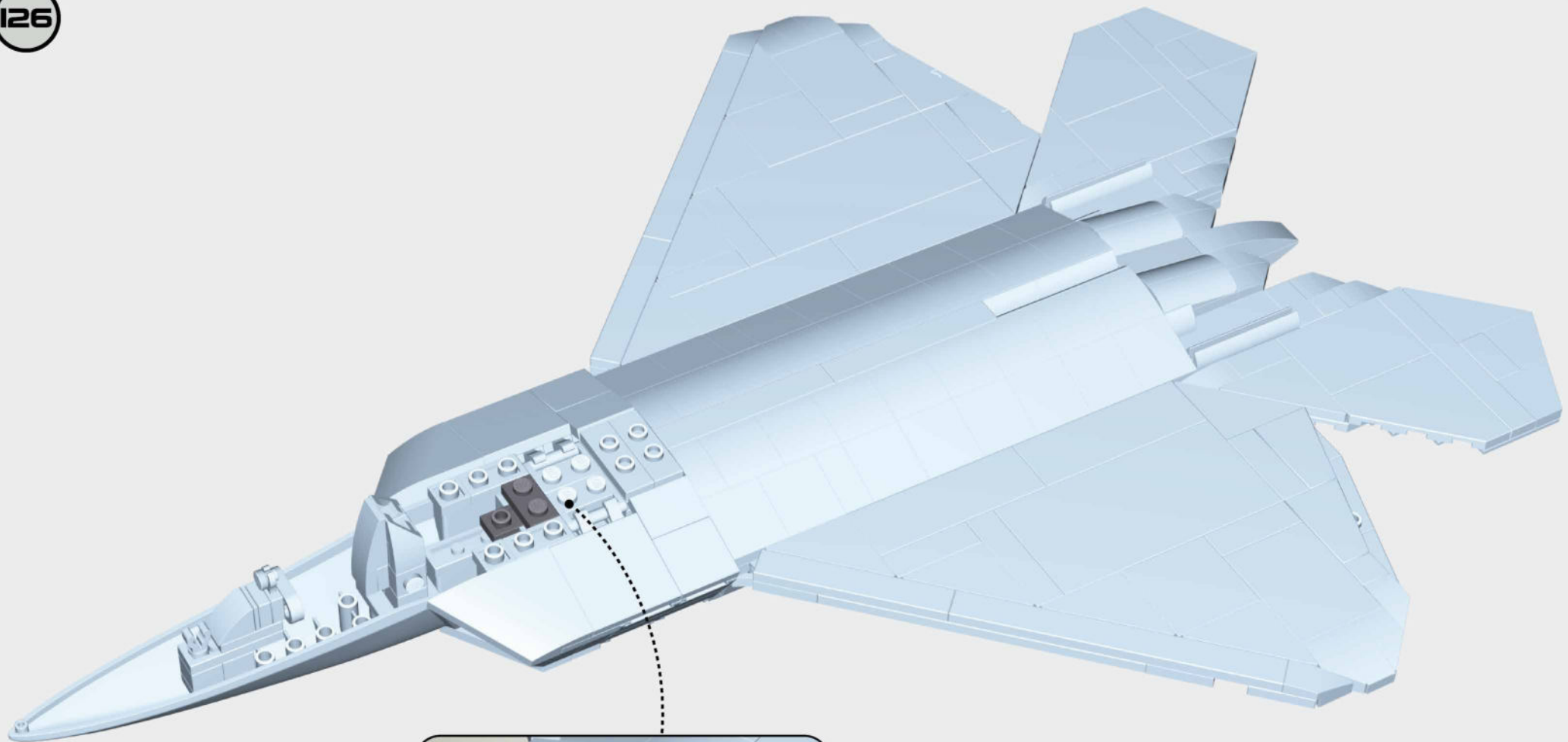

127

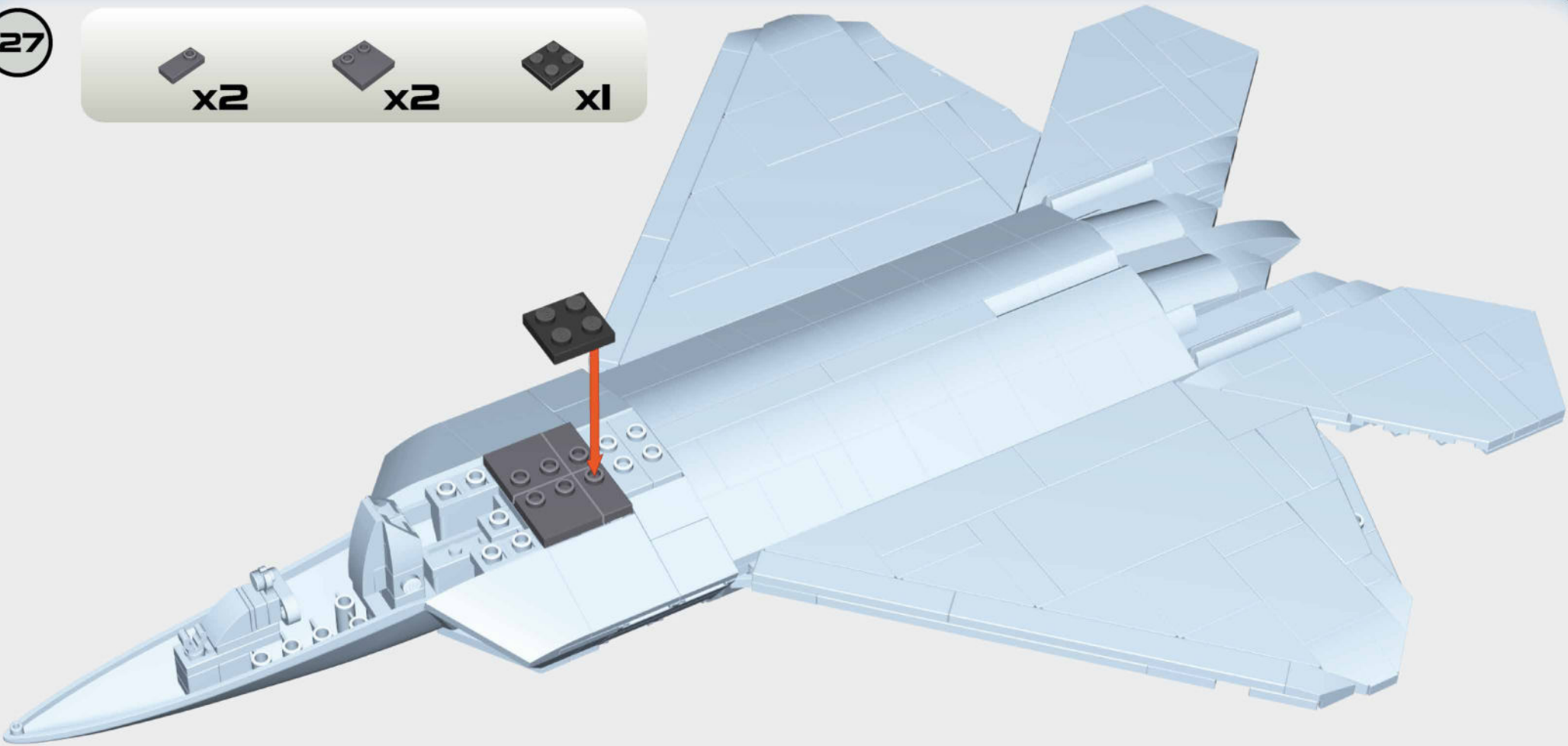

128

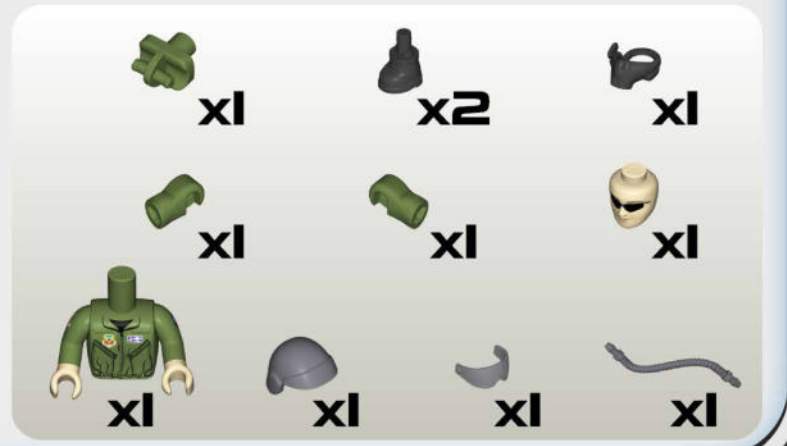
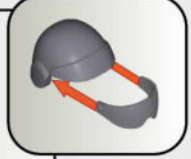
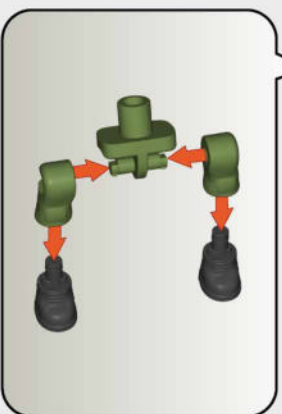

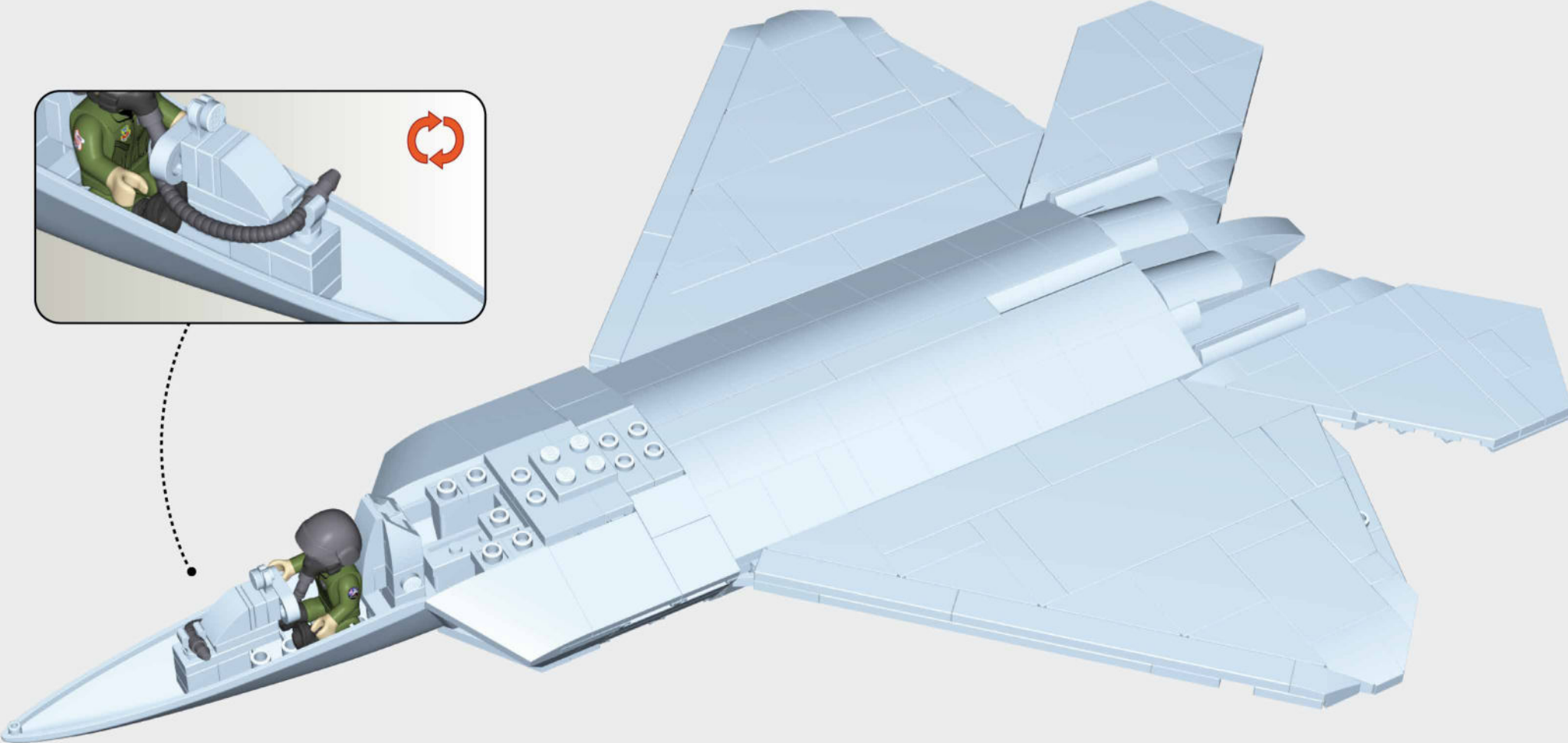
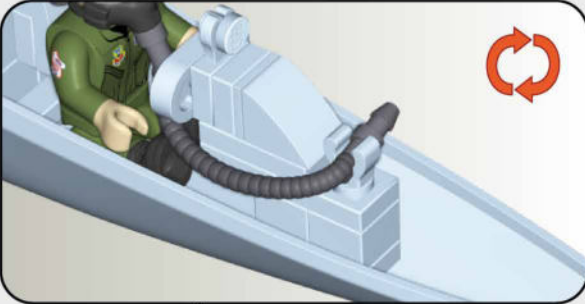

130

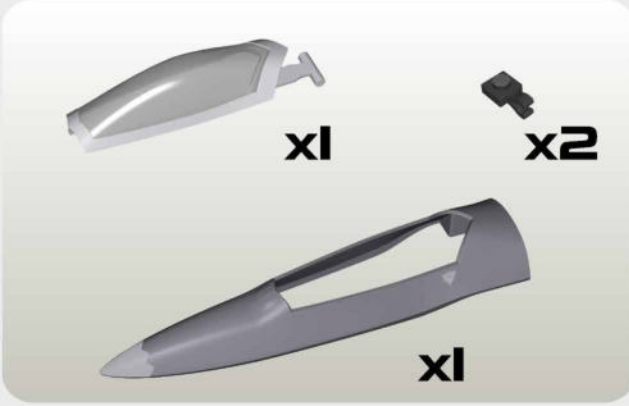
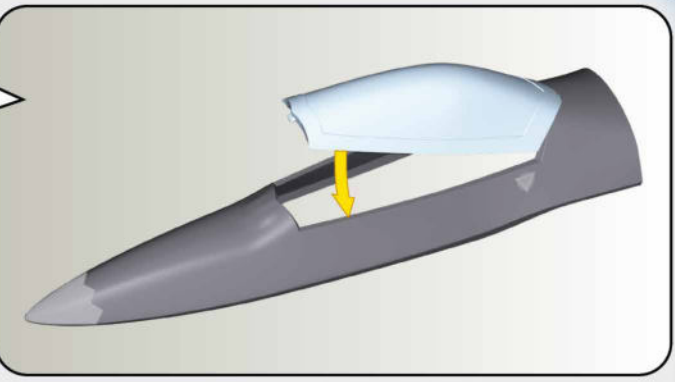
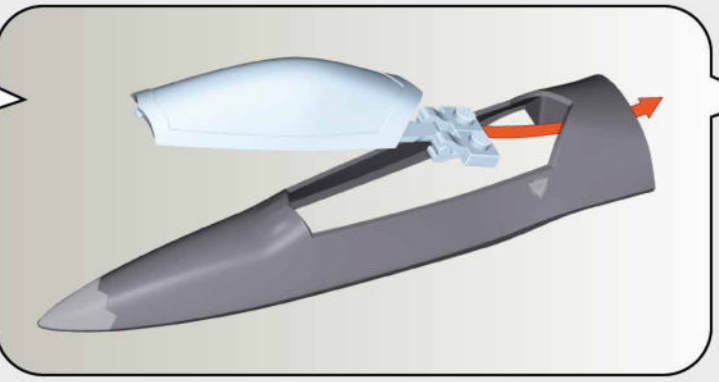
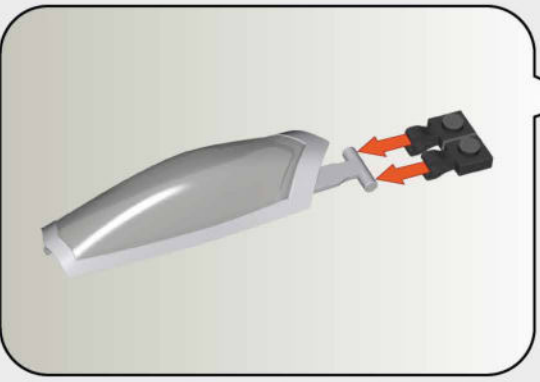

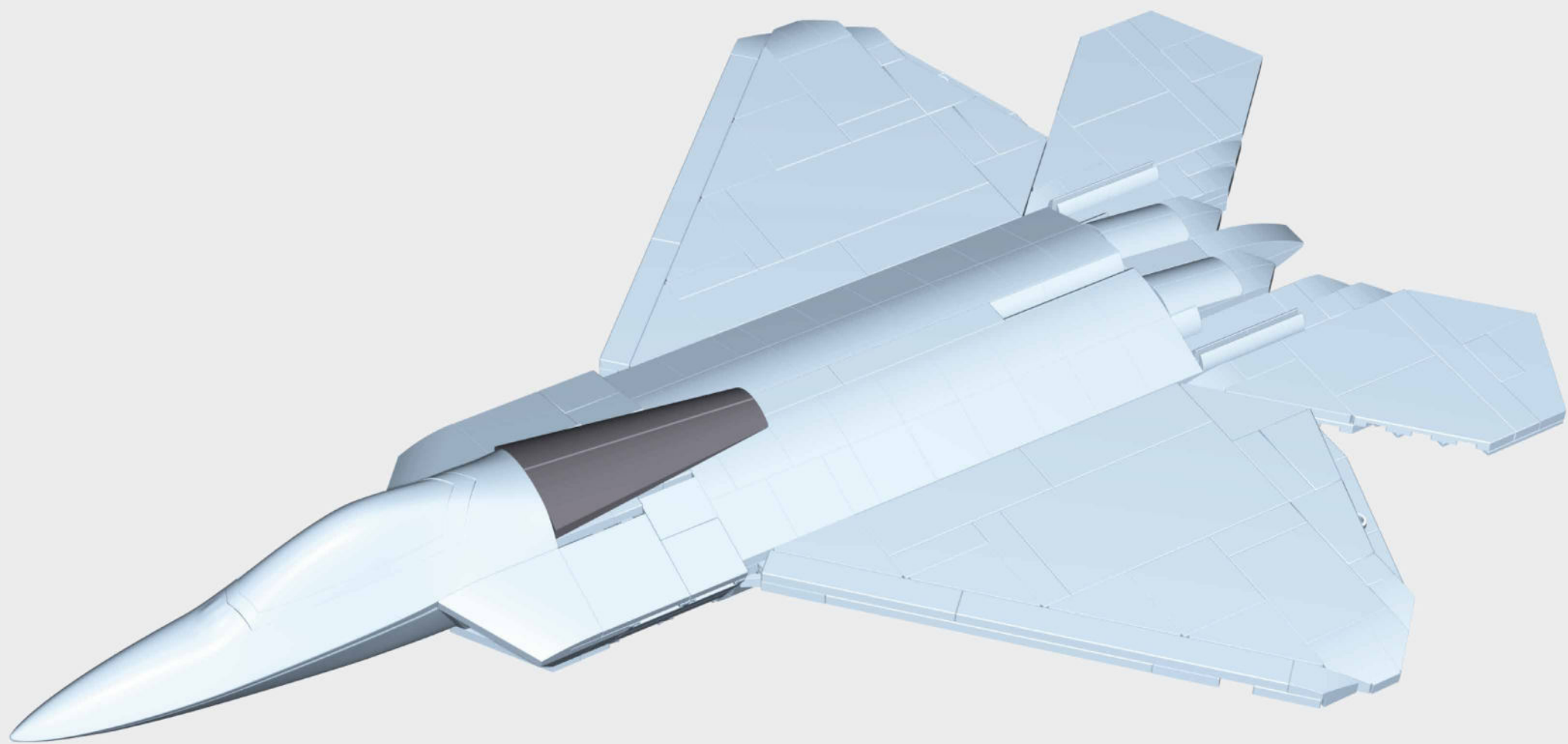

x1

x1

132

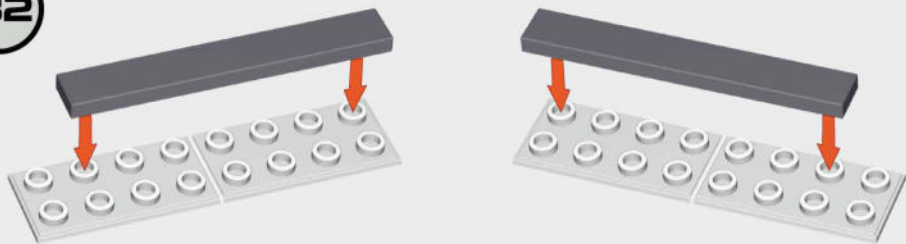

1:1



x4



x2

133



x2



x2

134



x4



x2

135

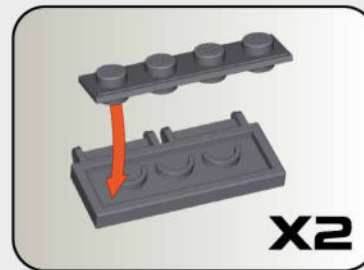

x2

A

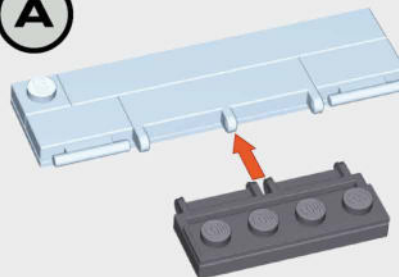

B

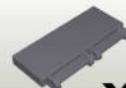
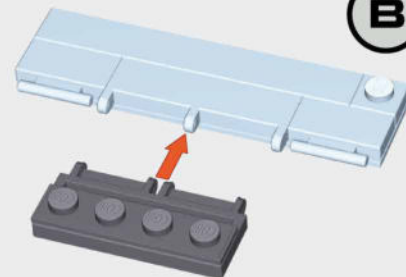

x2



x2

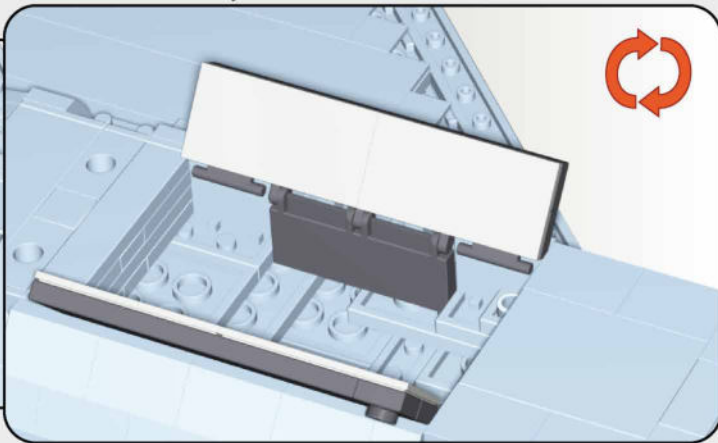
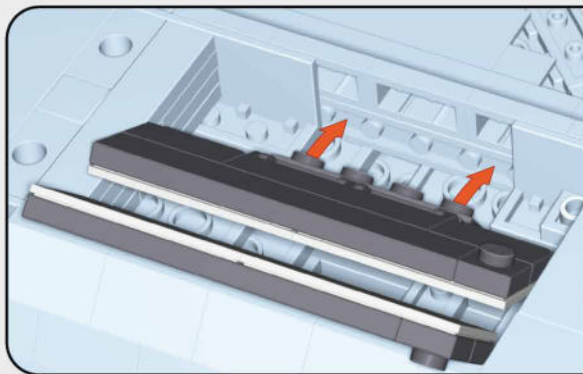
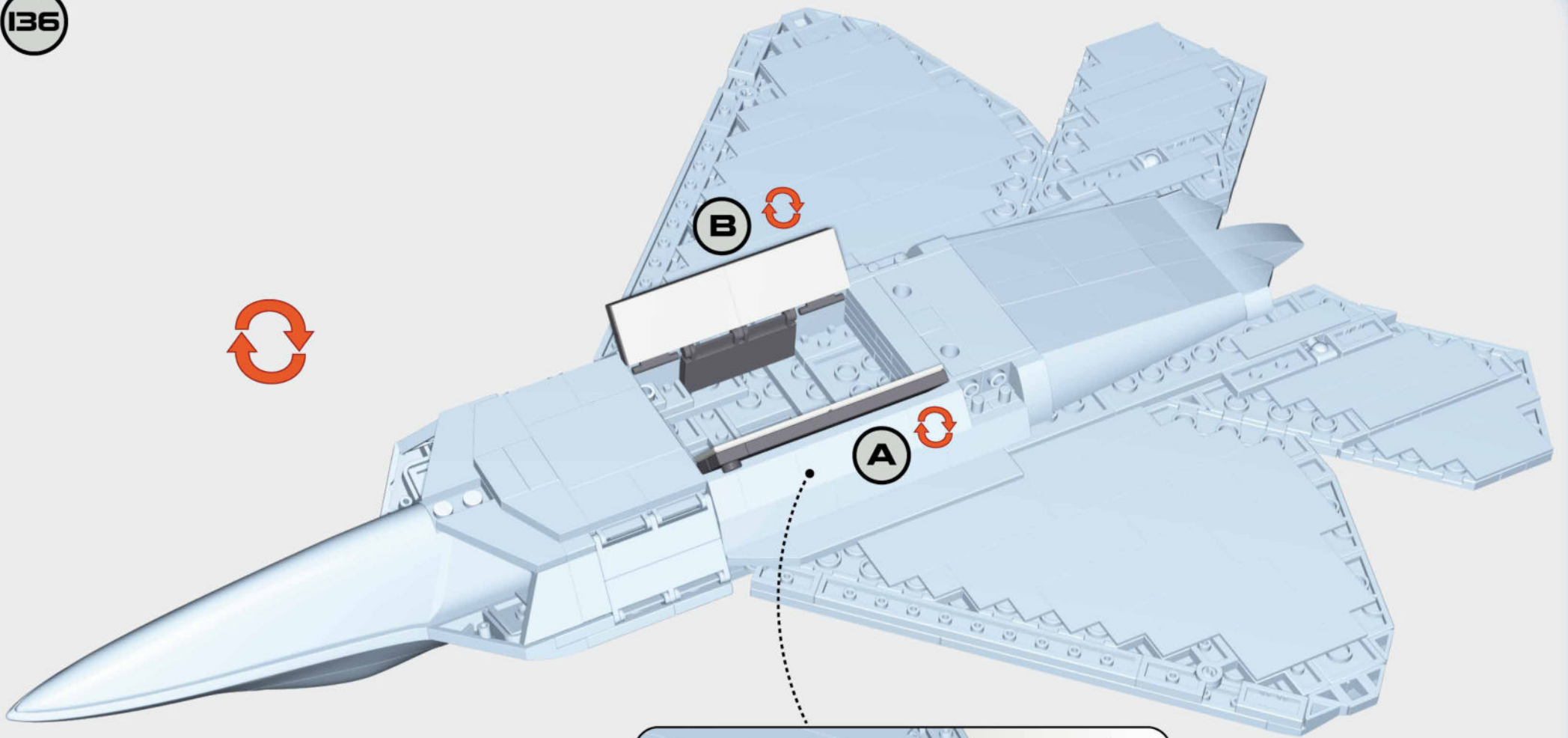

137



x1



x1



x2

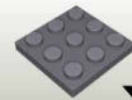

x1



x2

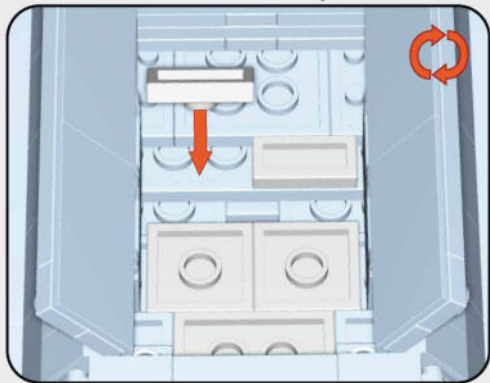
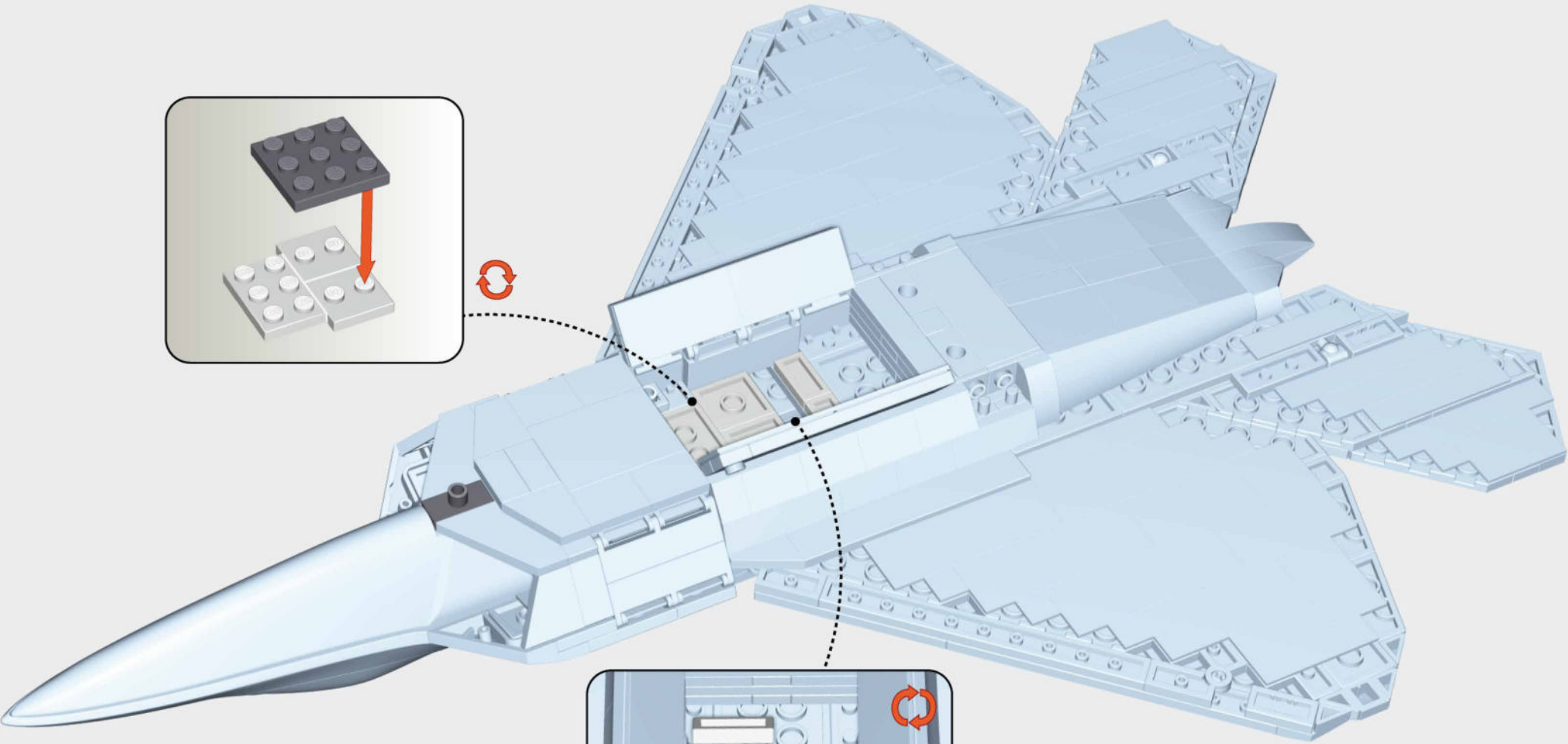
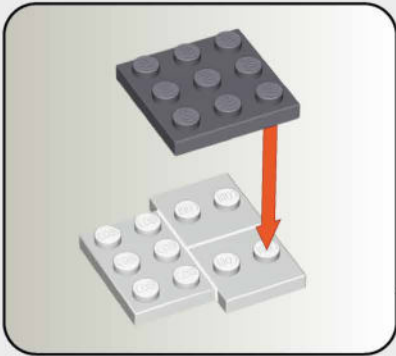

138

-  x2
-  x4
-  x4

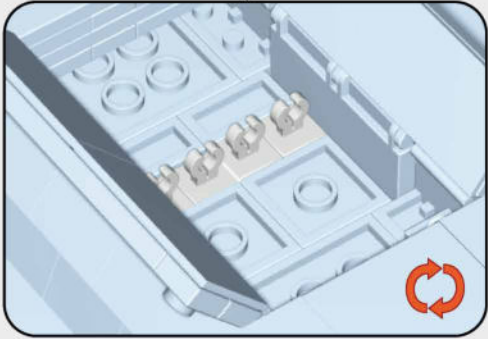
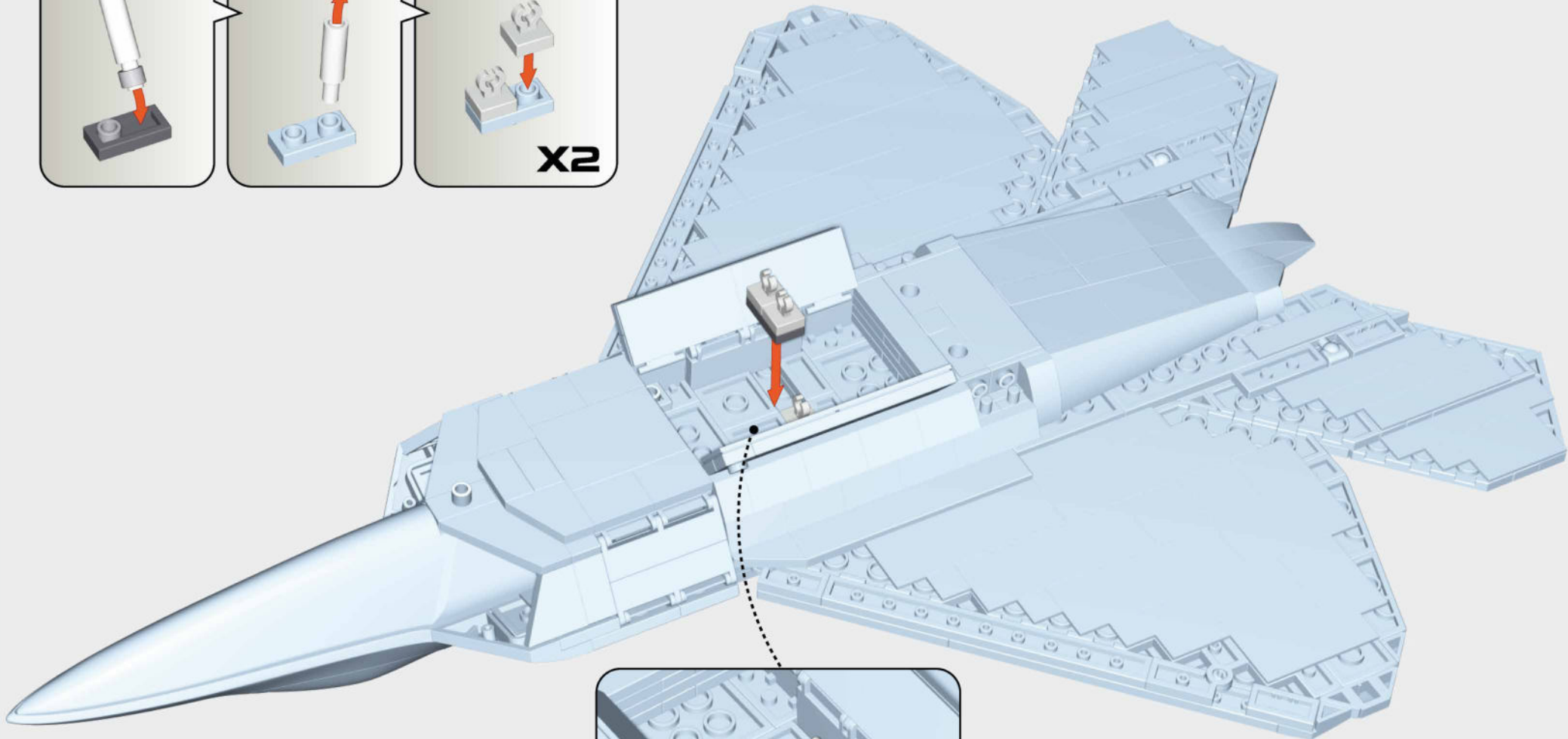
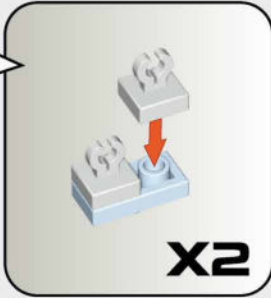
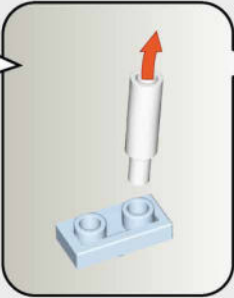

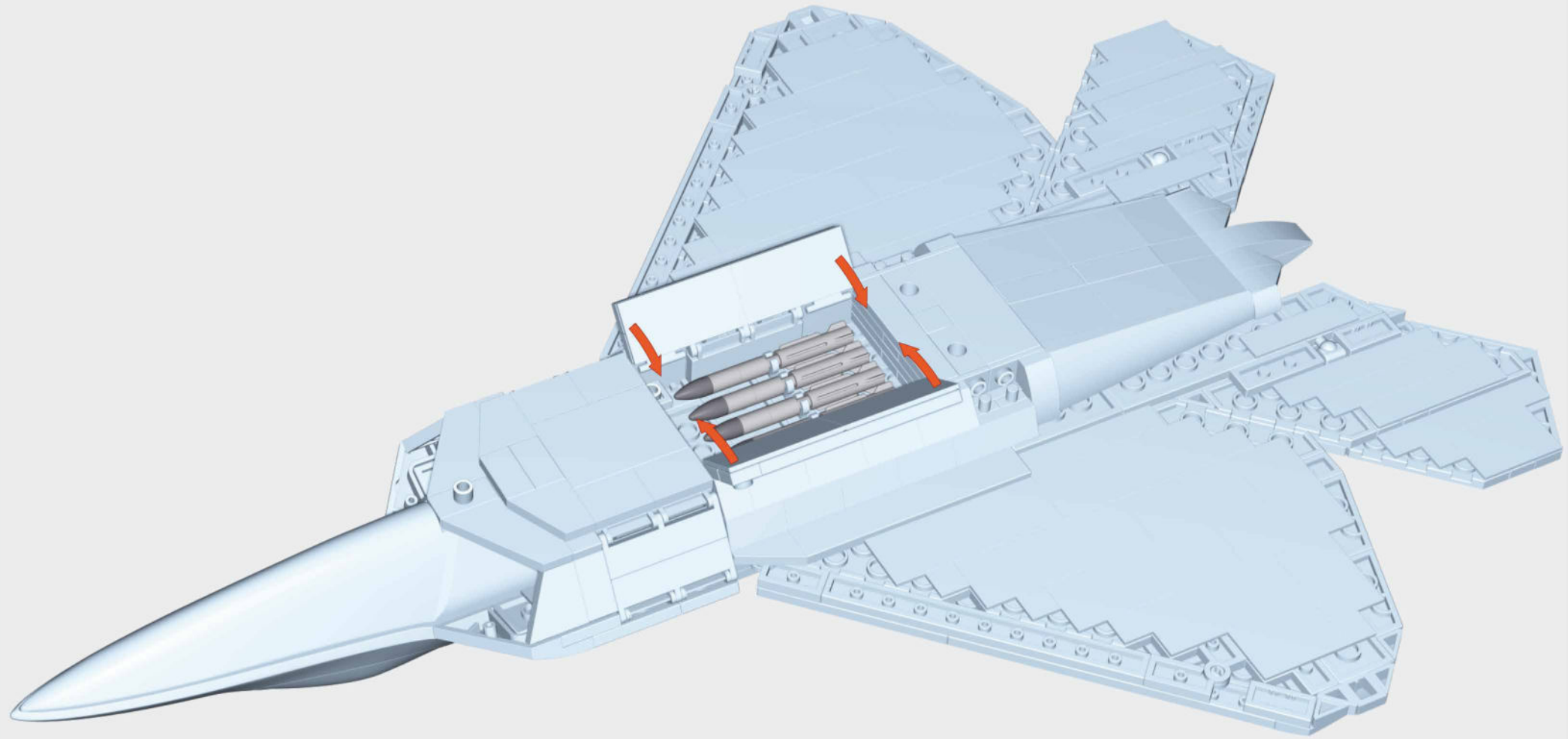
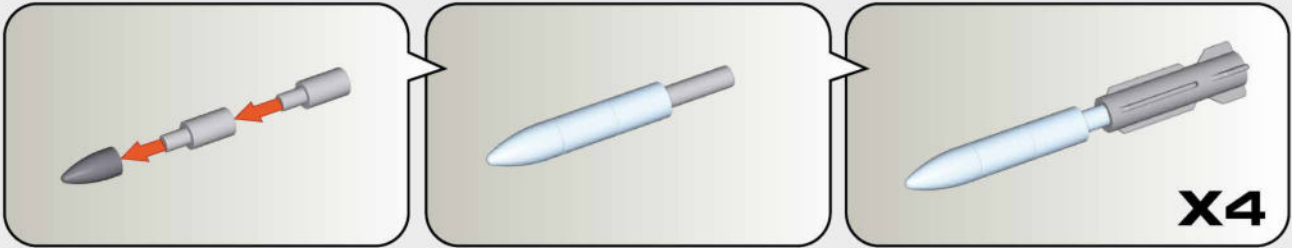

A

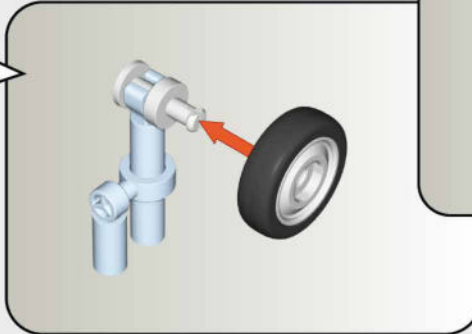
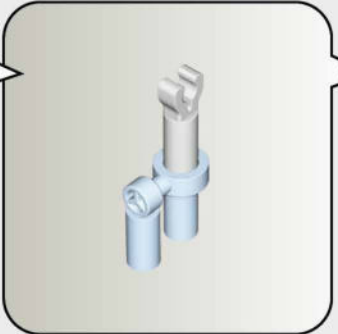
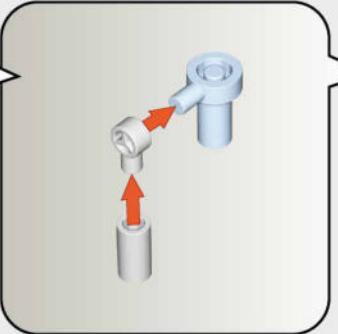
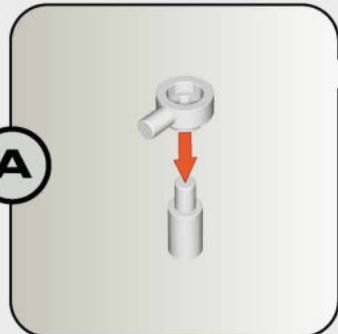

B

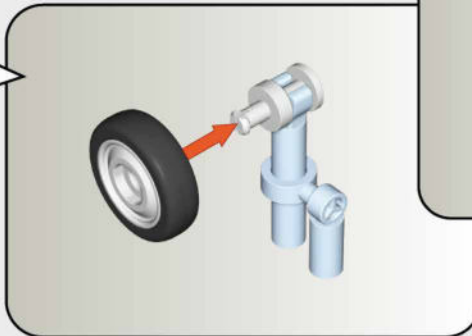
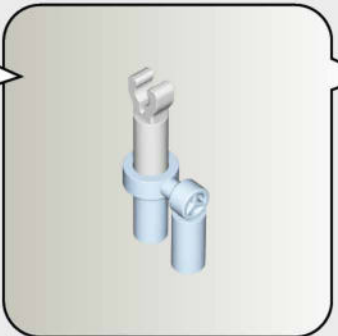
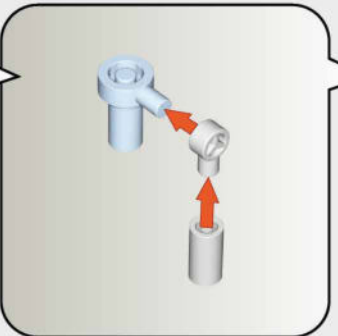
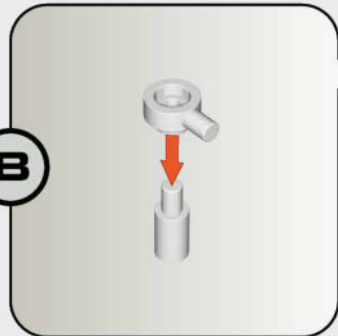

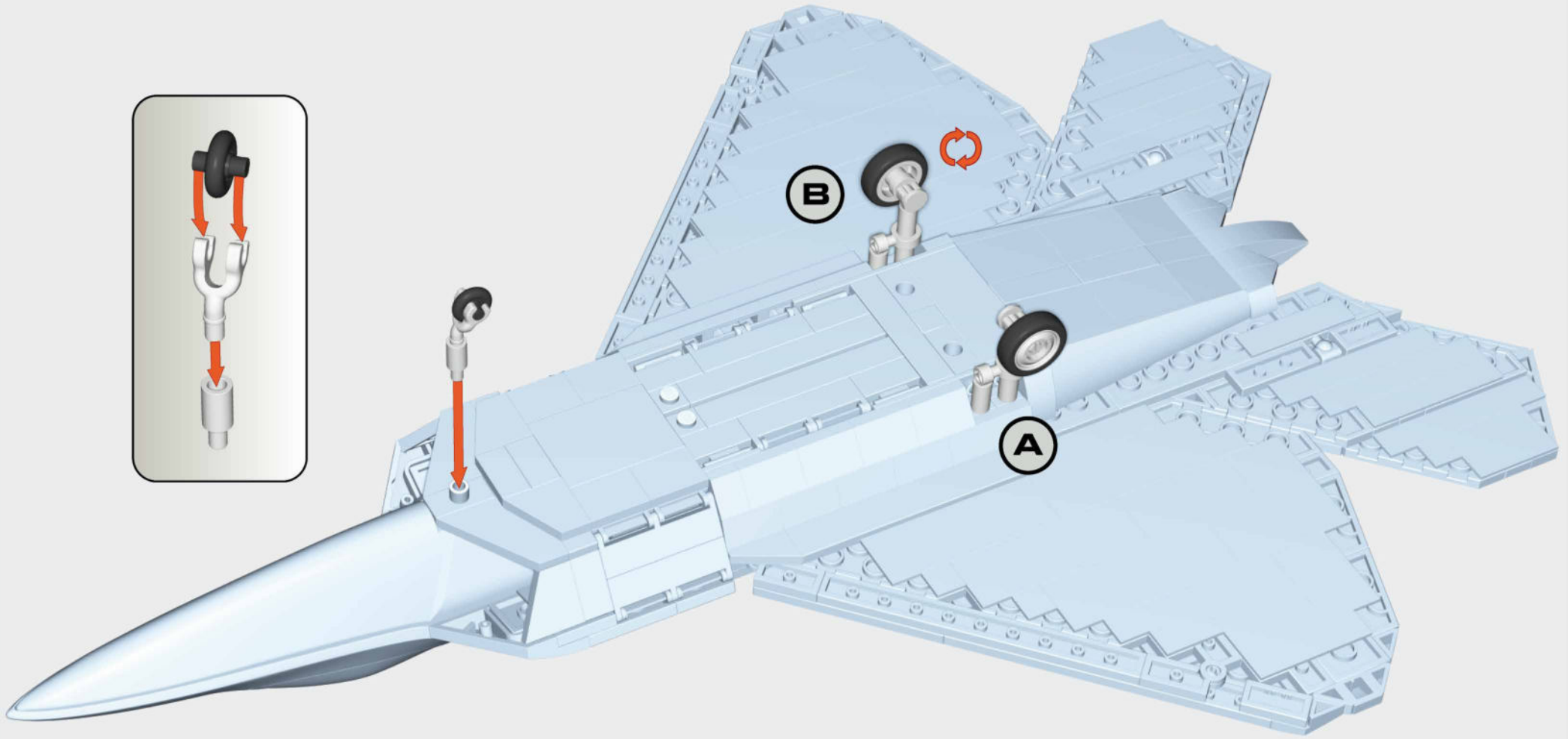
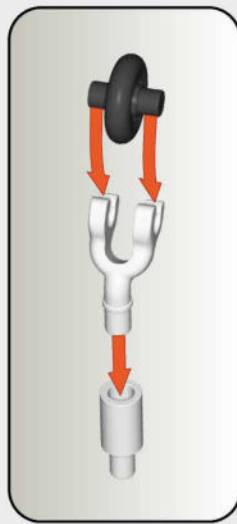

-  **x1**
-  **x1**
-  **x1**

142

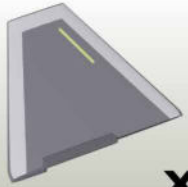

x1

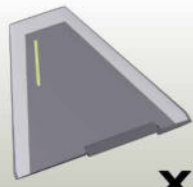

x1

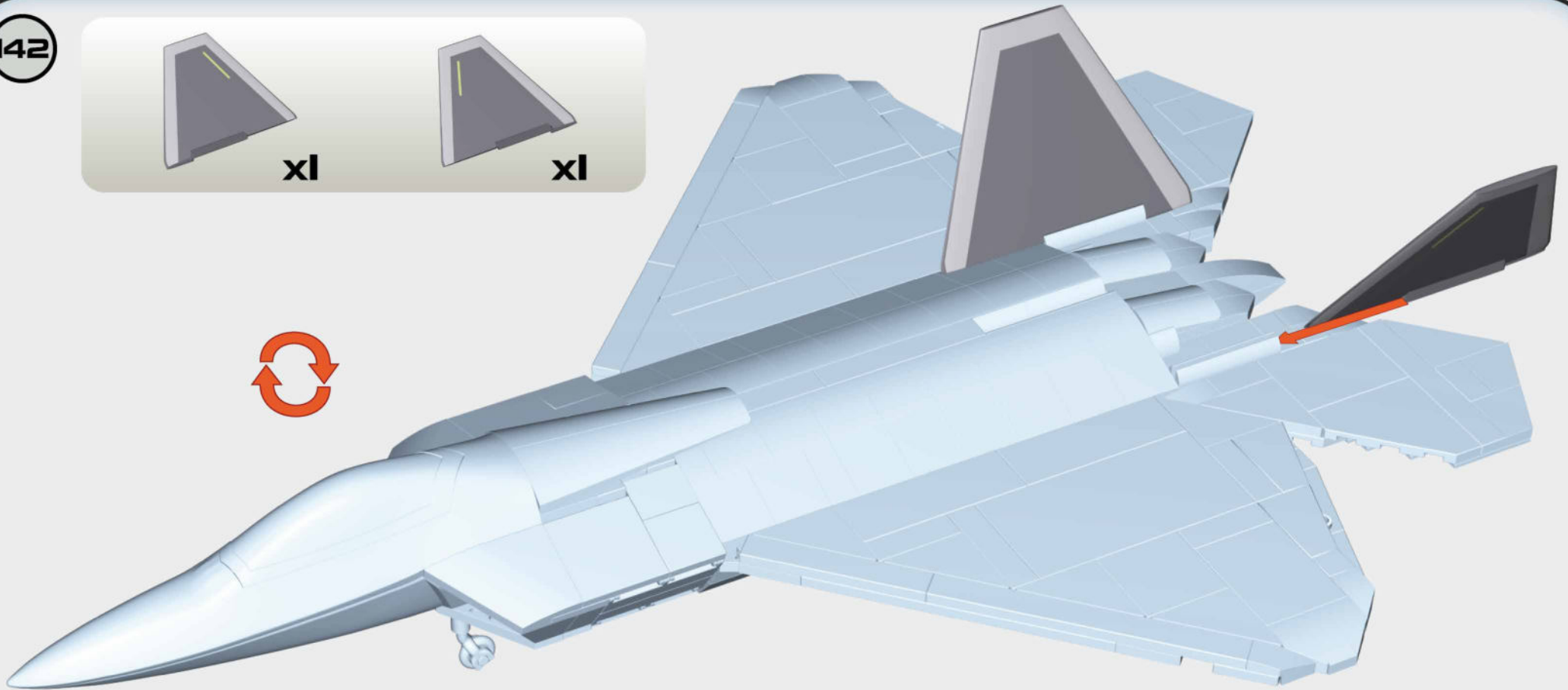

143

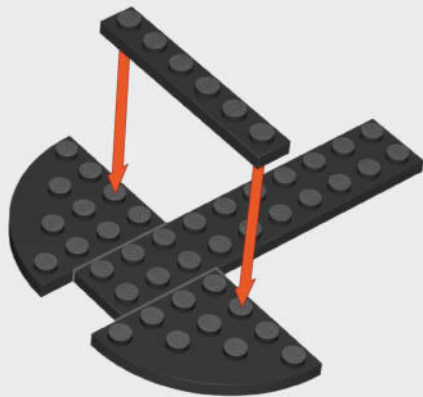

x2



x1



x1

144

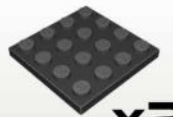
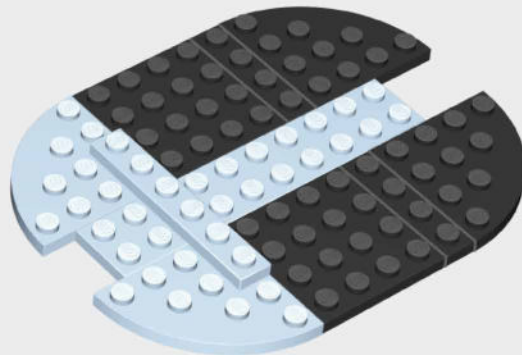

x2



x2



x2

150

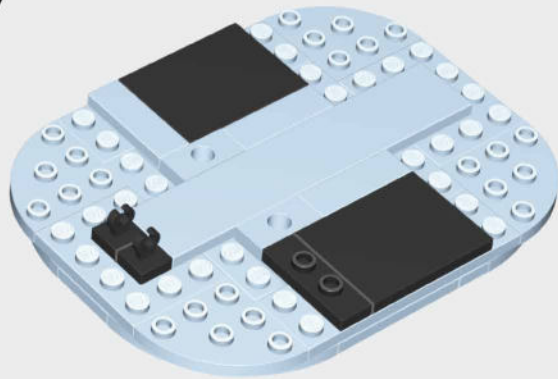

x2

x2

x1

151

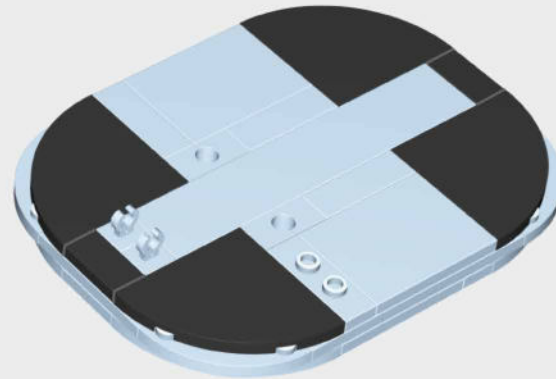

x4

x2

152

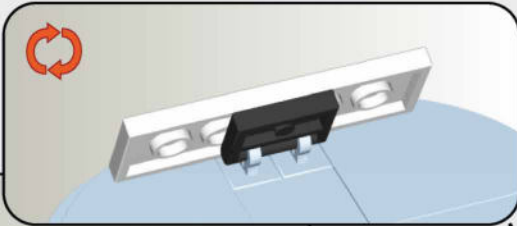

x1

x1

153

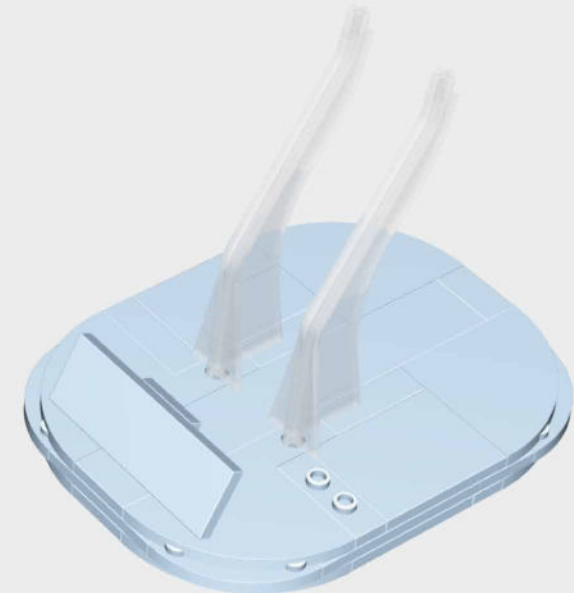

x2

154

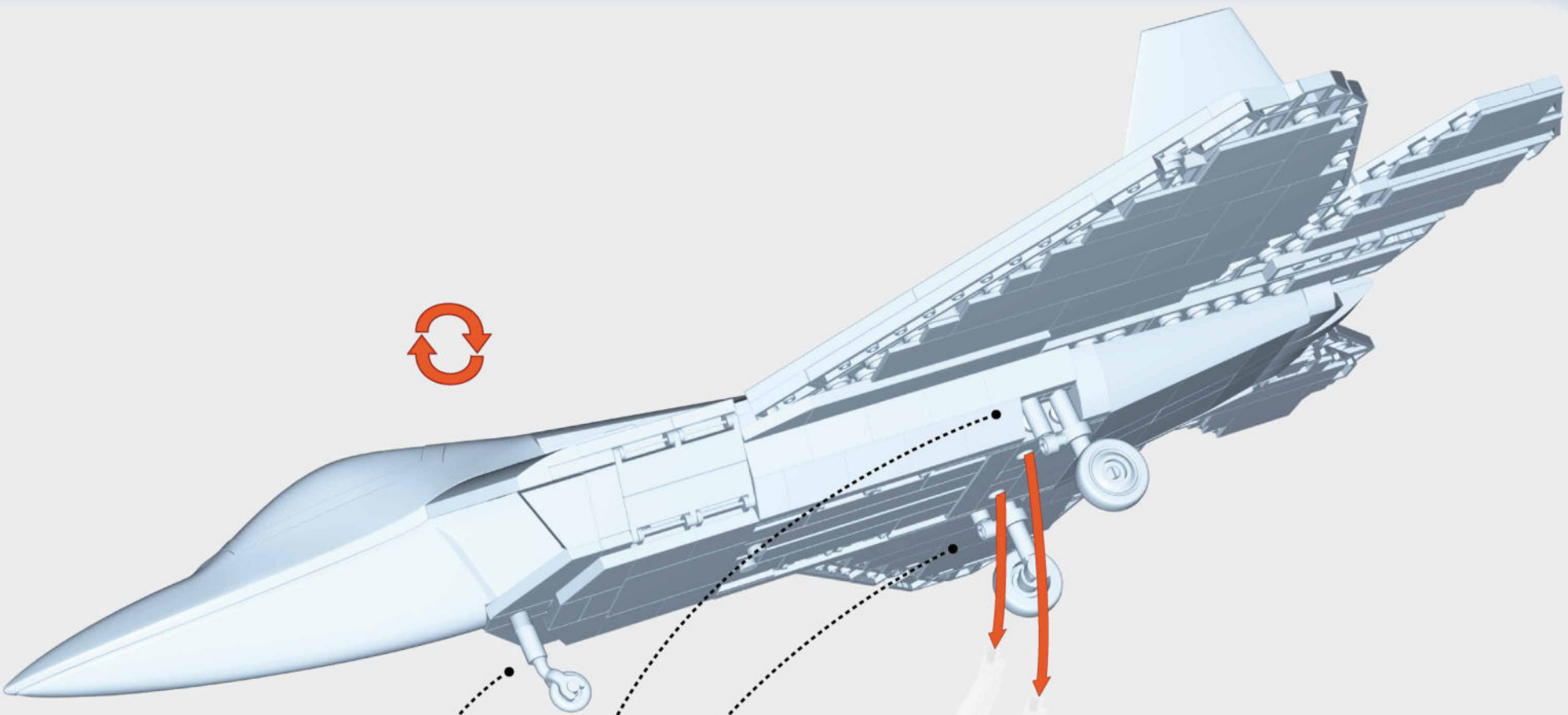

155 □ 156

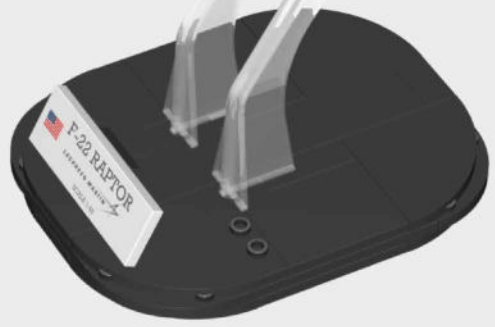

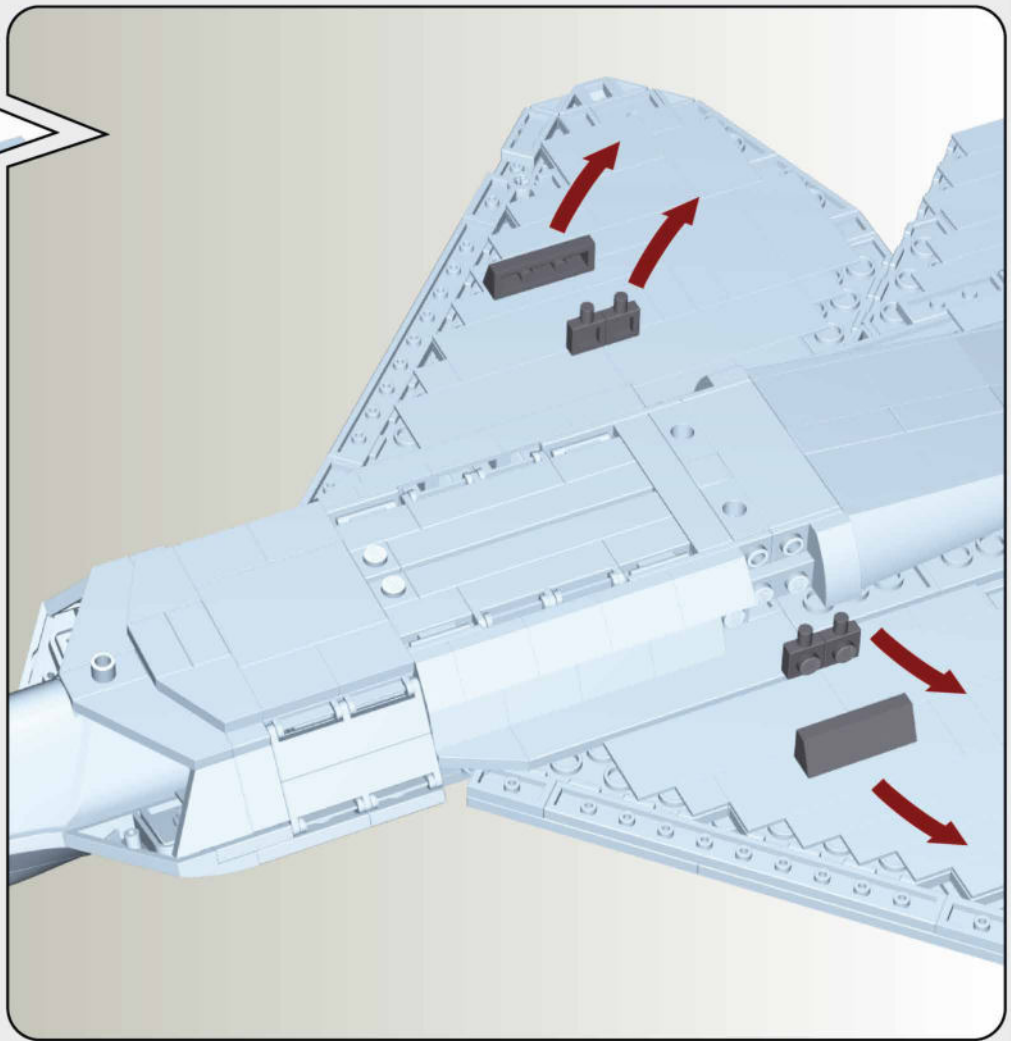
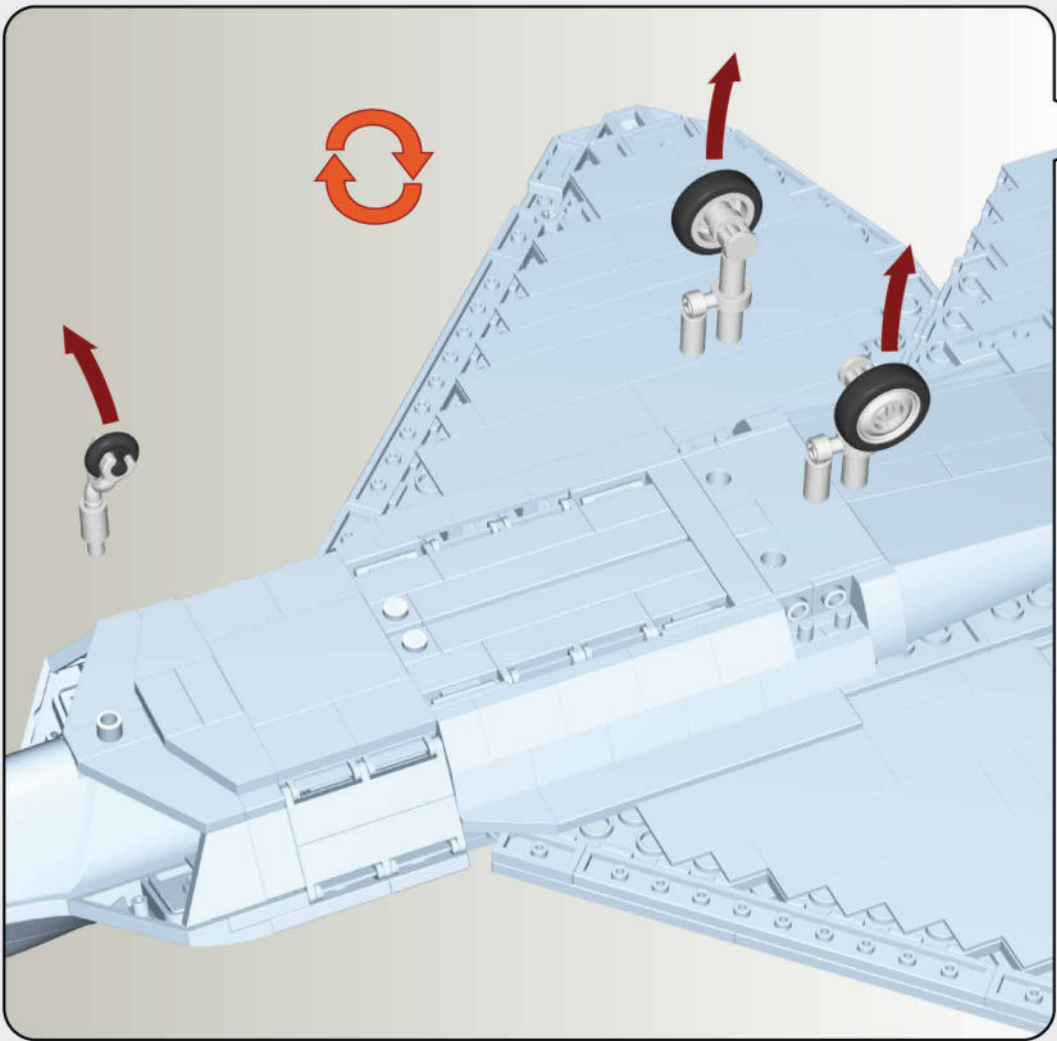

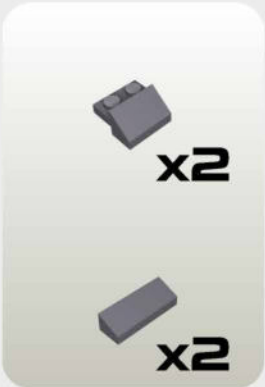
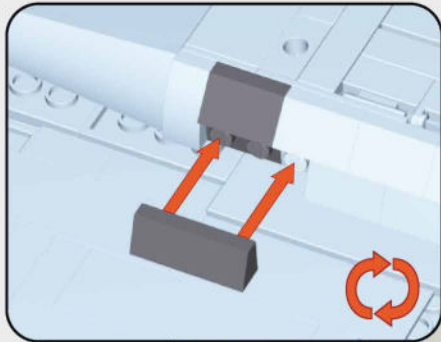
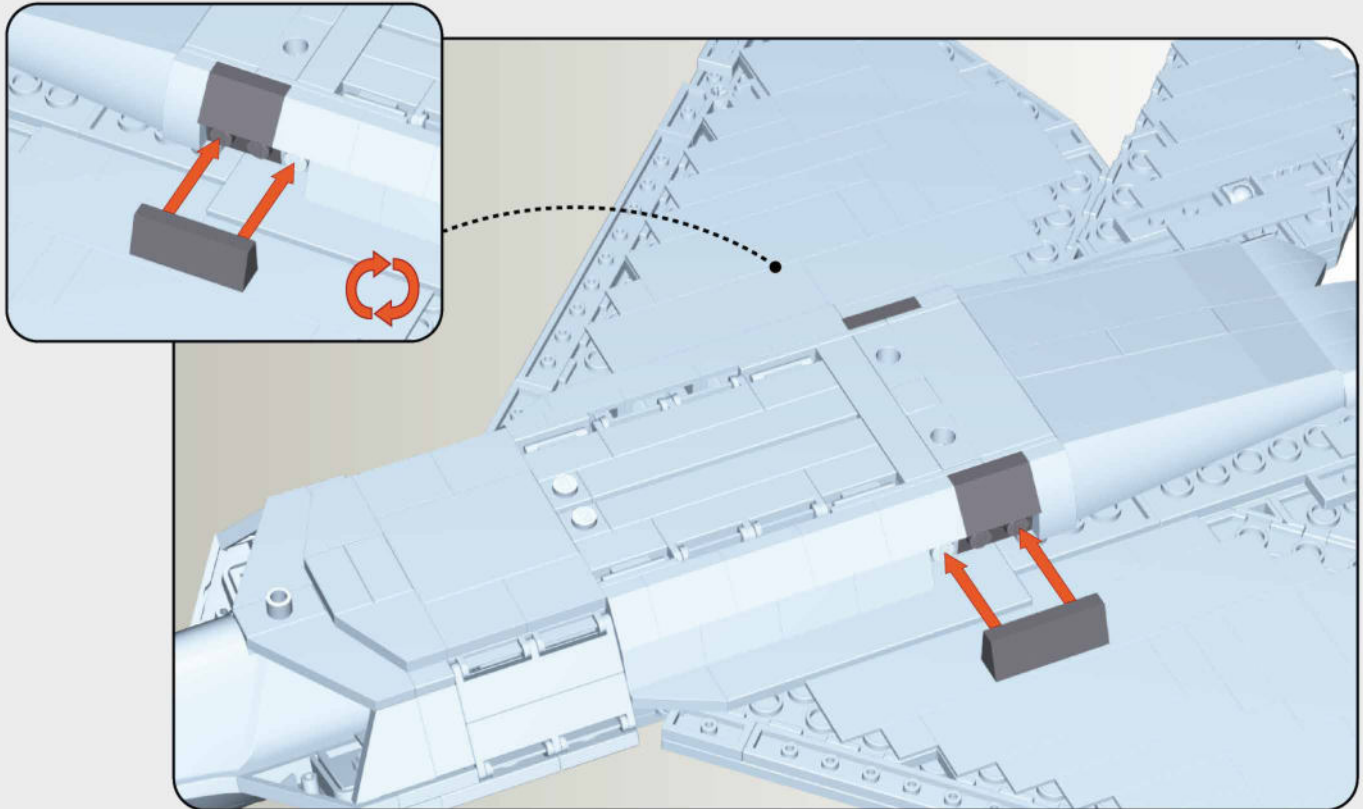

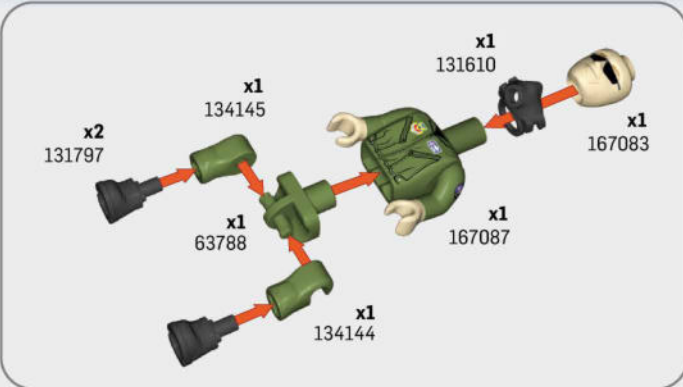

x4 140810	x6 155729	x2 111104	x2 110407	x2 124622	x2 133318	x6 43969	x7 54631	x2 141747	x2 88328	x2 101911	x4 106151
x1 42873	x2 81126	x4 77422	x2 164824	x7 52994	x1 150125	x2 147701	x2 44969	x4 94448	x4 90514	x2 111183	x1 155388
x2 101559	x8 132727	x1 139897	x4 42929	x12 51554	x2 43671	x2 88108	x2 42911	x8 57219	x4 98301	x2 45158	x10 51590
x2 141879	x1 129451	x1 100716	x2 131771	x2 51591	x2 92881	x2 111106	x2 105814	x4 127064	x2 160704	x2 145306	x2 146737
x2 145308	x1 140739	x4 143481	x3 156654	x1 139594	x1 140742	x4 143482	x3 147698	x1 139593	x2 125262	x2 145309	x8 97277
x10 127407	x1 84308	x2 54632	x6 109698	x3 42957	x8 57130	x3 98888	x6 94600	x1 115501	x6 116337	x4 98979	x2 120189
x2 120190	x1 107609	x2 106159	x8 108984	x2 42974	x6 51558	x1 42983	x4 63852	x2 104843	x2 64409	x6 128274	x2 106153
x6 129130	x2 147693	x1 64212	x7 67314	x1 90219	x1 89055	x1 43015	x1 51561	x1 85120	x2 83573	x10 132837	x2 112873

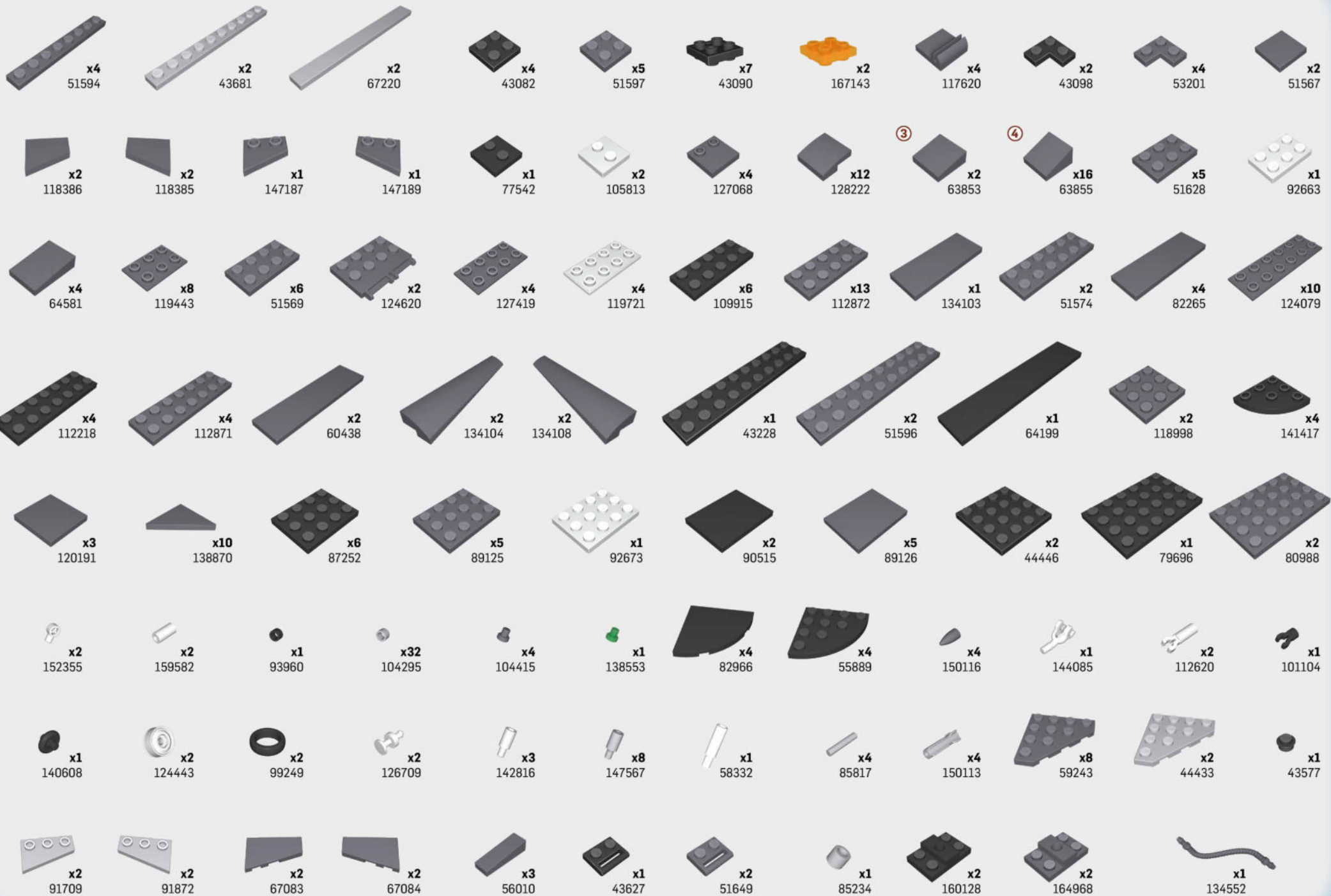

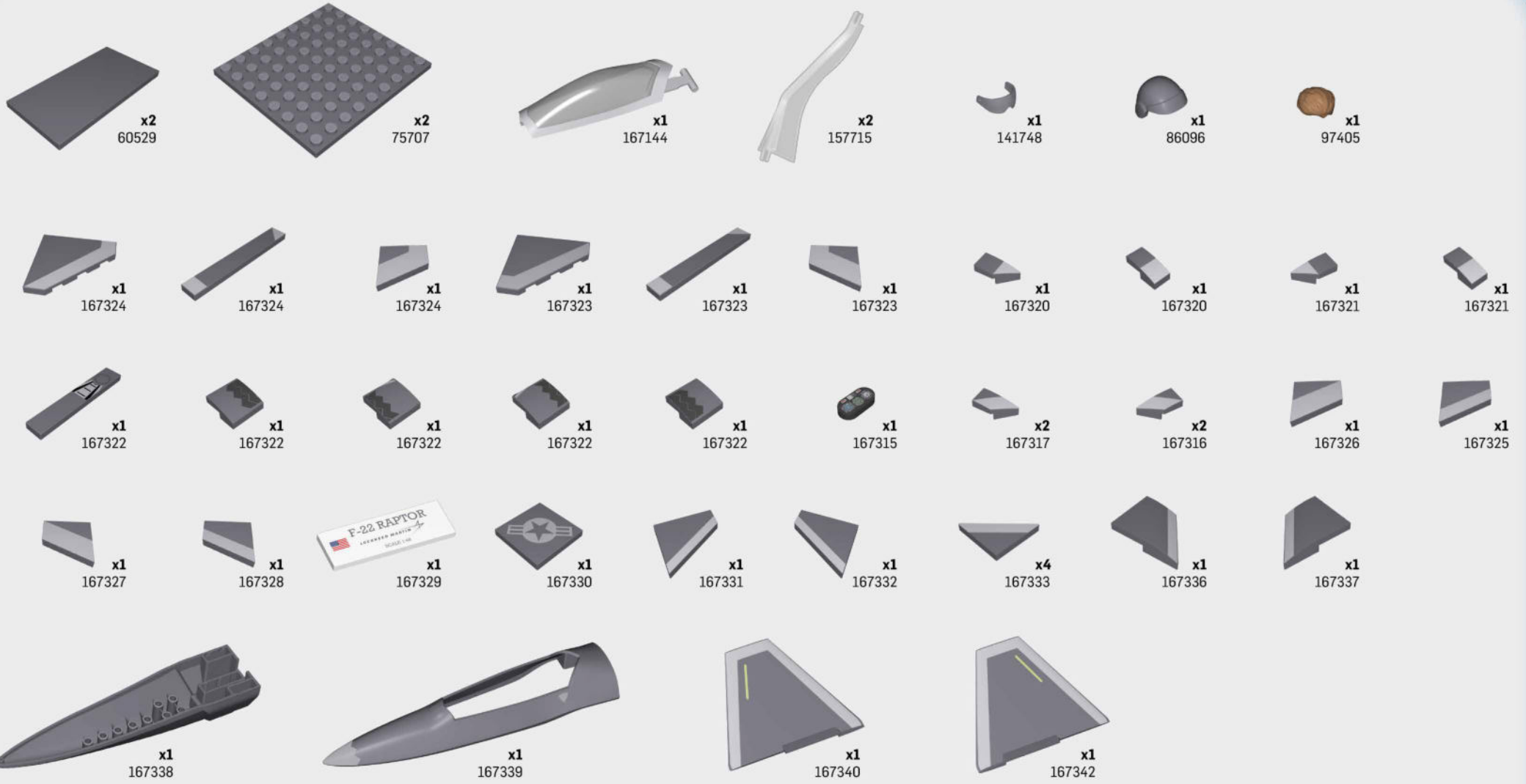

Customer Service
 Kundenservice
 Obštuga Klienta
www.cobi.eu/service



A-10 THUNDERBOLT II™
WARTHOG®

5856



SCALE 1:48

SCALE 1:48



PANAVIA TORNADO GR. 1
"MIG EATER"

5854





SCALE 1:48

LOCKHEED MARTIN 



F-35® B LIGHTNING II®
5829



F-35® B LIGHTNING II®
5830



SCALE 1:48



For
news and
special deals

Find us on:



WWW.COBI BRICKS.COM

17-05855-693

