

HISTORICAL COLLECTION

WORLD WAR II



Sd.Kfz. 251/9 "STUMMEL"

IN SERVICE - 1943 - 1945
PLACE OF ORIGIN - GERMANY
TYPE - ARMoured PERSONNEL CARRIER
COMBAT WEIGHT - 9t (19 800lb)
ARMOUR - 6-14mm (.2-.5")
ARMAMENT - 1x 75mm (2.95") KWK 37 L/24,
2x 7,92cm (.312") MG 34/42
ENGINE - HL 42 TUKRM, 73,6kW (99HP)
ROAD SPEED - 52,5km/h (32,6MPH)
ROAD RANGE - 320km (200mi)
CREW - 3

2283

Printed in EU

PAD PRINTED
NO STICKERS



WARNING: CHOKING HAZARD-

Toy contains small parts.
Not for children under 3 years.



UK
CA



485  1 

Sd.Kfz. 251/9 "STUMMEL"

SCALE 1:35



1

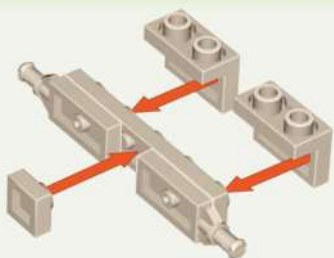

2

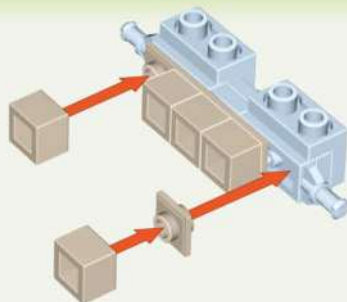

BE CAREFUL: NOTICE THE DIFFERENCE

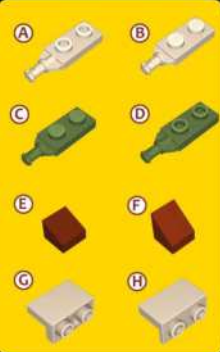

3

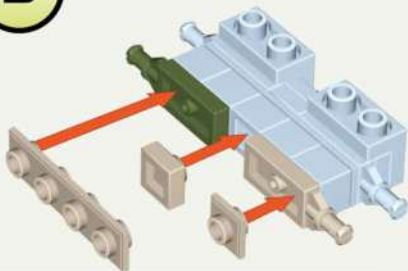

4

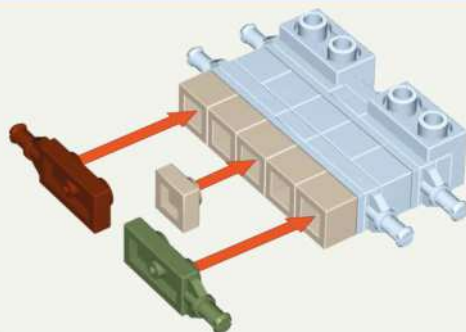

5

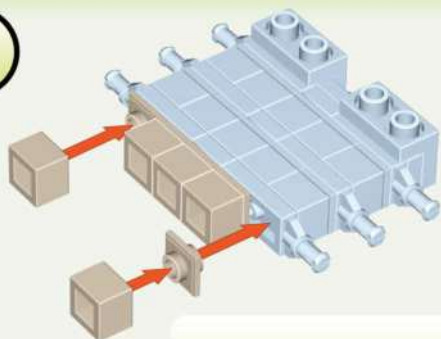

6

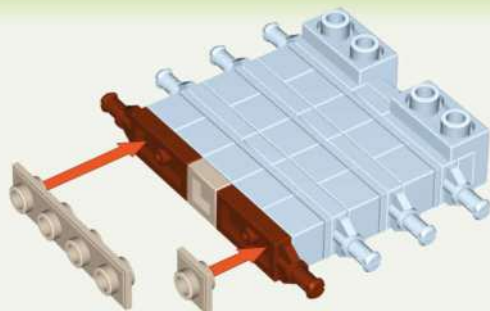

7

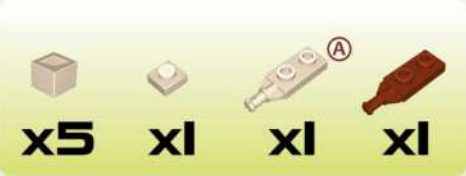
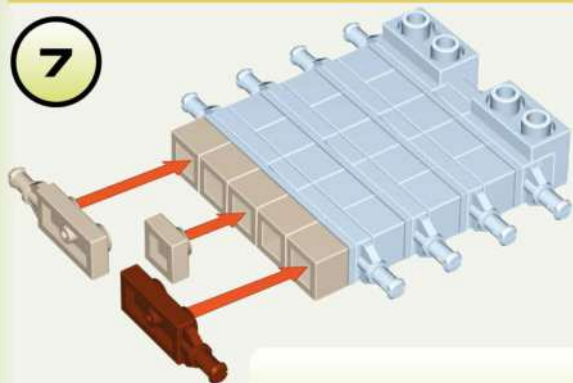

8

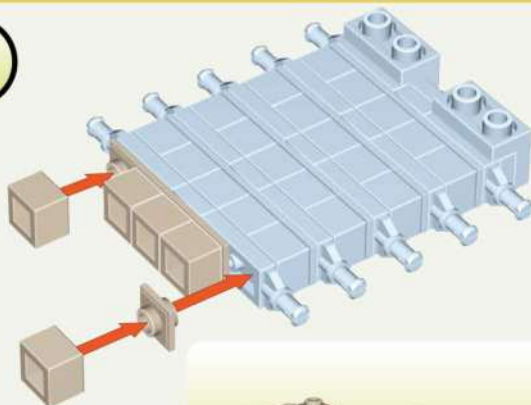

9

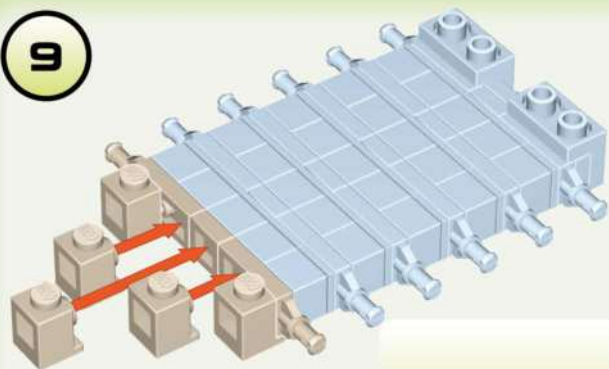

x1



x2



x5

10

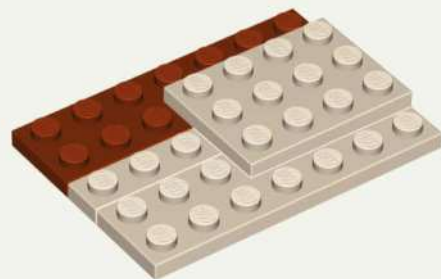

x1



x1



x1



x1

11

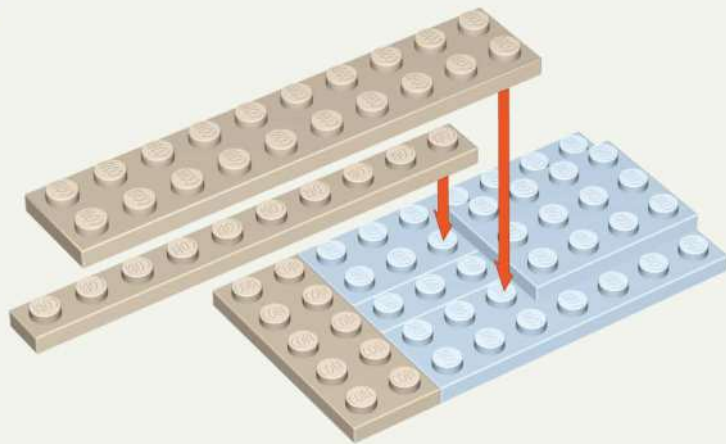

x1



x1



x1

12

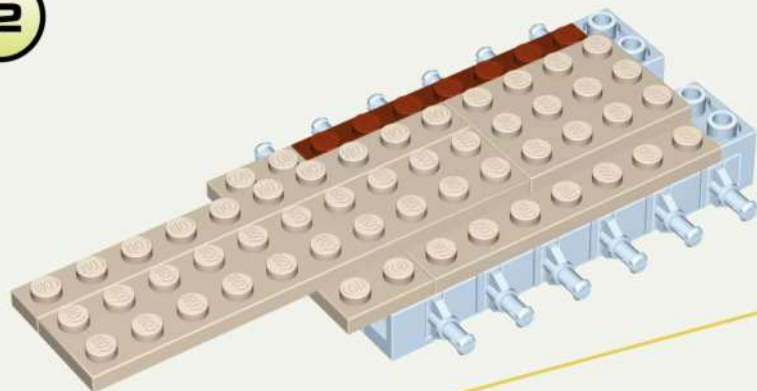

13

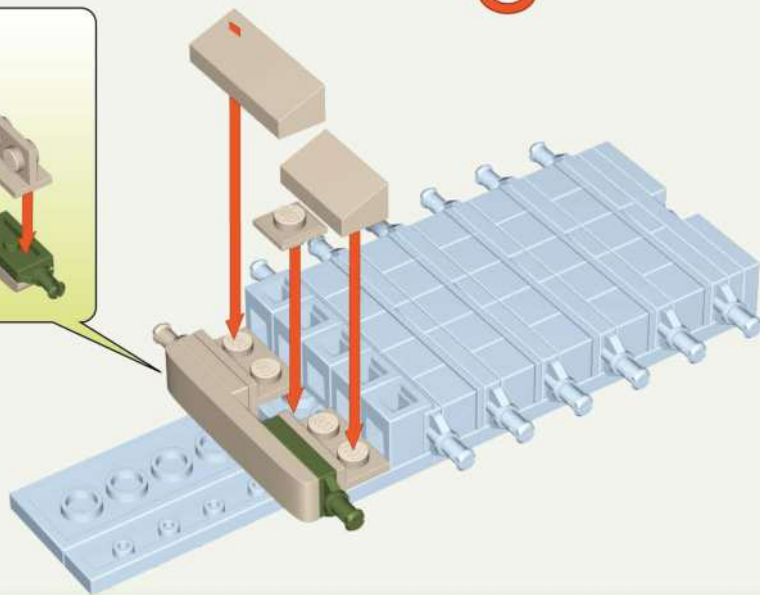
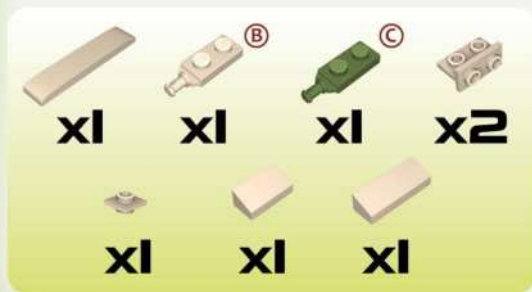
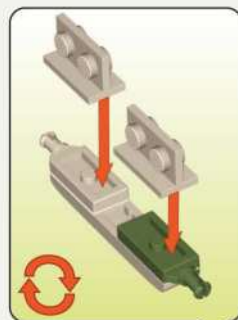

14

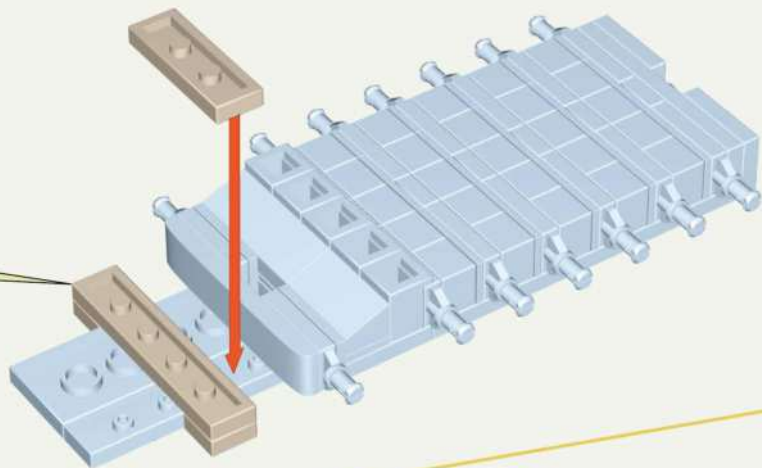
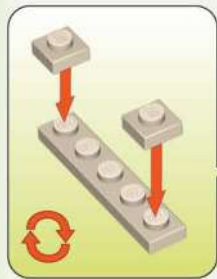

15

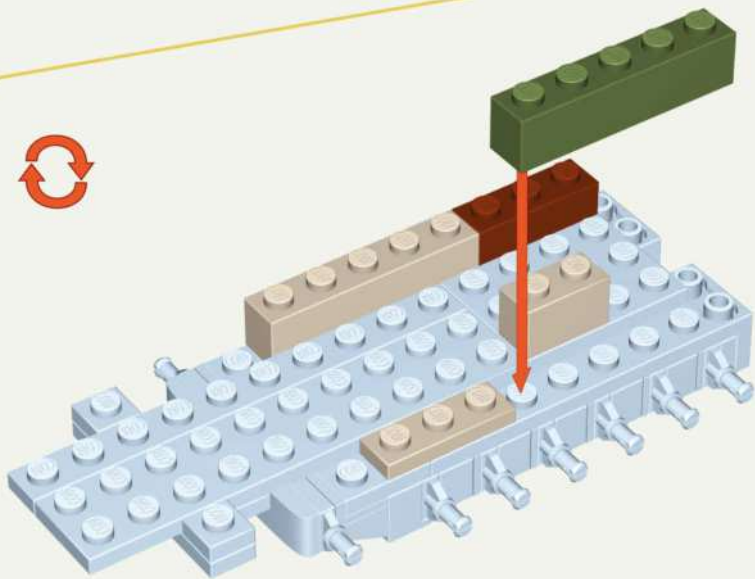
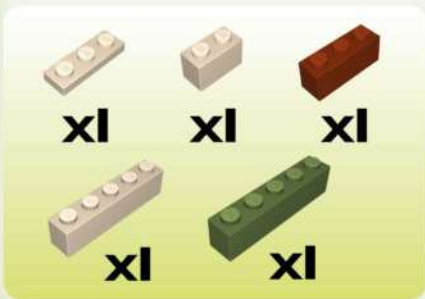

16

1:1

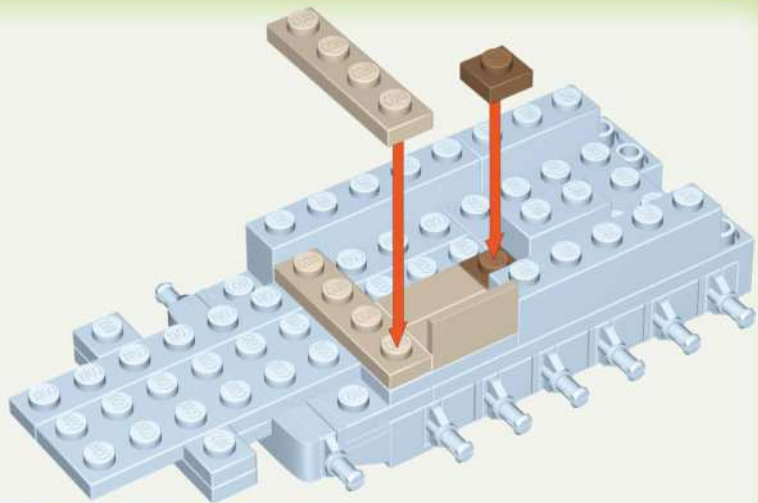
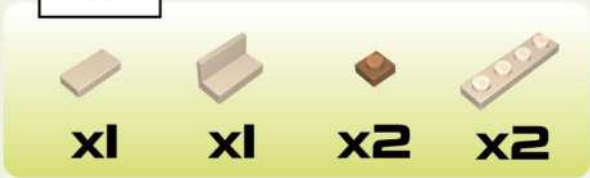

17

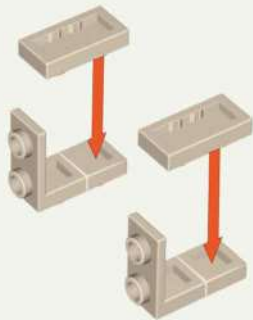

18

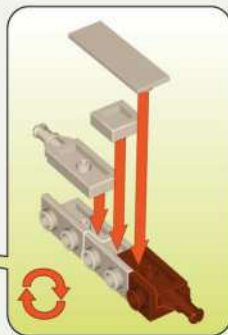
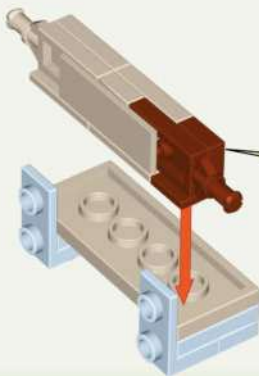

19

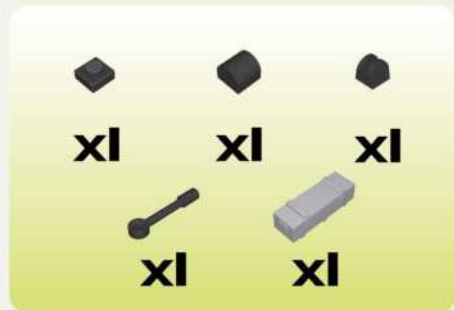
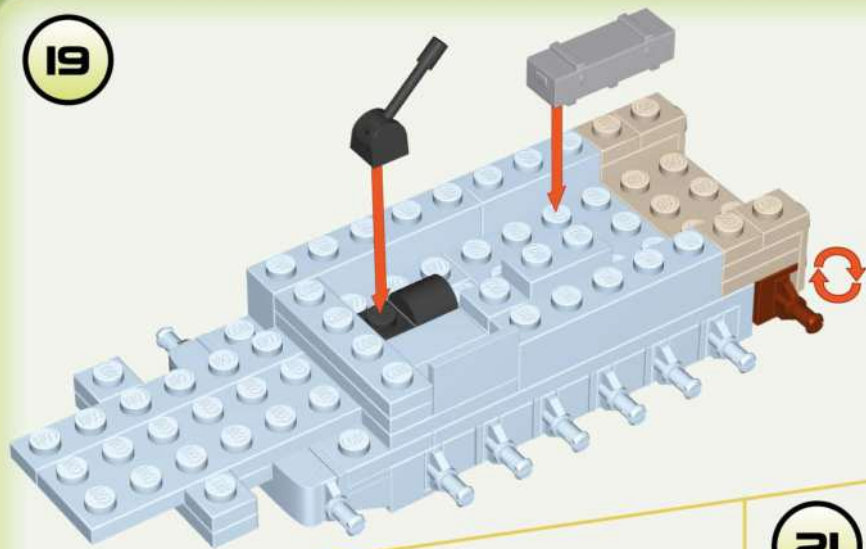

20

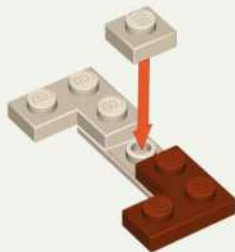

21

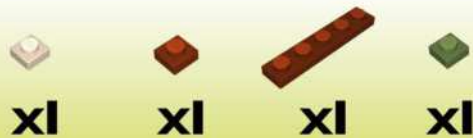
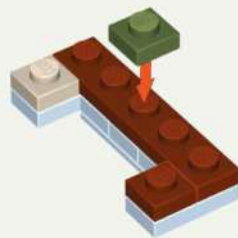

22

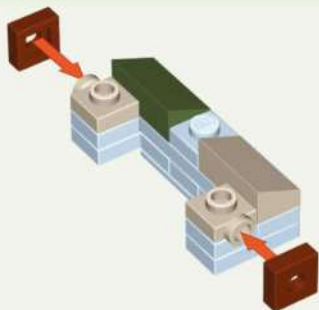

x2



x1



x1



x2

23

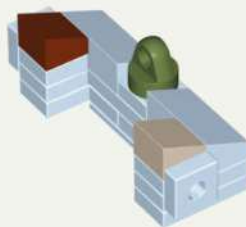

x1



x1



x1

24



x1



x2



x1



x1

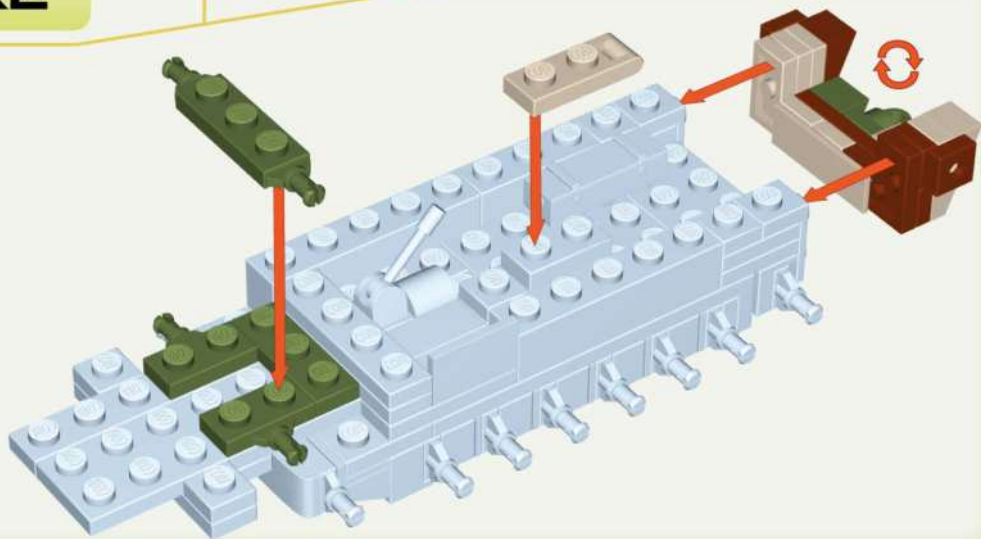

25

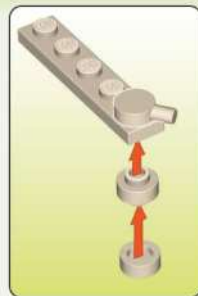
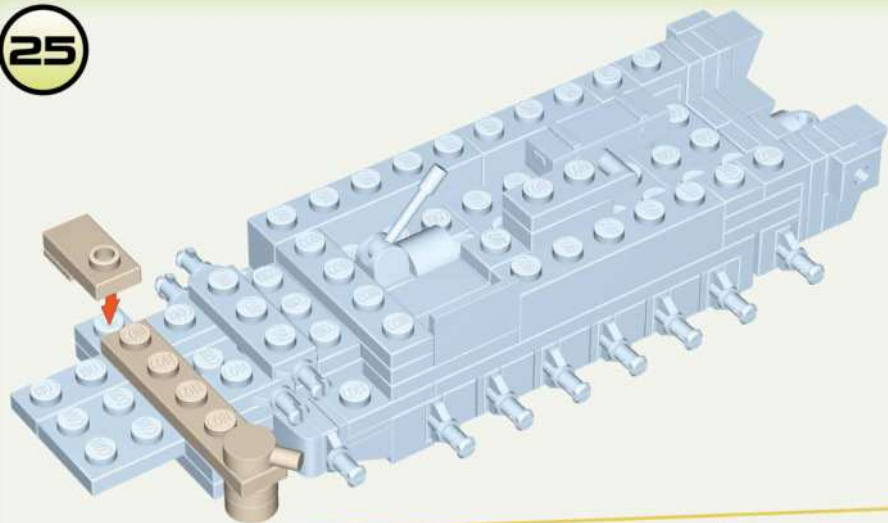

x1	x1
x1	x1
x1	x1

26

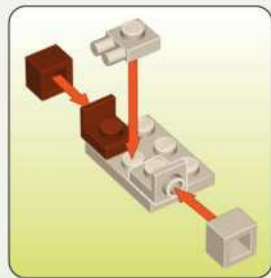
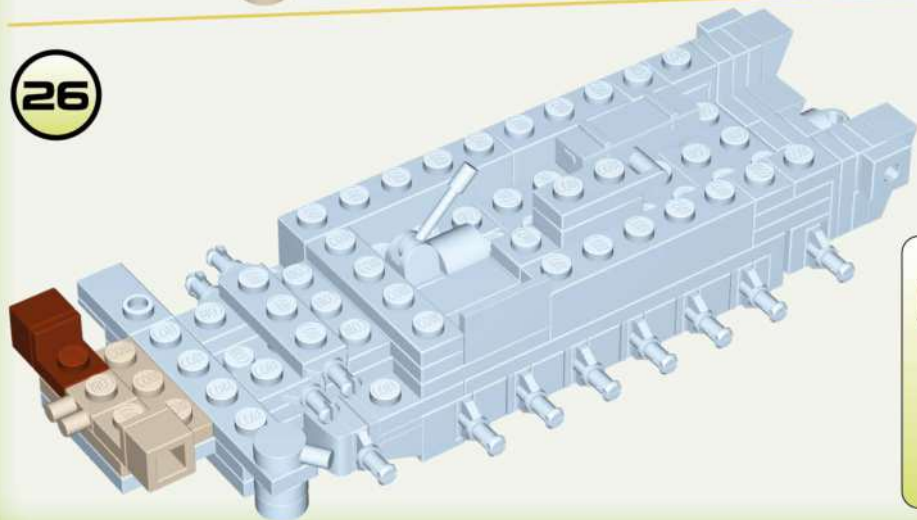



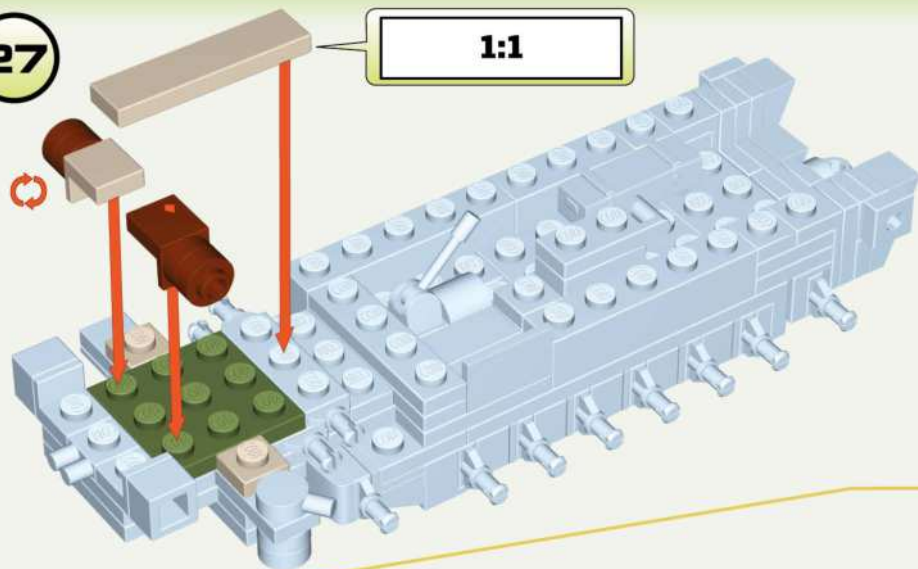

x1	x1
x1	x1
x1	x1

27







1:1



- | | |
|---|---|
|  |  |
| x1 | x2 |
|  |  |
| x1 | x1 |
|  |  |
| x1 | x4 |

28

- | | | |
|--|--|---|
|  |  |  |
| x2 | x2 | x1 |
|  |  | |
| x1 | x1 | |

1:1

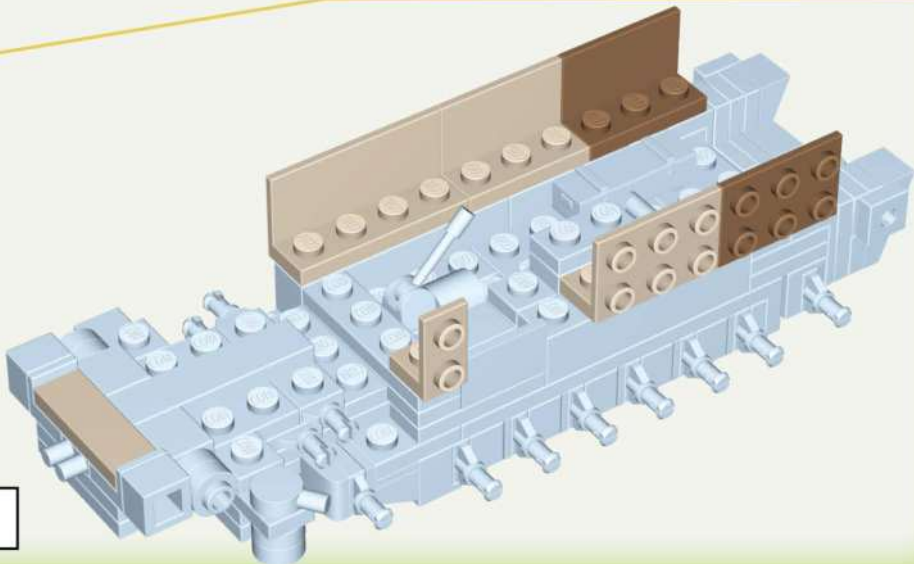

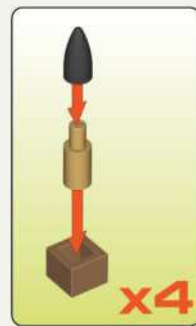
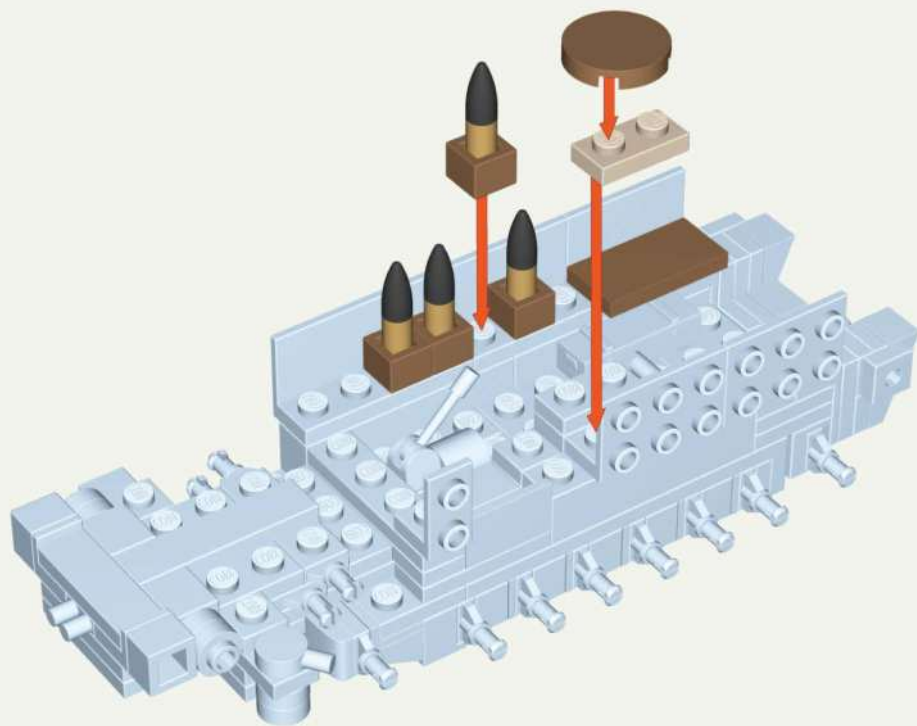

x1



x4



x4



x4



x1



x1

30

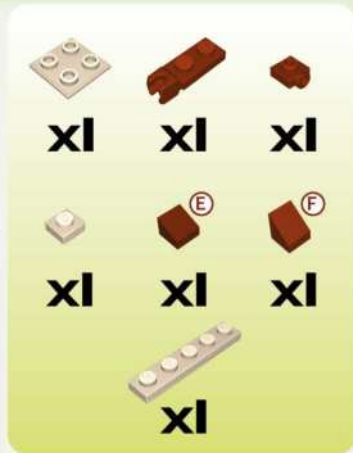
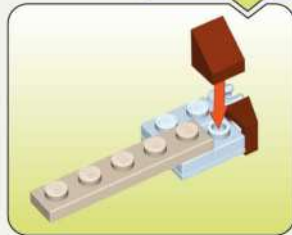
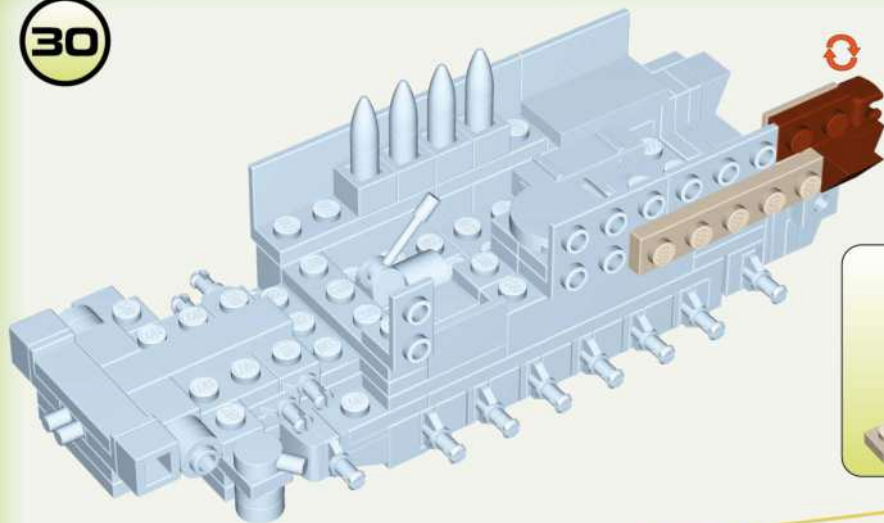



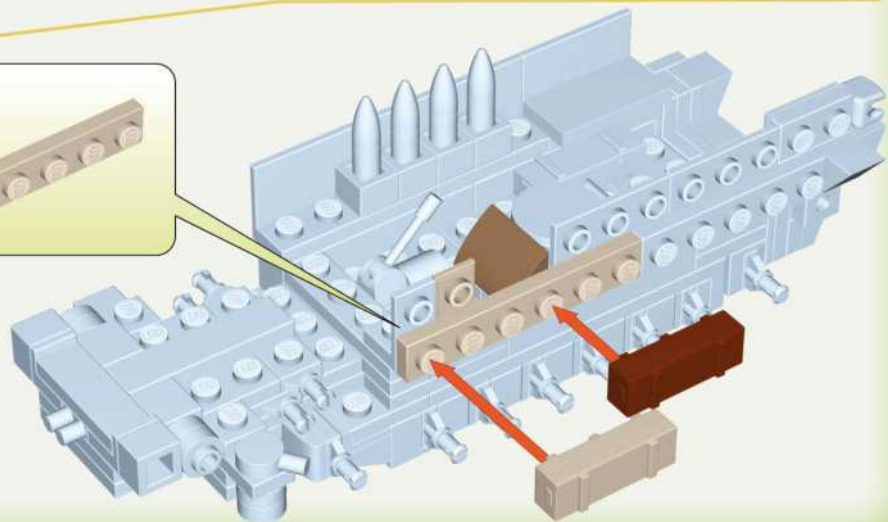
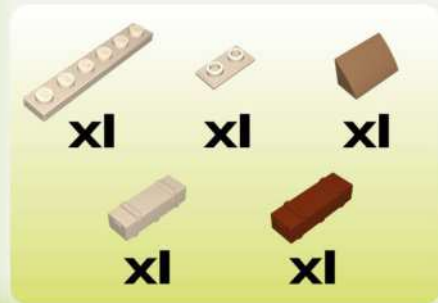
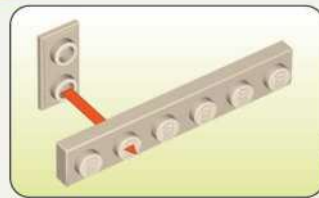



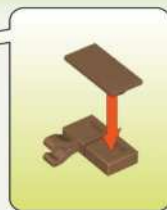
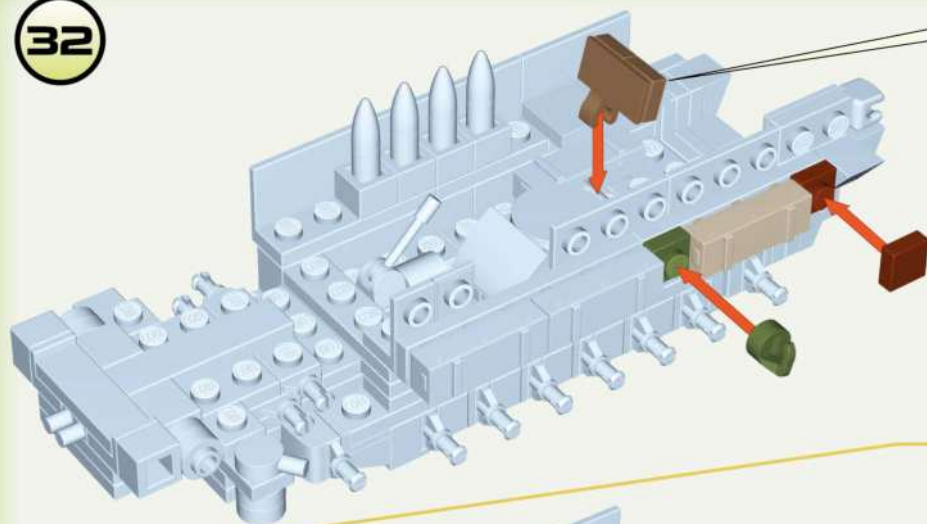

31







32

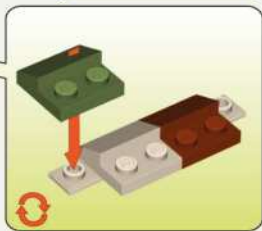
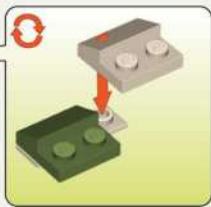
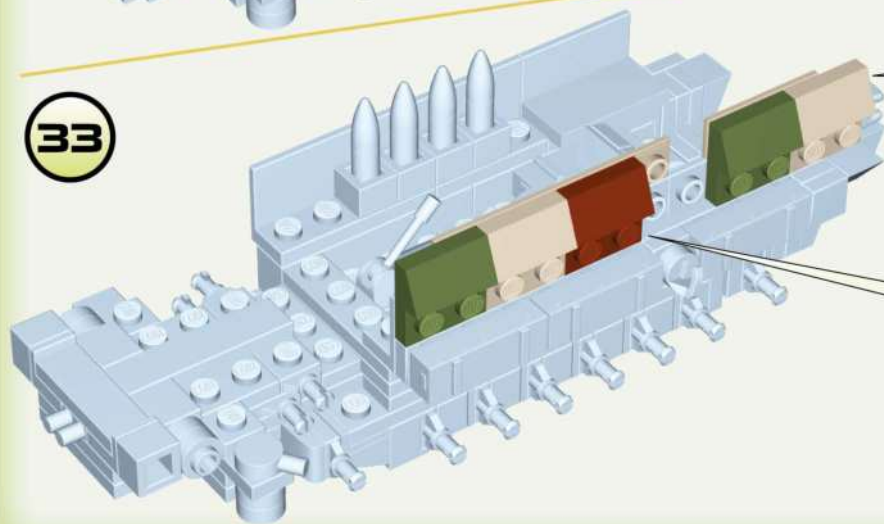

- | | | |
|---|---|---|
|  |  |  |
| x1 | x1 | x1 |
|  |  |  |
| x1 | x1 | x1 |
|  |  | |
| x1 | x1 | |

33



- | | |
|---|---|
|  |  |
| x1 | x1 |
|  |  |
| x1 | x2 |
| |  |
| | x2 |

34

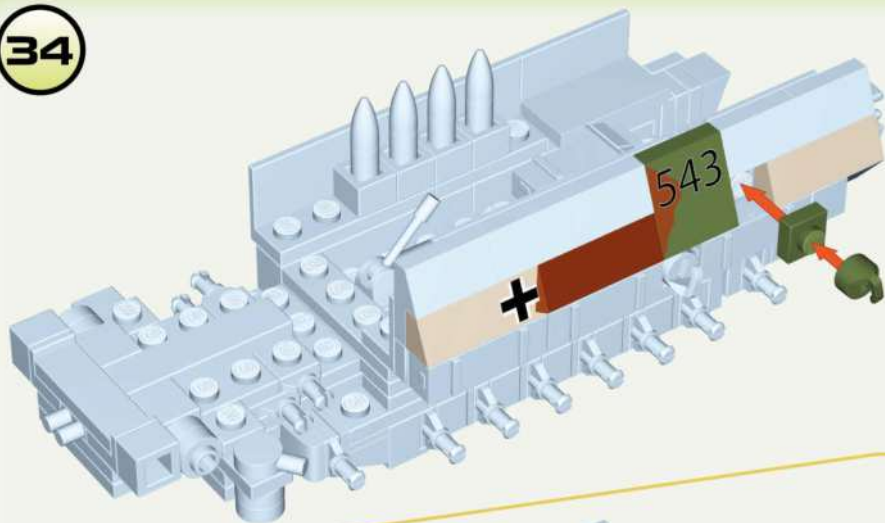

x1	x1	x1
x1	x1	x1

35

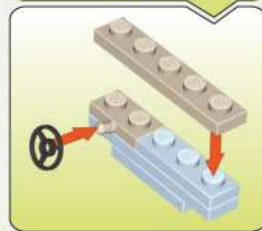
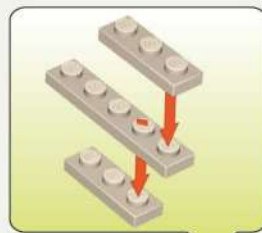
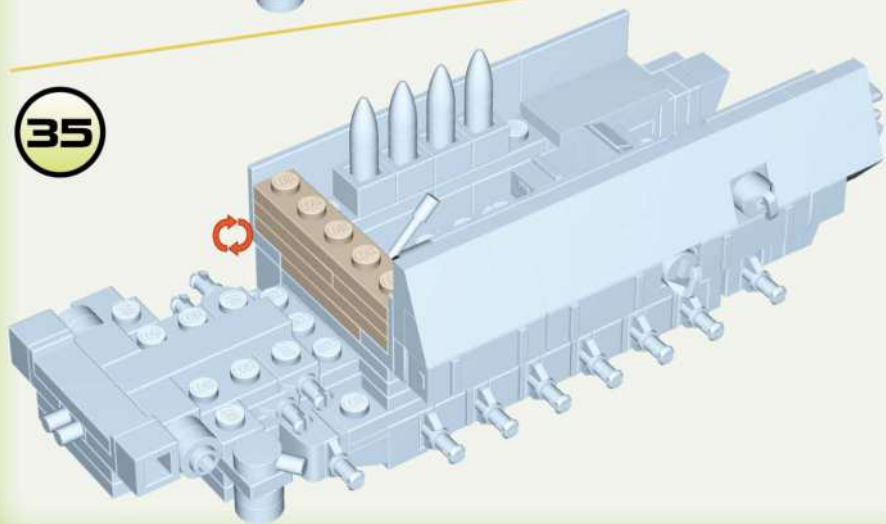

x2	x2
x1	x1

38

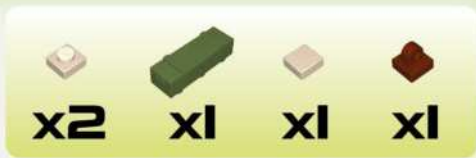
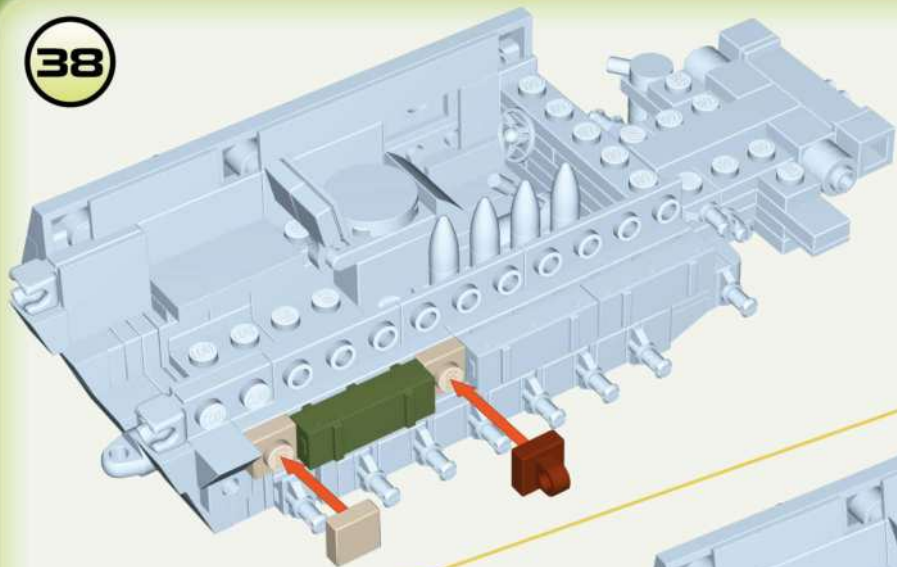

39

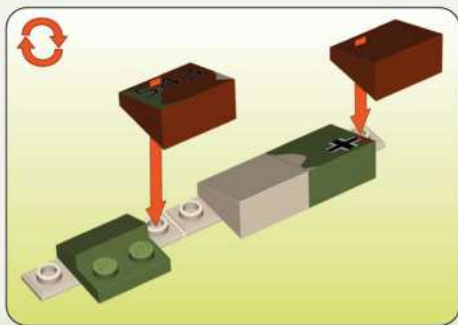
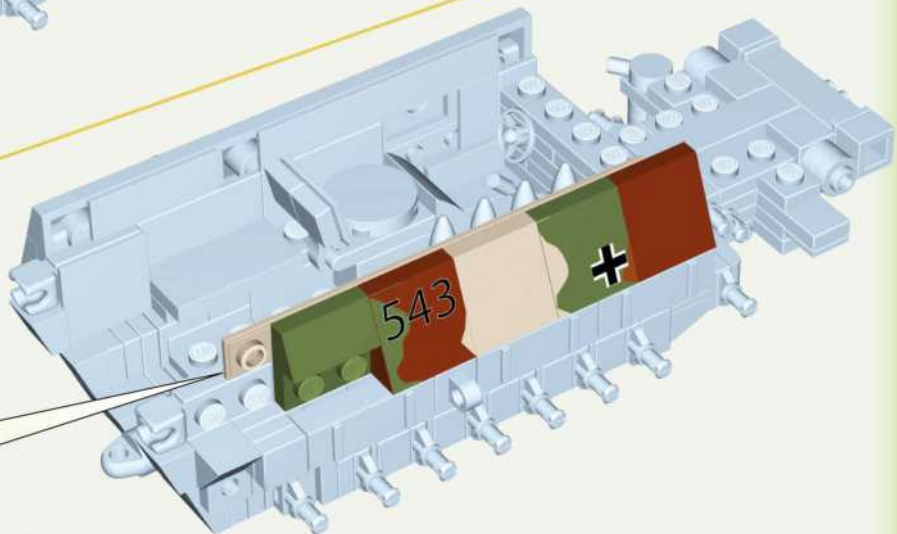



40



41

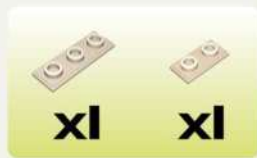
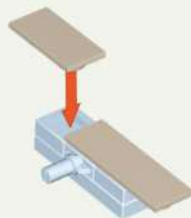

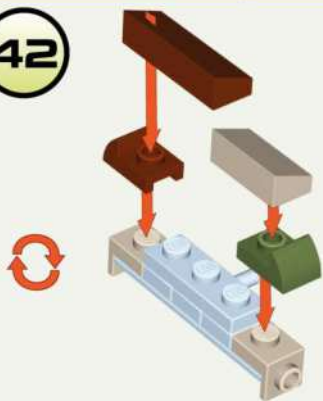

42

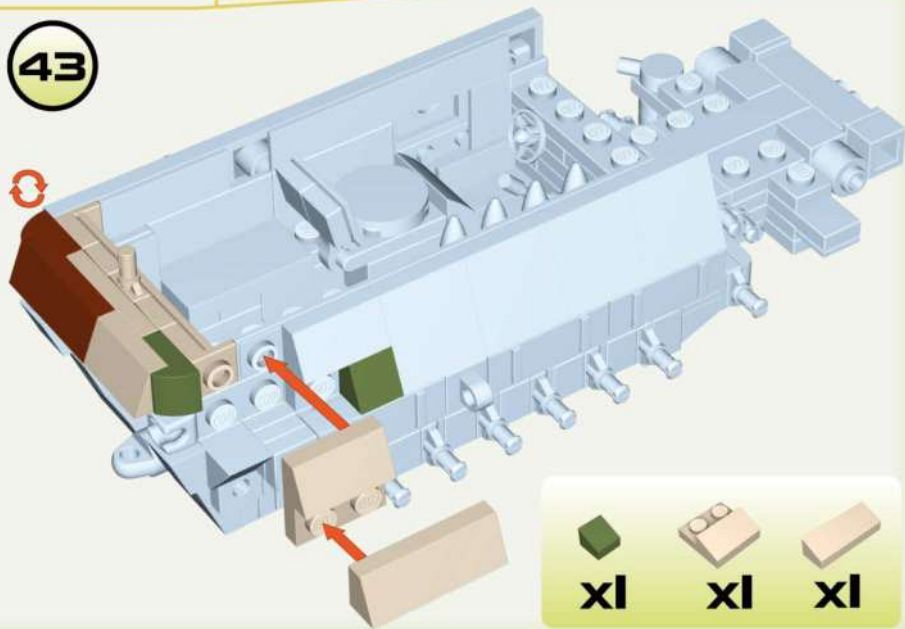

43

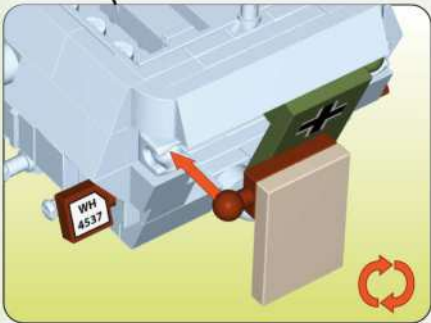
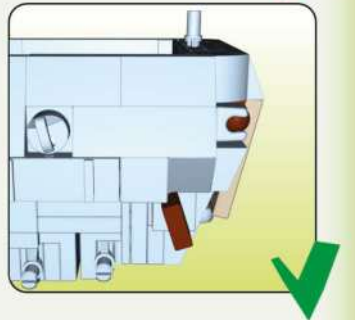
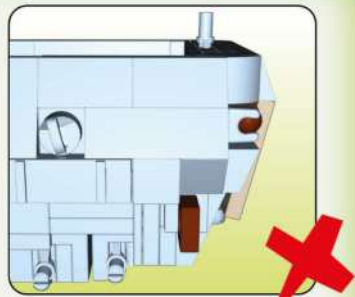
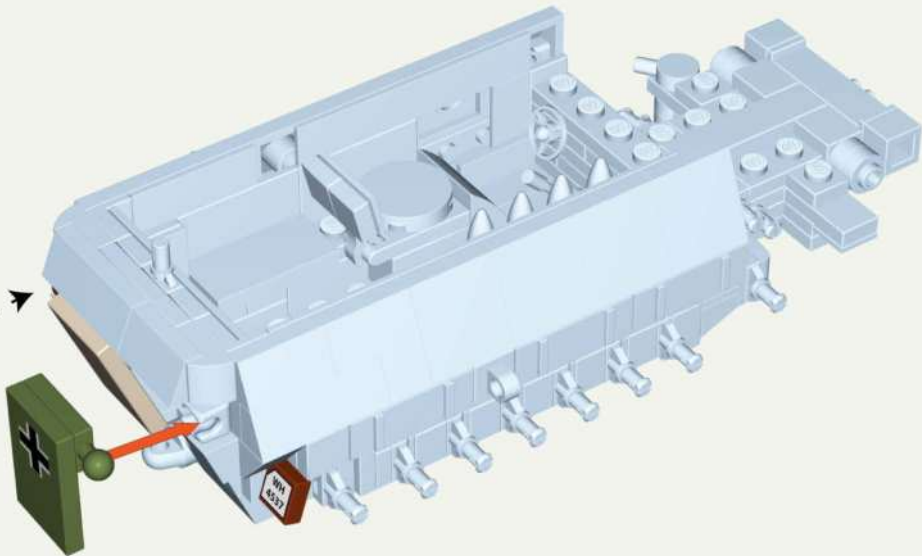



-  **x1**
-  **x1**
-  **x1**
-  **x1**
-  **x1**
-  **x1**

45

-  x1
-  x1
-  x1
-  x1
-  x1

1:1

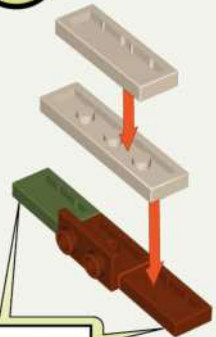

46

-  x1
-  x2
-  x1
-  x1

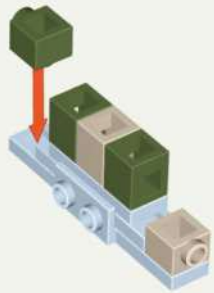

47

-  x2
-  x2

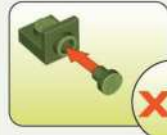



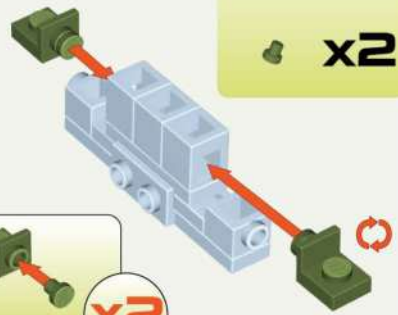

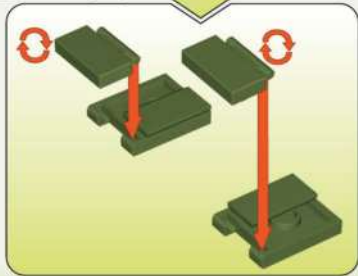
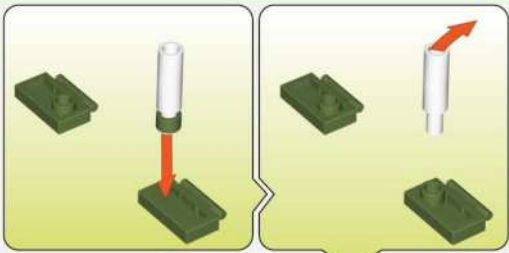
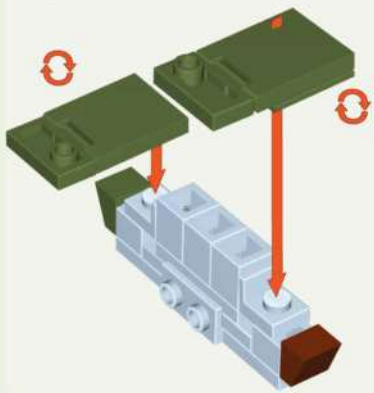

x2



48



-  x1
-  x1
-  x2
-  x2
-  x2
-  x2

49

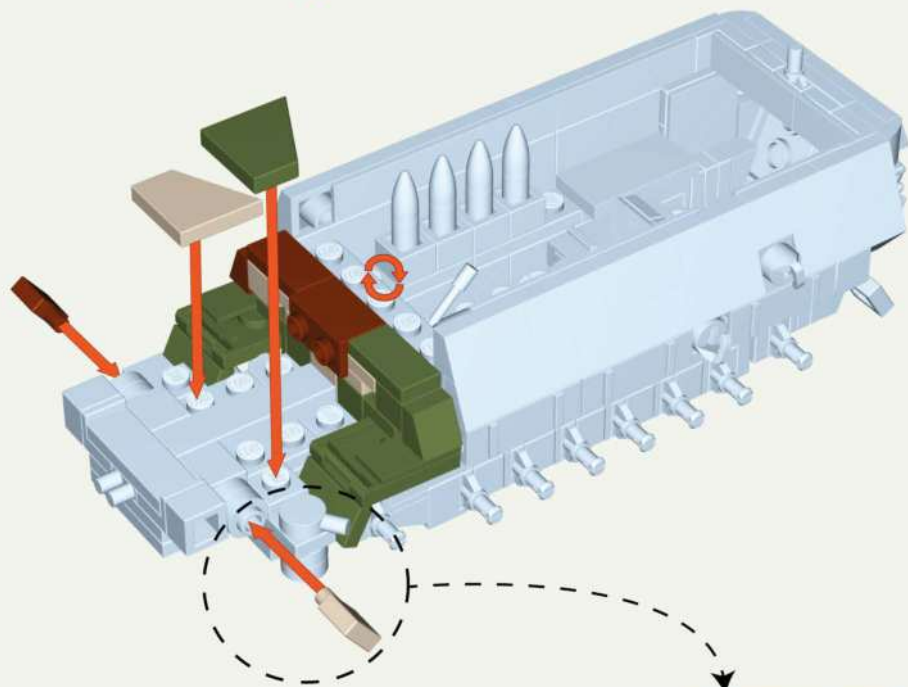

x1



x1



x1



x1

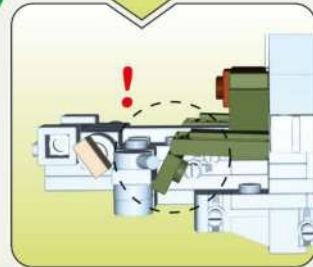
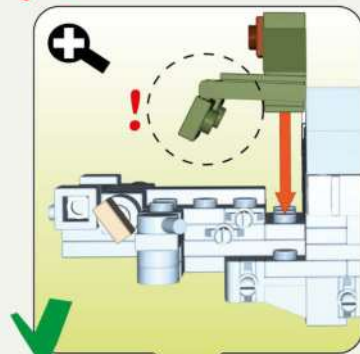
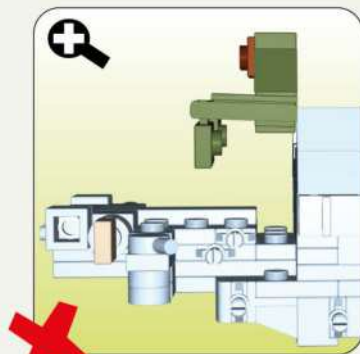
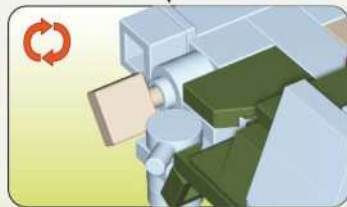

50

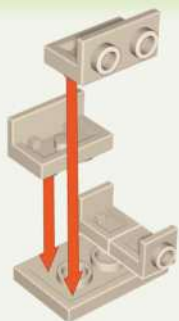

51

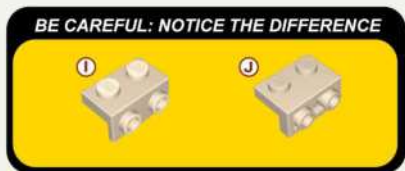
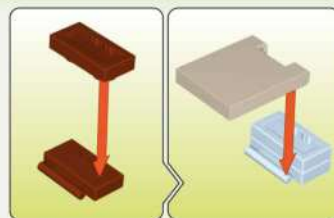
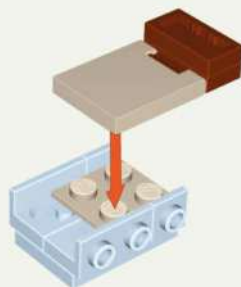

52

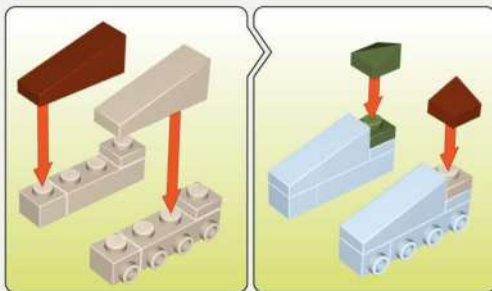

53

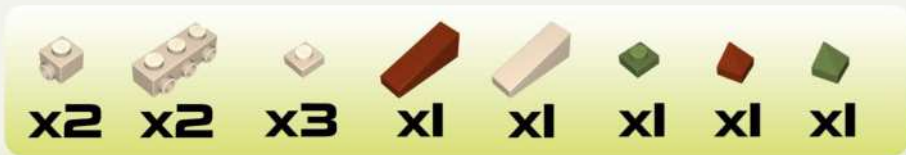
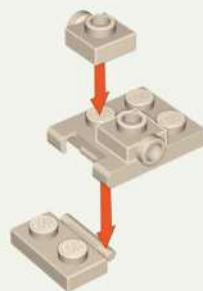

54

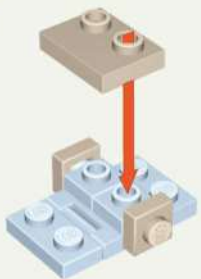

x2



x1

55

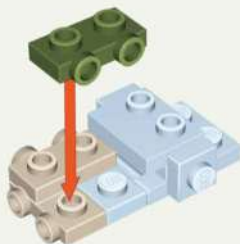

x2



x1

56

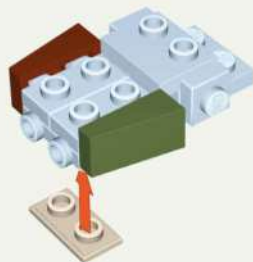

x1



x1



x1

57

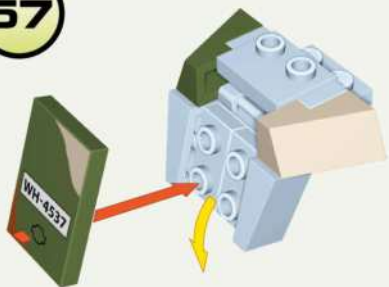

x1



x1



x1

58

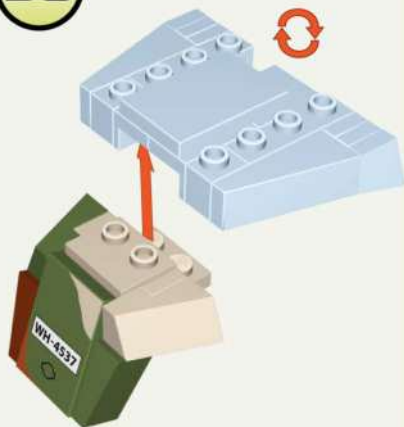

59



x1



x1



x1

60

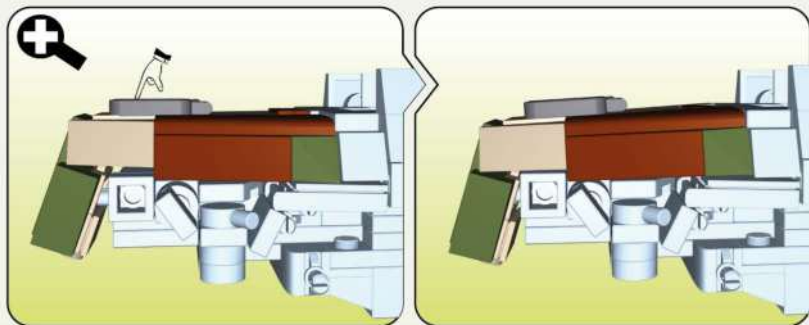
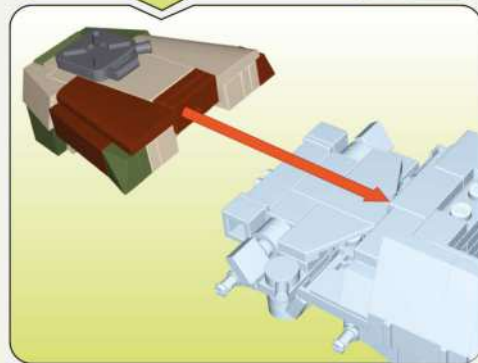
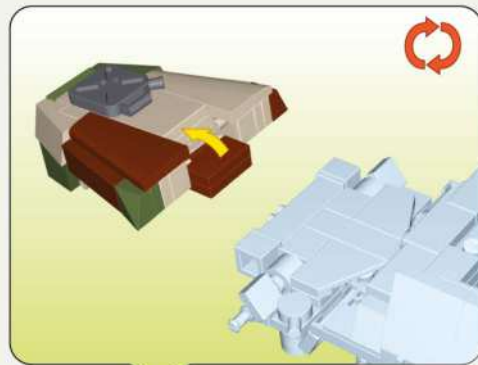
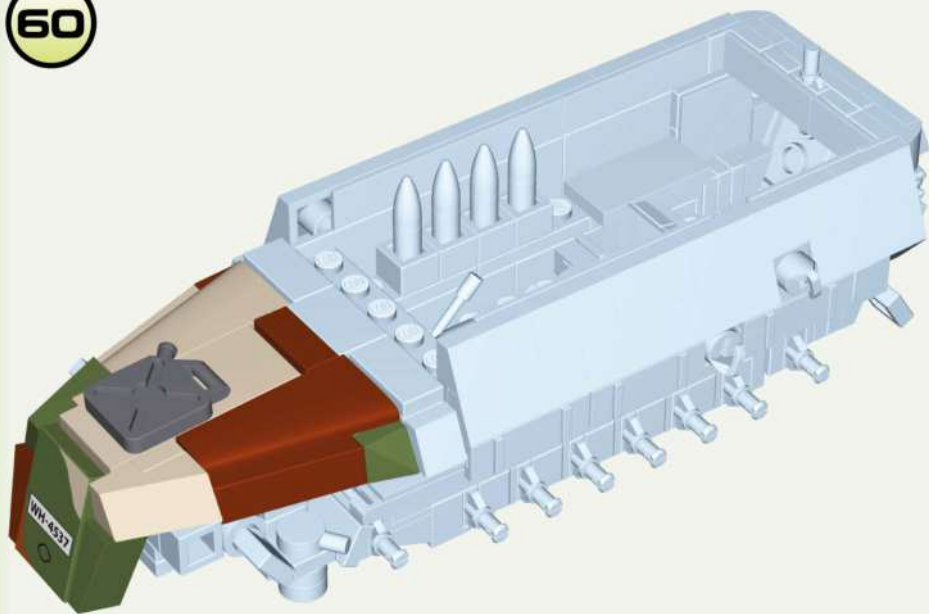

61

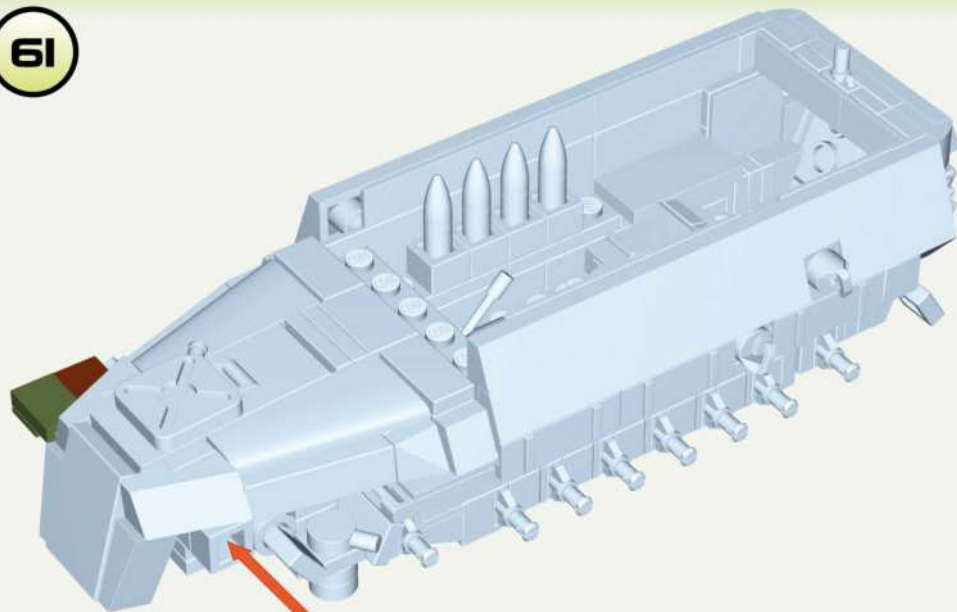

x2

x1

x1



x1

x1

x1



x1

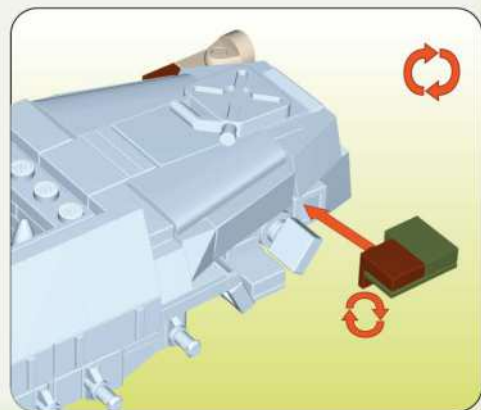
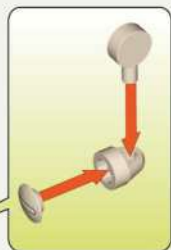
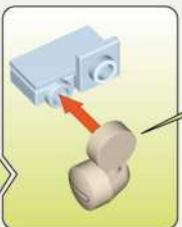
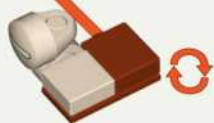

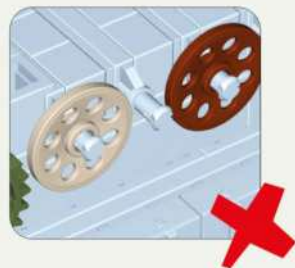
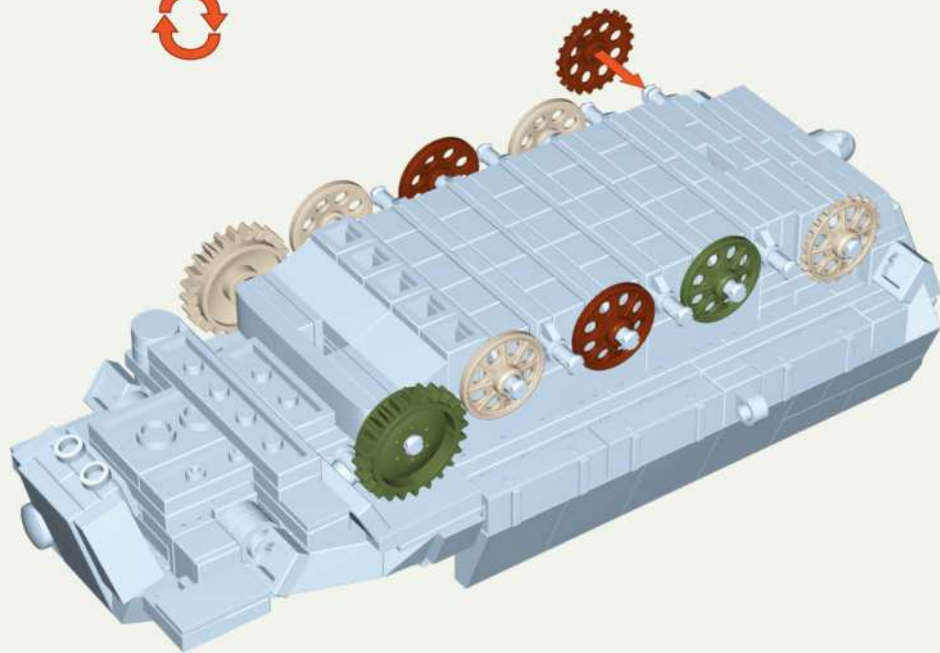

x1



x1



x3



x2



x1



x1



x1

63

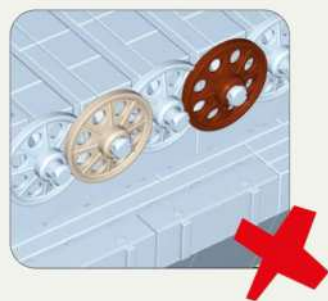
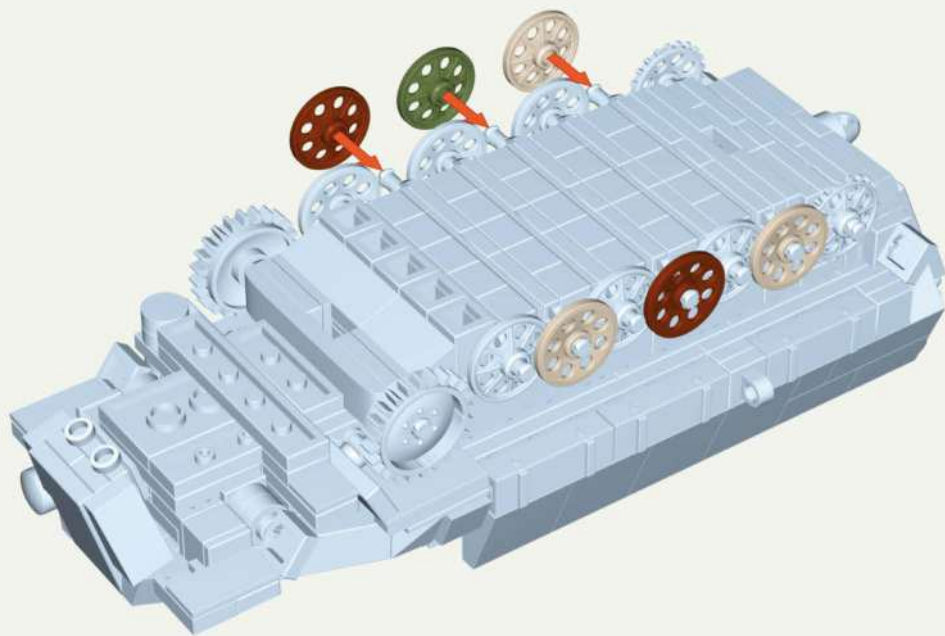

x2



x3



x1

64

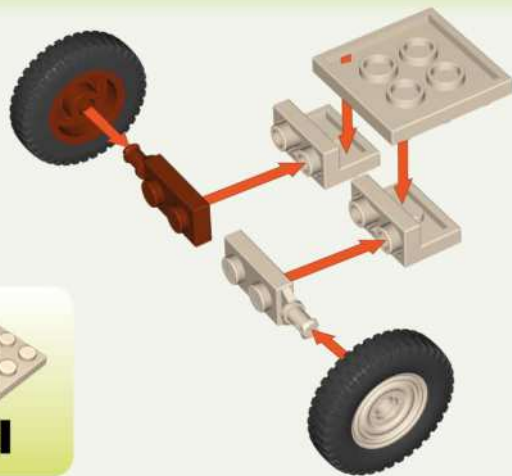
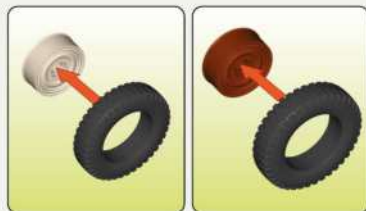

x1



x1



x2



x2



x1



x1



x1

65

1:1



x1



x1



x1



x1



x1

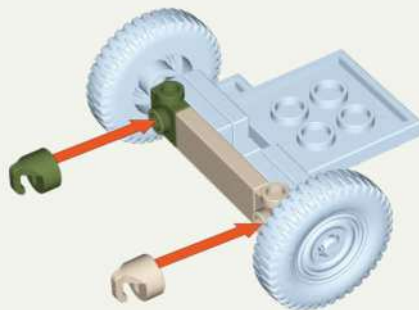

66

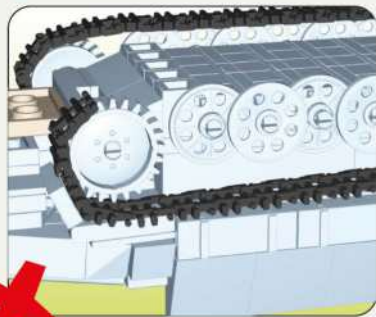
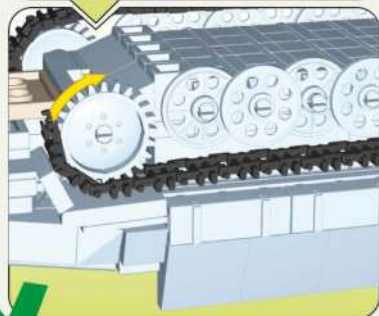
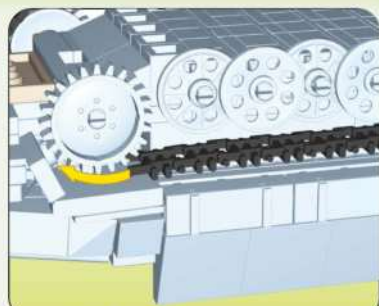
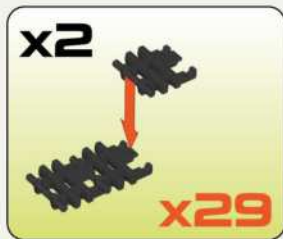
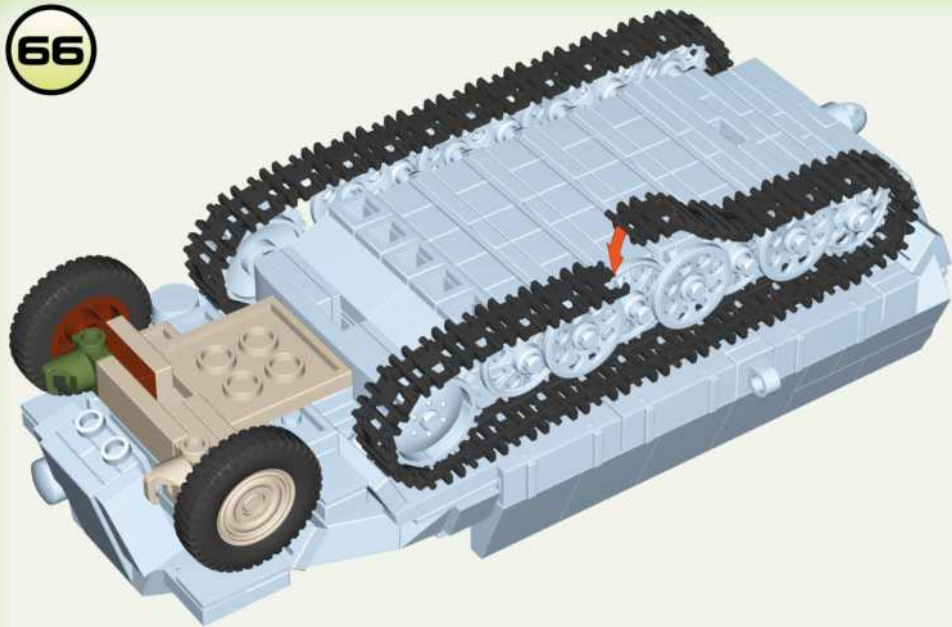

67

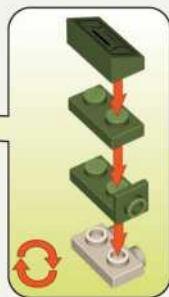
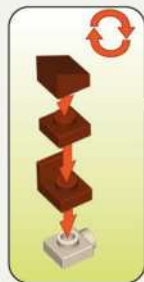
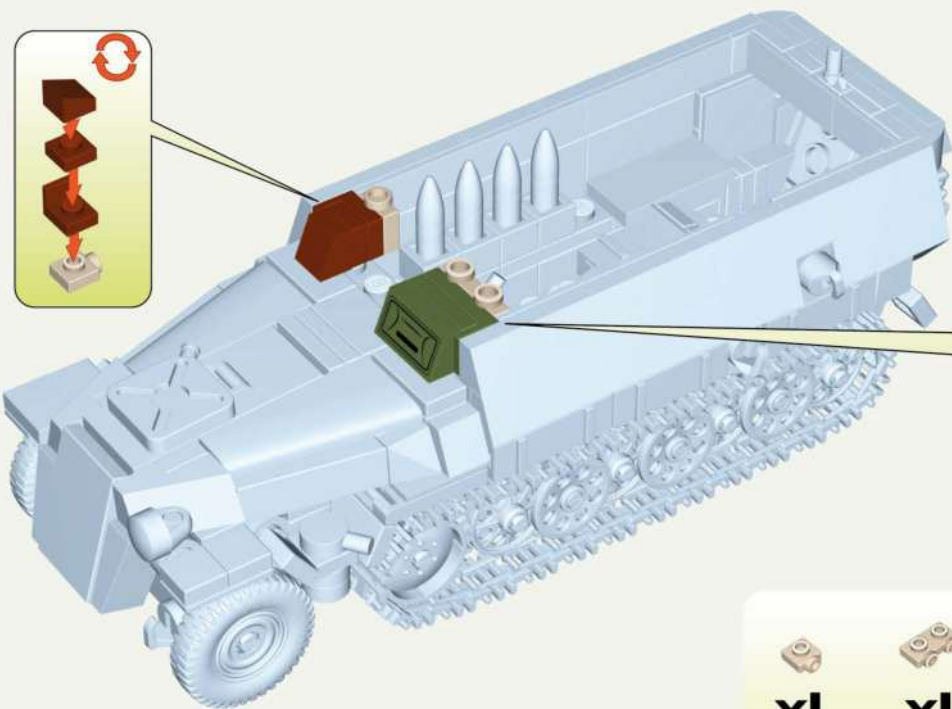

x1



x1



x1



x1



x1



x1



x1



x1

68

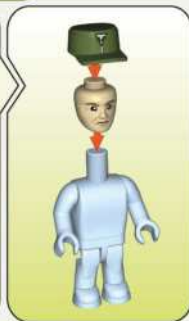
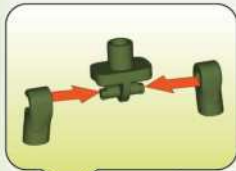
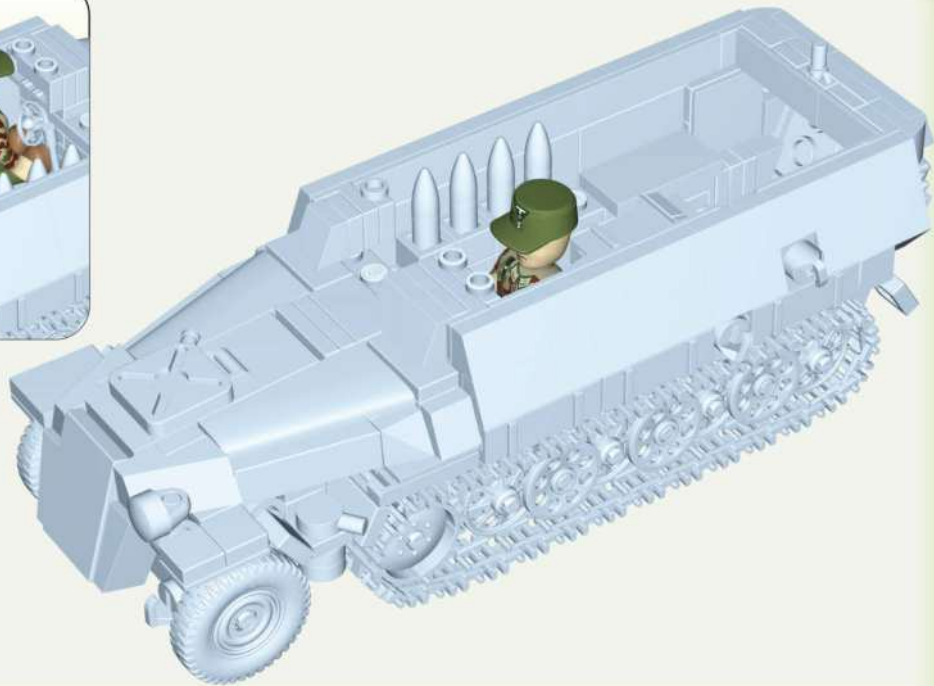
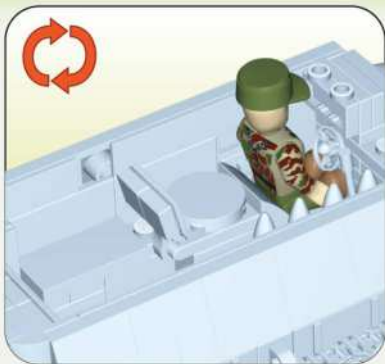

x1



x1



x1



x1



x2



x1



x1

69

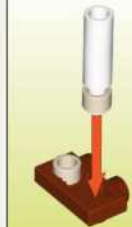

x1



x2



x1

70

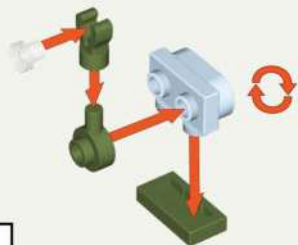

1:1



x1



x1



x1



x1

71

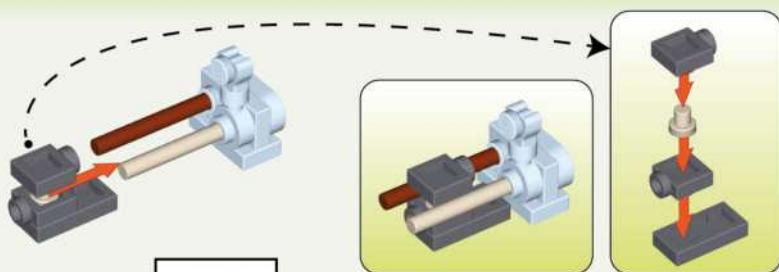

1:1



x1



x1



x1



x2



x1

72

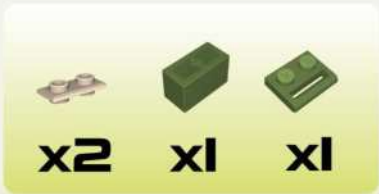
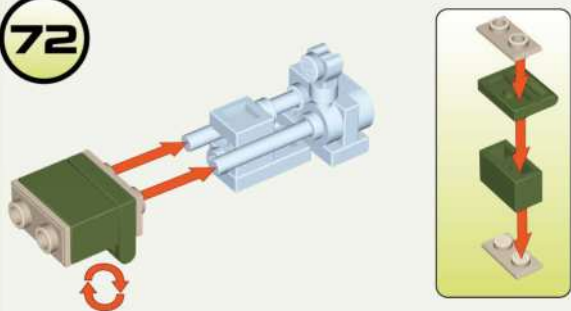

x2

x1

x1

73

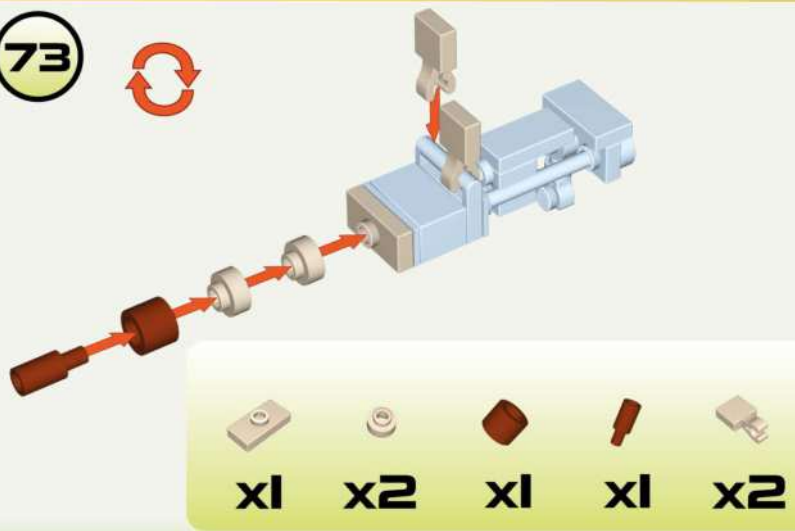

x1

x2

x1

x1

x2

74

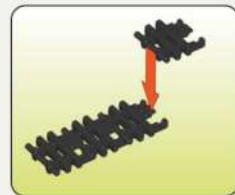
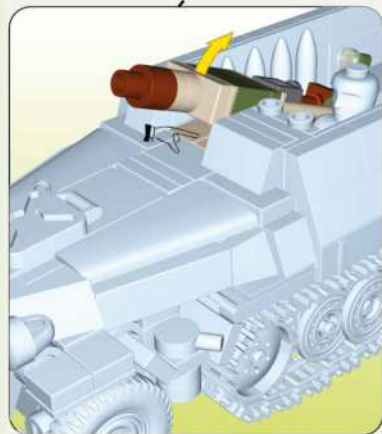
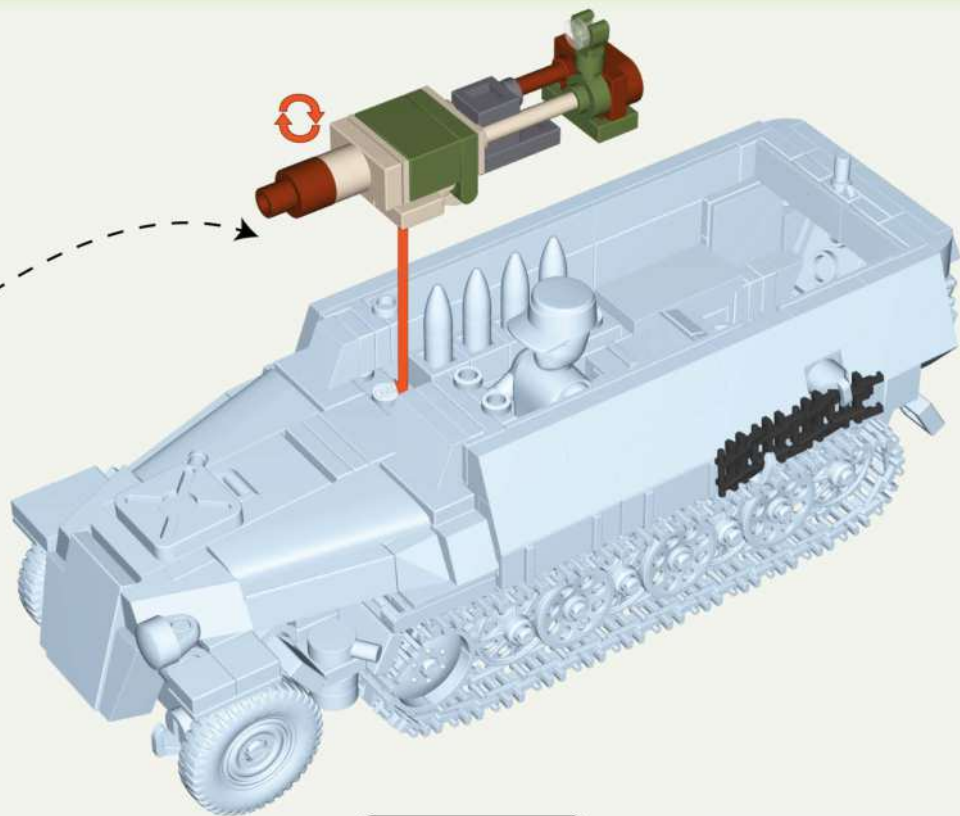

75

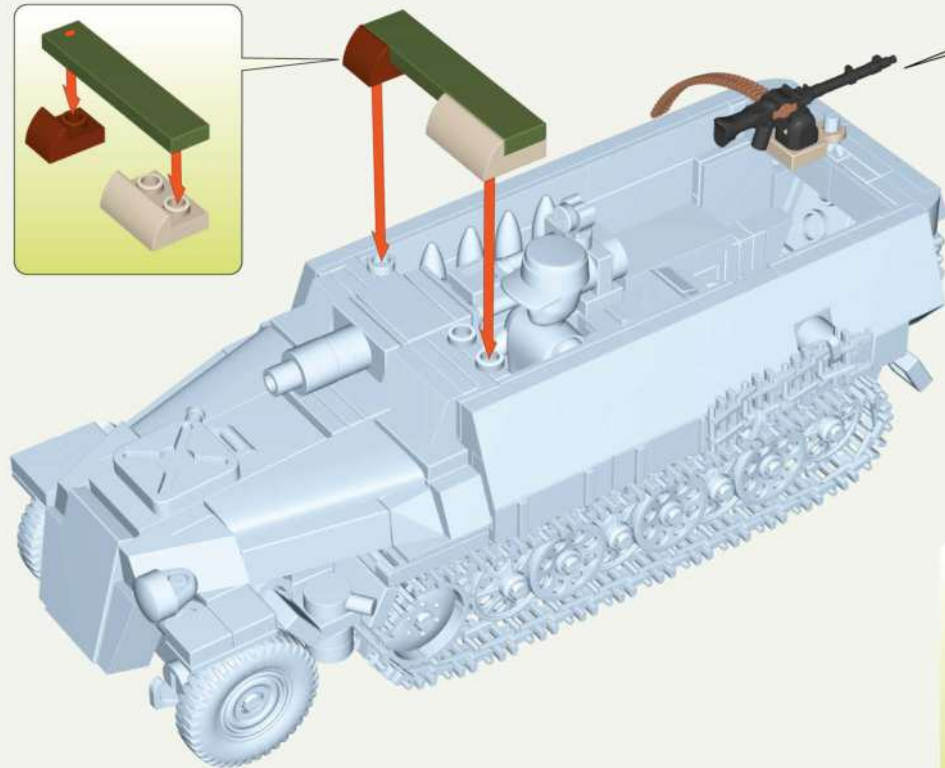
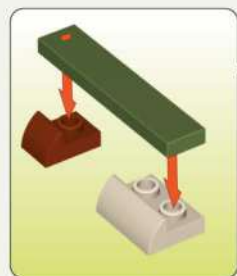

1:1



x1



x1



x1



x1



x1



x1







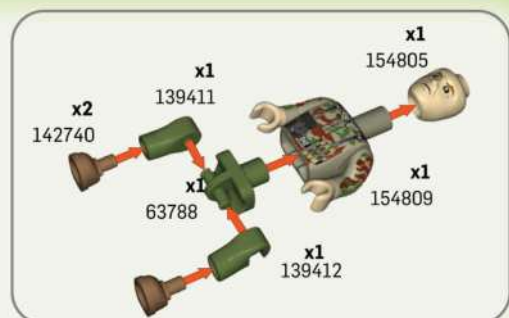
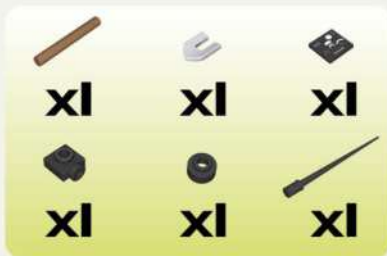
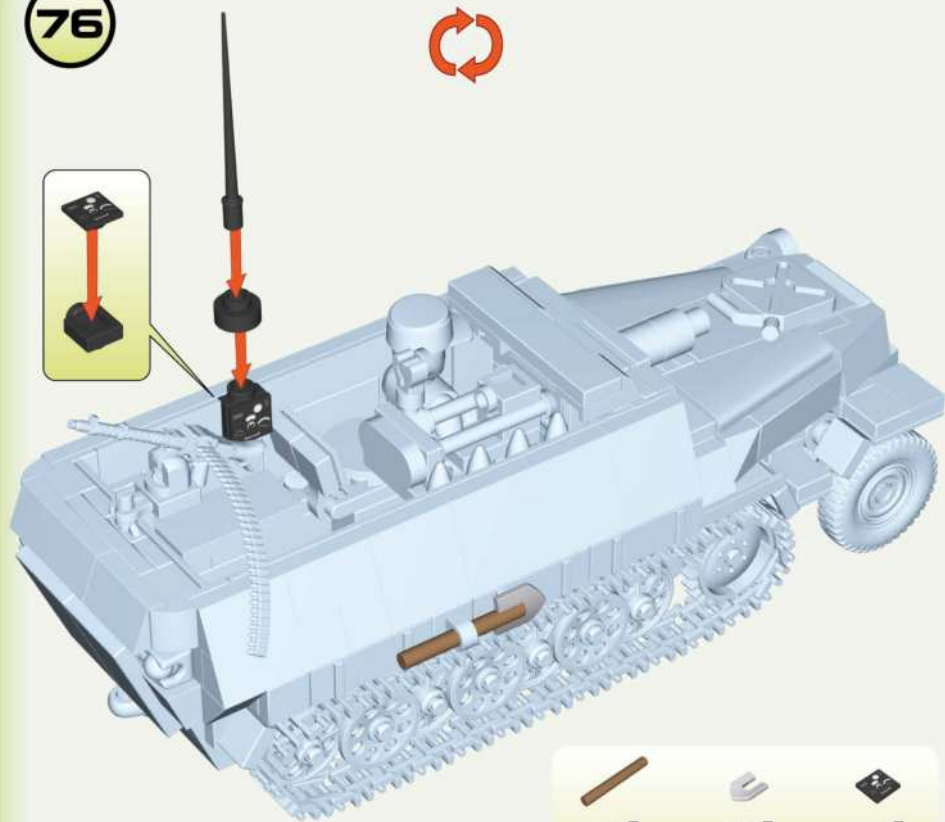







































































x1

76



- | | | | |
|--|--|--|--|
|  |  |  |  |
| x1
153389 | x2
154974 | x1
141421 | x1
144504 |
|  |  |  |  |
| x1
105892 | x2
154947 | x2
44013 | x3
97446 |
|  |  |  |  |
| x26
44497 | x1
43969 | x4
44014 | x1
42868 |
|  |  |  |  |
| x1
117340 | x1
154864 | x1
154865 | x1
127517 |
|  |  |  |  |
| x1
123021 | x1
48521 | x1
136861 | x2
135731 |
|  |  |  |  |
| x4
107019 | x4
152442 | x1
143568 | x2
107020 |

 x1 155031	 x2 128474	 x1 123484	 x2 118376	 x2 148816	 x1 150049	 x4 128409	 x2 127736	 x1 124771	 x1 42879	 x1 96797
 x1 42877	 x1 101860	 x1 154949	 x7 148828	 x1 150125	 x1 150425	 x2 147699	 x1 153159	 x1 128359	 x1 80121	 x2 154950
 x4 90342	 x1 105894	 x26 90513	 x1 154968	 x1 153306	 x1 128872	 x3 108073	 x1 111576	 x1 148971	 x5 105895	 x1 86037
 x2 86091	 x2 98212	 x1 132172	 x1 154866	 x6 136661	 x1 107860	 x2 120783	 x1 97495	 x3 42926	 x1 42931	 x2 42917
 x1 154971	 x2 133024	 x2 104584	 x2 143171	 x5 154895	 x7 154896	 x2 154639	 x1 128471	 x1 97447	 x1 45525	 x2 45540
 x1 51590	 x1 107257	 x2 98244	 x1 121447	 x1 154946	 x1 106788	 x1 148827	 x3 128232	 x1 132329	 x1 155017	 x1 106787
 x1 148826	 x2 105397	 x1 87333	 x1 42947	 x1 107036	 x1 54704	 x1 104434	 x2 83632	 x1 42890	 x1 42905	 x1 154608

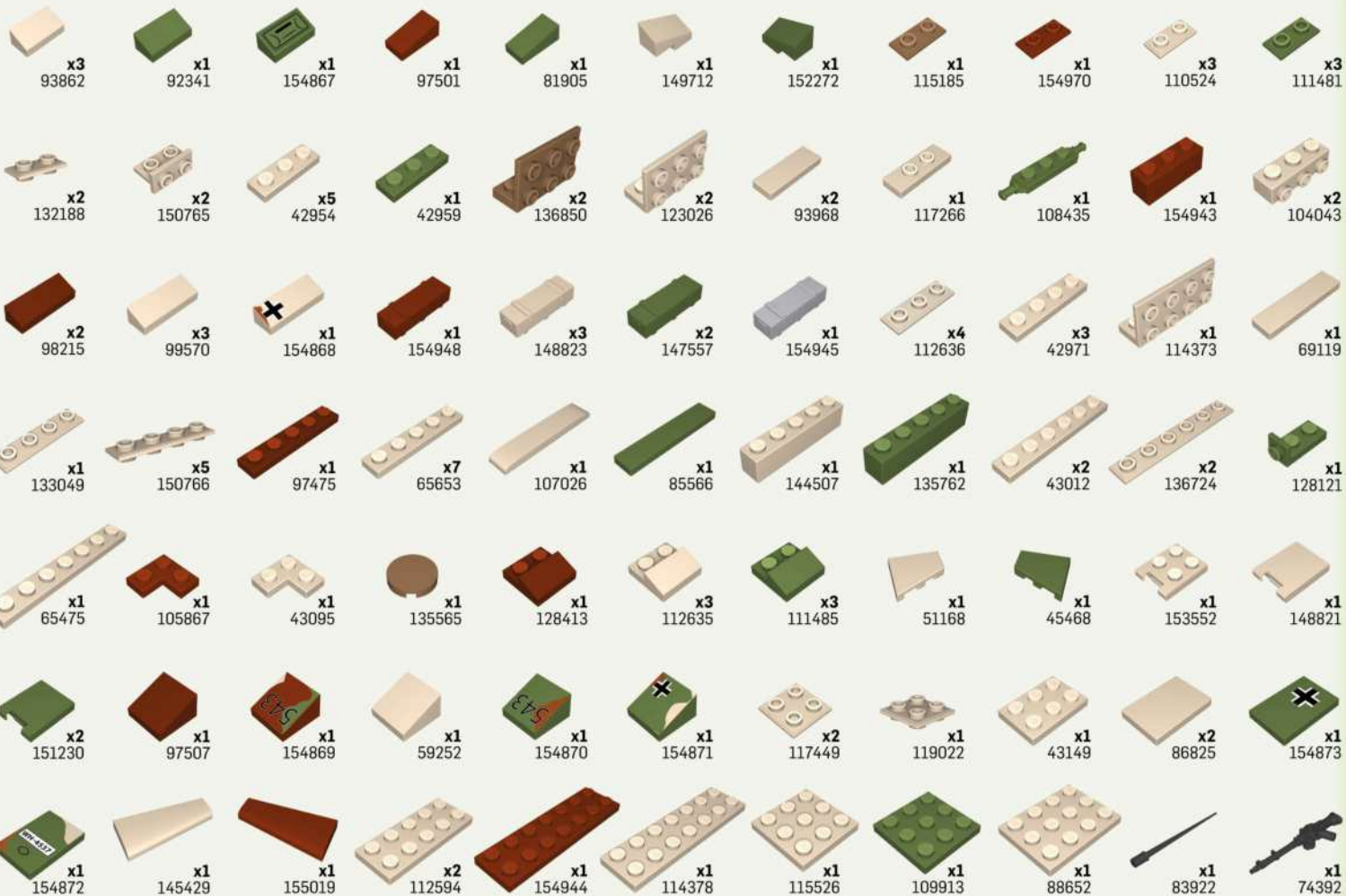





15cm NEBELWERFER 41

+ 2291



ZiS-3 SOVIET GUN

★ 2293

SD.Kfz. 251/9
"STUNNEL"



2283

SD.Kfz. 251/9
"STUNNEL" +

TABLE POINT

1.		38 cm	11.		1
2.		15 cm	12.		1
3.		-5 cm	13.		0
4.		-5 cm	14.		2
5.		+15 cm	15.		-
6.		5-6	16.		-
7.		5-6	17.		1
8.		8	18.		4
9.		2+	19.		42
10.		1	20.		Available 1942



2283

HISTORICAL
COLLECTIONBATTLE OF ARRAS (1940)
MATILDA II vs PANZER 38(t)

+ 2284

00-02283-482

WWW.COBIBRICKS.COM

For
news and
special deals

Find us on:

