

277



x1



x1

278



x1

1:1



x7

279

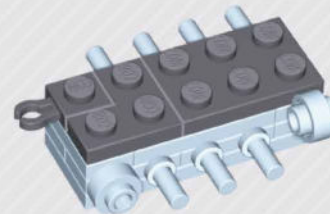

x1



x1

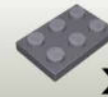

x1

280

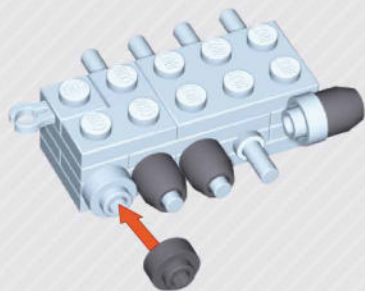

x1



x3

281

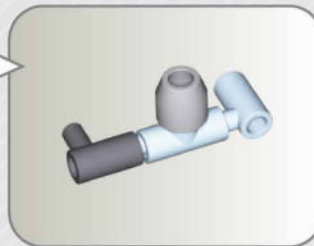
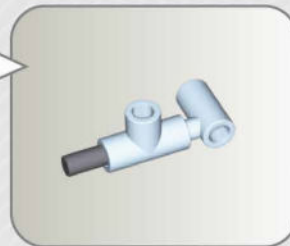
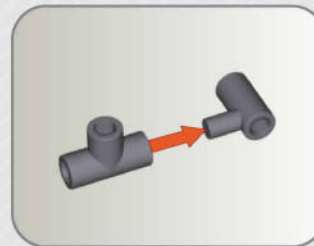

x1



x2

1:1



x1



x1

282

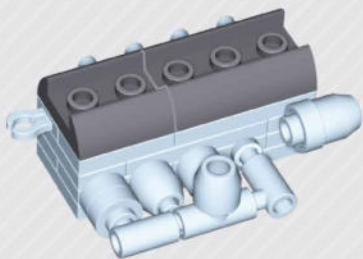

x1



x1

283

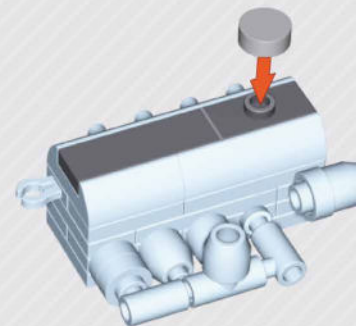

1:1



x1



x1



x1

284

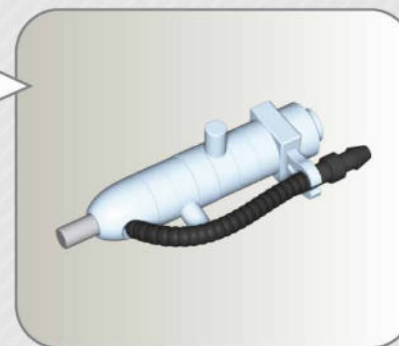
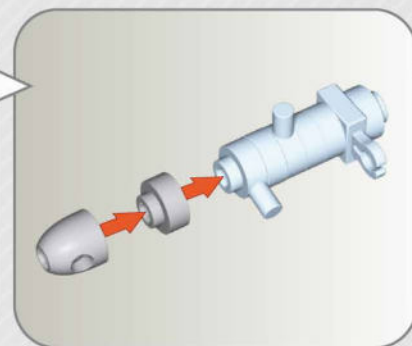
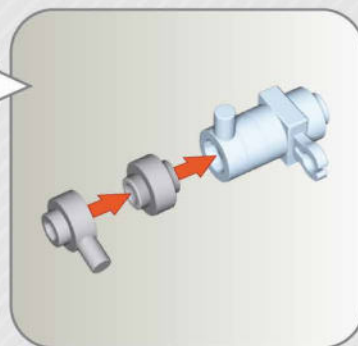
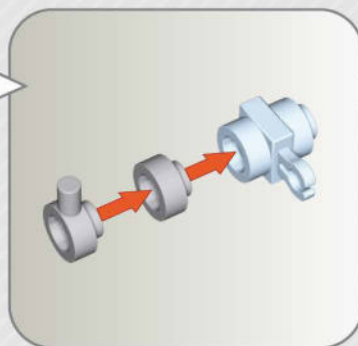
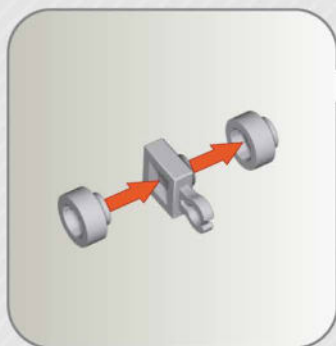

x4



x1



x2



x1



x1

1:1



x1



x1

285

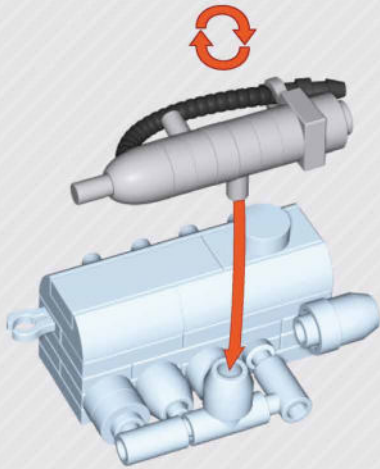

286

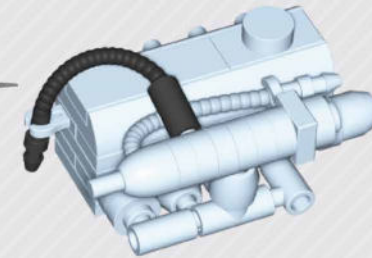

287

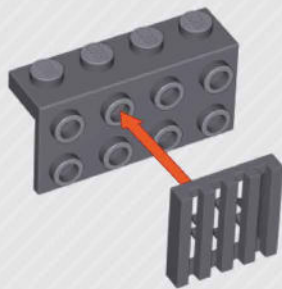

288

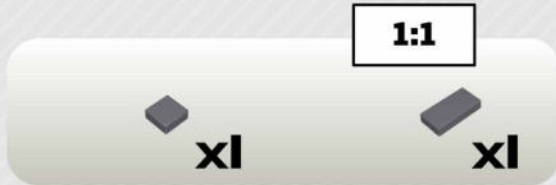
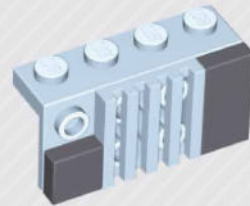

289

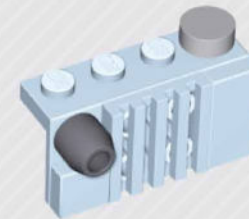

290

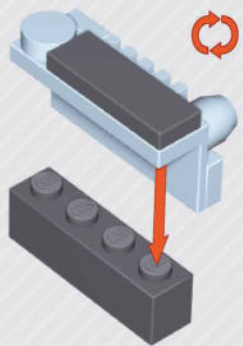

1:1

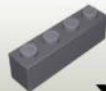

x1



x1

291

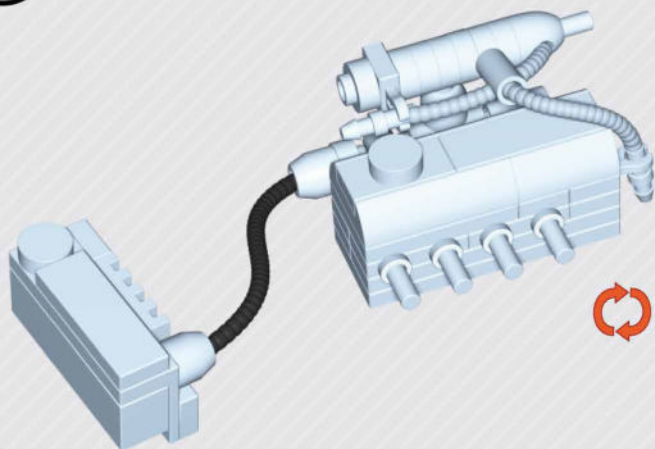

x1

292

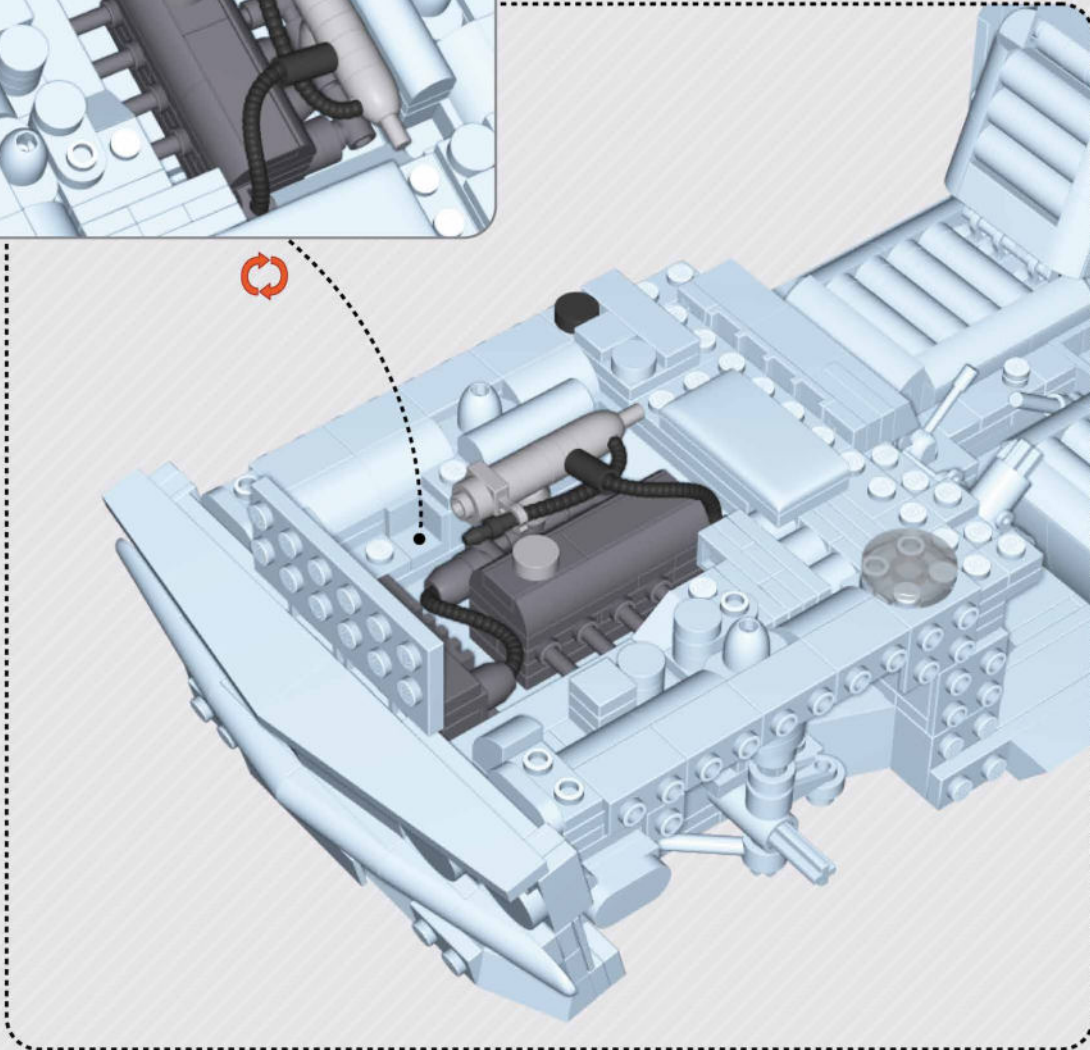
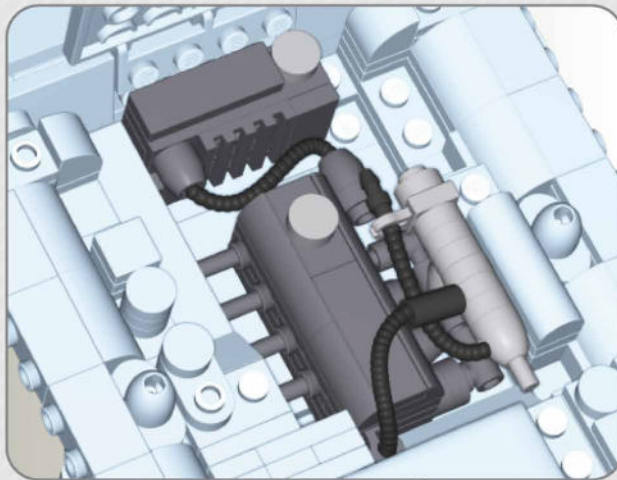



293

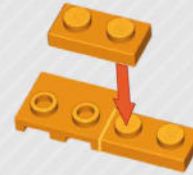

294



295



296

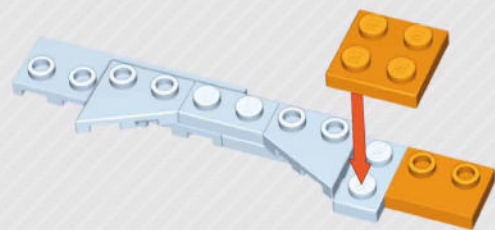
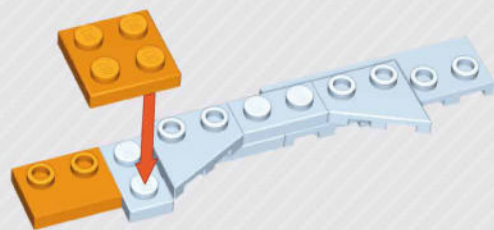

297



298



299



300

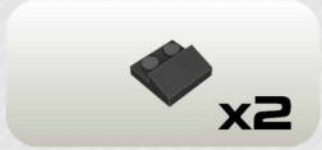

301

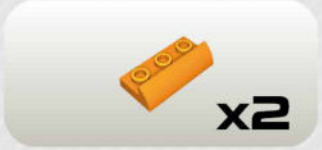

302

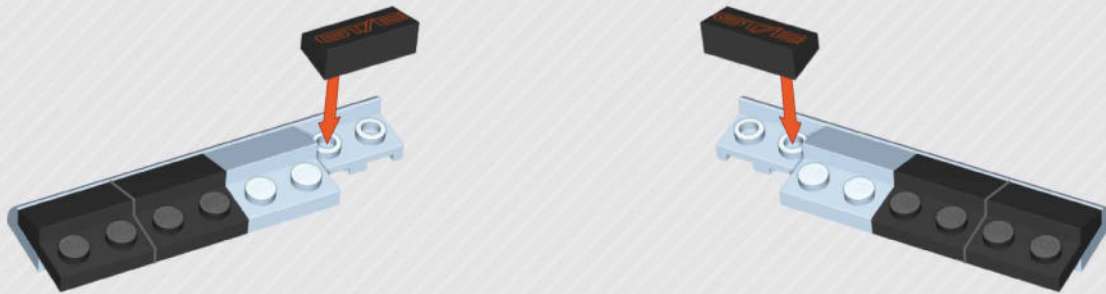

303



304



305

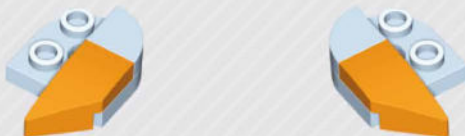

306

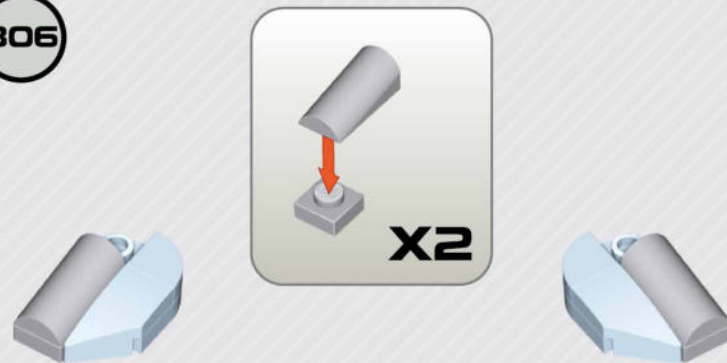

307



308



309



310



311



312

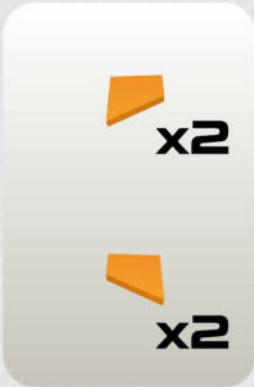

313



314

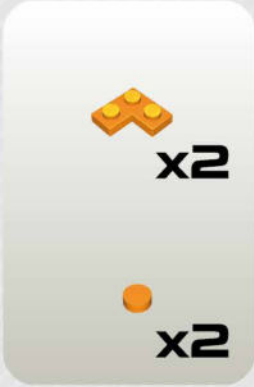

315

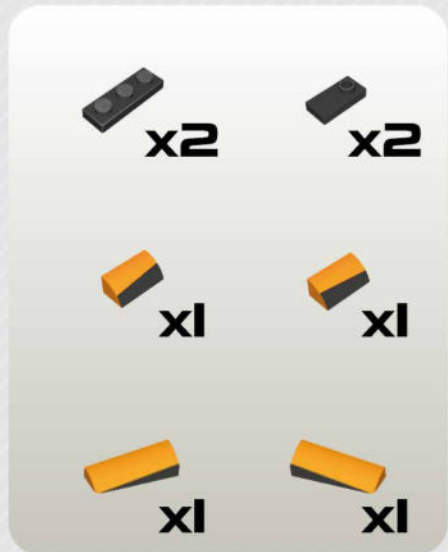
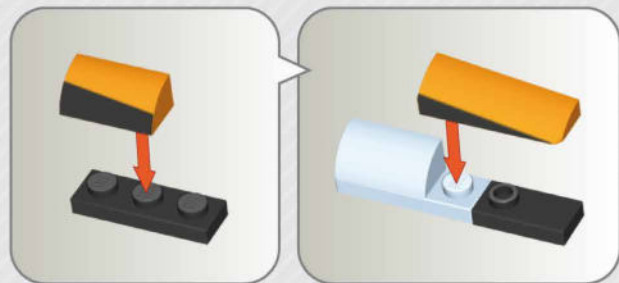
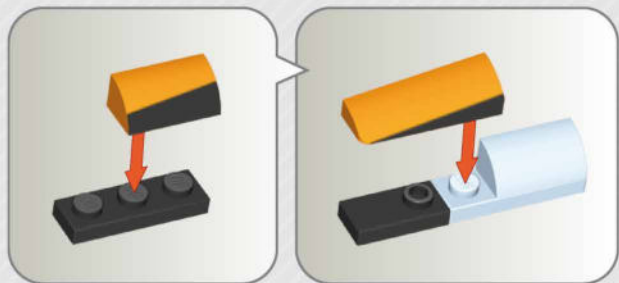

316

A

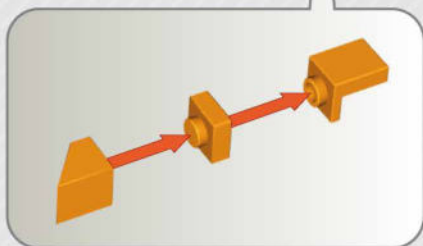
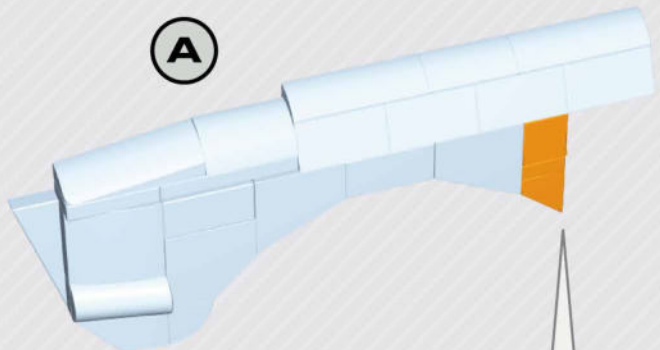

B

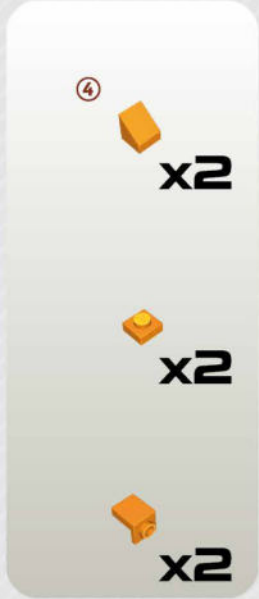
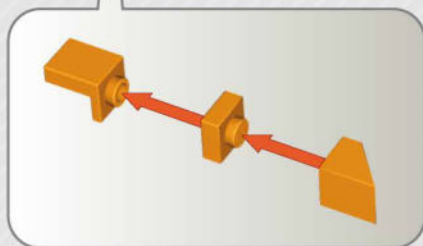
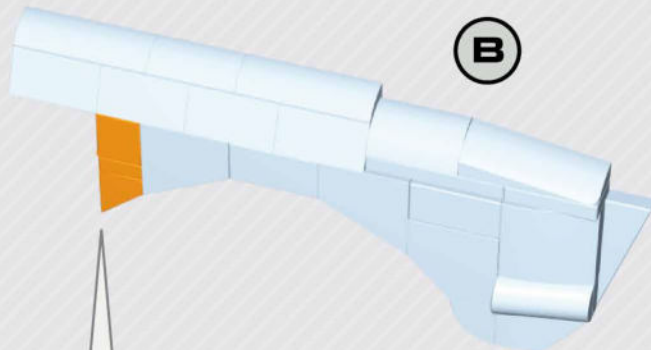

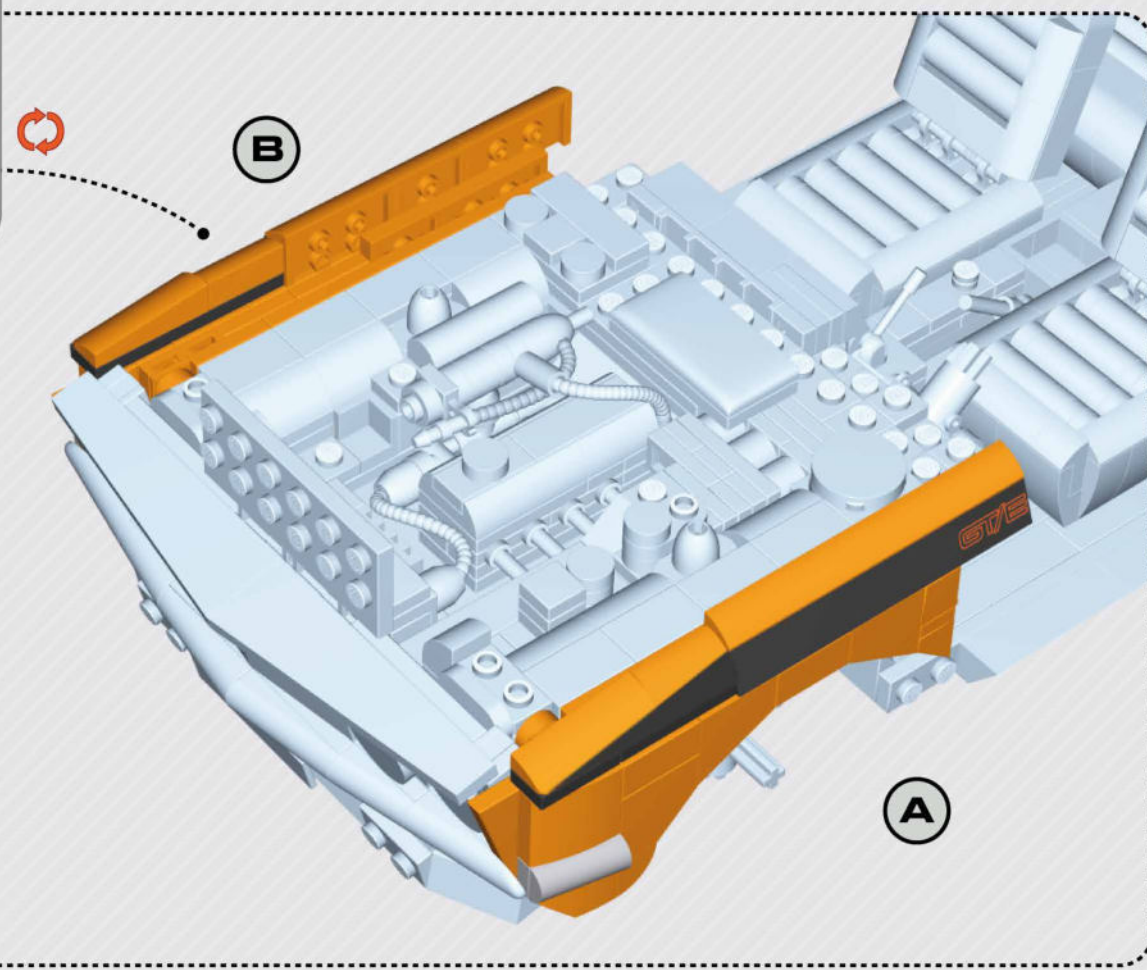

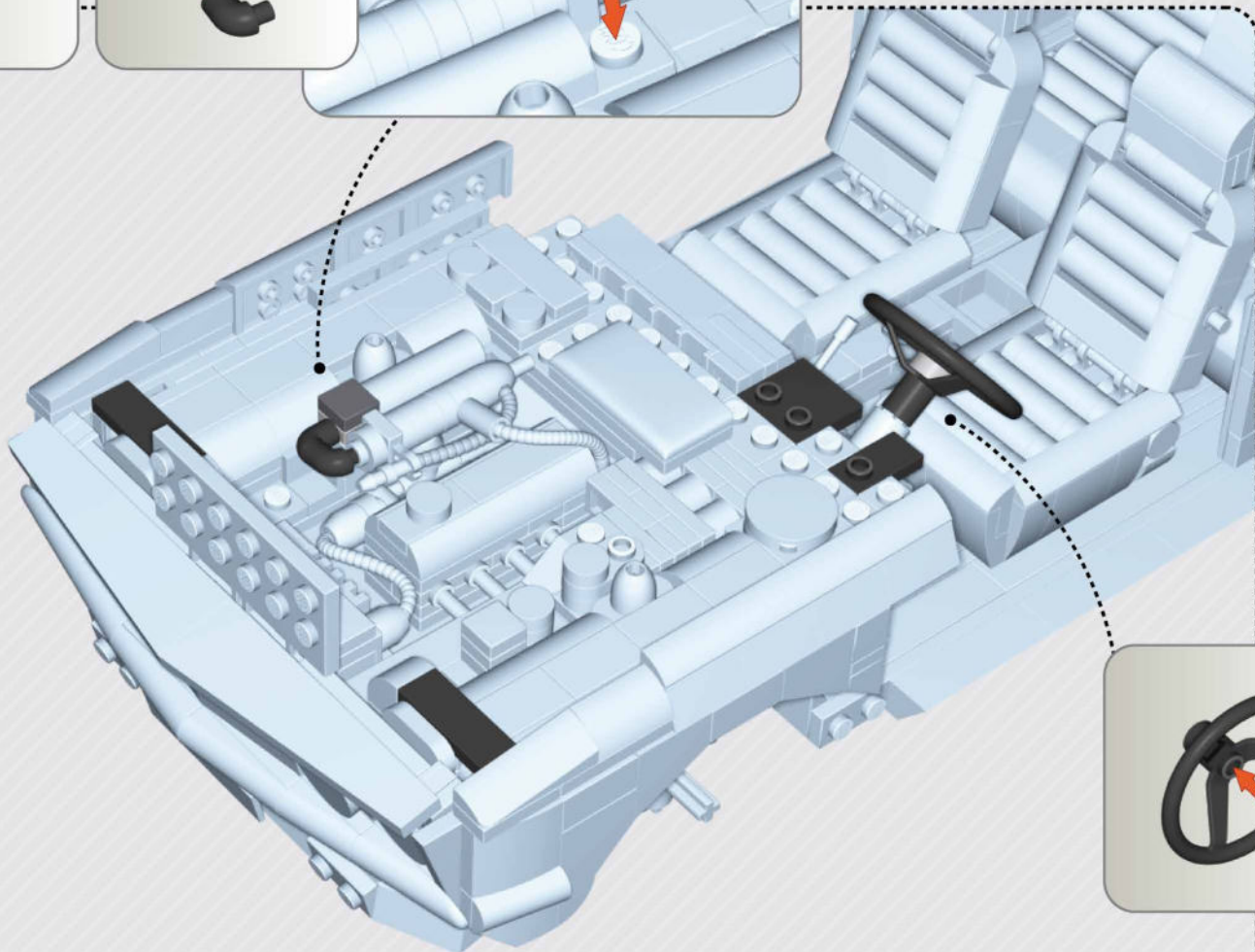
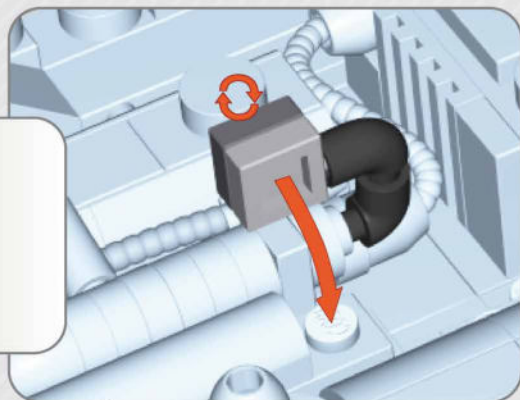
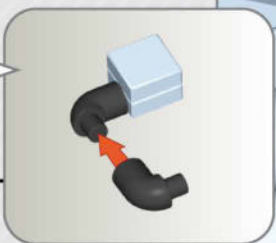
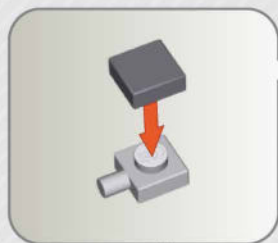

319



x2

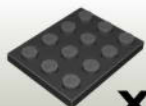

x4



x2

320



x6

321



x4

322



x4



x4

323

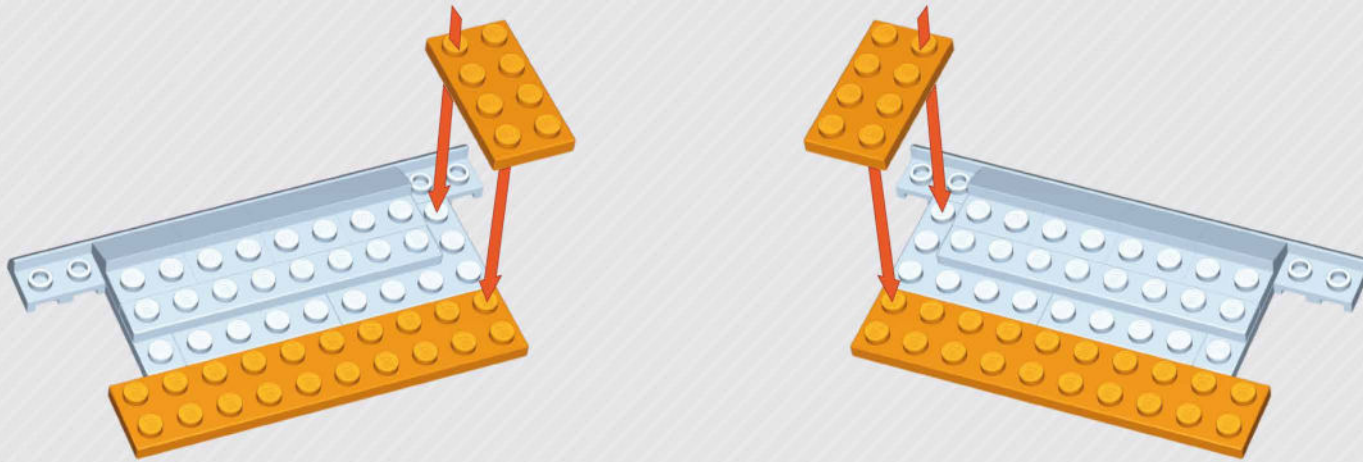

x2



x2

324



x2



x2

325



x2

326



327



328



329

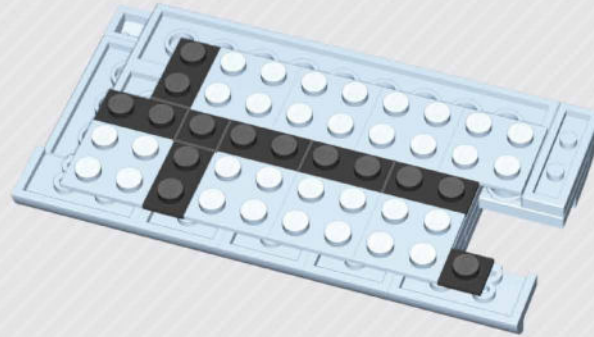

 x12

 x4

330

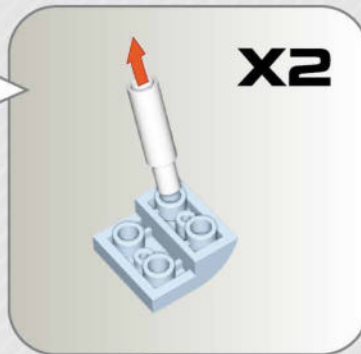

 x4

 x4

 x2

 x8

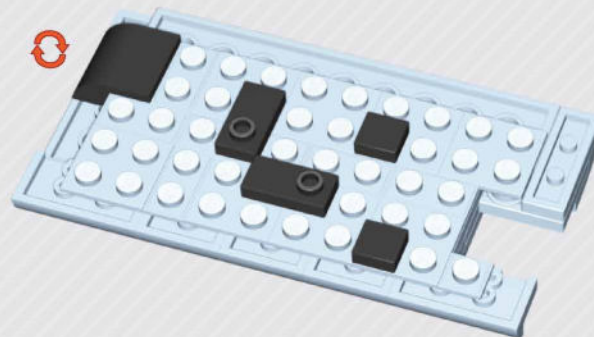

331

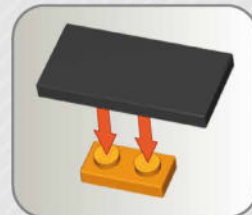
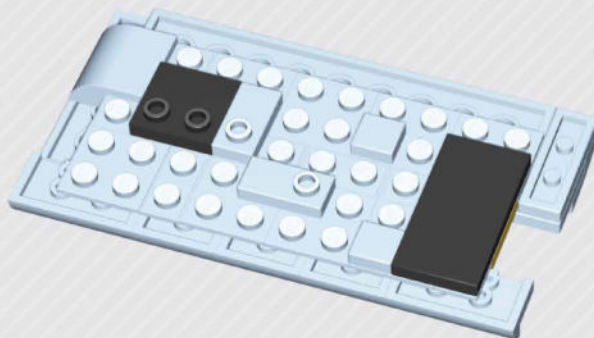
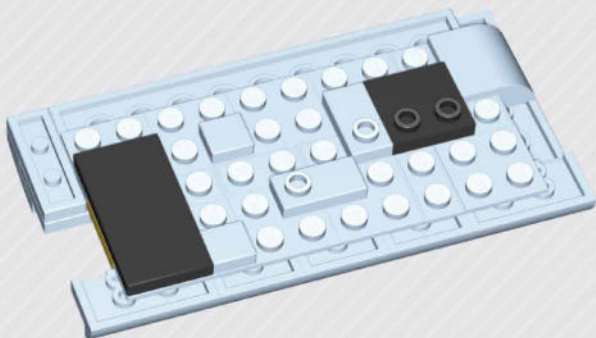
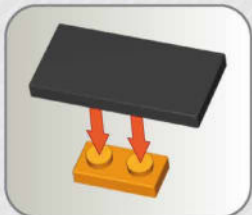

332

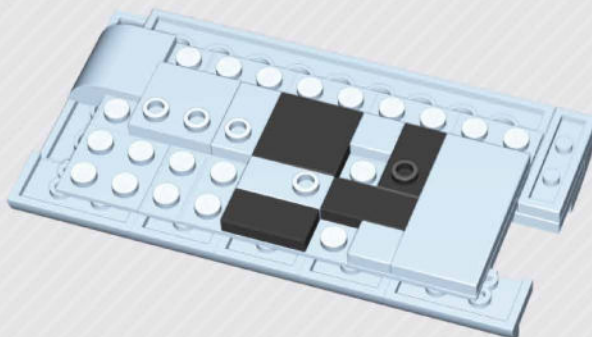
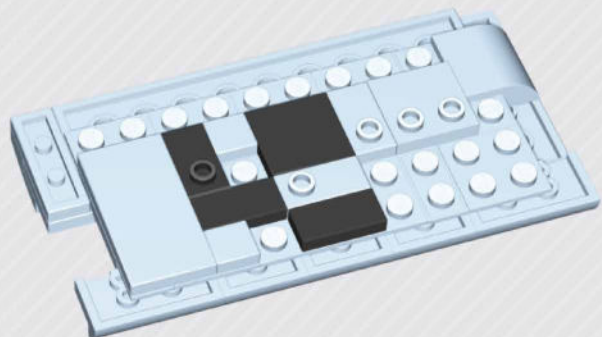

1:1



333

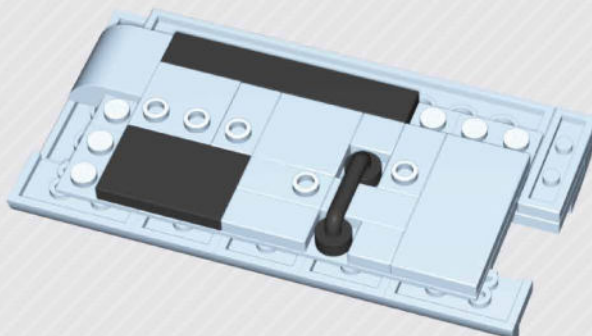
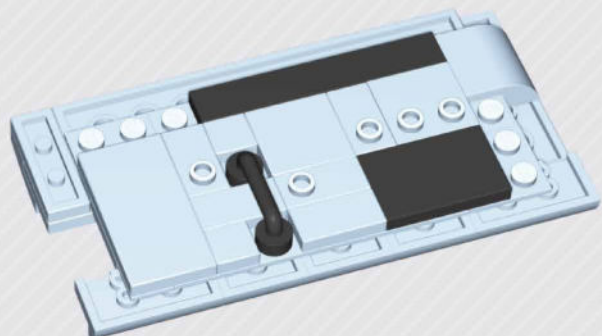

1:1



334

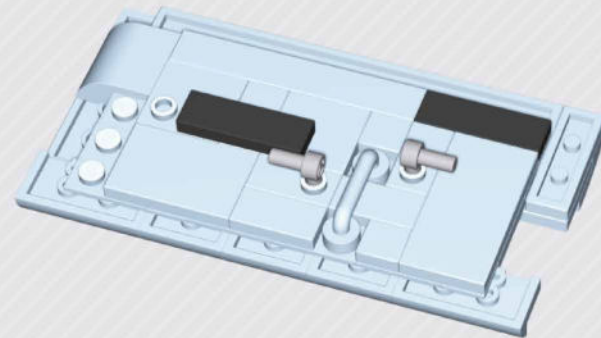
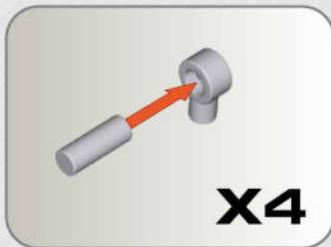
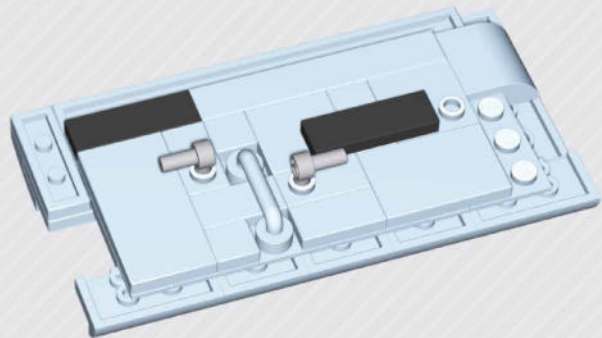

1:1



1:1



335

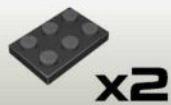
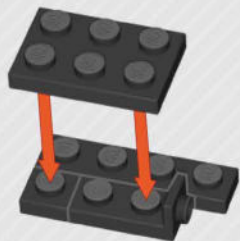

336

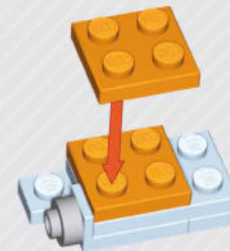
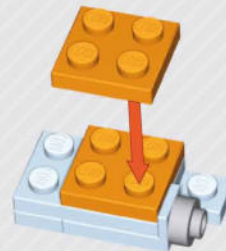

337

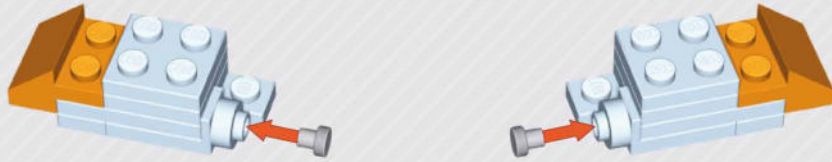

x2



x2

338

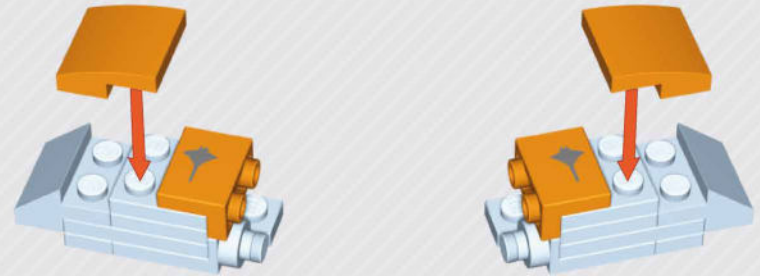

x2



x1



x1

339



x2



x2



x2

340



x2



x2

341



x2



x2



x2

342

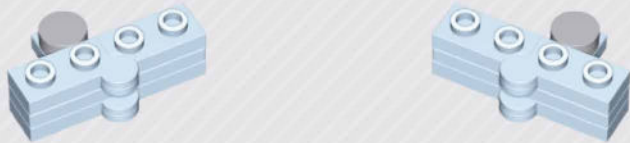

343



344

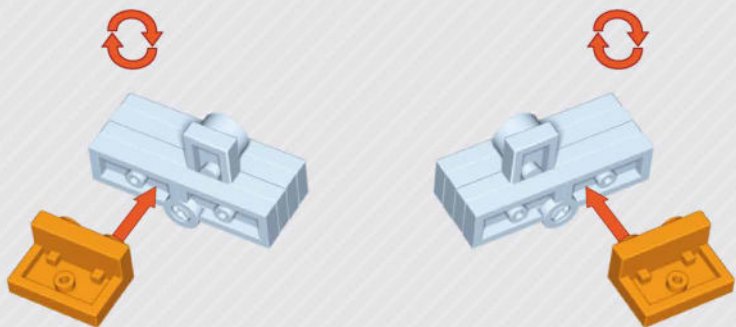

345

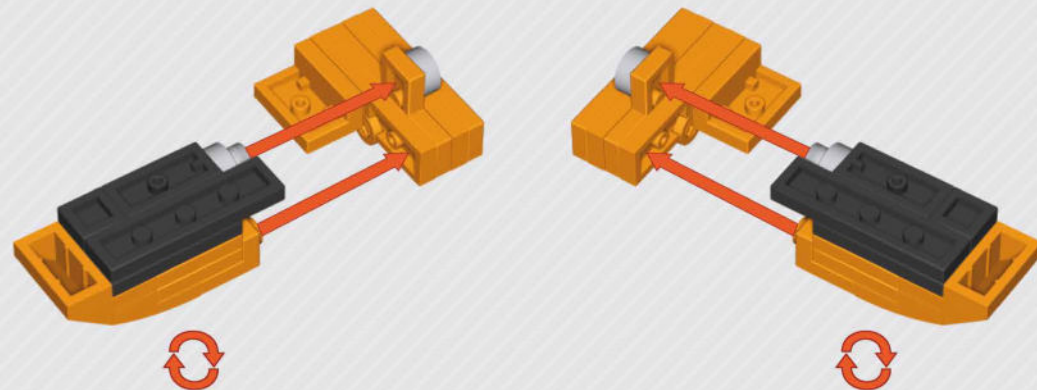

346

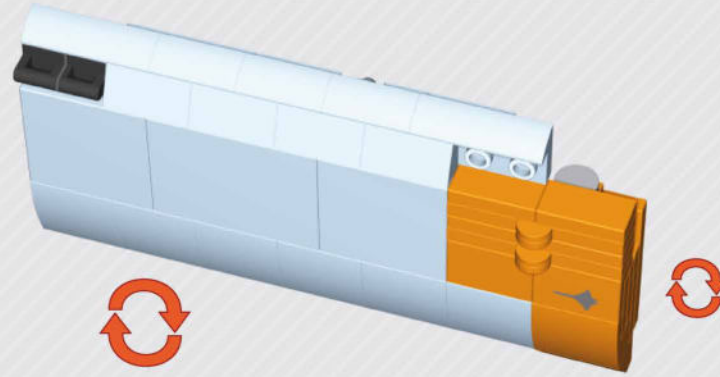
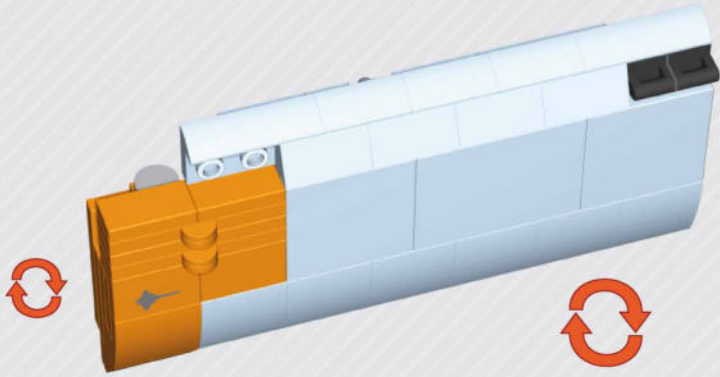

347

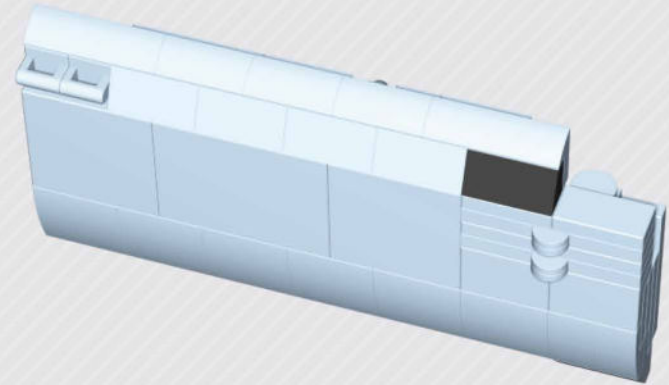
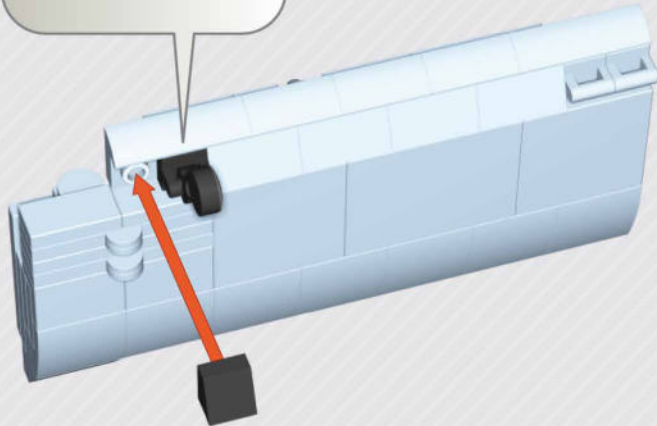

348

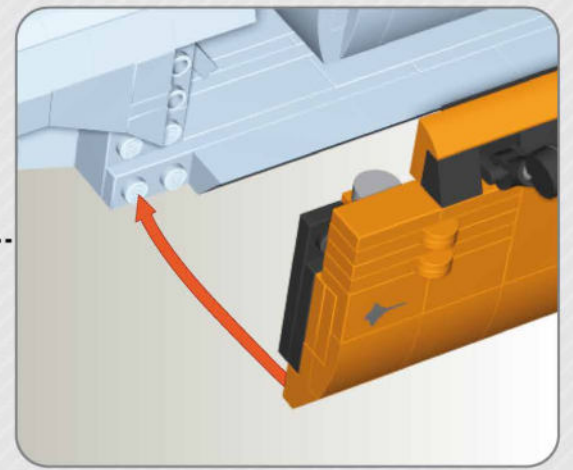
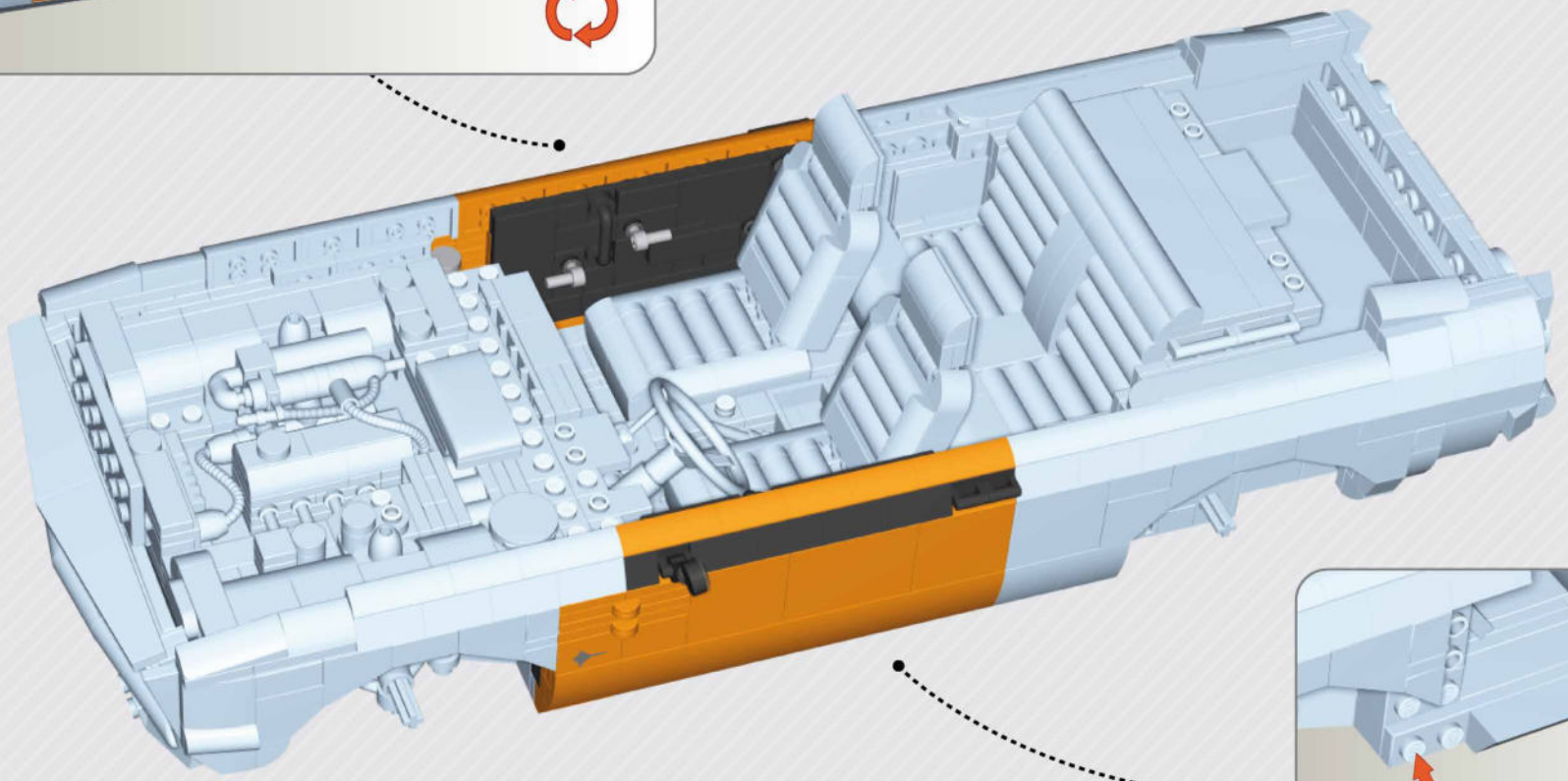
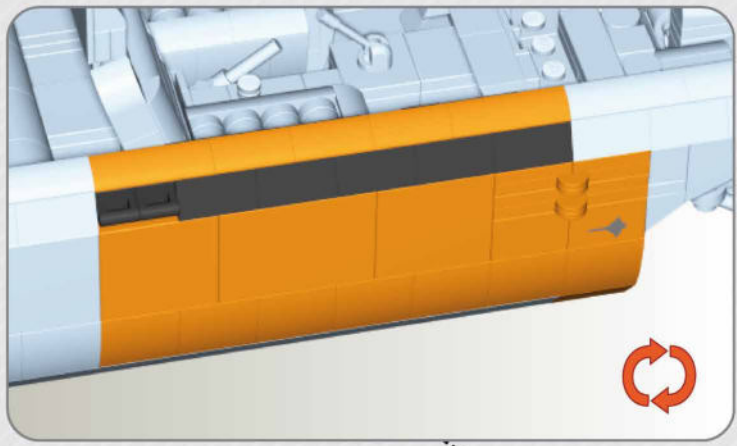

349

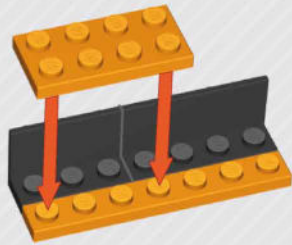

350

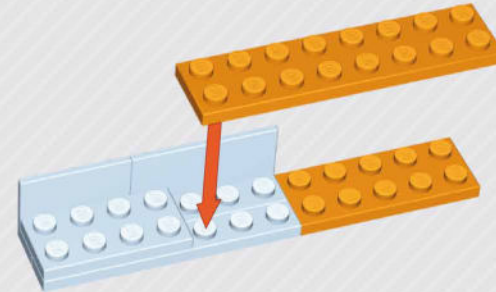

351

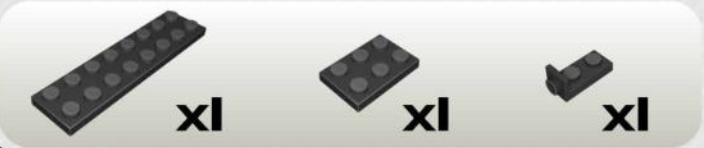

352

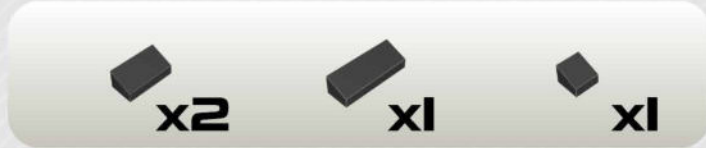
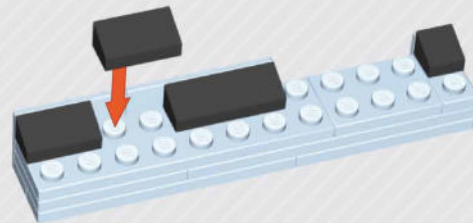

353

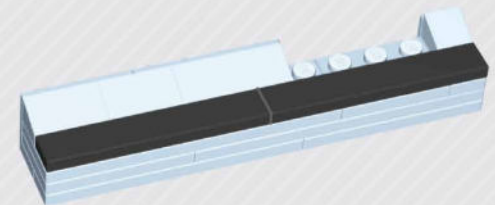

354



x1



x1

355

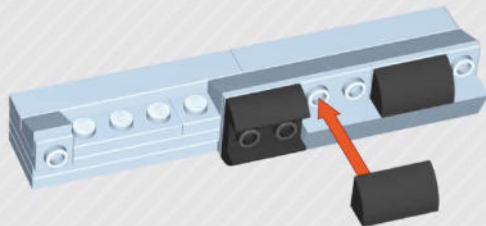

x1



x2

356

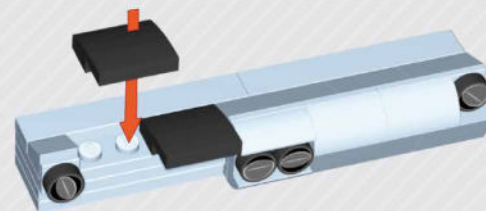

x2



x2

16



x2

357

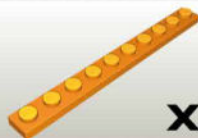
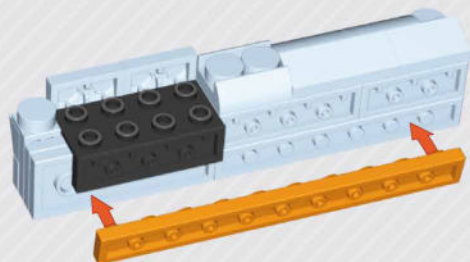

x1

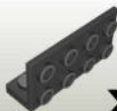

x1

358

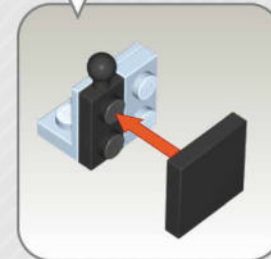
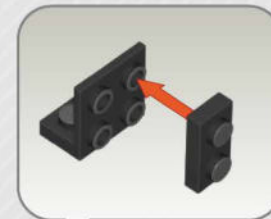
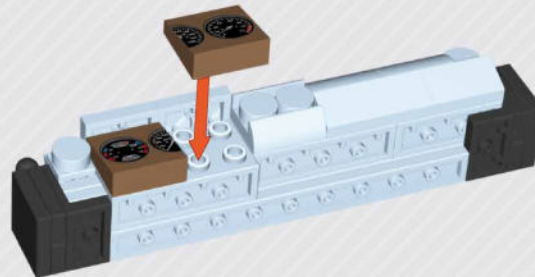
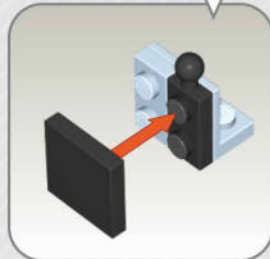
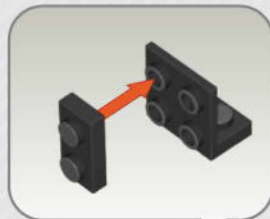

x2



x2



x2



x2



x1



x1

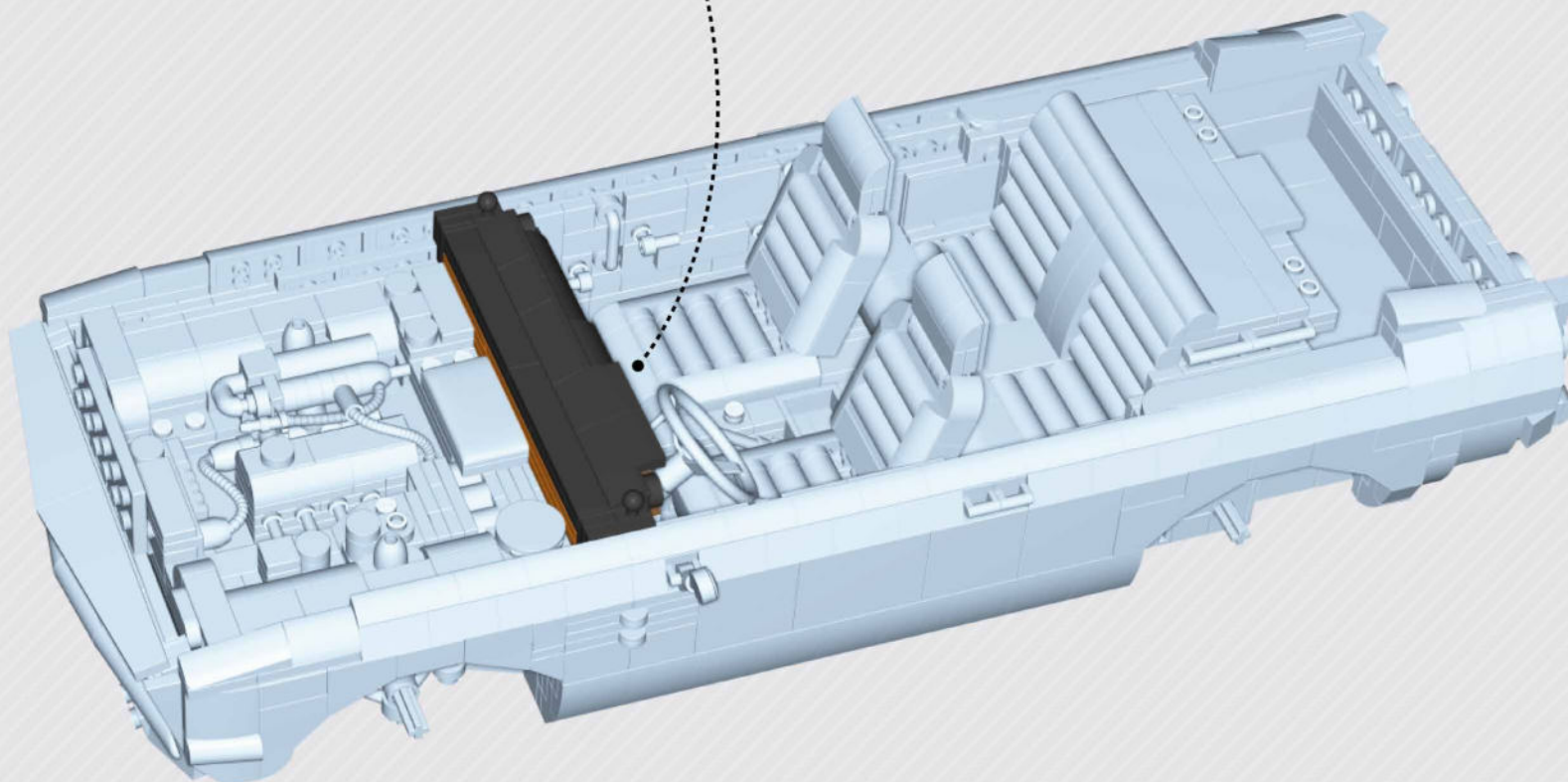
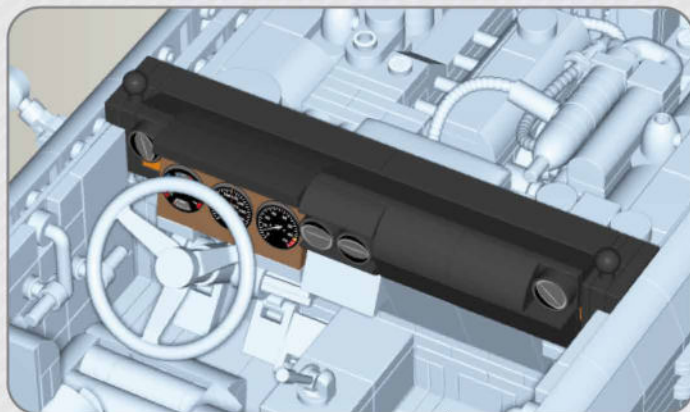



360

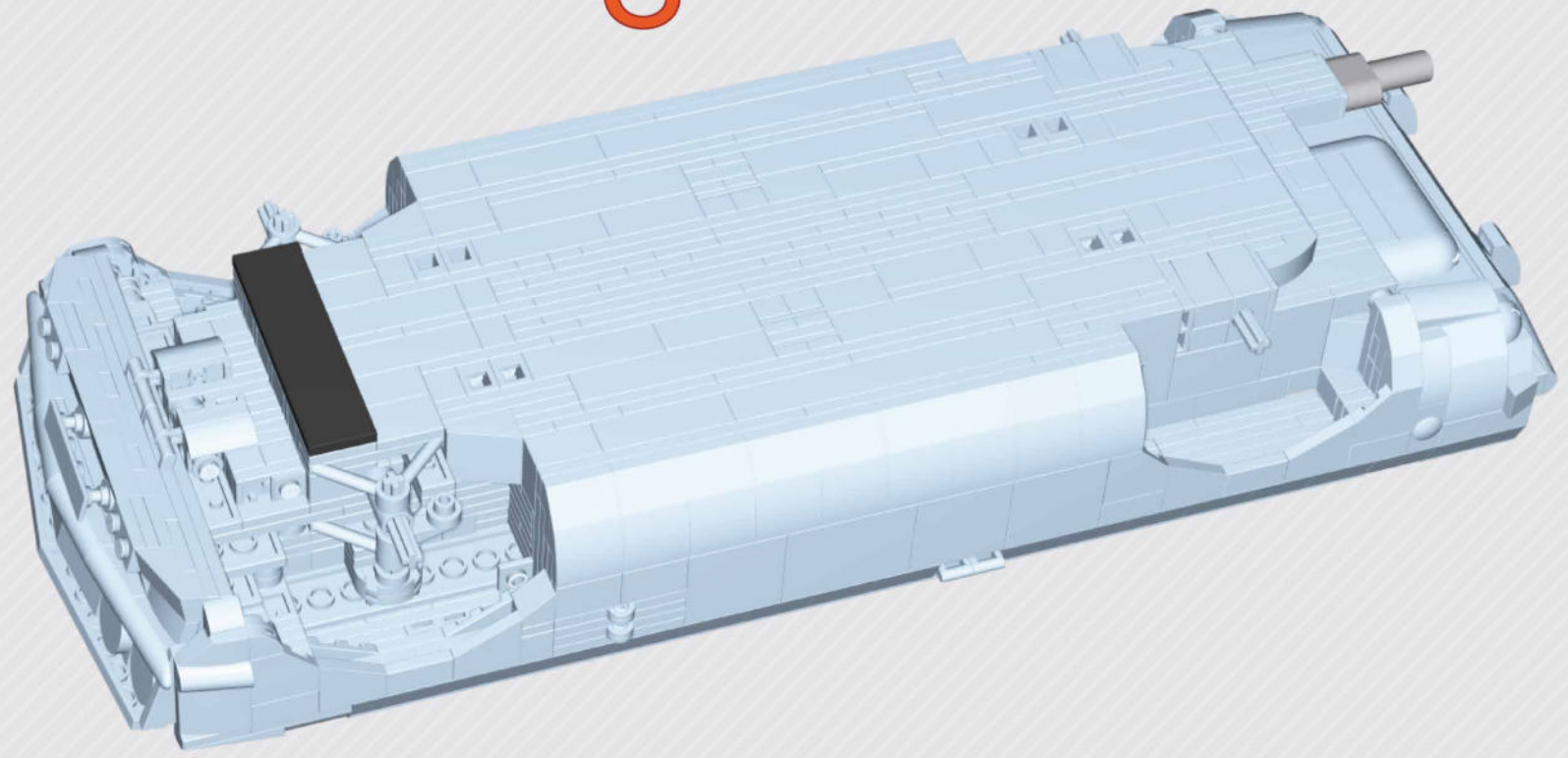
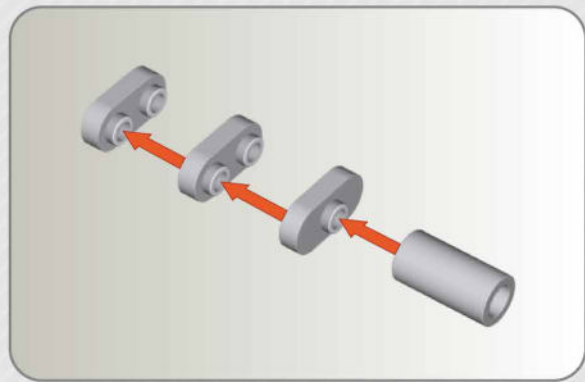

-  x1
-  x2
-  x1
-  x1

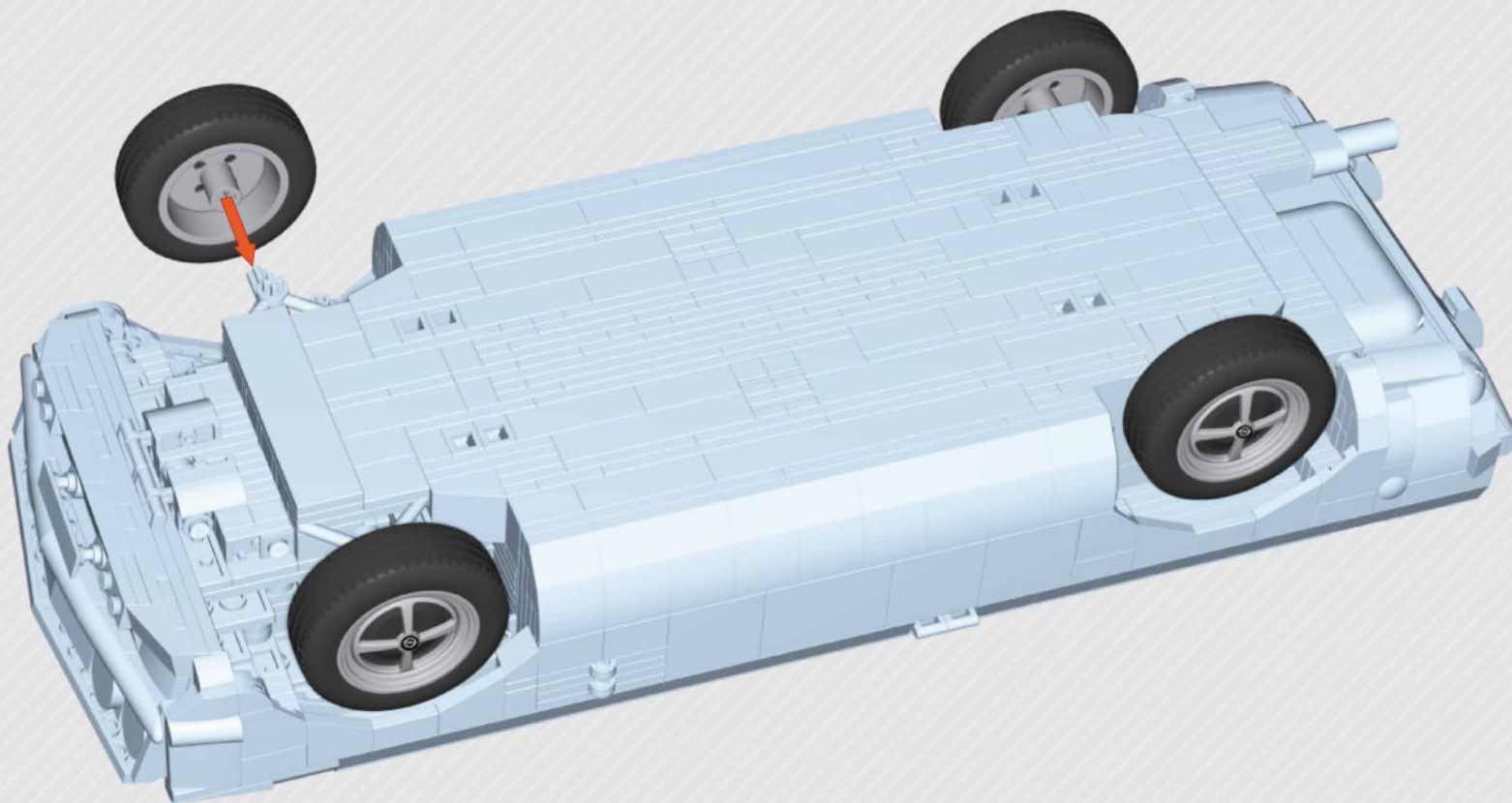

362

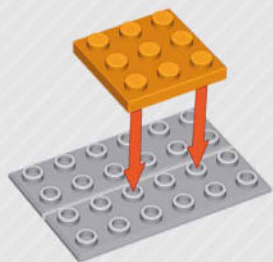

363

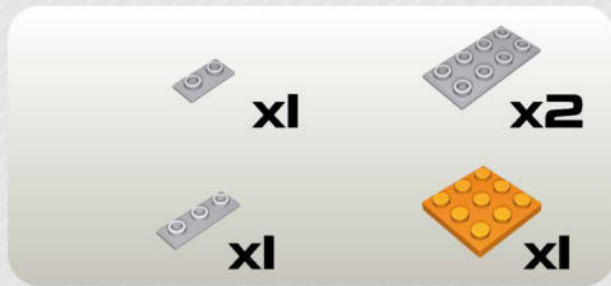
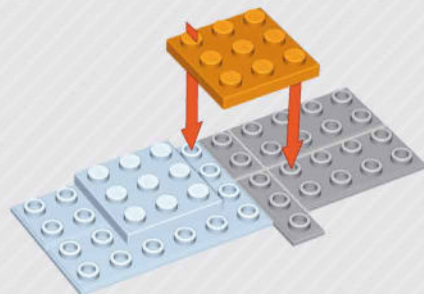

364



365



366

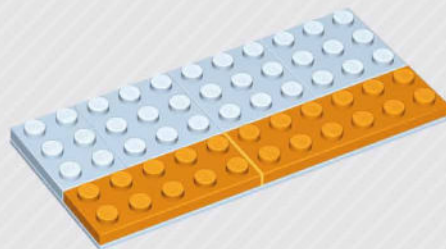

367



368

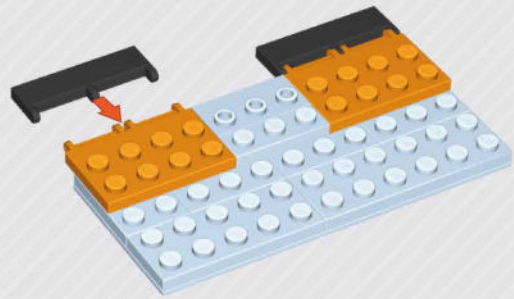

x2



x2

369

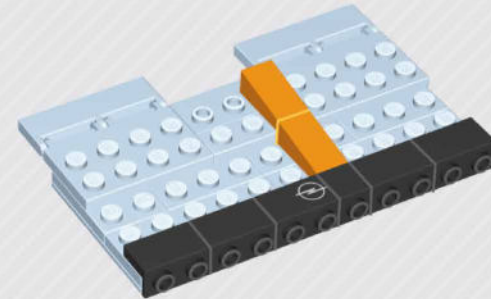

12



x4



x1



x2



x1

370

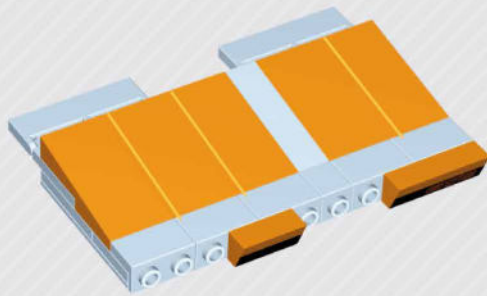

x5



x1



x1

371

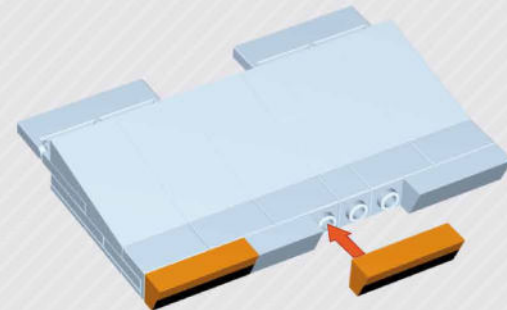

x2

372

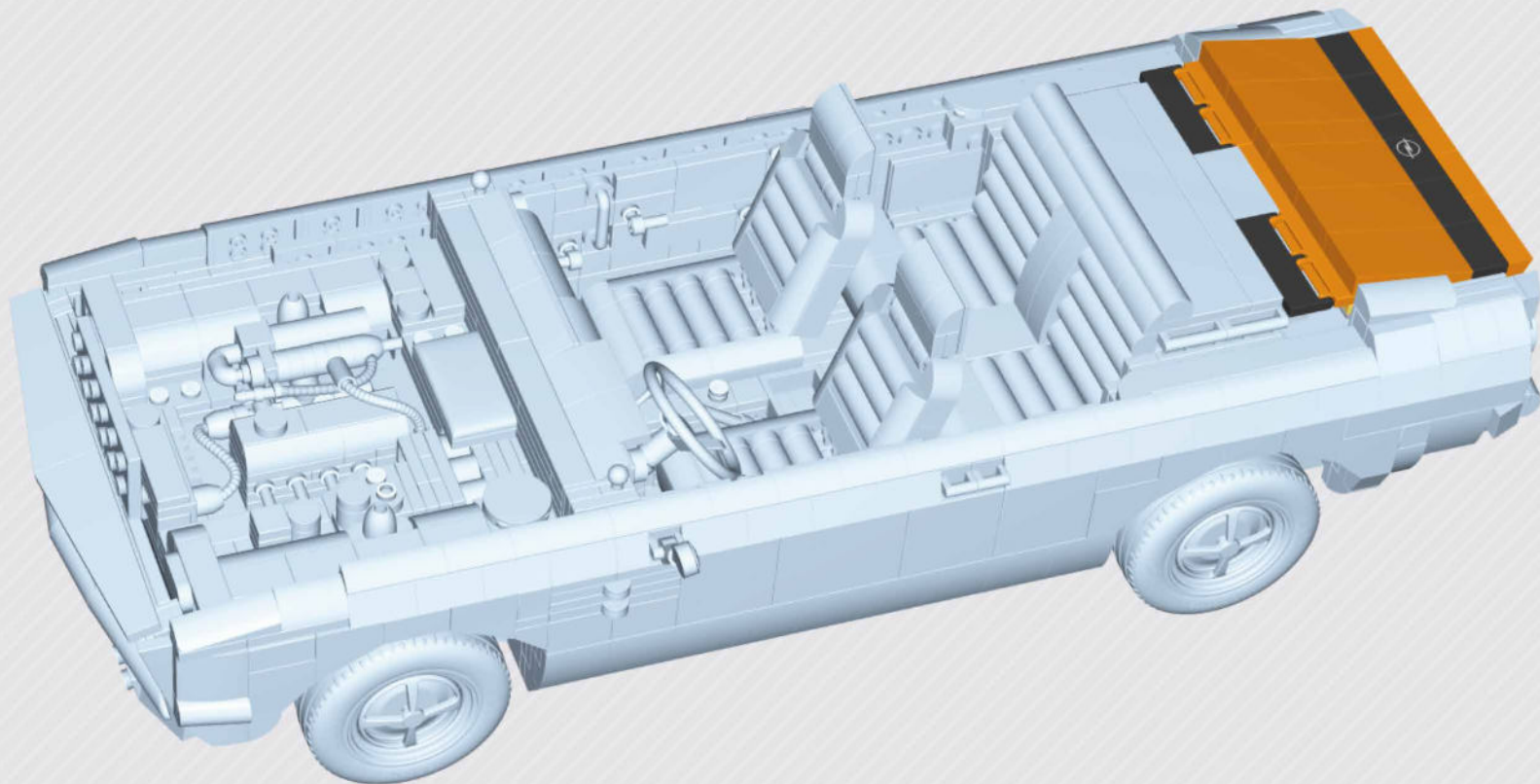

373

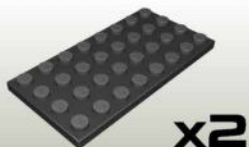
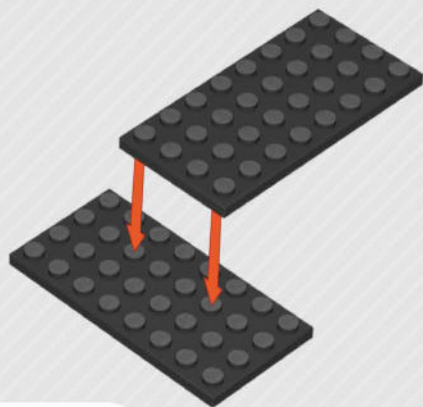

374

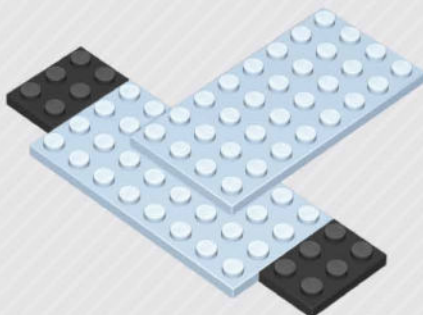

375

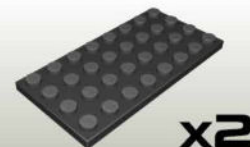
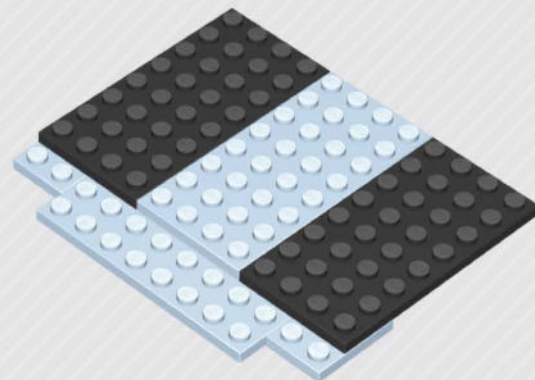

376

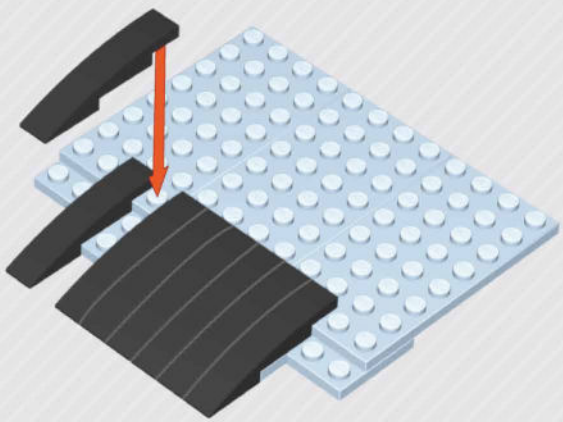

377

A

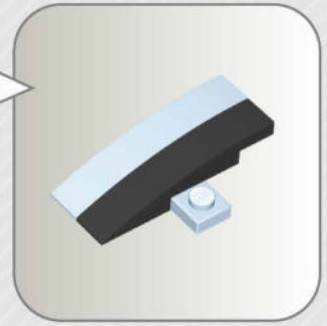
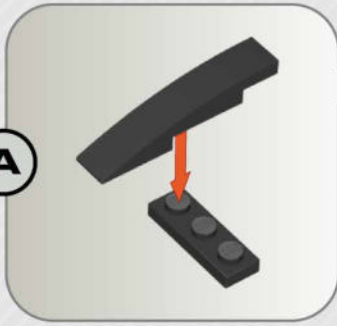

B

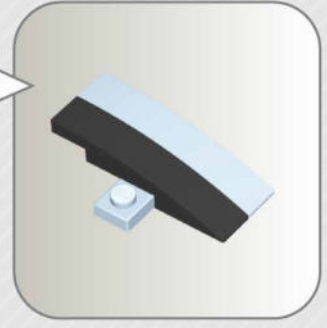
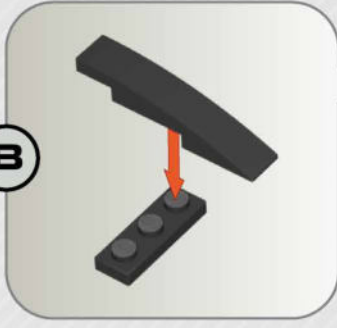

378

B

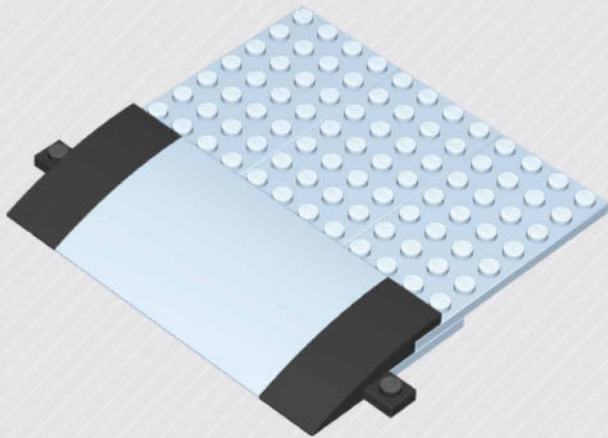

A

379



x2

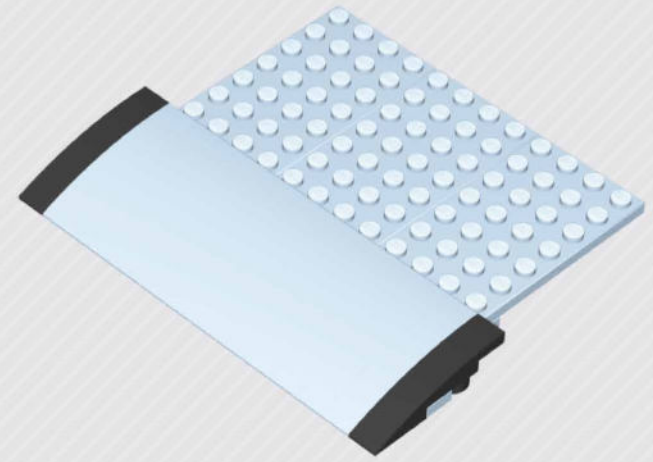

380

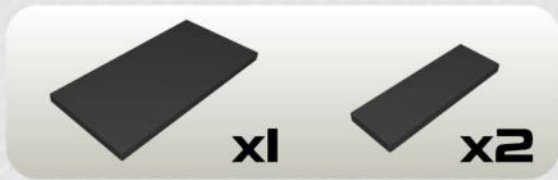
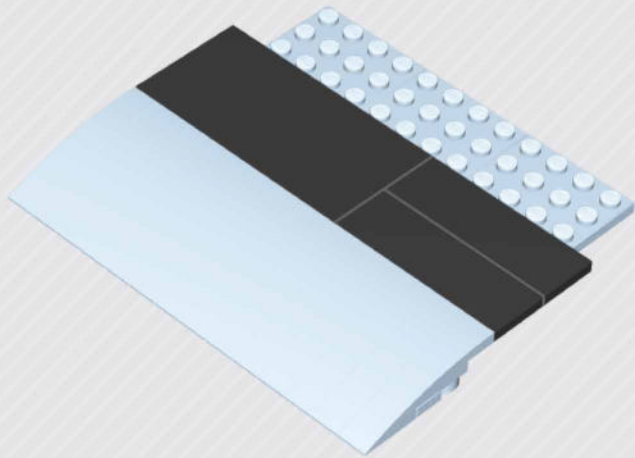

381

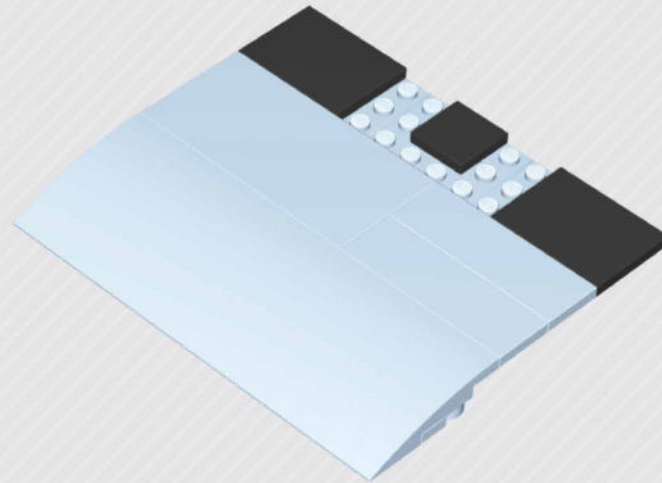

382

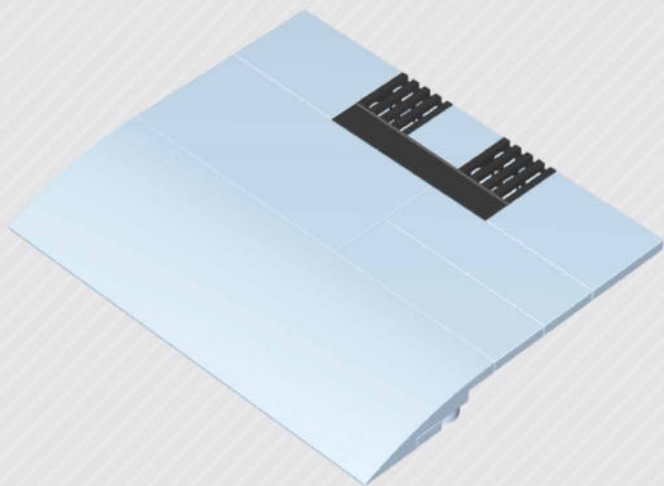

1:1



383

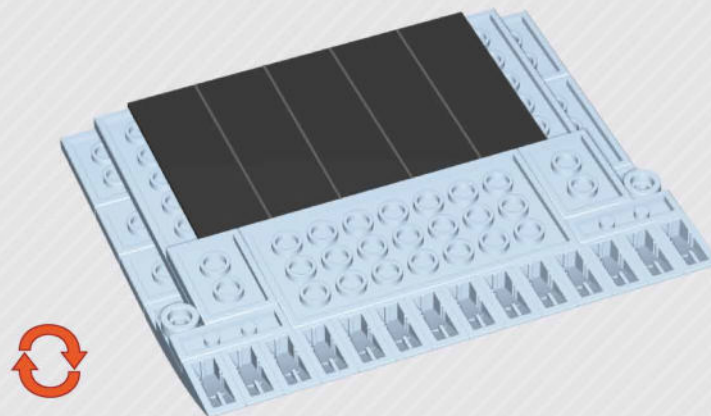

384

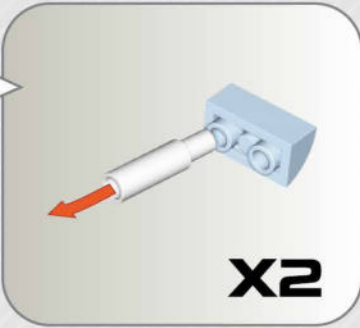
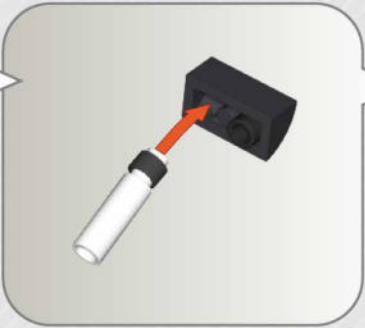

X2

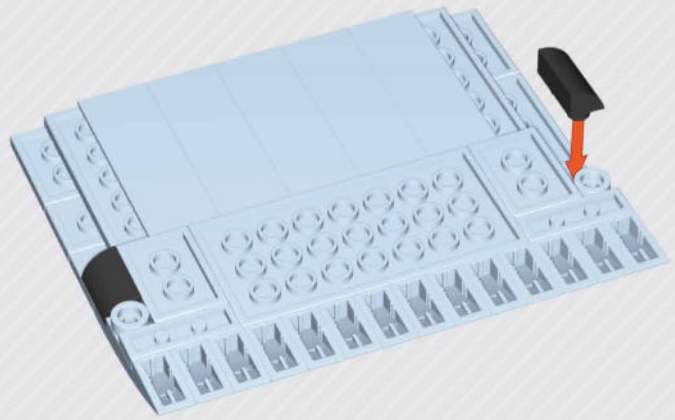

385

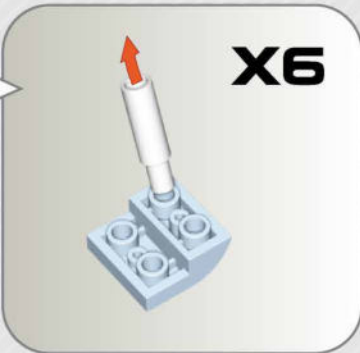

X6

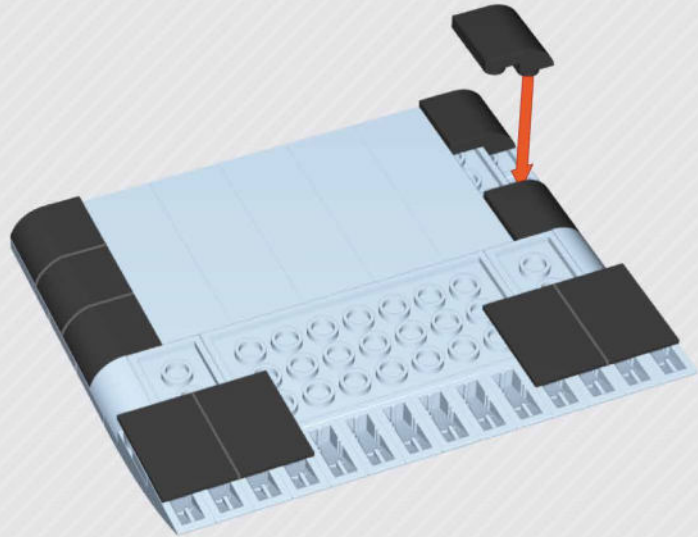

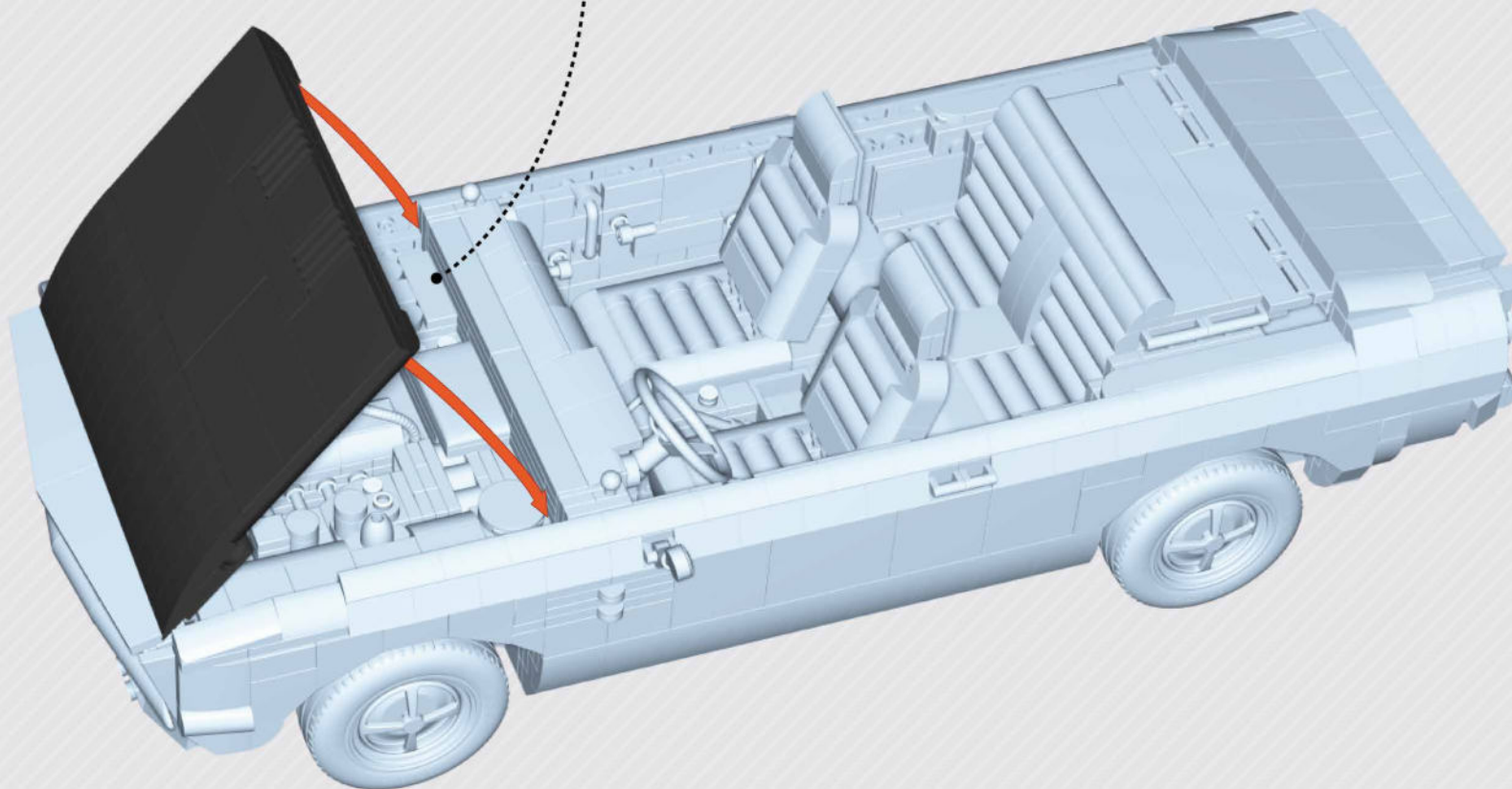

387

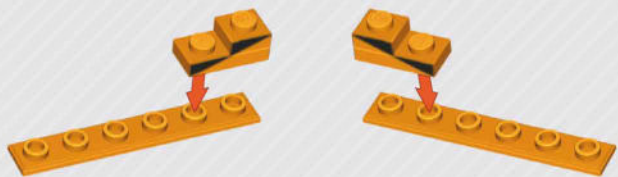

388



389

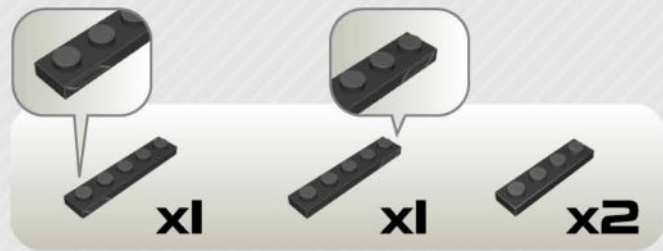

390

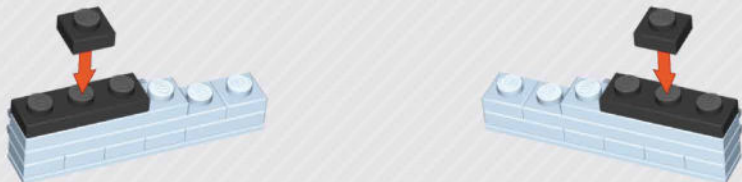

391

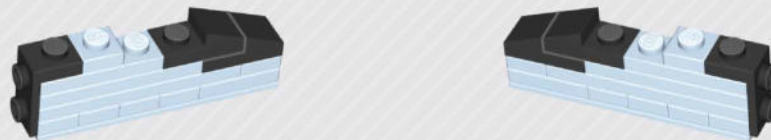

392



 x2

 x4

393

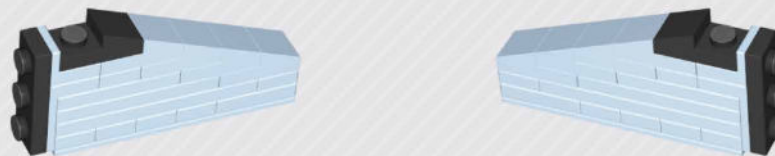

 x2

 x2

394



 x2

 x2

395

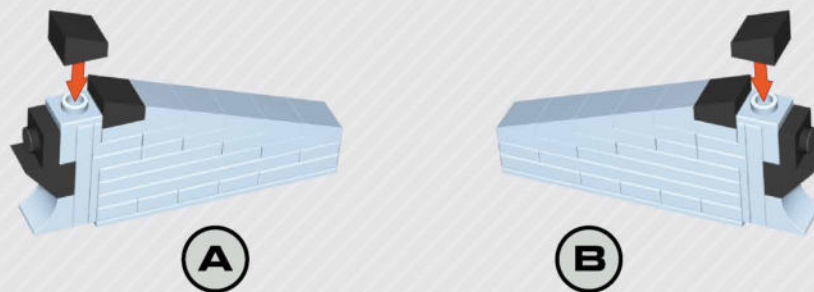

A

B

 x2

 x4

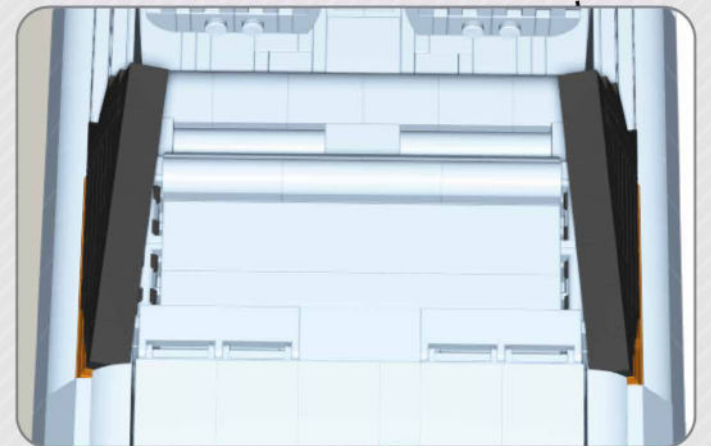
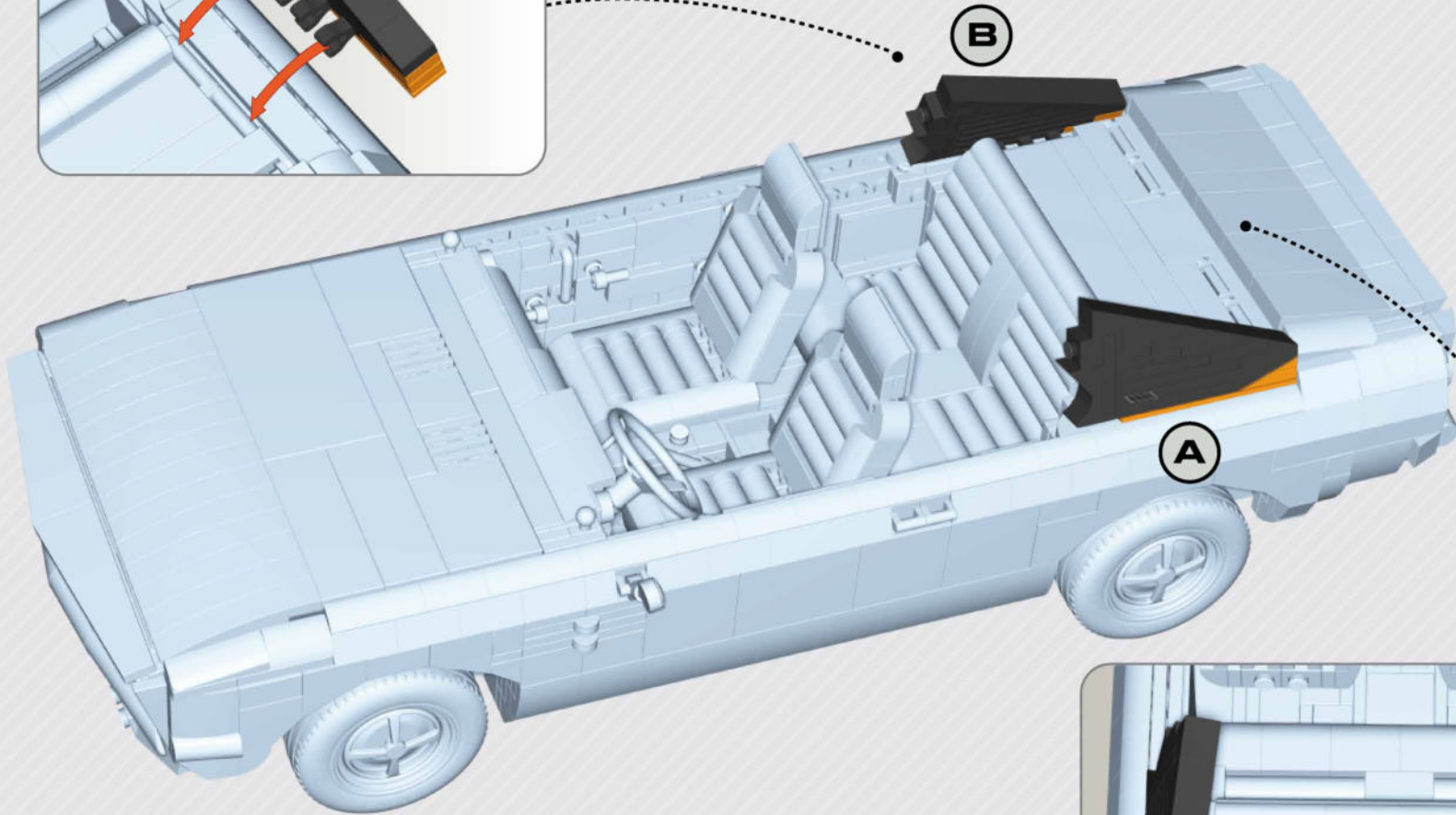
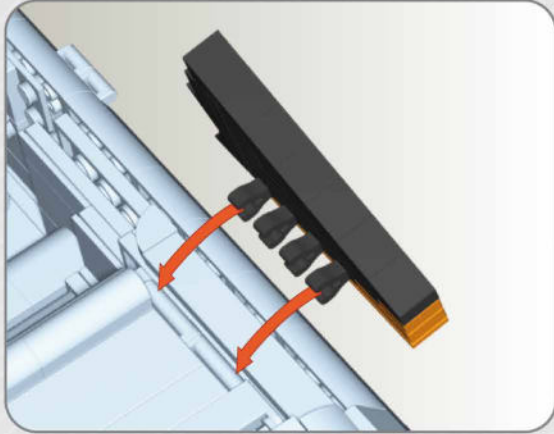

397

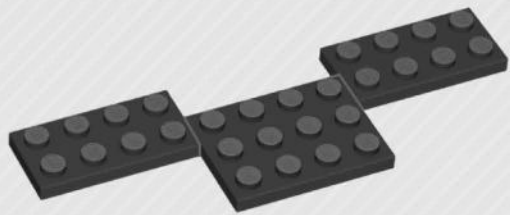

398

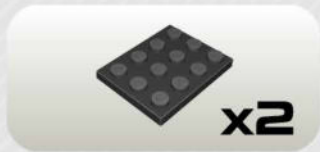

399



400

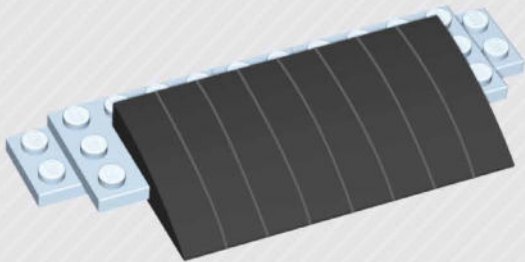

401

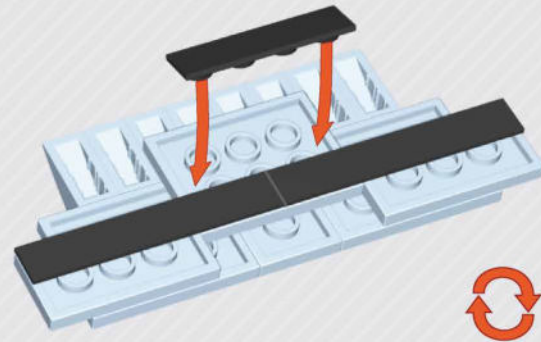



- 1:1
- x4
 - x2
 - x2
 - x2
 - x2
 - x1
 - x2
 - x2
 - x2
 - x2
 - x2
- 10

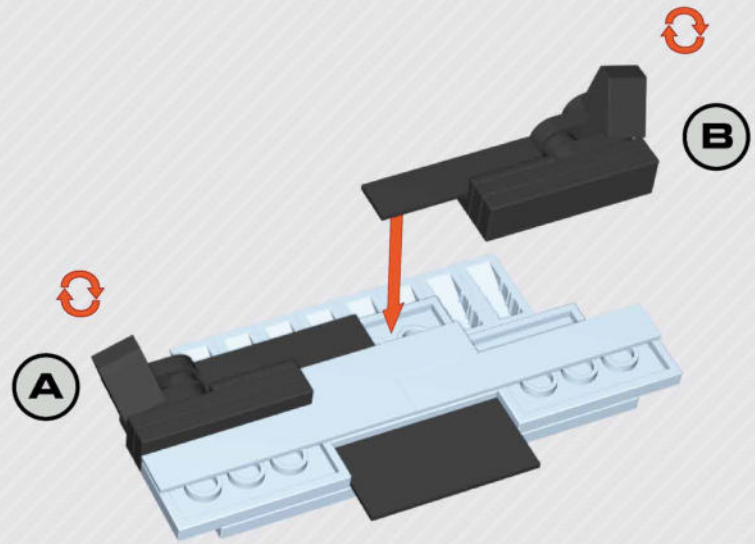

403

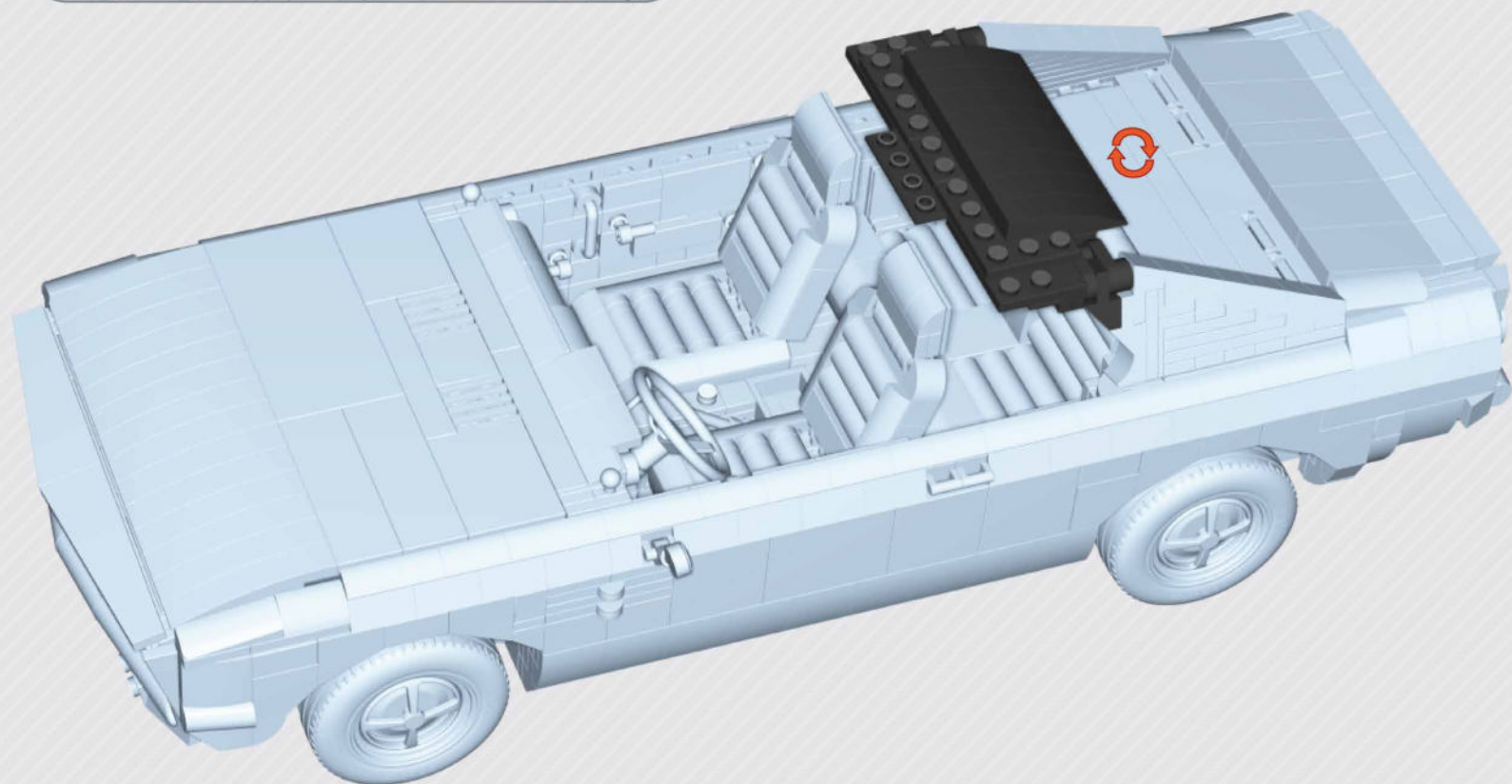
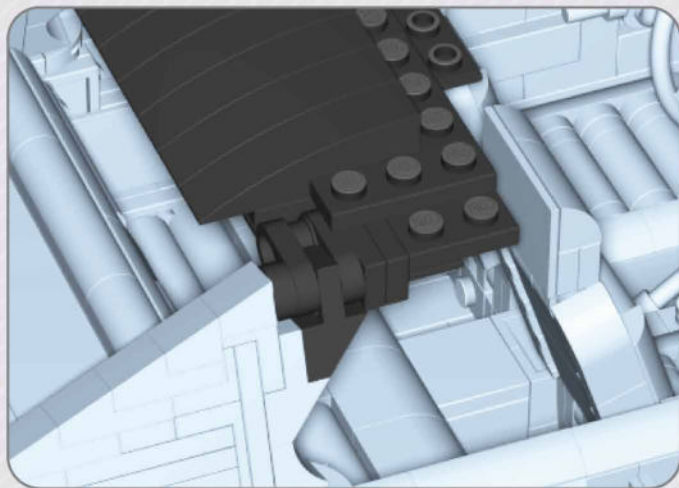

404

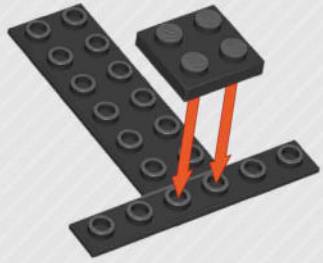

405

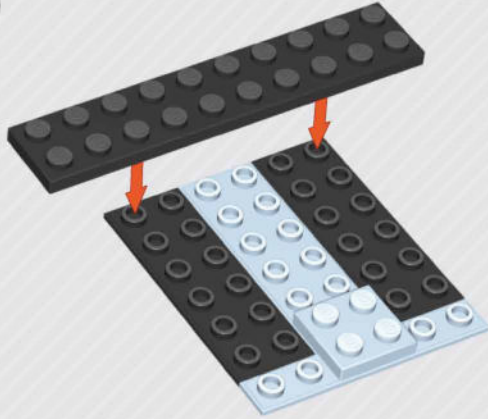

406

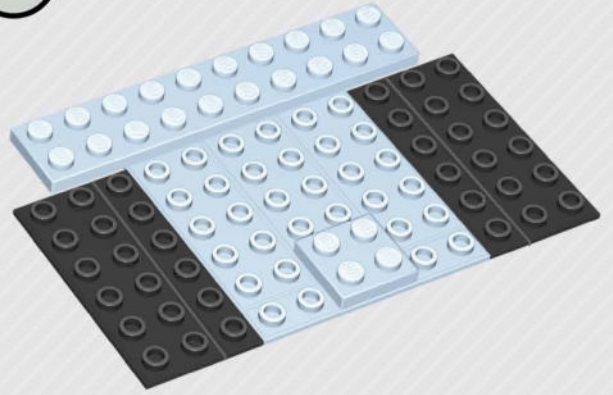

407

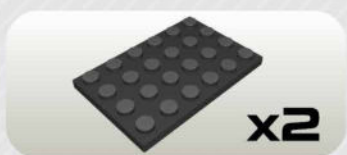
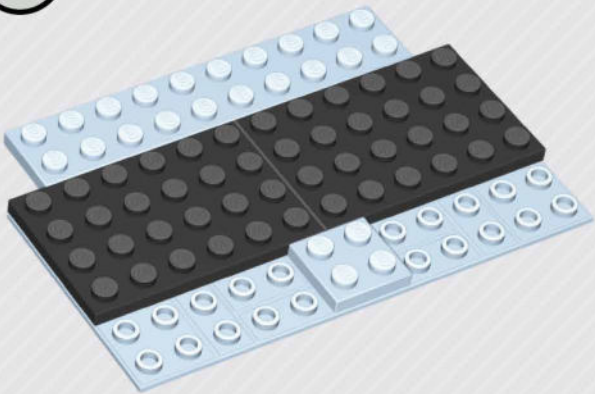

408

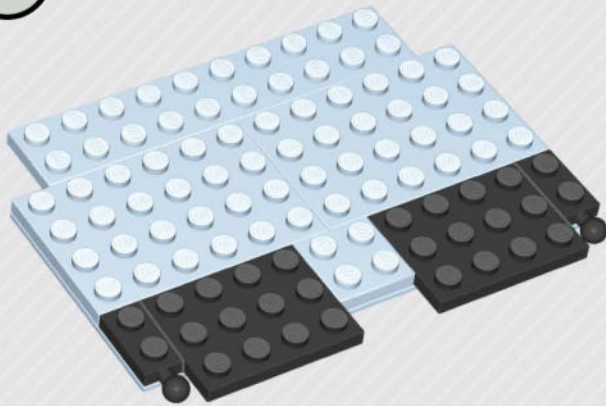

409

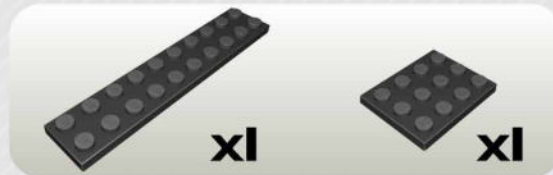
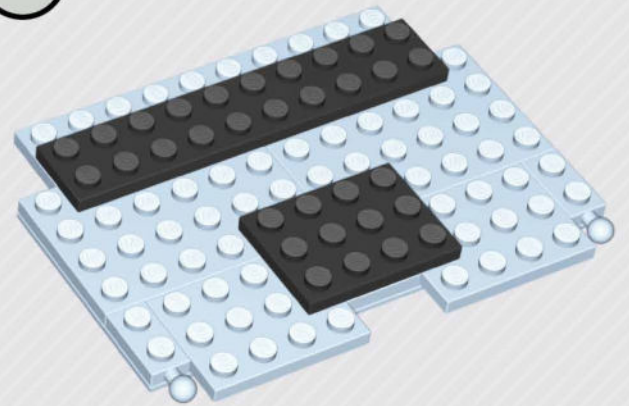

410

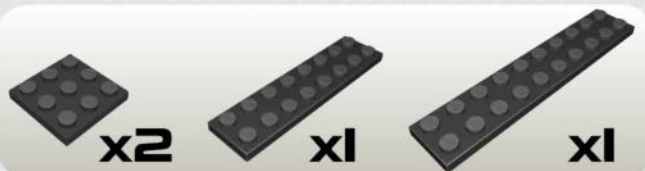
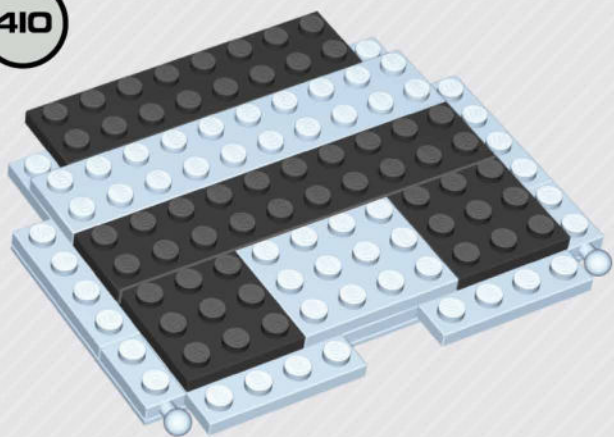

411

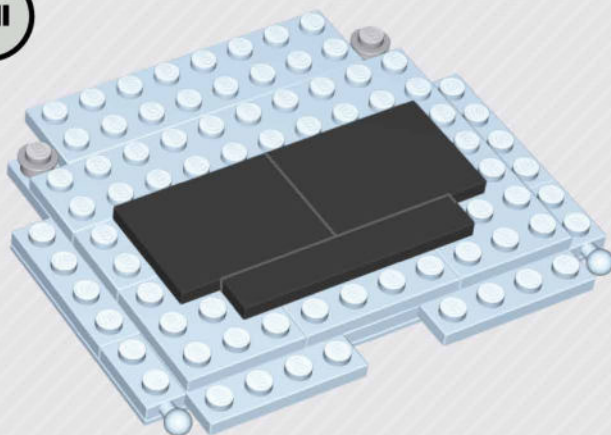

1:1



412

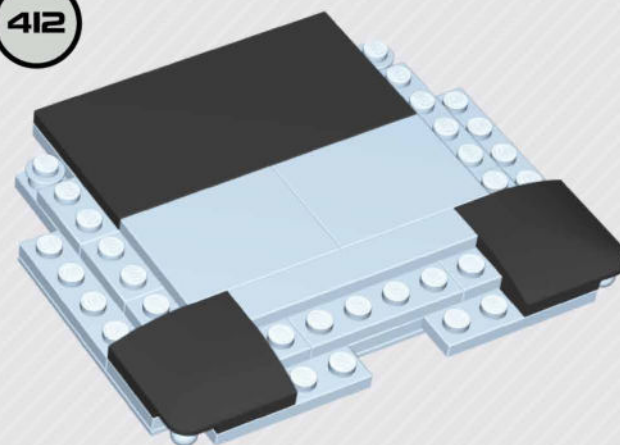

413

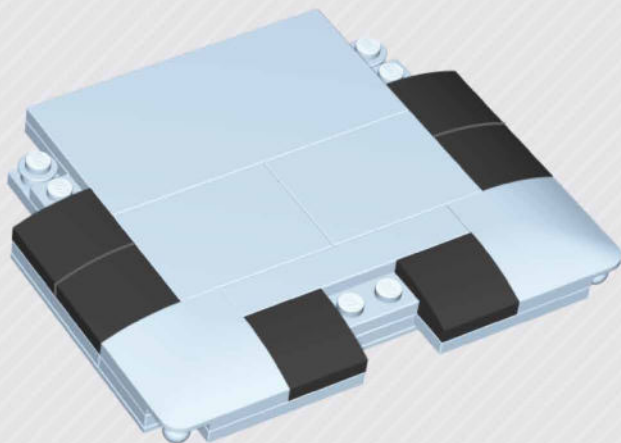

414



415

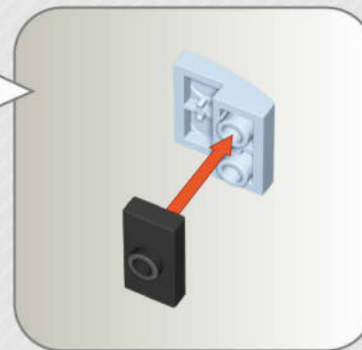
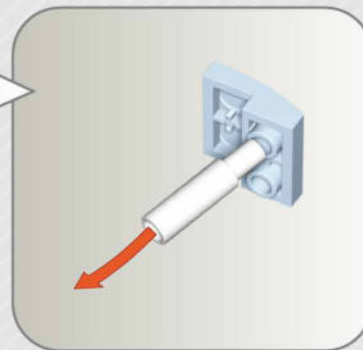
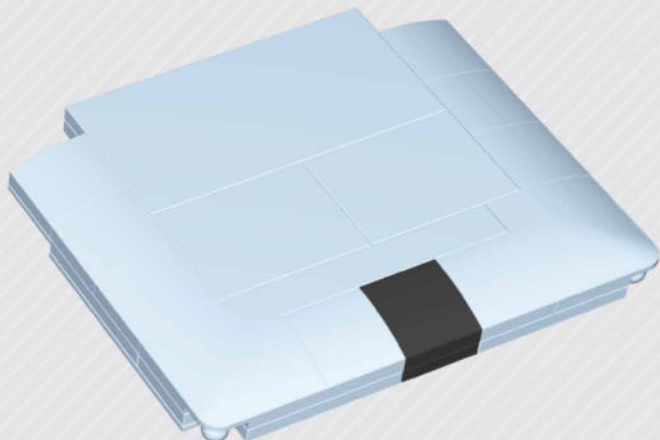

416

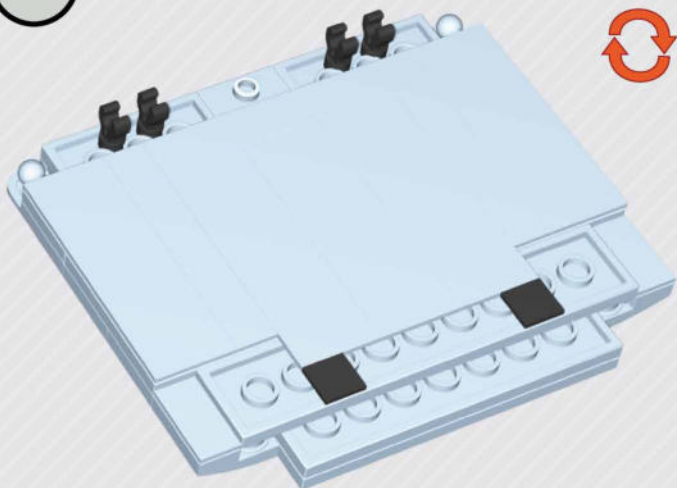

417

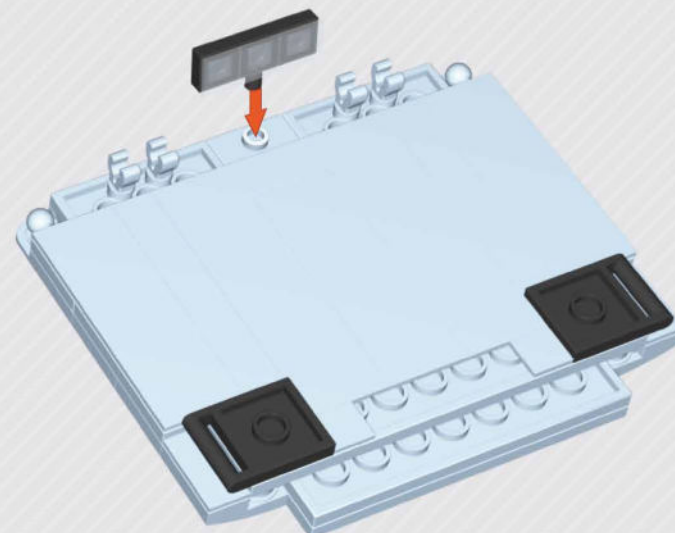
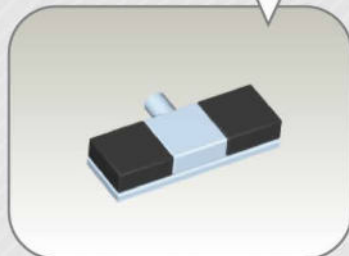
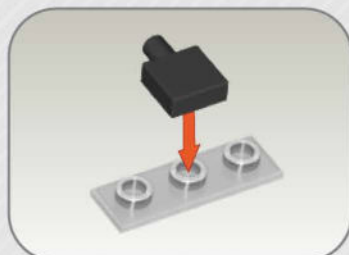

418

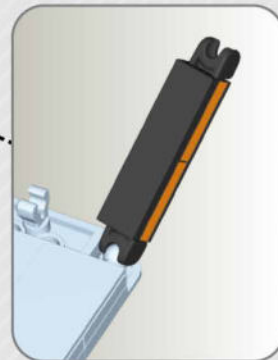
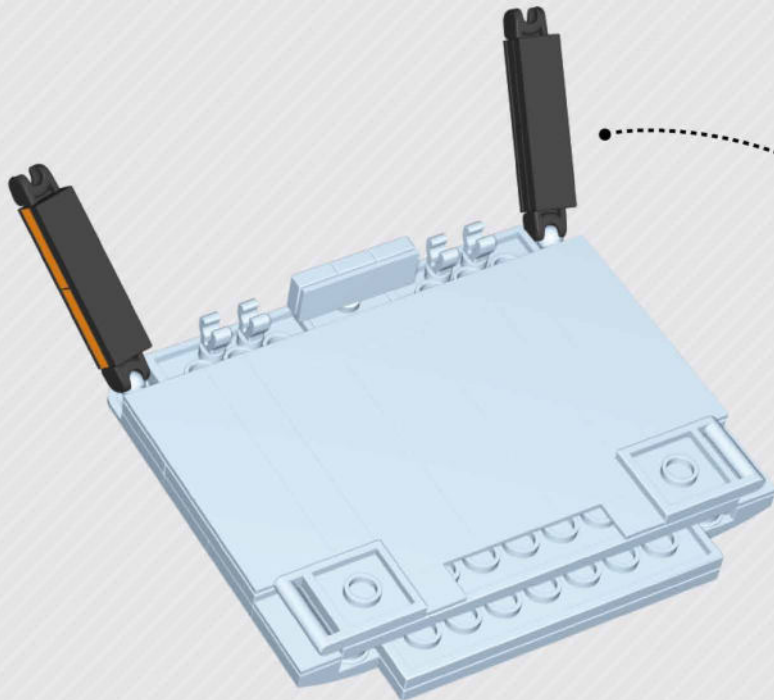
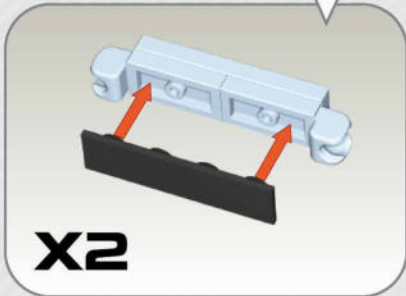

1:1



419

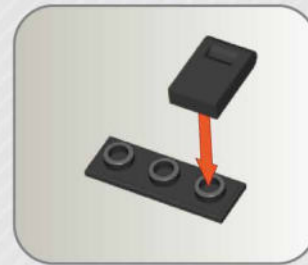
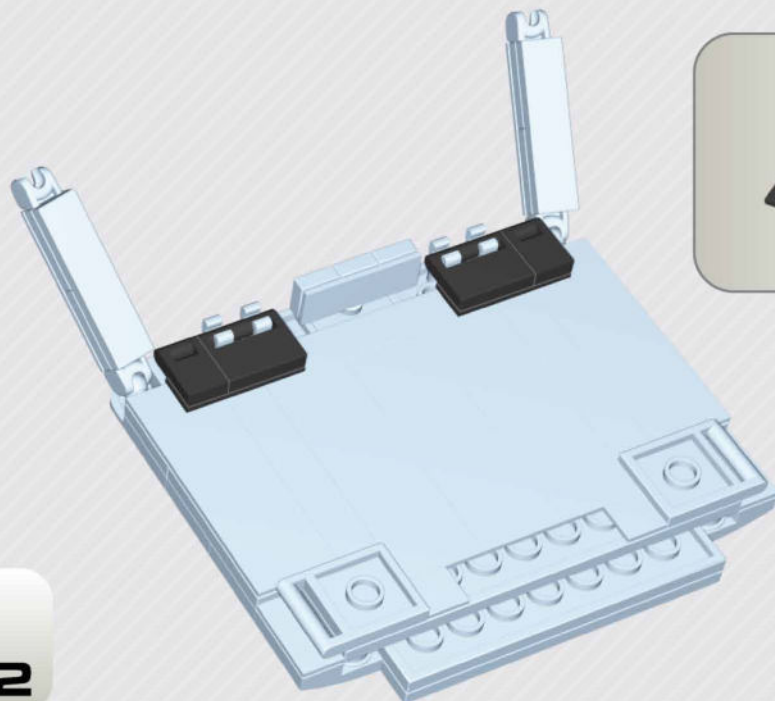
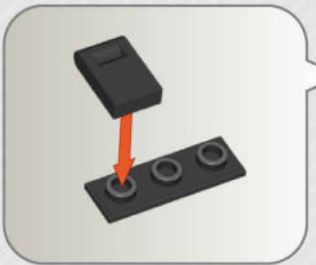

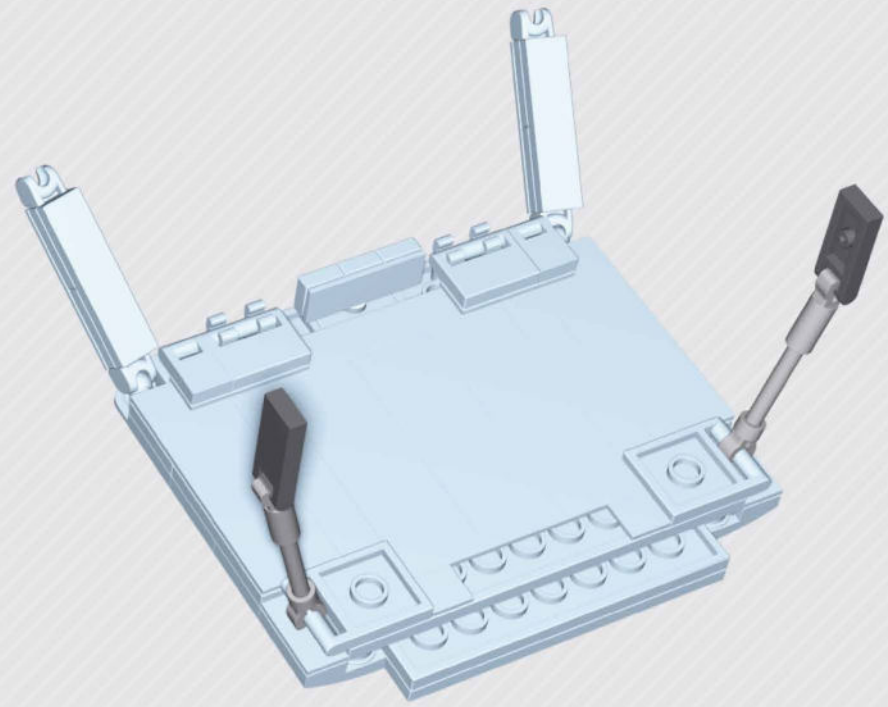
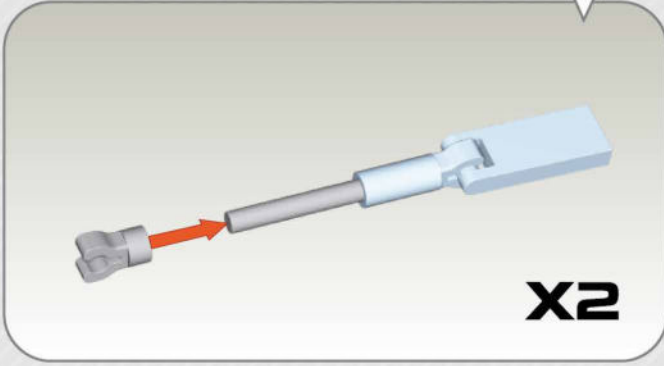
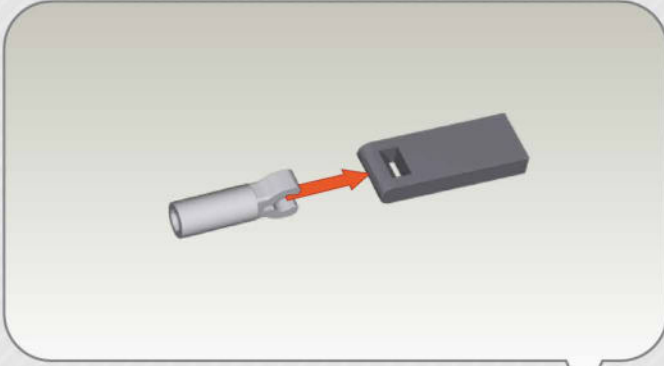

-  x2
-  x2
-  1:1 x2
-  x2

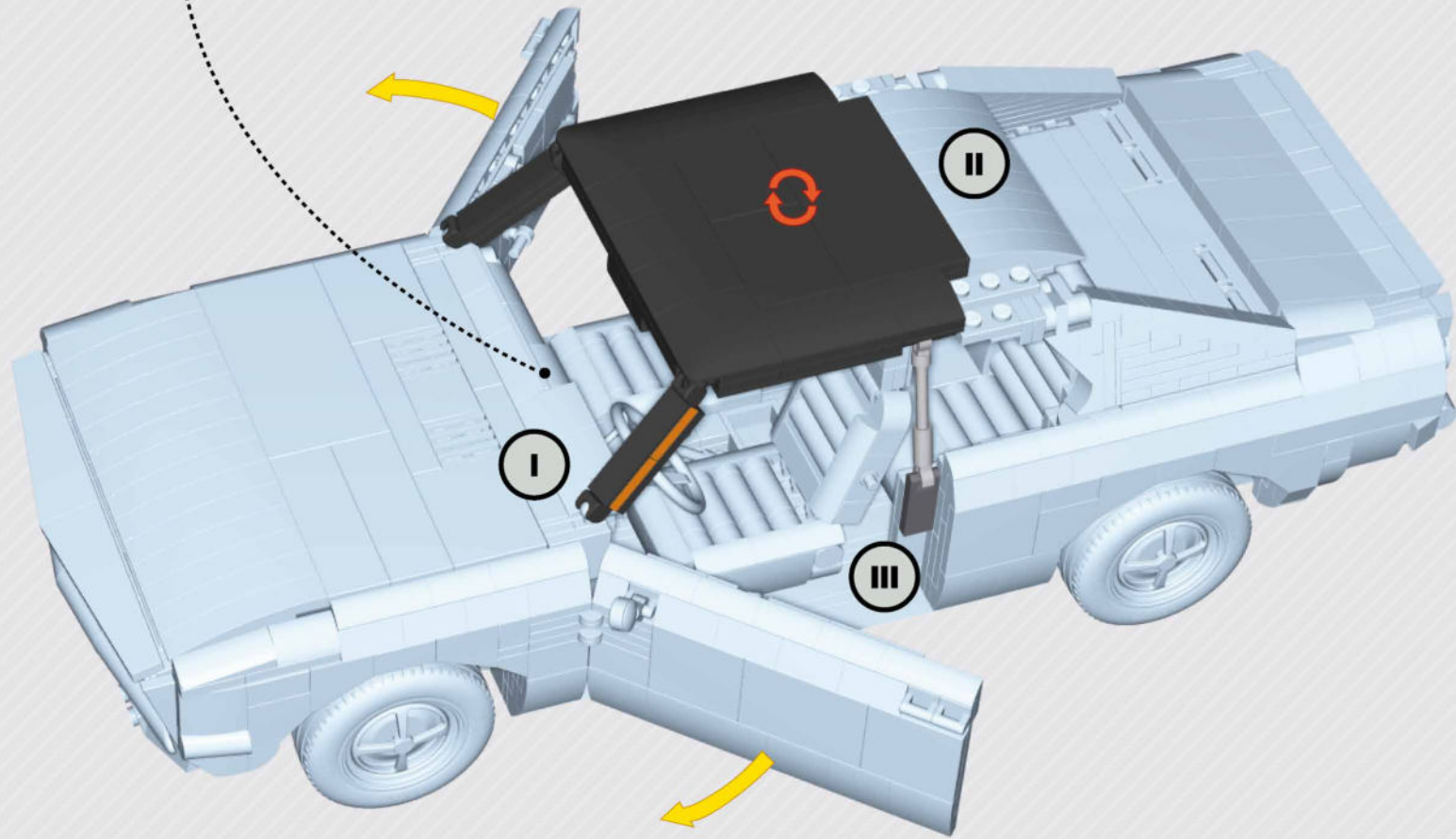
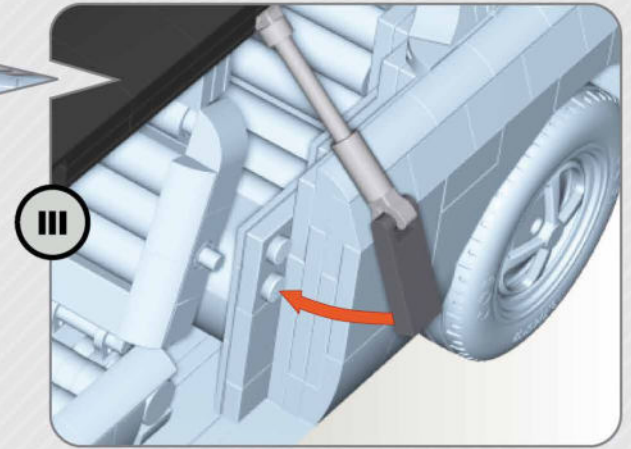
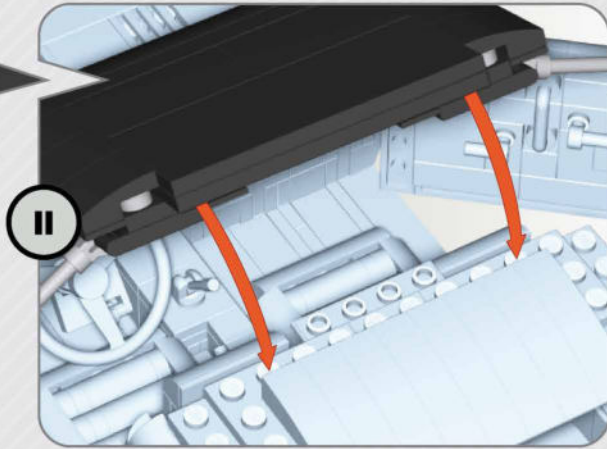
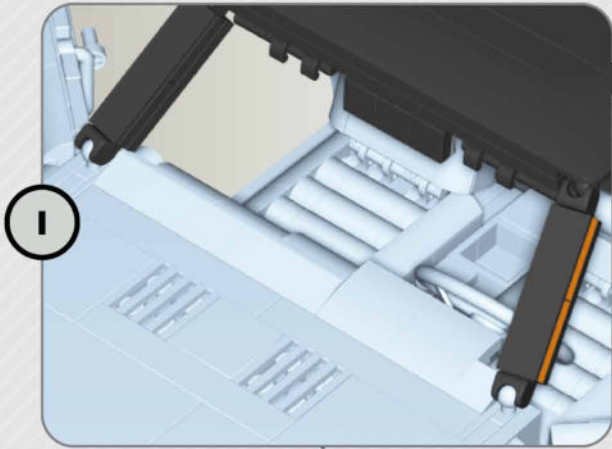

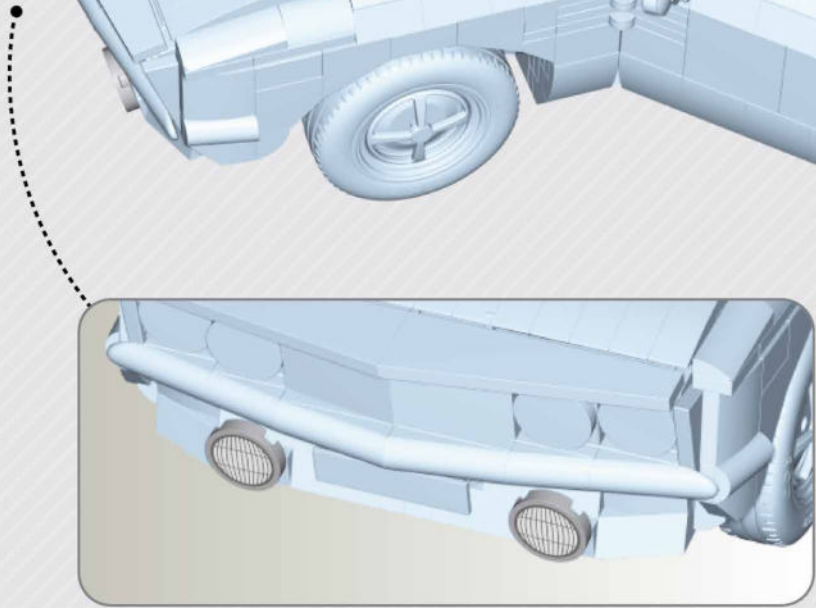
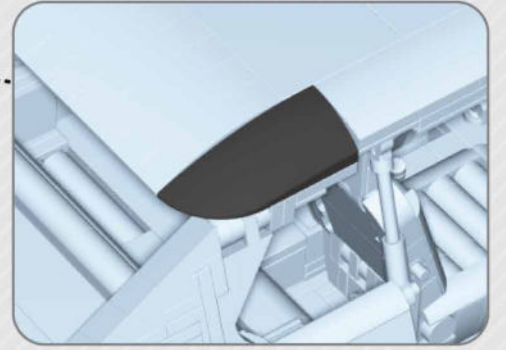
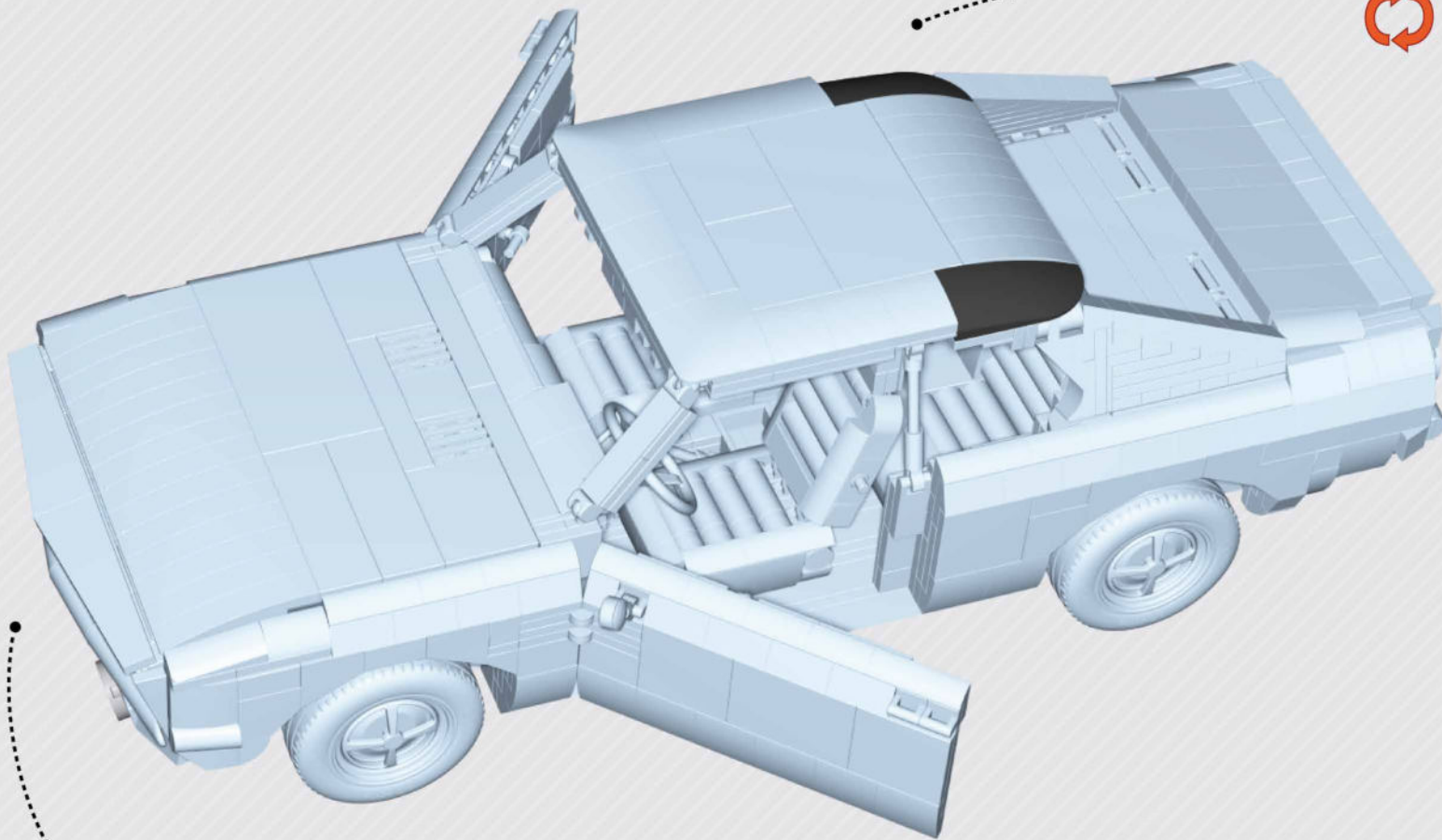

-  x2
-  x1
-  x1

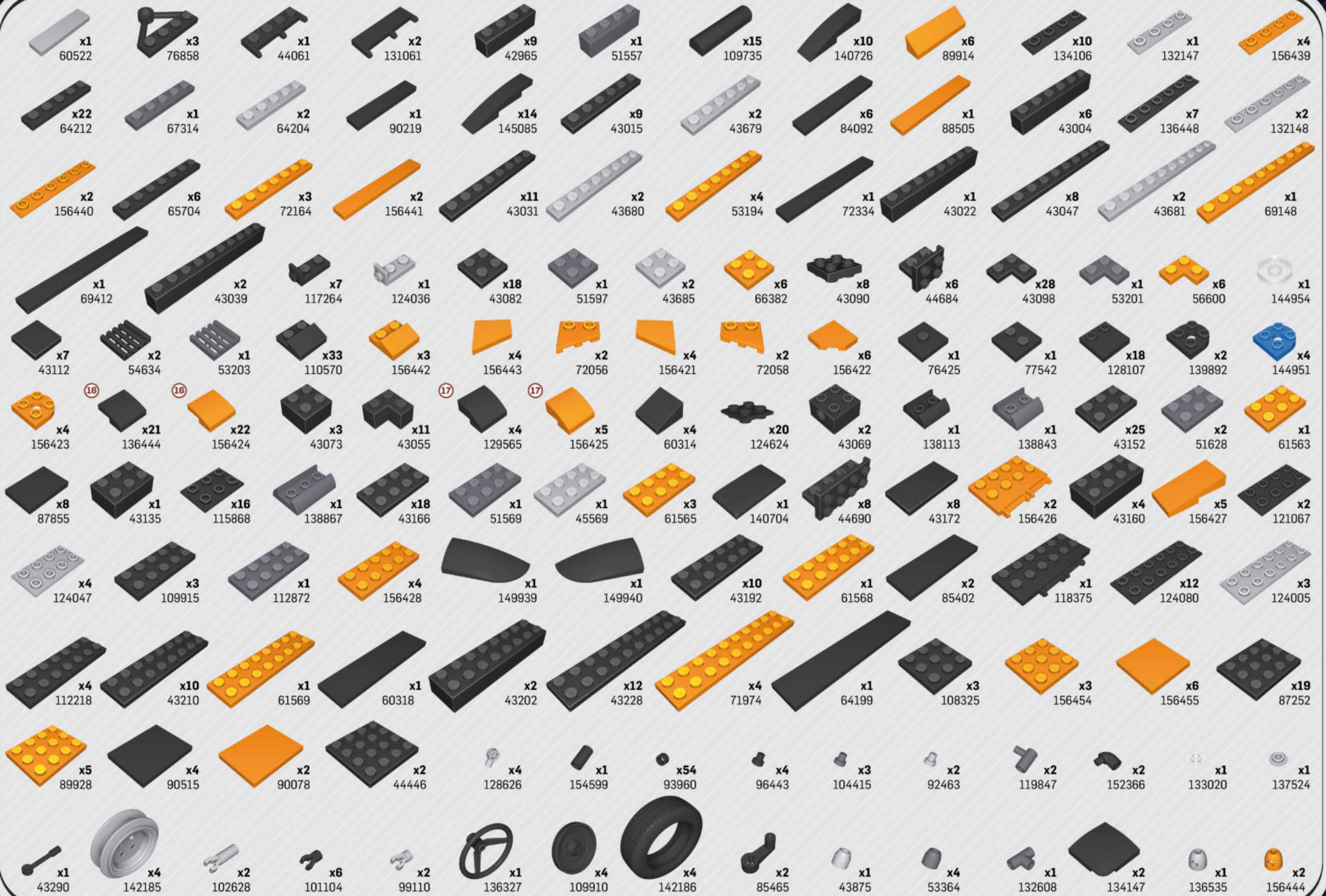





CITROËN 2CV
CHARLESTON
24341
1:12 scale



1970
OPEL MANTA A
24339
1:12 scale



PRODUCT UNDER
LICENSE //



Printed in EU



1938
CITROËN TRACTION
AVANT 11CV
24337
1:12 scale



For
news and
special deals

Find us on:



WWW.COBIBRICKS.COM

00-24349/11-1937