

HISTORICAL COLLECTION

WORLD WAR II



**EXECUTIVE
EDITION**



Sherman M4A3
T34 Calliope

M4A3 SHERMAN & T34 CALLIOPE
 IN SERVICE - 1944 - 1945
 PLACE OF ORIGIN - UNITED STATES
 TYPE - MEDIUM TANK
 WEIGHT - 32T (70,550LB)
 ARMOUR - 76MM (3") AT THE FRONT
 ARMAMENT - 75MM (2.95") GUN M3,
 ROCKET LAUNCHER T34
 60x 114MM (4.5") M8 ROCKETS,
 1x 7,62MM (.30") M1919A4 BROWNING
 ENGINE - FORD GAA V8, 500HP (373KW)
 SPEED - 42KM/H (26MPH)
 CREW - 5



**PAD PRINTED
NO STICKERS**

Printed in EU

2569



WARNING: CHOKING HAZARD-
 Toy contains small parts.
 Not for children under 3 years.

1230 3

M4A3 SHERMAN with T34 CALLIOPE

SCALE 1:28

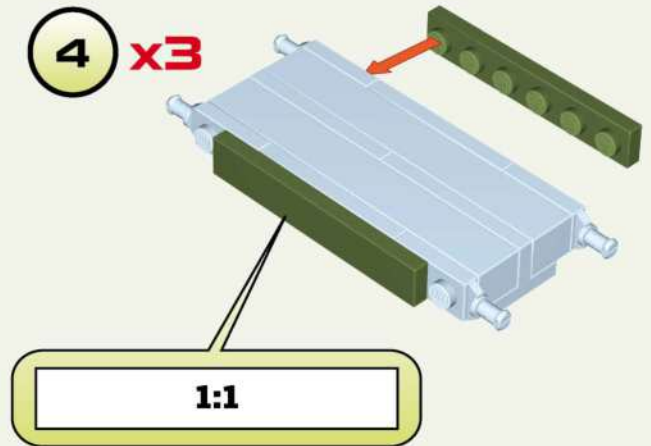
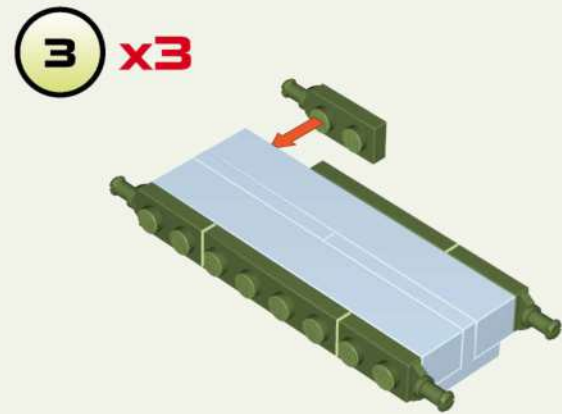
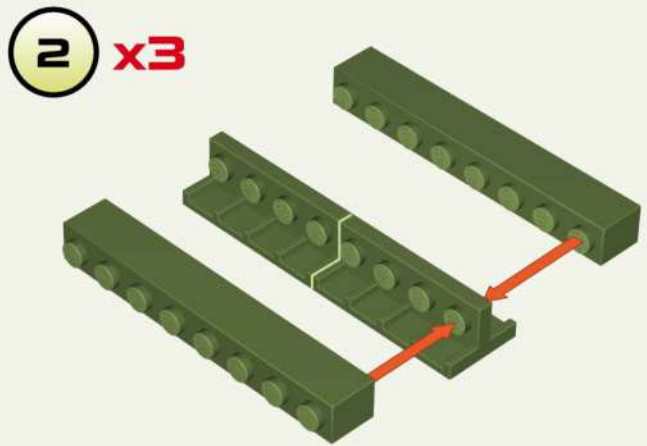
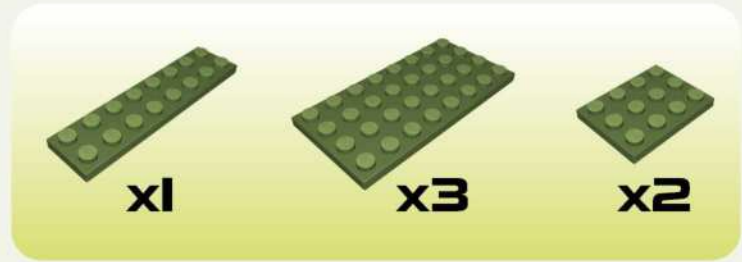
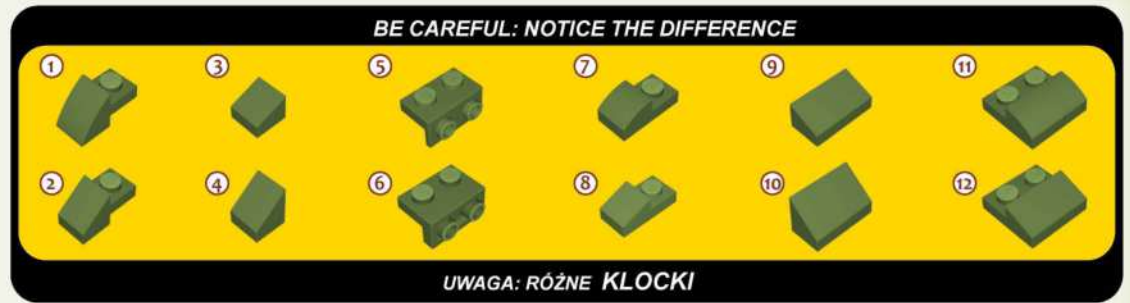
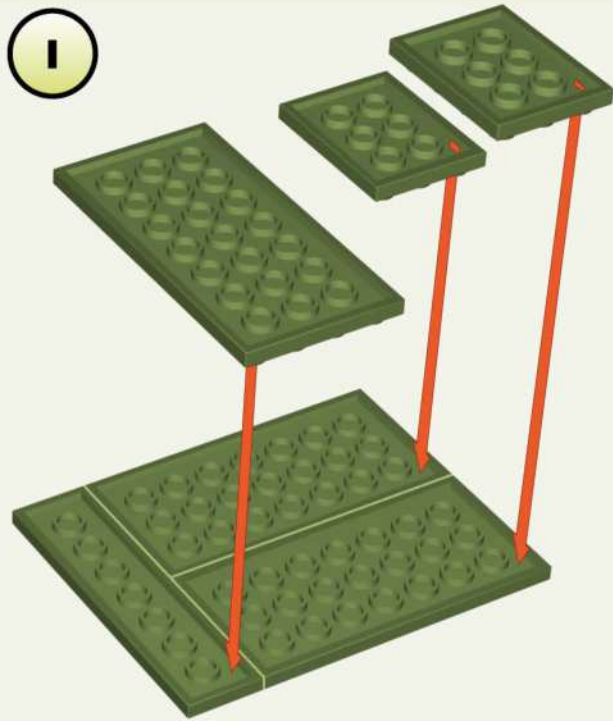

5

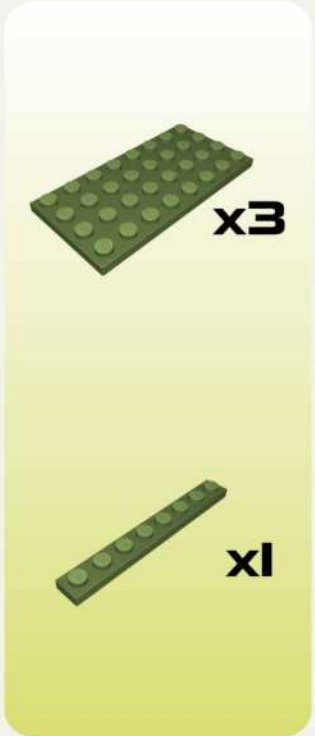
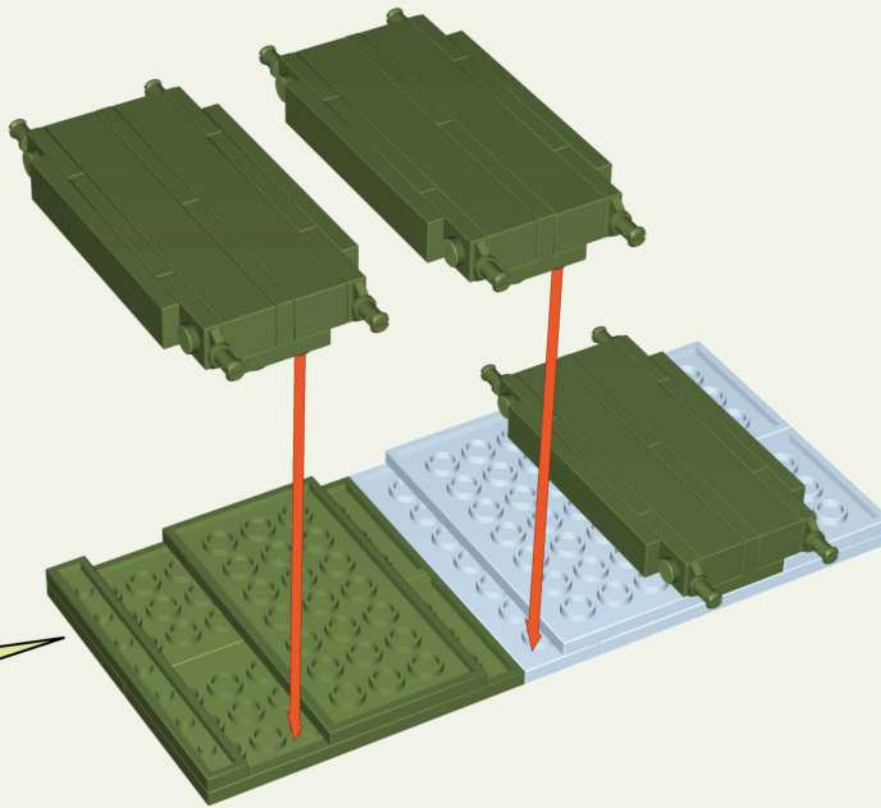
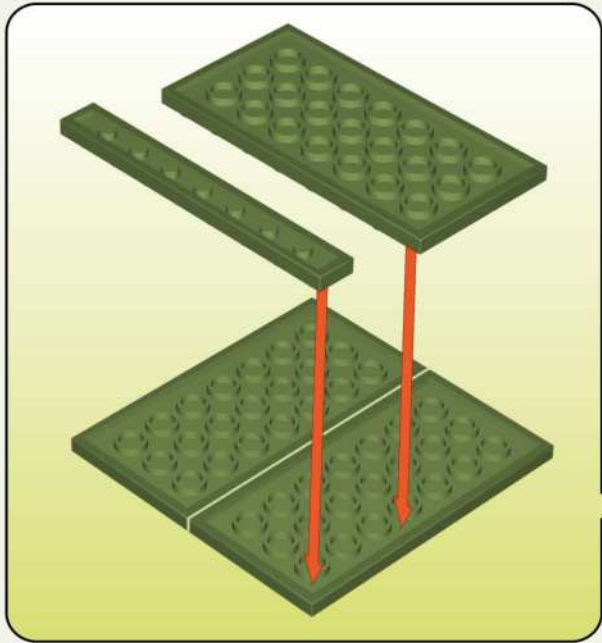

6

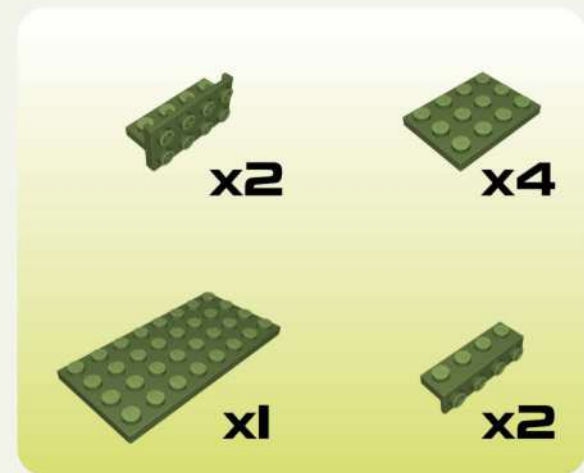
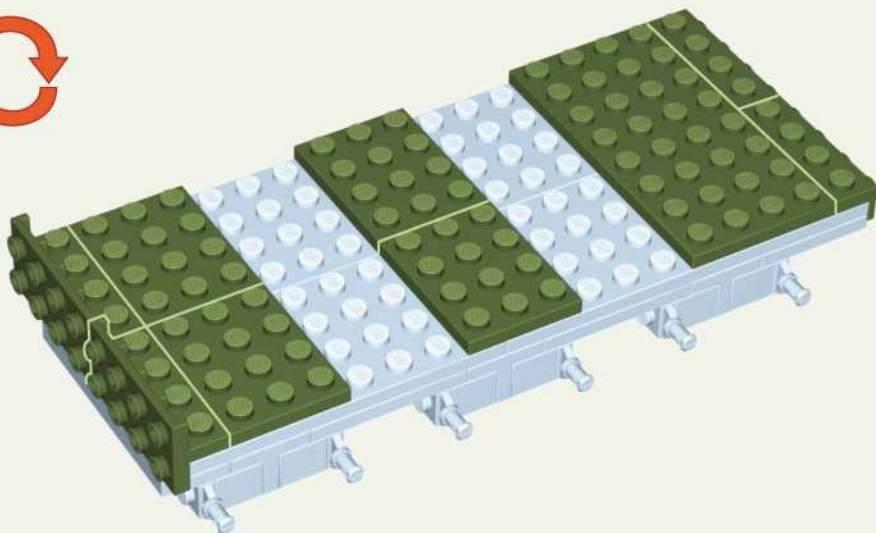

7

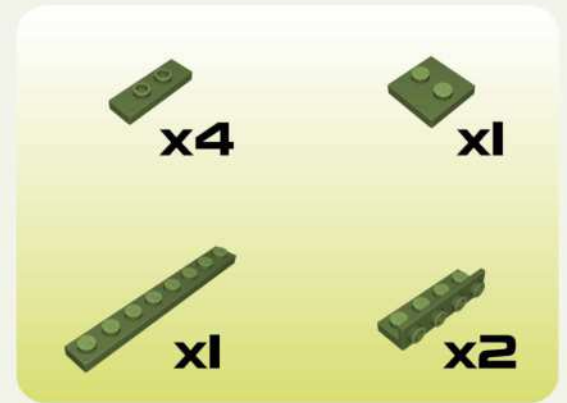
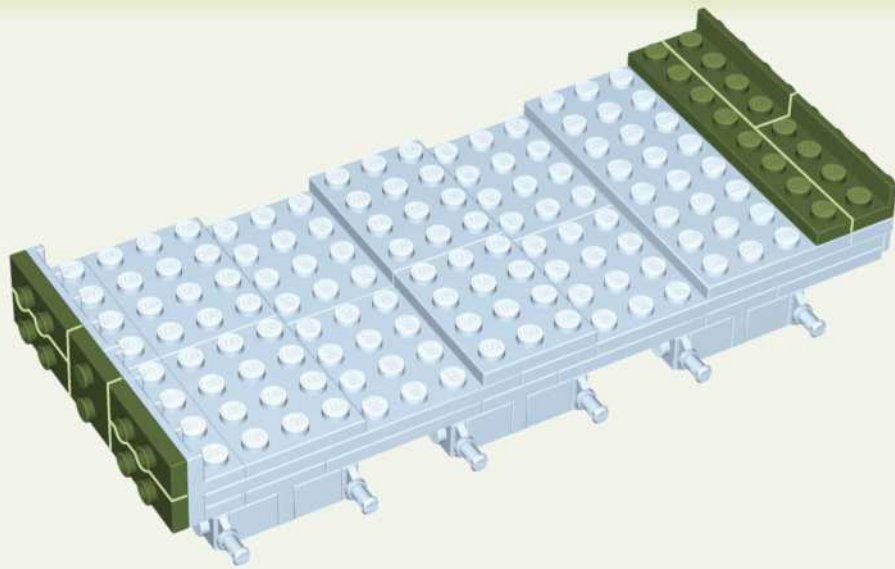

8



9

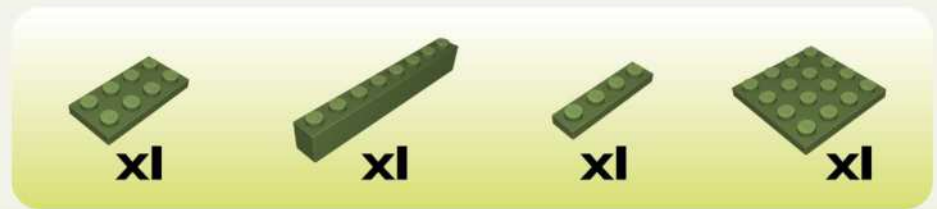
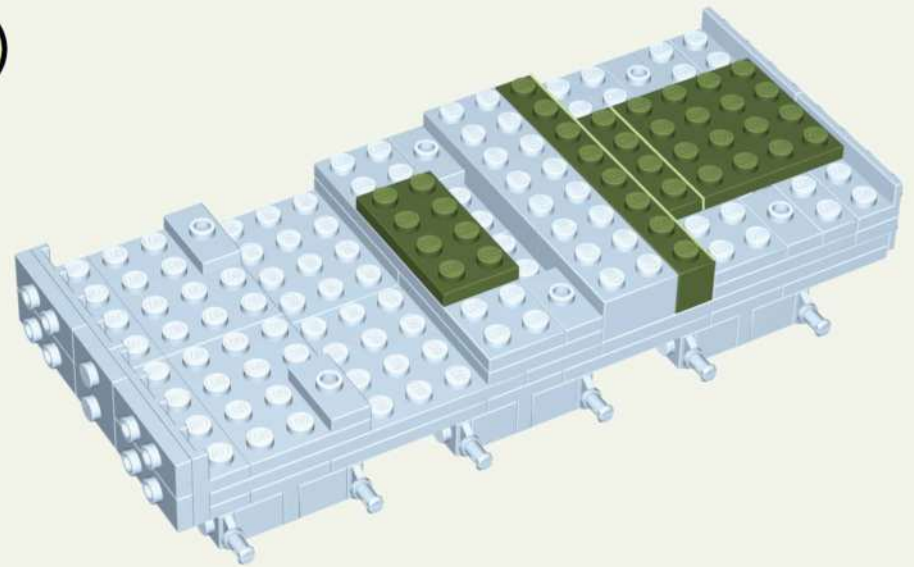

10

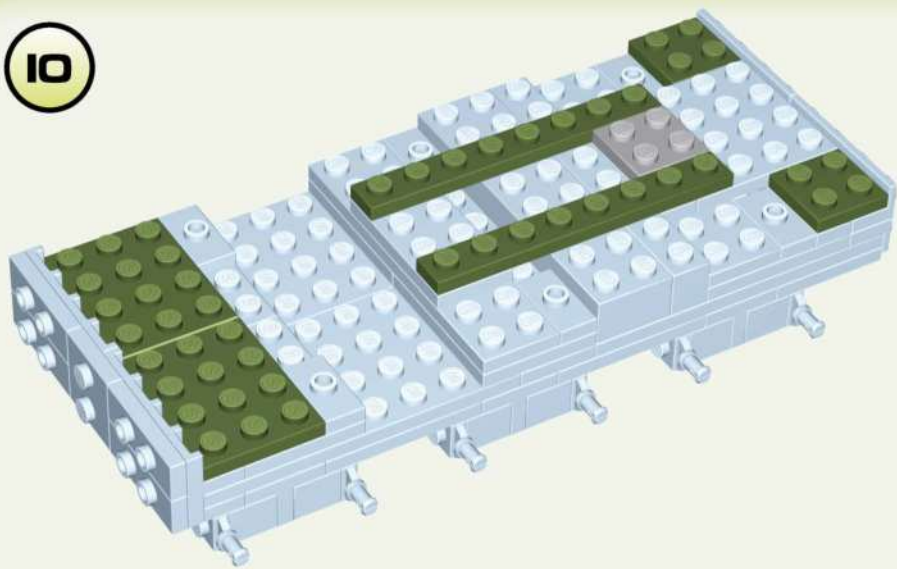

x2



x2



x1



x2

11

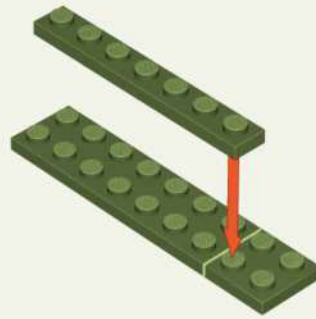

x1



x1



x1

12

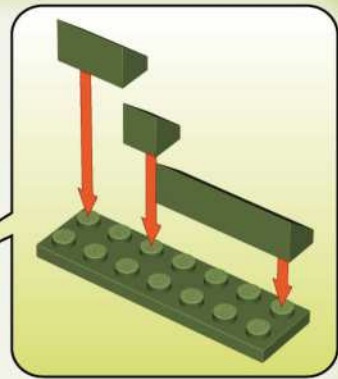
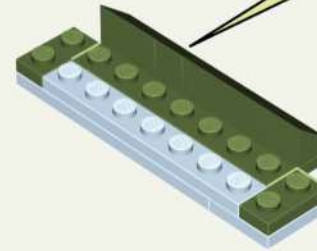

x2



x1



10

x1



4

x1



x1

13

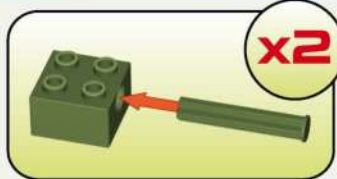
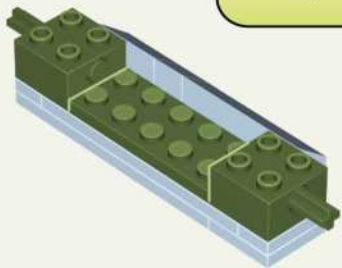

x2



x1



x2



x2

14

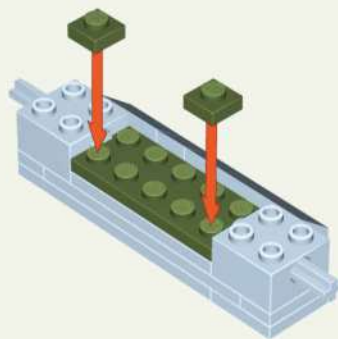

x1



x2

15

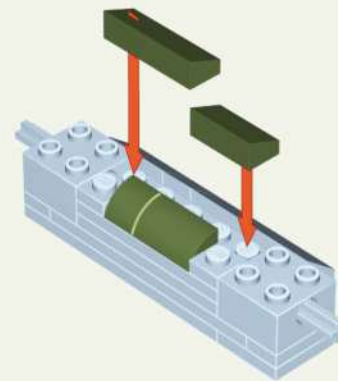

x1



x1



9

x1



x1

16

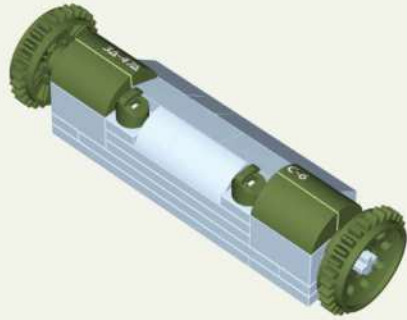

x2



x1



x1



x2



x2

17

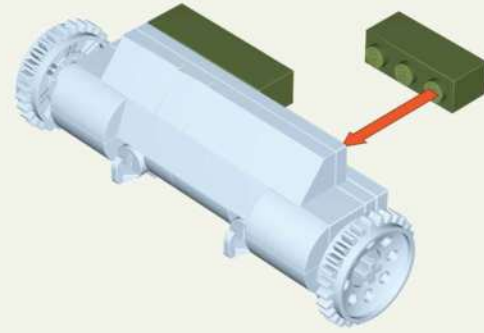

x1



x1

18

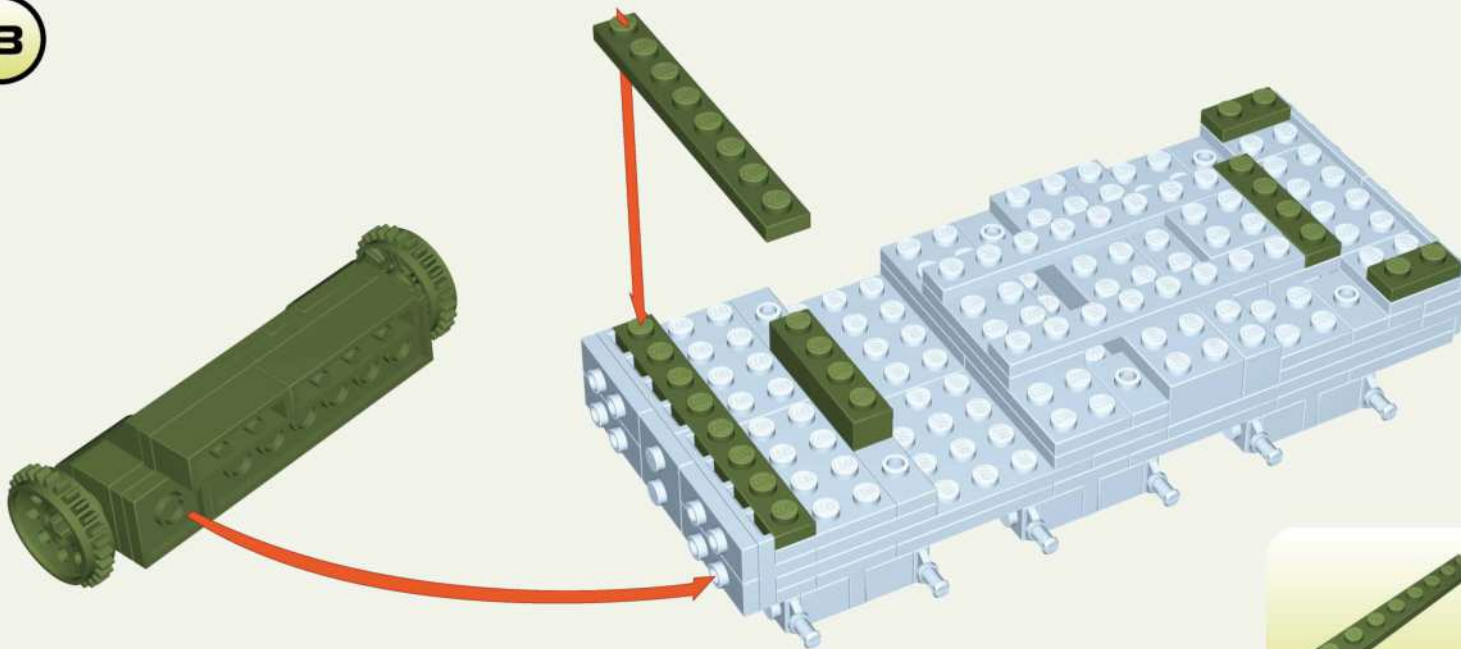

x2



x1



x1



x2

19

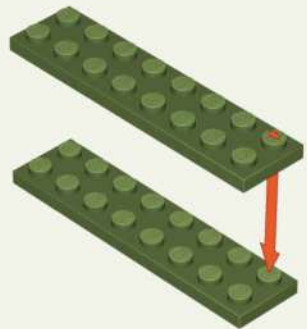

20

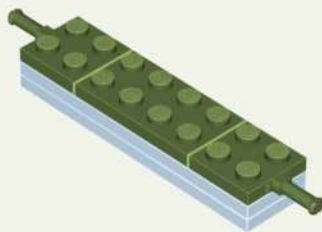

21

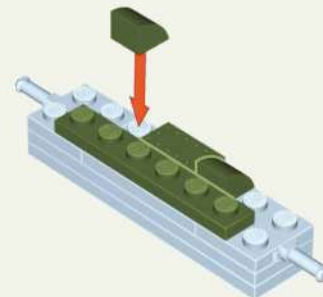

22

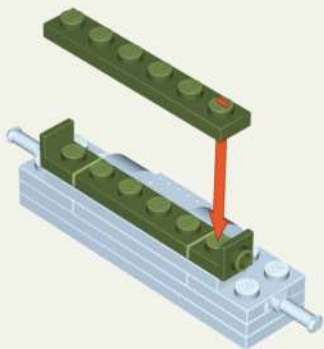

23

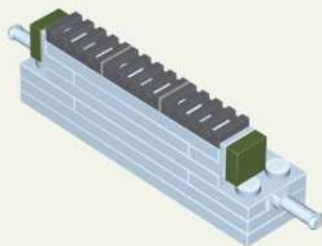

24

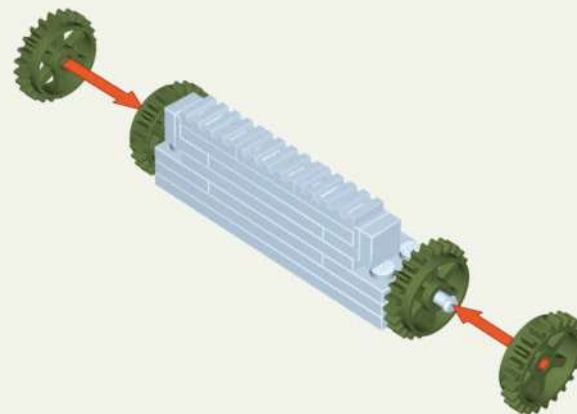

25

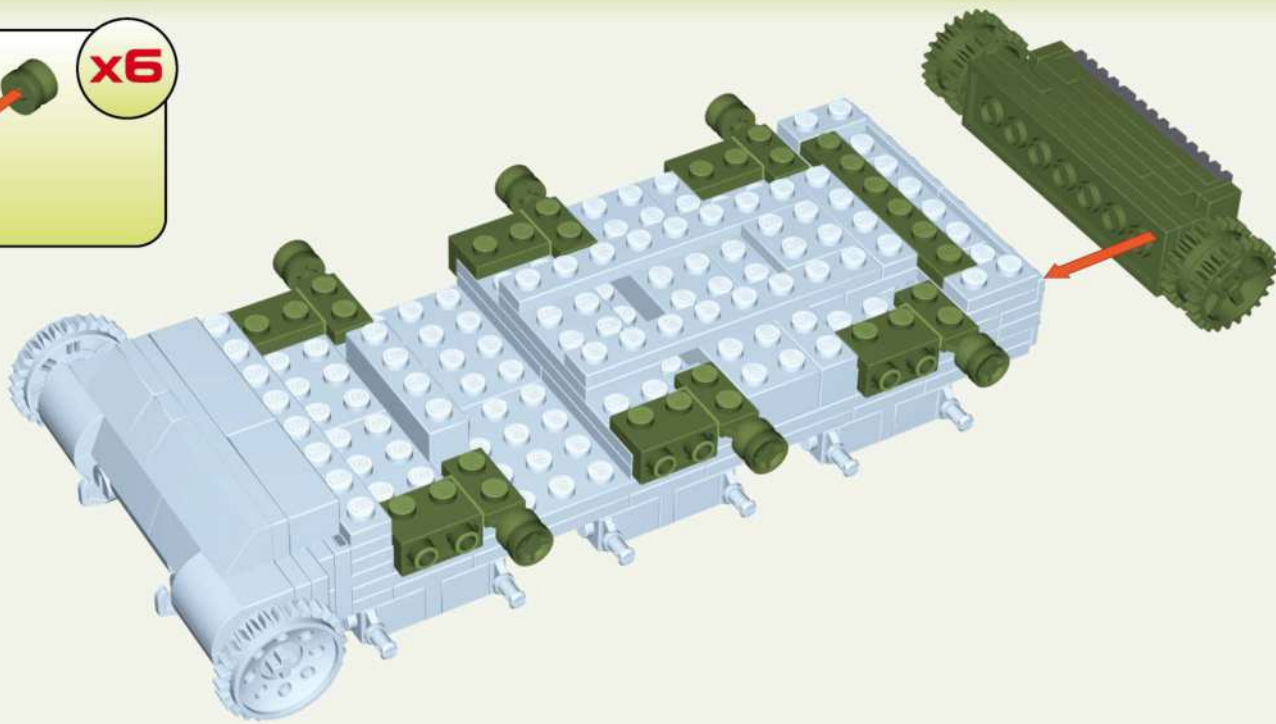
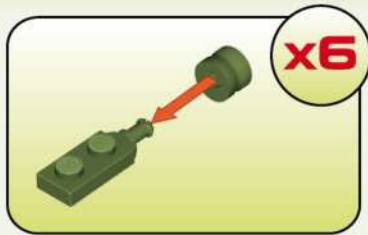

-  x6
-  x6
-  x6
-  x1



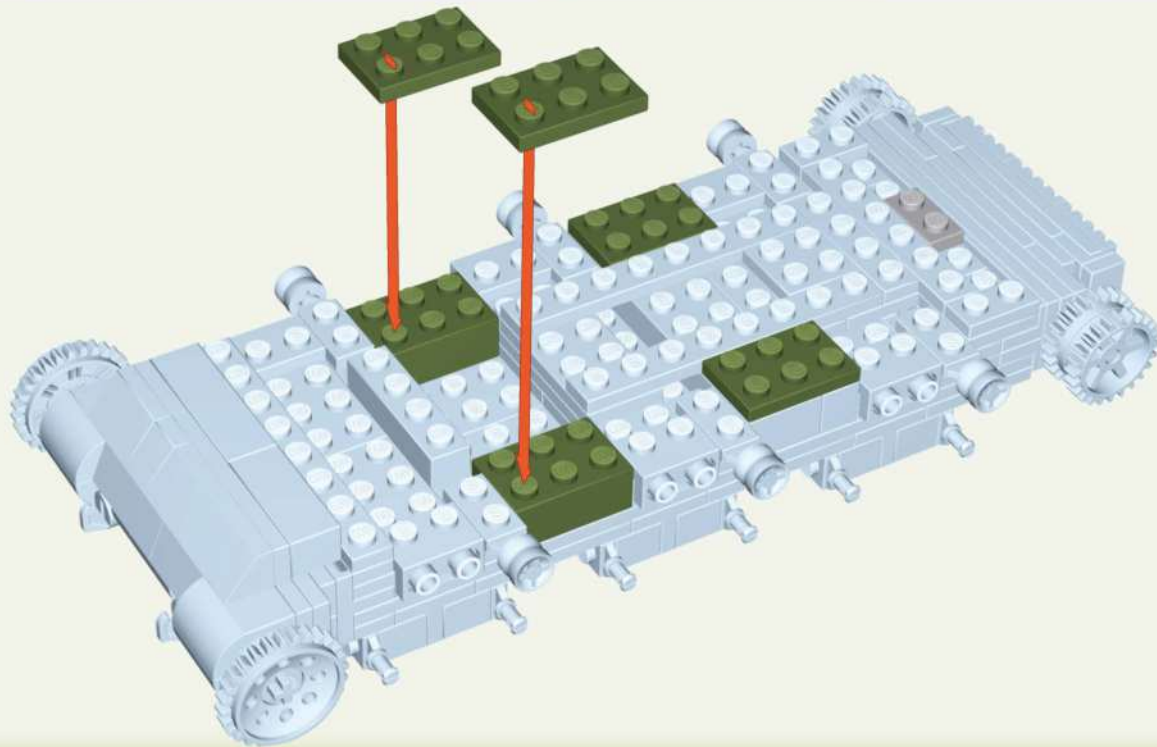

26

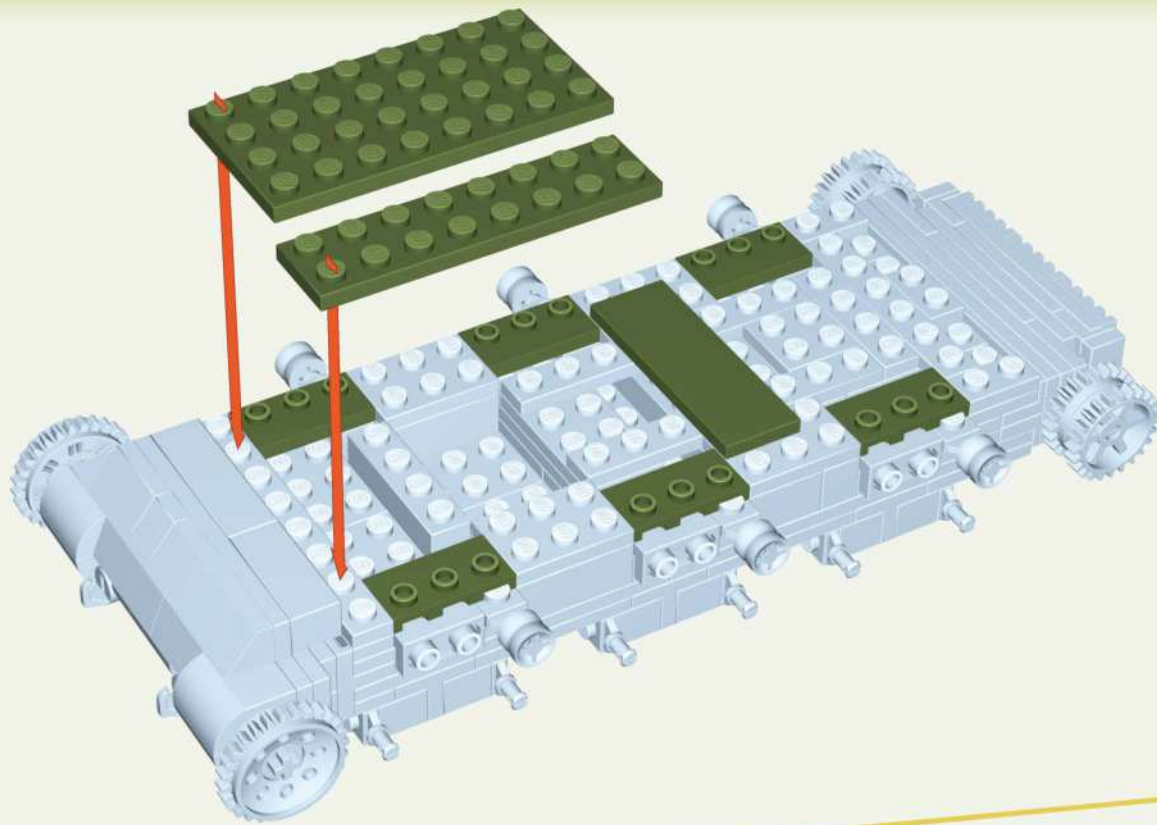

-  x2
-  x4
-  x1

27



-  x6
-  x1
-  x1
-  x1

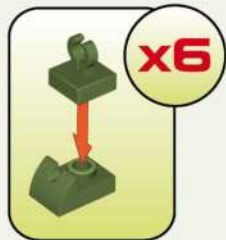
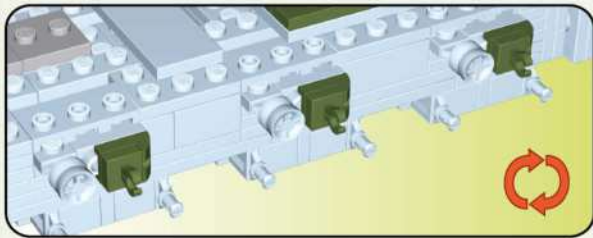

28

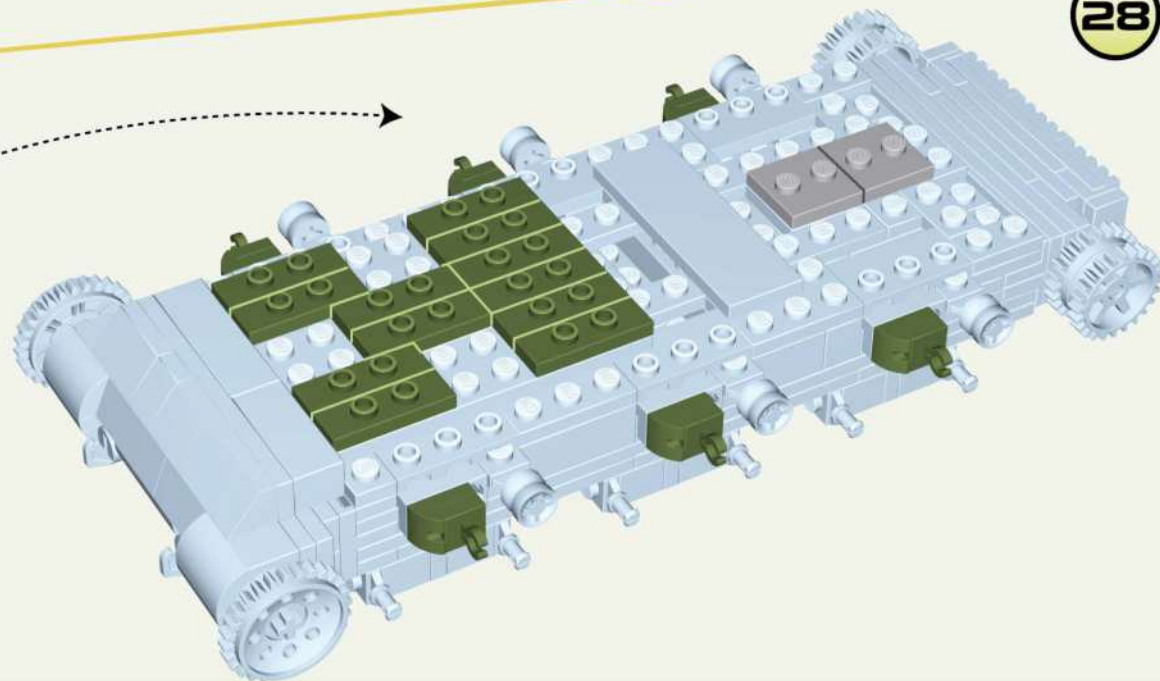

-  x6
-  x6
-  x12
-  x2

29

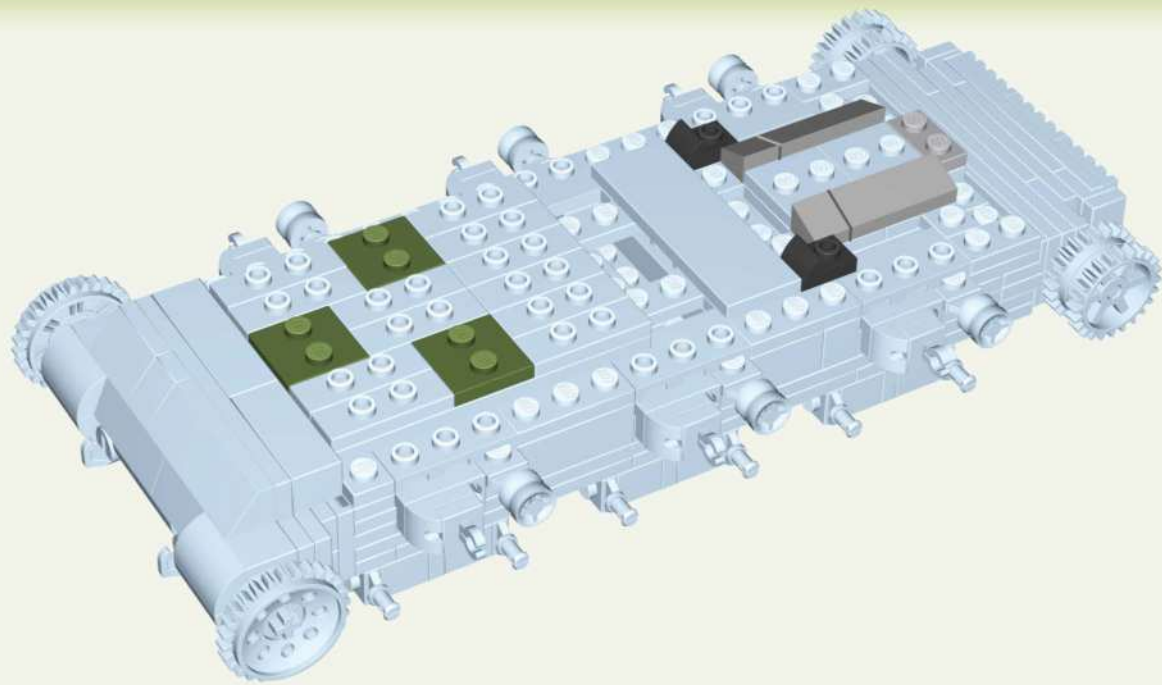

 x3

 x2

 x2

 x2

 x1

30

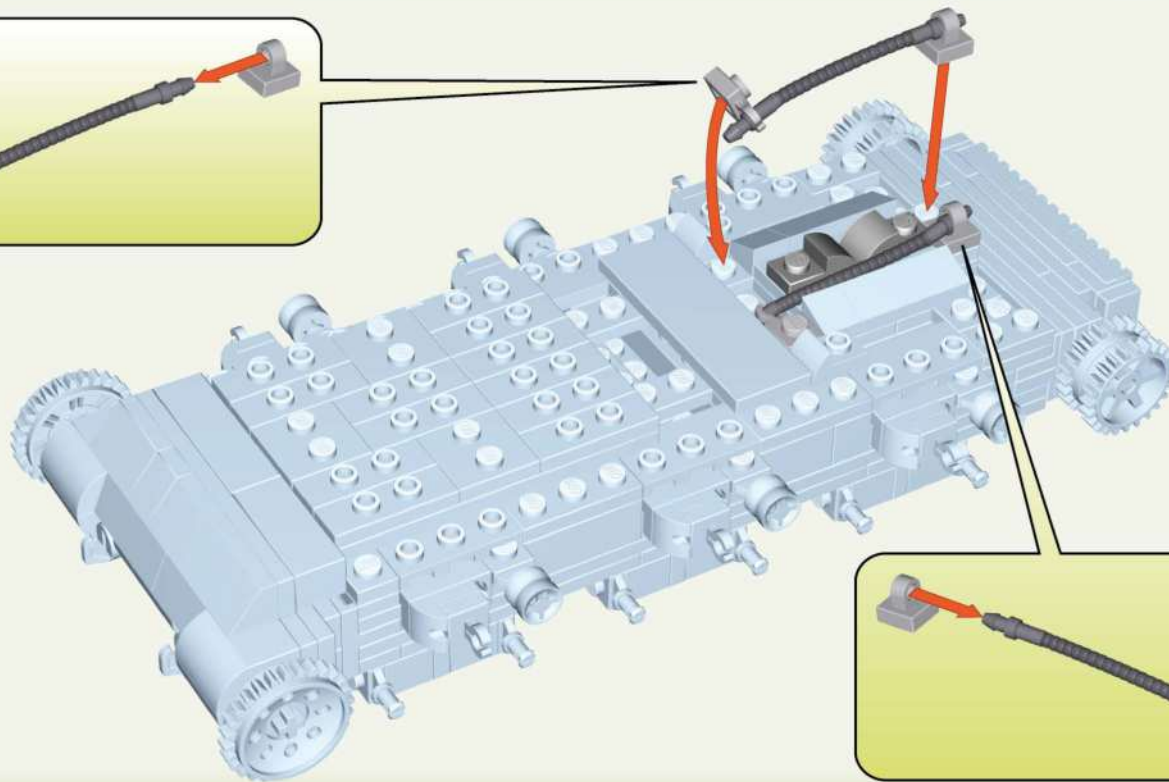
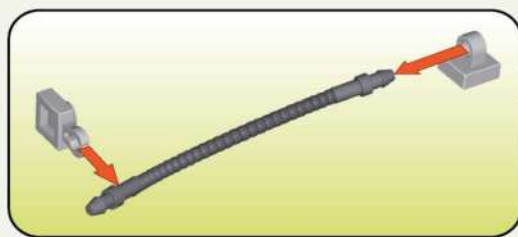

 x2

 x2

 x2

 x2

 x2

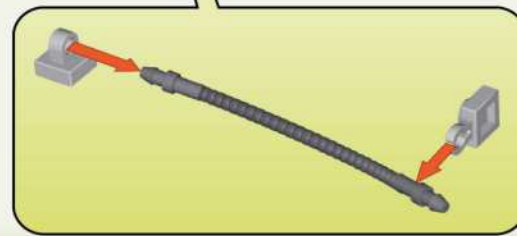



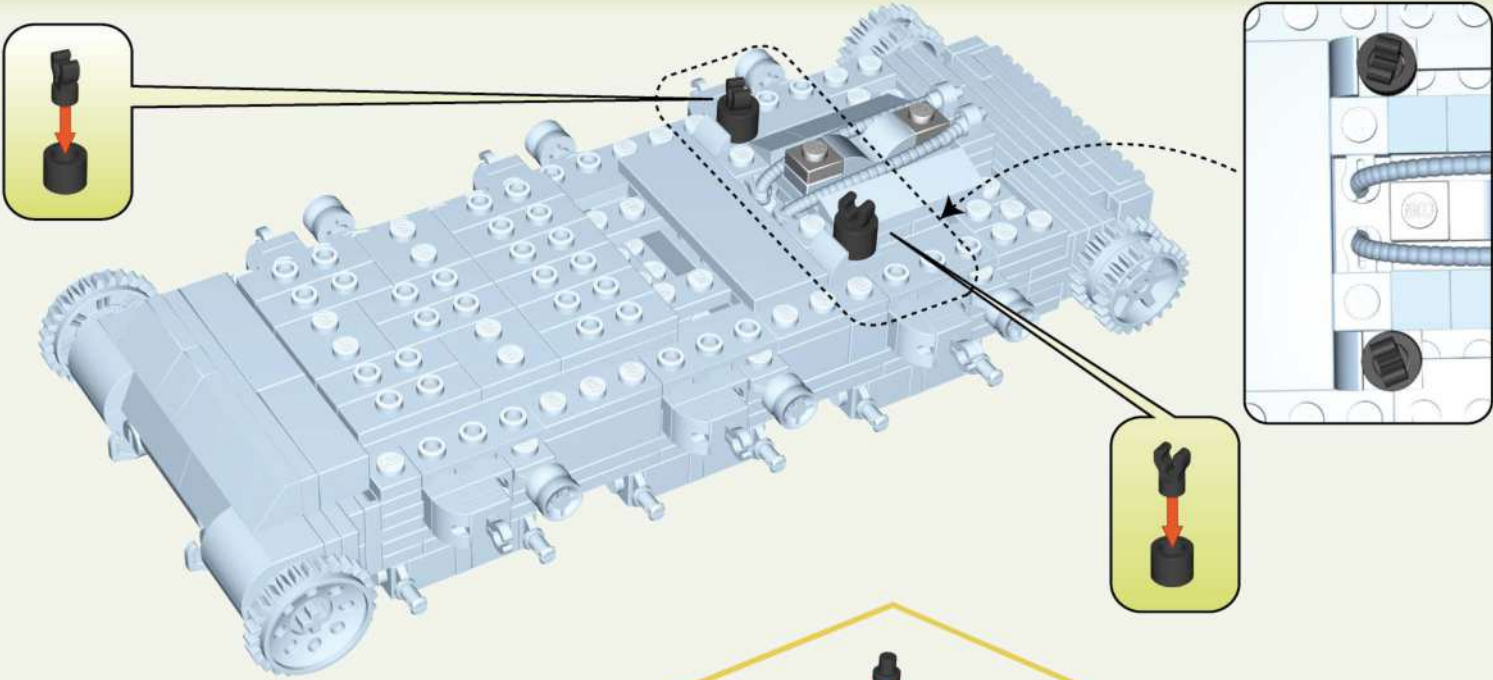

31

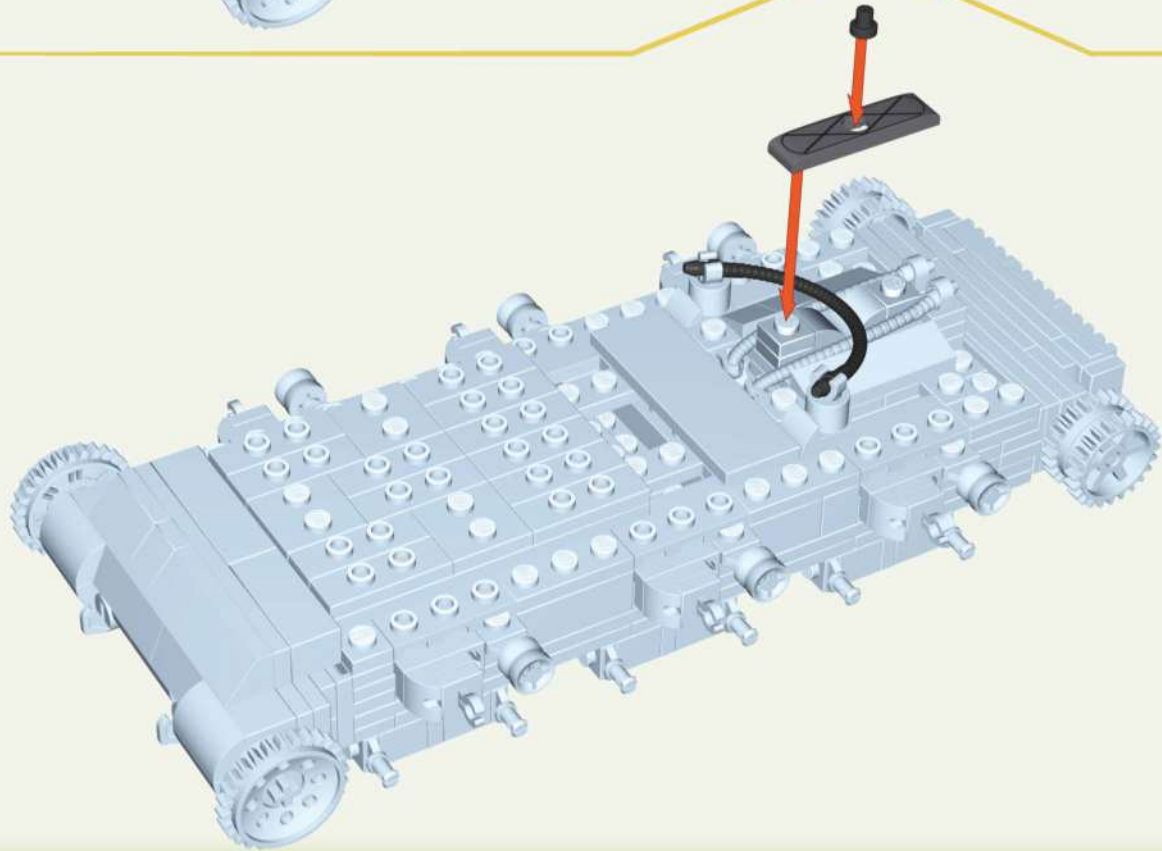

-  x2
-  x2
-  x2

32



-  x1
-  x1
-  x1

33

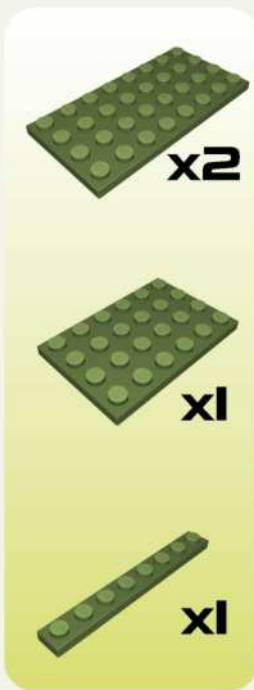
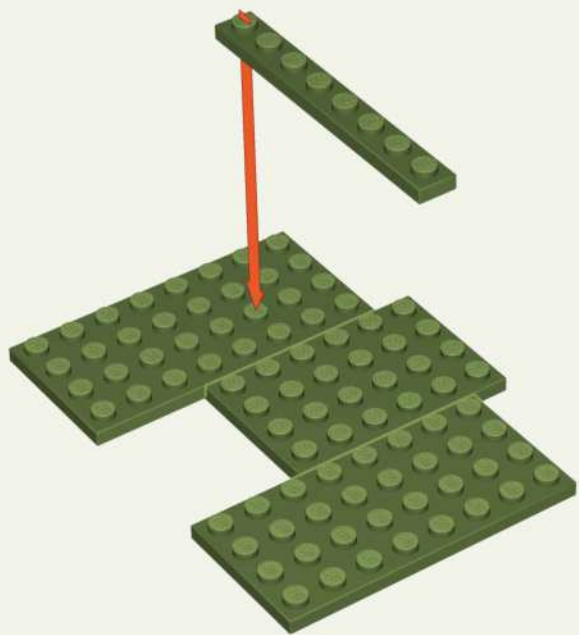

34

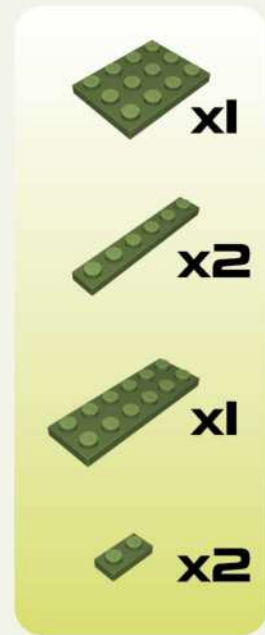
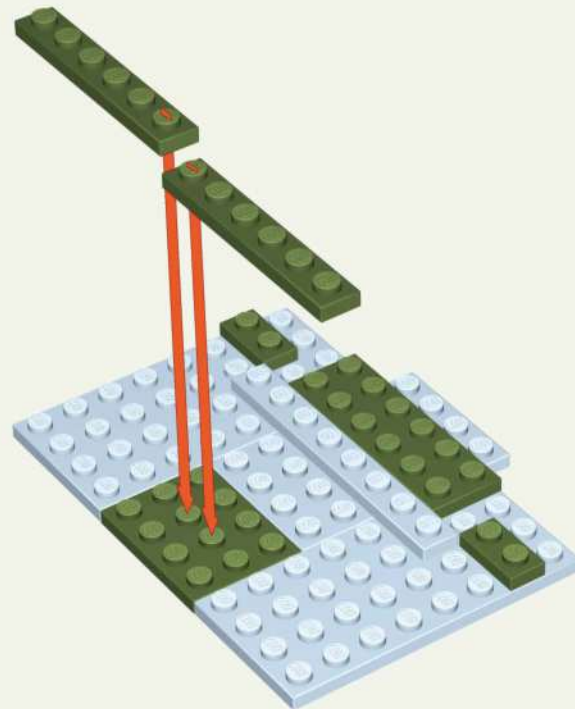

35

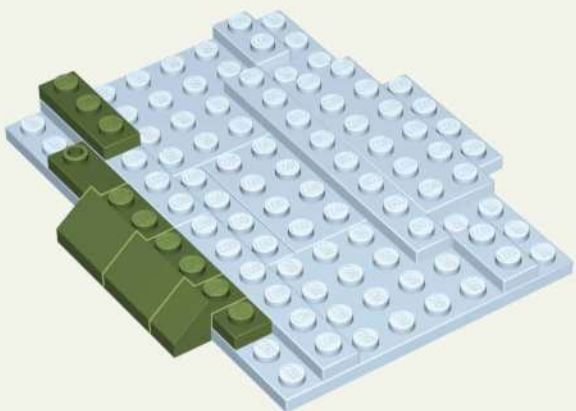

36

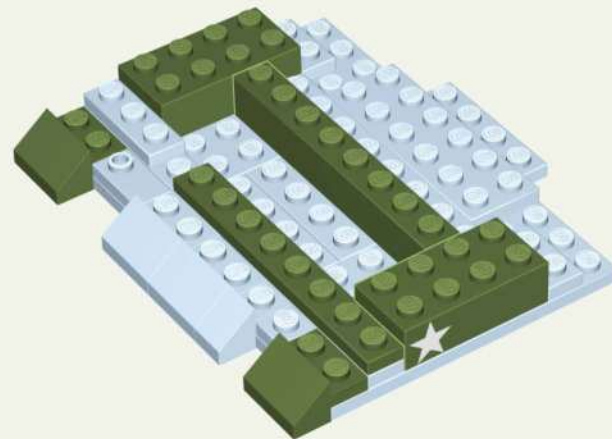

37

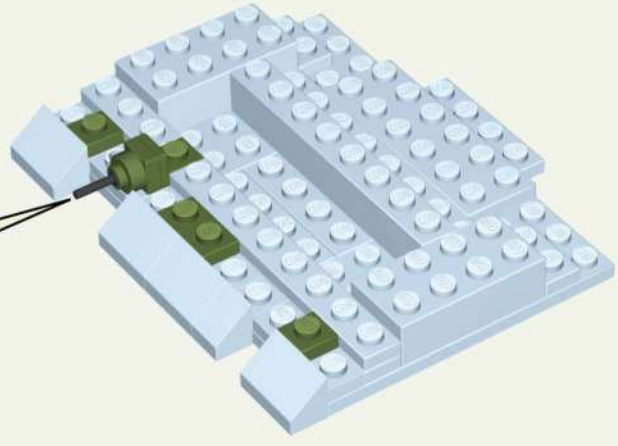
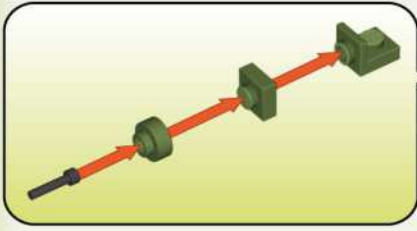

- 
x3
- 
x1
- 
x1
- 
x1
- 
x1

38

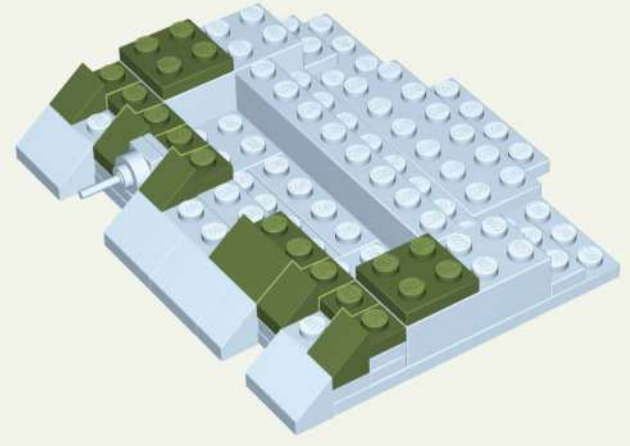

- 
x5
- 
x2
- 
x1
- 
x3

39

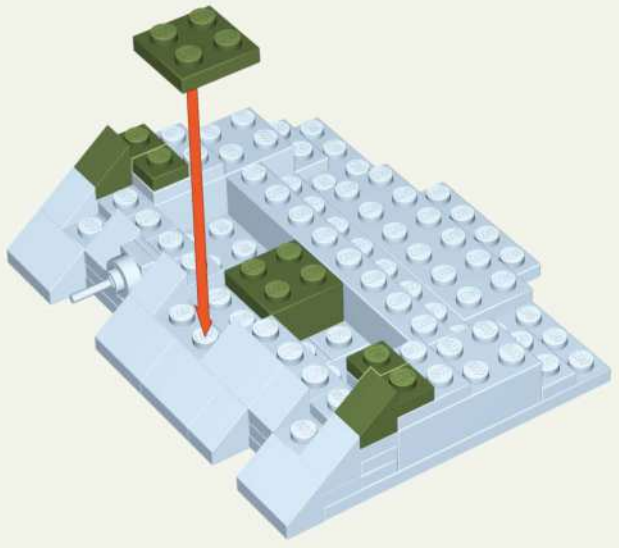

- 
x2
- 
x2
- 
x1
- 
x1

40

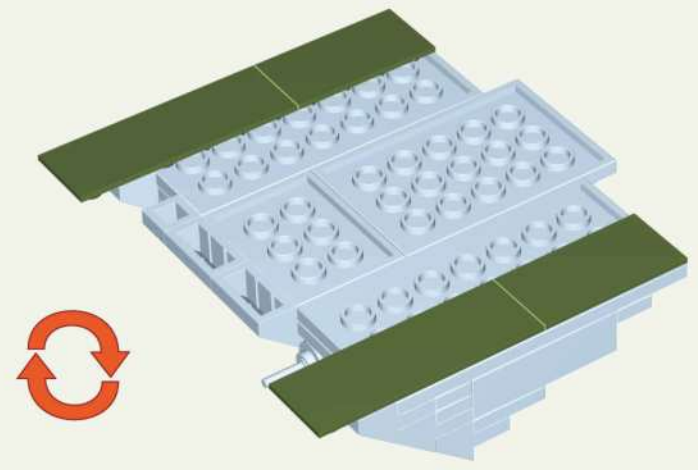

- 
x2
- 
x2

41

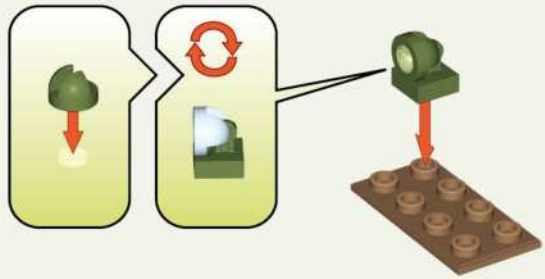

 **x1**
  **x1**
  **x1**
  **x1**

42

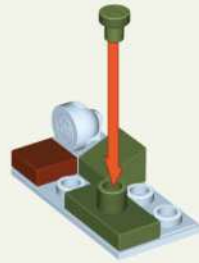

 **x1**
  ³ **x1**
  **x1**
  **x1**

43

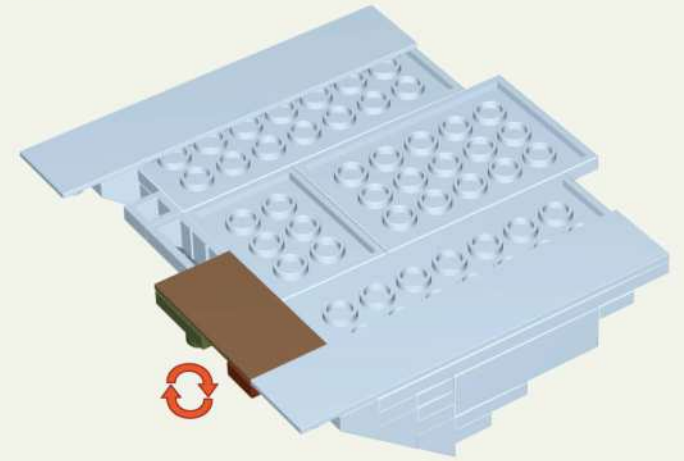

44

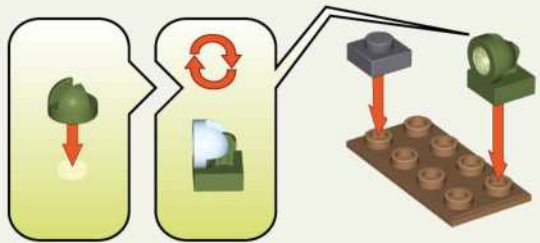

 **x1**
  **x1**
  **x1**
  **x1**
  **x1**

45

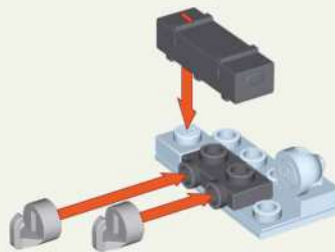

 **x1**
  **x2**
  **x1**

46

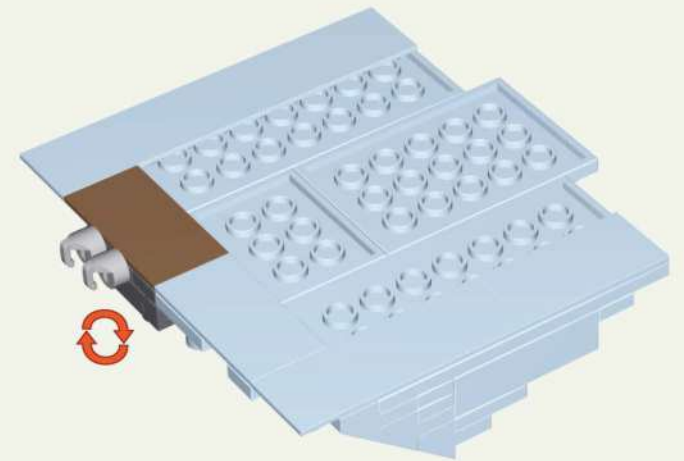

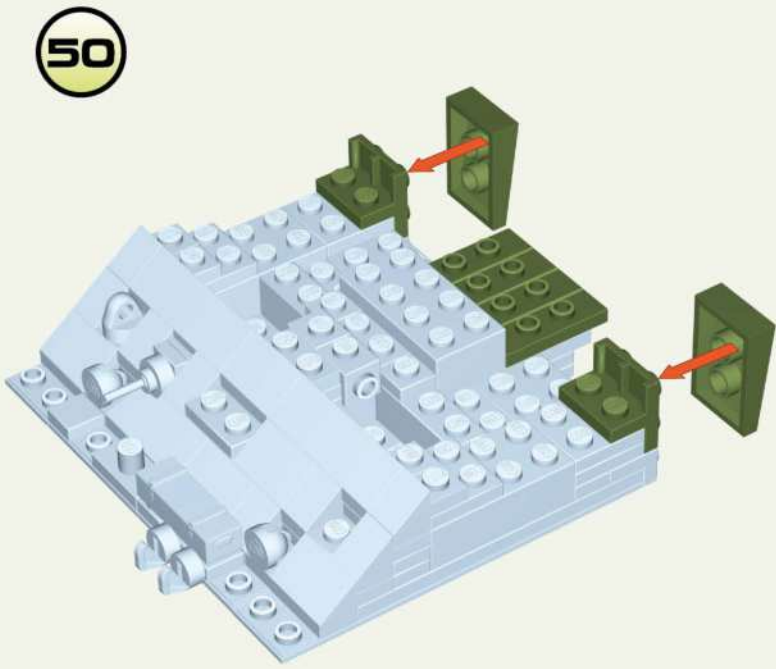
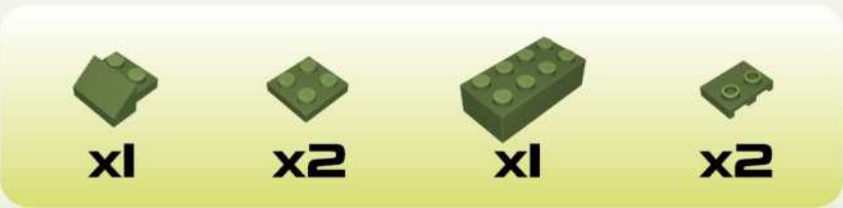
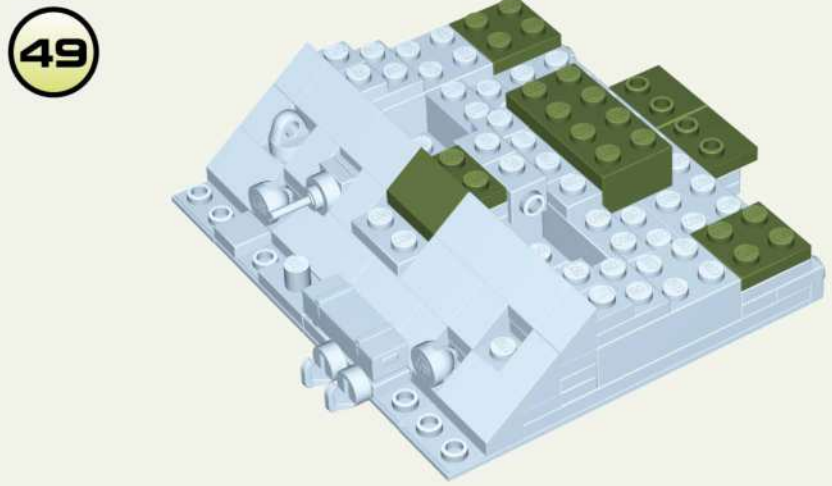
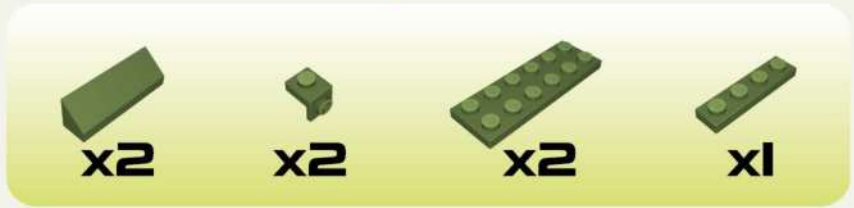
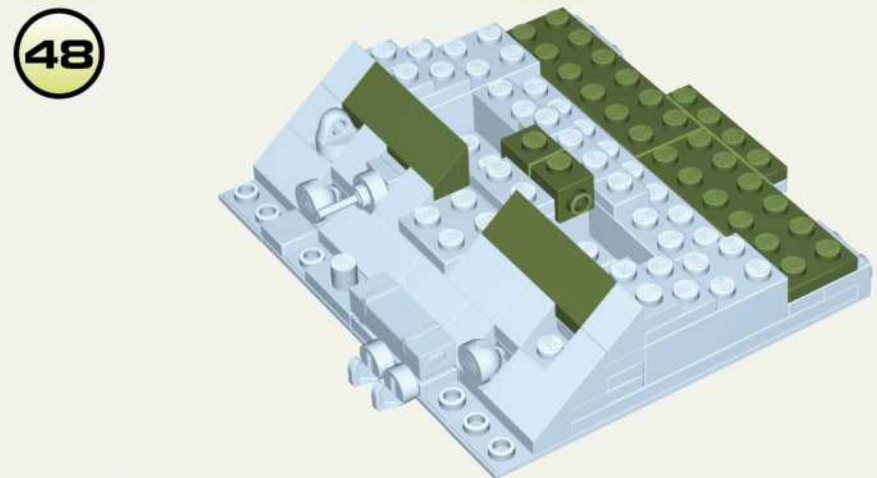
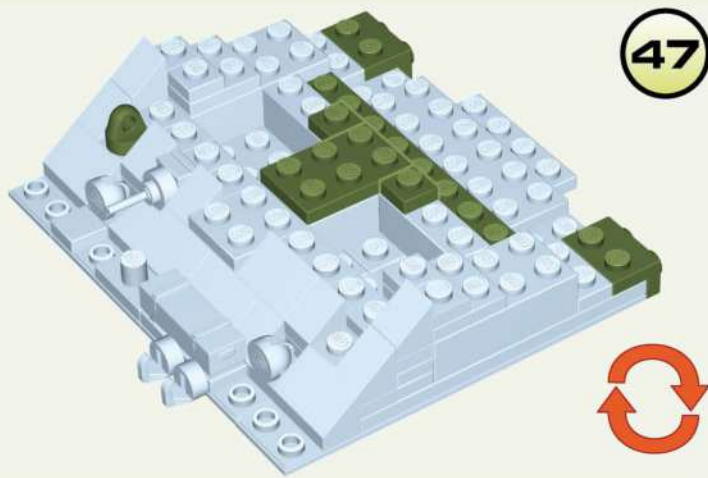

51



x2



x2



x1

52

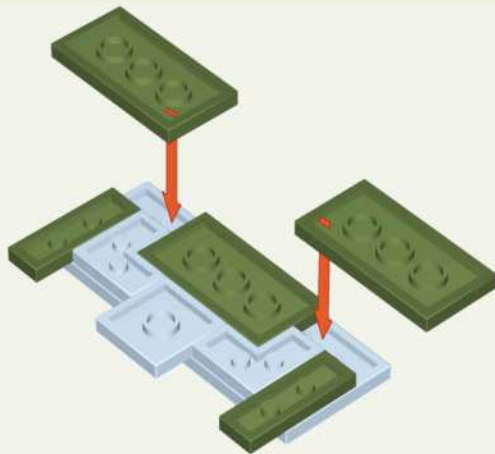

x2



x3

53

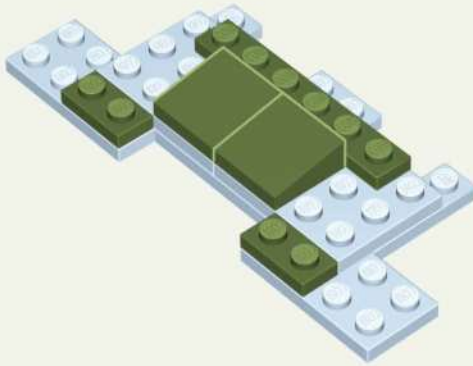

x2



x2



x1

54

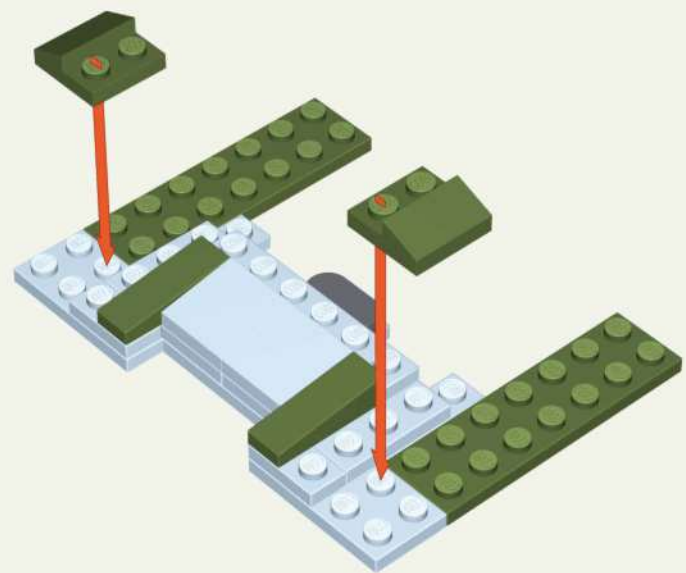

x2



x2

12



x2



x1

55

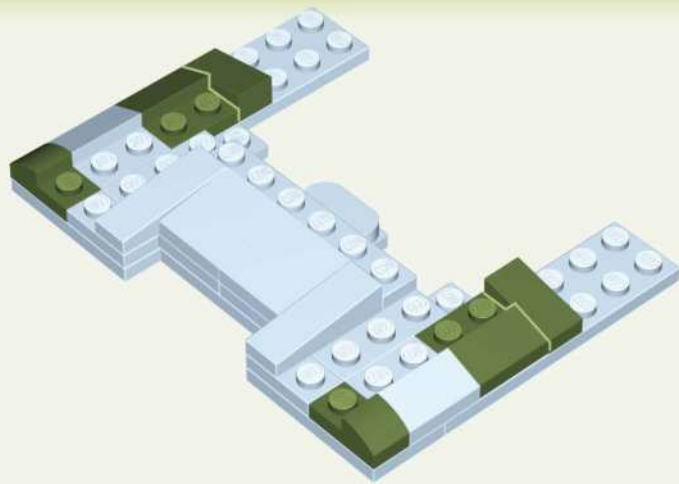

56

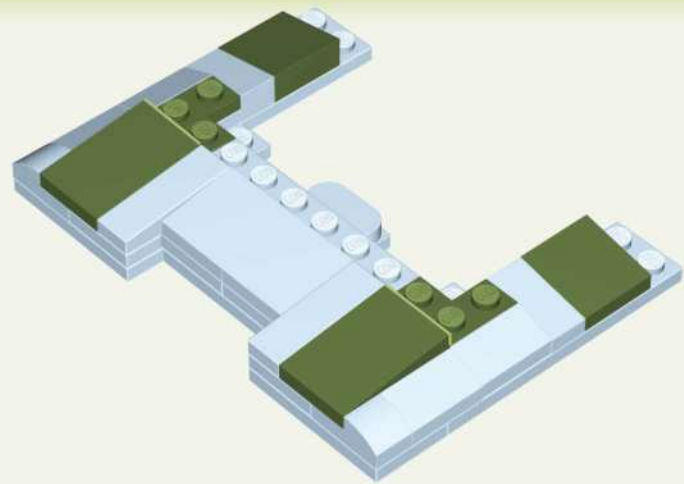

57

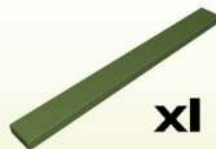
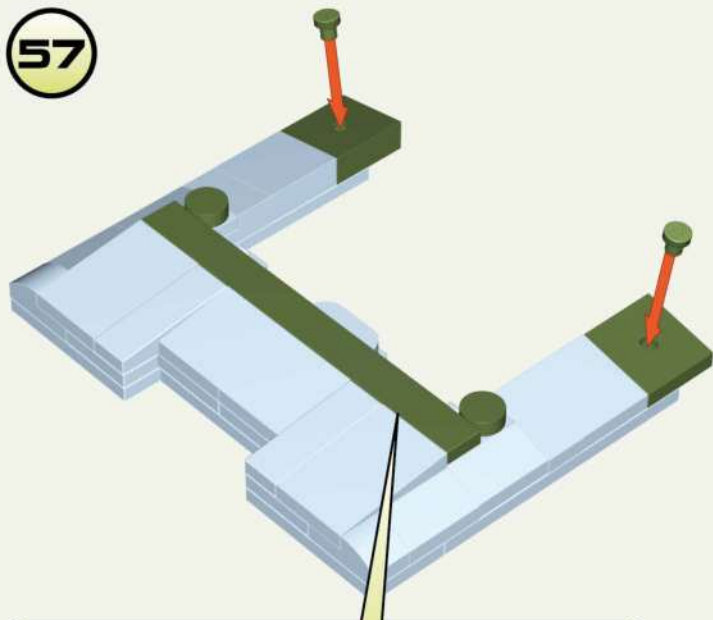

1:1

58

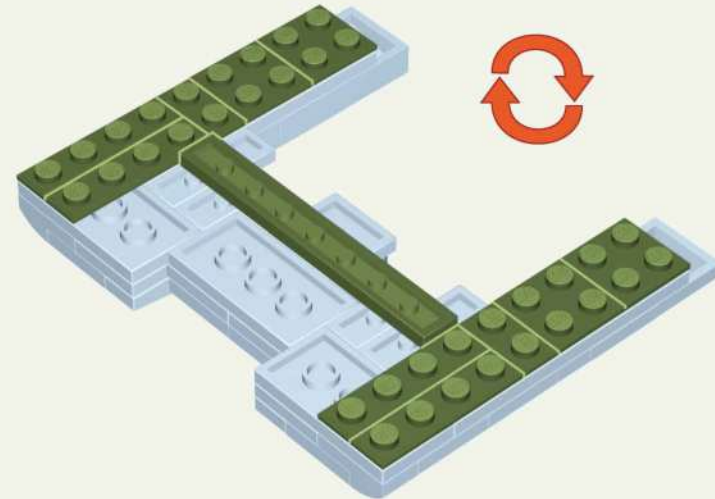

59

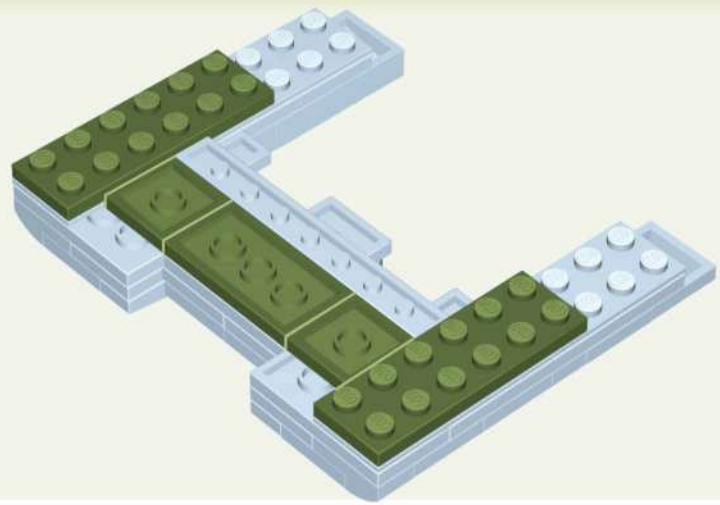

60

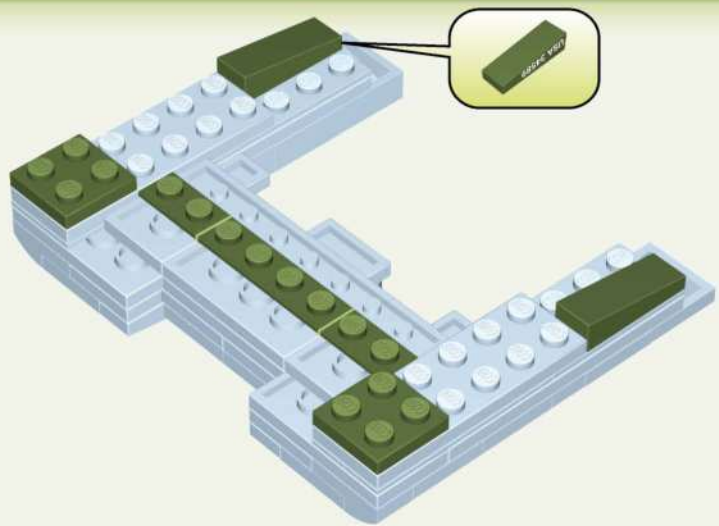

61

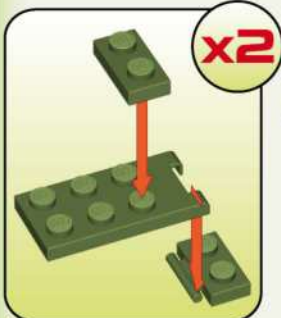

62

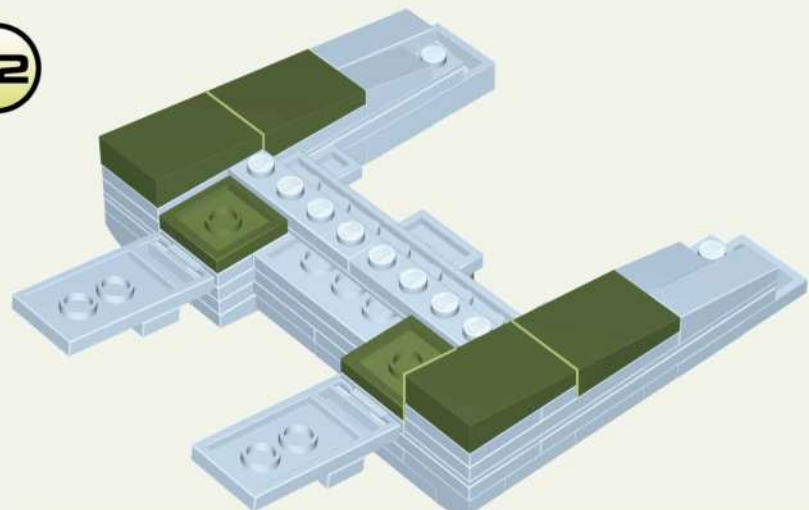

63

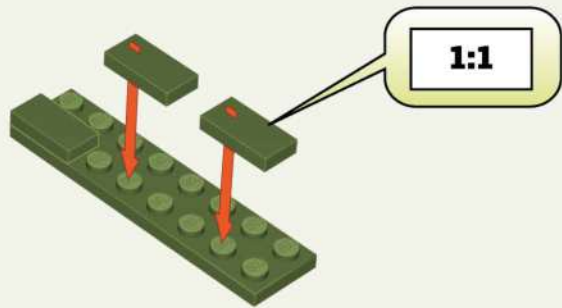

64

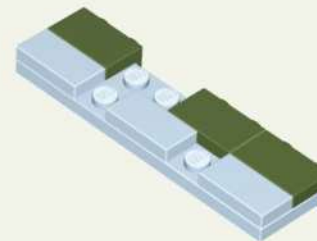

65

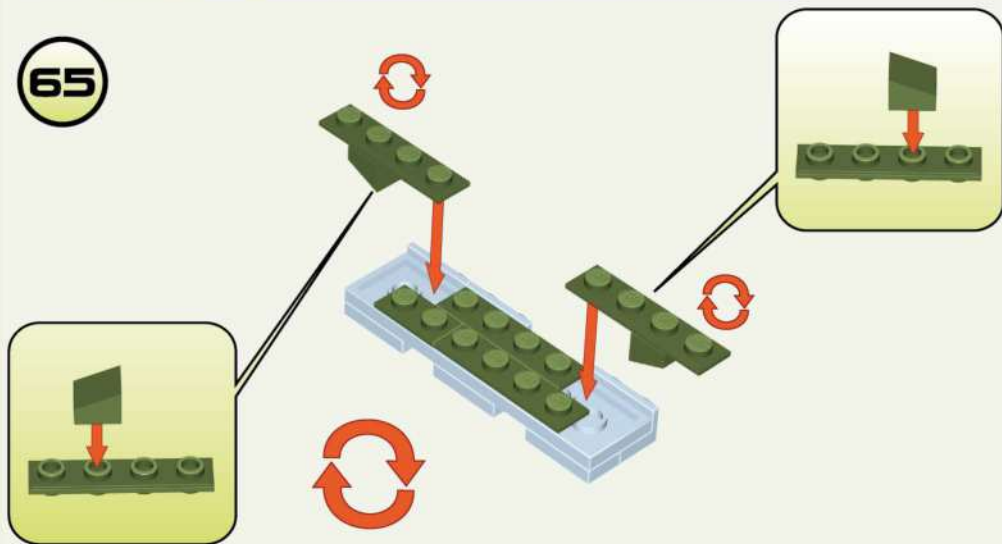

66

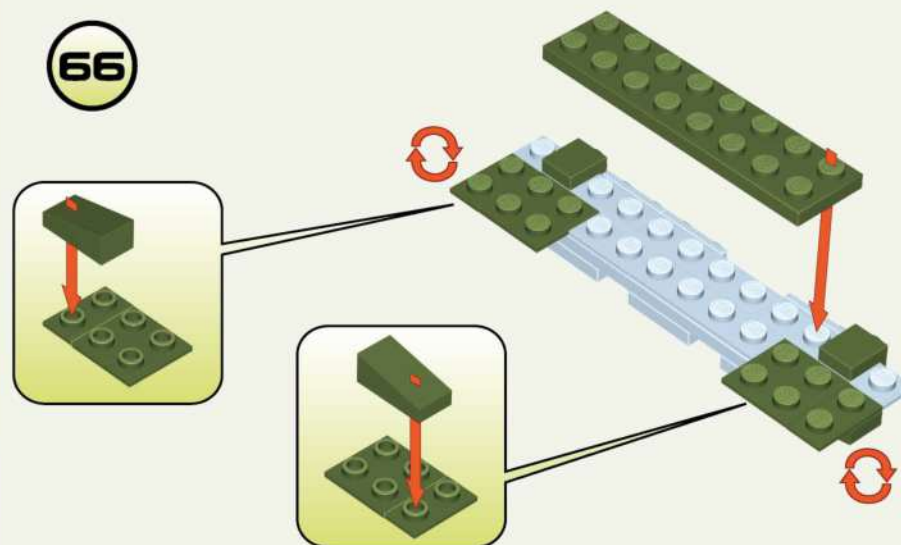

67

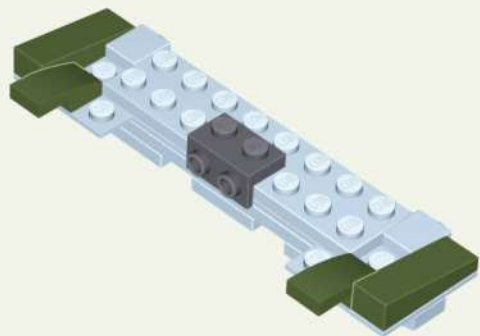

x2



x2



x1

68

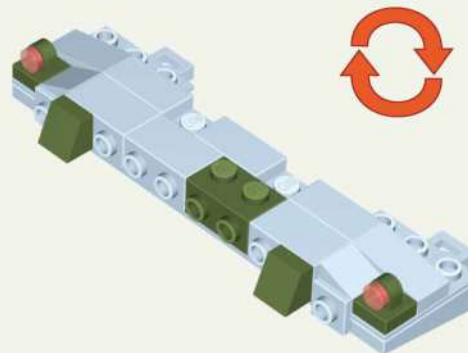

x2



x2



x2



x2



x1

69

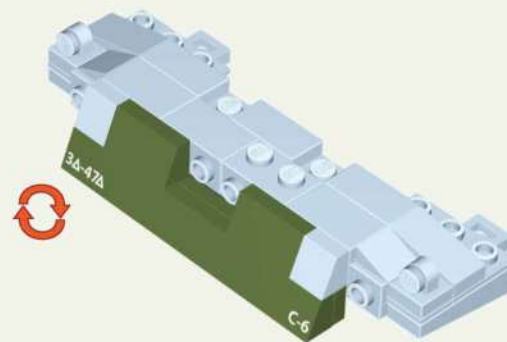
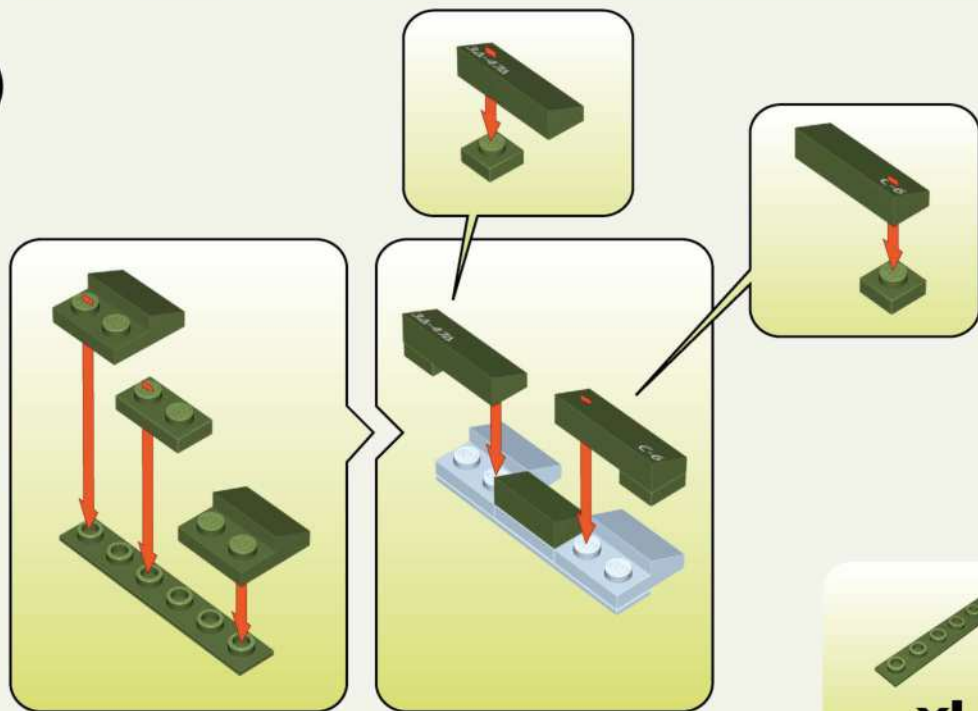

x1



x2



x1



x1



x2



x1



x1

70

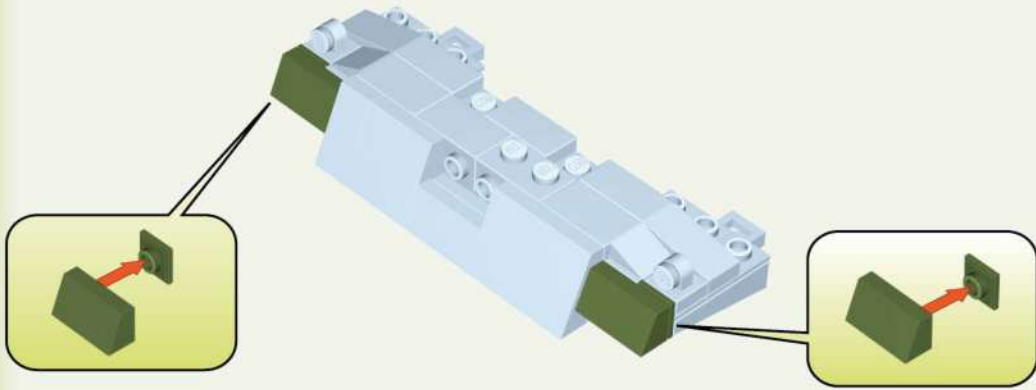

71

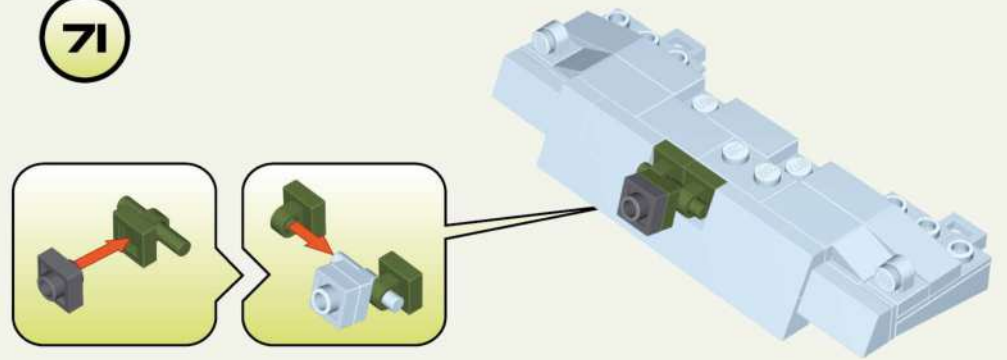

72

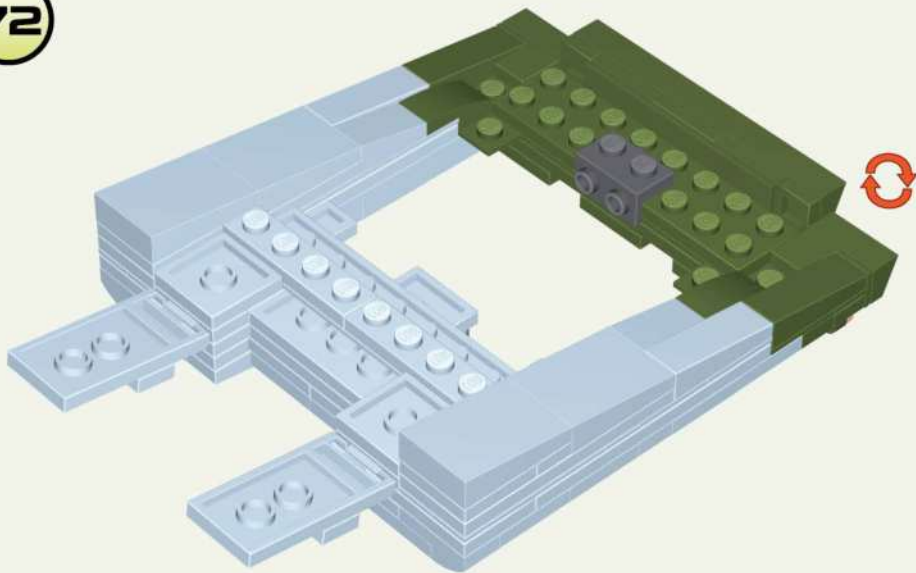

73

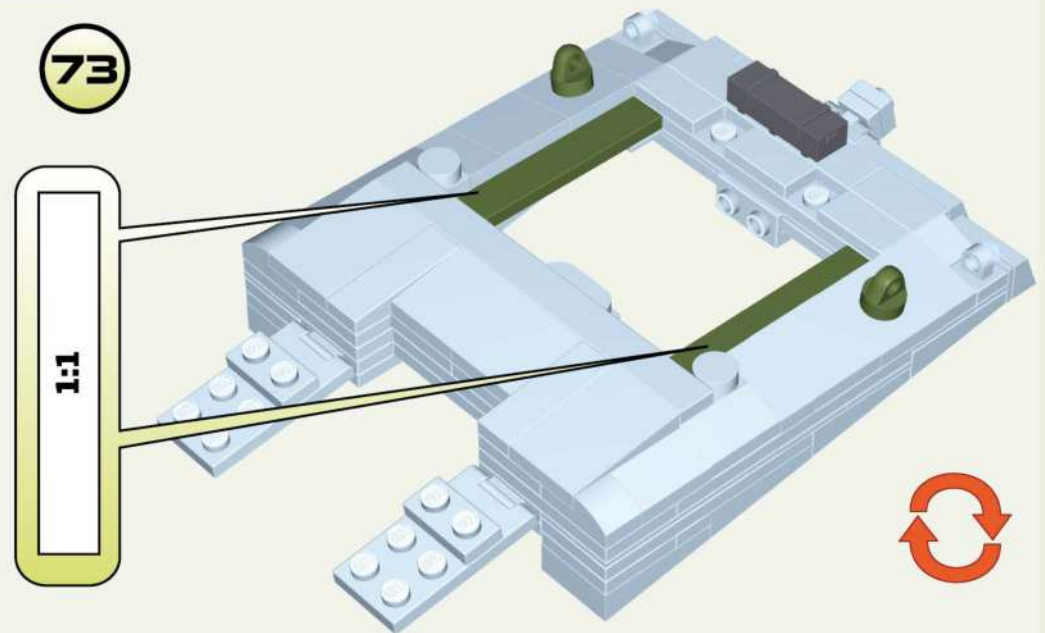

74

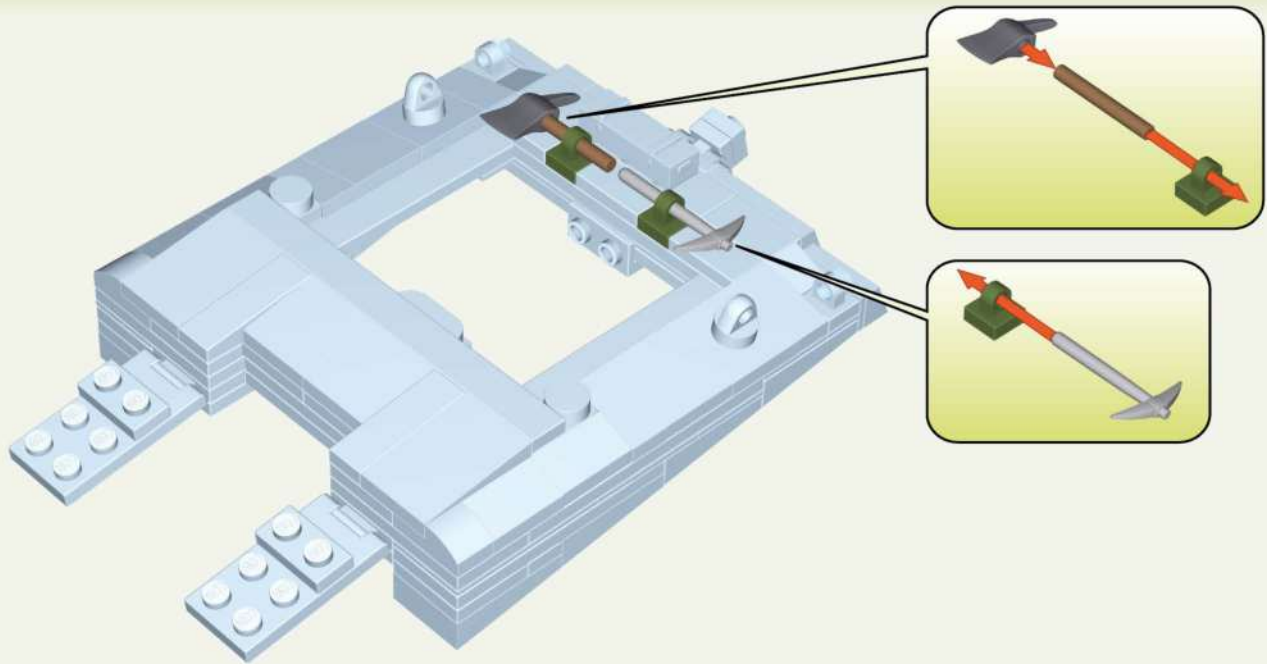

1:1

x1

x1

x2

x1

75

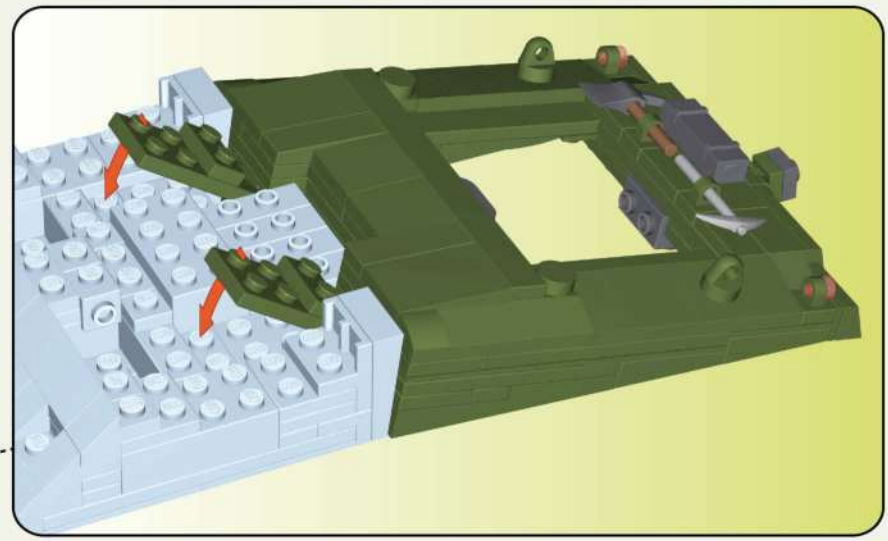
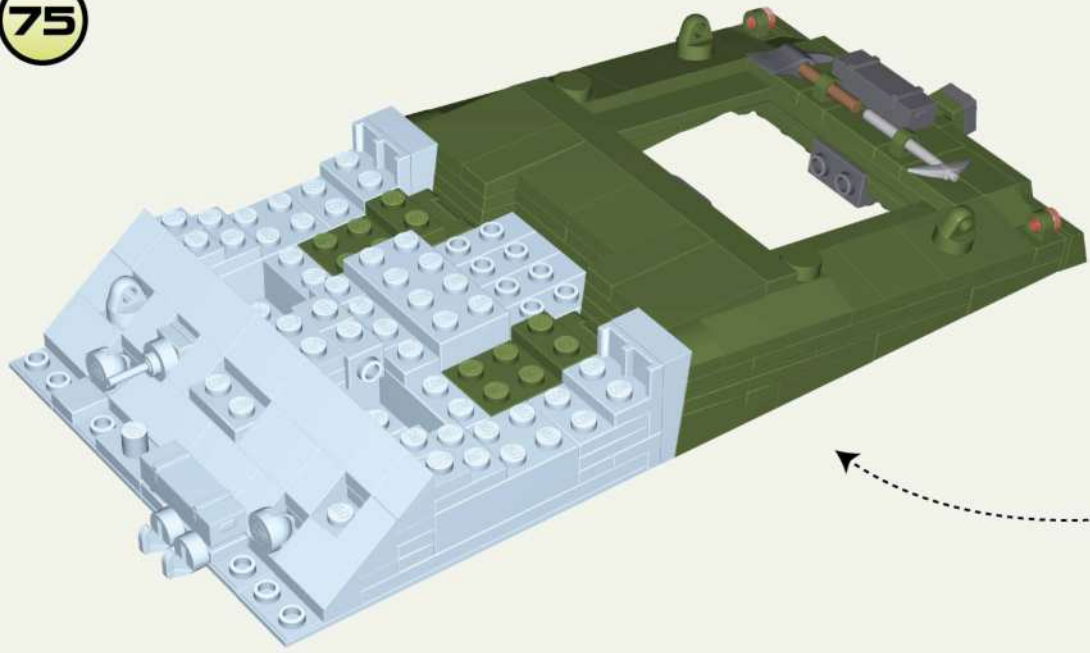

76

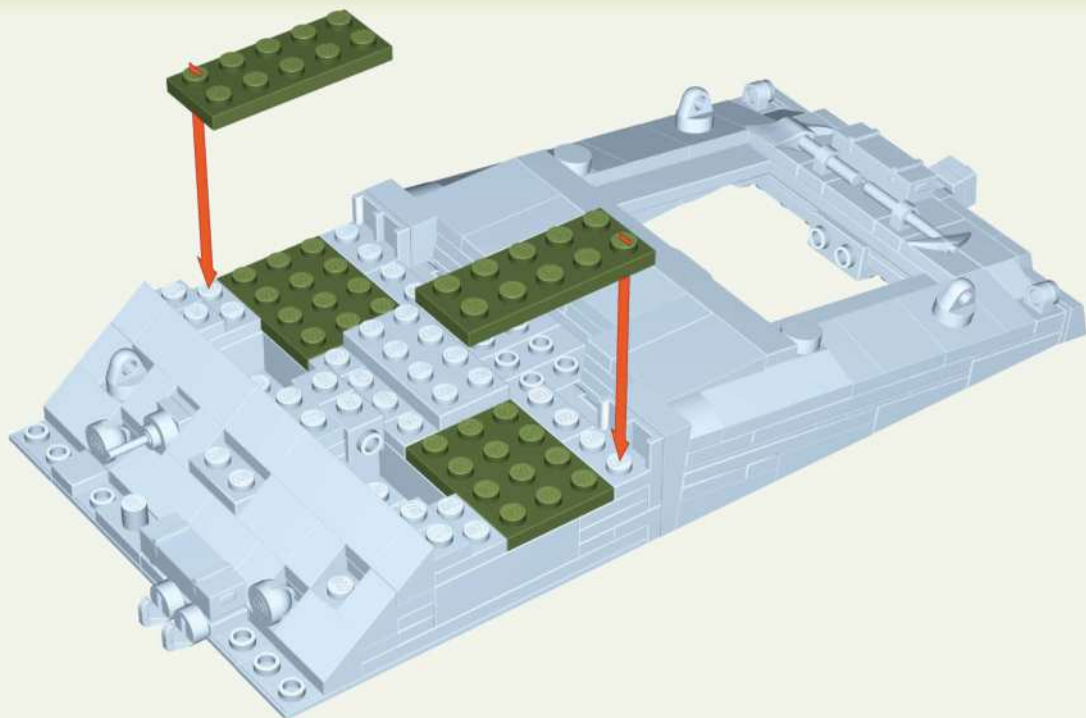

77

1:1

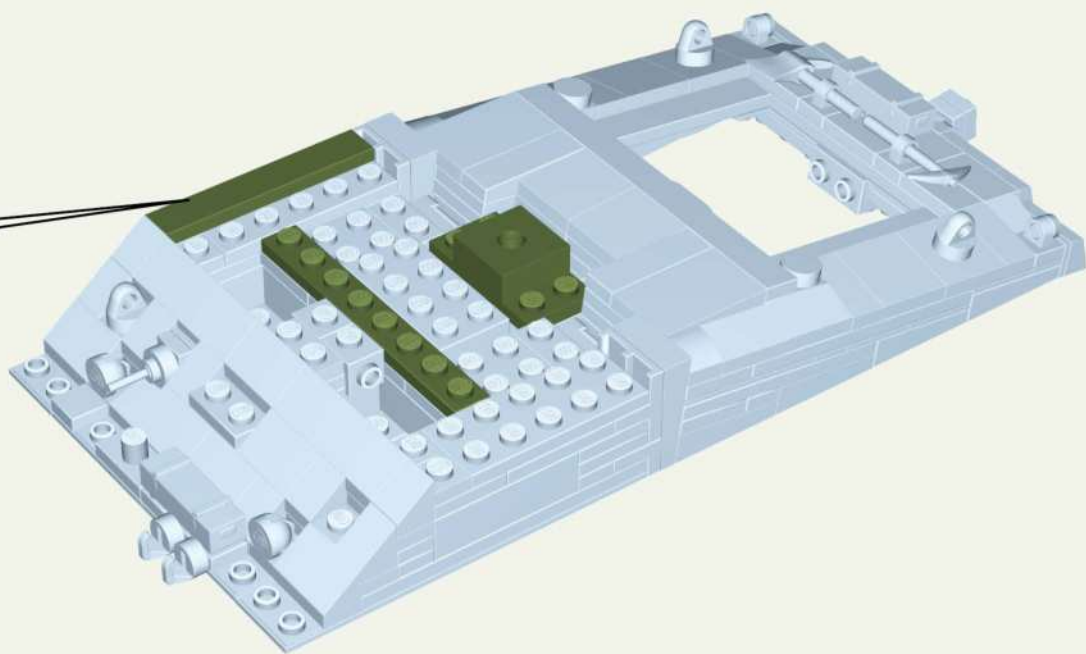

78

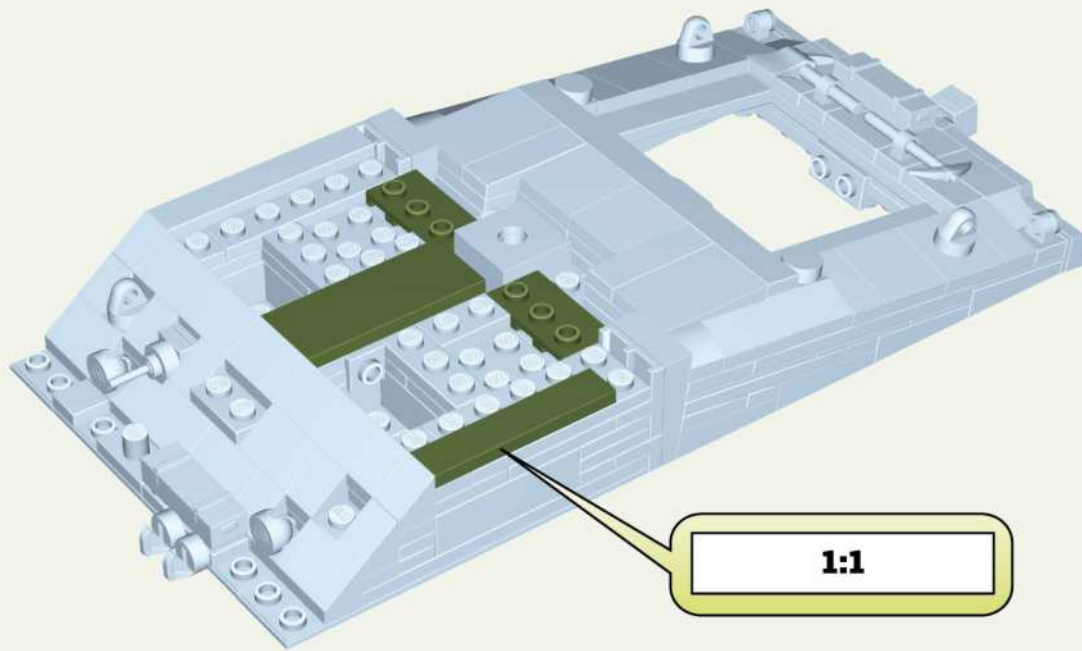

x2

x1

x1

79

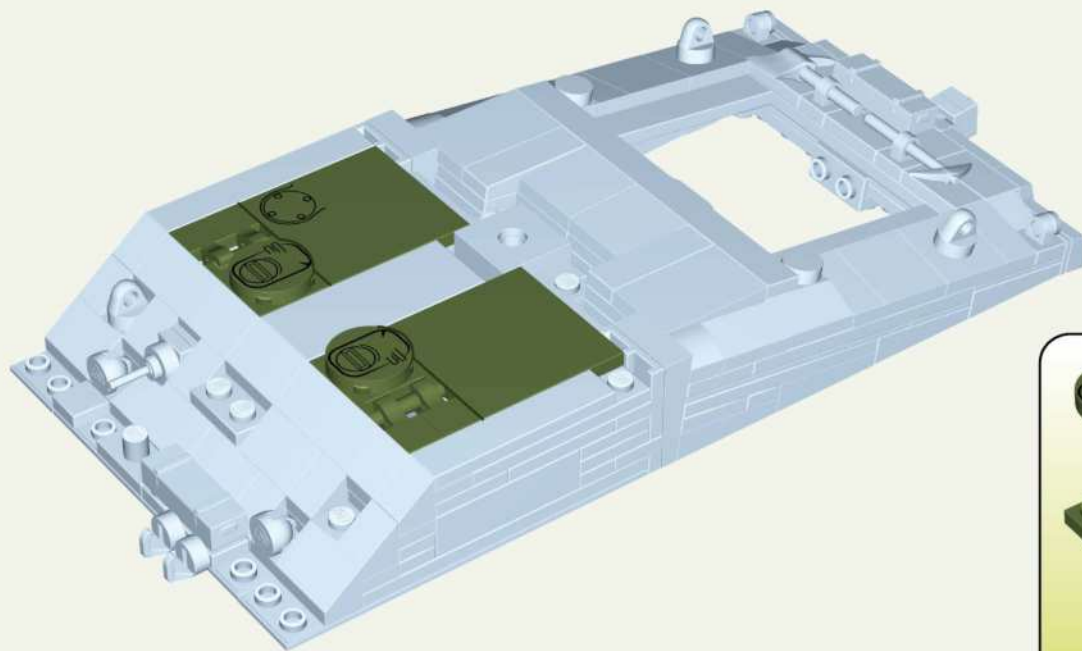
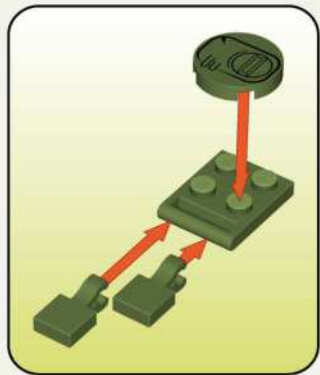

x2

x1

x1

x4

x1

x1

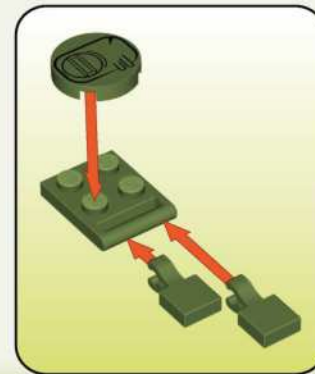

80

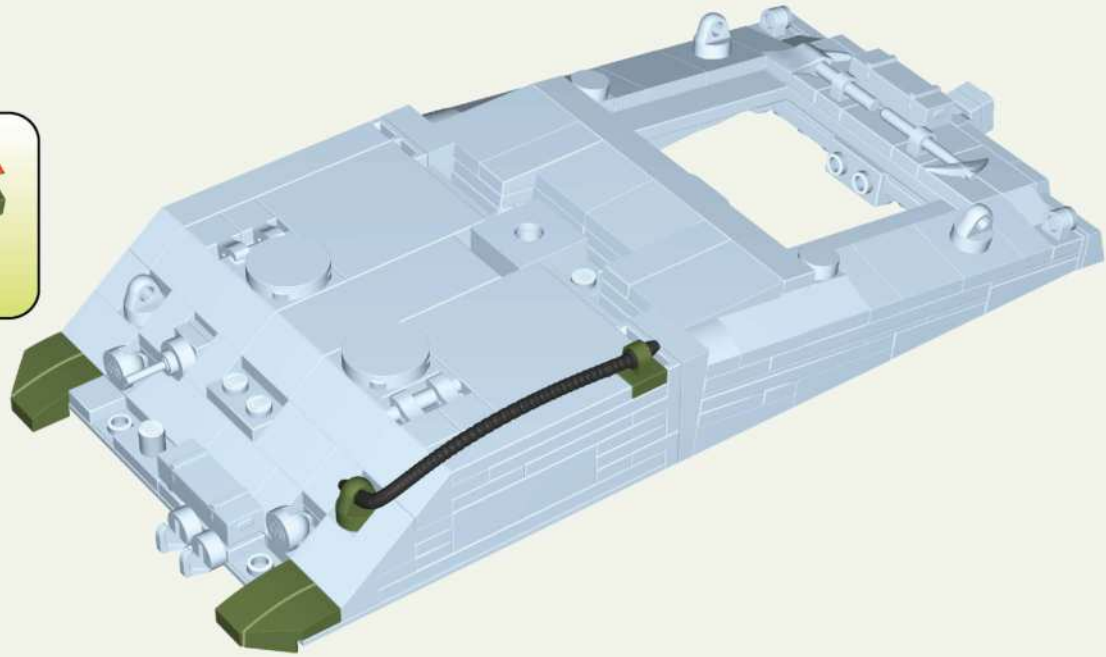



-  x1
-  x2
-  x1
-  x1
-  x1
-  x1

81

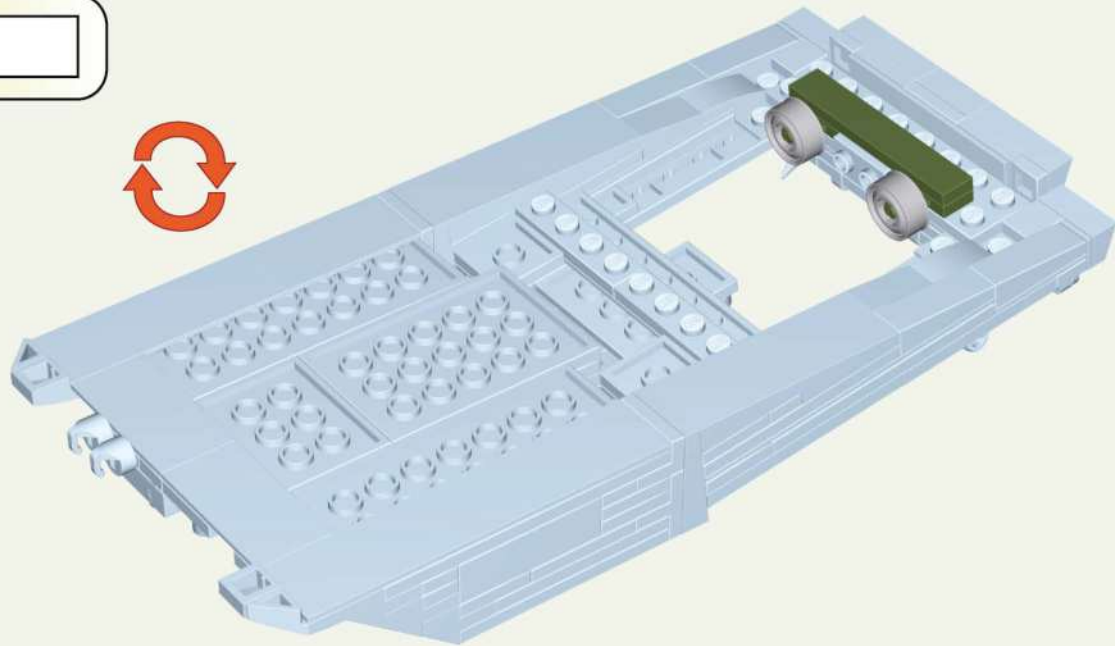
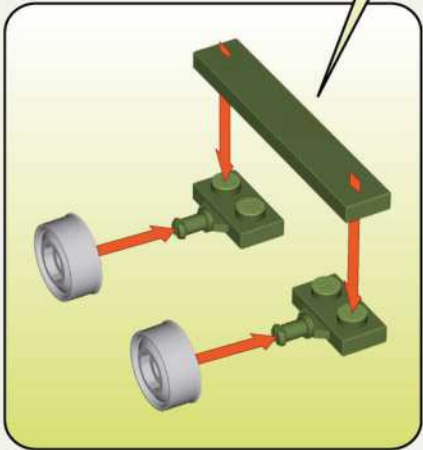
1:1



-  x2
-  x1
-  x2

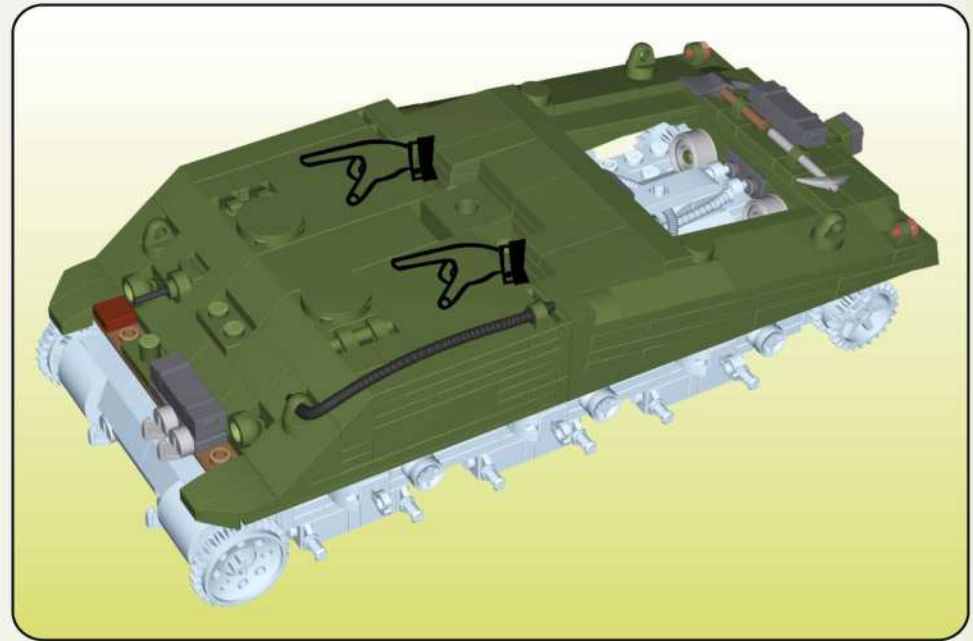
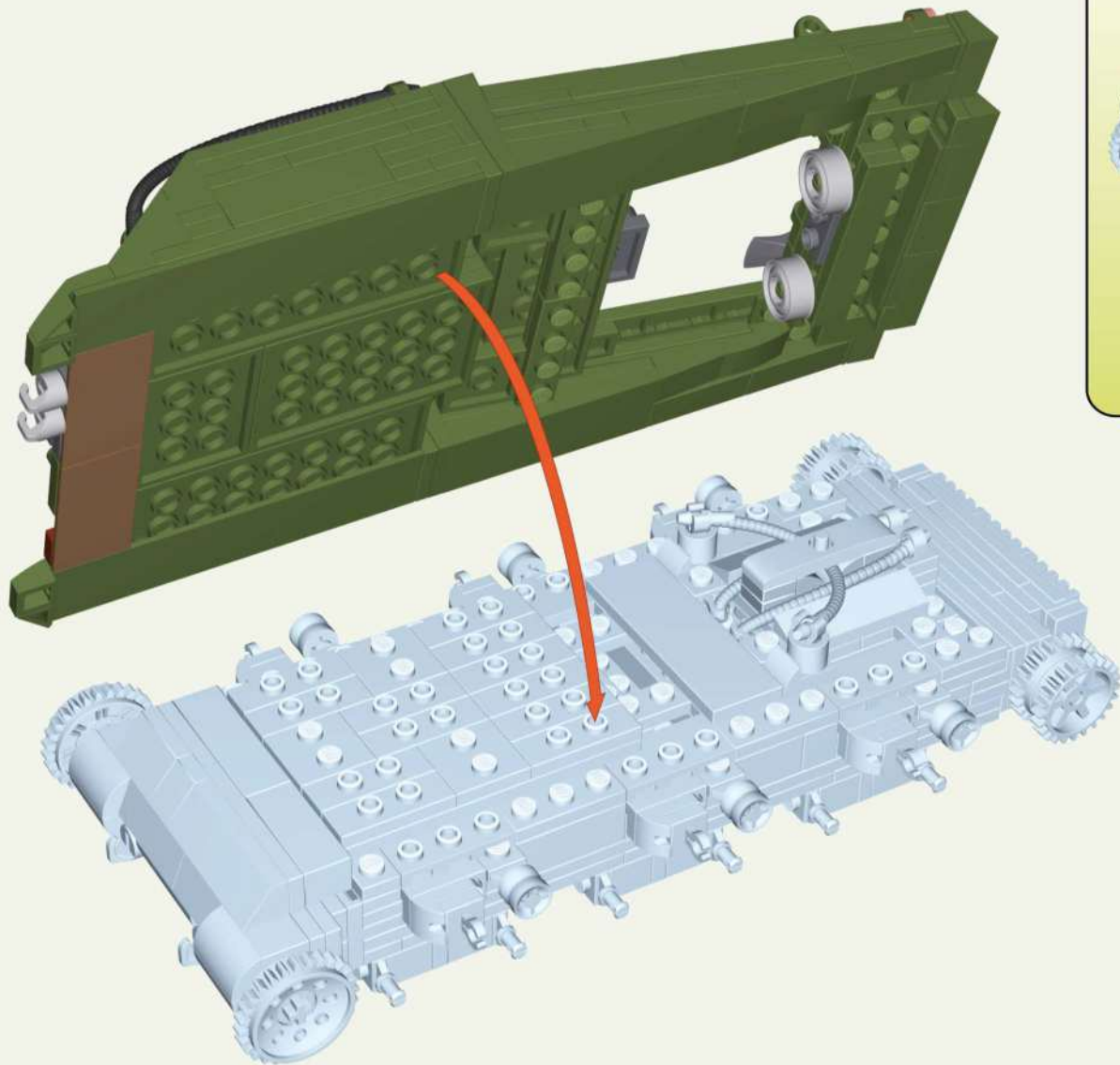

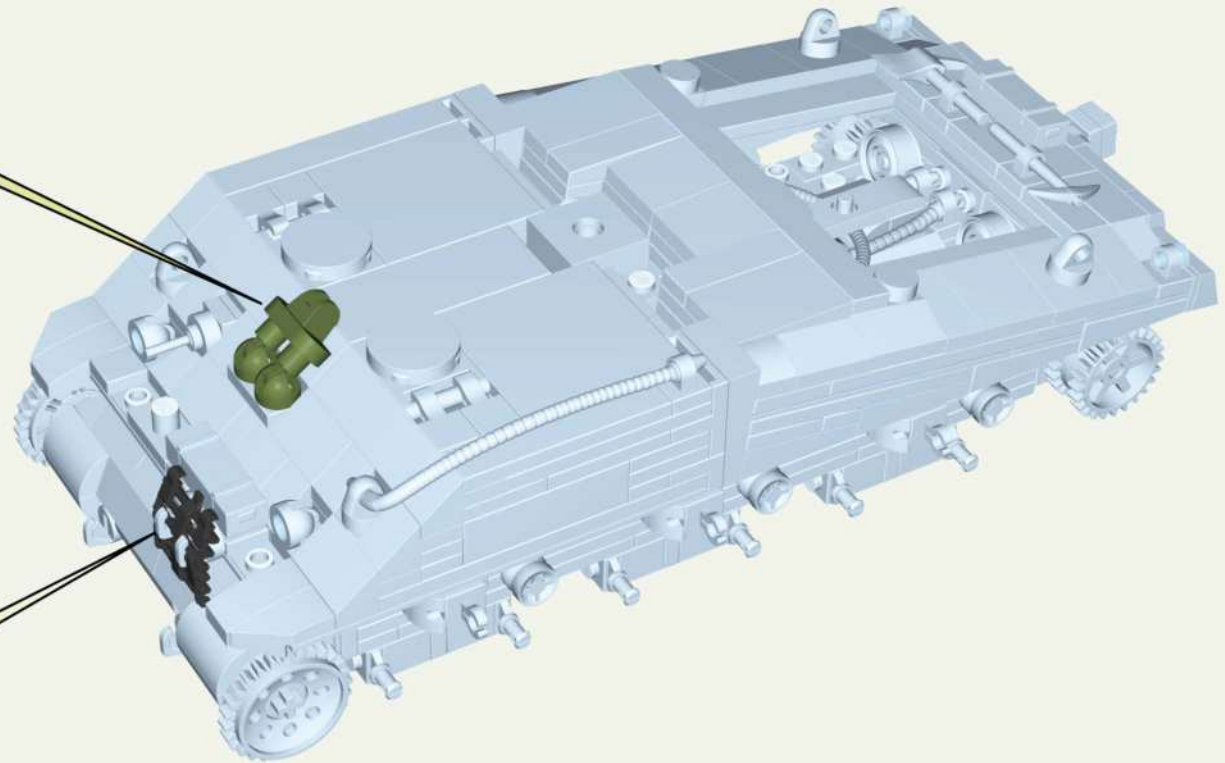
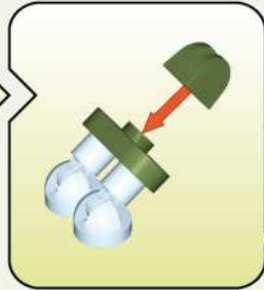
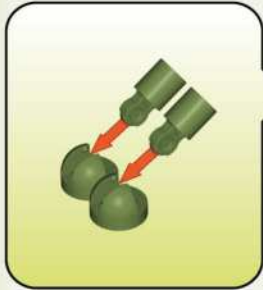

x2



x2

x2

x1

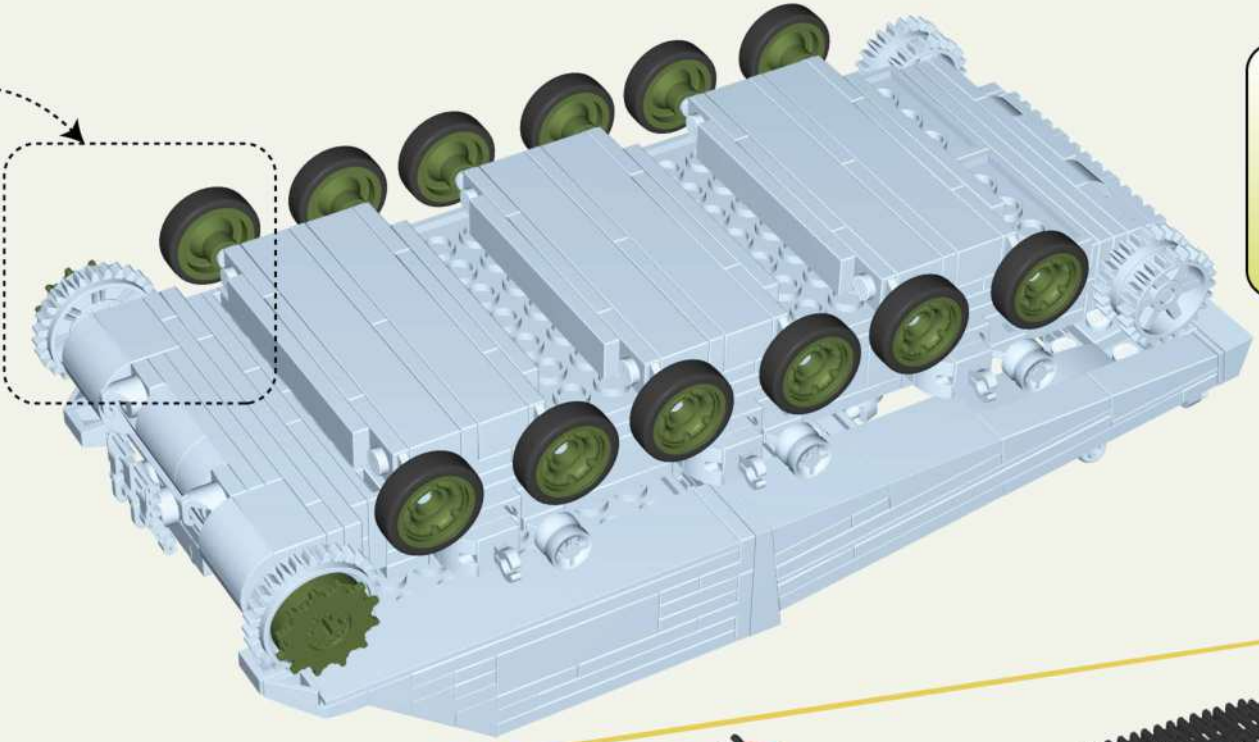
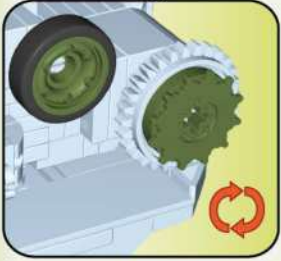

x1

84

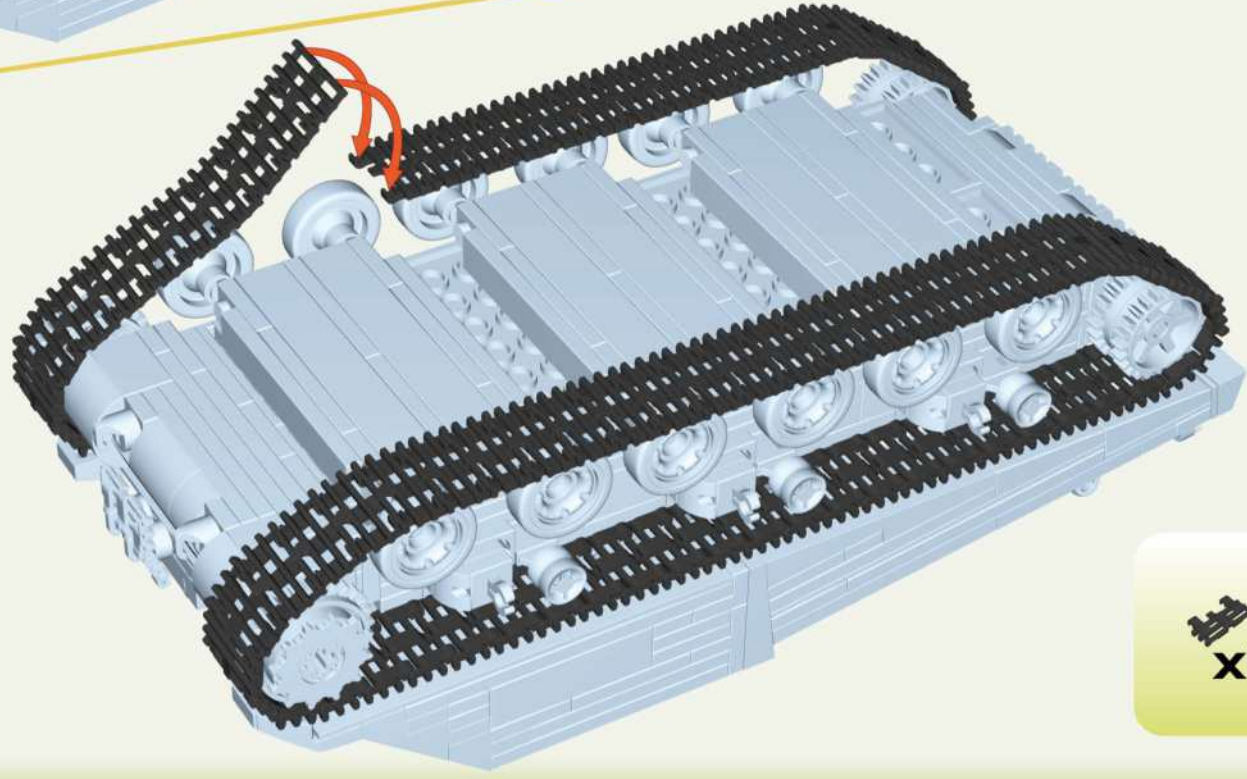
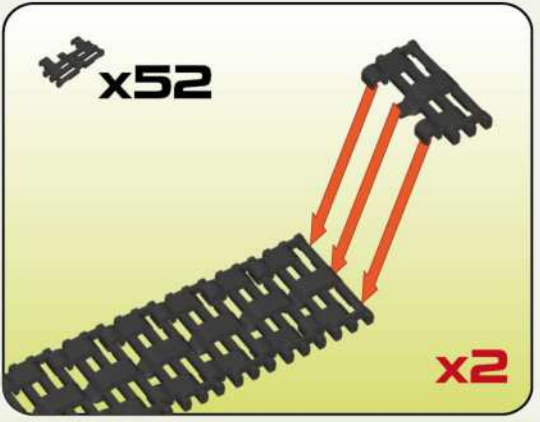

-  x12
-  x12
-  x2

85



-  x104

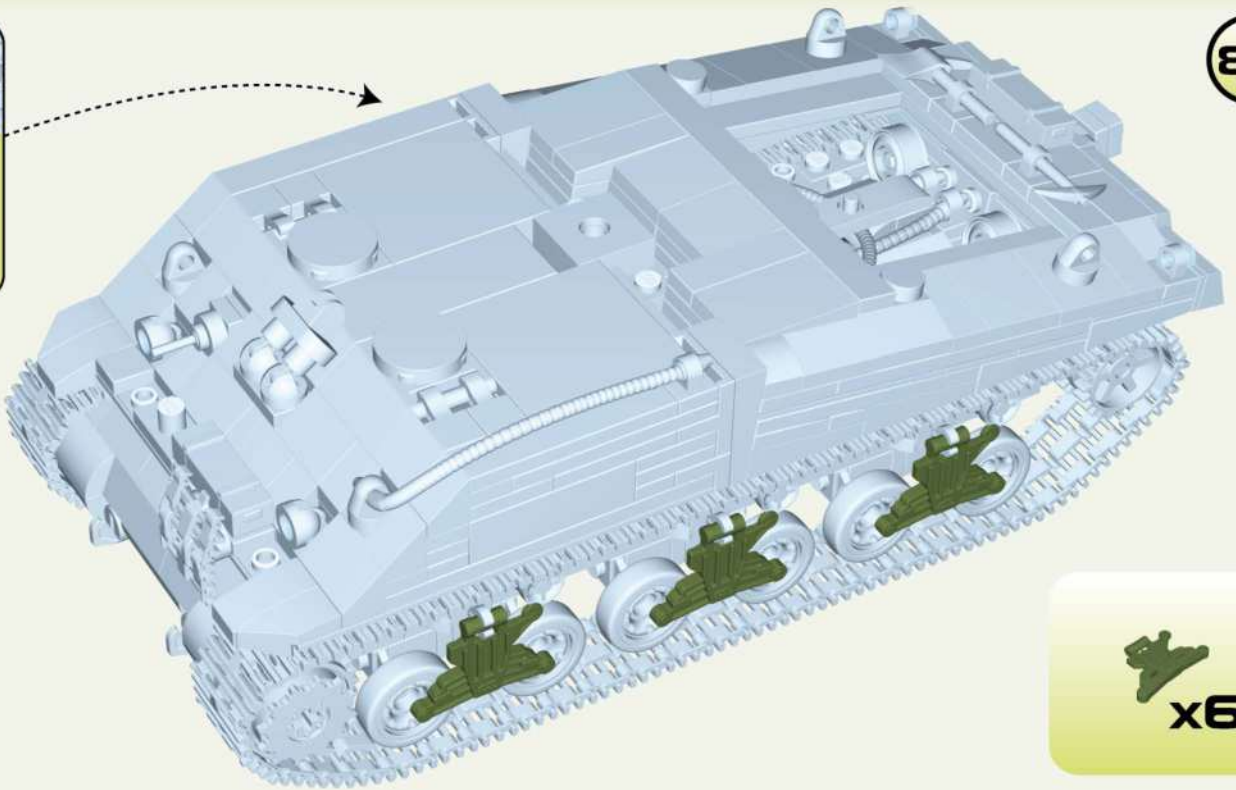
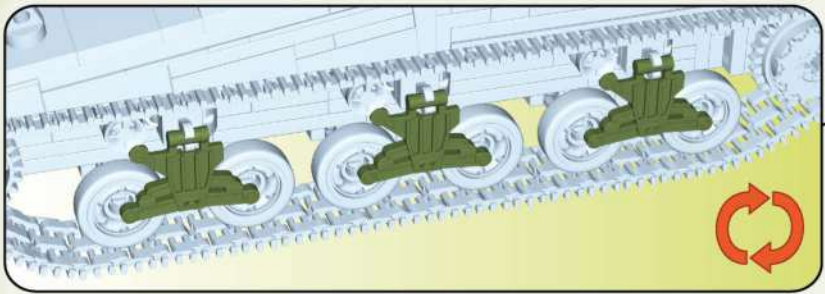

87

1:1

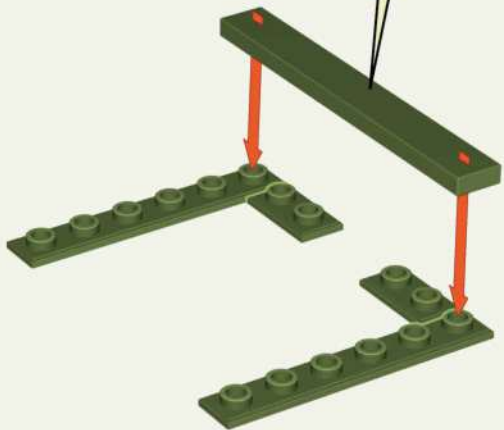

88

1:1

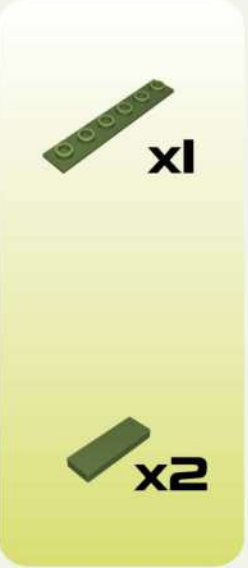
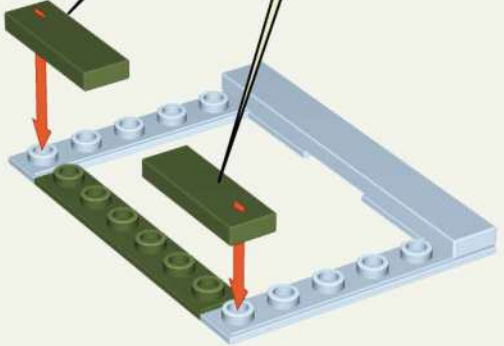

89

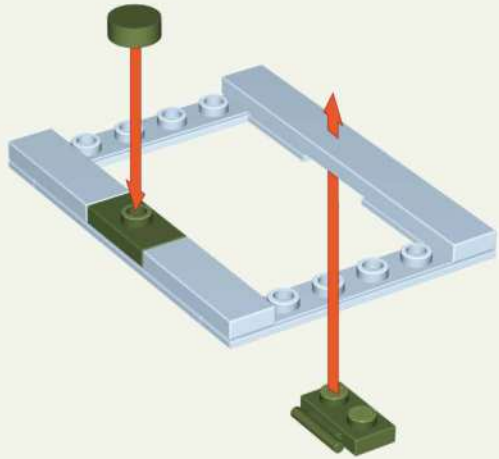

 x1

 x1

 x1

90

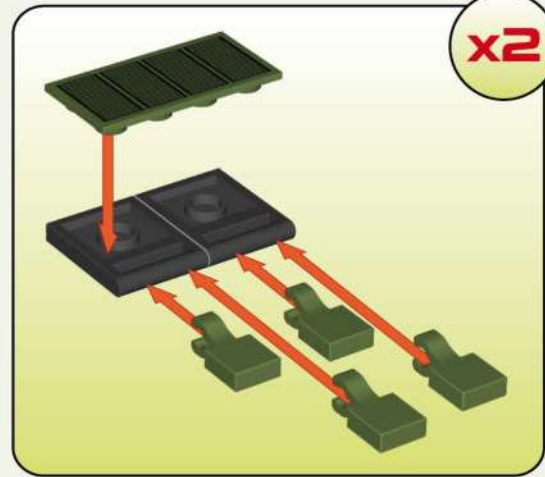

x2

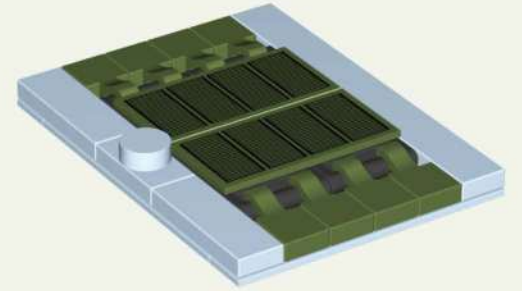

x8



x4



x2

91

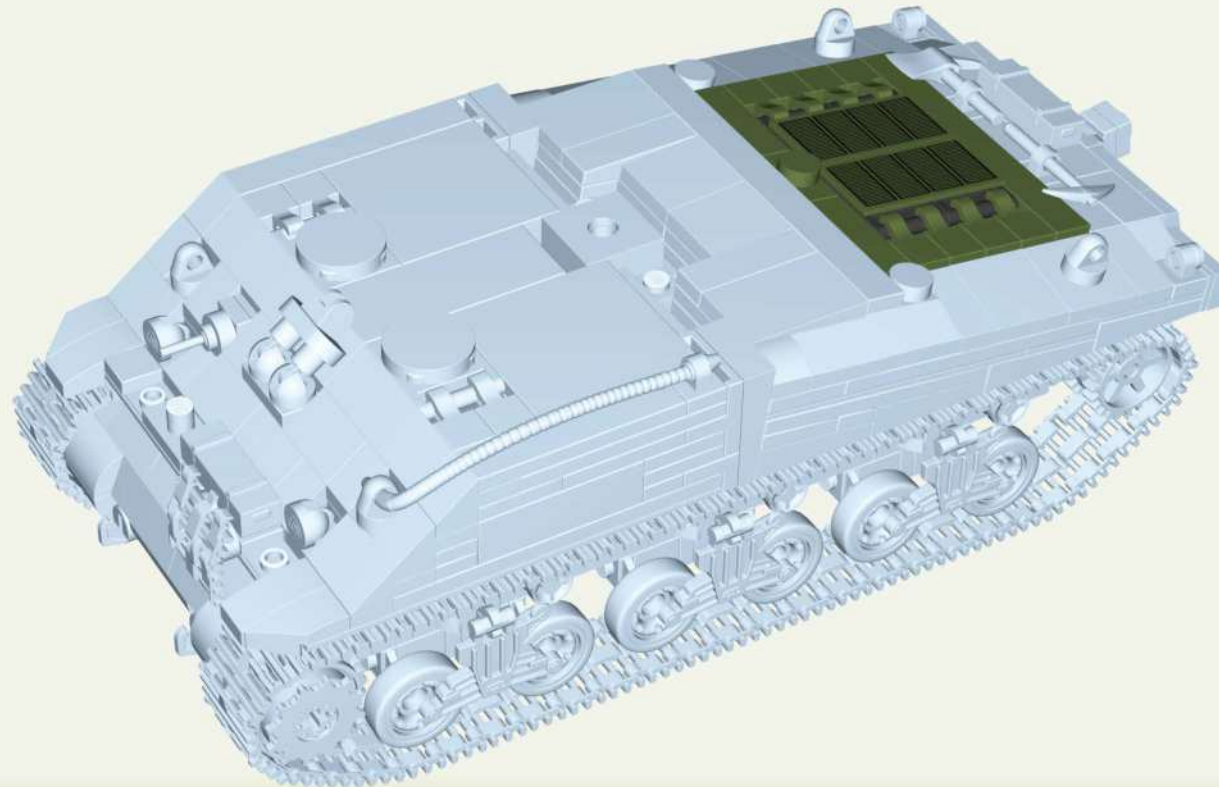

92

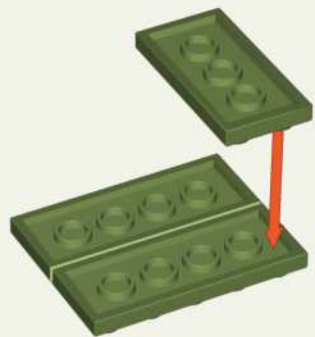

93



94



95



96

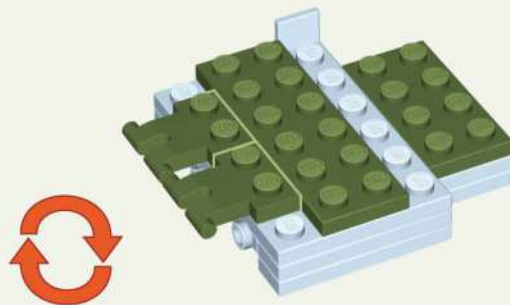

97

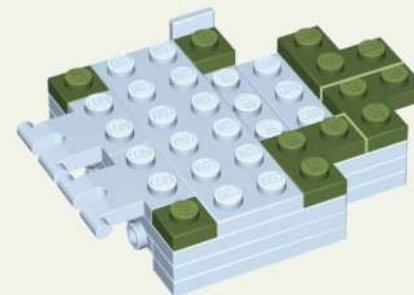

98

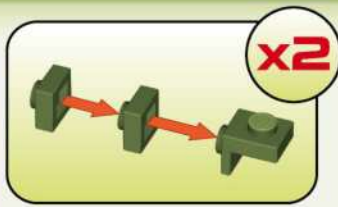
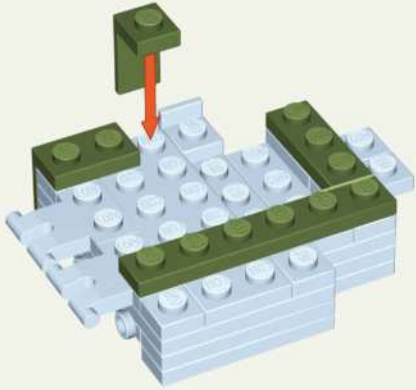

99

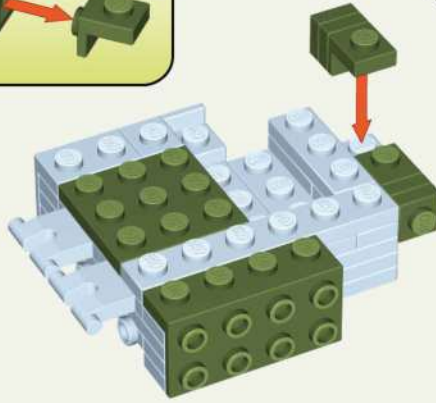

100

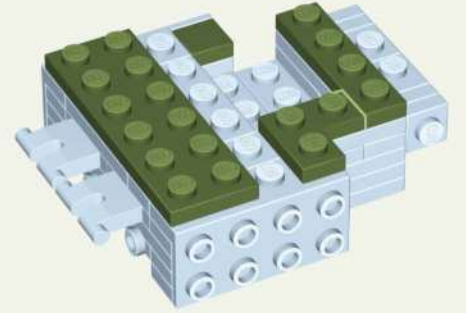

101

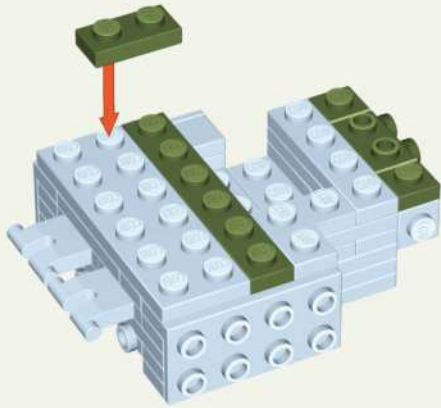

102

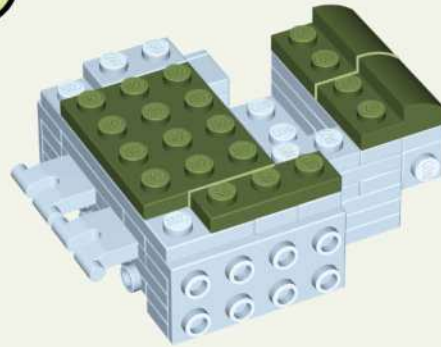

103

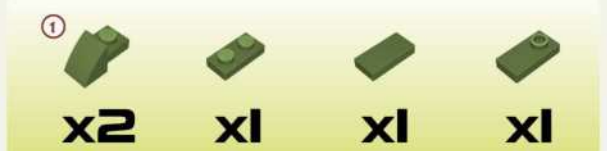
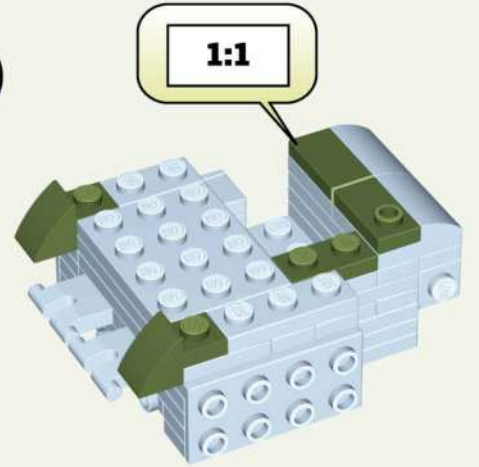

104

1:1

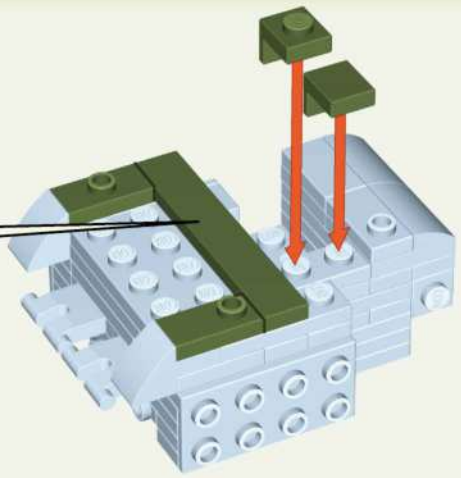

- 1x2 Technic pin (dark green) x1
- 1x2 Technic pin (dark green) x1
- 1x6 Technic beam (dark green) x1
- 1x2 Technic pin (dark green) x1
- 1x2 Technic pin (dark green) x1

105

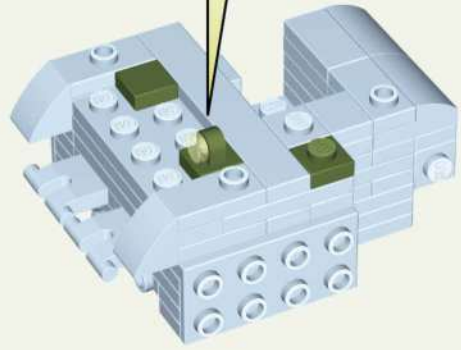

- 1x2 Technic pin (dark green) x1
- 1x2 Technic pin (dark green) x1
- 1x2 Technic pin (dark green) x1
- 1x2 Technic pin (dark green) x1

106

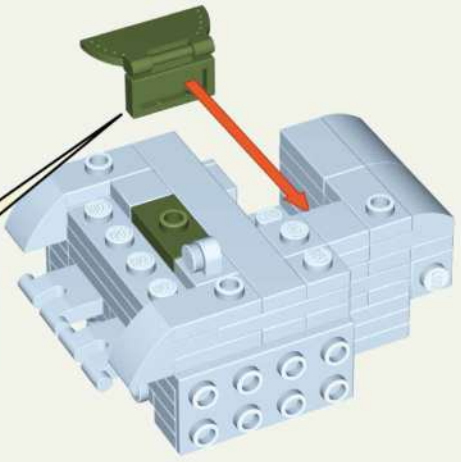
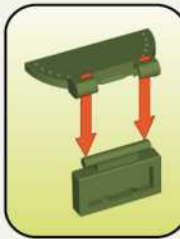

- 1x2 Technic pin (dark green) x1
- 1x2 Technic pin (dark green) x1
- 1x2 Technic pin (dark green) x1

107

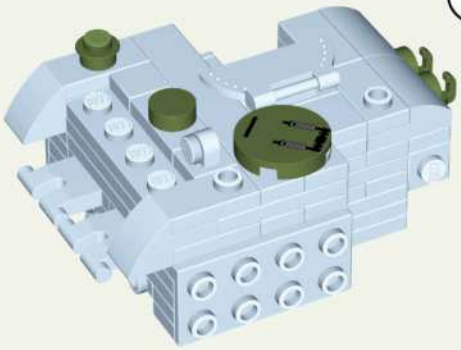

- 1x2 Technic pin (dark green) x1
- 1x2 Technic pin (dark green) x1
- 1x2 Technic pin (dark green) x1
- 1x2 Technic pin (dark green) x2

108



- 1x2 Technic pin (dark green) x1
- 1x2 Technic pin (dark green) x1

109

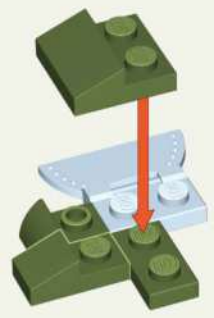

- 1x2 Technic pin (dark green) x1
- 1x2 Technic pin (dark green) x1
- 1x2 Technic pin (dark green) x1
- 1x2 Technic pin (dark green) x1

110

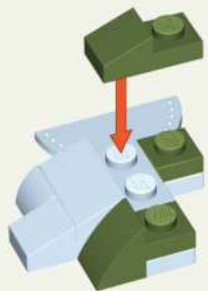

111

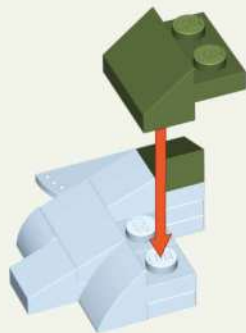

112

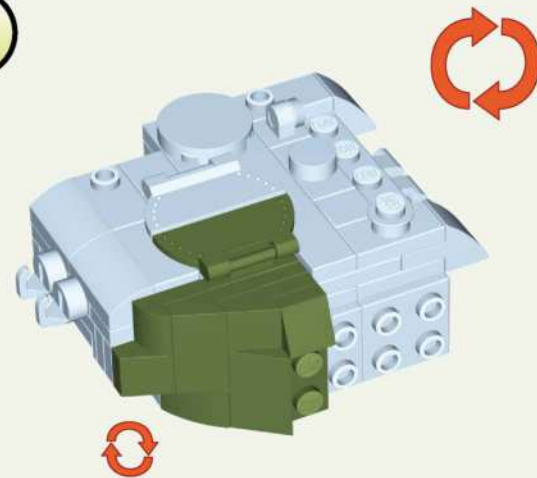

115

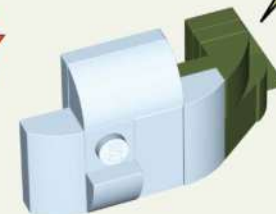
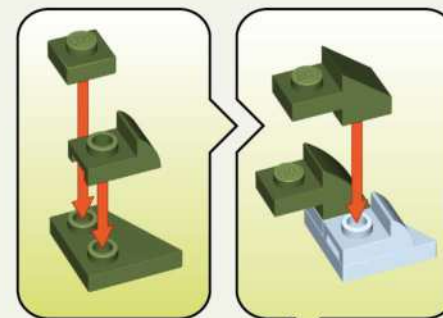

113



114

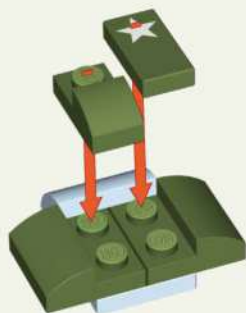

116

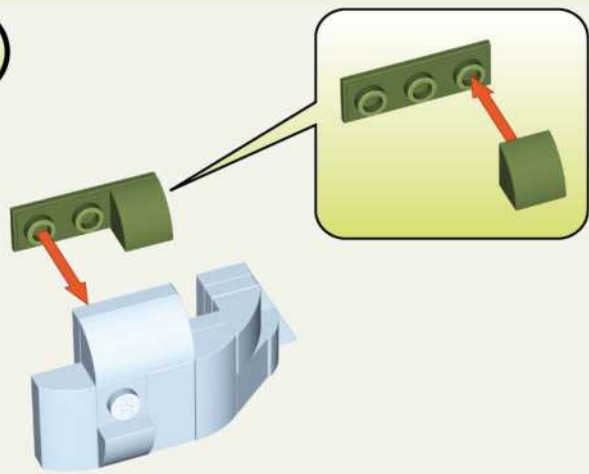

 **x1**
 **x1**

117

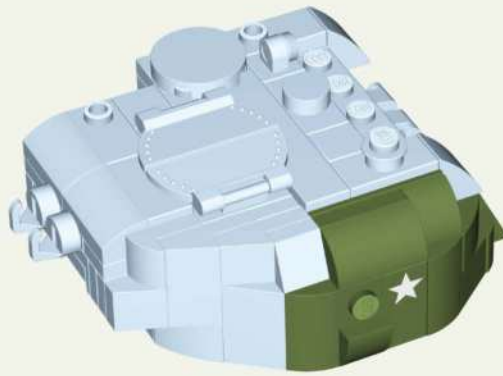

118

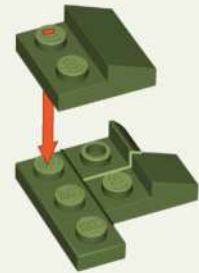

 **x1**
 **x1**
 **x1**
 **x1**

119

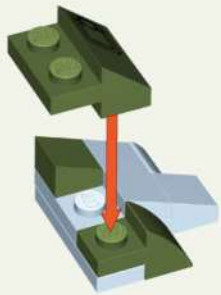

 **x1**
 **x1**
 **x1**

120

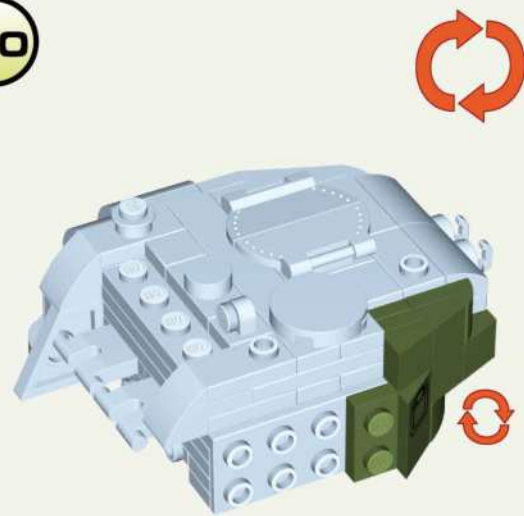

121



 **x1**
 **x1**

122

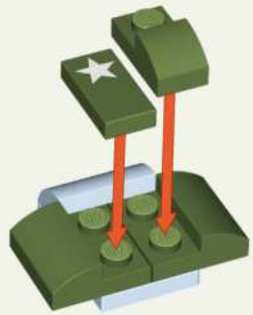

x2



x1



x1

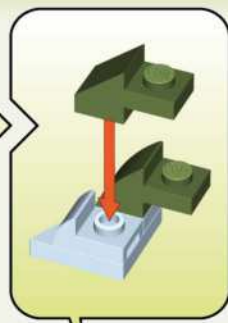
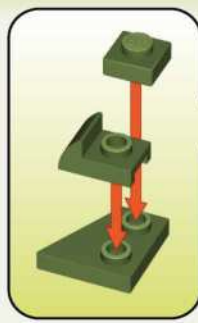

123



x1



x1



x1



x1



x1

124

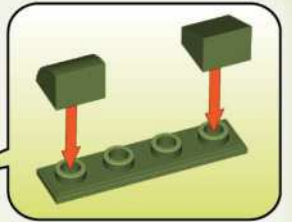
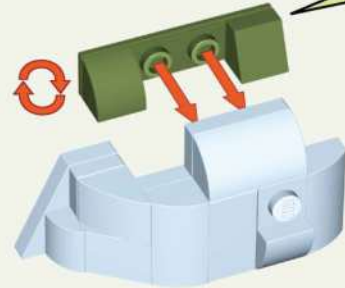

x1



x1



x1

125

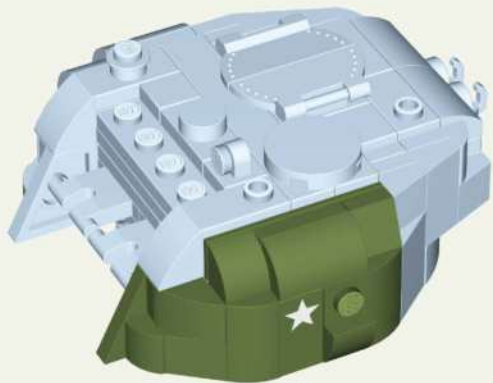

126

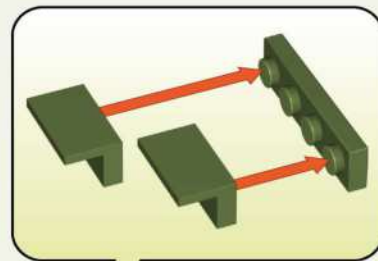

x1



x2

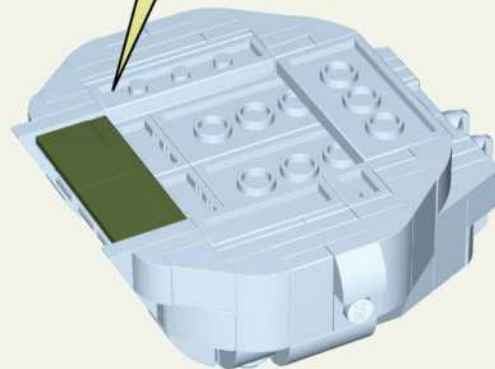

127

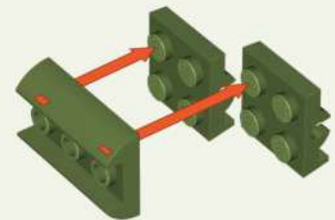

x1



x2

128

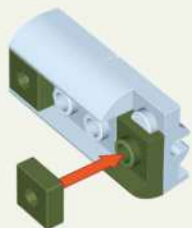



x2

x1

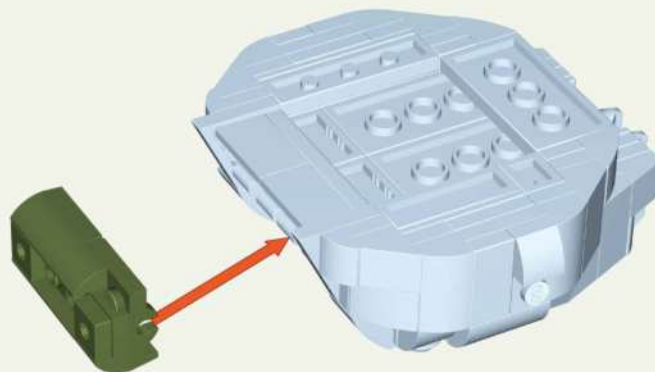
129

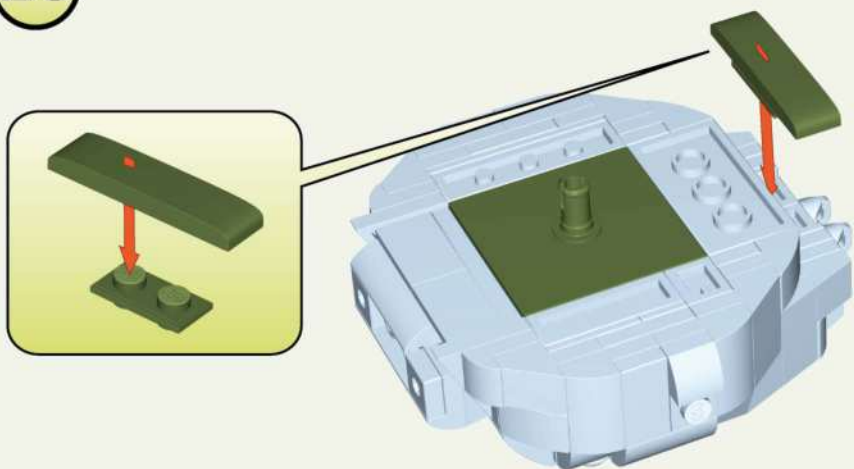

130





x1

x1

x1

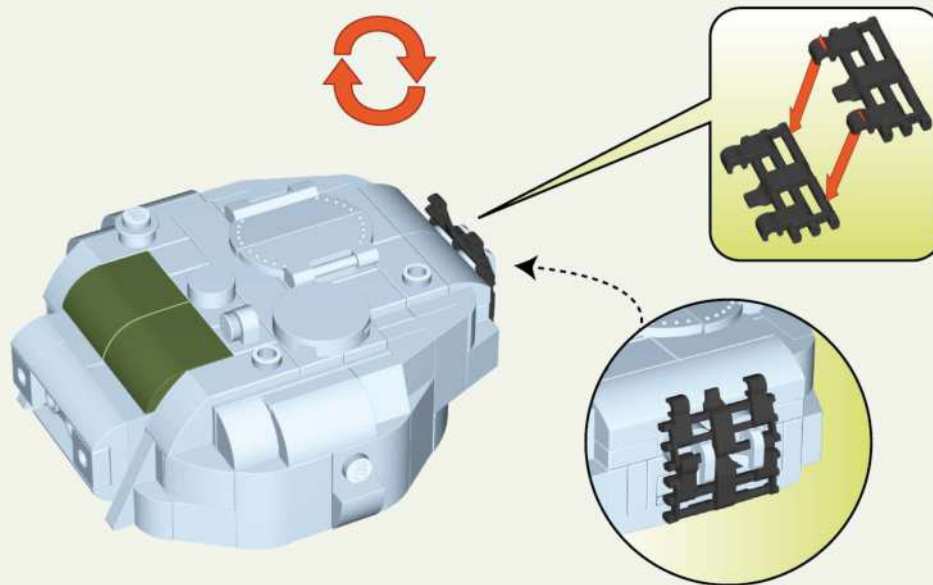
131





x2

x2

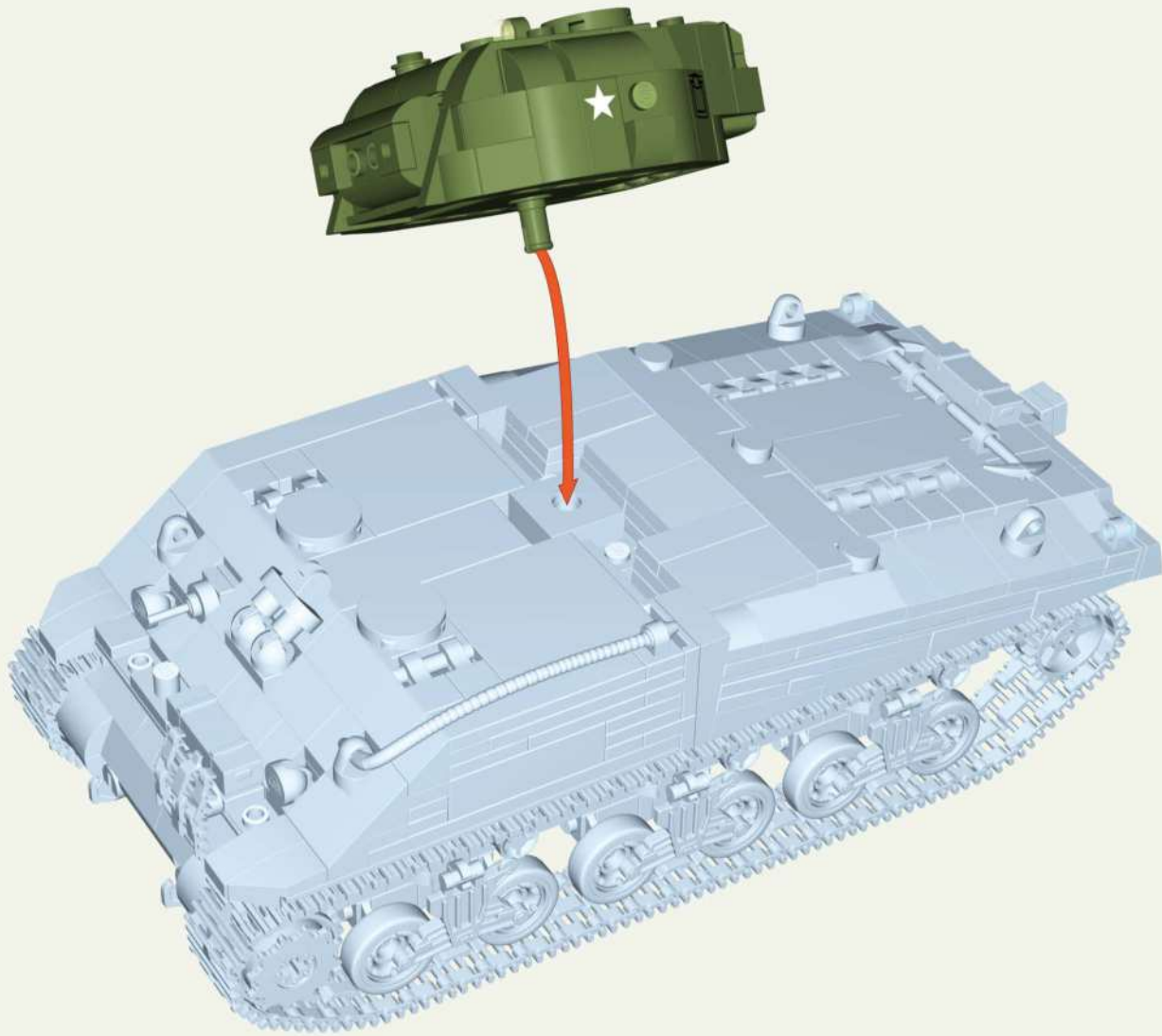
132

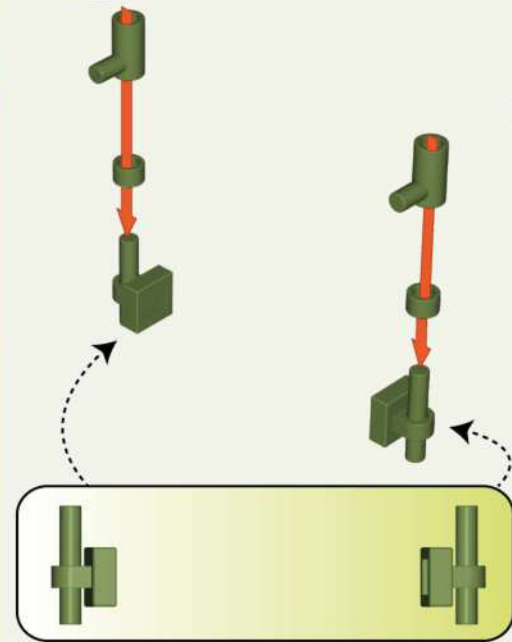

133



1:1

x2

x2

x2

x2

134



1:1

x2

x2



135



x2

x2

136

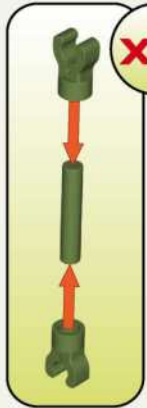

x2



1:1

x2

x4

137

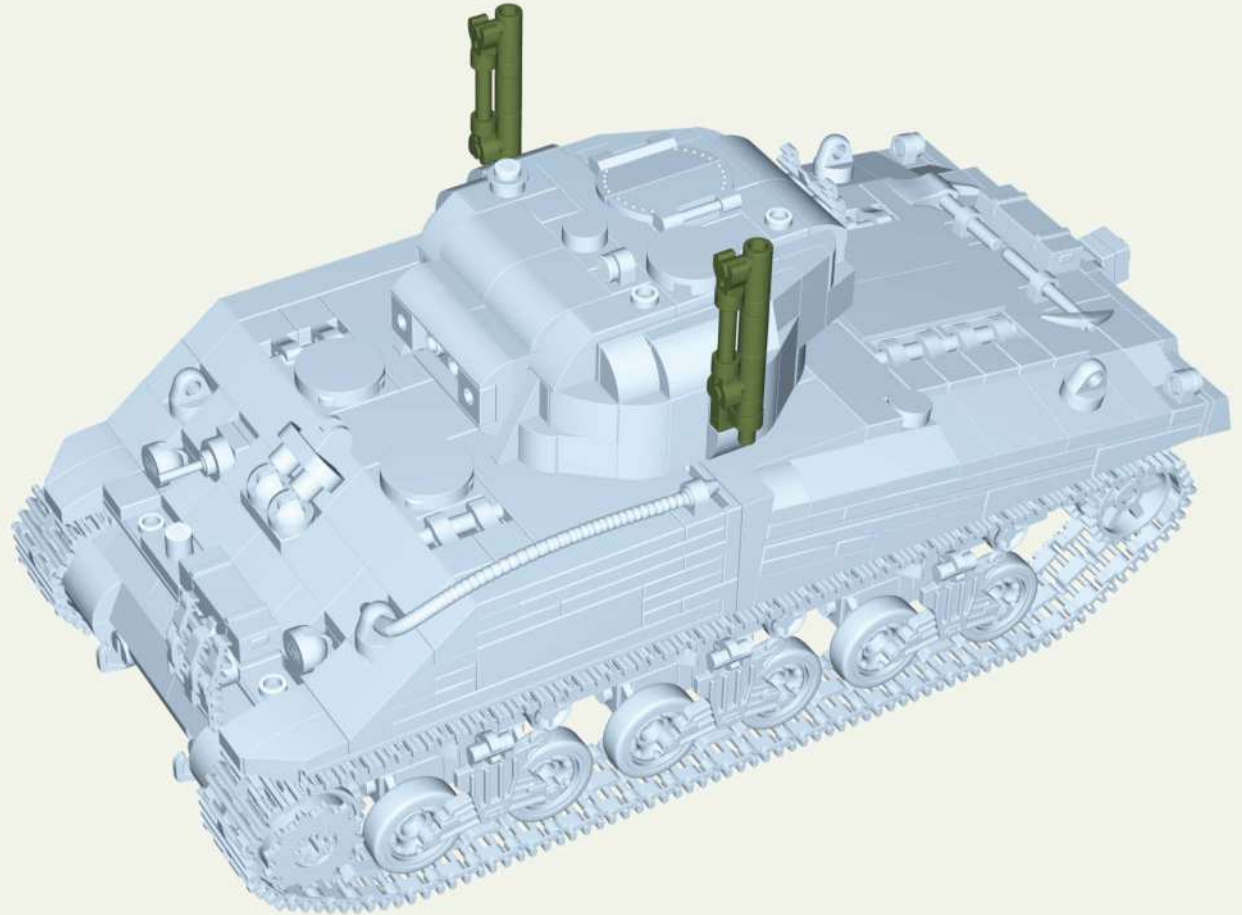

138 x6

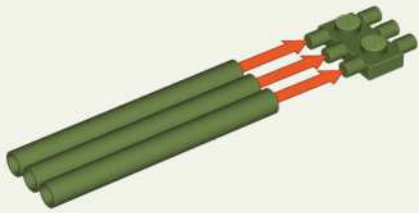

139 x6

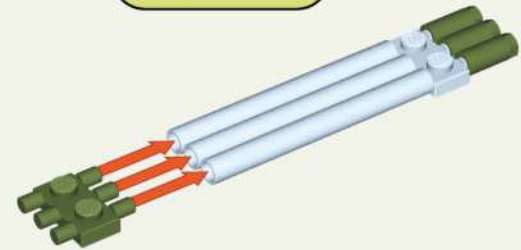

140 x6

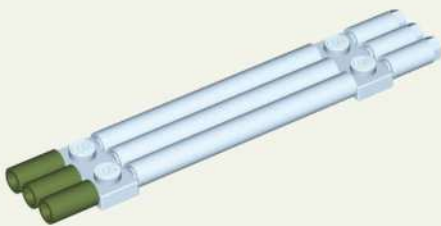

141

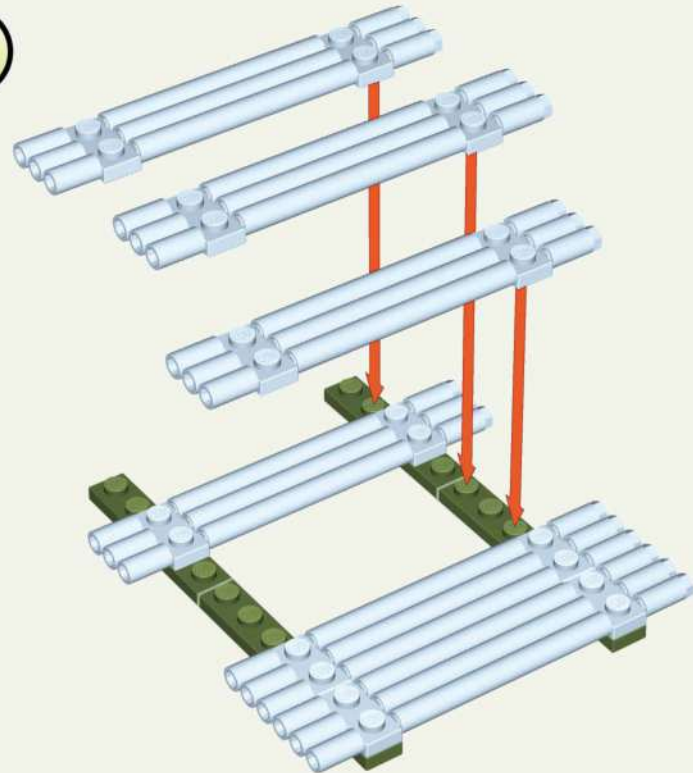



4

142

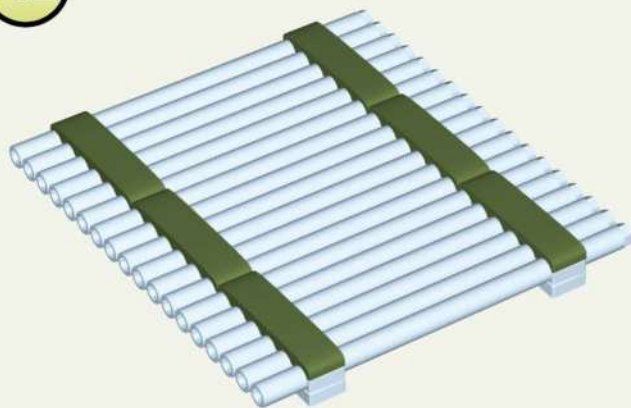

x6

143 x6

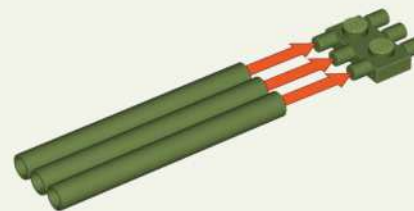

x1



x3

144 x6



x3

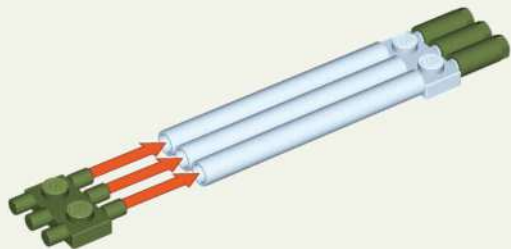

x1



x3



x3

145 x6



x3

146

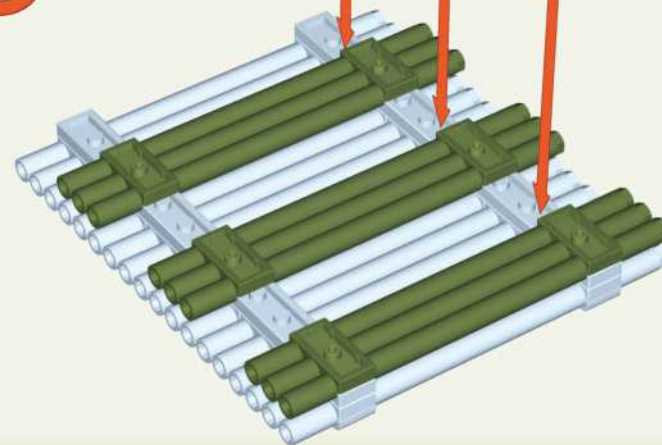
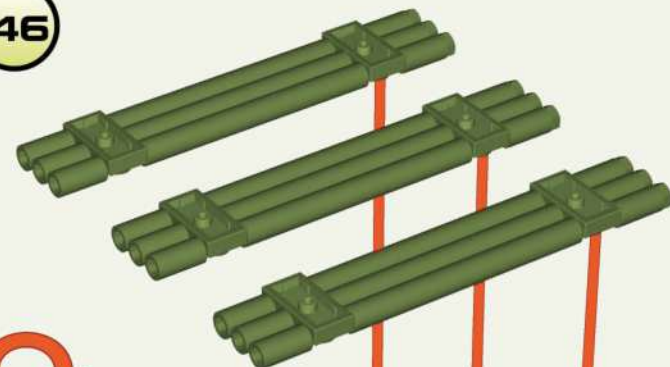

151

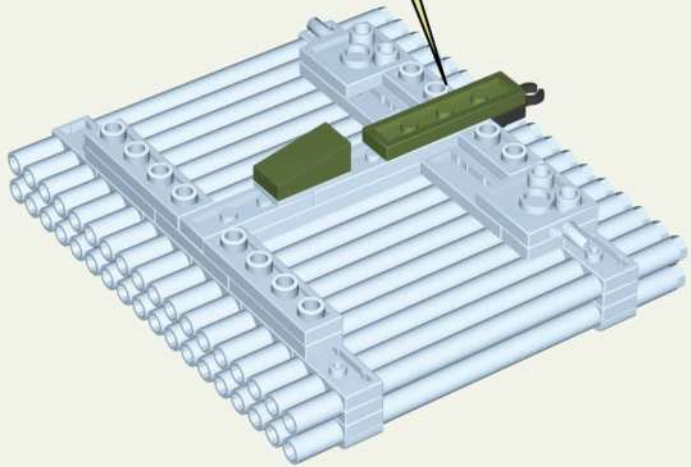

x1



x1



x1

152

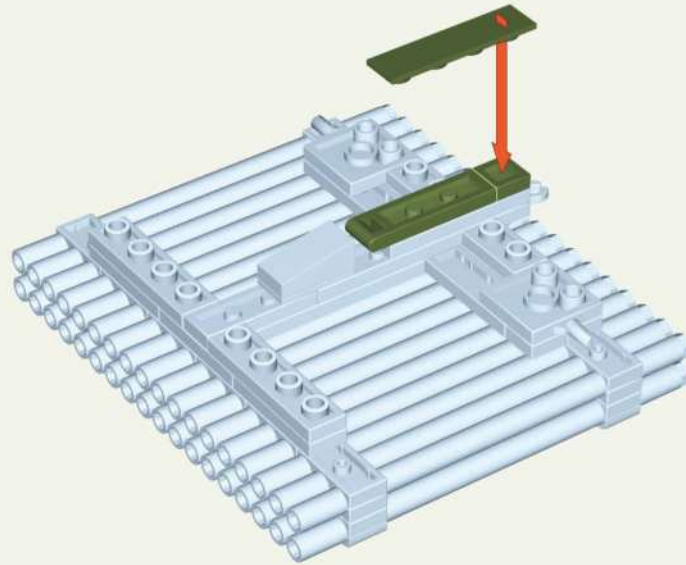

x1



x1



x1

153 x4

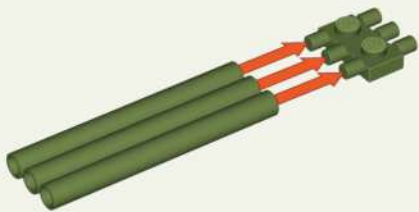

x1



x3

154 x4



x3

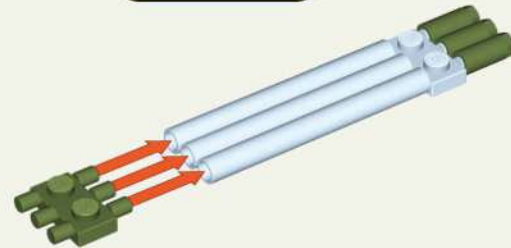

x1



x3



x3

155 x4

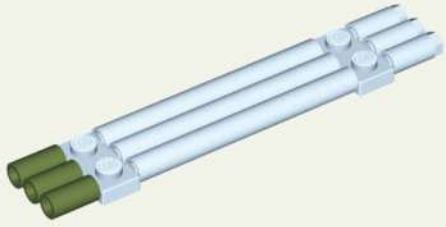

x3

156

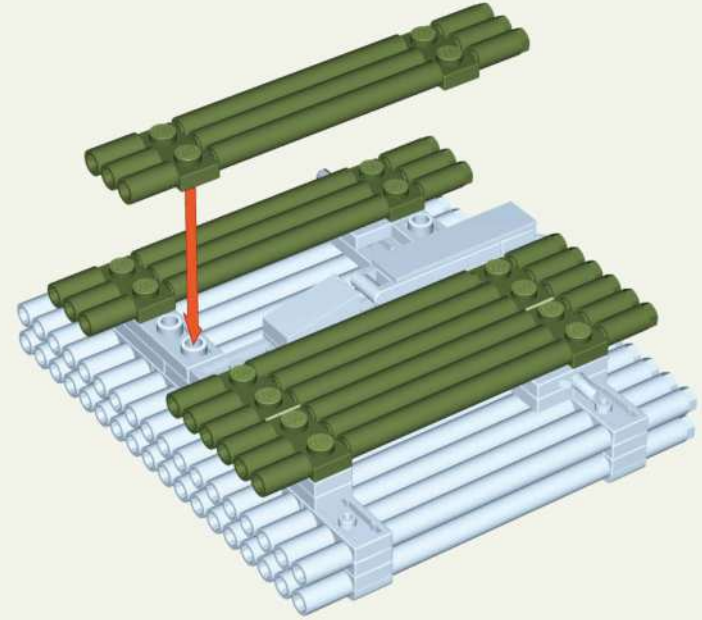

157

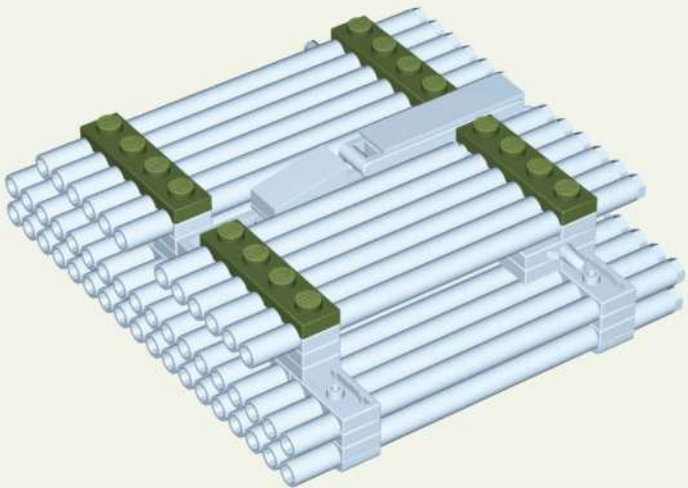

x4

158 x4

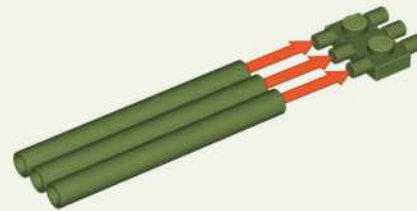

x1

x3

159 x4

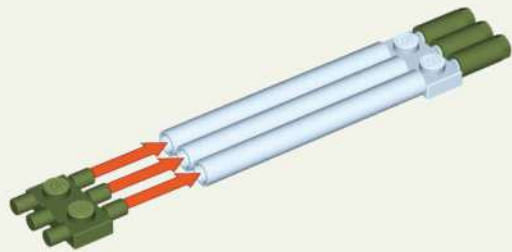

x1



x3



x3

160 x4



x3

161

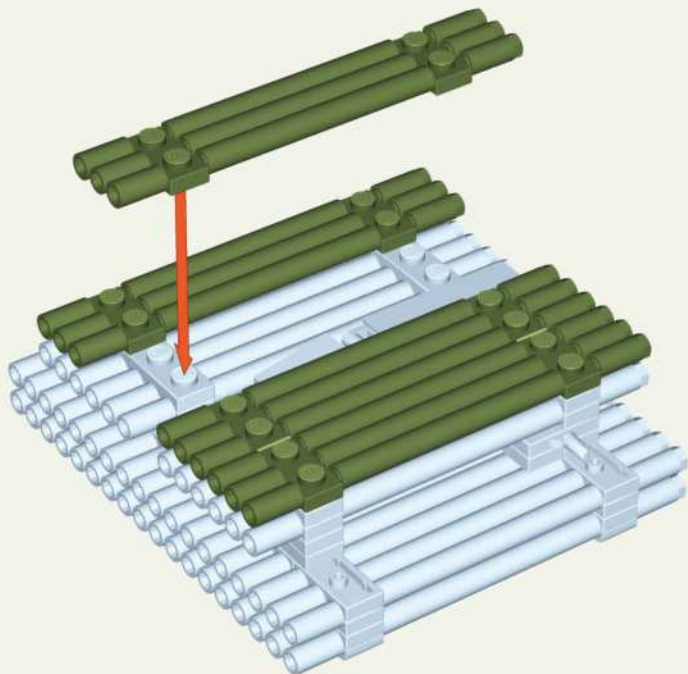

162

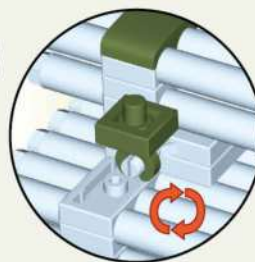

x2



x2



x2



x4

163

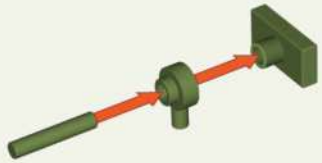

1:1



x1



x1



x1

164

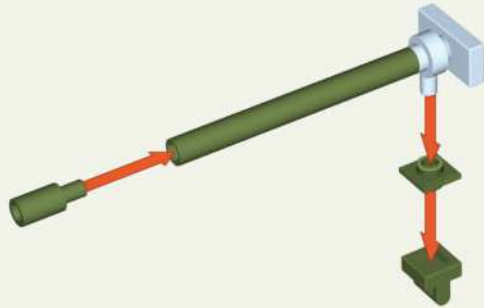

x1



x1



x1



x1

165

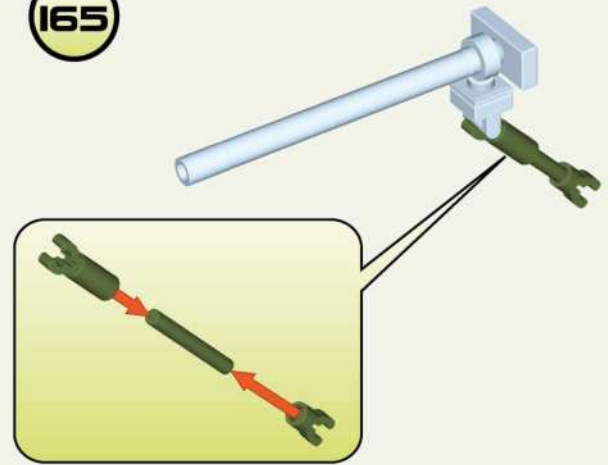

1:1



x1



x1



x1

166

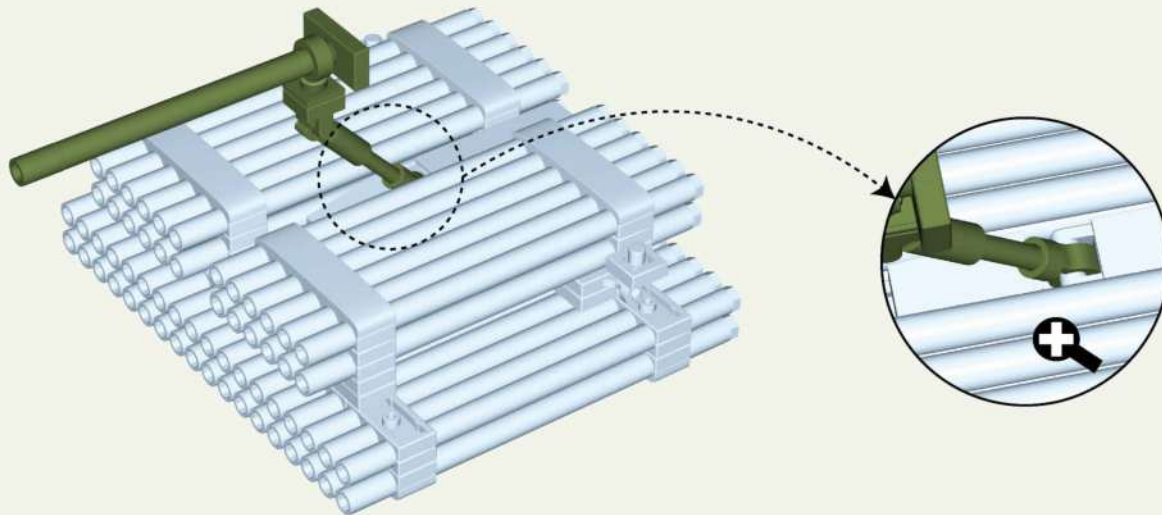

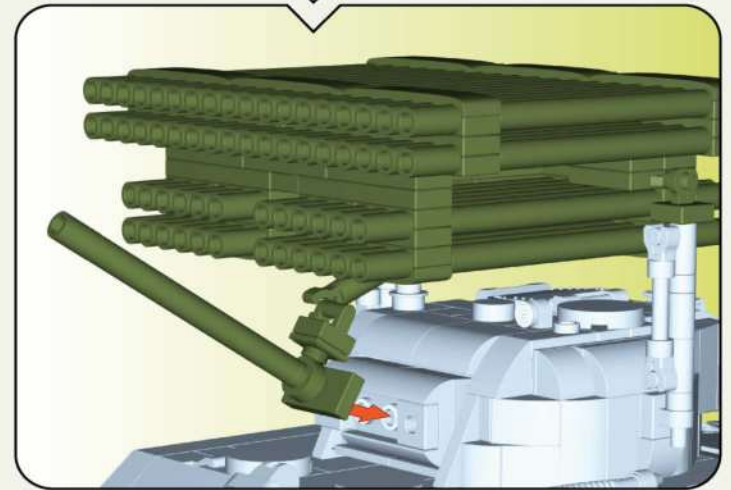
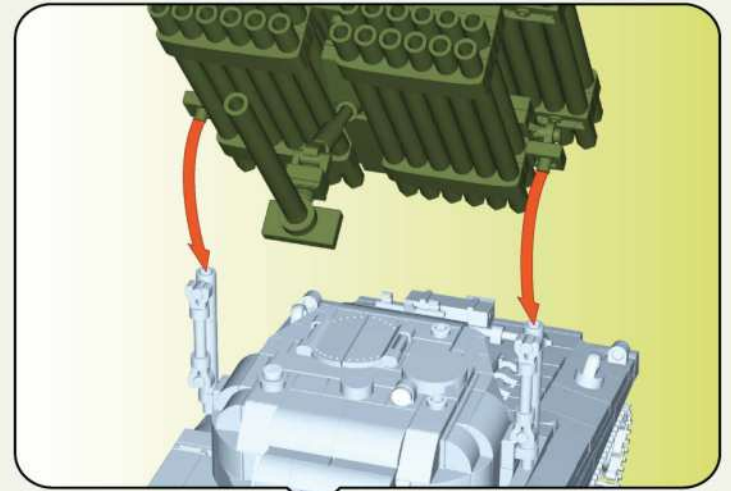
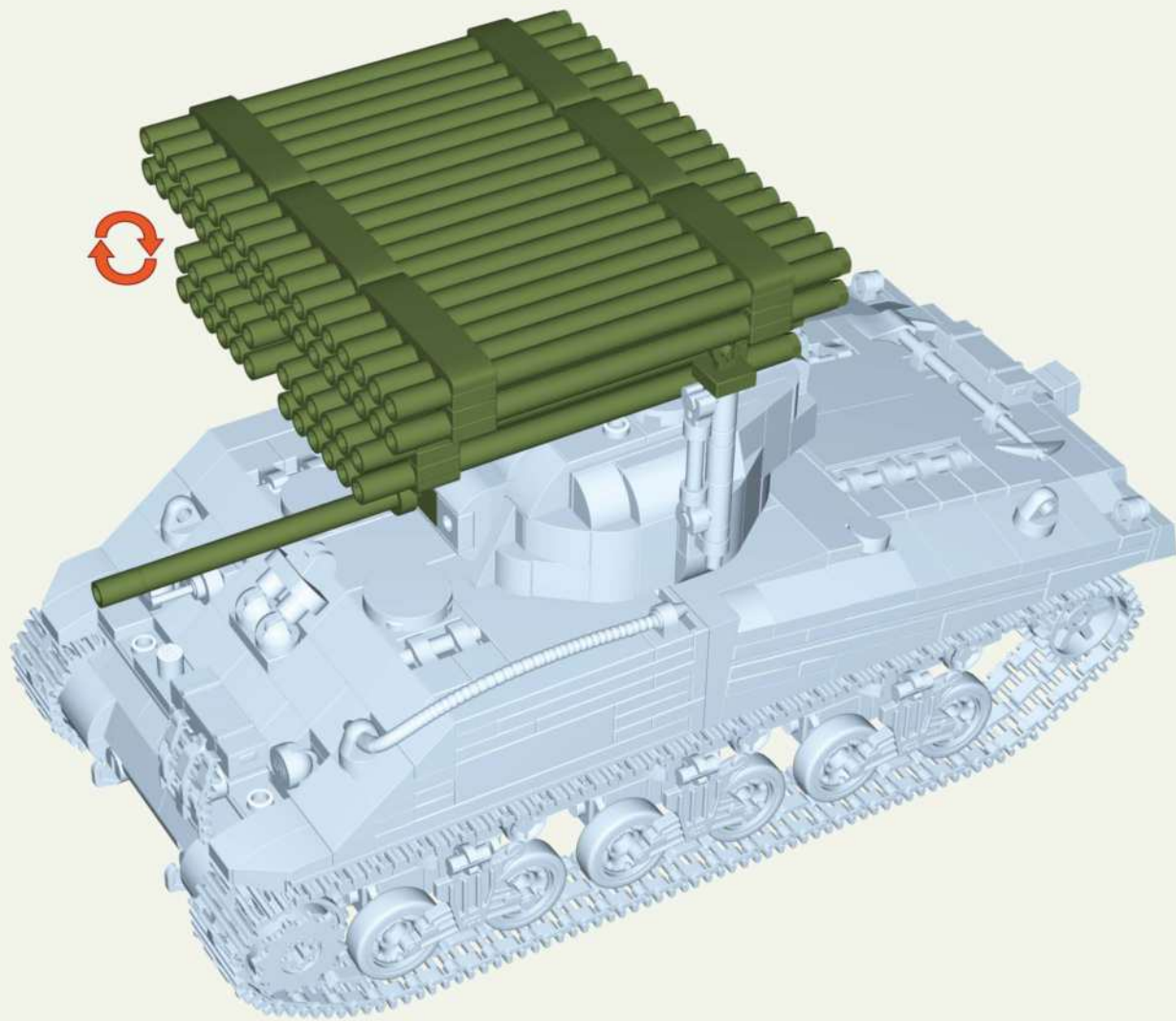

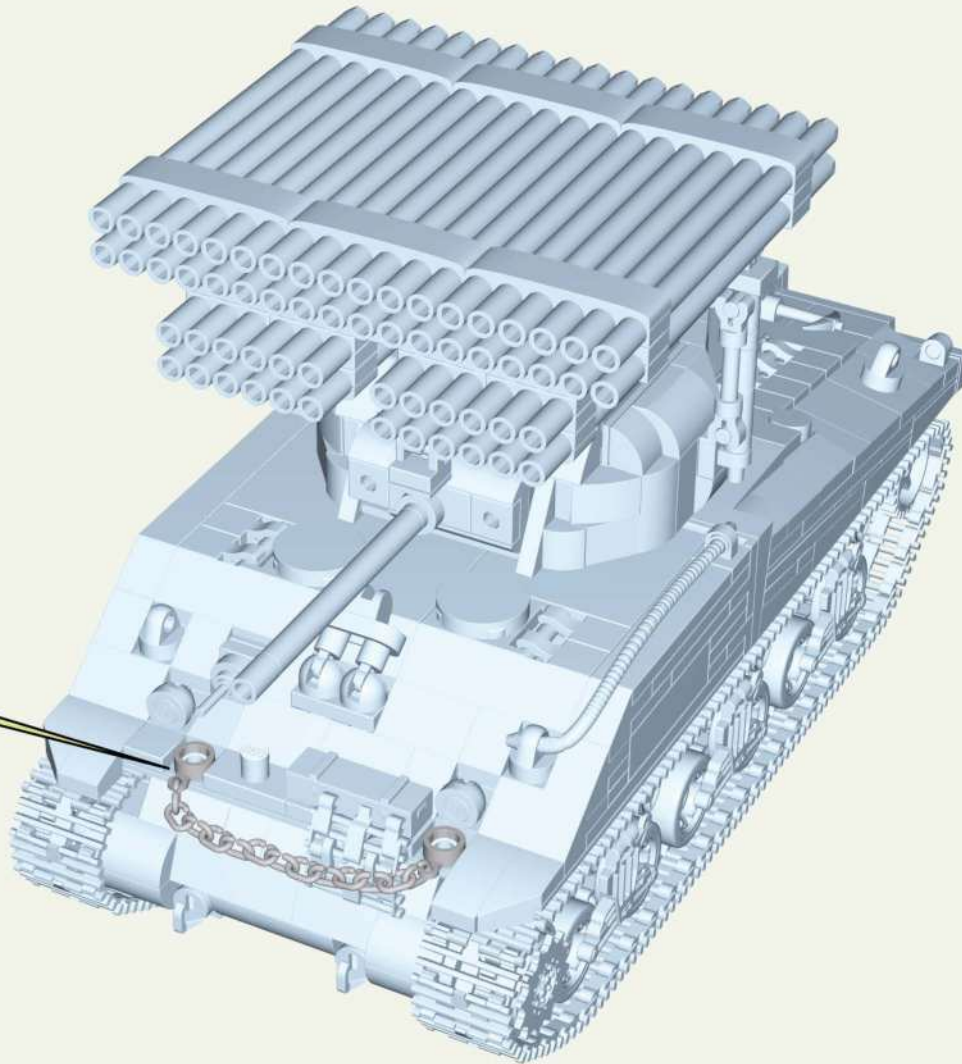
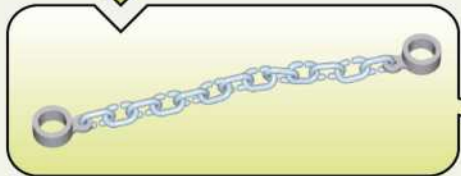
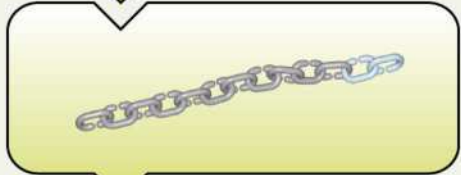

 **x13**  **x2**

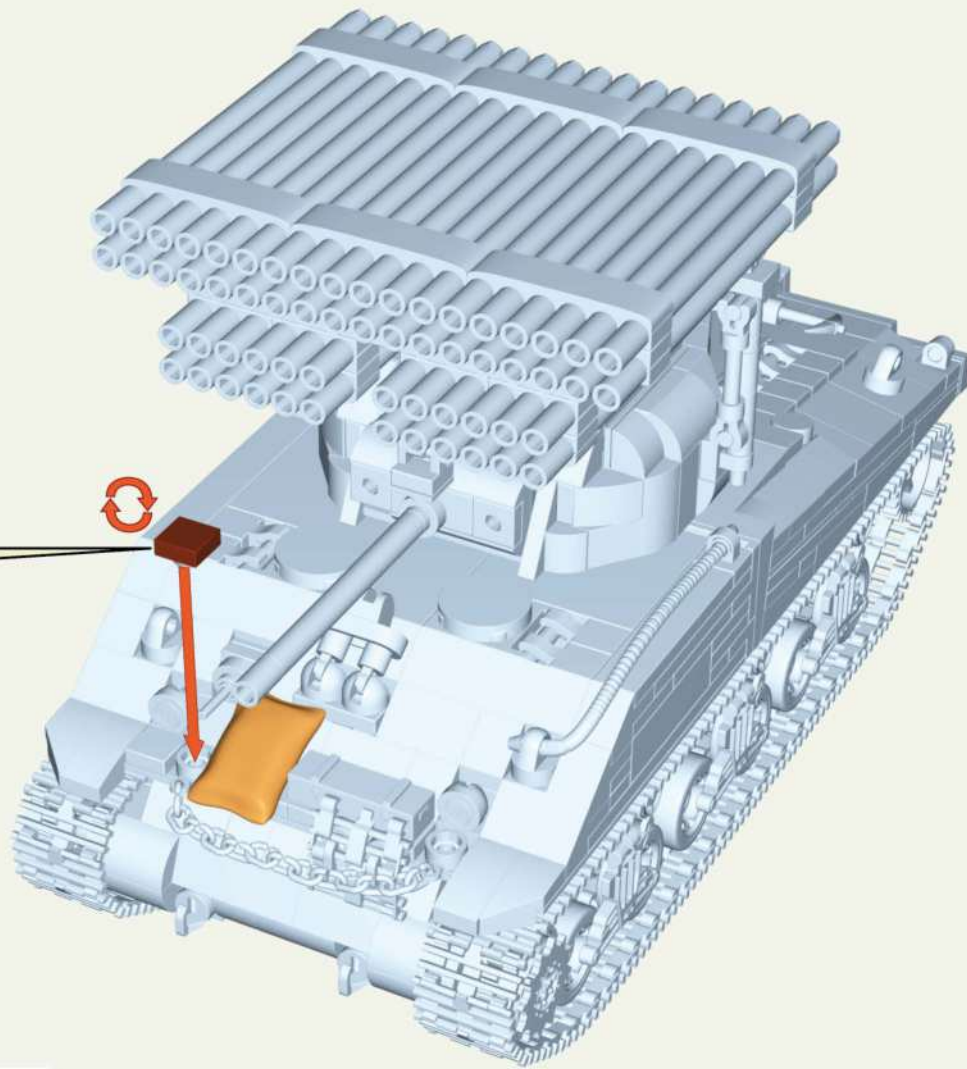
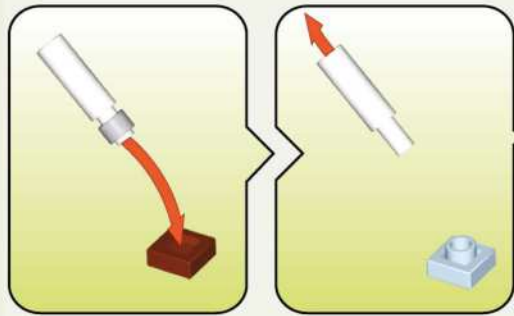

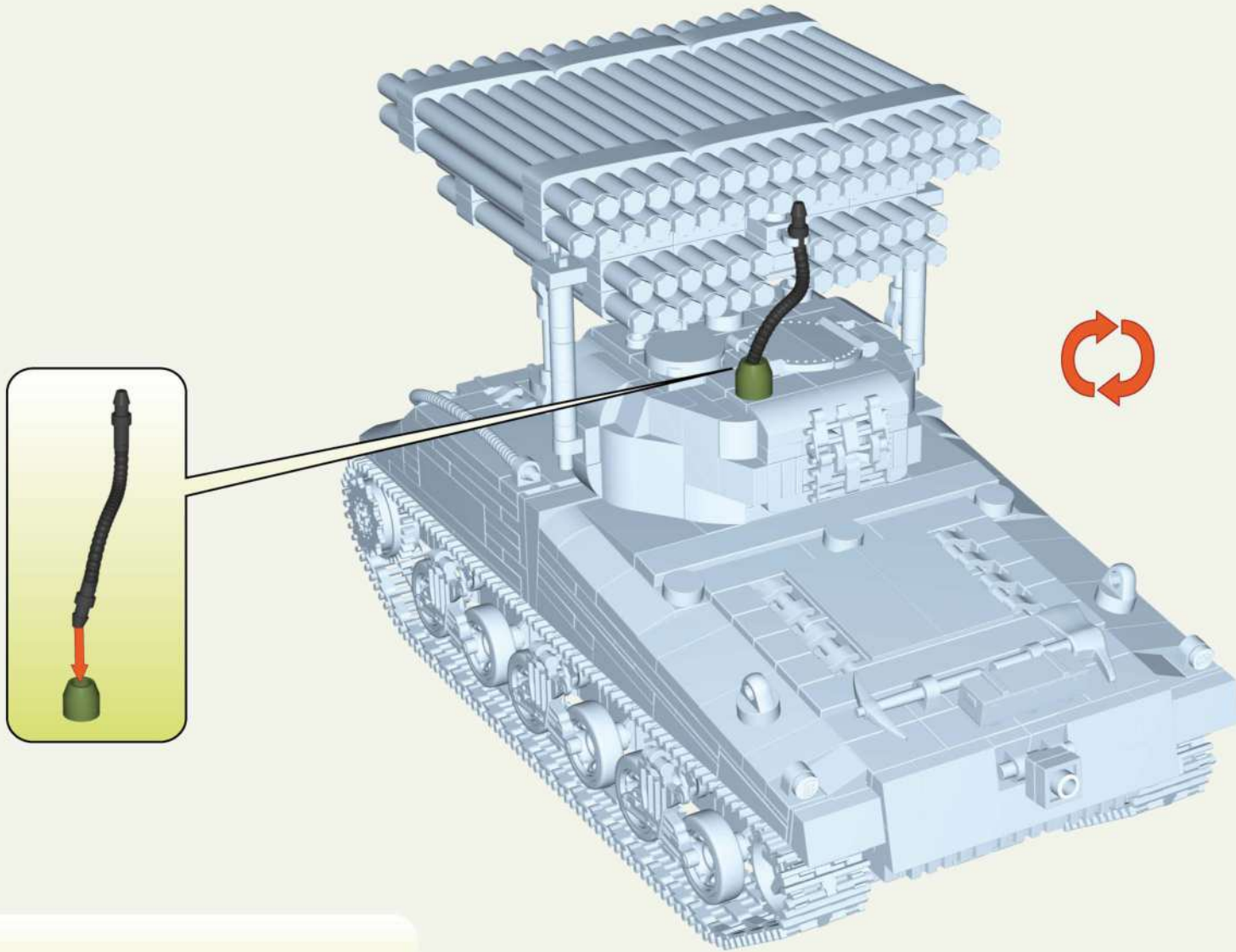

	
x1	x1

171

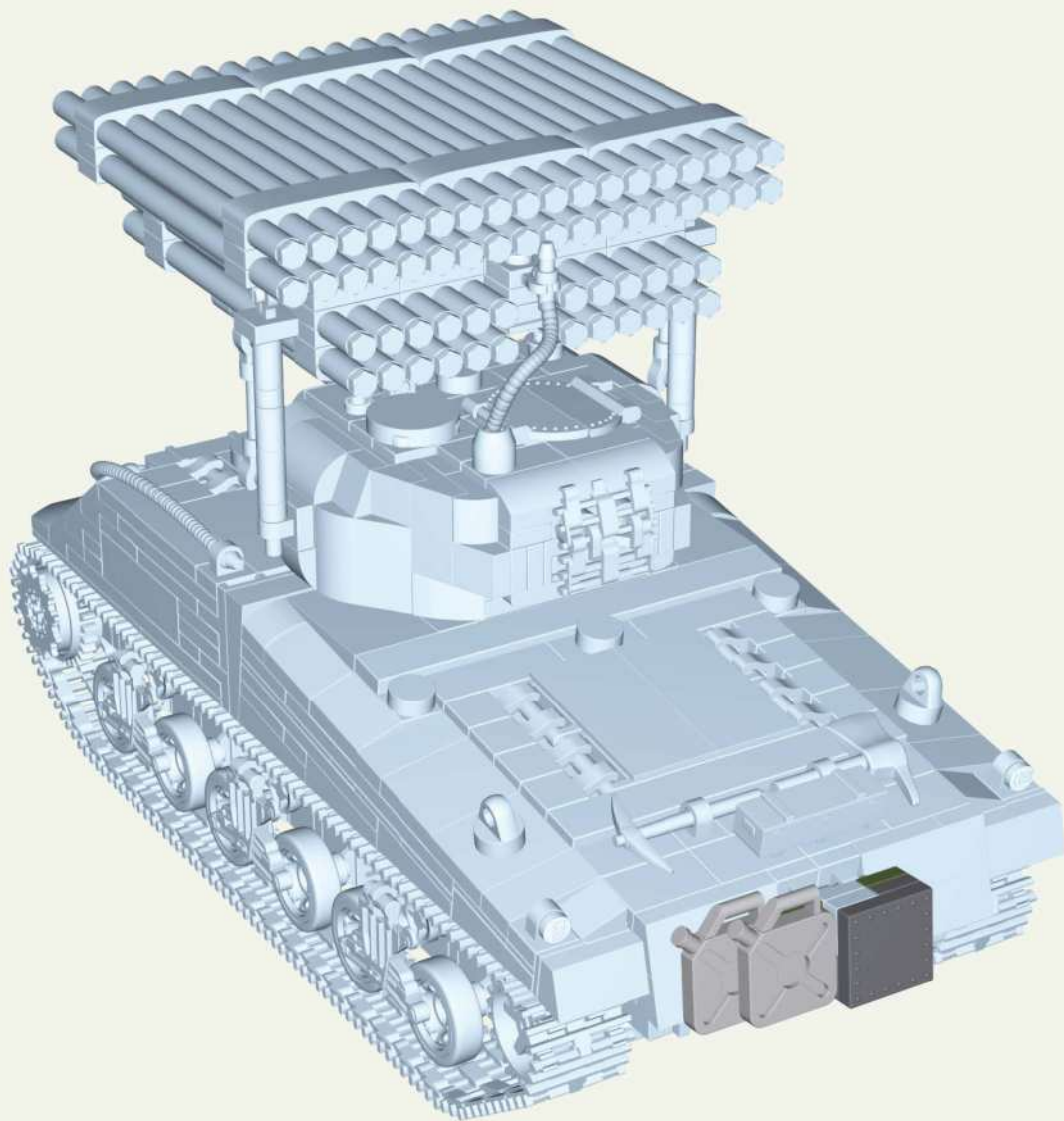
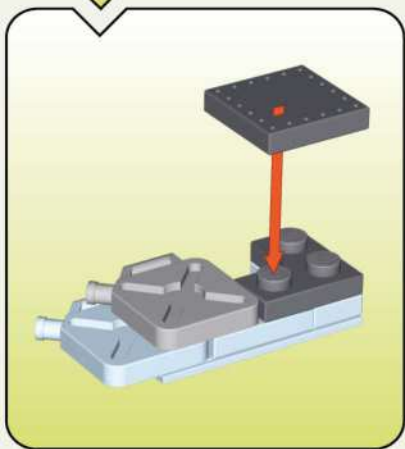
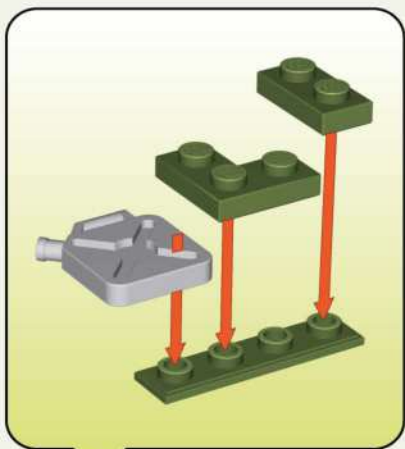

x1



x2



x1



x1



x1



x1

172



x1



x1



x1



x6 105891	x2 138083	x5 141421	x2 128622	x8 128623	x29 44014	x1 54631	x4 97241	x1 101911	x2 43795	x12 132985	x5 105092
x3 147889	x1 105094	x1 150048	x3 118376	x2 125256	x2 96797	x5 42882	x4 96758	x2 143480	x11 121246	x2 118380	x2 150044
x8 44879	x4 148971	x5 92239	x2 102460	x6 108318	x8 86091	x2 85894	x1 44169	x10 99232	x2 132984	x16 42931	x2 43671
x1 98135	x1 42922	x1 51555	x3 134976	x8 104956	x1 119440	x1 125205	x6 45540	x2 98244	x3 101912	x4 104428	x3 94039
x2 125376	x3 132329	x1 131780	x2 92369	x1 91424	x18 87333	x9 42952	x3 106342	x4 45647	x2 80005	x1 83632	x1 42873
x1 150049	x1 143654	x1 143657	x4 143521	x4 128968	x5 98140	x1 149914	x1 149913	x4 92341	x1 44251	x7 111484	x1 149915
x7 81905	x2 111481	x9 132618	x8 42959	x2 93457	x26 115502	x1 44877	x1 94649	x1 149916	x1 149917	x2 93965	x2 147990
x1 109733	x20 42976	x11 100145	x1 149919	x1 99178	x2 42991	x2 106762	x2 42967	x1 125333	x3 85406	x3 128844	x9 148707
x2 85566	x13 43017	x8 83478	x4 128843	x3 74222	x11 43033	x2 74372	x8 43024	x14 43084	x1 51597	x1 43685	x2 44686
x9 43100	x1 53201	x1 149922	x1 149920	x1 149921	x6 80920	x8 111485	x1 150046	x1 150047	x4 77515	x2 75779	x1 111105
x2 97401	x2 80006	x2 133187	x1 43075	x4 62886	x6 121252	x2 67979	x7 43154	x2 45648	x2 43137	x8 60501	x1 140307

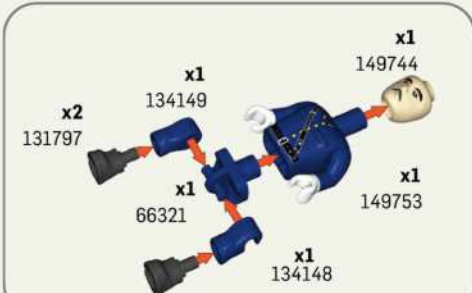
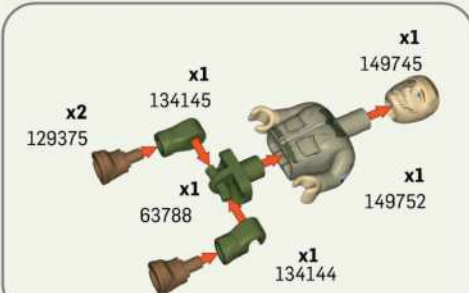
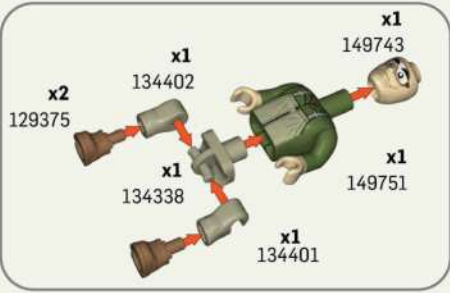



PANZER III Ausf. J
+ 2562



PzKpfw V PANTHER Ausf. G
+ 2566



PANZER IV AUSF. G
SCALE 1:48
+ 2714



PzKpfw V PANTHER „PUDEL”
+ 2568

HISTORICAL COLLECTION

2569

M4A3 SHERMAN
T34 CALLIOPE



TABLE POINT

1.		24 cm	11.		4
2.		10 cm	12.		3
3.		-5 cm	13.		4
4.		-5 cm	14.		4
5.		+10 cm	15.		3
6.		5-6	16.		2
7.		5-6	17.		1
8.		14	18.		5
9.		8+	19.		180
10.		8	20.		* Available 1944

* -1 to hit with Gun, 'small Target



2569



SHERMAN M4A1
SCALE 1:48
★ 2715



PzKpfw VI TIGER "131"
SCALE 1:48
+ 2710

HISTORICAL COLLECTION

WWW.COBIGAMES.COM

N4A3 SHERMAN T34 CALLIOPE



CHURCHILL MK. IV
SCALE 1:48
🇬🇧 2717



PANZER II AUSF. A
SCALE 1:48
+ 2718



Sd.Kfz.7 HALF-TRACK
+ 2275

WWW.COBI.EU

01-02569-1193

For news and special deals

Find us on:

