

HISTORICAL COLLECTION

WORLD WAR II



M4A3 SHERMAN

IN SERVICE - 1943 - 1945
PLACE OF ORIGIN - UNITED STATES
TYPE - MEDIUM TANK
WEIGHT - 30,2T (66,700LB)
ARMOUR - 76MM (3")
ARMAMENT - 75MM GUN M3,
1x HMG 12,7MM (.50") M2HB,
1x MG 7,62MM (.30") M1919A4
ENGINE - FORD GAA V8
MAXIMUM SPEED - 42KM/H (26MPH)
CREW - 5



PAD PRINTED
NO STICKERS

Printed in EU

2570



WARNING: CHOKING HAZARD-
Toy contains small parts.
Not for children under 3 years.

852 2

M4A3 SHERMAN

SCALE 1:28

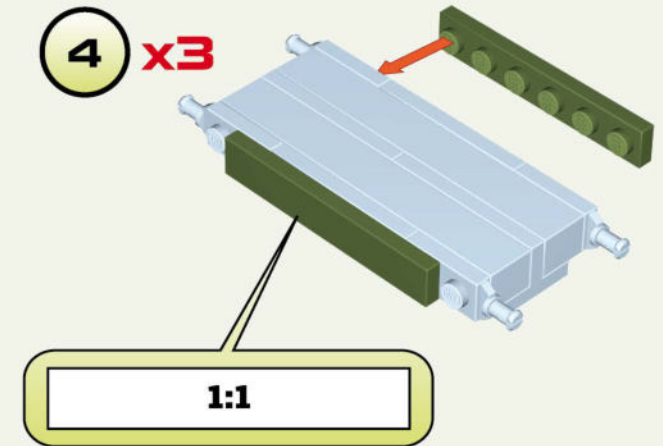
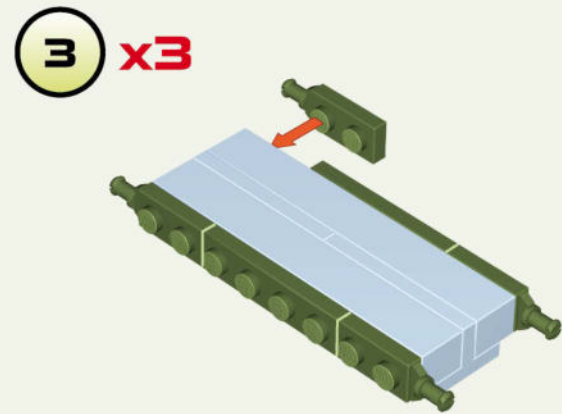
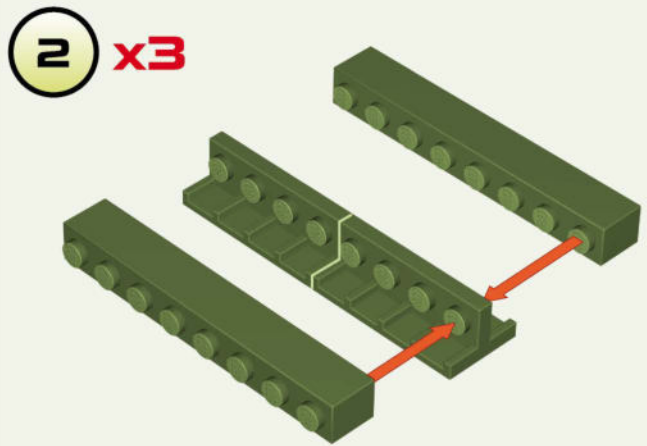
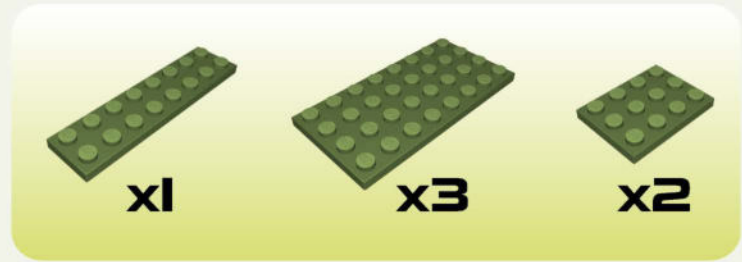
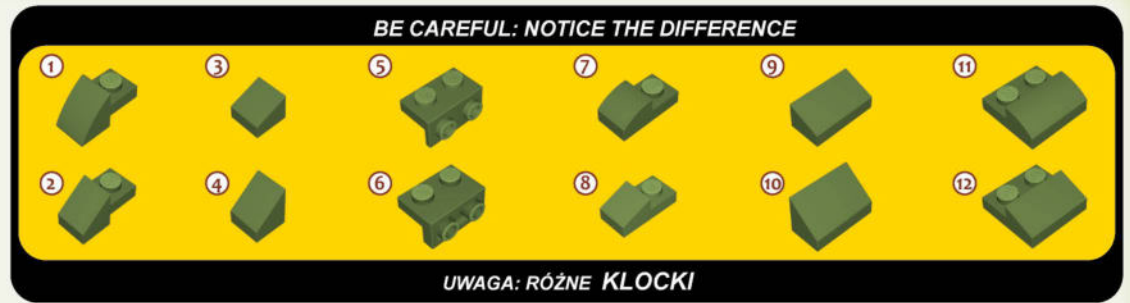
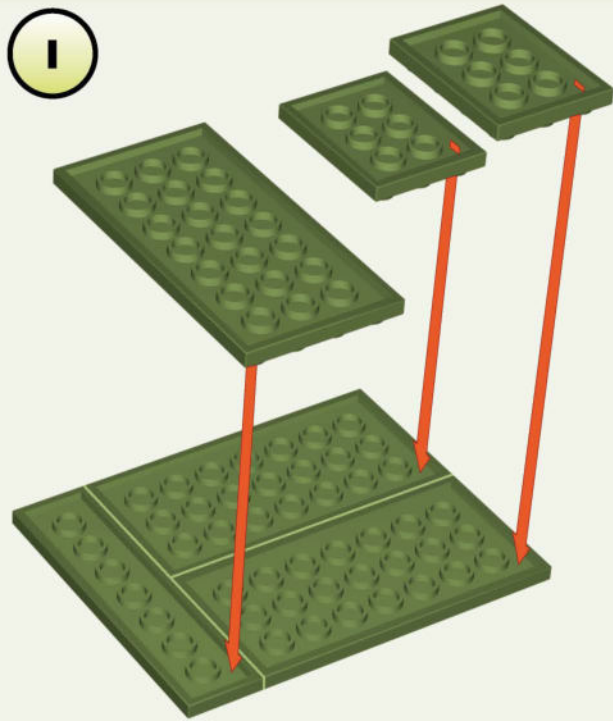

5

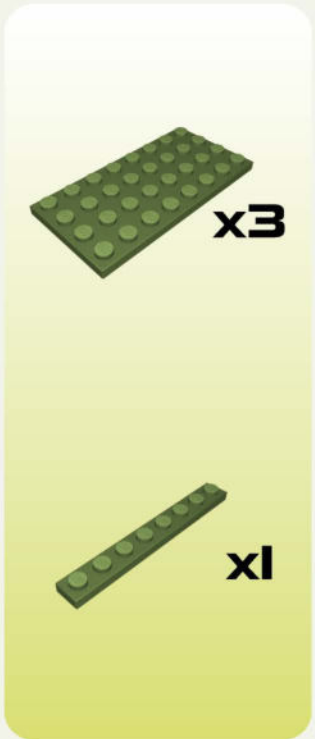
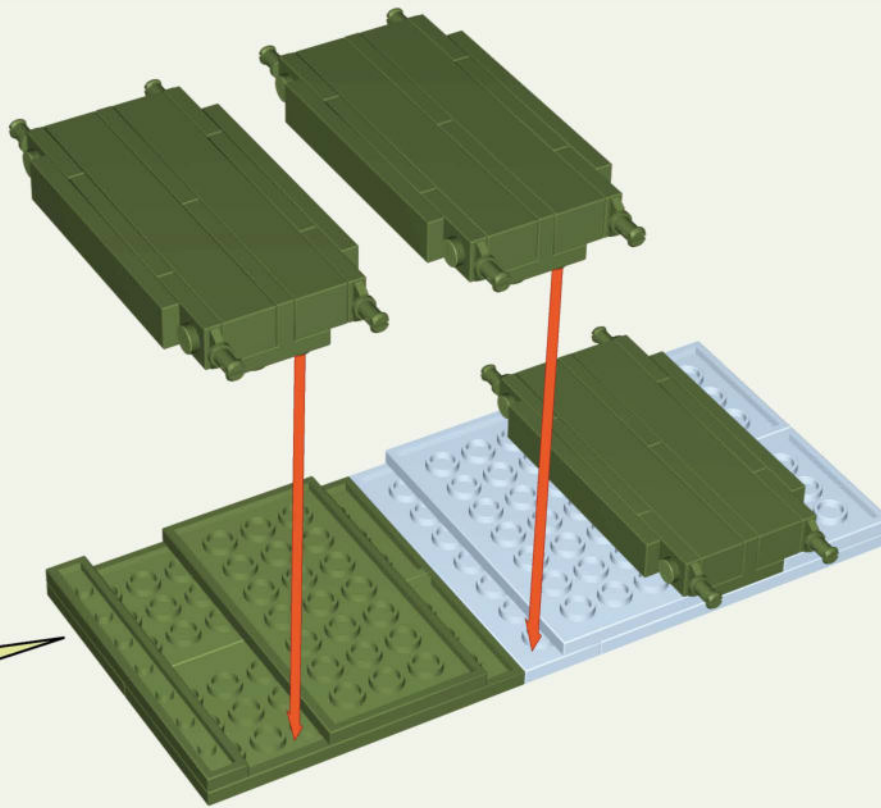
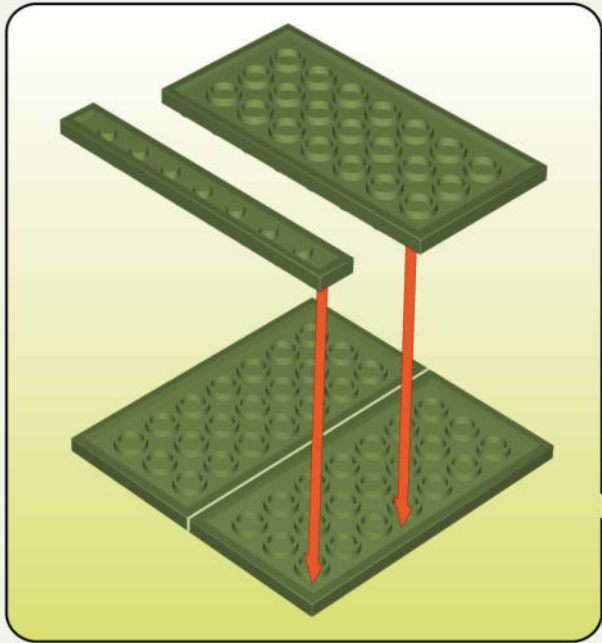

6

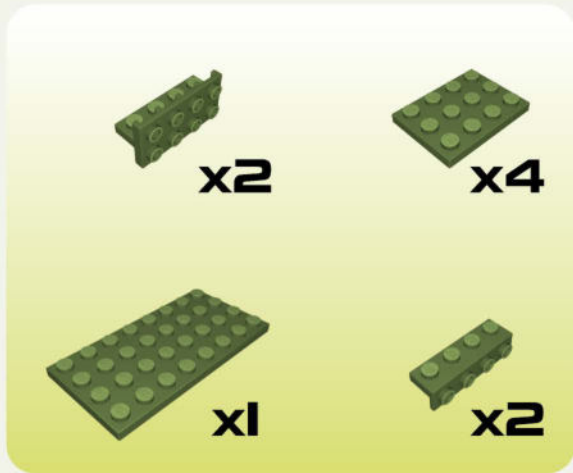
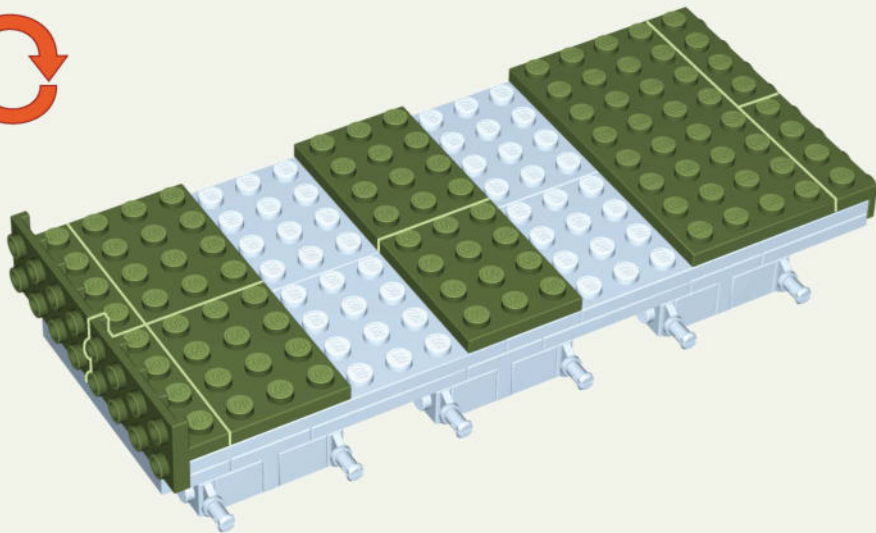

7

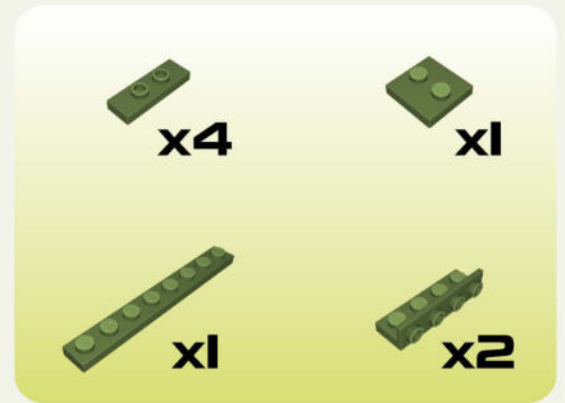
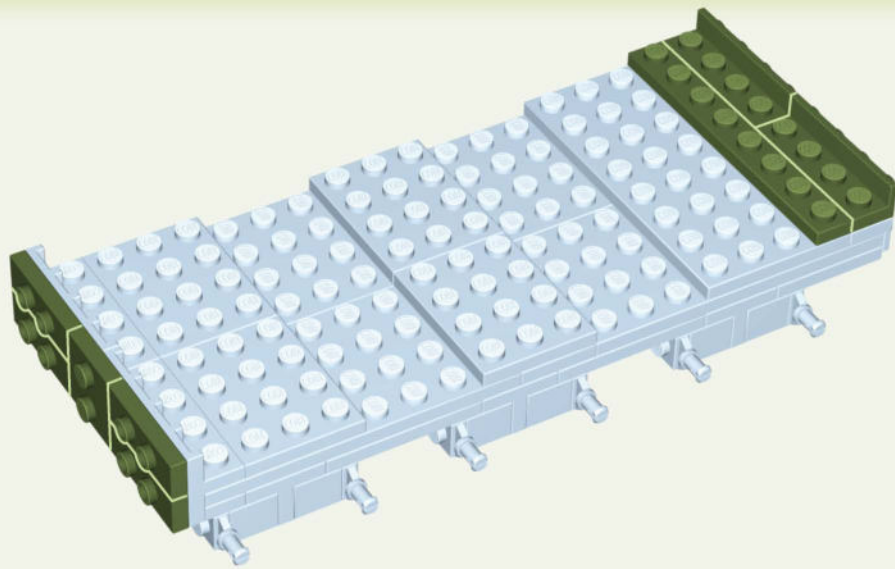

8

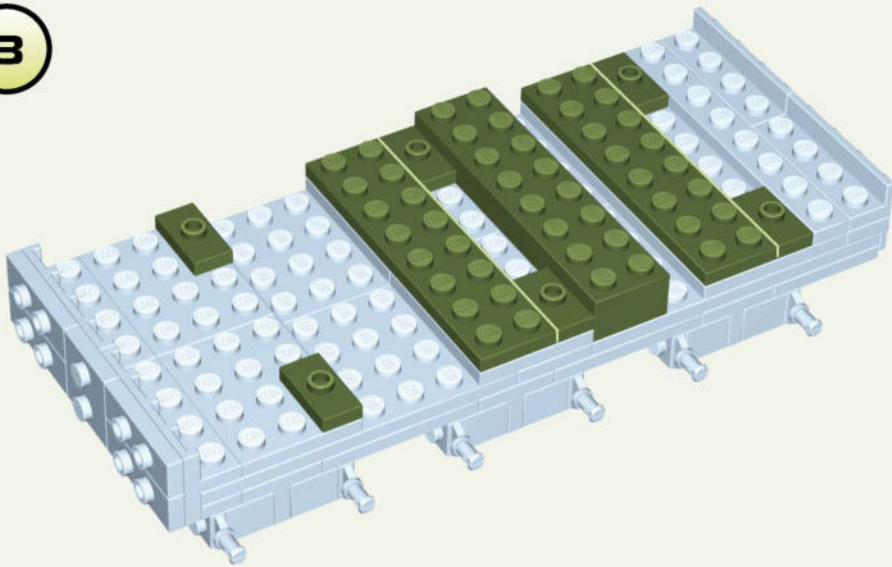

9

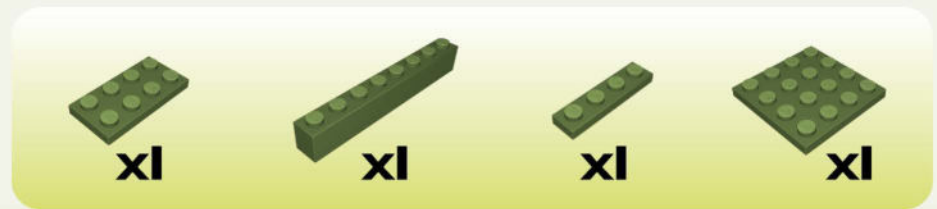
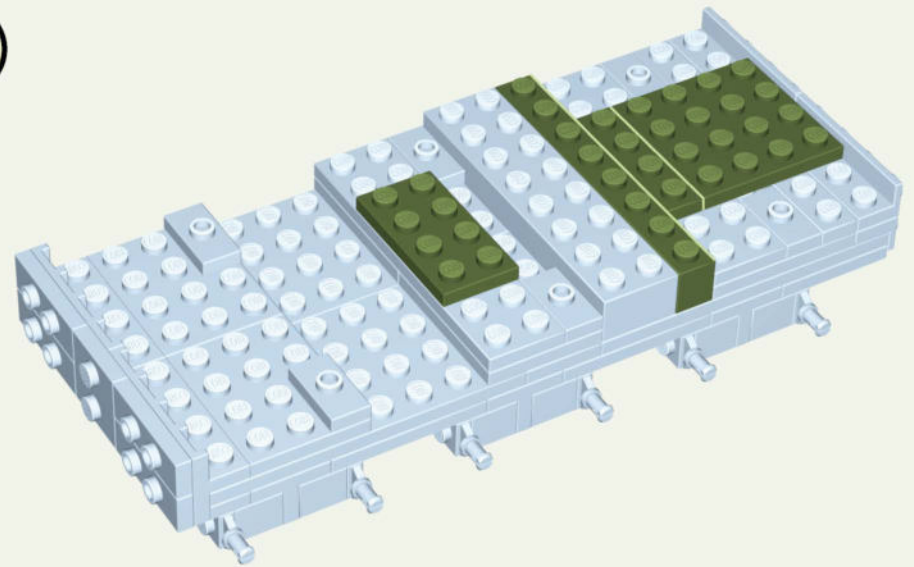

10

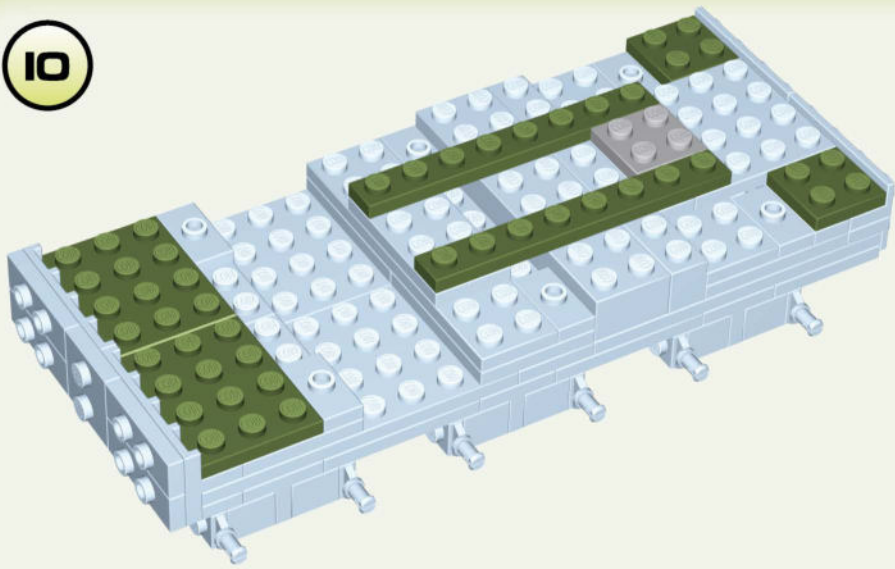

x2



x2



x1



x2

11

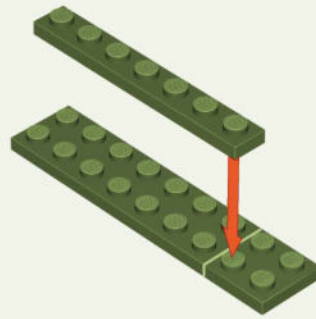

x1



x1



x1

12

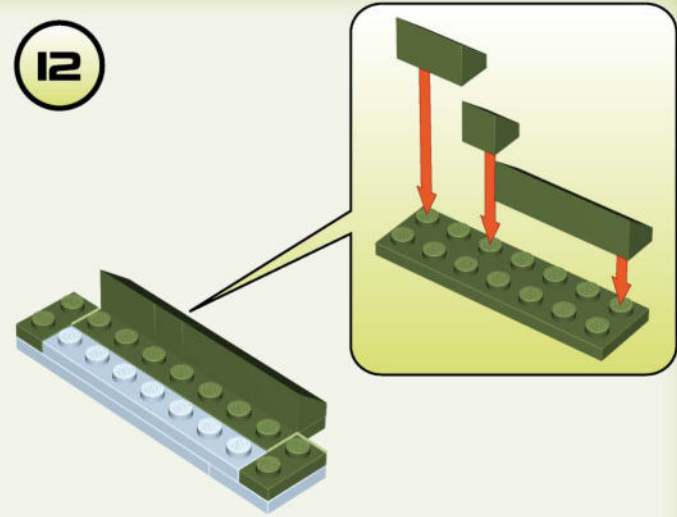

x2



x1



x1



x1



x1

13

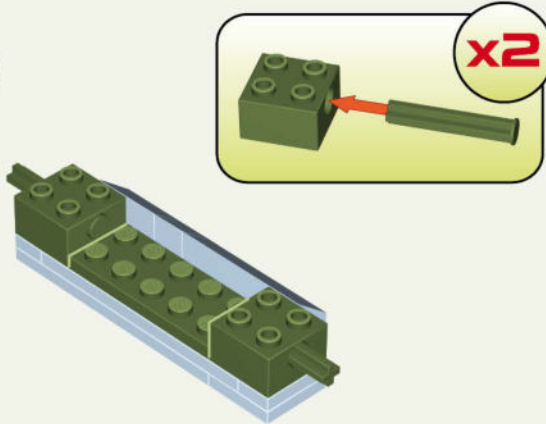

x2



x1



x2



x2

14

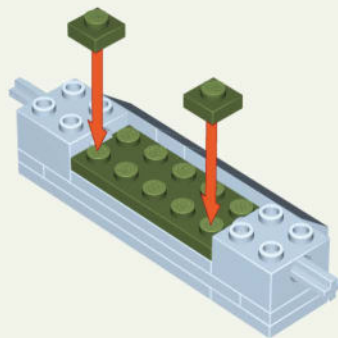

x1



x2

15

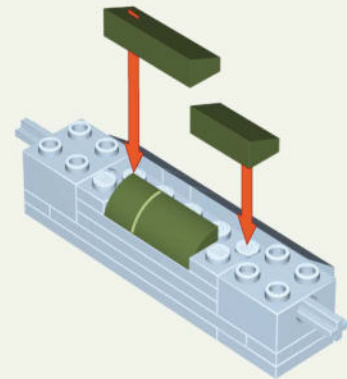

x1



x1



x1



x1

16

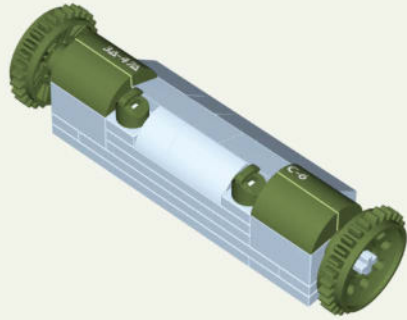

x2



x1



x1



x2



x2

17

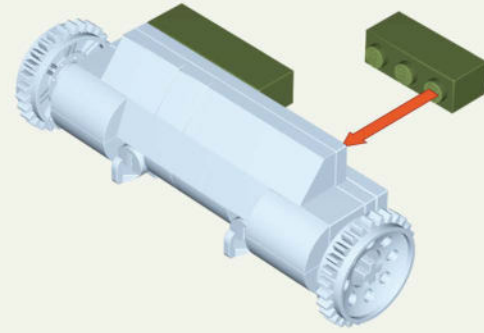

x1



x1

18

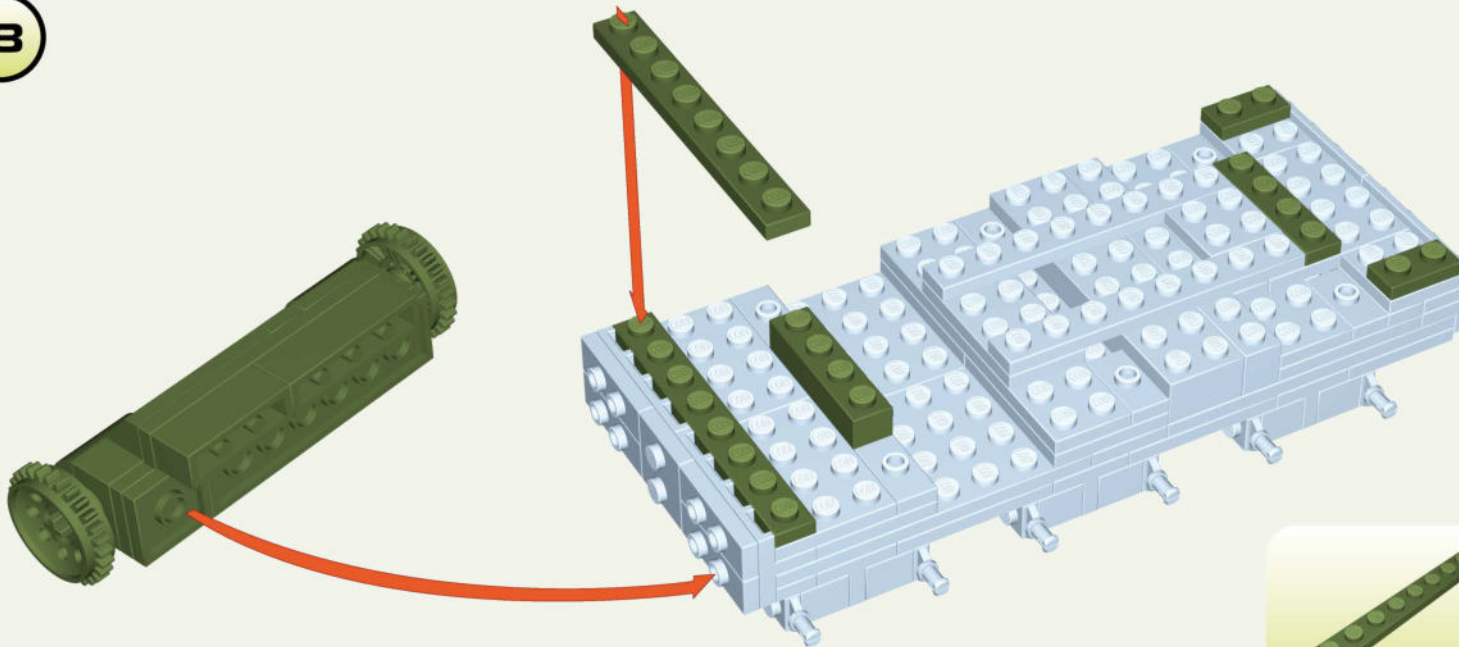

x2



x1



x1



x2

19

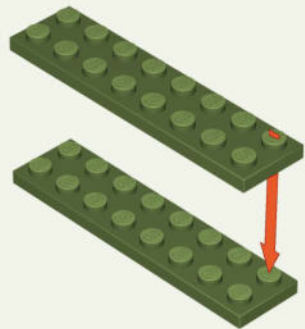

x2

20

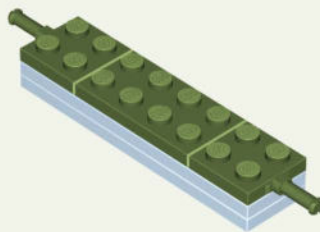

x2



x1

21

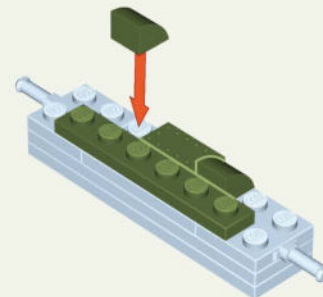

x1



x1



x2

22

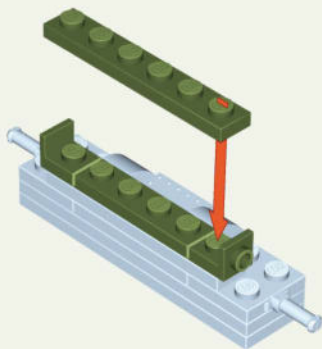

x2



x1



x1

23

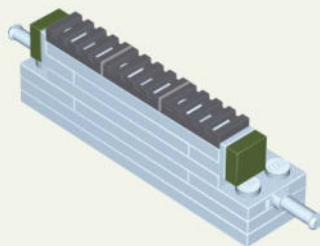

x2



x3

24

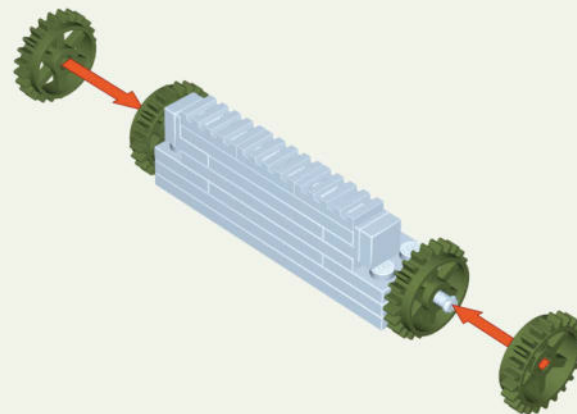

x4

25

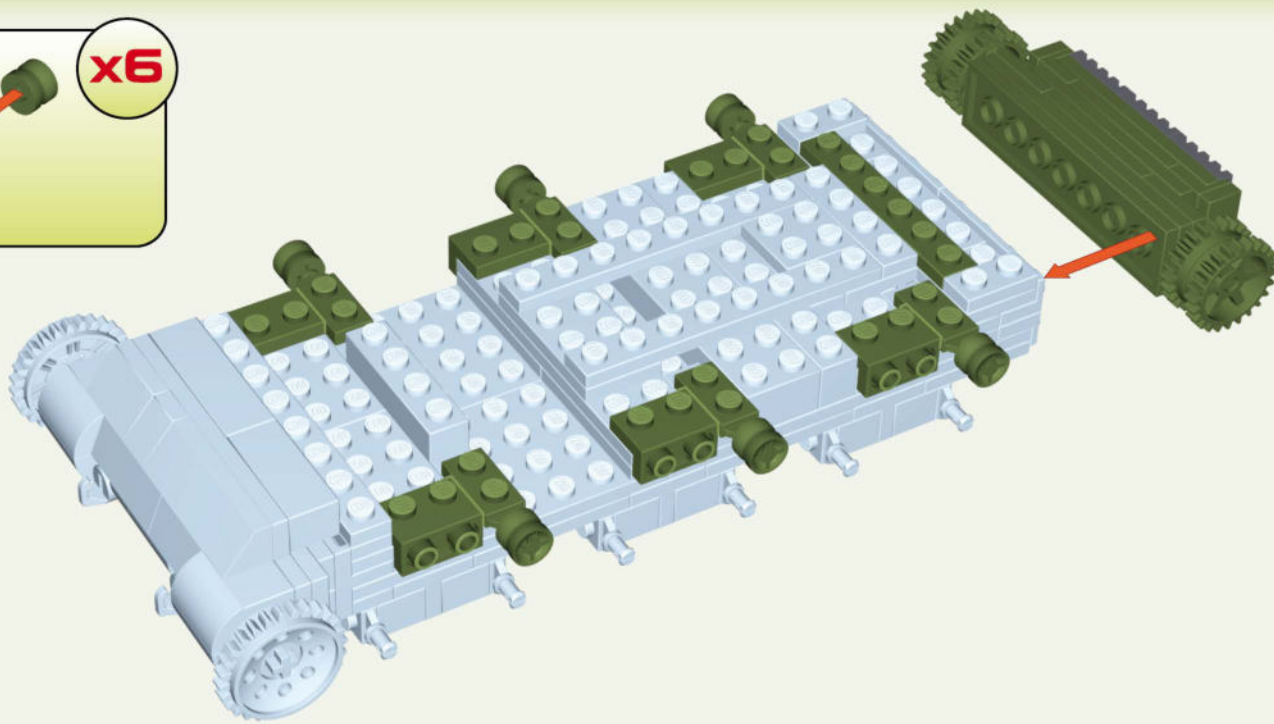
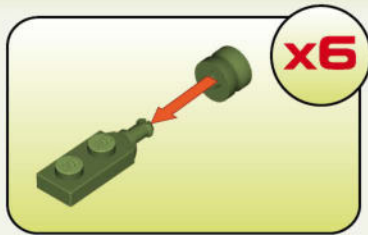

⑥  x6

 x6

 x6

 x1

26

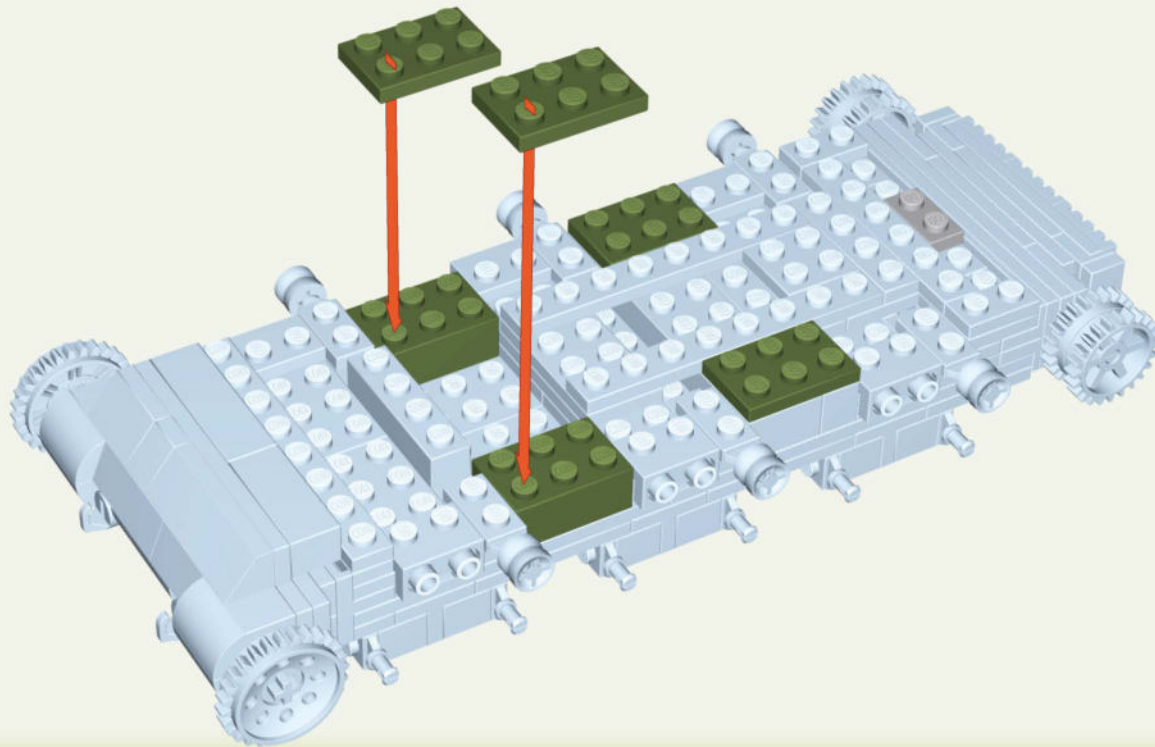



 x2

 x4

 x1

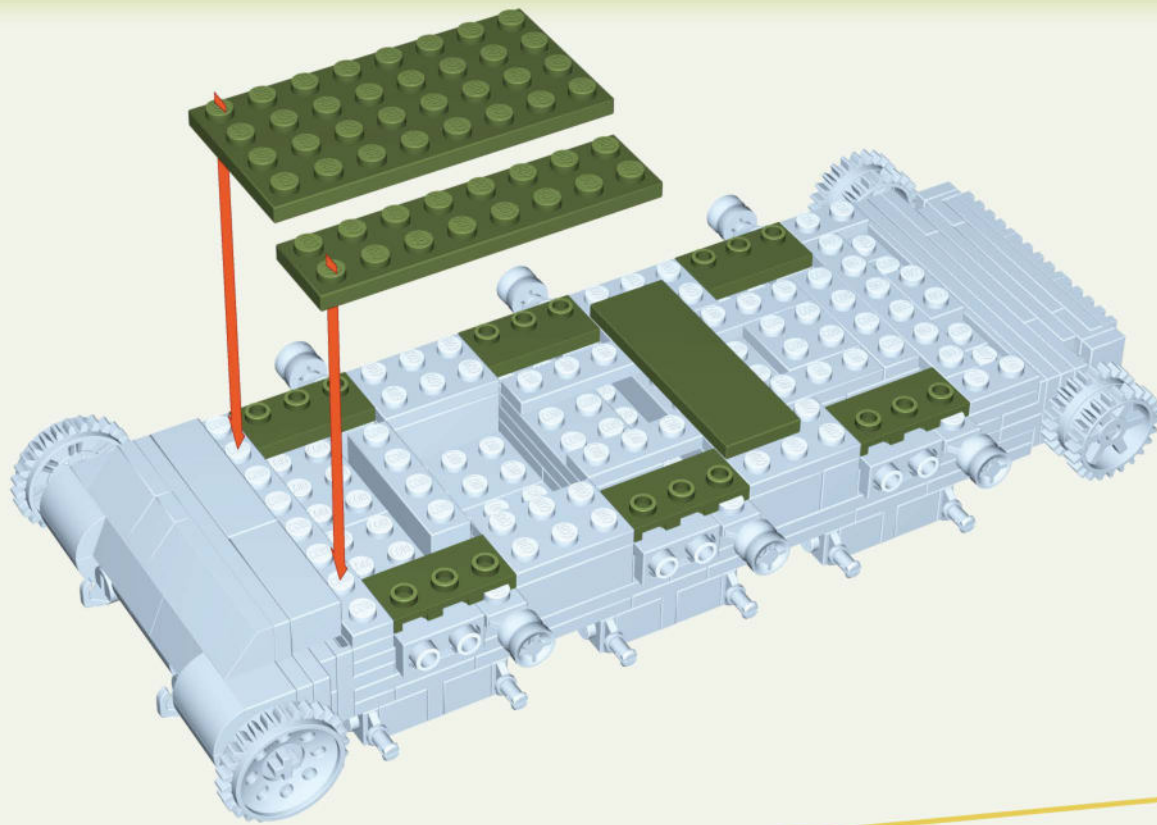
27

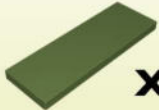
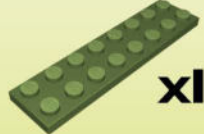
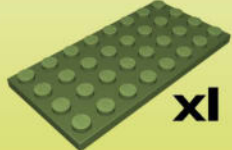

-  x6
-  x1
-  x1
-  x1

28

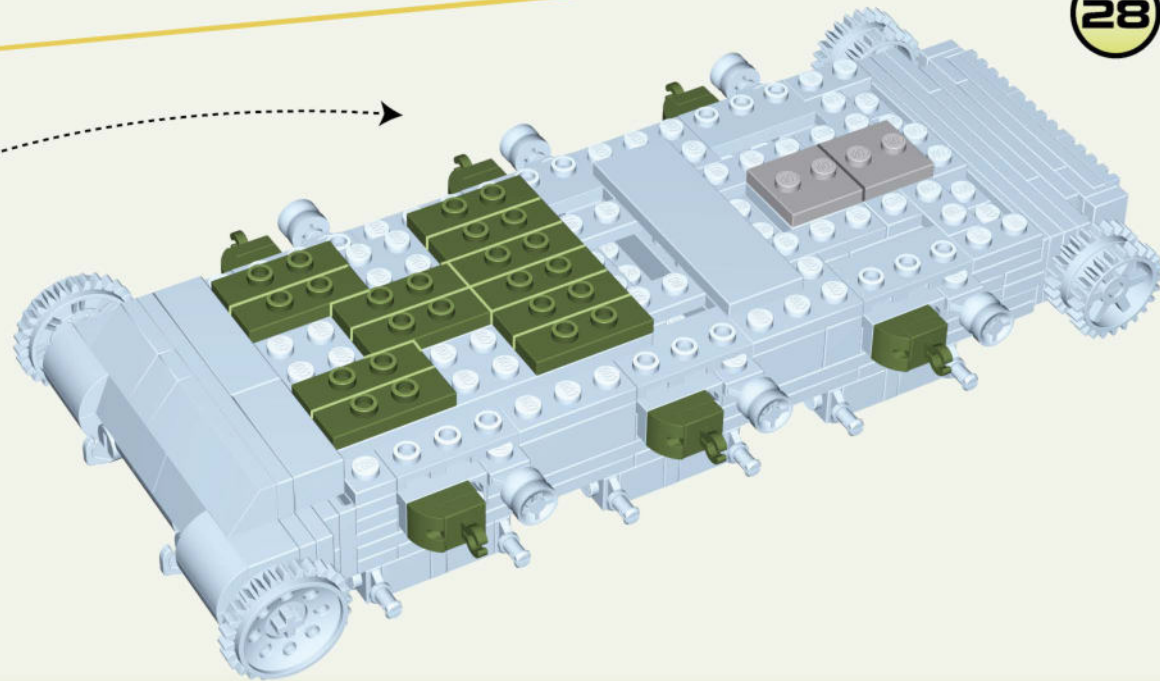
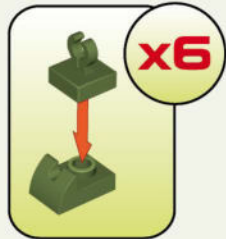
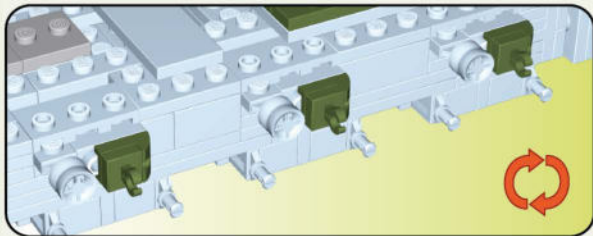

-  x6
-  x6
-  x12
-  x2

29

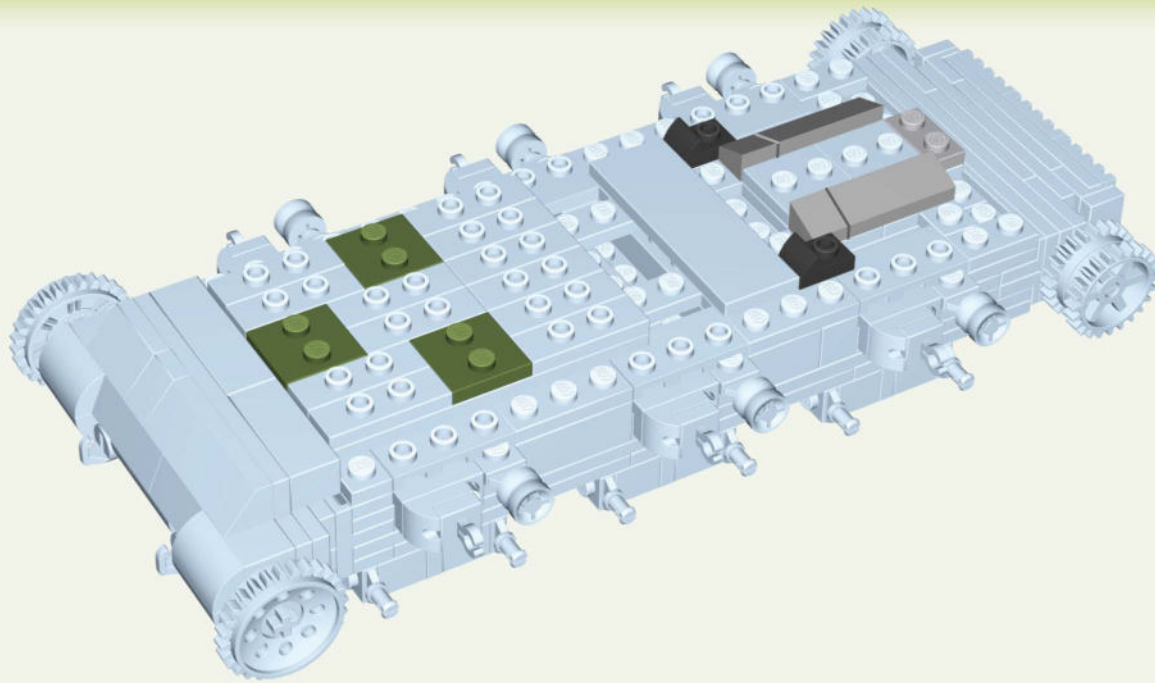

 x3

 x2

 x2

 x2

 x1

30

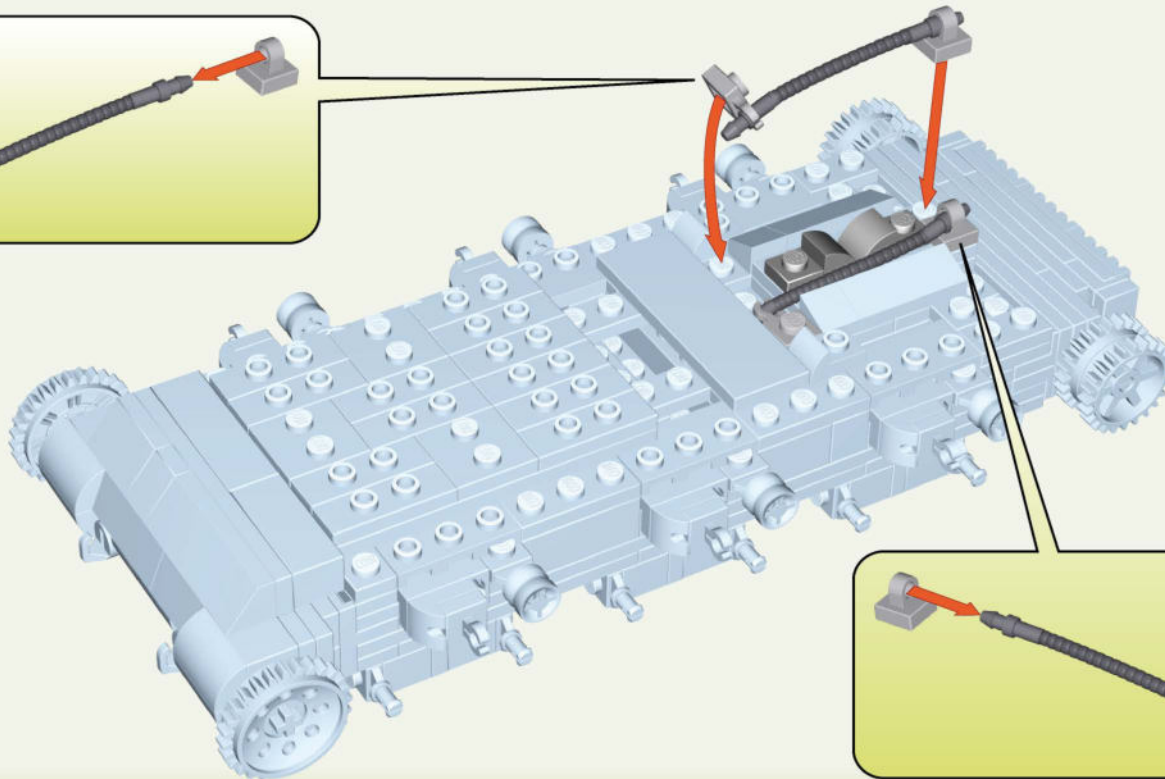
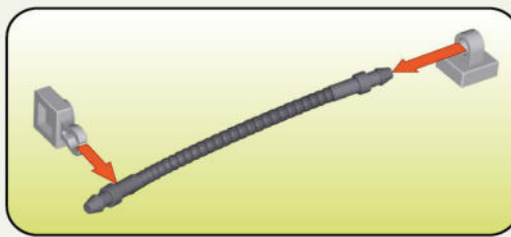

 x2

 x2

 x2

 x2

 x2

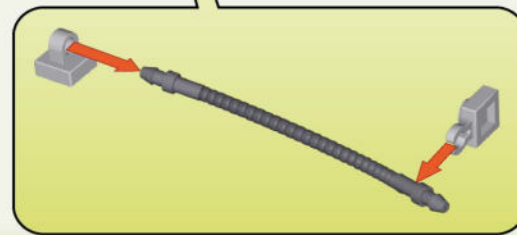



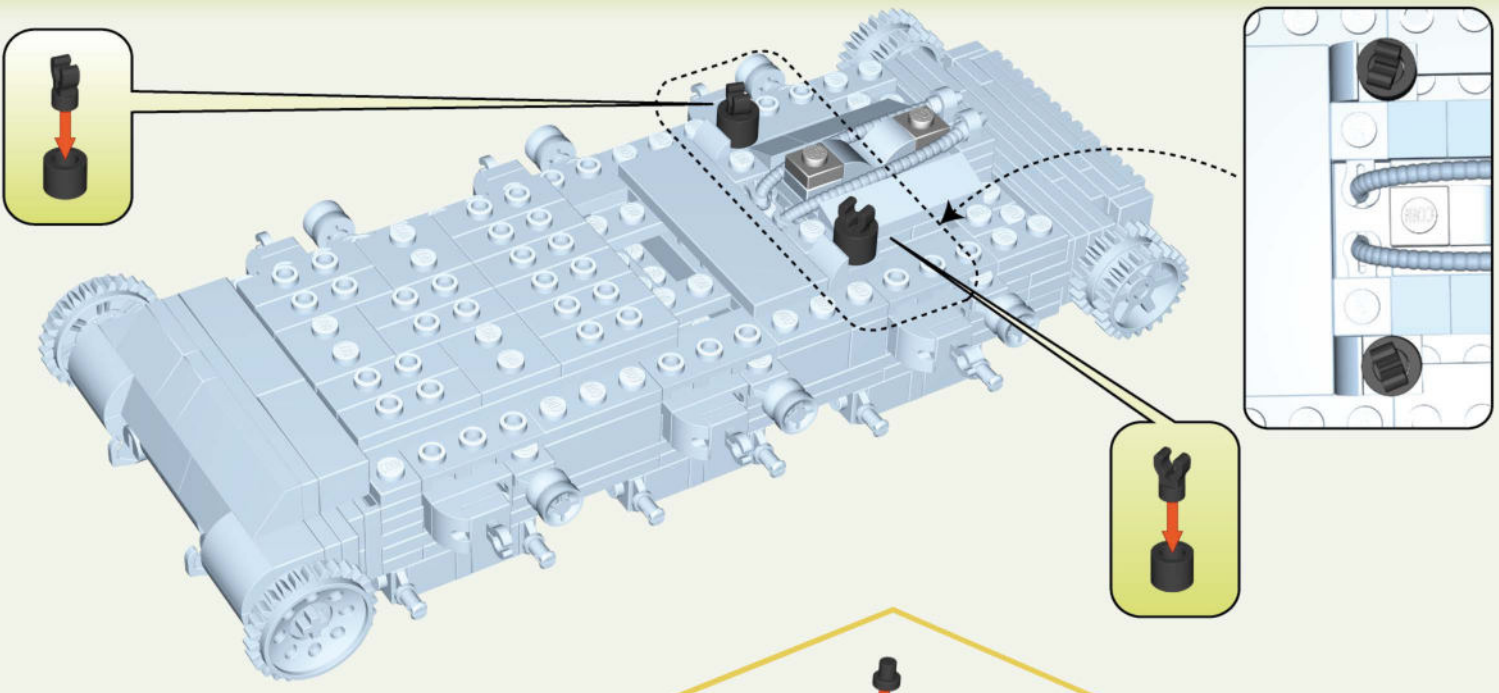

31

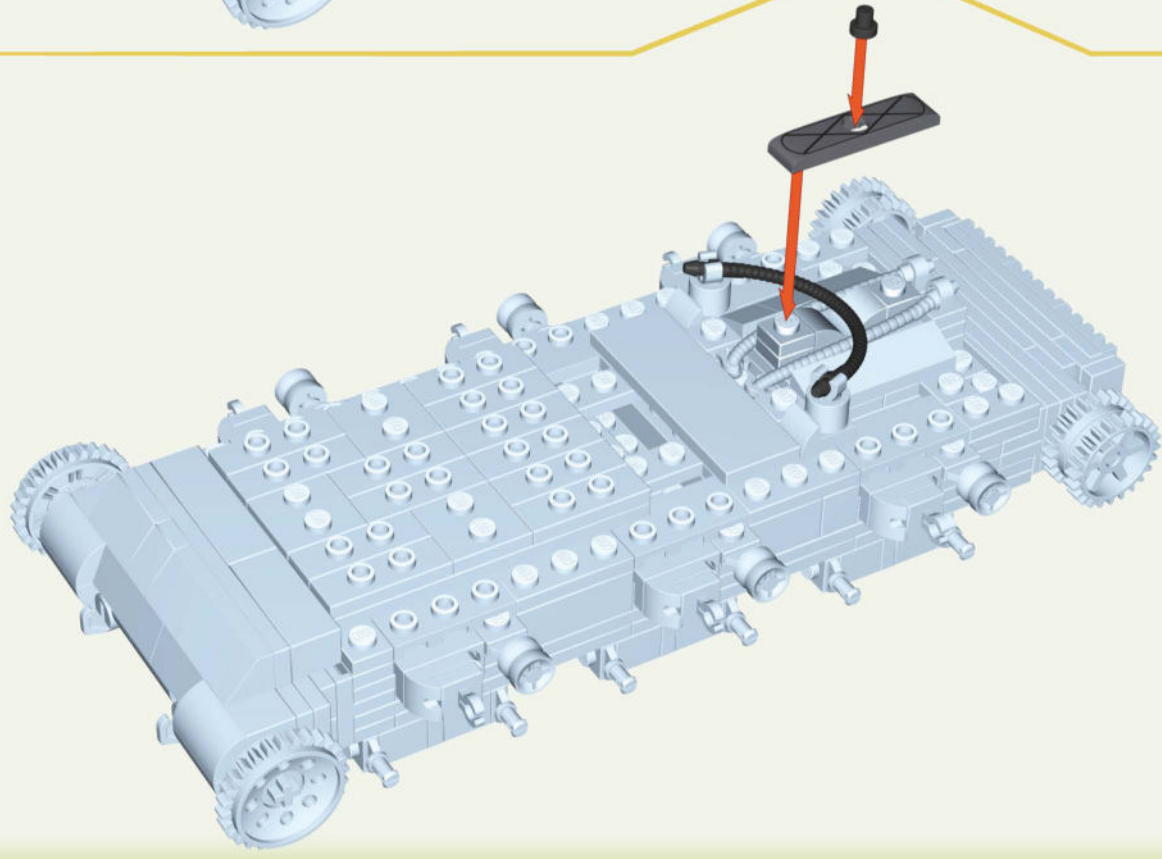

-  x2
-  x2
-  x2

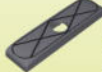

32



-  x1
-  x1
-  x1

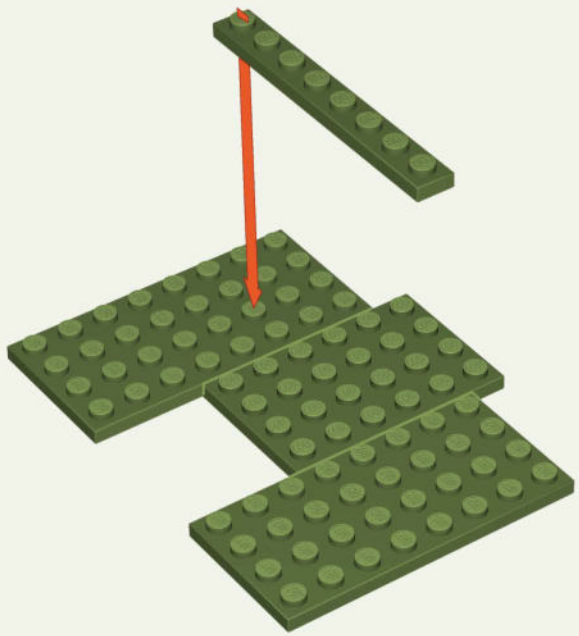

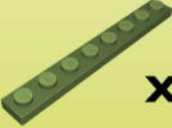

33

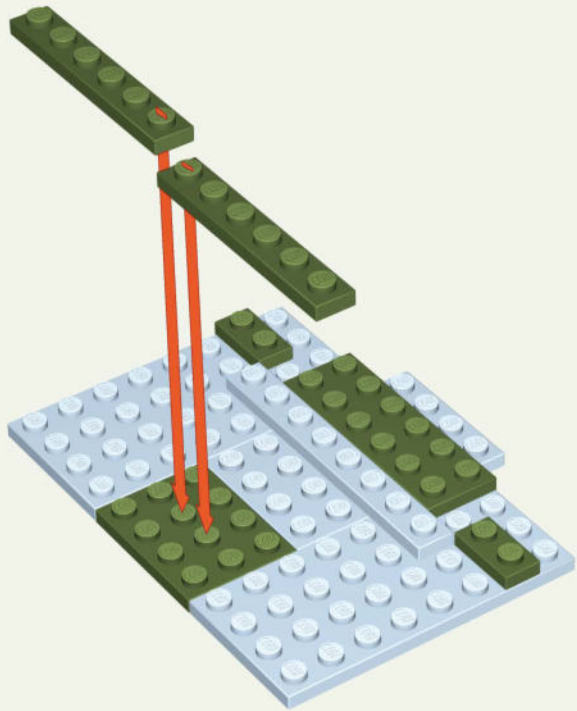

-  x2
-  x1
-  x1

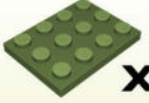
34



-  x1
-  x2
-  x1
-  x2



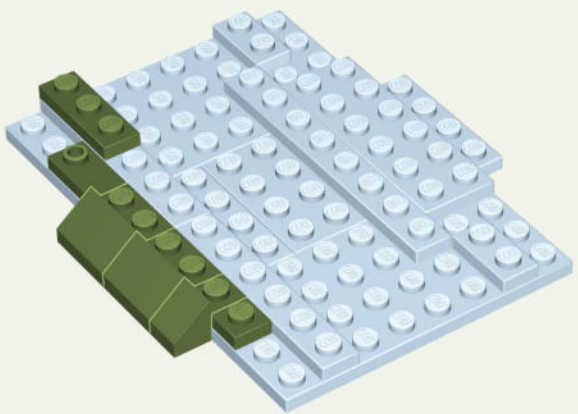

35

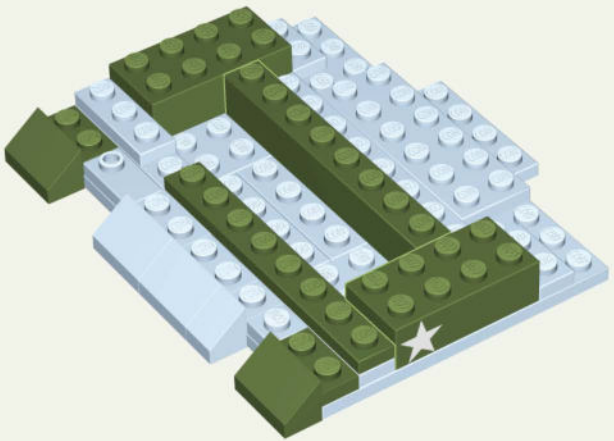

-  x1
-  x1
-  x2
-  x1
-  x1

36



-  x2
-  x1
-  x1
-  x1
-  x1

37

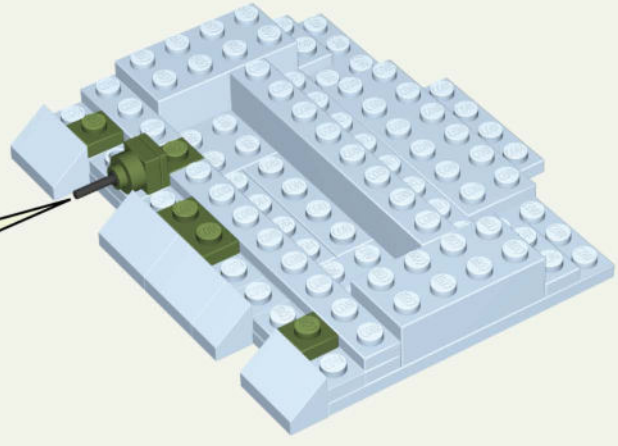
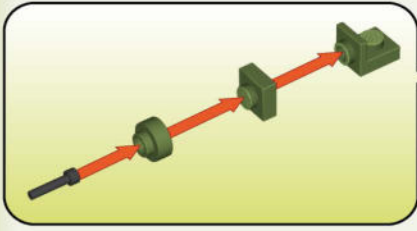

- 
x3
- 
x1
- 
x1
- 
x1
- 
x1

38

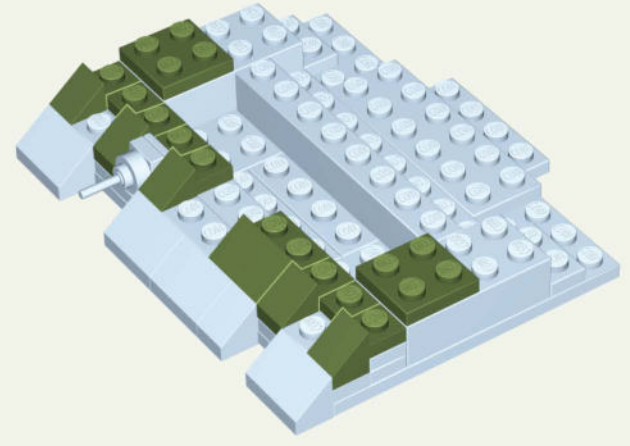

- 
x5
- 
x2
- 
x1
- 
x3

39

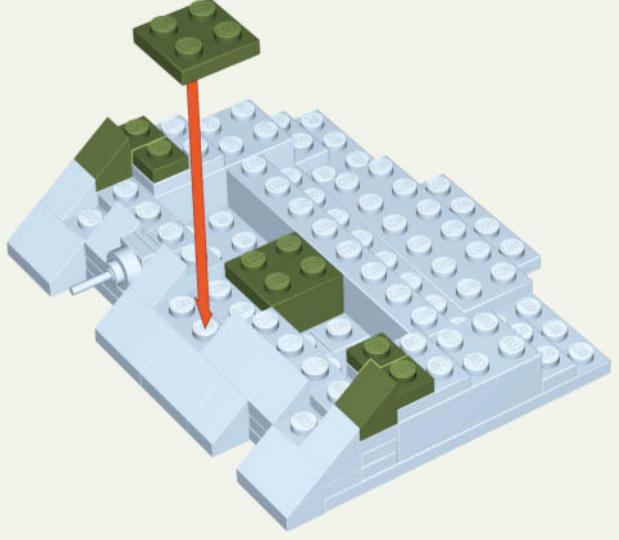

- 
x2
- 
x2
- 
x1
- 
x1

40

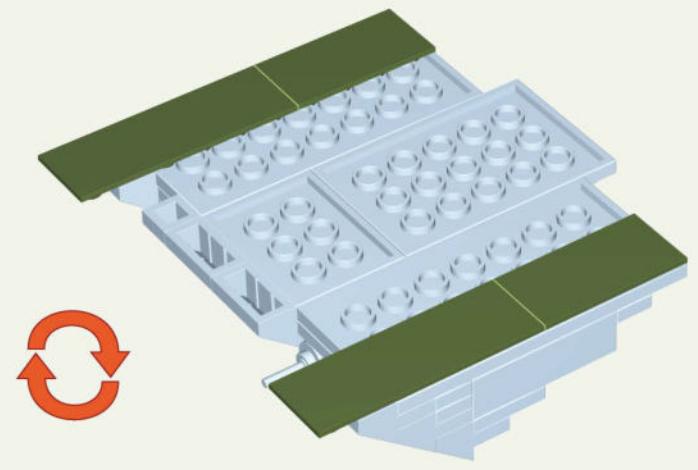

- 
x2
- 
x2

41

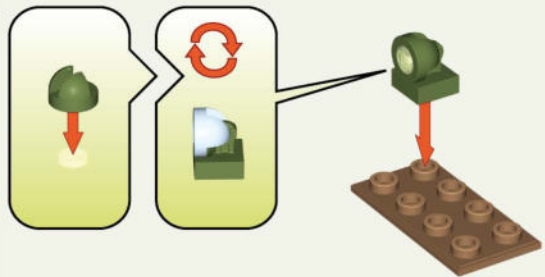

- x1
- x1
- x1
- x1

42

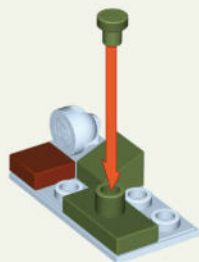

- x1
- x1
- x1
- x1

43

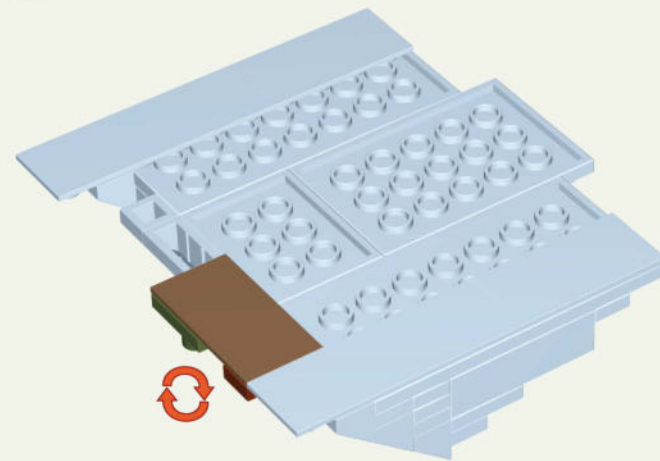

44

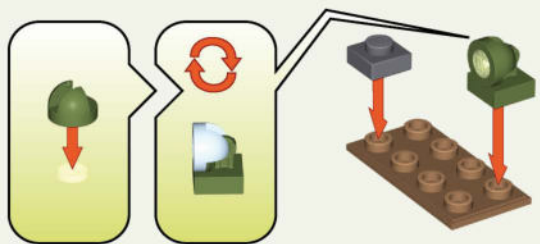

- x1
- x1
- x1
- x1
- x1

45

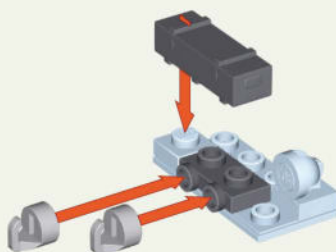

- x1
- x2
- x1

46

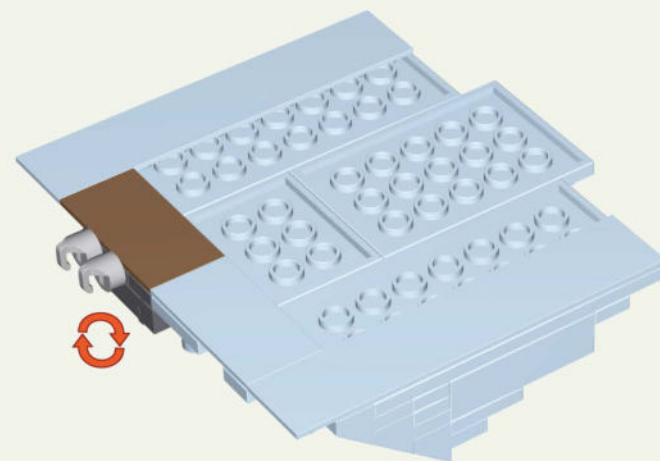

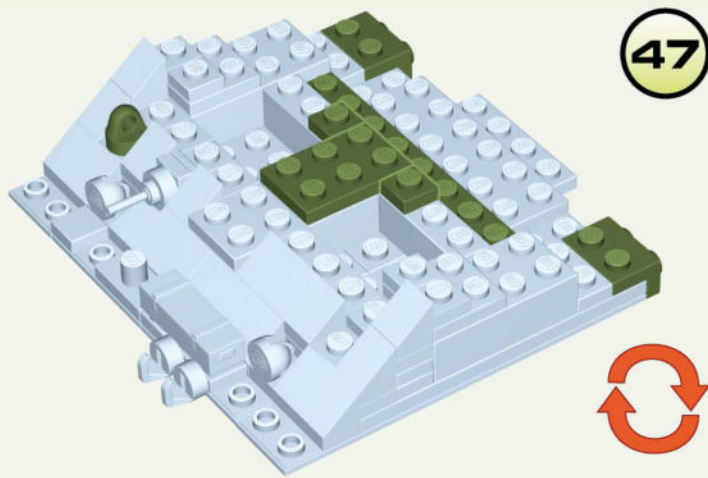

47

- x1
- x1
- x2
- x1
- x2

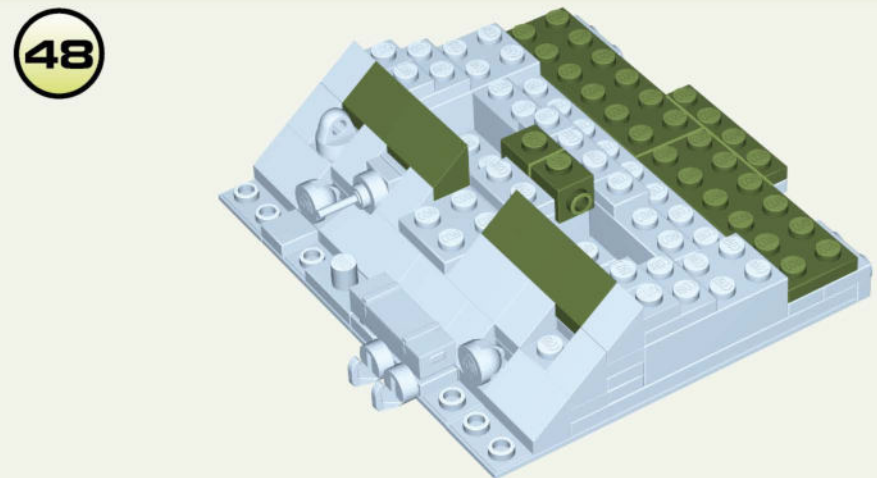

48

- x2
- x2
- x2
- x1

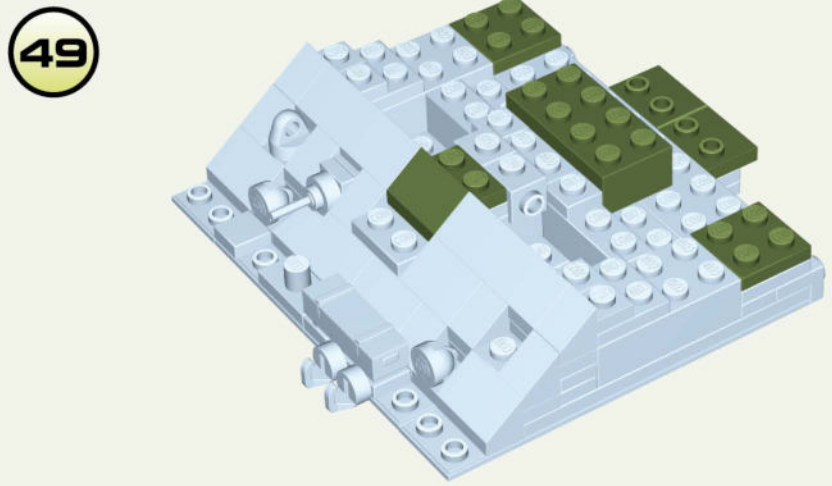

49

- x1
- x2
- x1
- x2

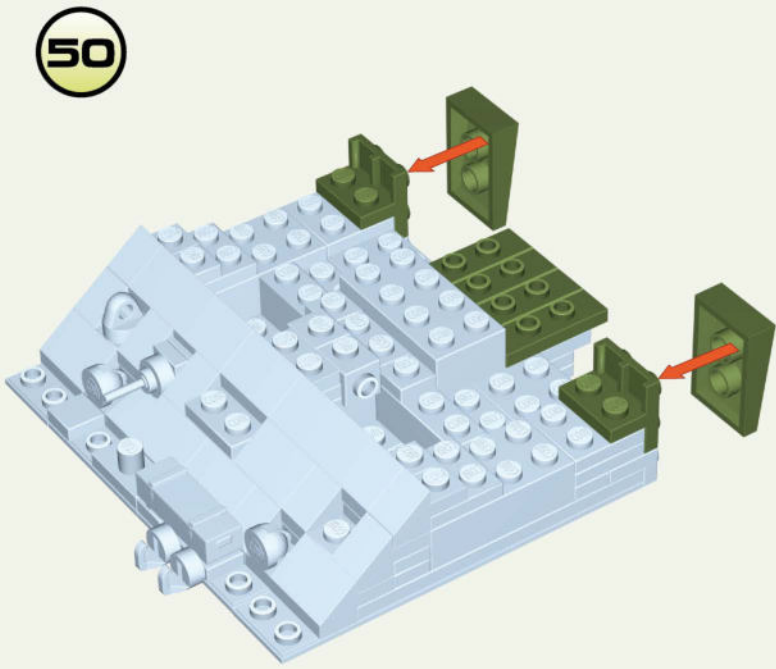

50

- x2
- x4
- x2

51



x2



x2



x1

52

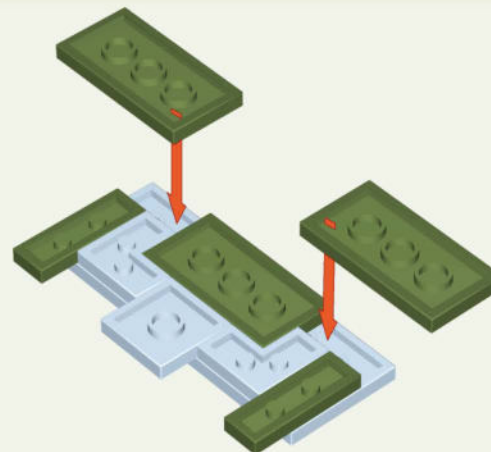

x2



x3

53

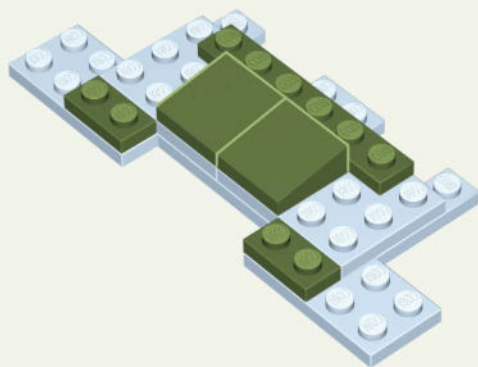

x2



x2



x1

54

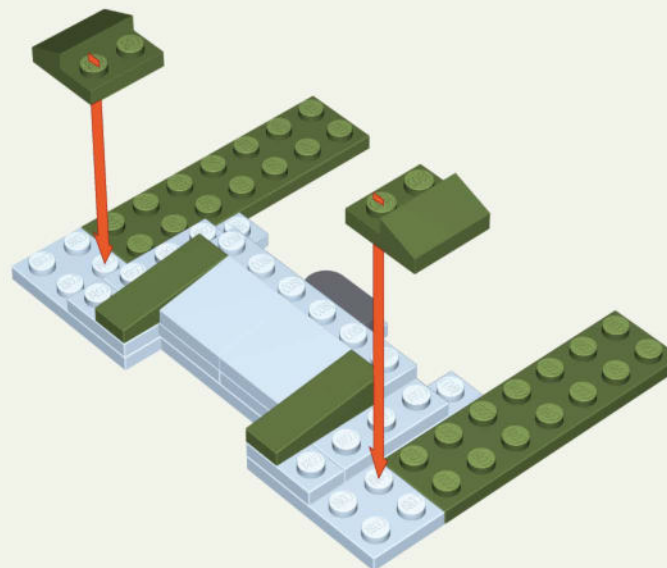

x2



x2



x2



x1

55

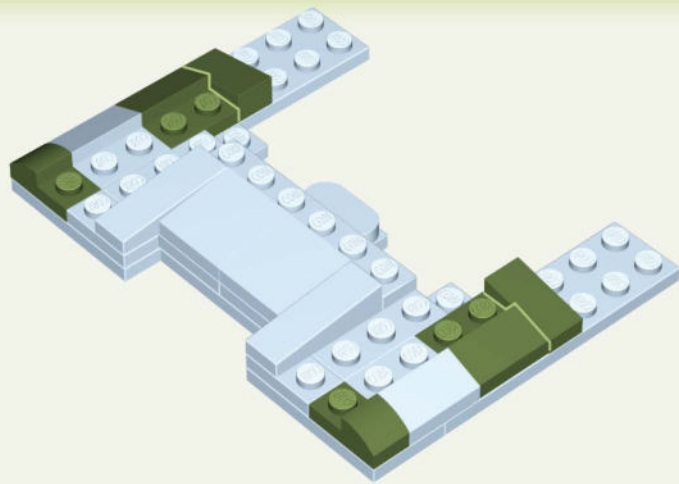

56

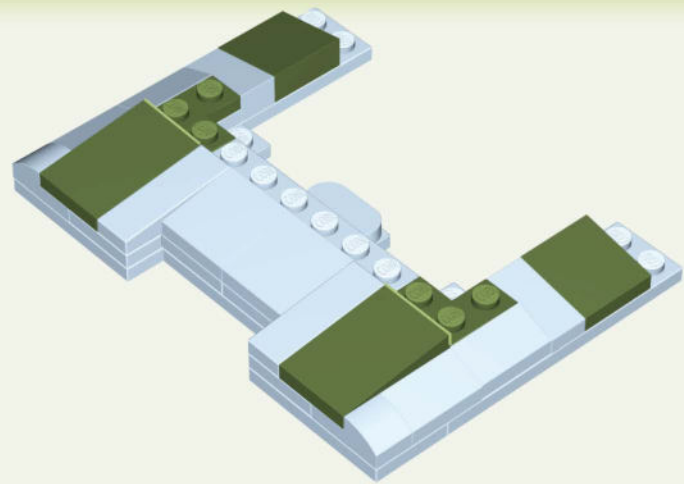

57

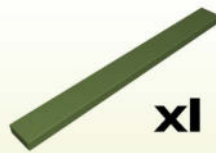
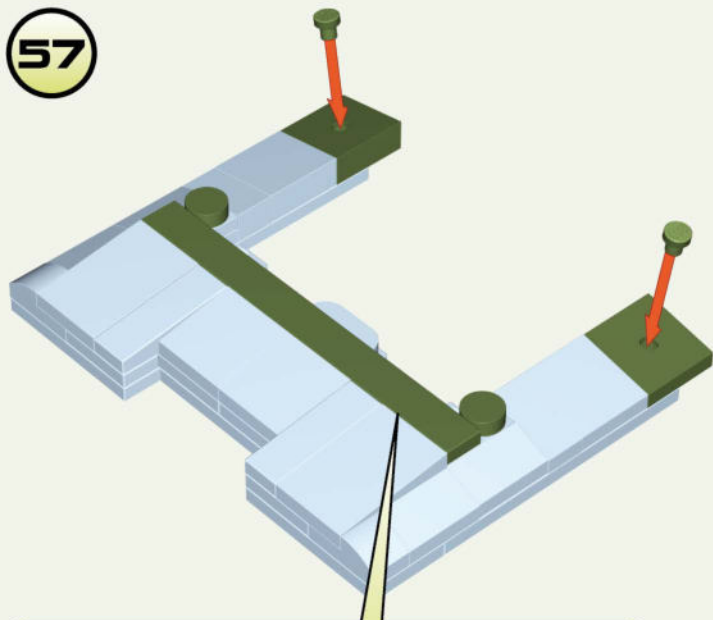

58

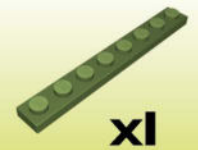
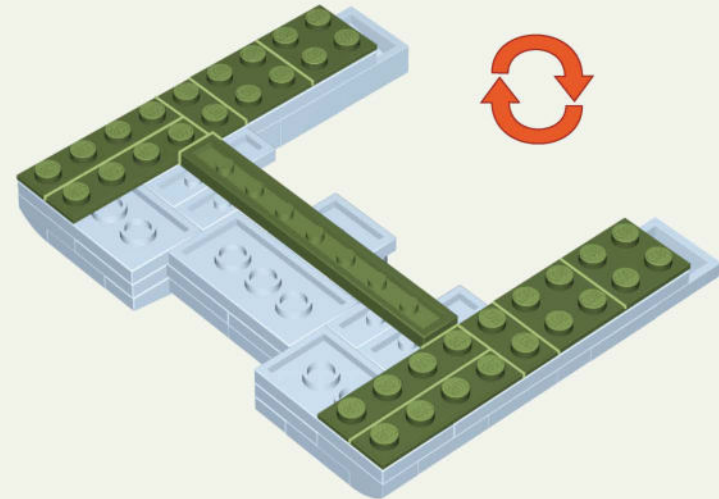

59

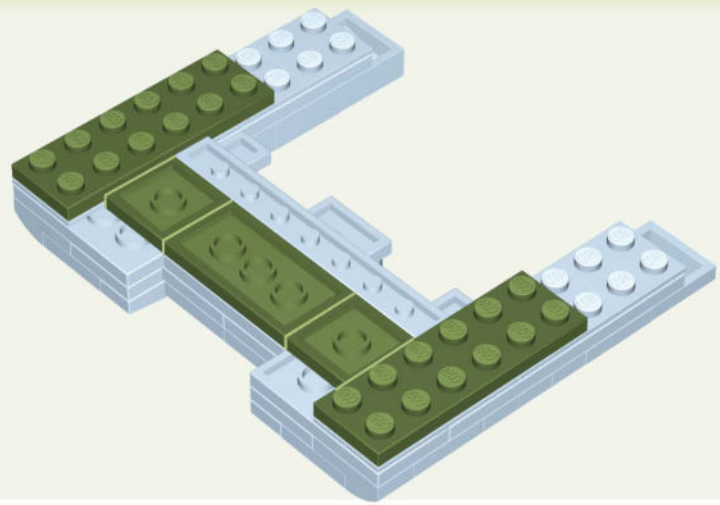

x2



x2



x1

60

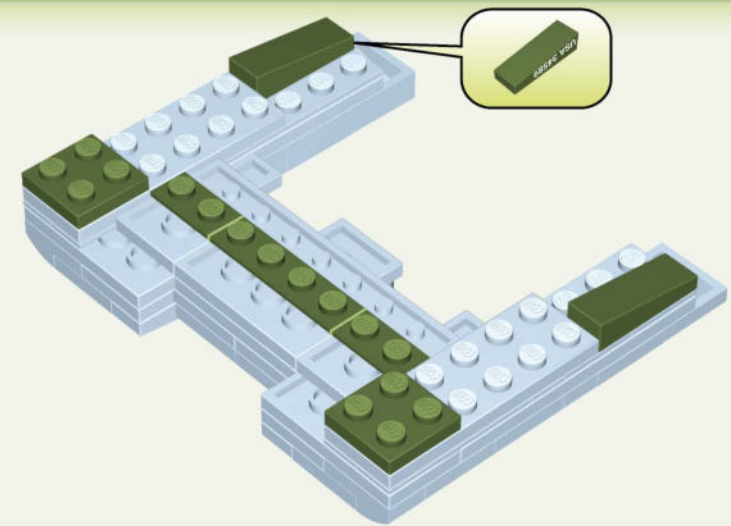

x2



x2



x1



x1



x1

61

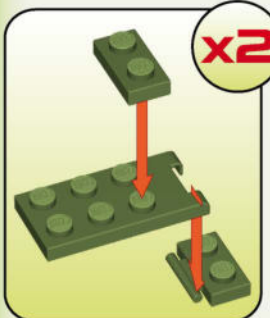
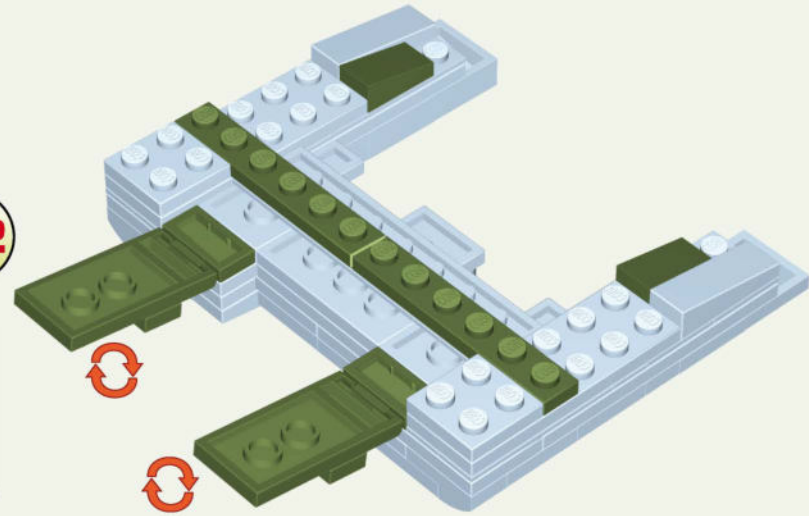

x2



x2



x2



x2



x2

62

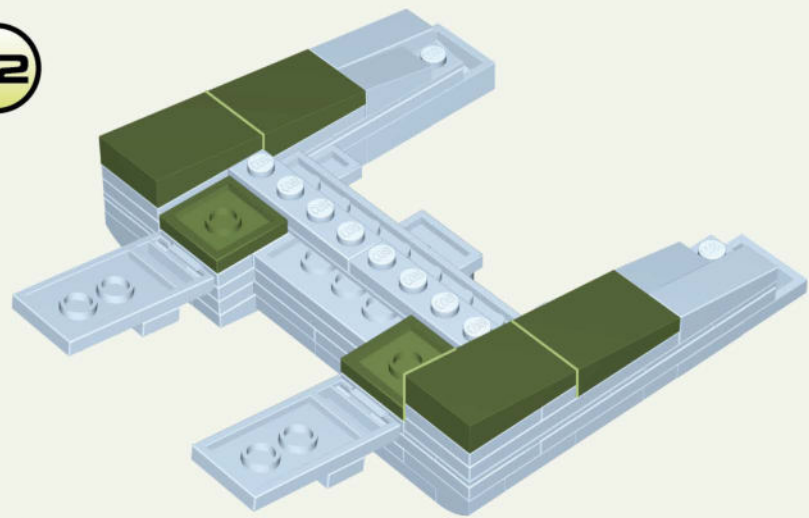

x2



x4

63

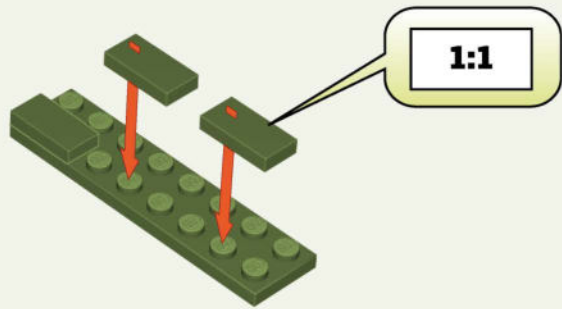

64

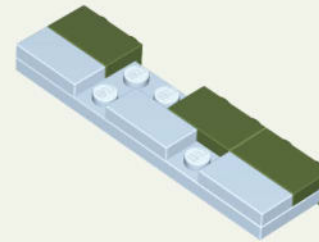

65

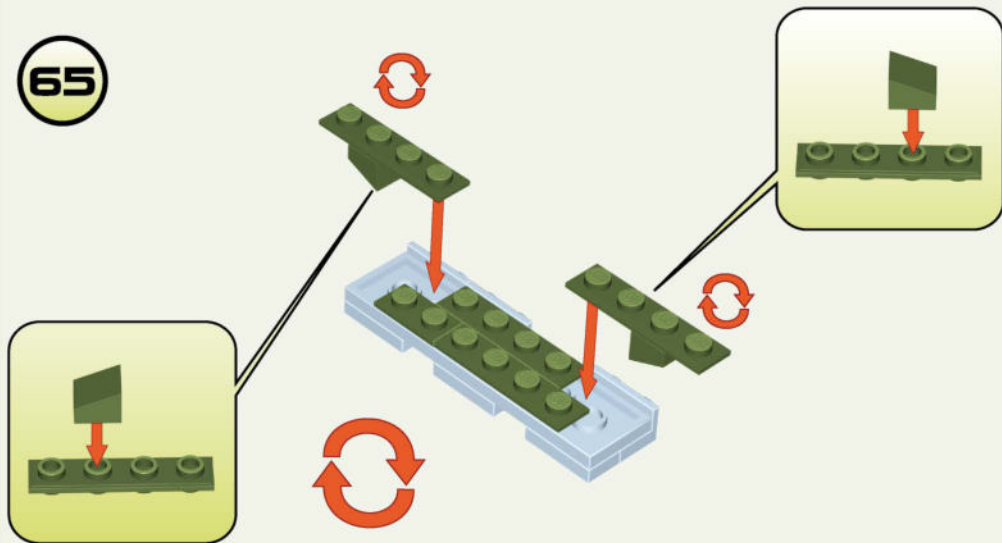

66

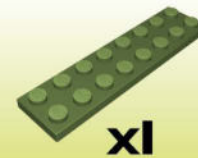
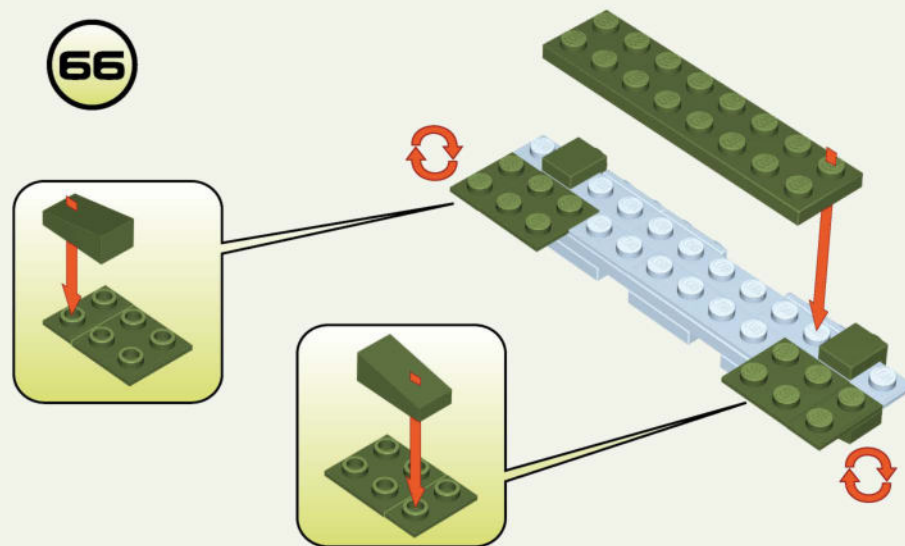

67

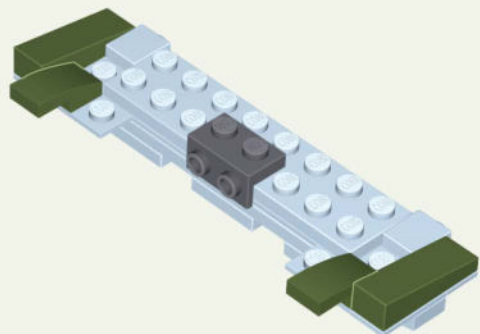

x2



x2



x1

68

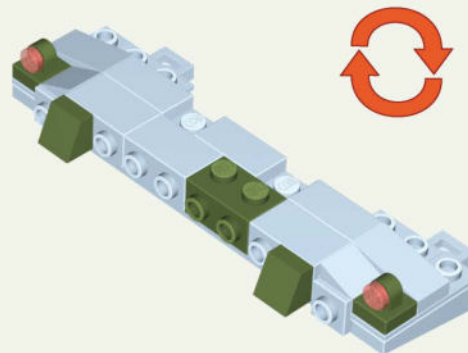

x2



x2



x2

3



x2



x1

69

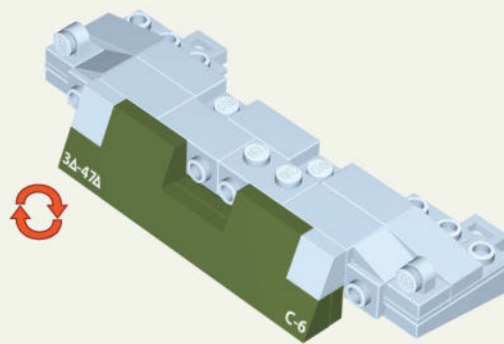
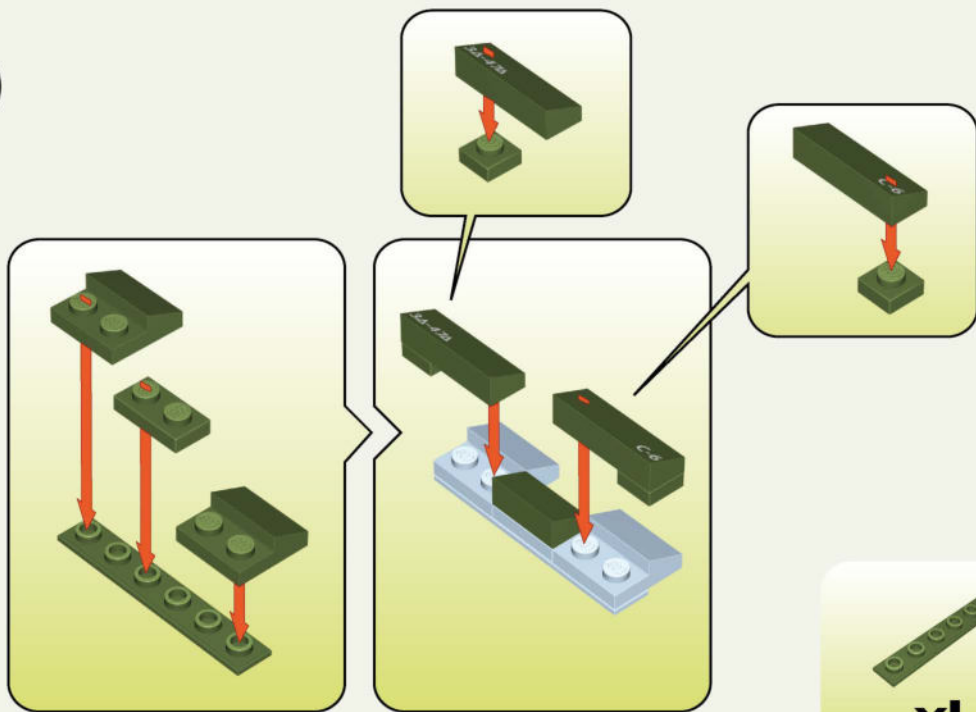

x1



12

x2



x1



9

x1



x2



x1



x1

70

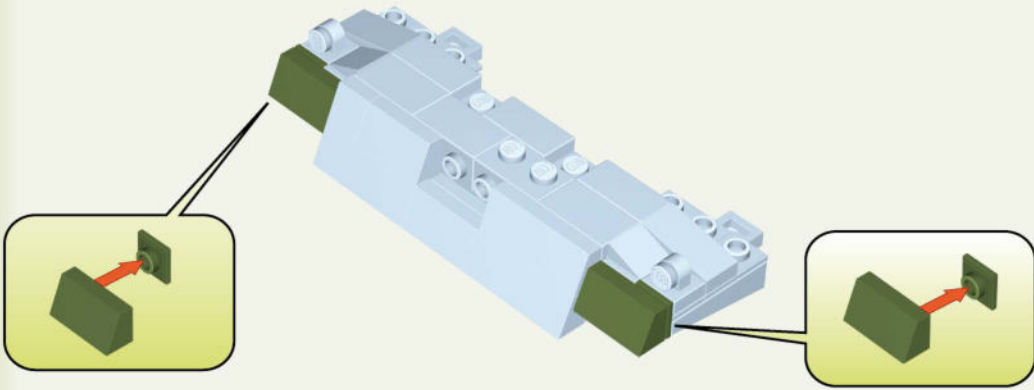

 **x2**
 **x2**

72

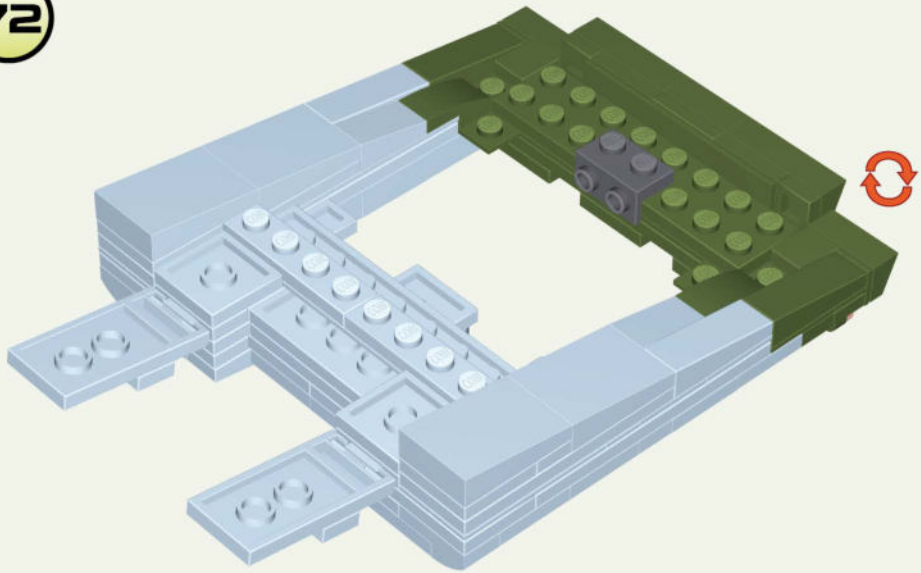

71

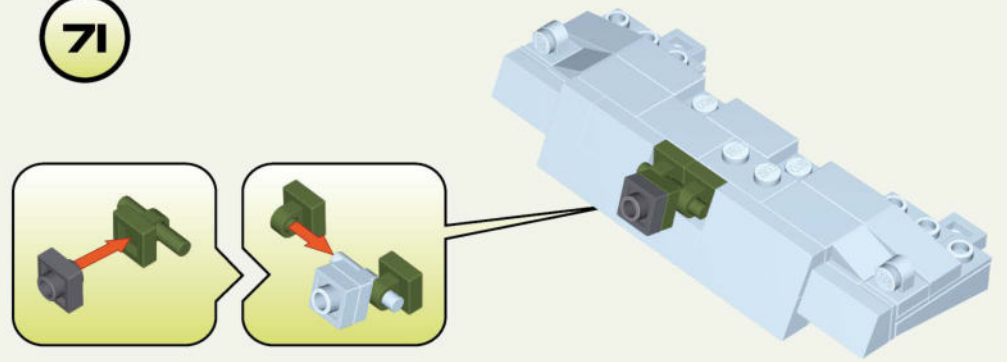

1:1
 **x1**
 **x3**
 **x1**

73

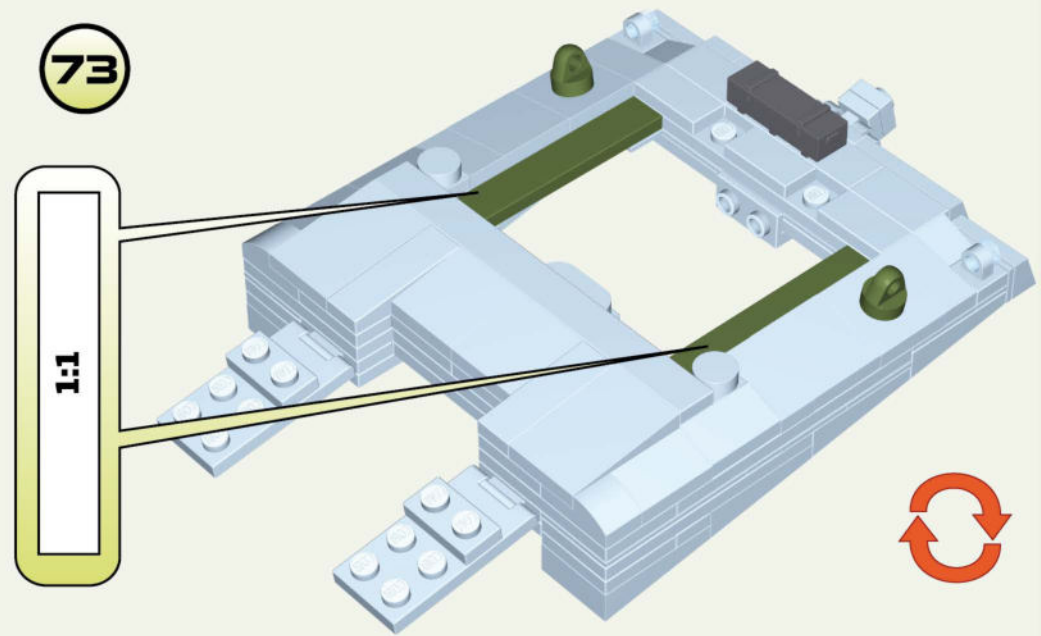

1:1
 **x2**
 **x2**
 **x1**

74

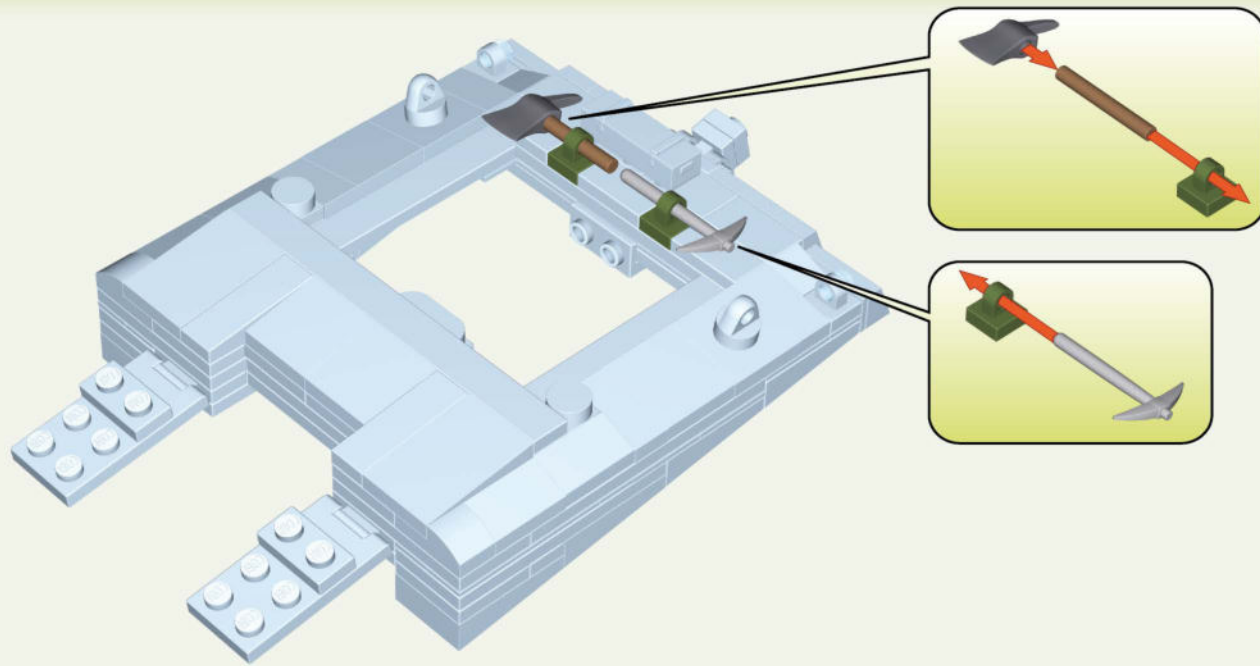

1:1

 x1

 x1

 x2

 x1

75

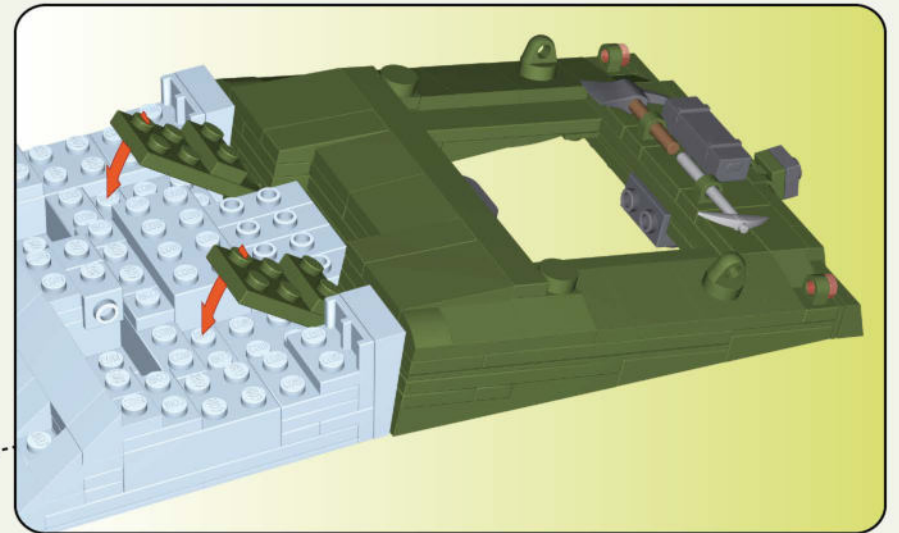
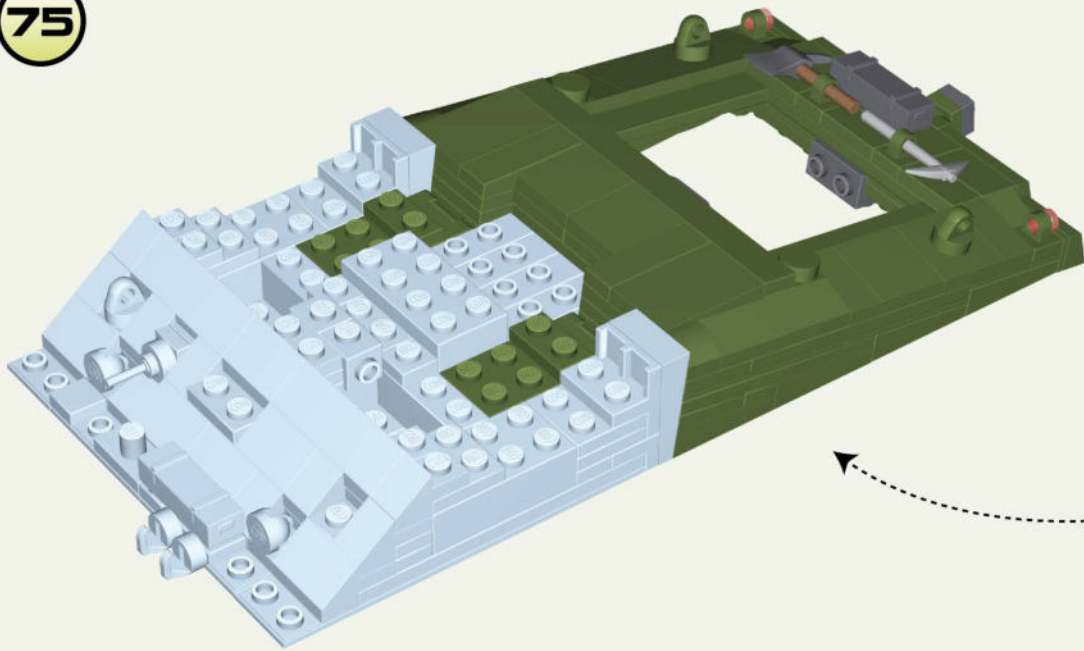

76

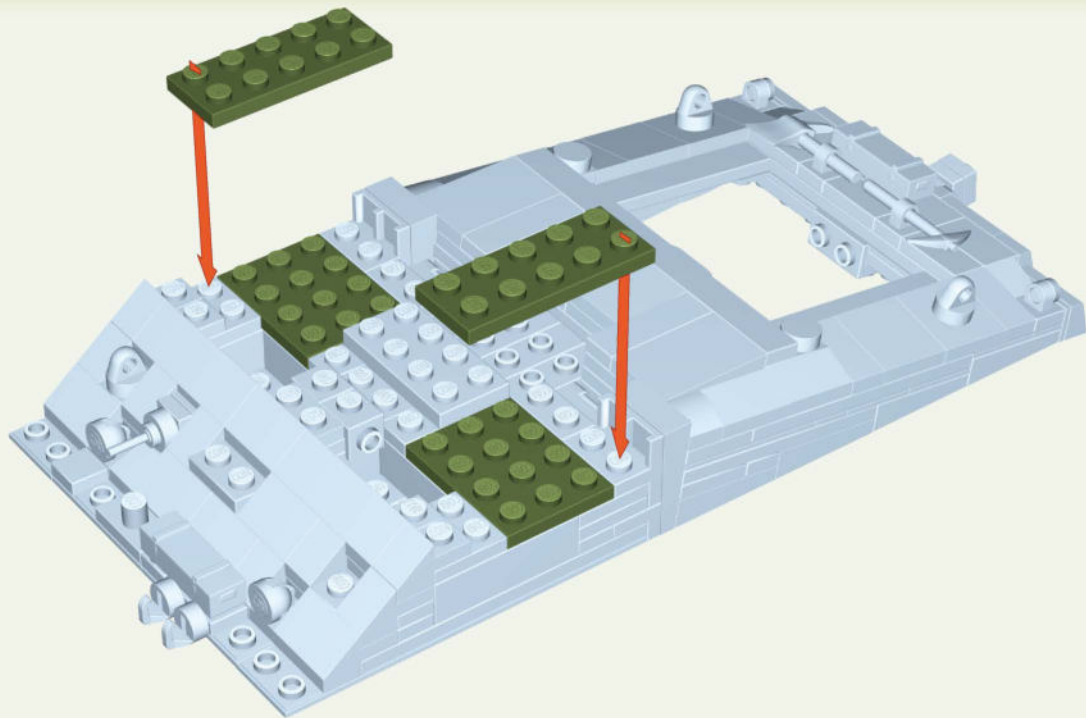

77

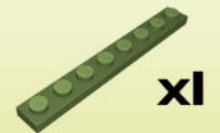
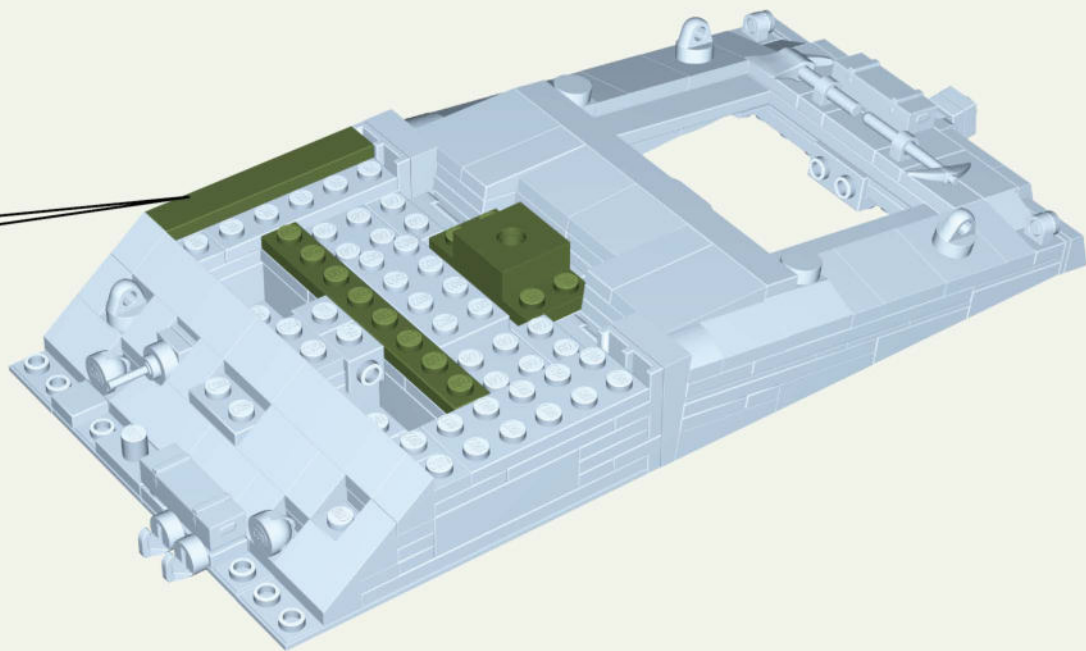

1:1

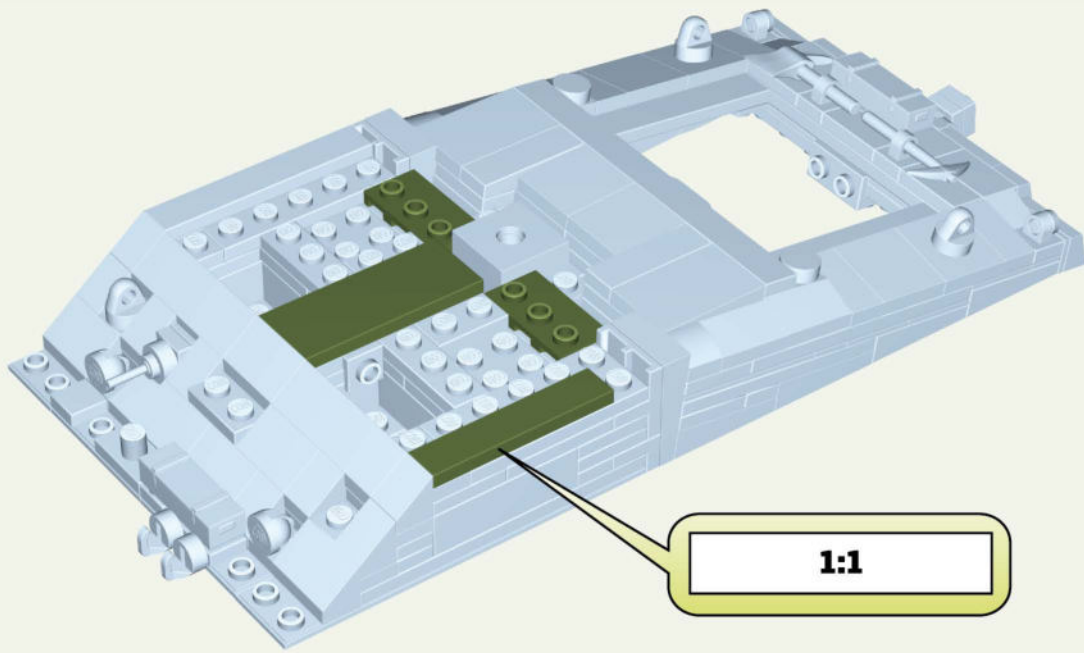

78



1:1

-  x2
-  x1
-  x1



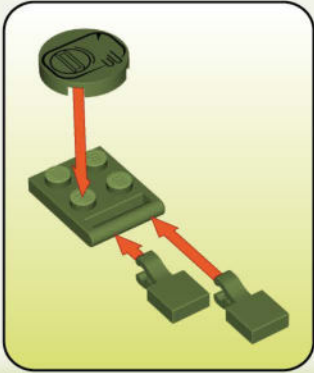
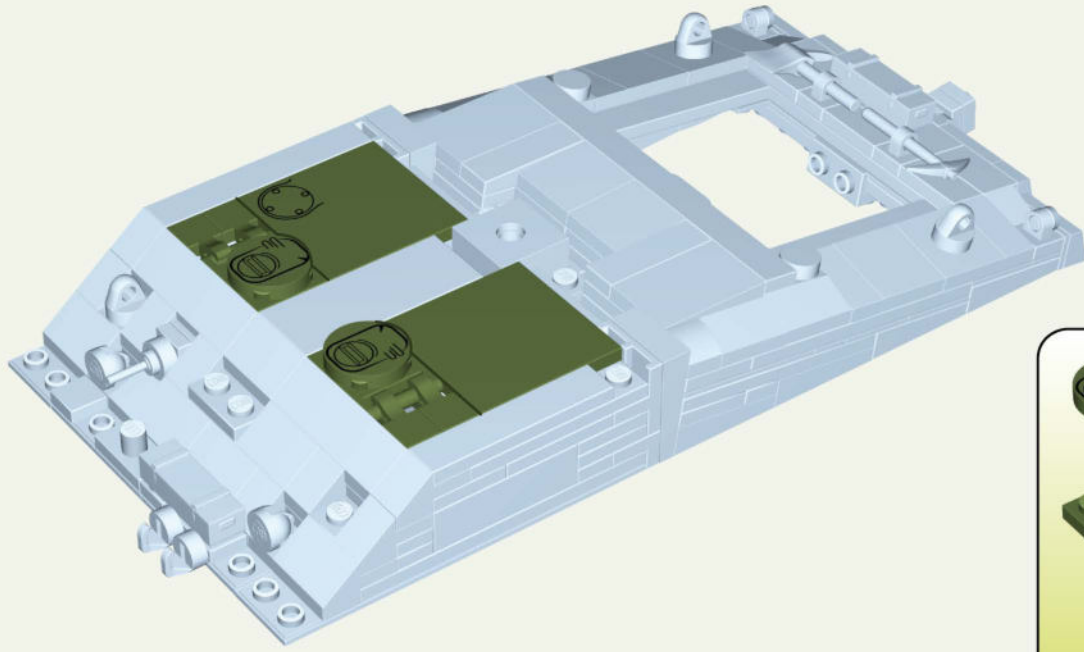
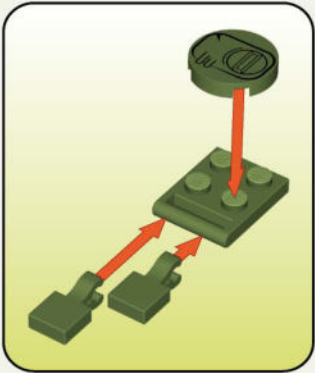



79

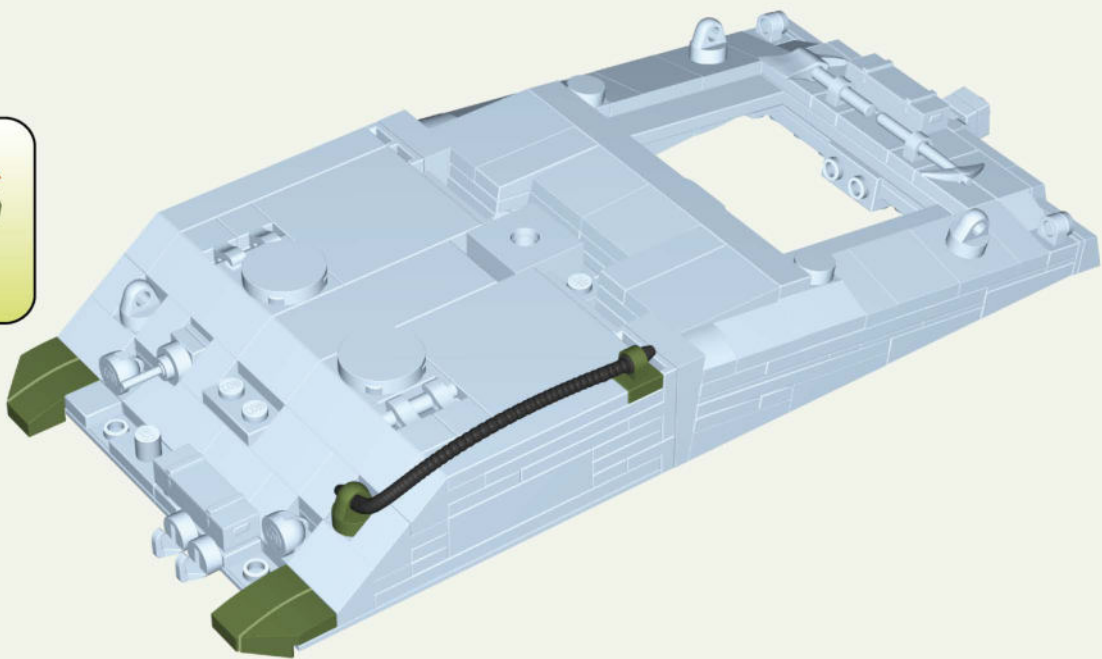

-  x2
-  x1
-  x1
-  x4
-  x1
-  x1

80





-  x1
-  x2
-  x1
-  x1
-  x1
-  x1

81

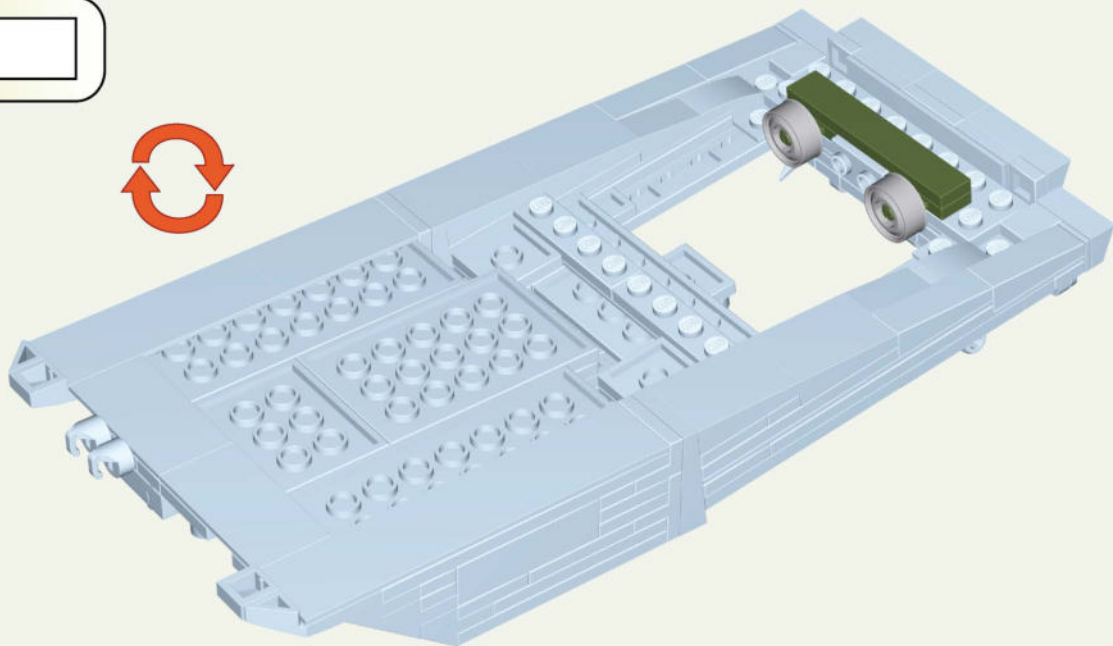
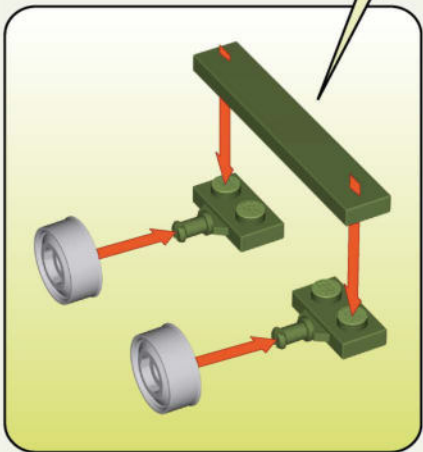
1:1



-  x2
-  x1
-  x2

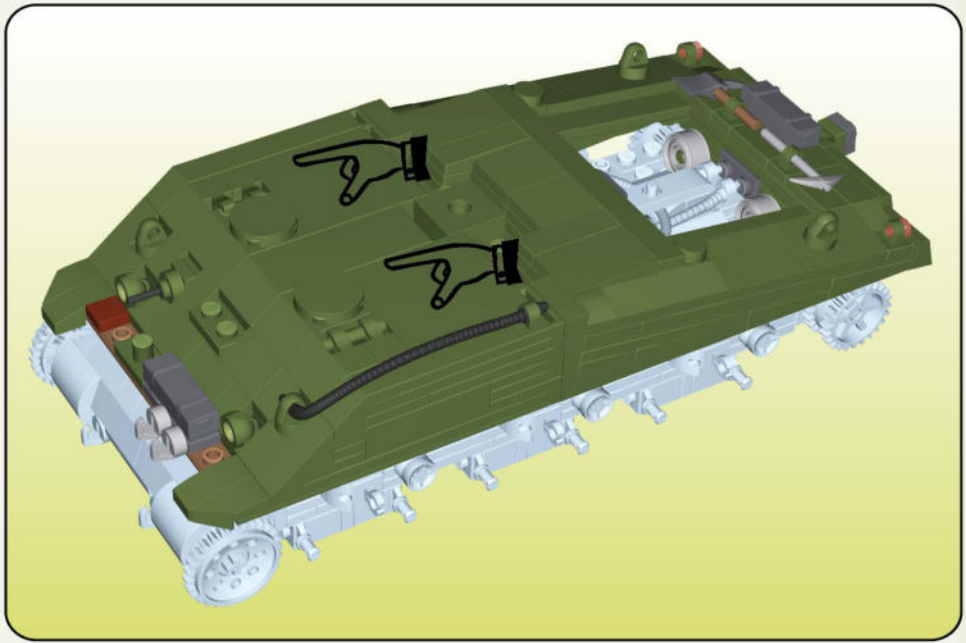
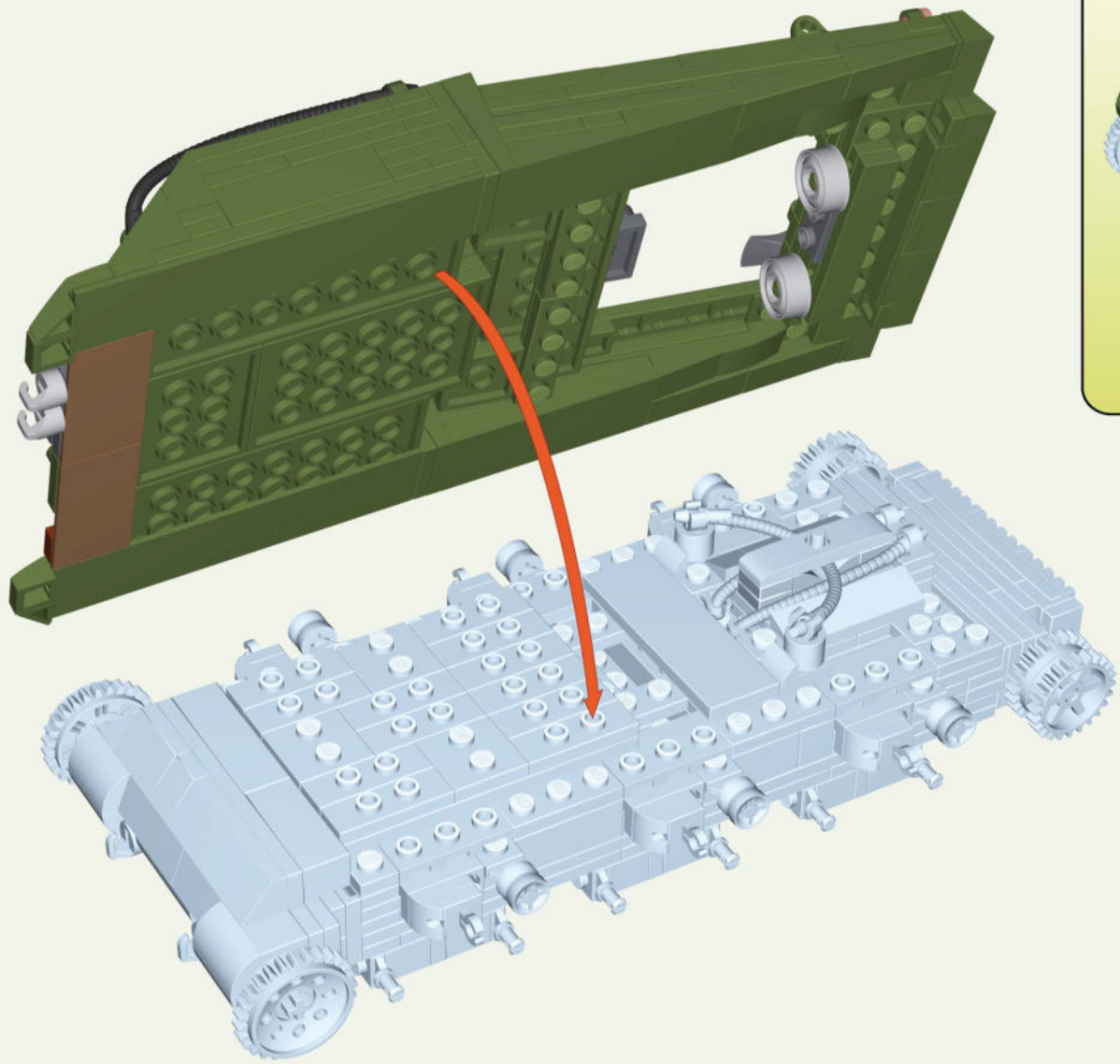

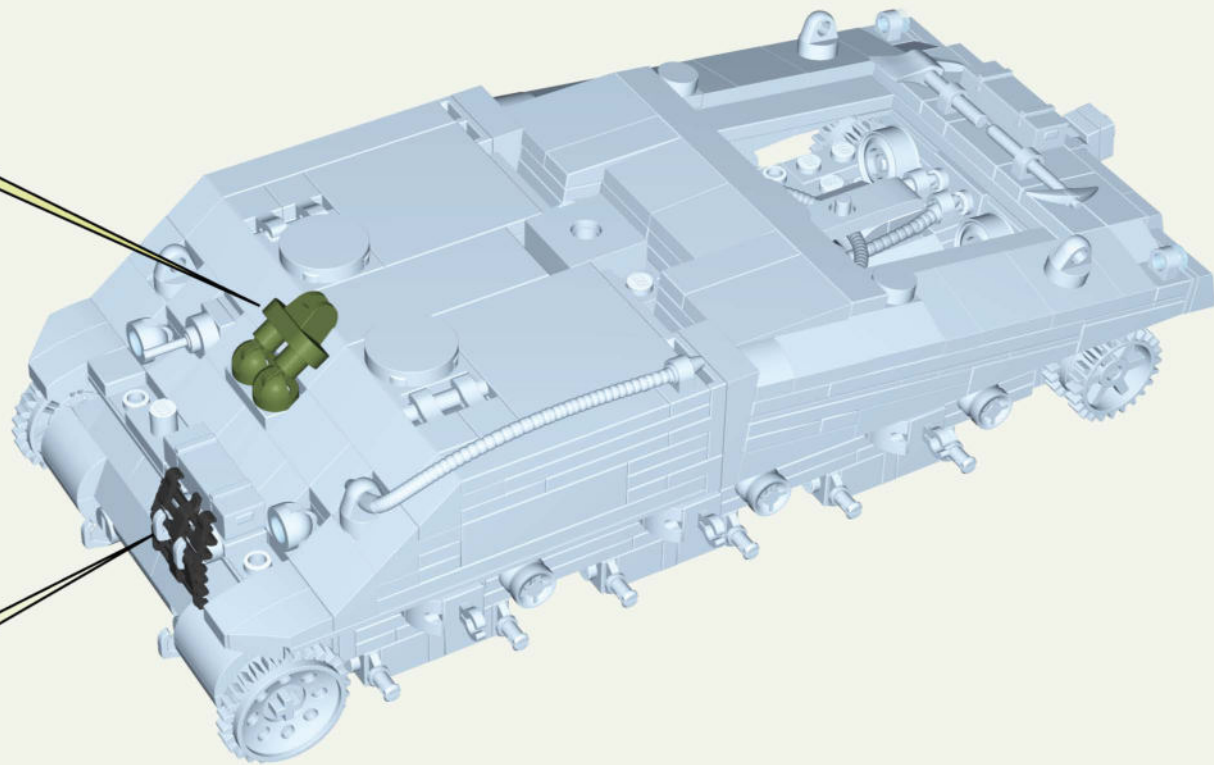
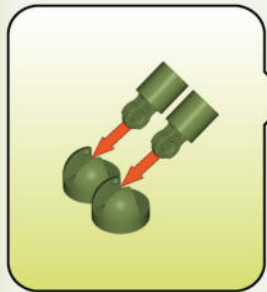

x2



x2



x2



x1



x1

84

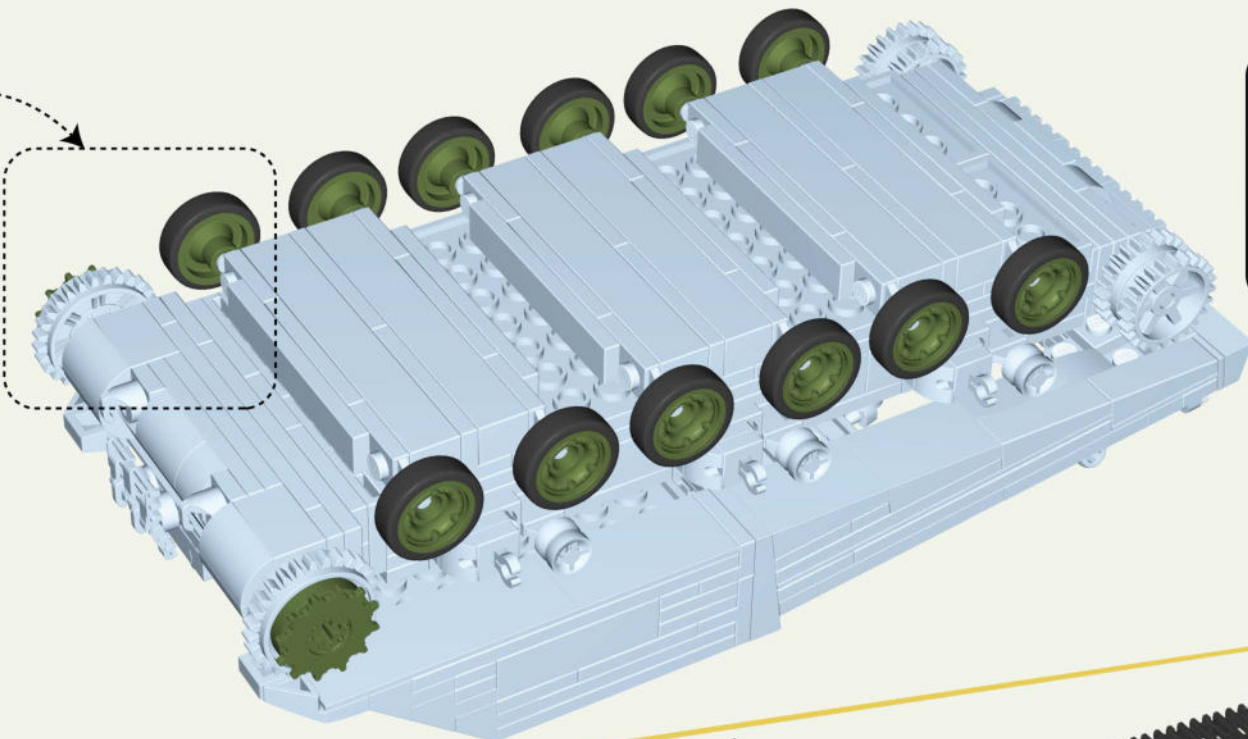
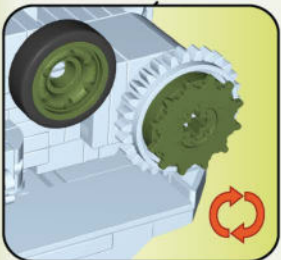

-  x12
-  x12
-  x2

85

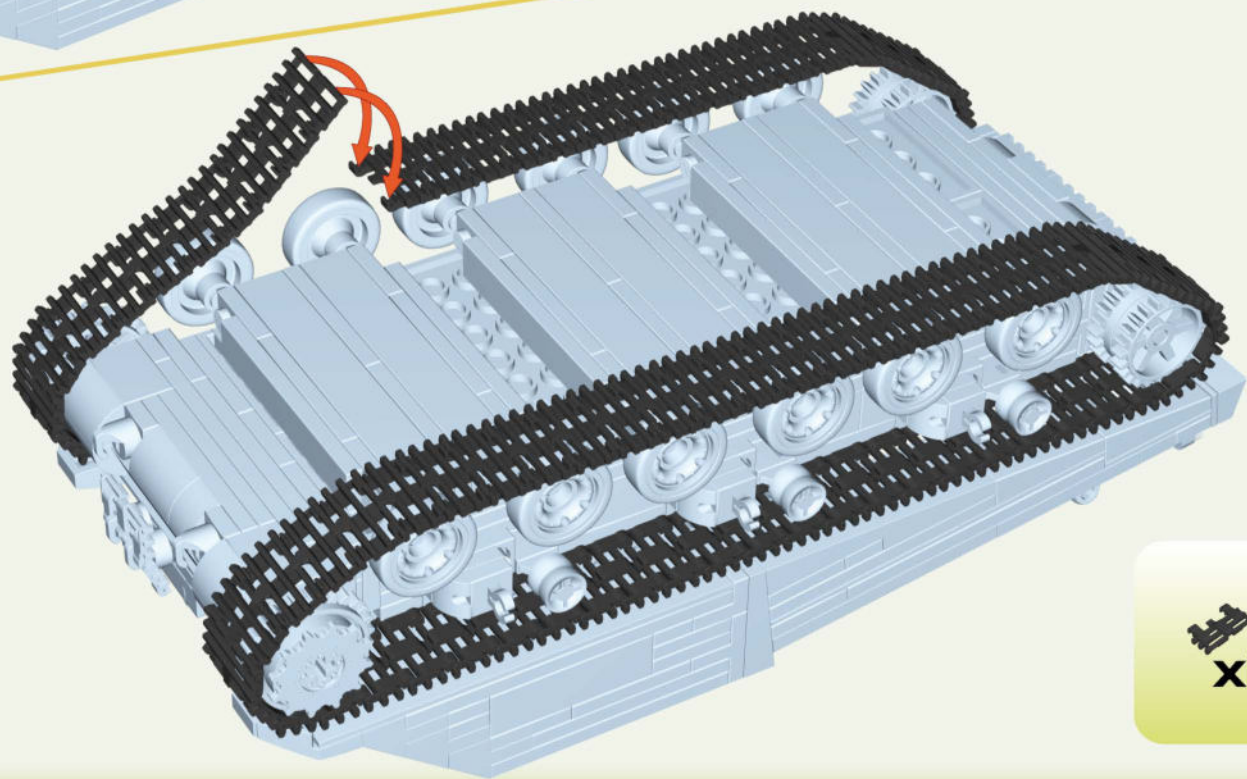
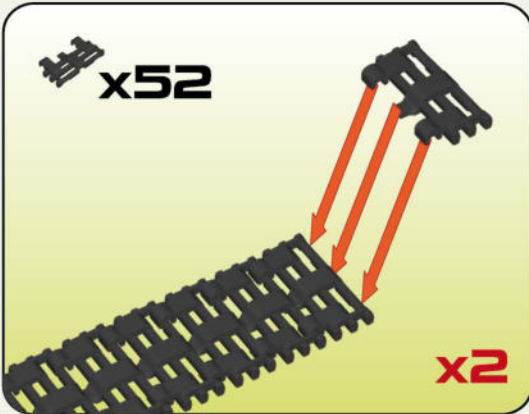

-  x104

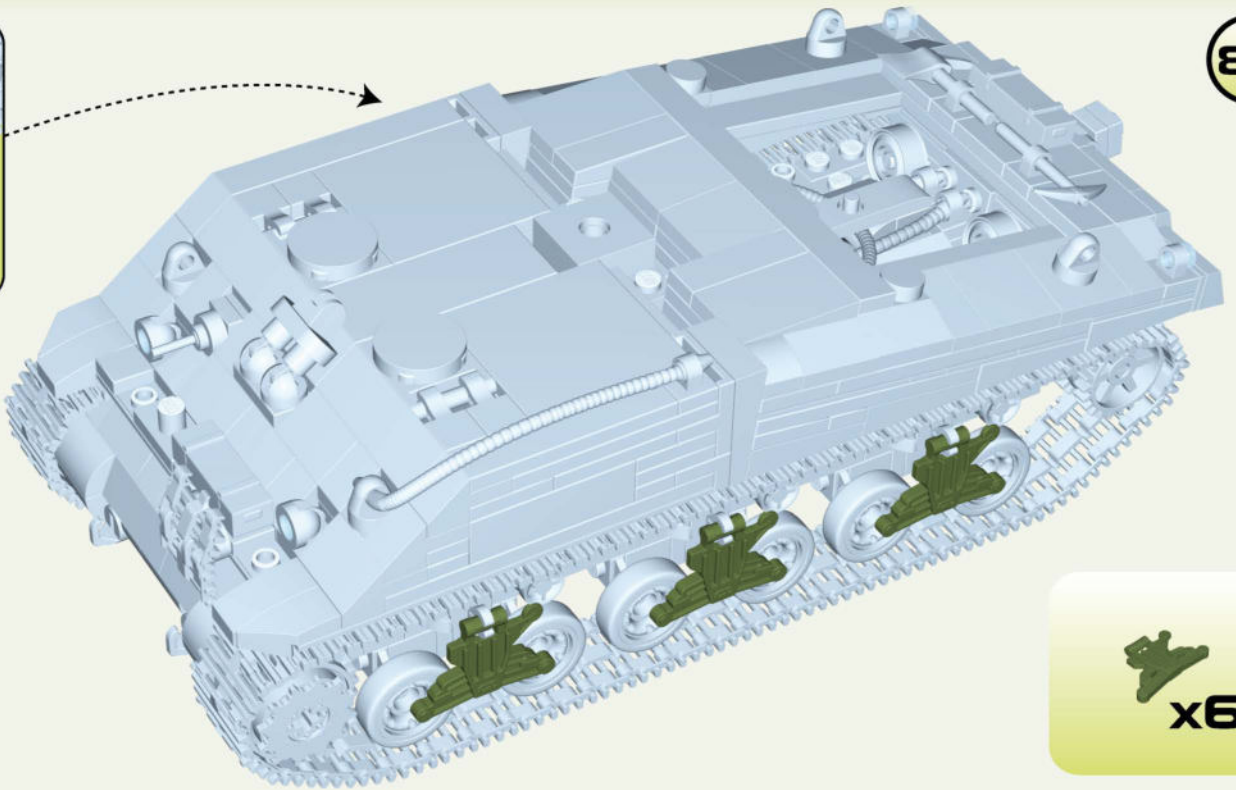
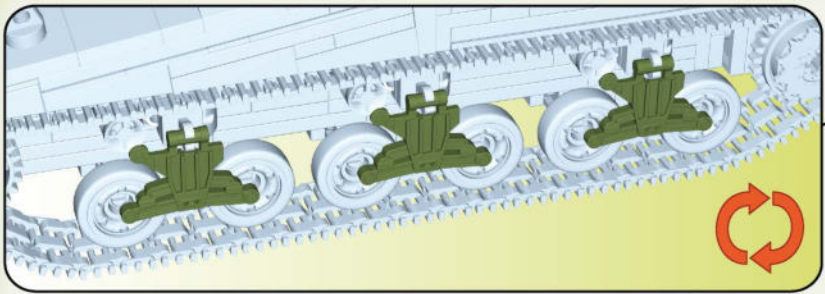

87

1:1

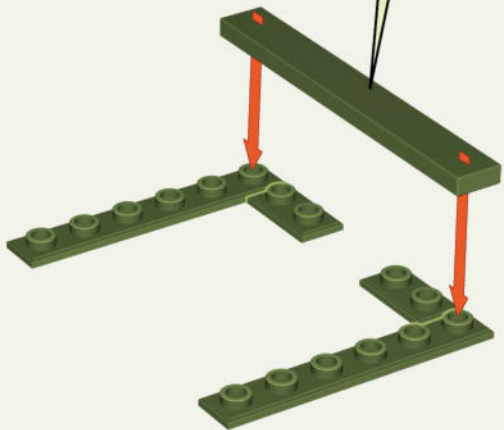

88

1:1

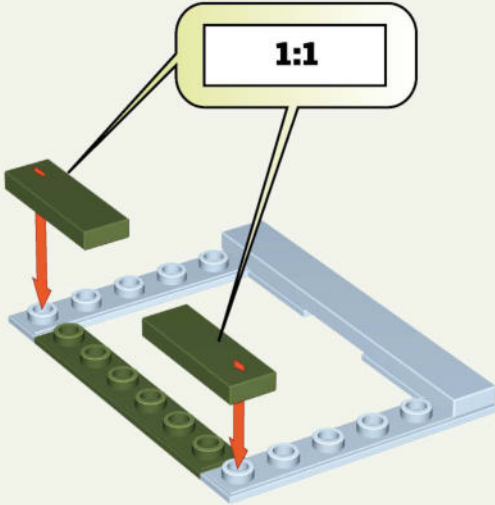

89

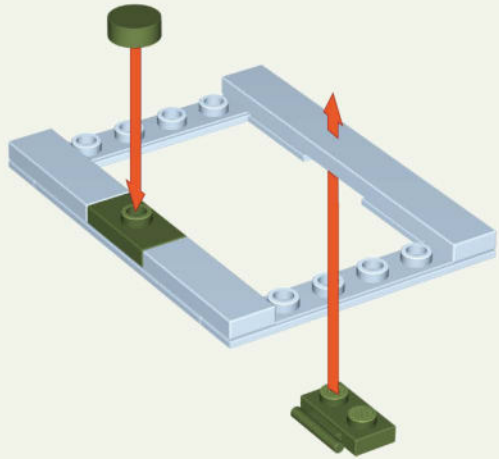

1x2 Technic Brick (Green) x1

1x2 Technic Brick (Green) x1

1x2 Technic Brick (Green) x1

90

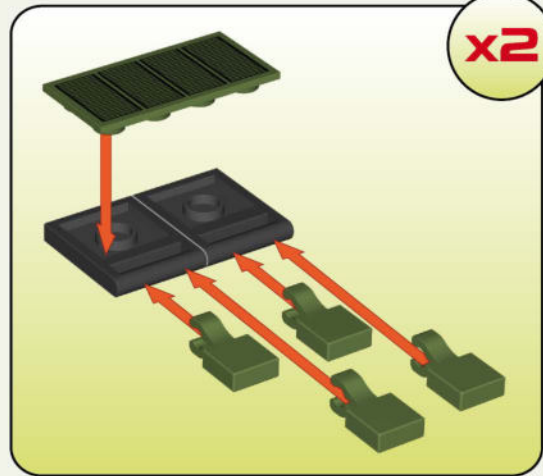

x2

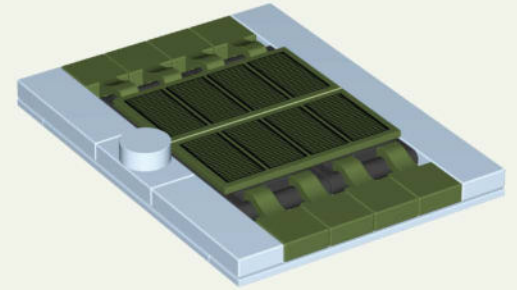

1x2 Technic Brick (Green) x8

1x2 Technic Brick (Black) x4

1x2 Technic Brick (Green) x2

x8

x4

x2

91

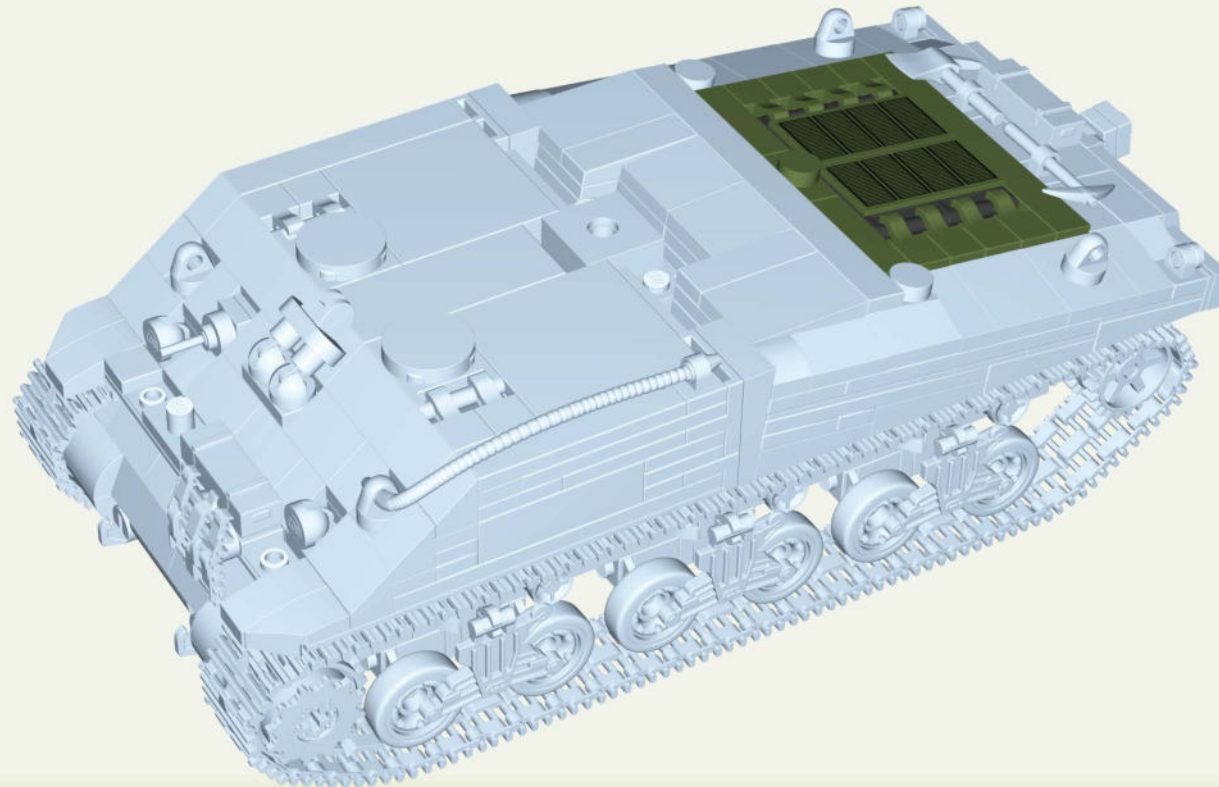

92

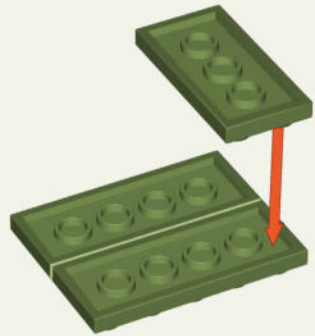

93

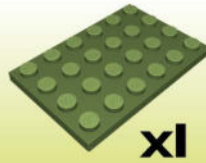

94



95

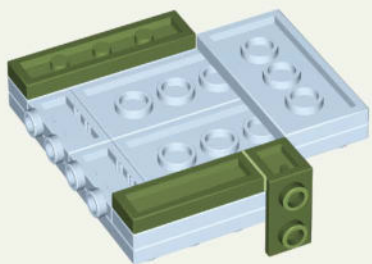

96

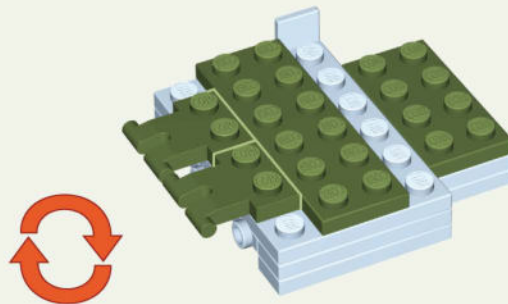

97

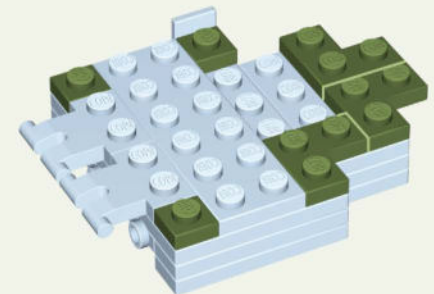

98

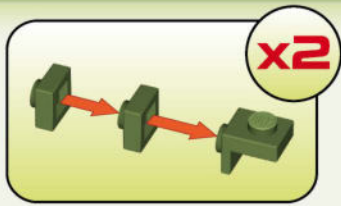
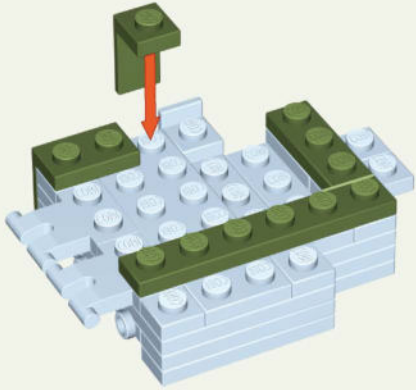

99

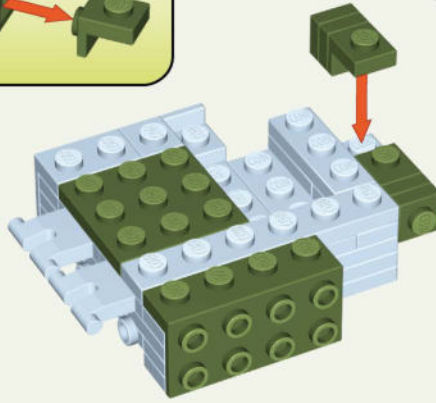

100

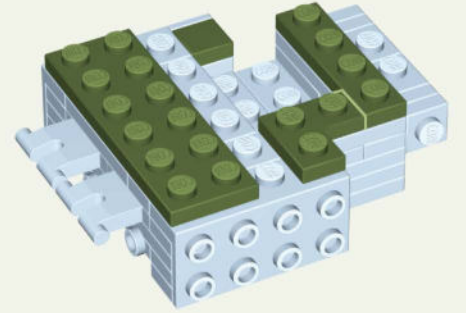

101

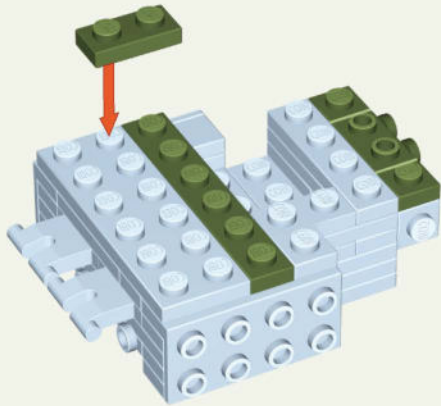

102

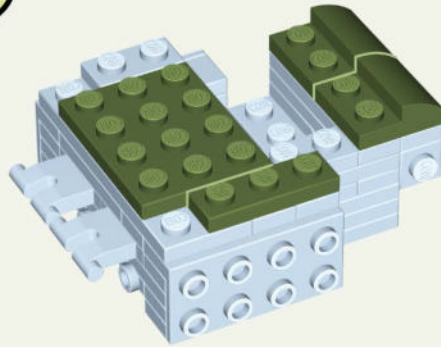

103

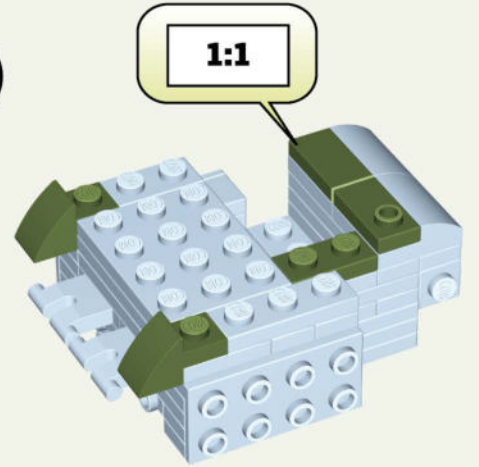

104

1:1

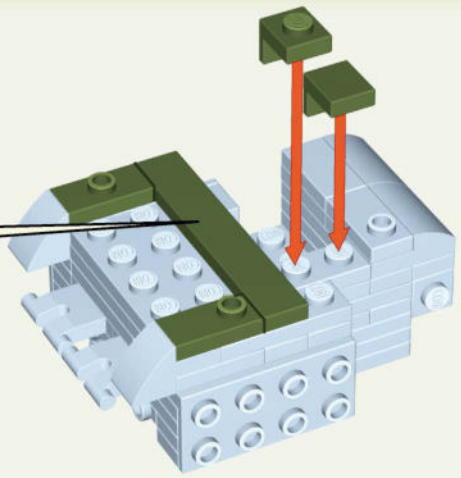

- 1x2 Technic Technax pin x1
- 1x2 Technic Technax pin x1
- 1x6 Technic Technax beam x1
- 1x2 Technic Technax pin x1
- 1x2 Technic Technax pin x1

105

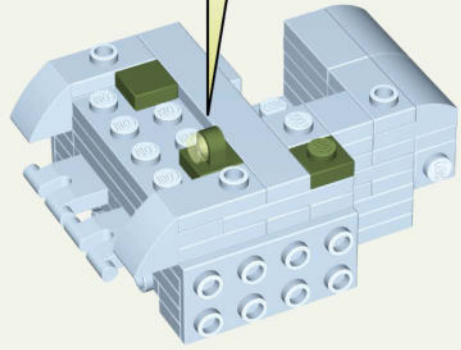

- 1x2 Technic Technax pin x1
- 1x2 Technic Technax pin x1
- Yellow Technic axle x1
- 1x2 Technic Technax pin x1

106

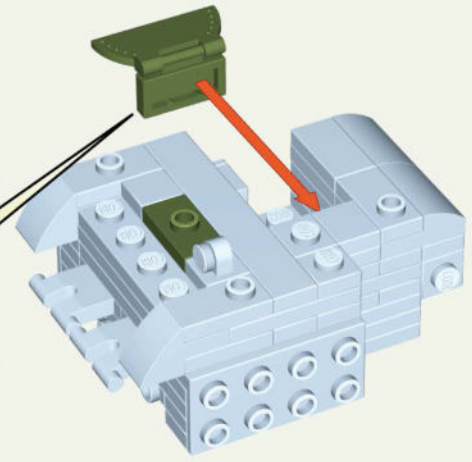
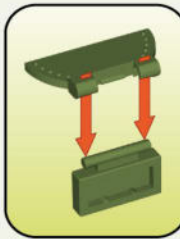

- 1x2 Technic Technax pin x1
- 1x2 Technic Technax pin x1
- 1x2 Technic Technax pin x1

107

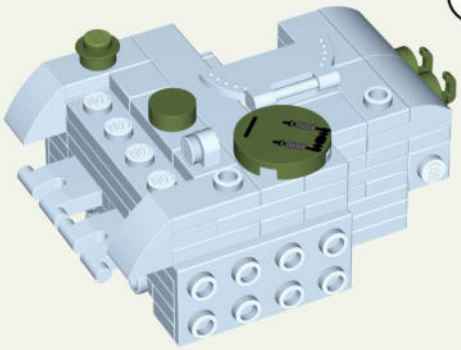
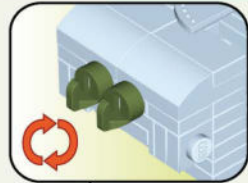

- Dark green Technic axle x1
- Dark green Technic axle x1
- Dark green Technic axle x1
- Dark green Technic axle x2

108



- Dark green Technic axle x1
- Dark green Technic axle x1

109

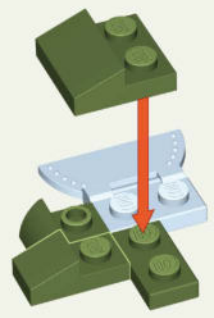

- Dark green Technic axle x1
- Dark green Technic axle x1
- Dark green Technic axle x1
- Dark green Technic axle x1

110

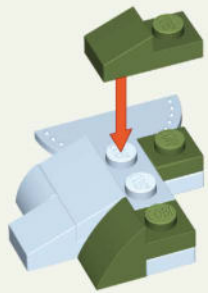

 **x1**
 **x1**
 **x1**

111

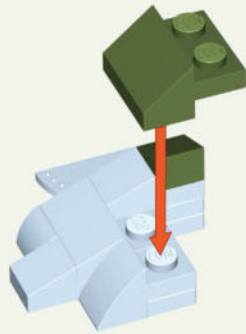

 **x1**
 **x1**

112

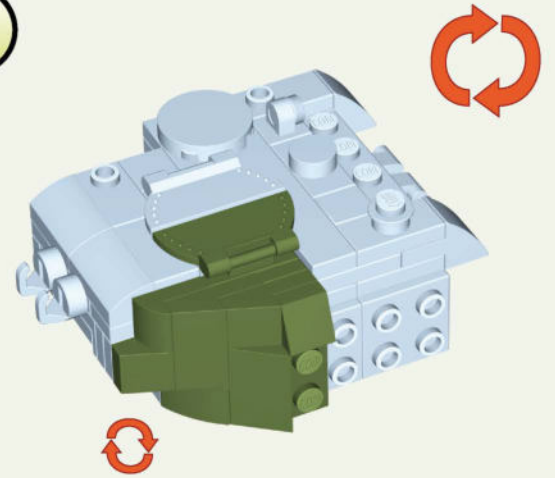

115

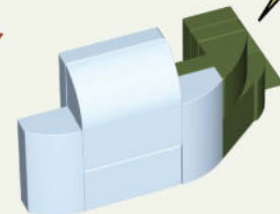
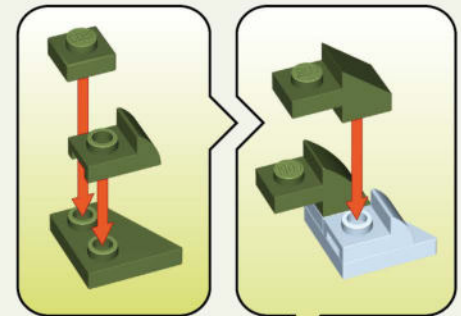

113

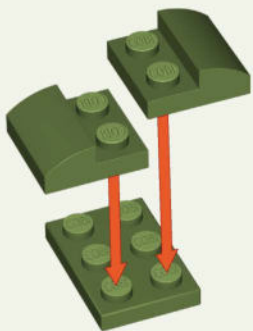

 **x1**
 **x2**

114

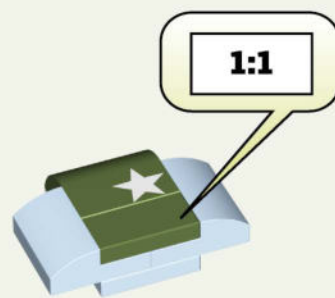

 **x1**
 **x1**

 **x1**
 **x1**
 **x1**
 **x1**
 **x1**

116

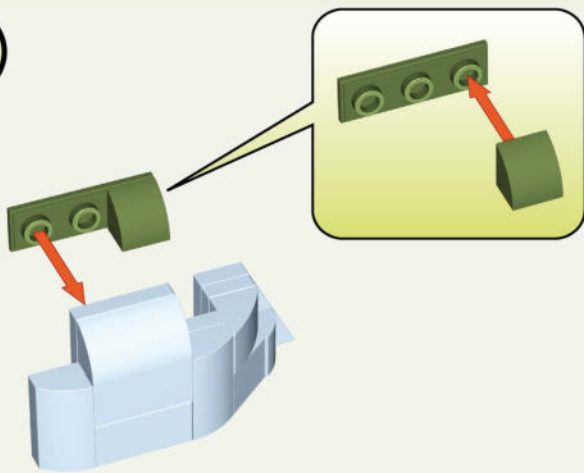

x1



x1

117

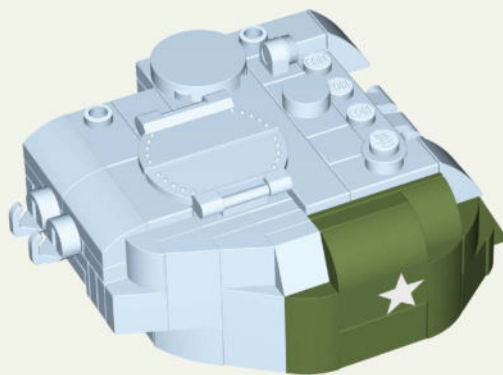

118

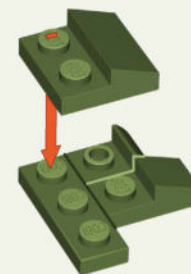

x1



x1

8



x1

12



x1

119

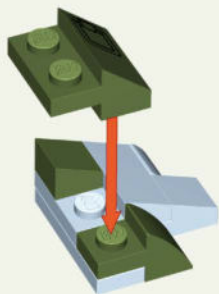

x1

1



x1



x1

120

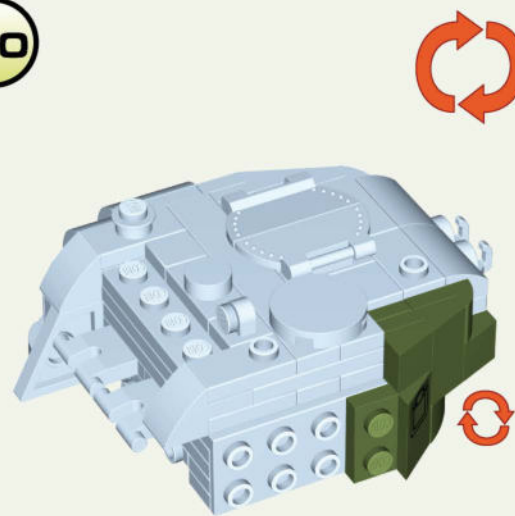

121

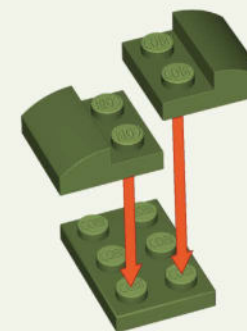

x1

11



x2

122

1:1



x1



x1

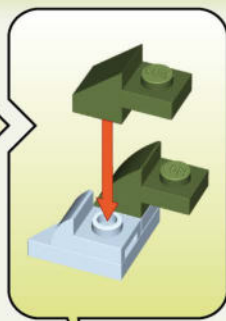
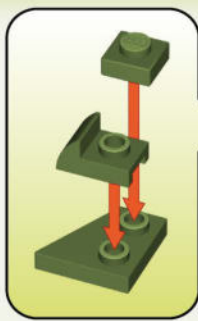

123



x1



x1



x1



x1



x1

124

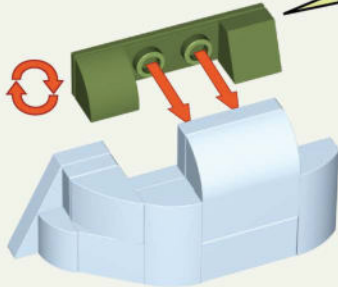
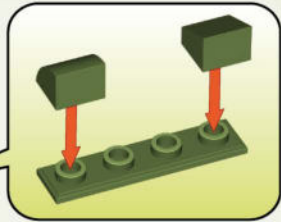

x1



x1



x1

125

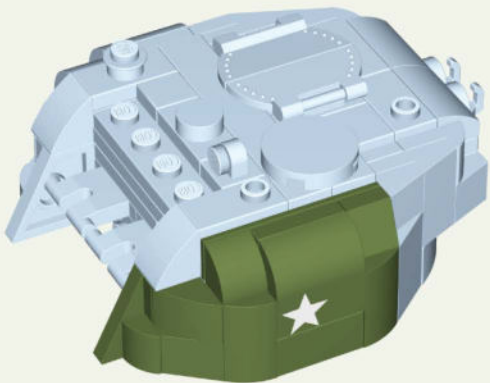

126

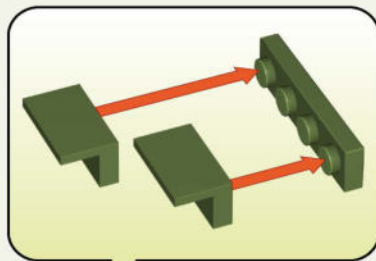

x1



x2

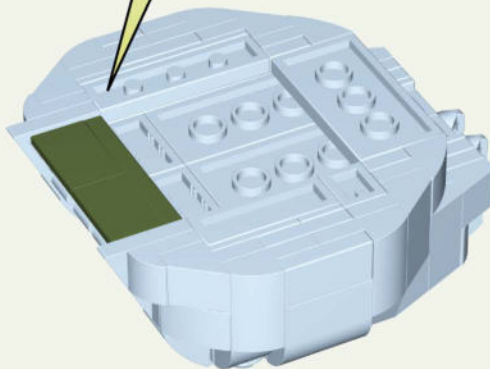

127

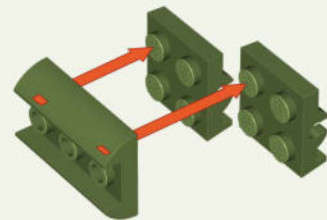

x1



x2

128

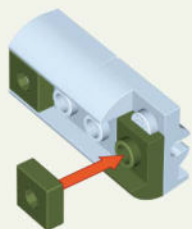



x2



x1

129

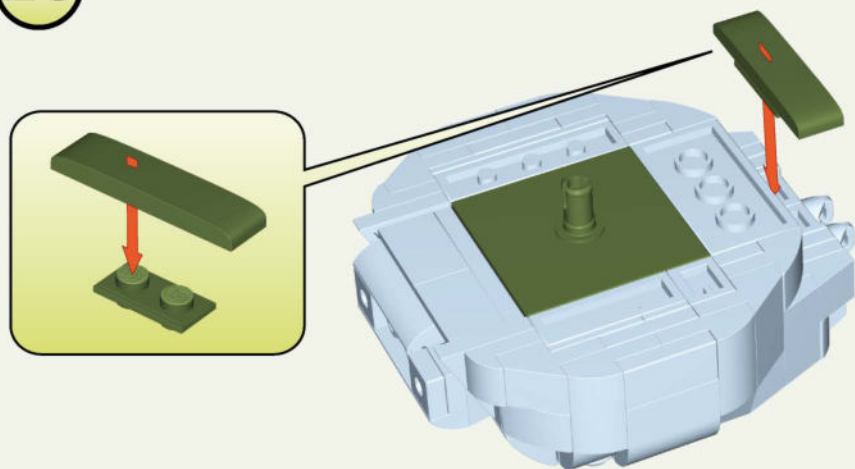

130

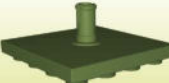



x1

x1

x1

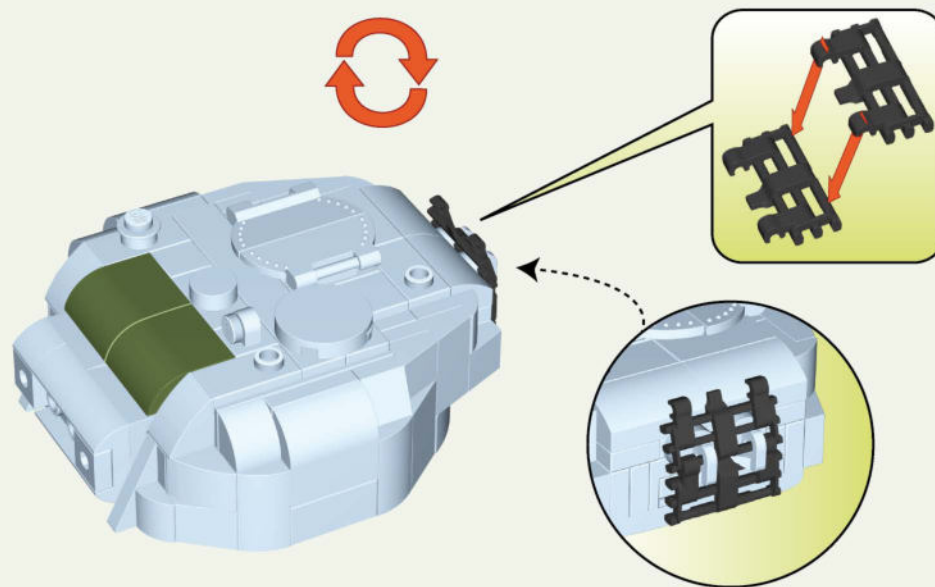
131





x2

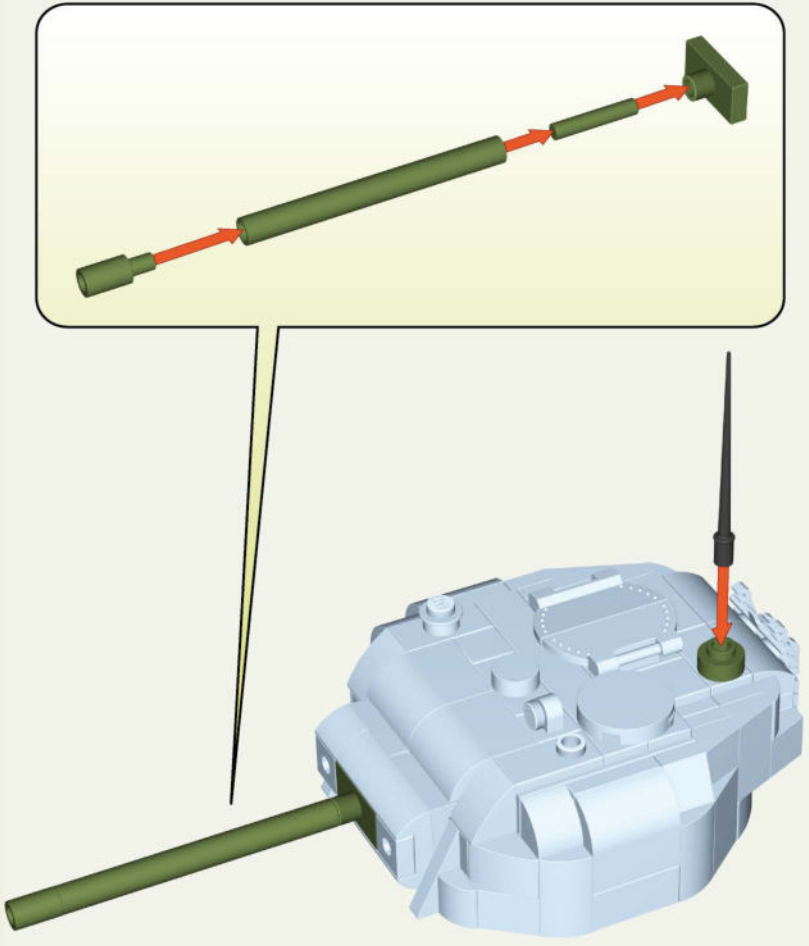

x2

132

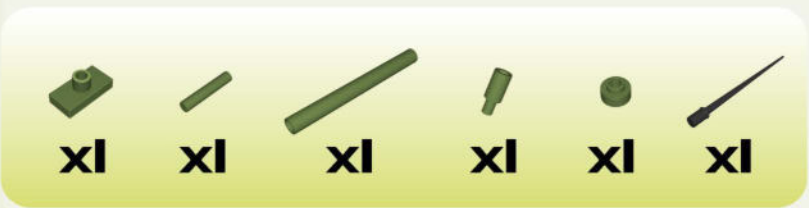

133

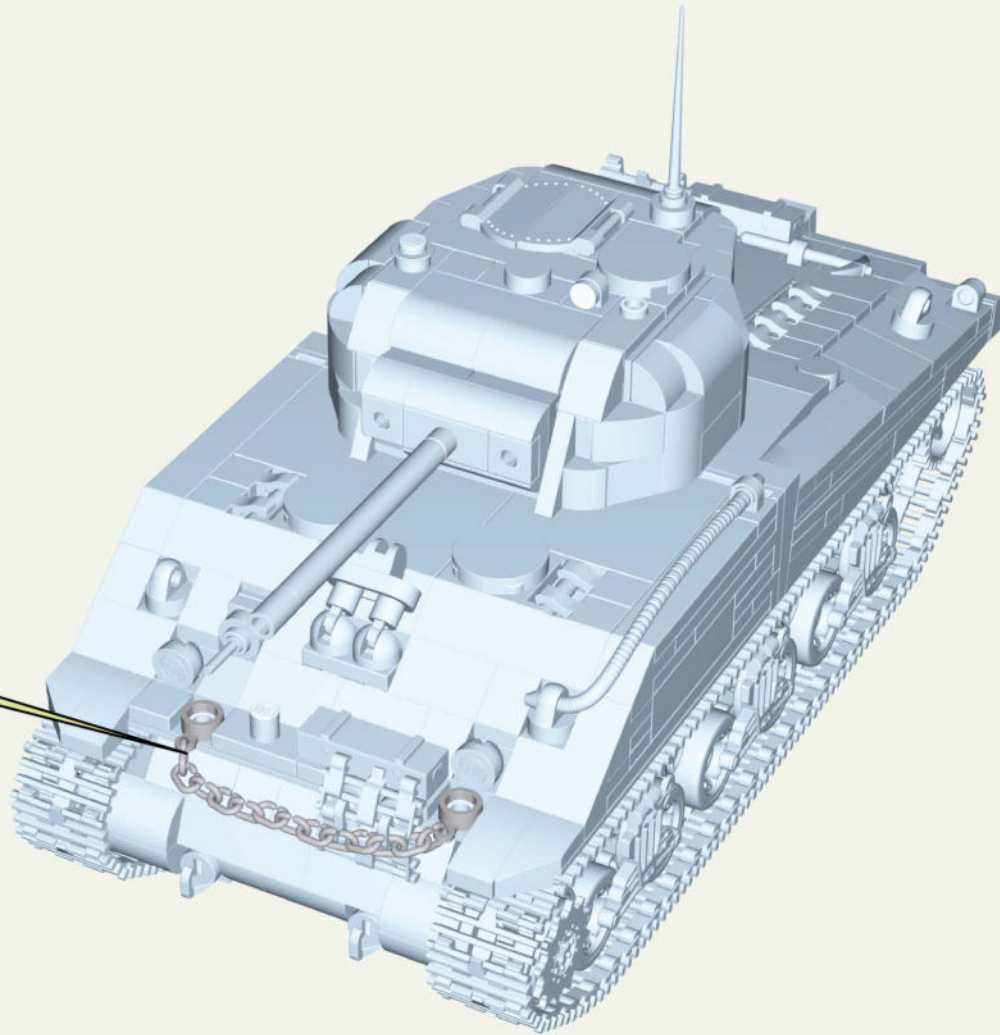
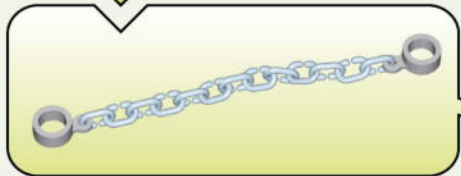
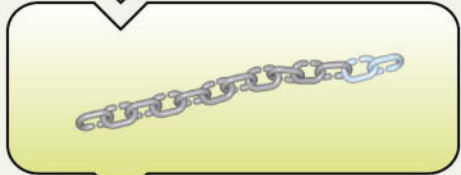





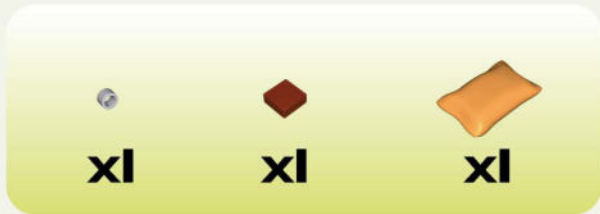
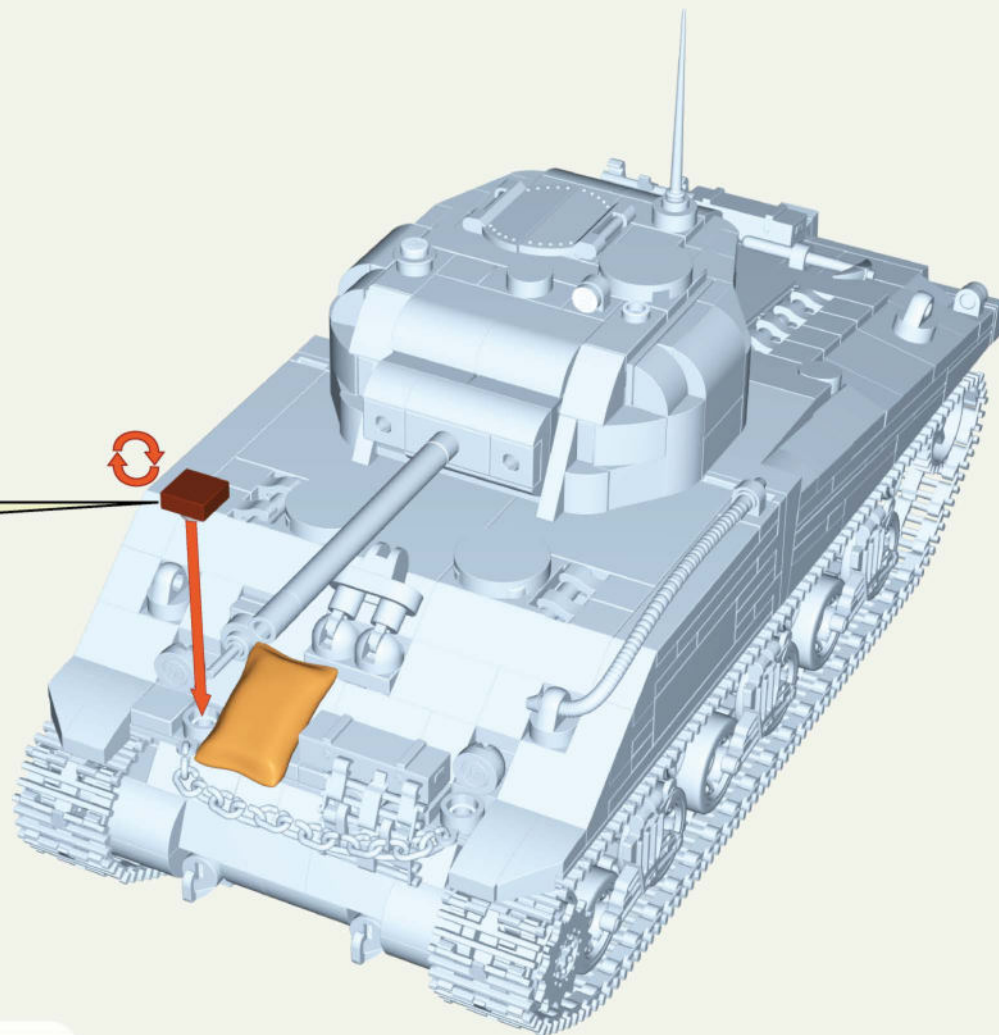
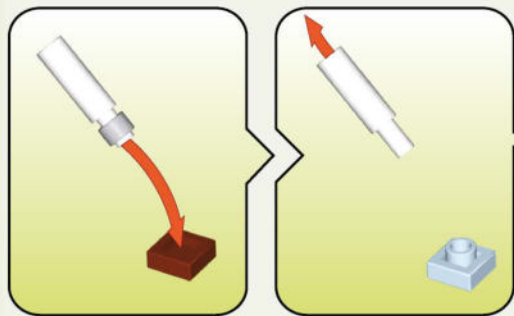

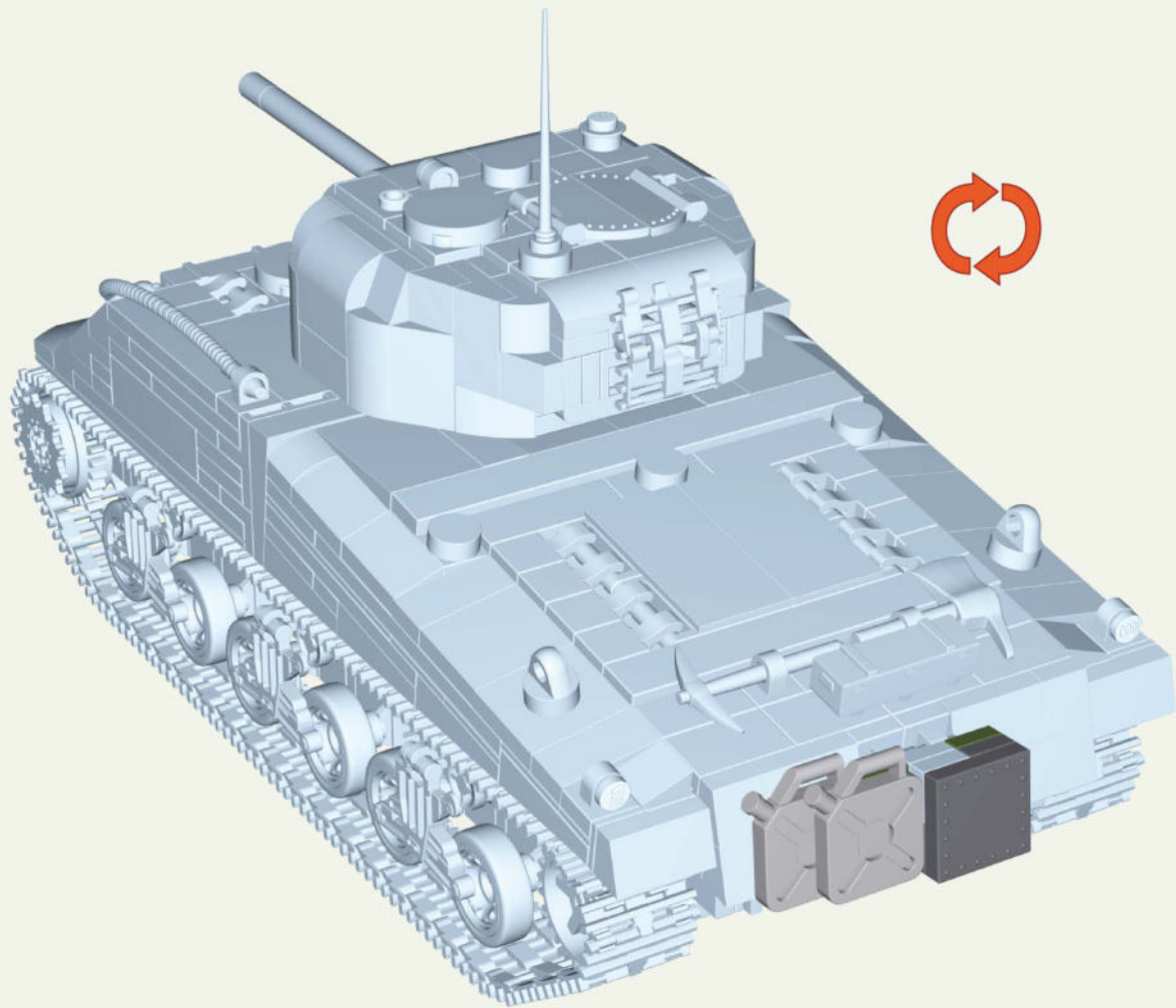
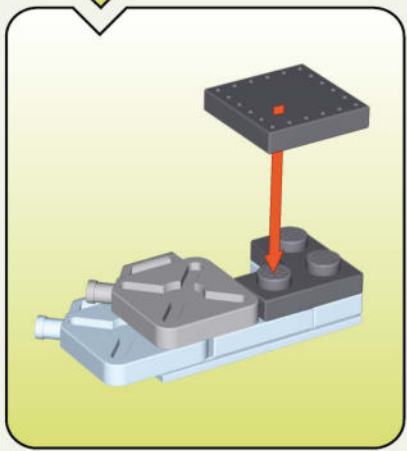
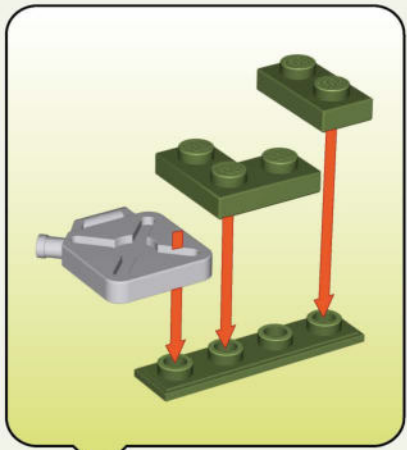

 **x13**  **x2**





-  **x1**
-  **x2**
-  **x1**
-  **x1**
-  **x1**
-  **x1**

x6 105891	x2 138083	x5 141421	x2 128622	x8 128623	x28 44014	x1 54631	x4 97241	x1 101911	x2 43795	x13 132985	x5 105092
x3 147889	x1 105094	x1 150048	x3 118376	x2 125256	x2 96797	x4 42882	x4 96758	x2 143480	x9 121246	x2 118380	x2 150044
x6 44879	x4 148971	x5 92239	x2 102460	x6 108318	x8 86091	x2 85894	x1 44169	x10 99232	x2 132984	x16 42931	x2 43671
x1 98135	x1 42922	x1 51555	x3 134976	x8 104956	x1 119440	x1 125205	x6 45540	x2 98244	x3 101912	x2 104428	x3 94039
x2 125376	x3 132329	x1 131780	x2 92369	x1 91424	x18 87333	x9 42952	x3 106342	x4 45647	x2 80005	x1 83632	x1 149961
x1 149962	x1 143654	x1 143657	x2 143521	x4 128968	x3 98140	x1 149914	x1 149913	x4 92341	x1 44251	x7 111484	x1 149915
x6 81905	x2 111481	x8 132618	x7 42959	x2 93457	x20 115502	x1 44877	x1 94649	x1 149916	x1 149917	x2 93965	x2 147990
x1 109733	x15 42976	x1 100145	x1 149919	x1 99178	x2 42991	x2 106762	x2 42967	x1 Sherman M4A3 149932	x3 85406	x2 128844	x9 148707
x1 85566	x13 43017	x8 83478	x4 128843	x1 74222	x11 43033	x1 74372	x8 43024	x14 43084	x1 51597	x1 43685	x2 44686
x9 43100	x1 53201	x1 149922	x1 149920	x1 149921	x6 80920	x8 111485	x1 150046	x1 150047	x4 77515	x2 75779	x1 111105
x2 97401	x2 80006	x2 133187	x1 43075	x4 62886	x6 121252	x2 67979	x7 43154	x2 45648	x2 43137	x8 60501	x1 140307



2570 M4A3 SHERMAN

TABLE POINT ★

1.		24 cm	11.		4
2.		10 cm	12.		3
3.		-5 cm	13.		2
4.		-5 cm	14.		4
5.		+10 cm	15.		3
6.		3-6	16.		2
7.		5-6	17.		1
8.		12	18.		5
9.		2+	19.		90
10.		8	20.		Available 1943

2570



SHERMAN M4A1
SCALE 1:48
★ 2715



PzKpfw VI TIGER "131"
SCALE 1:48
+ 2710



HISTORICAL COLLECTION

WWW.COBIGAMES.COM

N4A3 SHERMAN



CHURCHILL MK. IV
SCALE 1:48
🇬🇧 2717



PANZER II AUSF. A
SCALE 1:48
+ 2718



Sd.Kfz.7 HALF-TRACK
+ 2275

WWW.COBI.EU

For news and special deals

Find us on:
f cobr.bricks
i cobr.klocki
y COBI SA

01-02570-830