

HISTORICAL COLLECTION

WORLD WAR II



PANZERKAMPFWAGEN E-100

PLACE OF ORIGIN - GERMANY
 TYPE - SUPER-HEAVY TANK
 STATUS - PROTOTYPE
 WEIGHT - 123t (271 200lb)
 ARMOUR - 200mm (7.87") AT THE FRONT
 ARMAMENT - 1x 15cm (5.9") KwK L/37 GUN,
 1x 7,5cm (2.95") KwK L/24 GUN,
 2x 7,92mm (.312") MG 42
 ENGINE - MAYBACH HL 230 P30 V-12,
 450kw (600hp)
 SPEED - 23km/h (14MPH)
 RANGE - 160km (100mi)
 CREW - 6



2572

PAD PRINTED
NO STICKERS

Printed in EU



WARNING: CHOKING HAZARD-
 Toy contains small parts.
 Not for children under 3 years.

1511 1

PANZERKAMPFWAGEN E-100

SCALE 1:28

BE CAREFUL: NOTICE THE DIFFERENCE

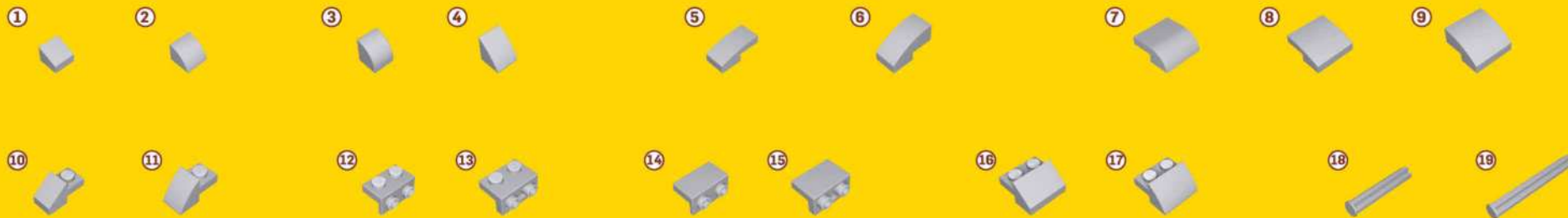

UWAGA: RÓŻNE KLOCKI



1

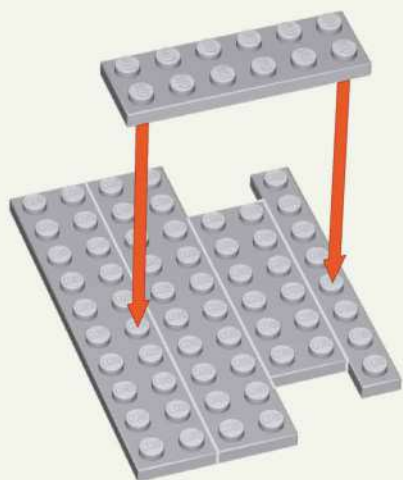

2

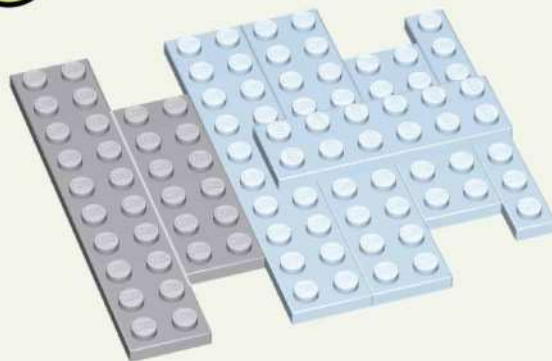

3

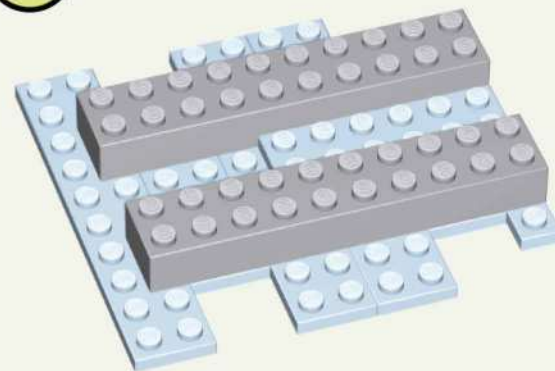

4

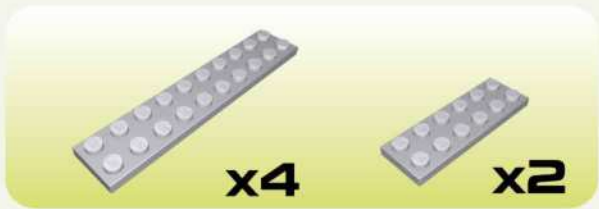

5

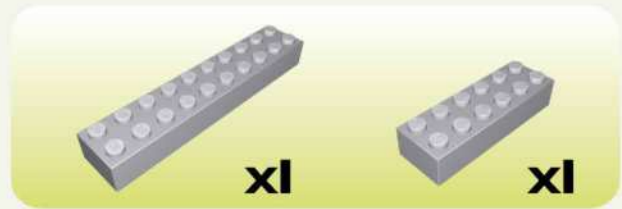
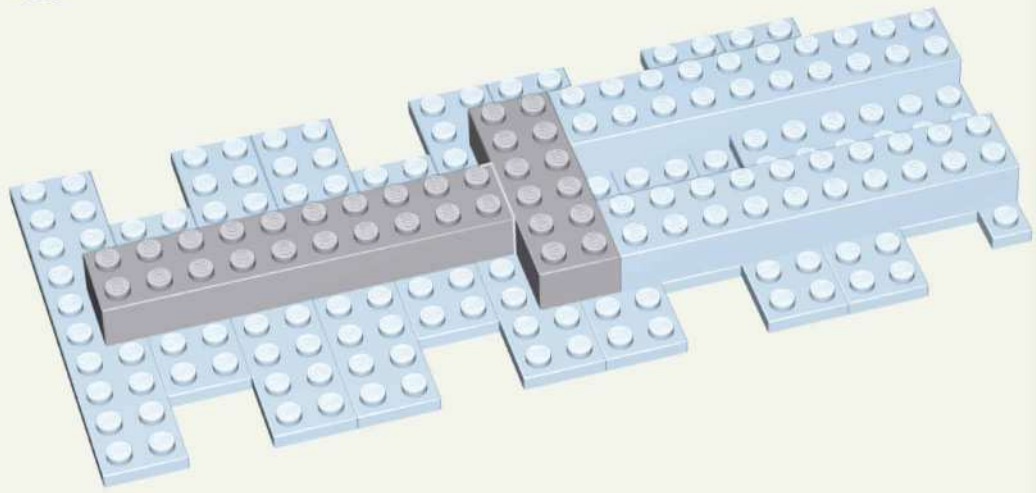

6

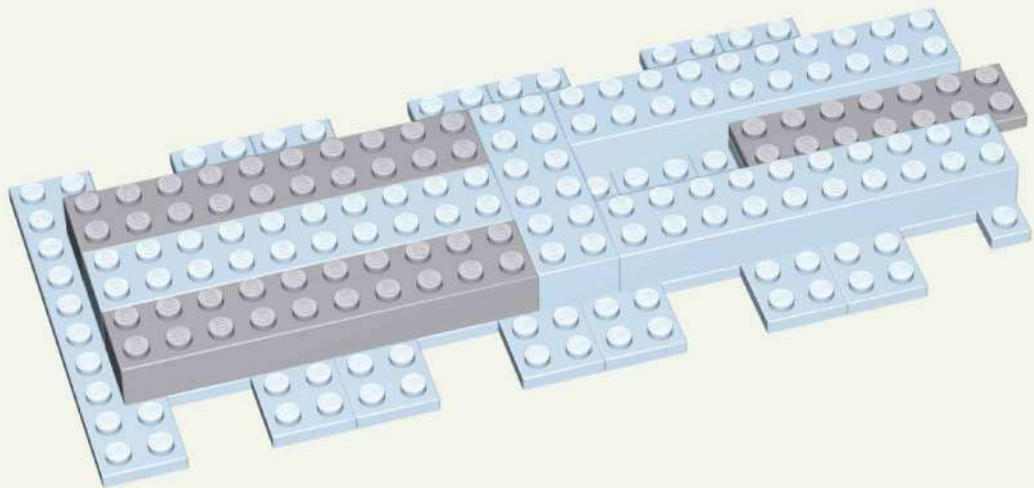

7

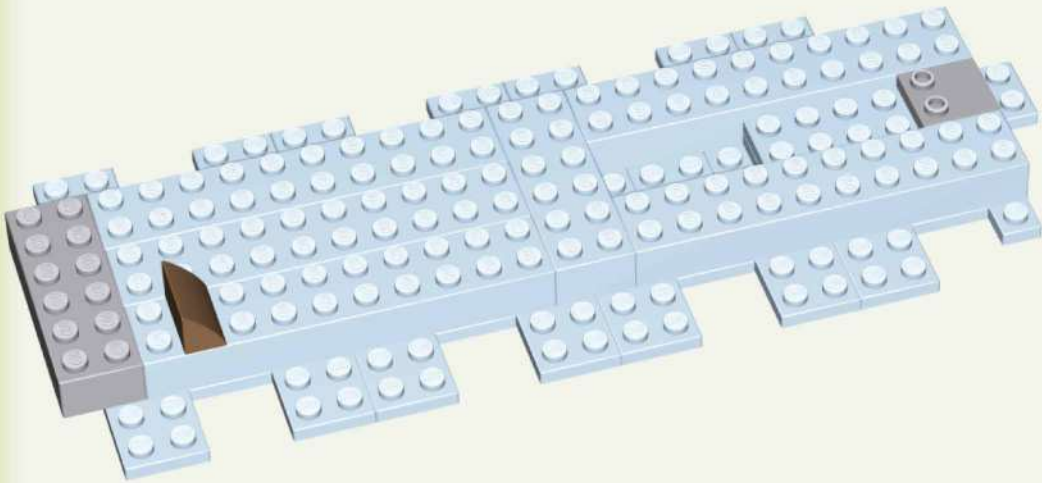

8

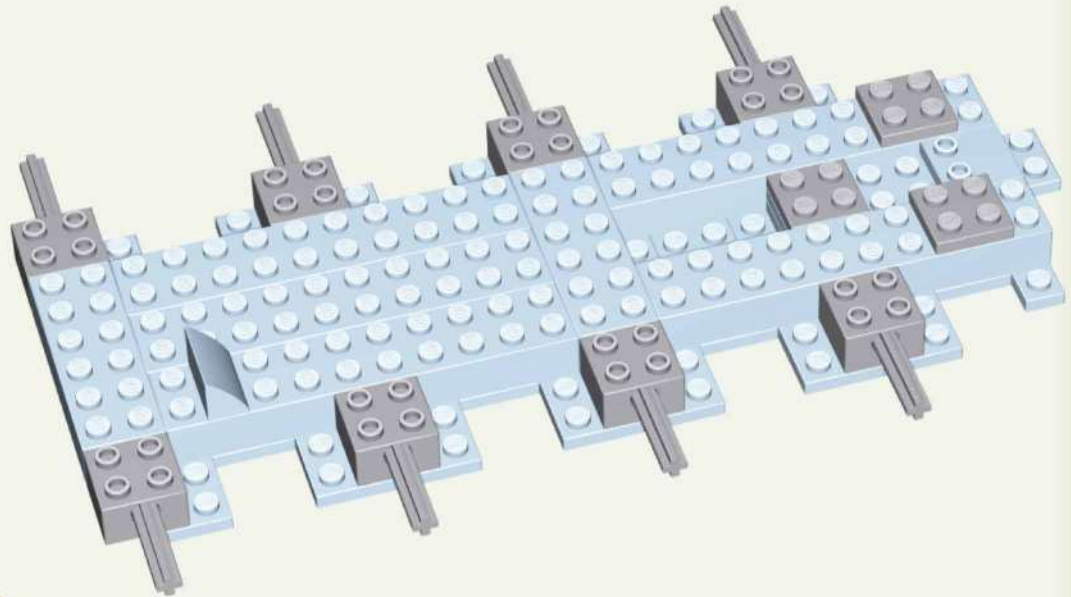
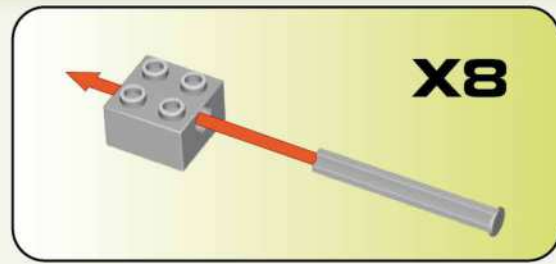

9

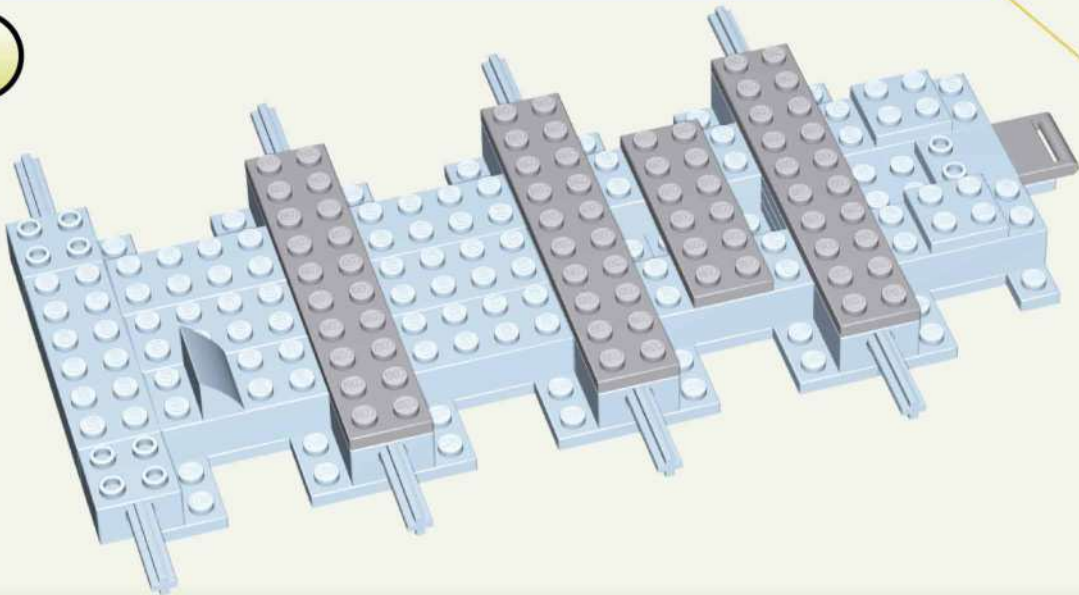

10

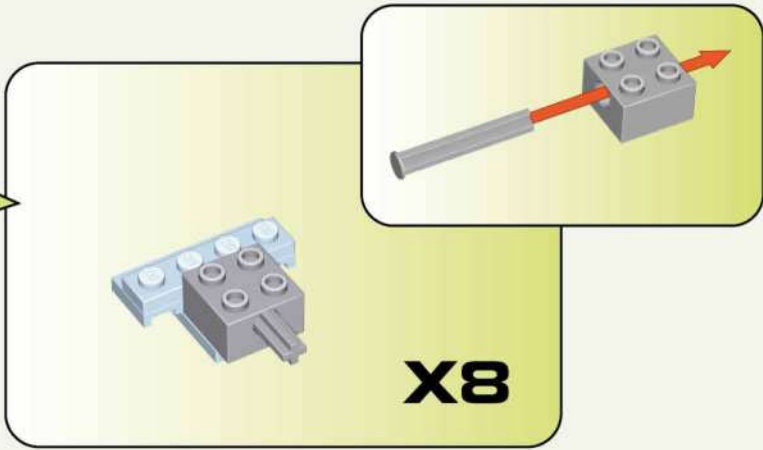
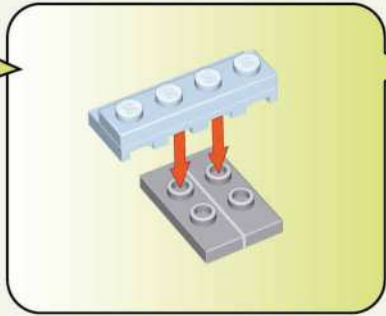
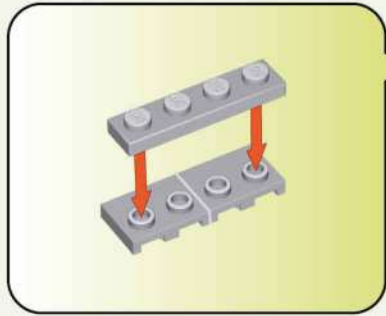

X8



x16



x8



x16



x8



x8

11

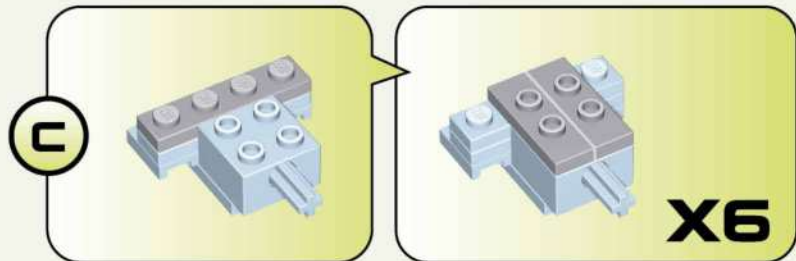
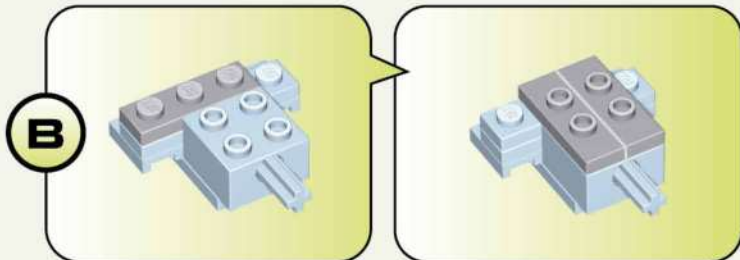
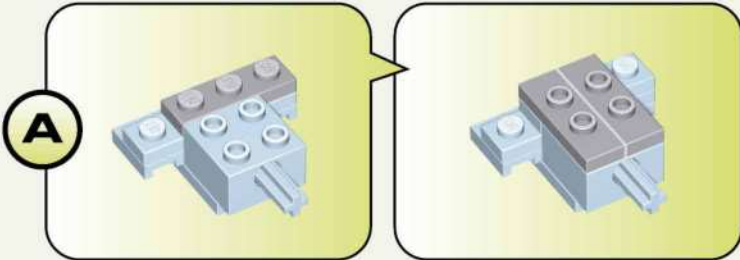

X6



x2

x6

x16

12

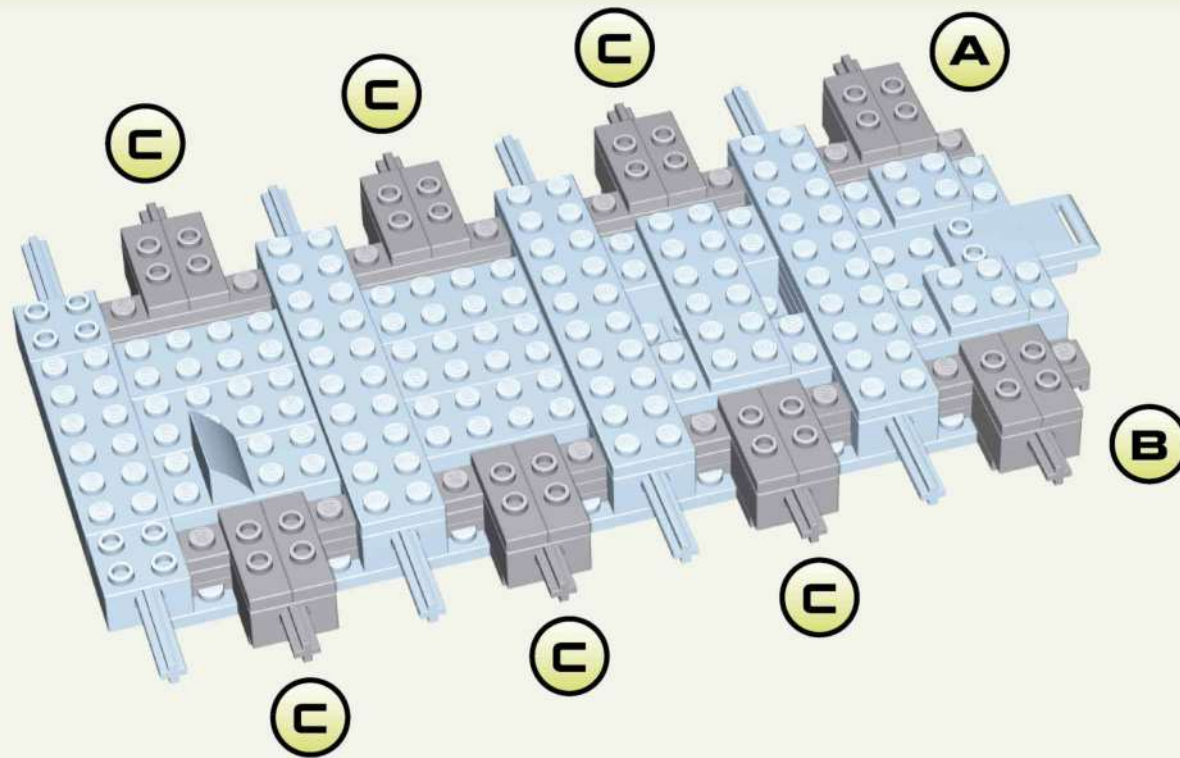

13

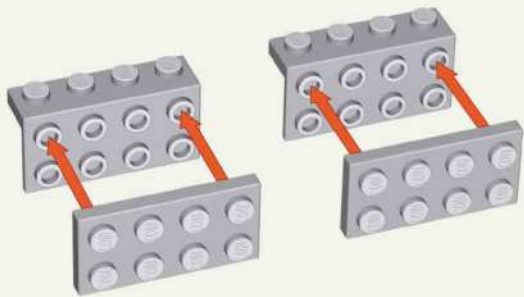

x2



x2

14

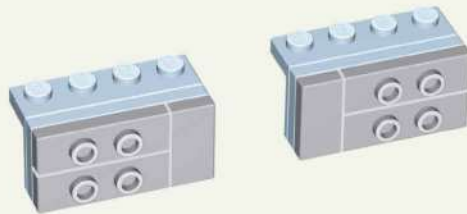

x4

1:1



x2

15

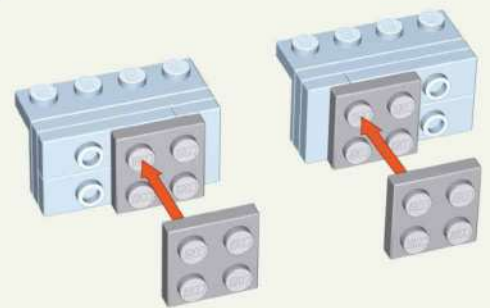

x4

16

x2

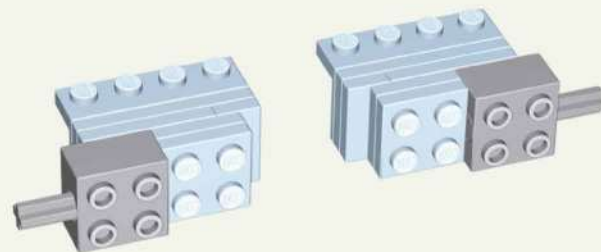
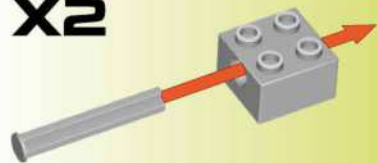

18



x2



x2

17

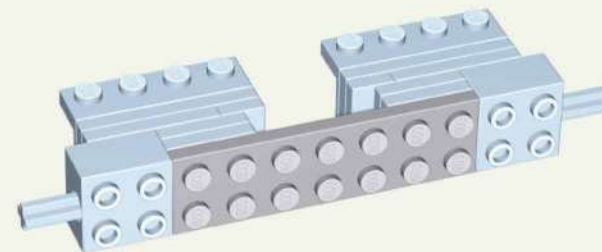

x1

18

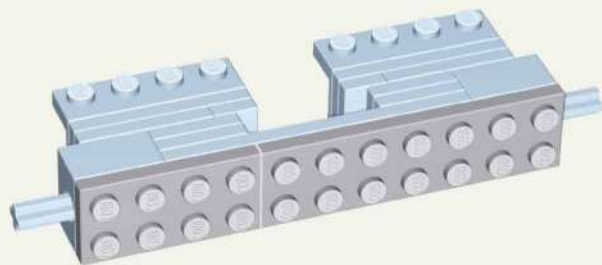

19

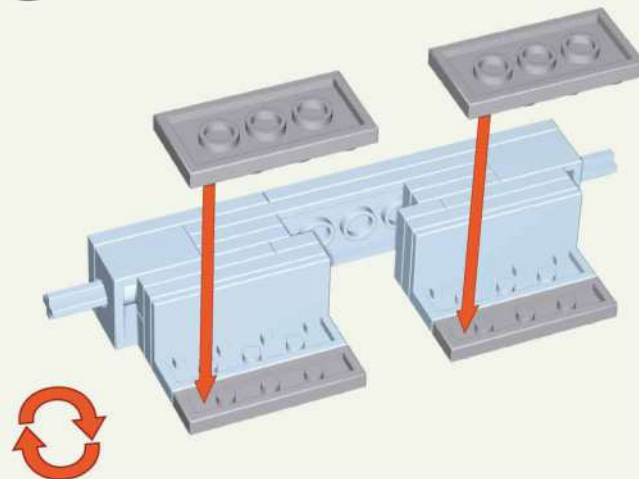

20

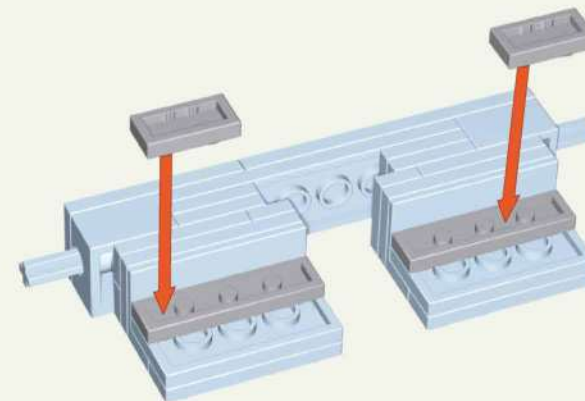

x1



x1



x2



x2



x2



x2

21

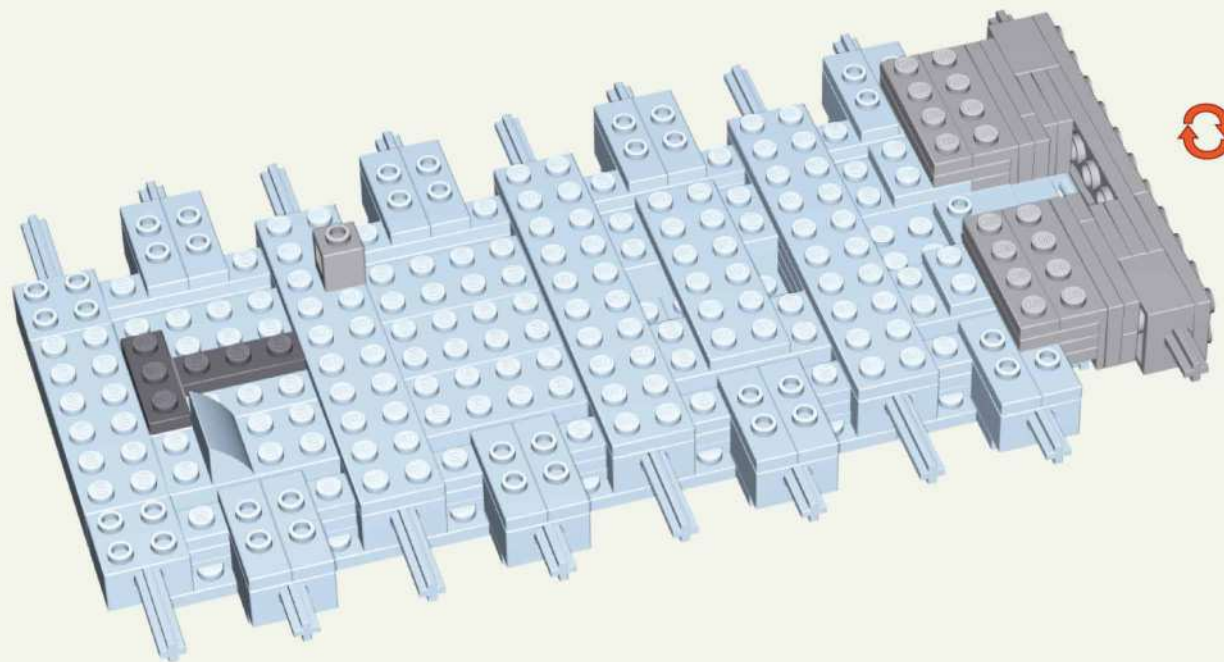

x2



x1

22

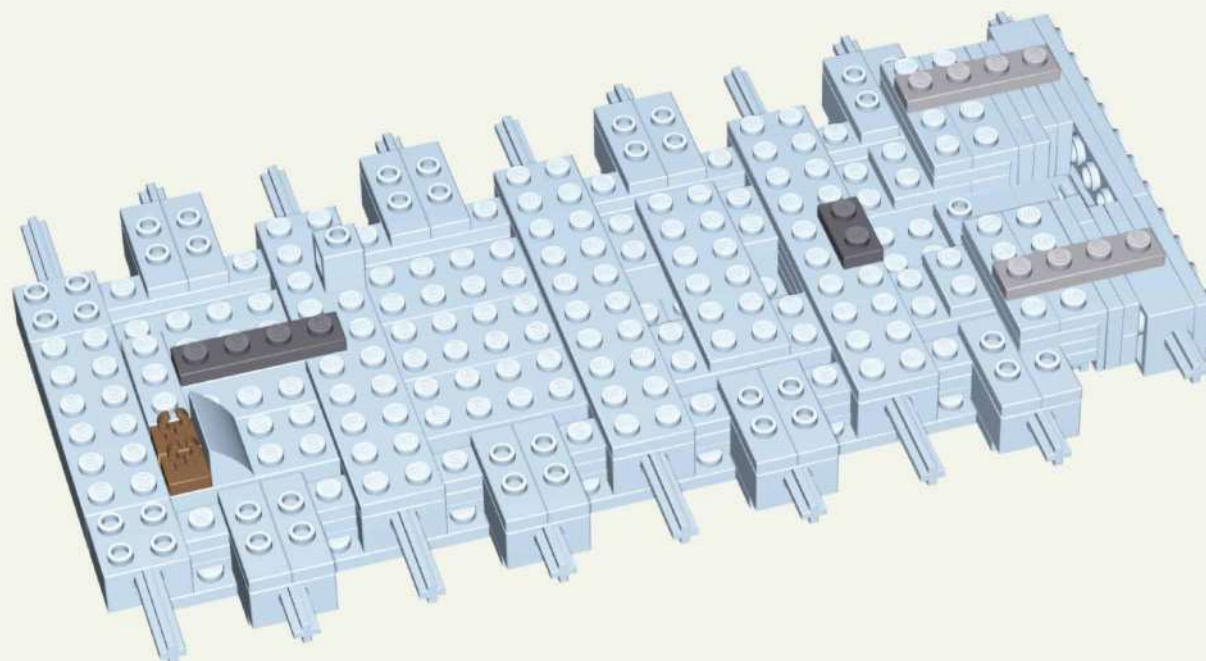

x2



x1



x1



x2

23

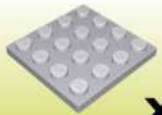
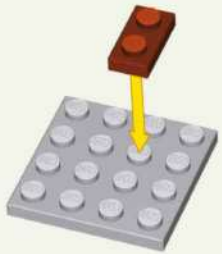

x1



x1

24



x1



x1



x1

25

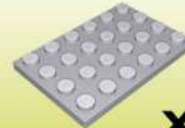
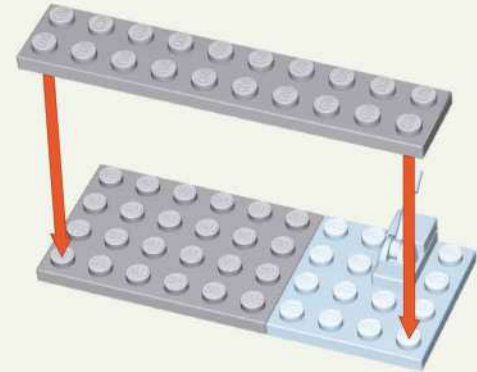

x1



x1

26

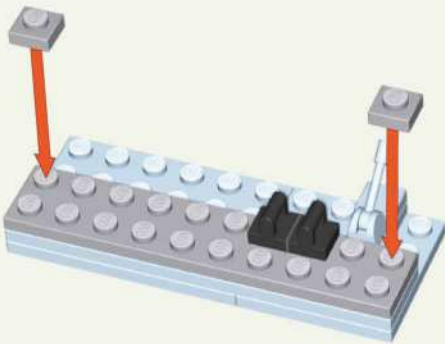

x1



x2



x2

27

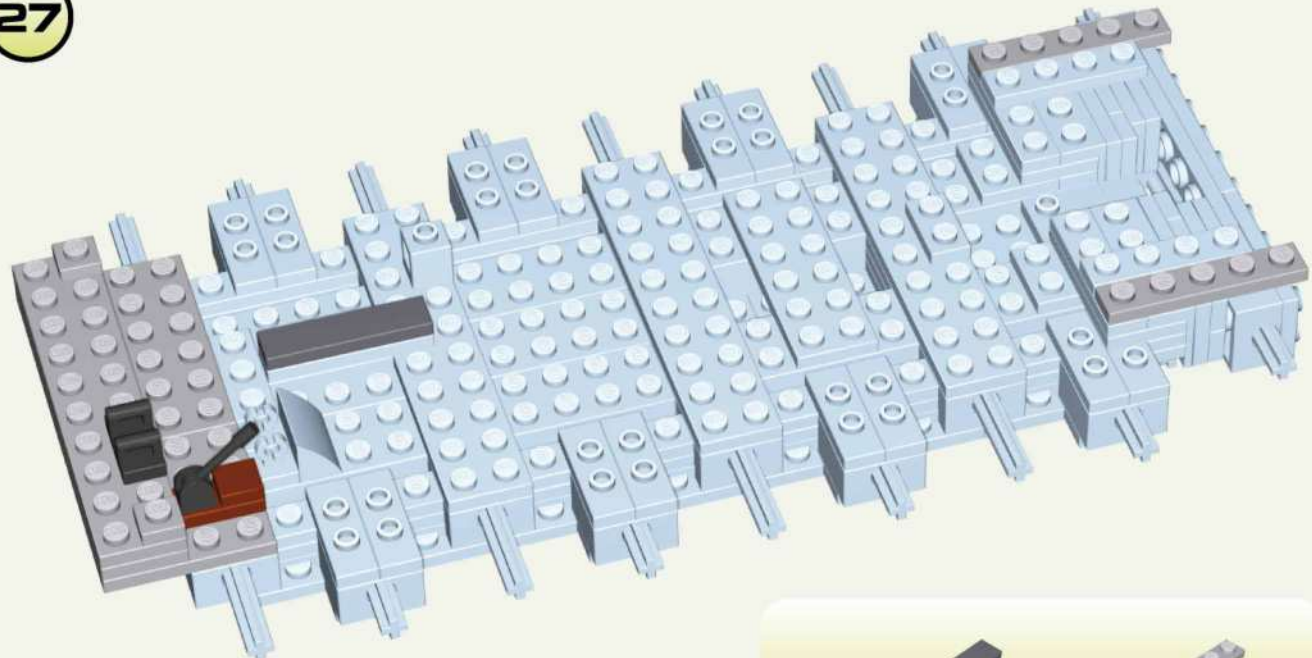

x1



x2

1:1

28

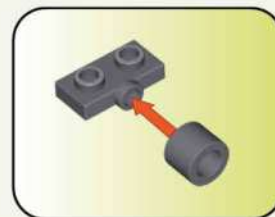
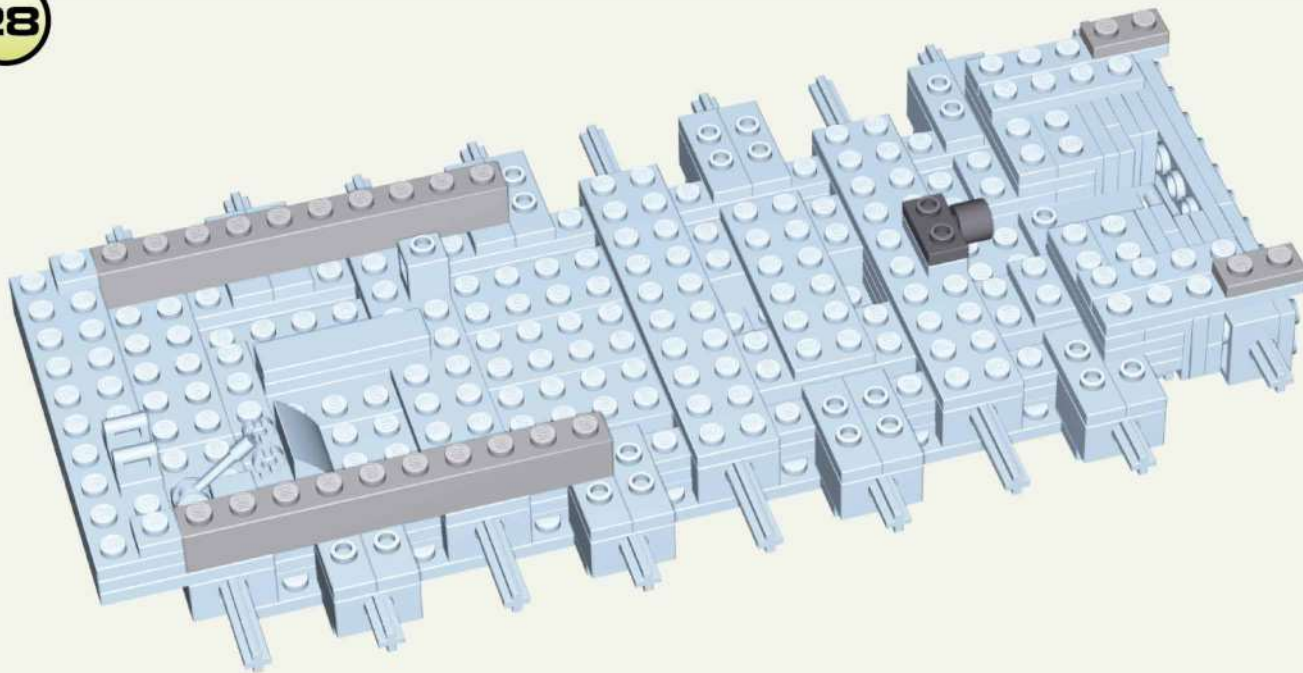

x2



x1



x1



x2

29

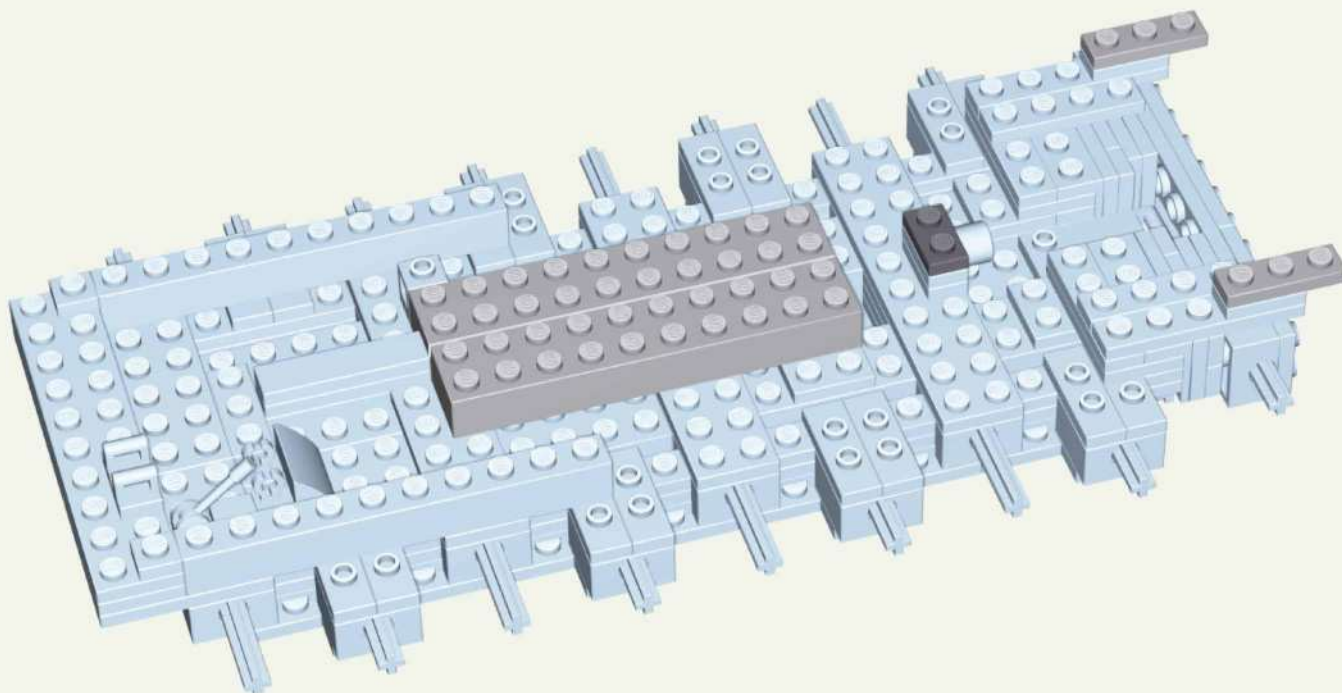

x2



x1



x2

30

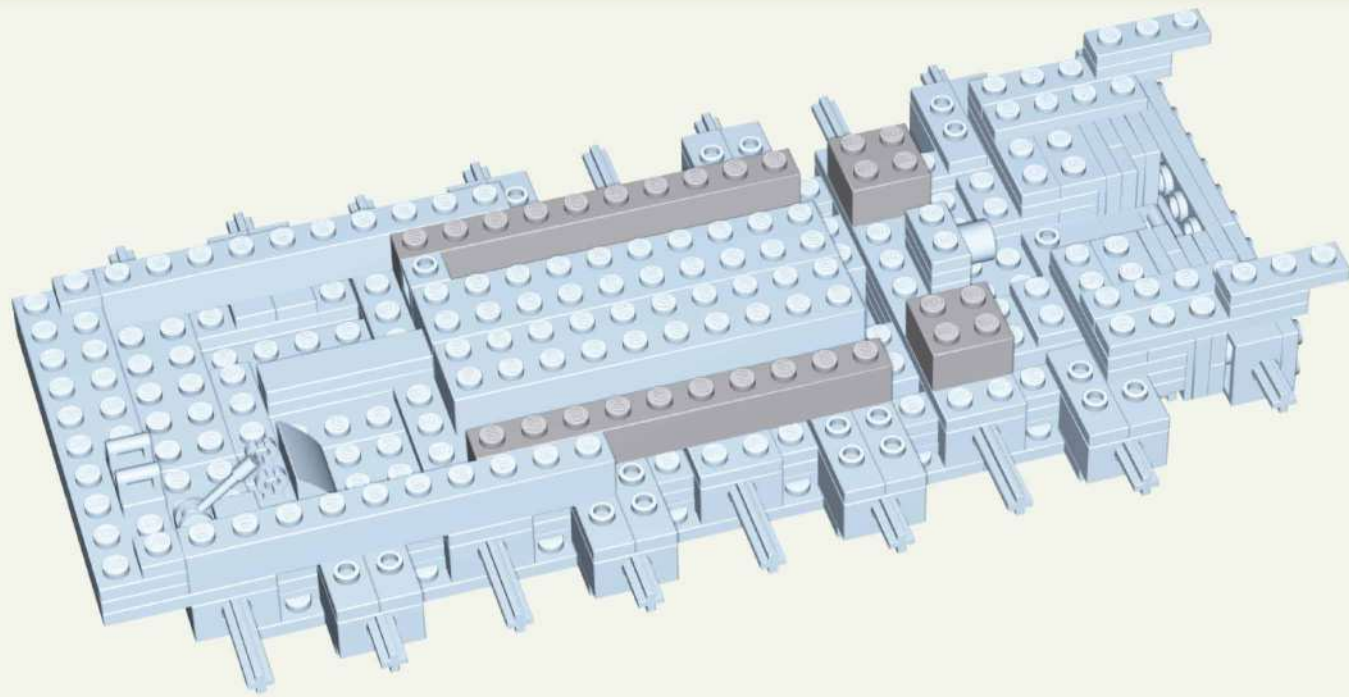

x2



x2

31

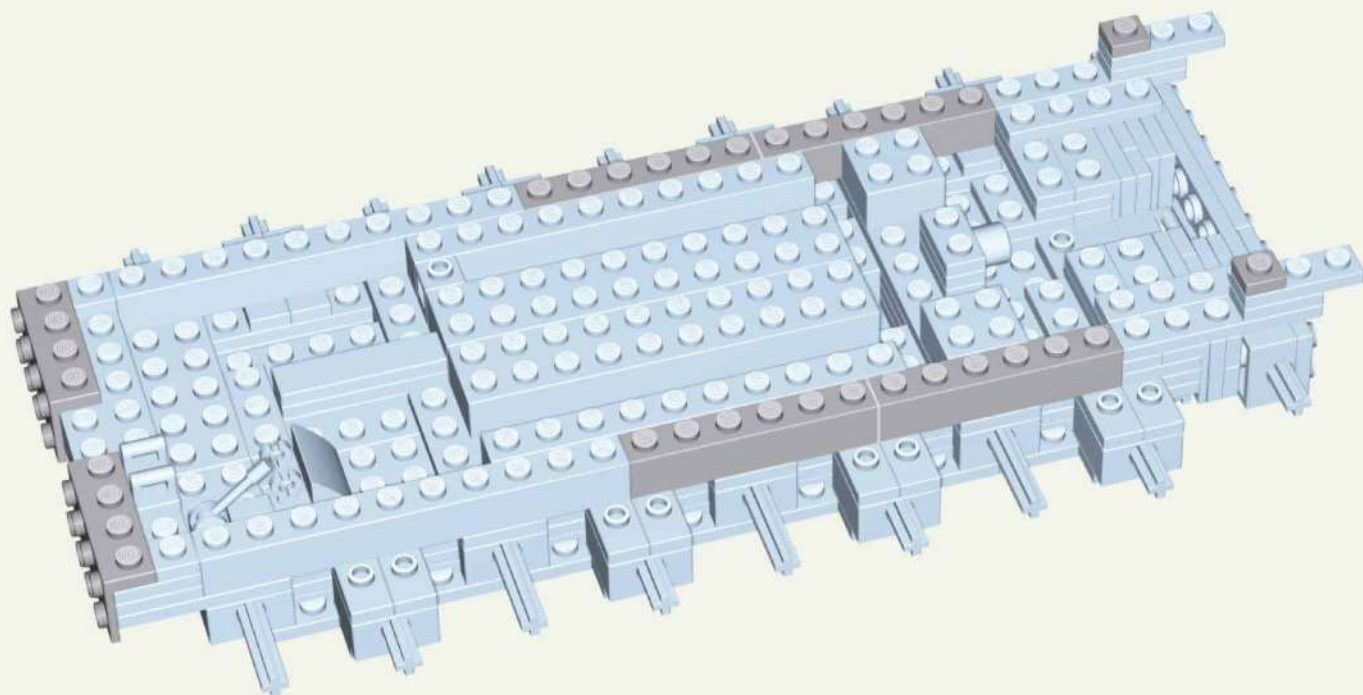

x2



x4



x2

32

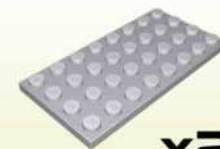
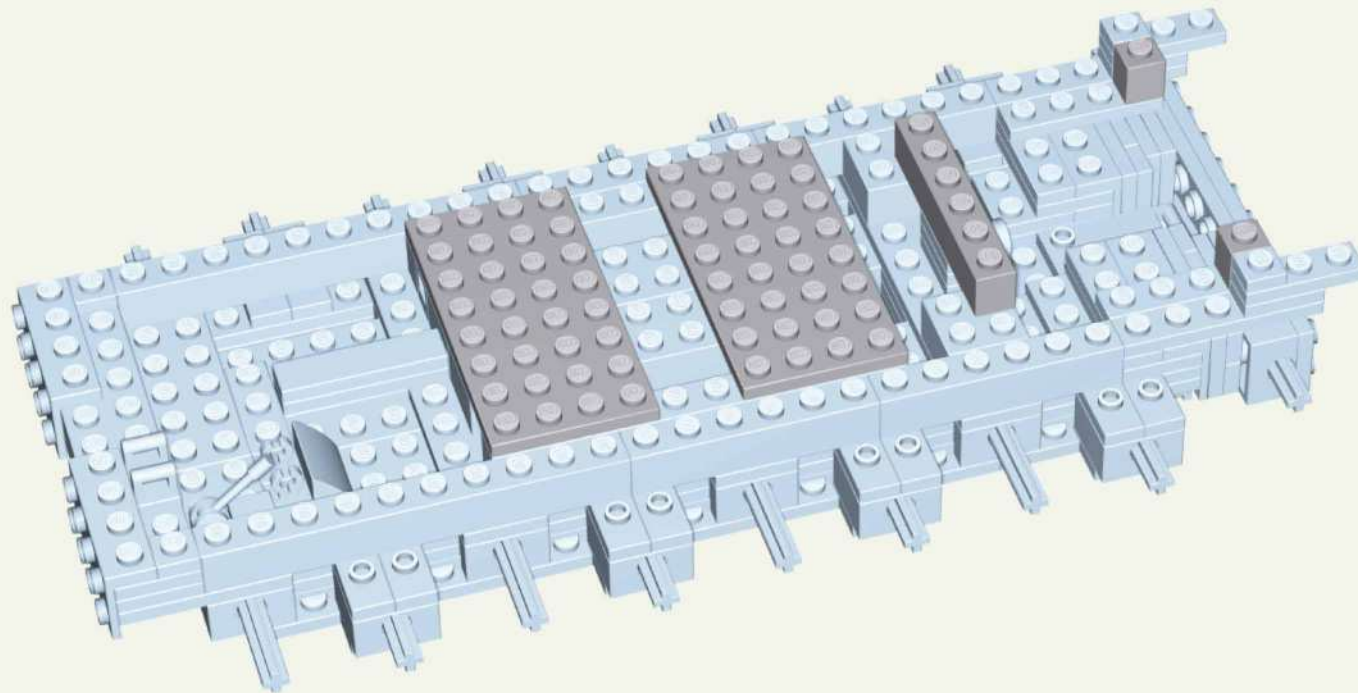

x2

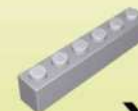

x1



x2

33

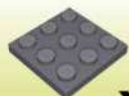

x1



x1

34



x1



x1

35

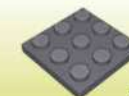

x1



x1

36

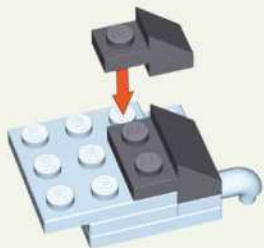

x1

x1

37



x1

x1

x1

38

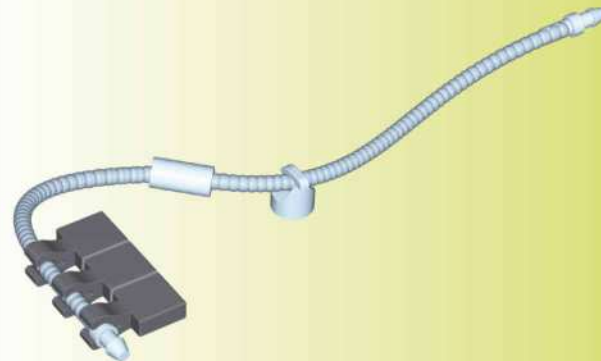
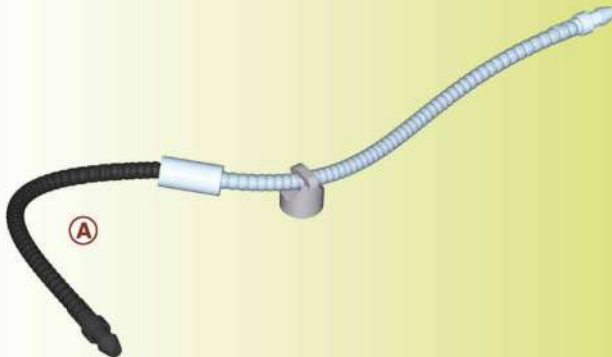
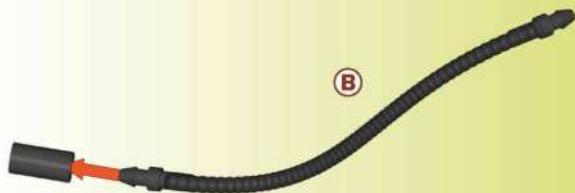

x1

x1

x1

x3

x1

x1

1:1



39

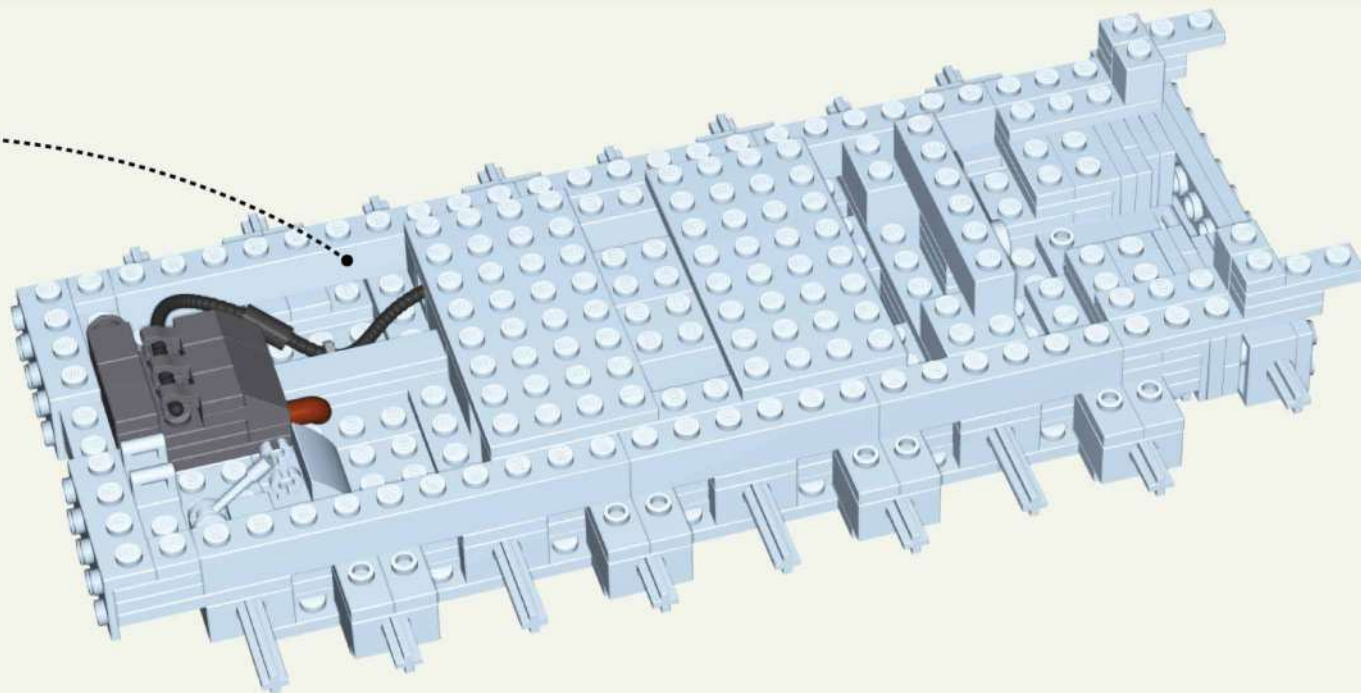
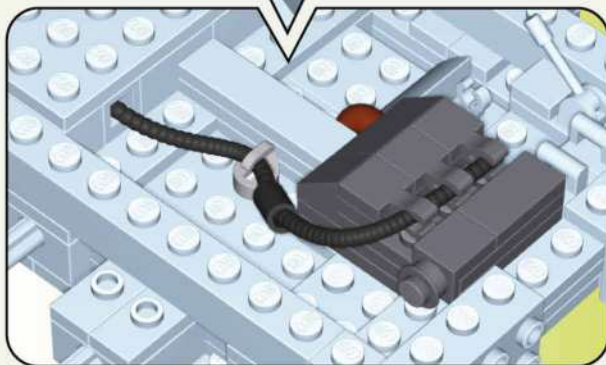
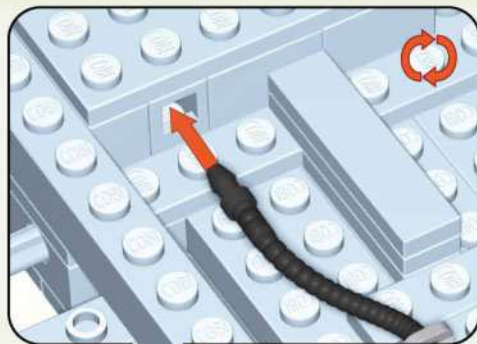

40

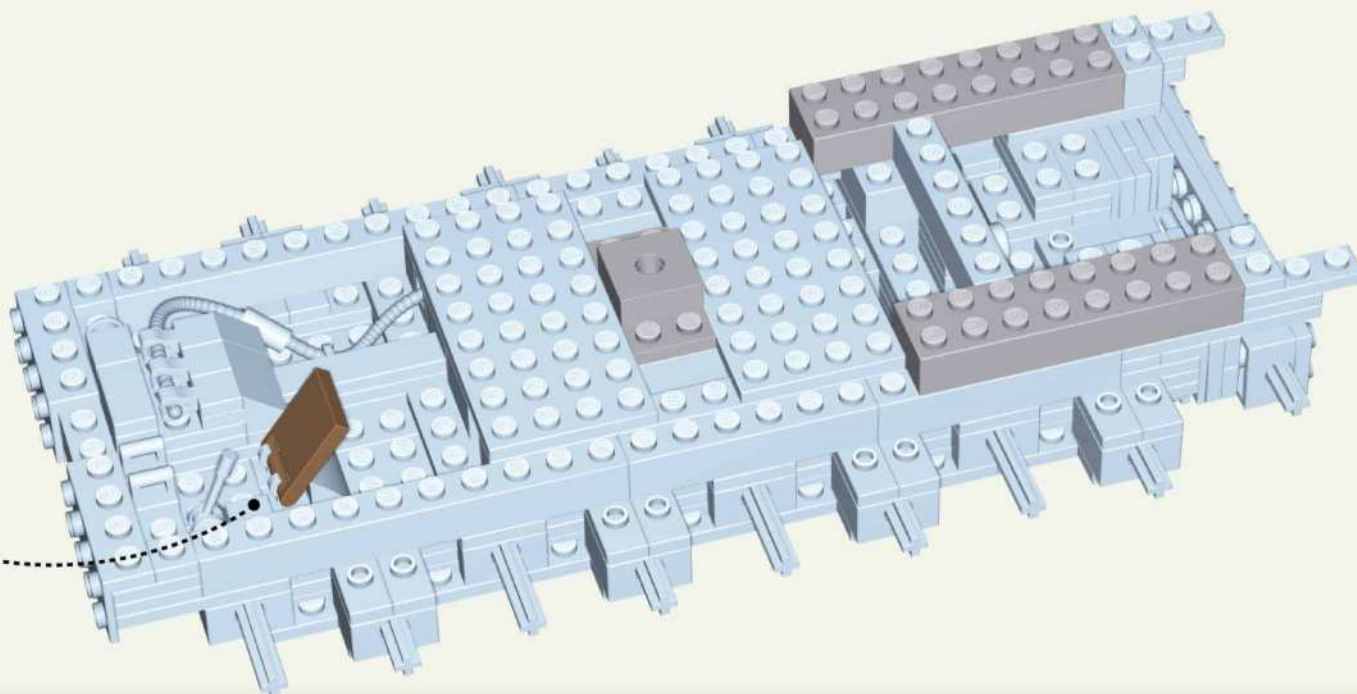

x1



x1



x2

41

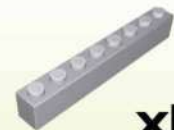
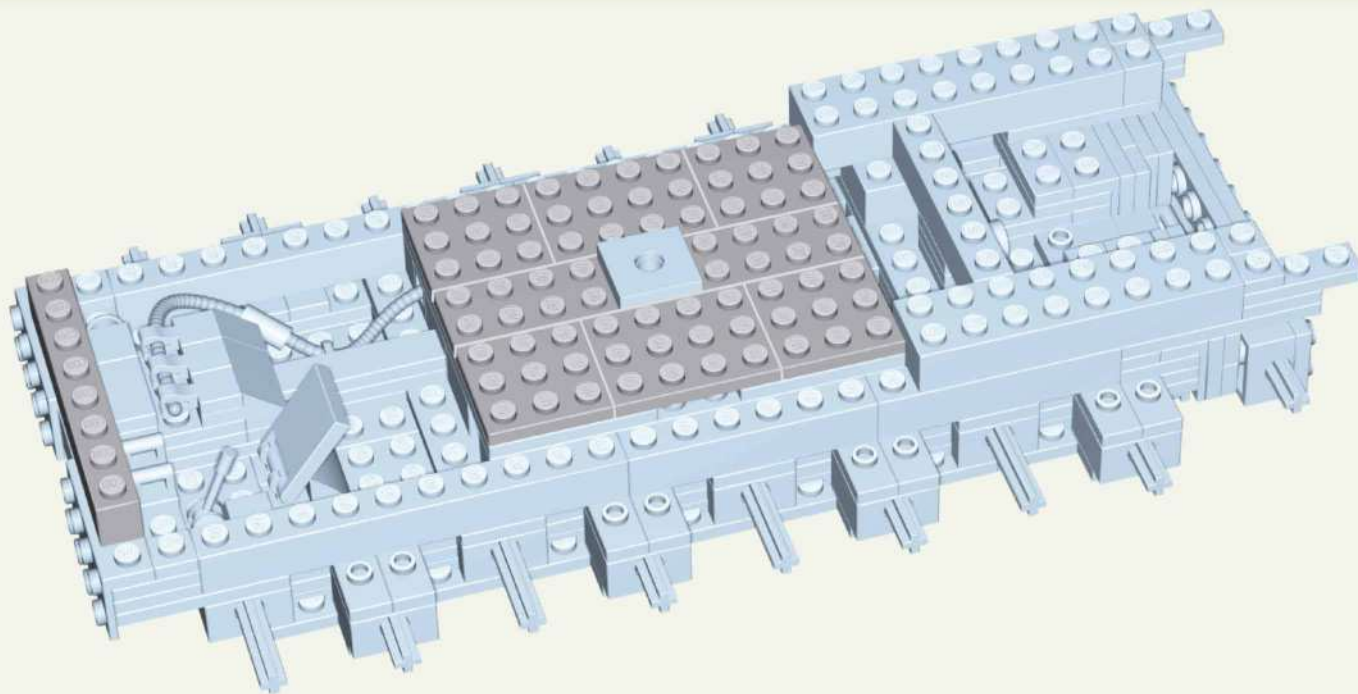

x1



x2



x4



x2

42

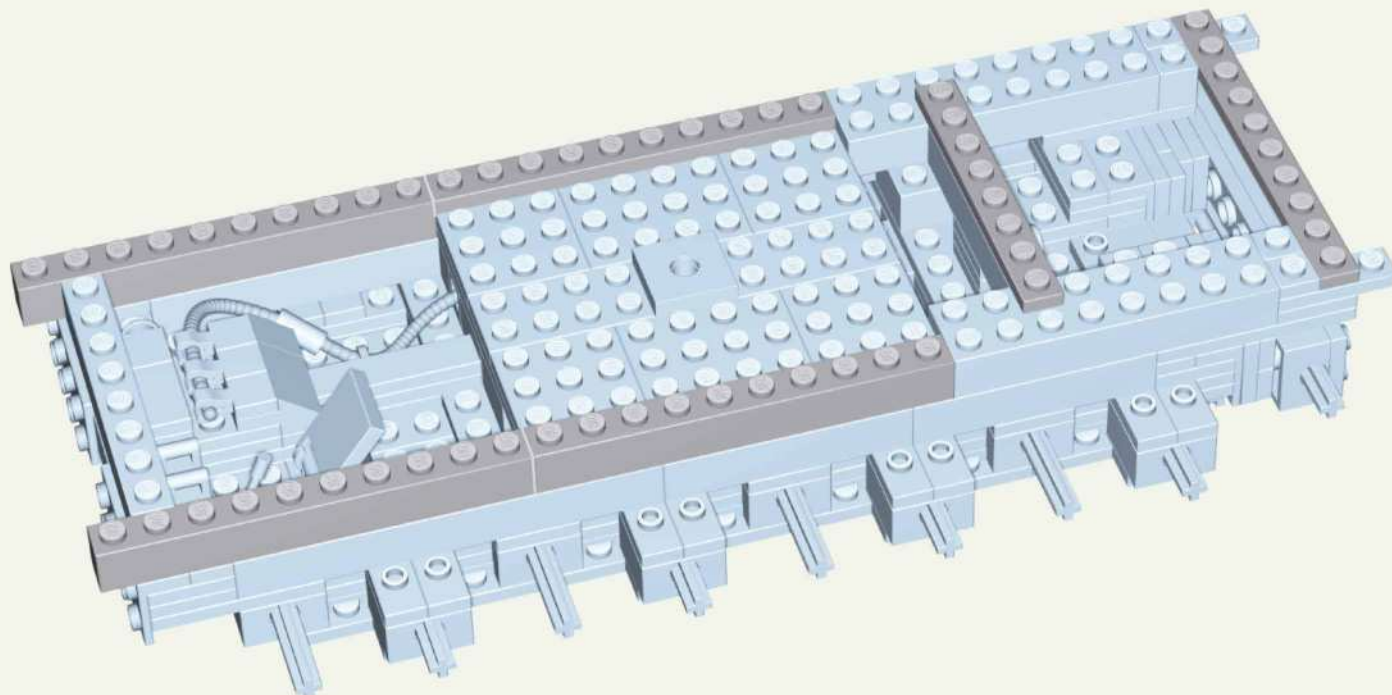

x4





x1

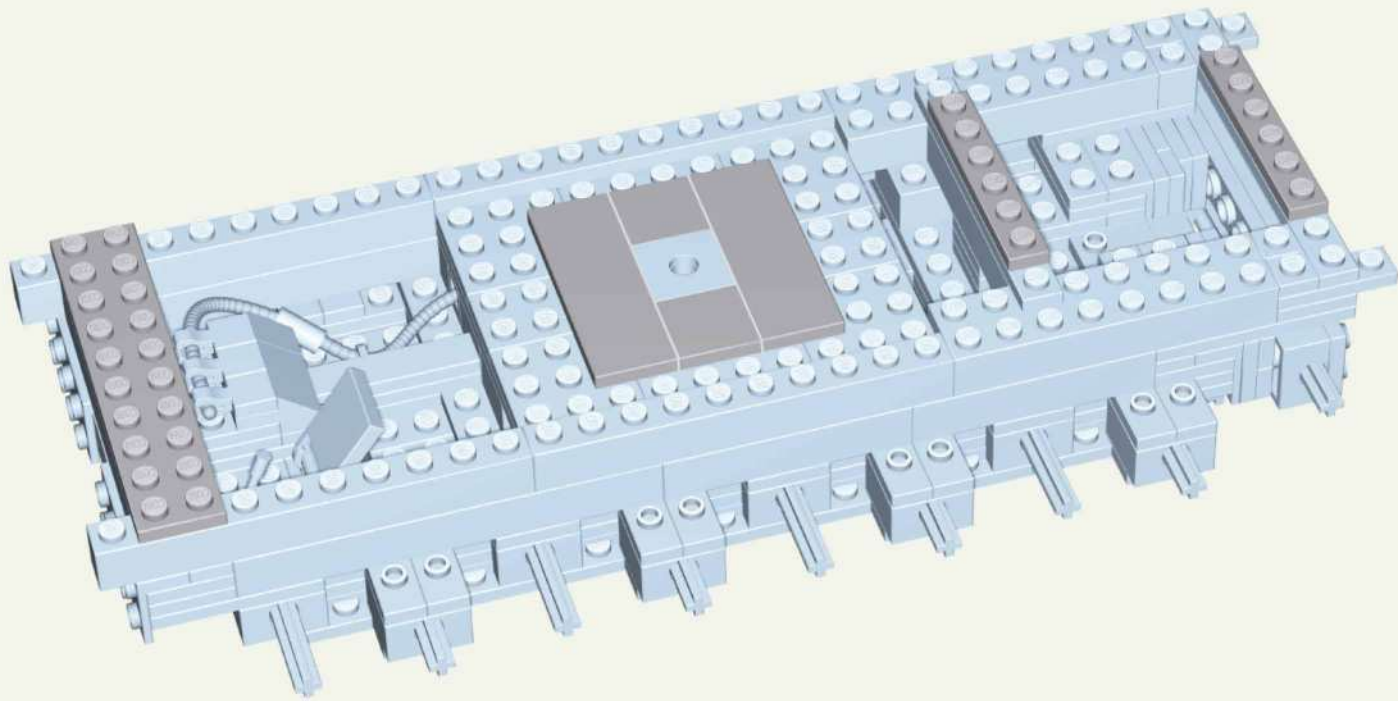

x1

43

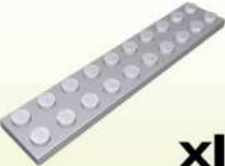
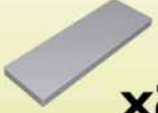

-  x1
-  x2
-  x2
-  x2

44

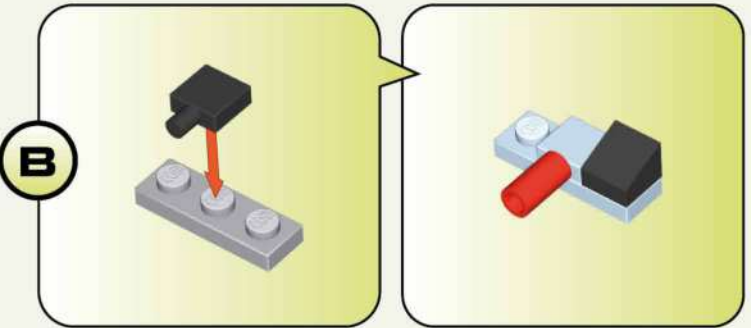
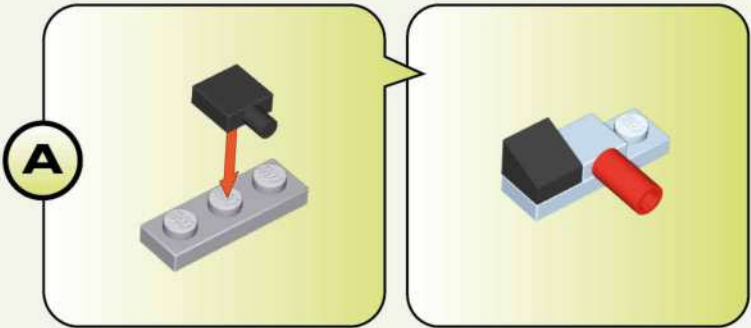

-  x2
-  x2
-  x2
-  x2

45

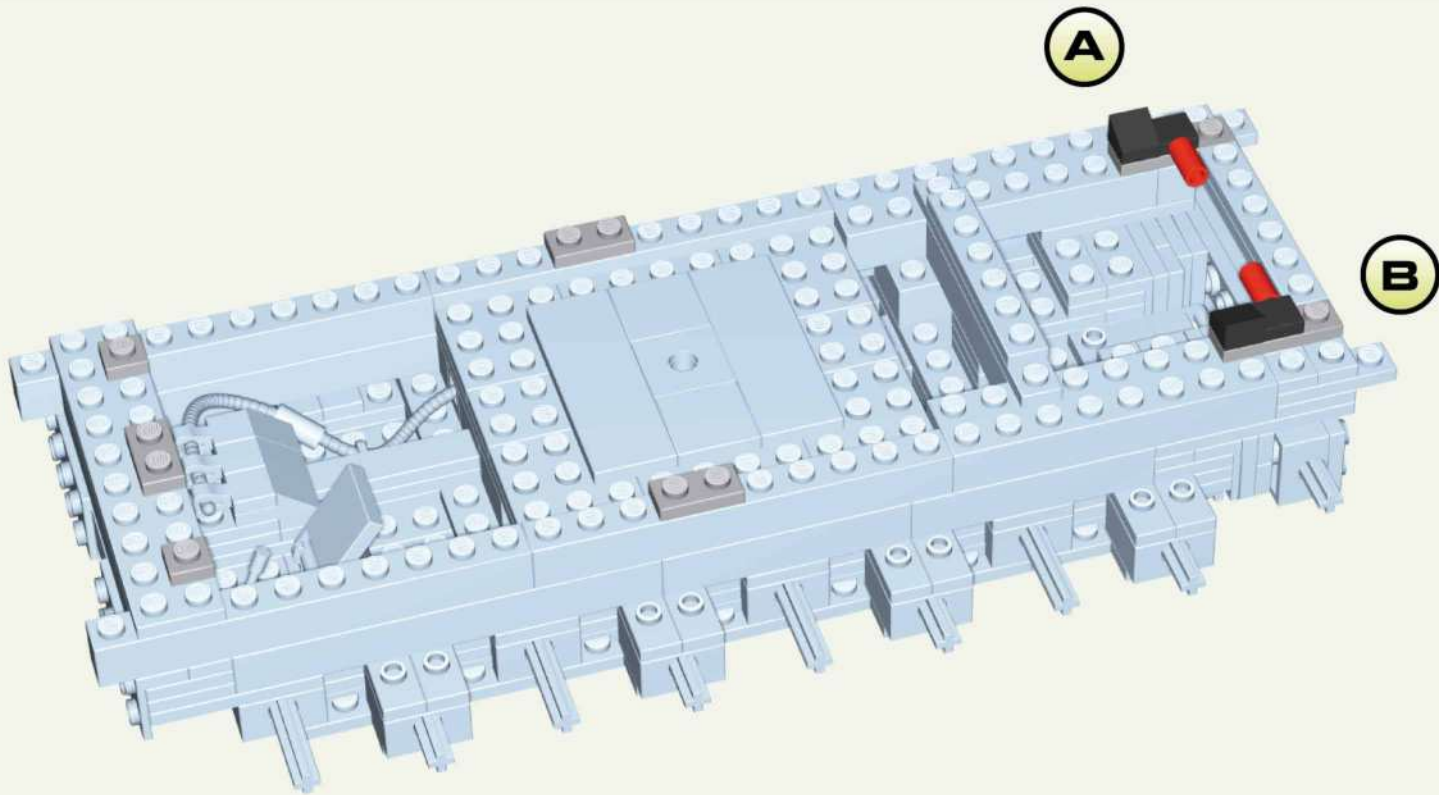

46

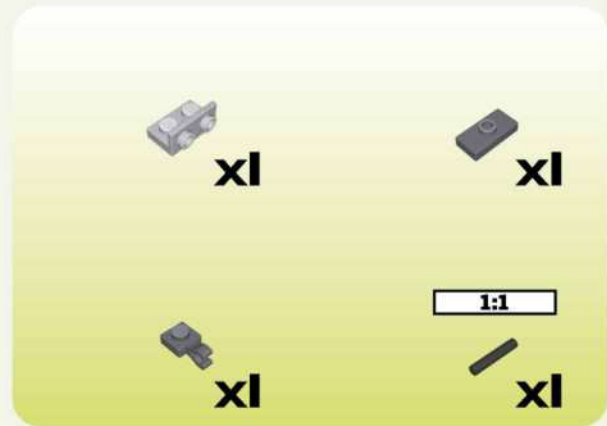
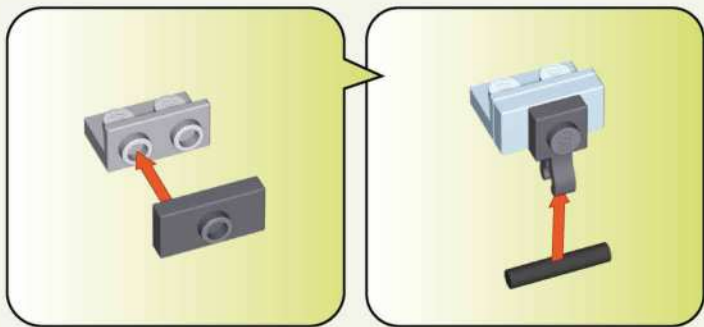

47

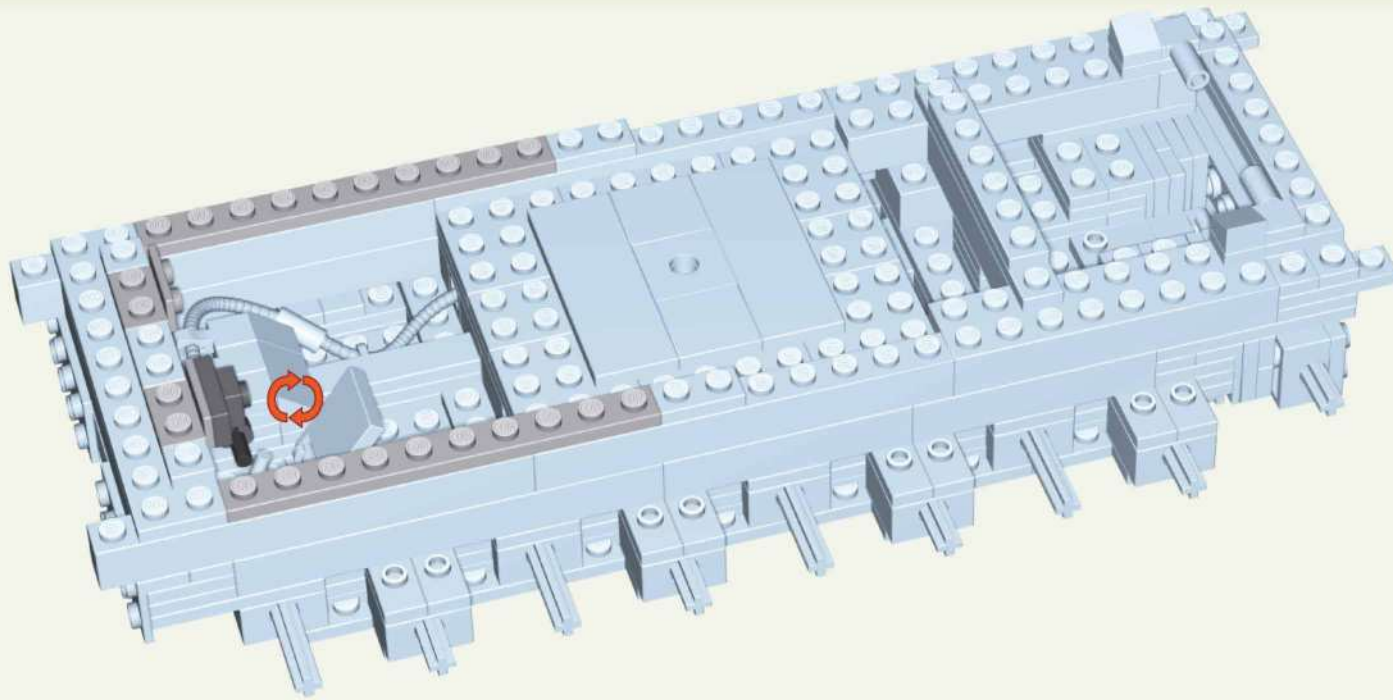

x1



x2

48

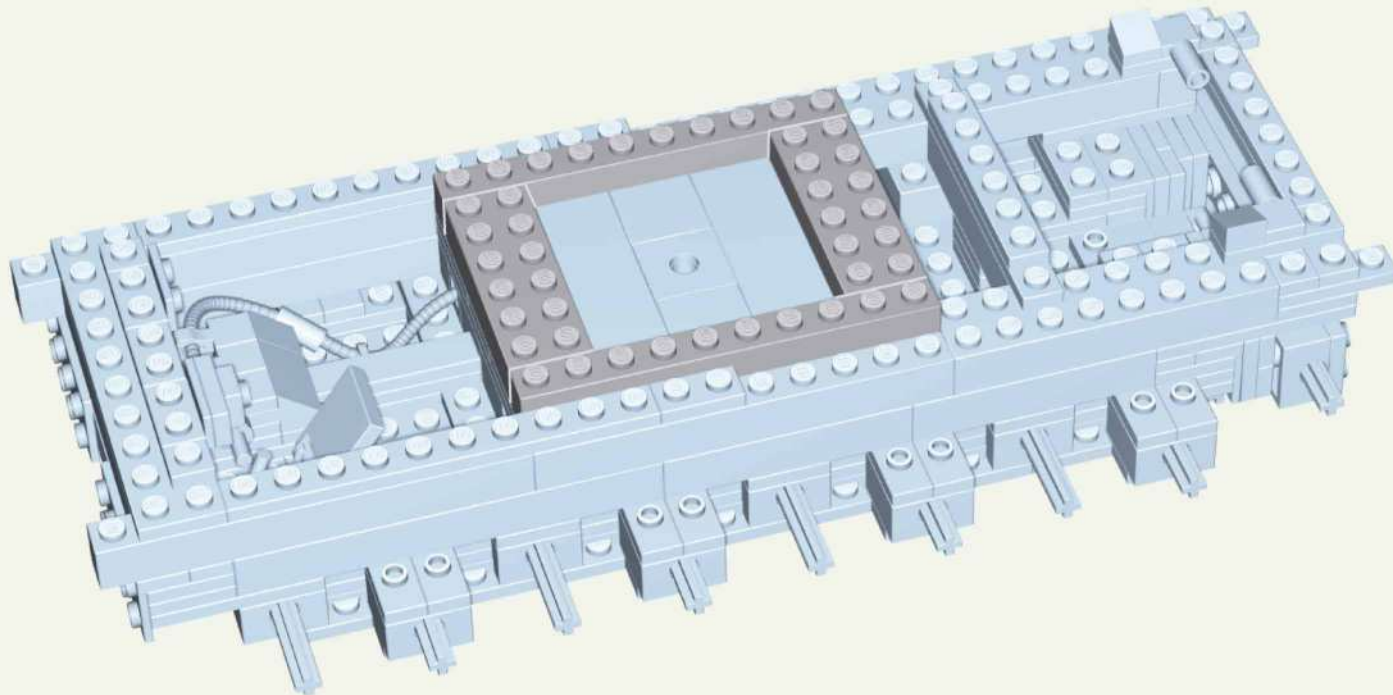

x2



x2

49

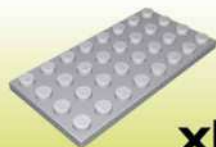
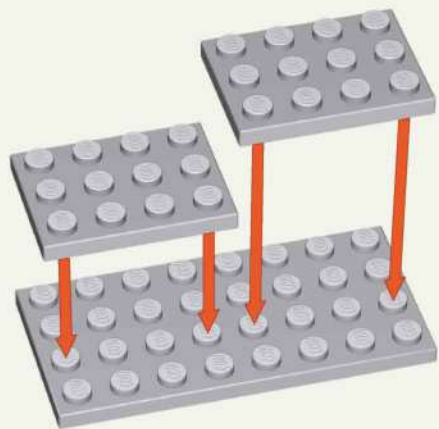

x1



x2

50

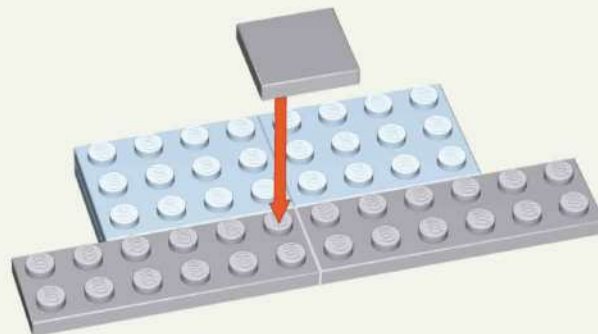

x1



x2

51

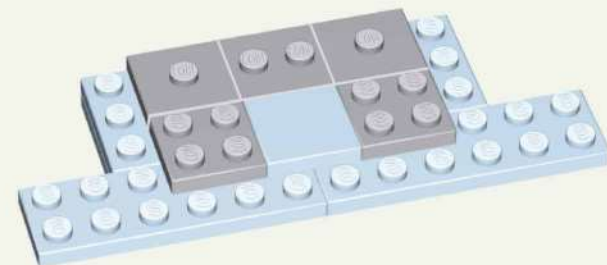

x2



x2



x1

52

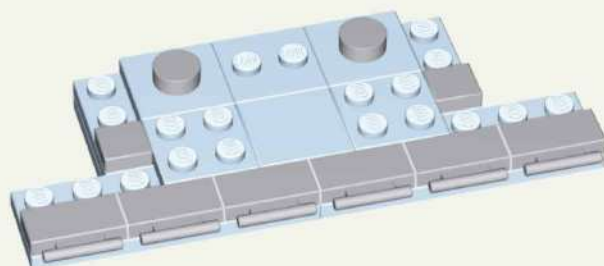

x2



x2



x6

53



1:1



x2



x1

54

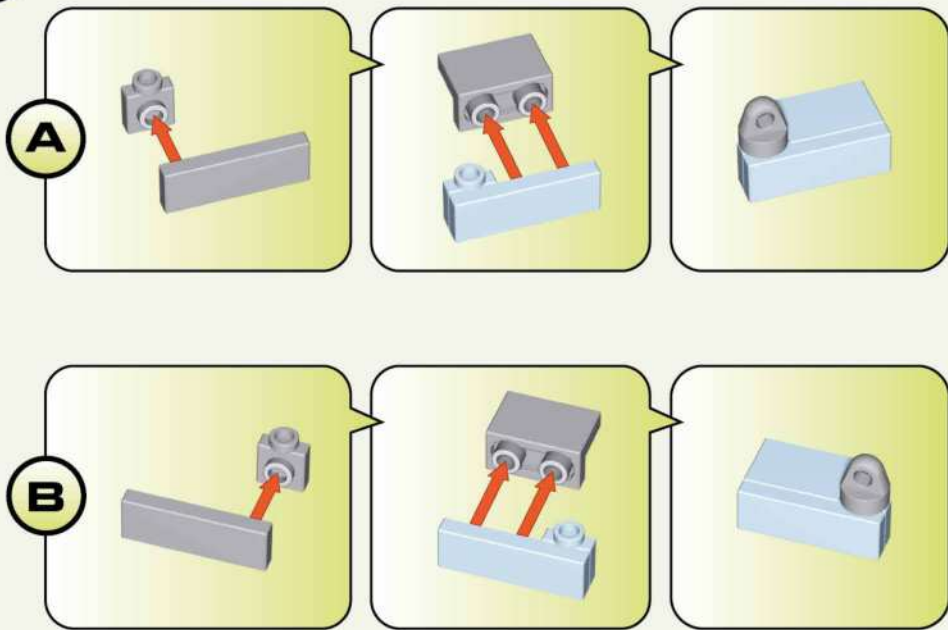

1:1

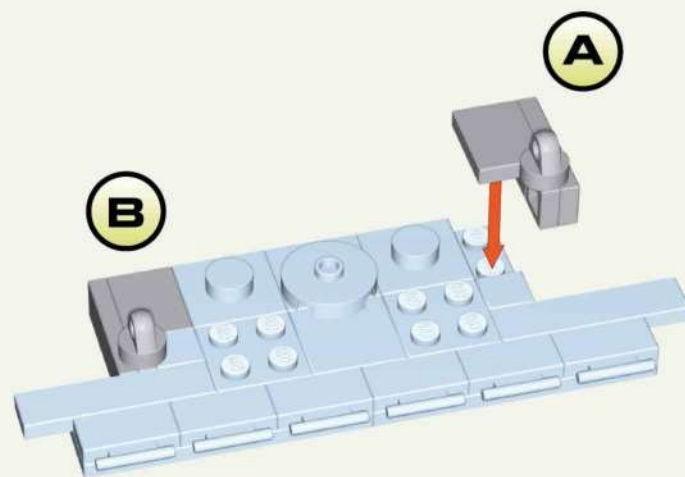

55

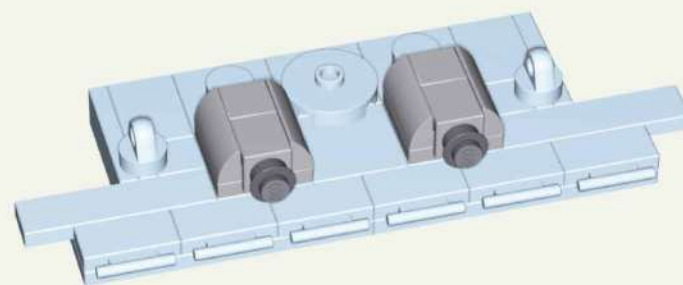
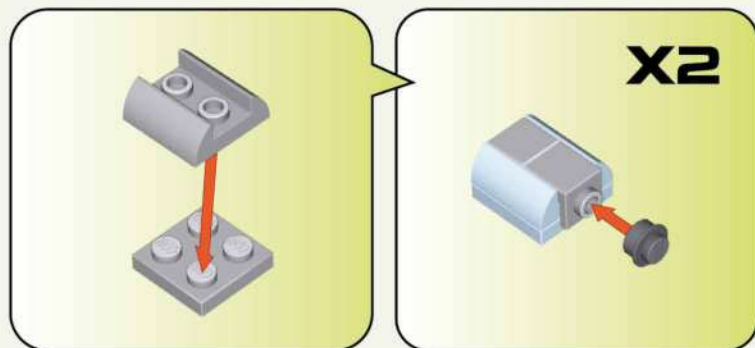

56

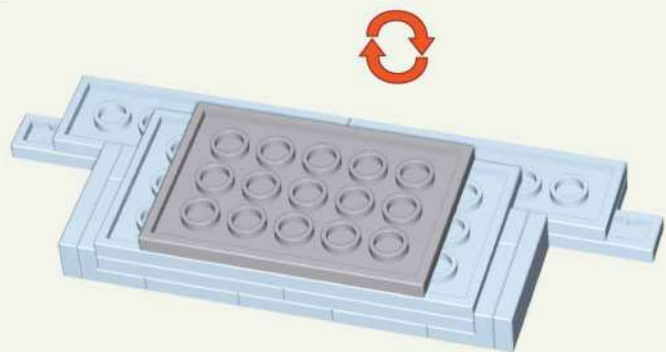

57

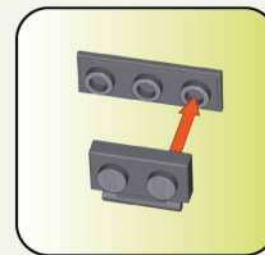
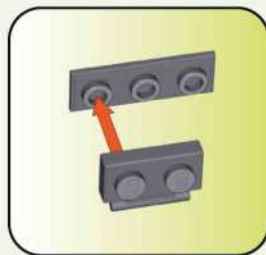

58

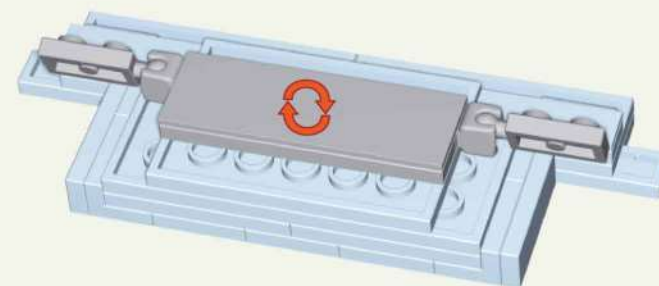
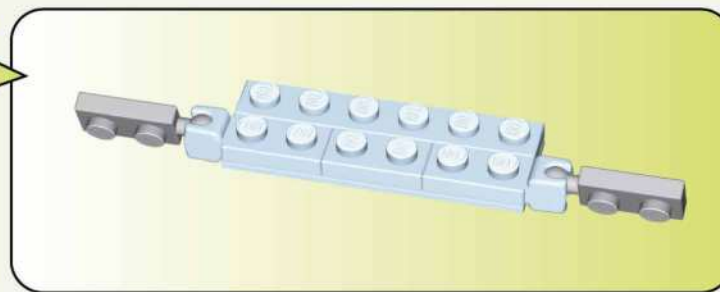
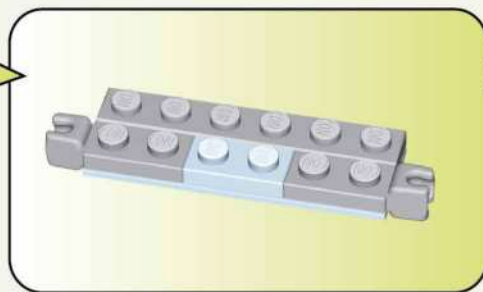
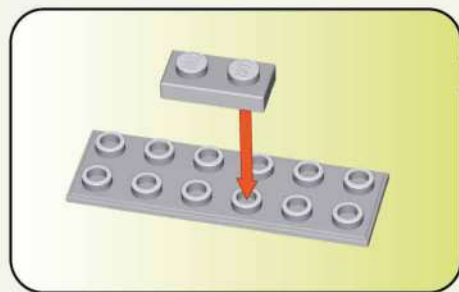

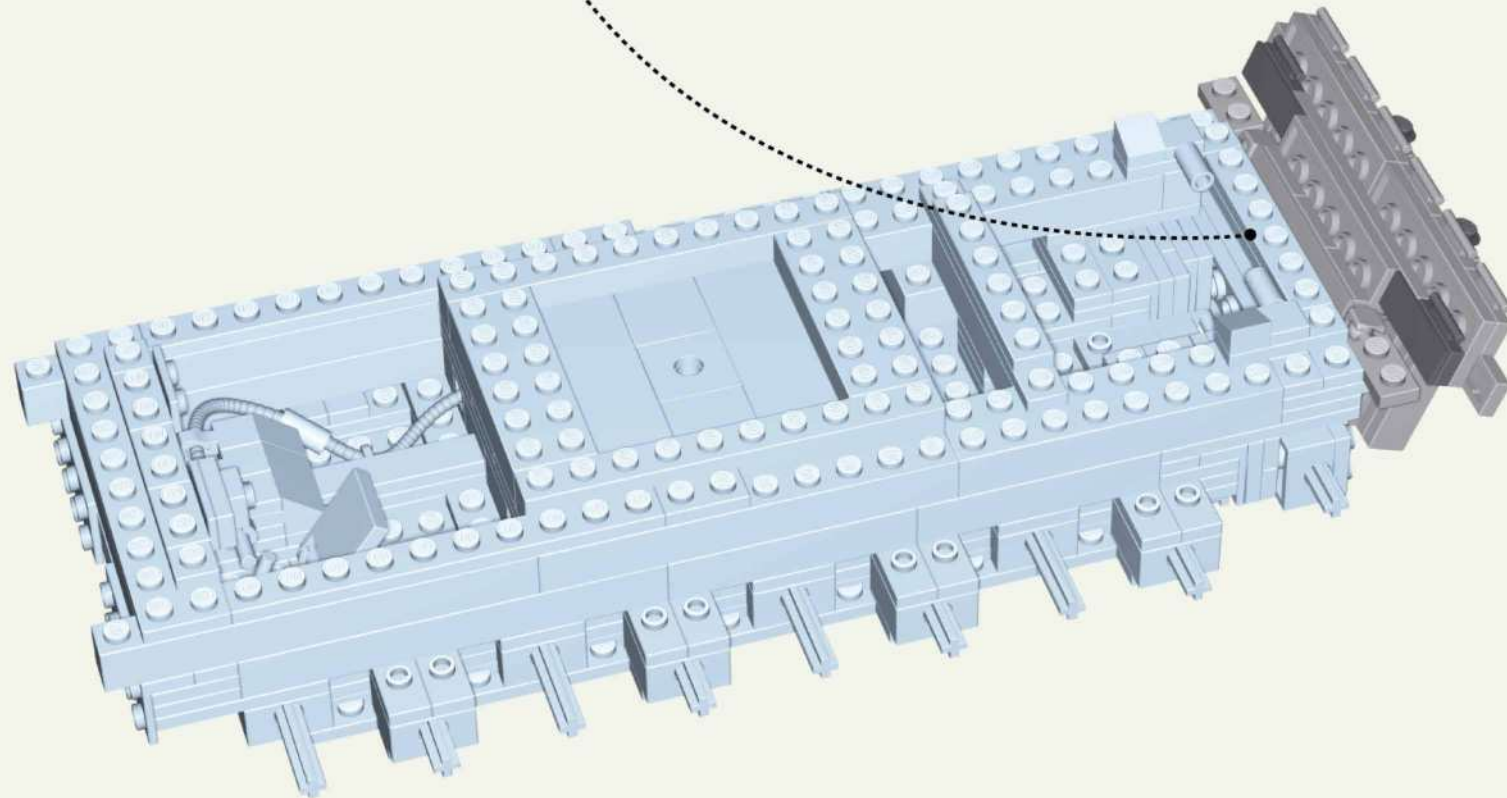
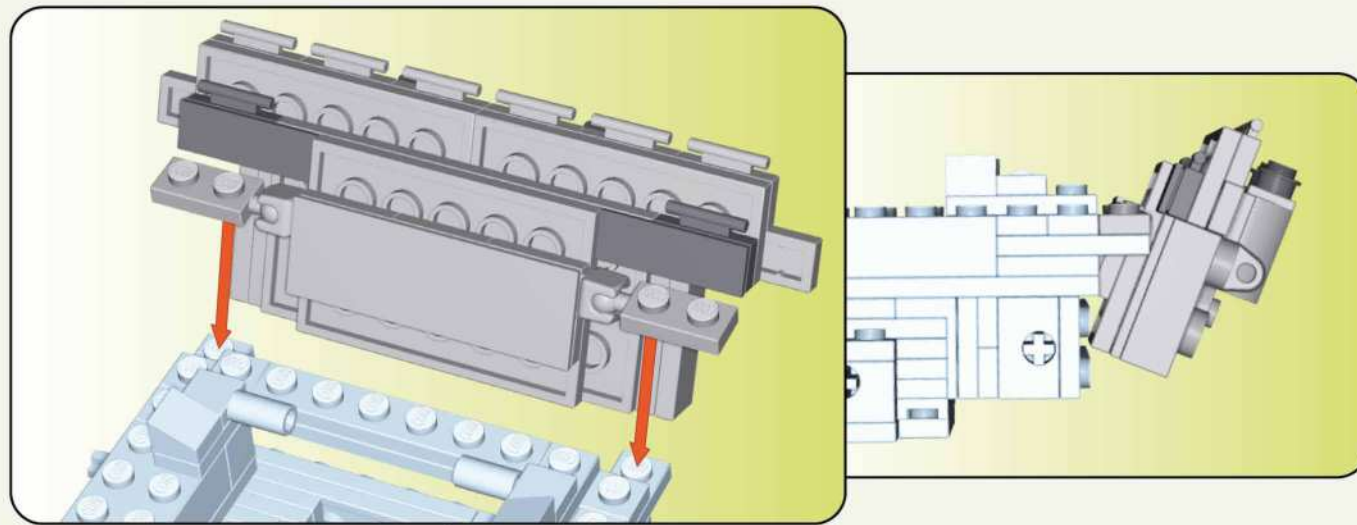



60

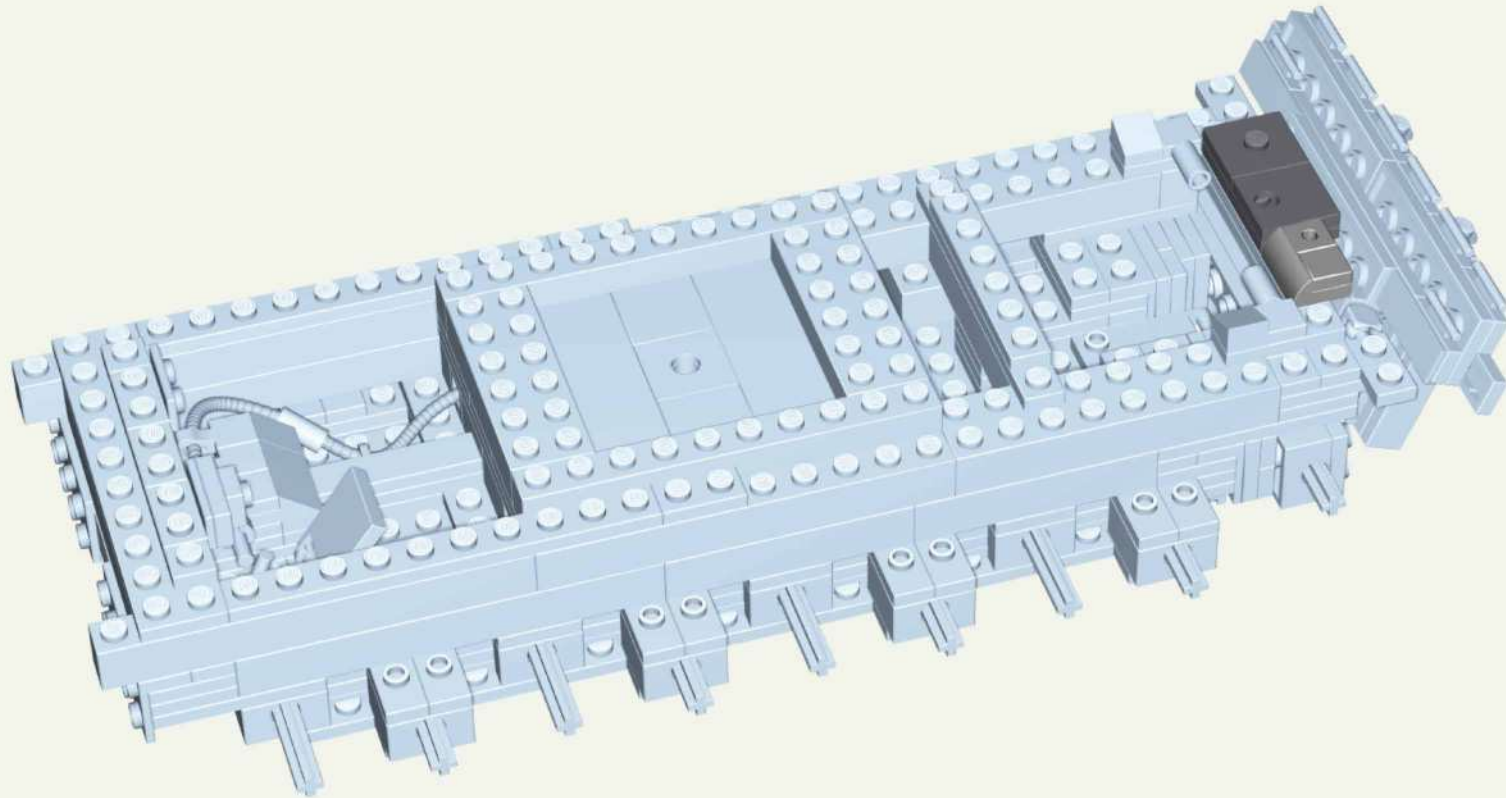
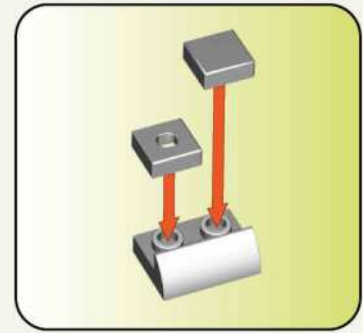
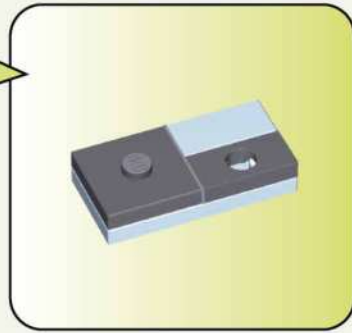
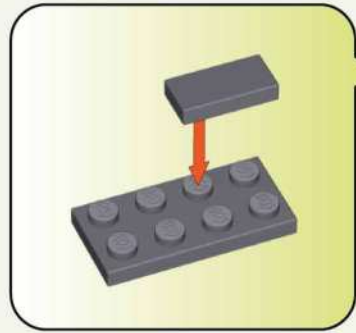

1:1



61



x2



x1

62



x2

1:1



x1

63

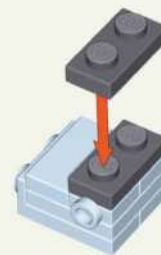

x2

64

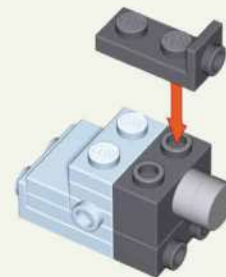
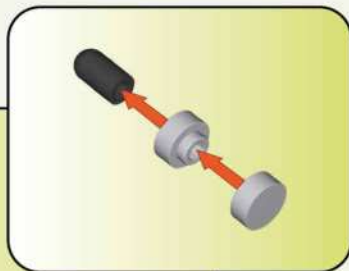
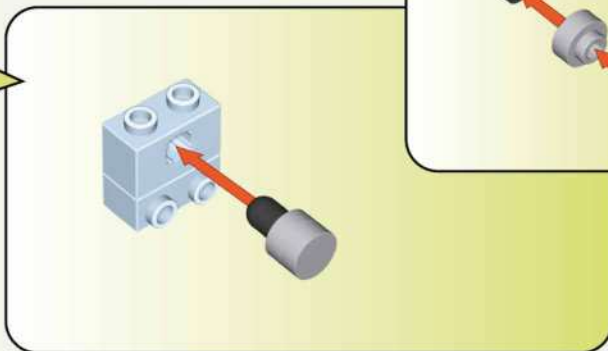
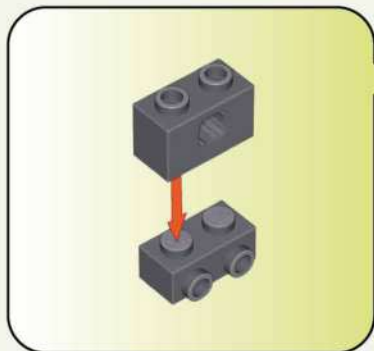

x1



x1



x1



x1



x1



x1

65

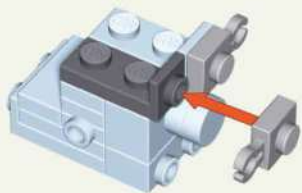

x1



x2

66

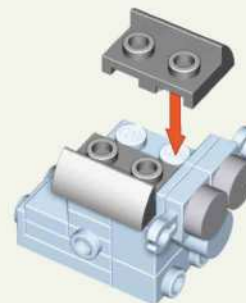

x2



x2

67

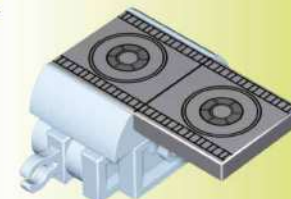
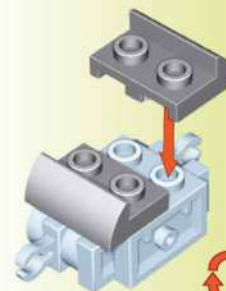

x1



x4



x1



x2



x3



x2



x1

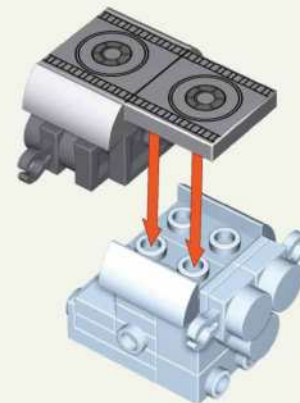

68

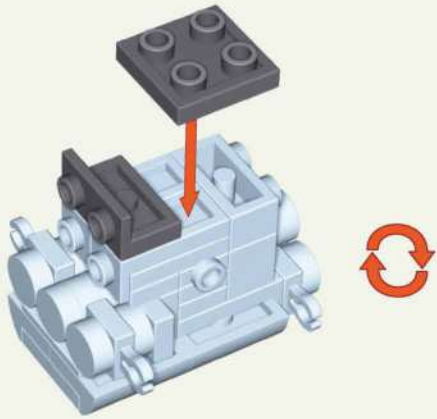

x1



x1

69

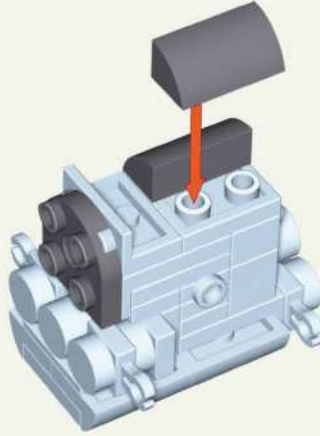

x1



x2

70

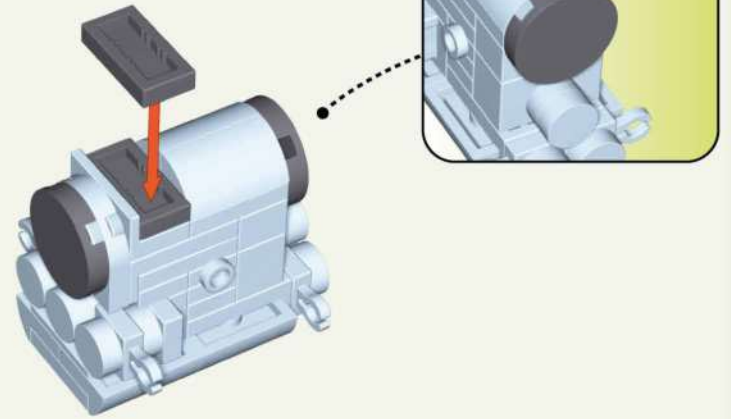

x2



x2

71

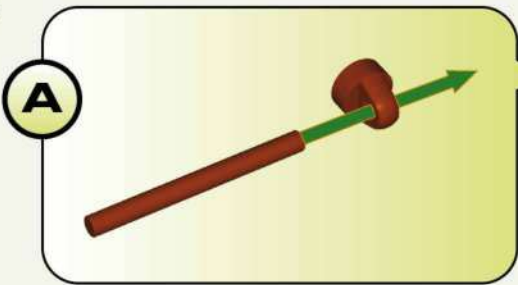

A

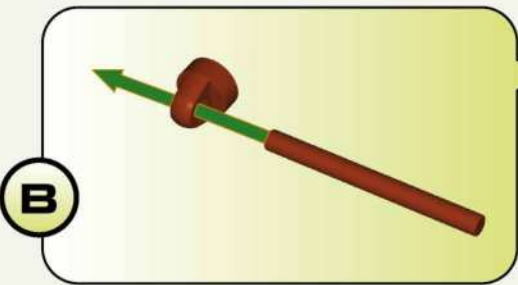
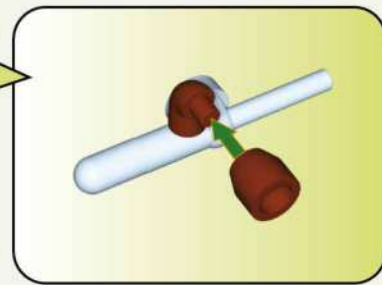
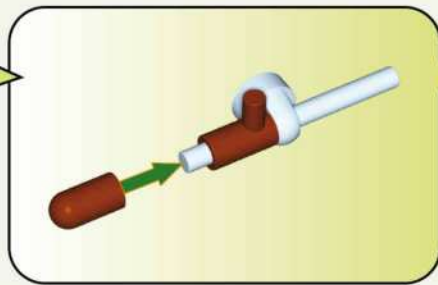

B

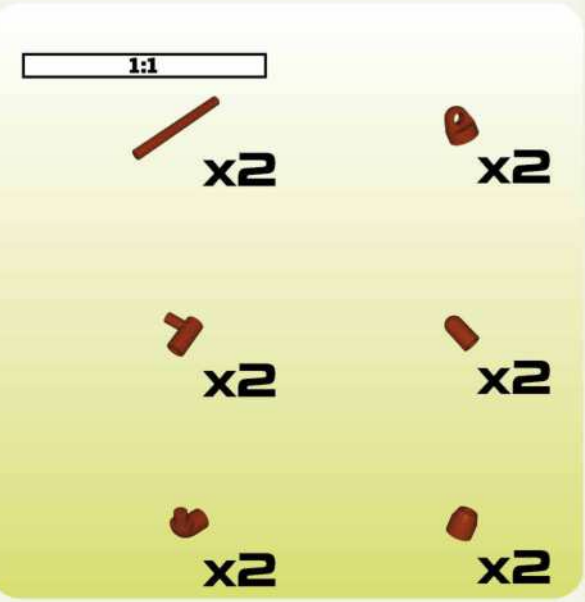
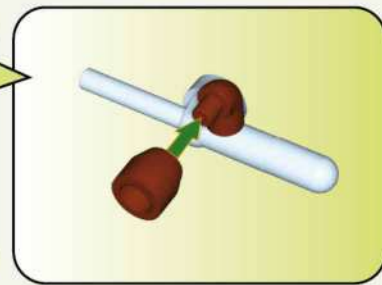
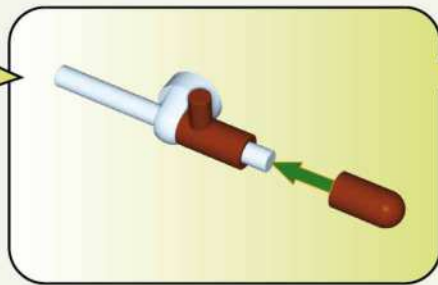

72

B

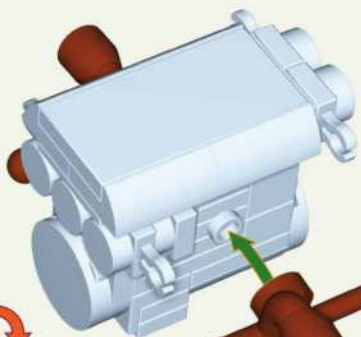

A

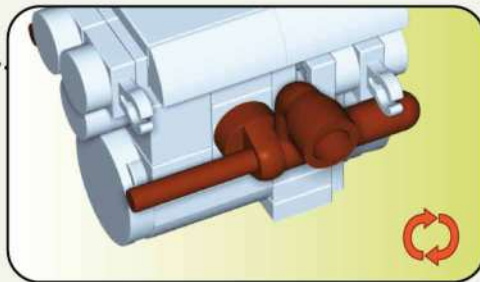

73

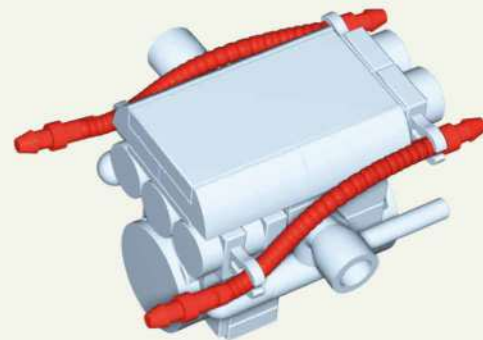

74

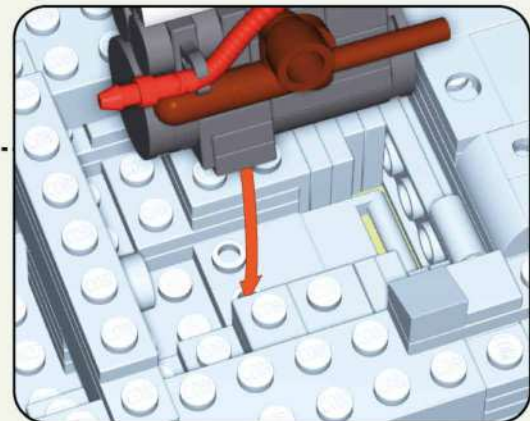
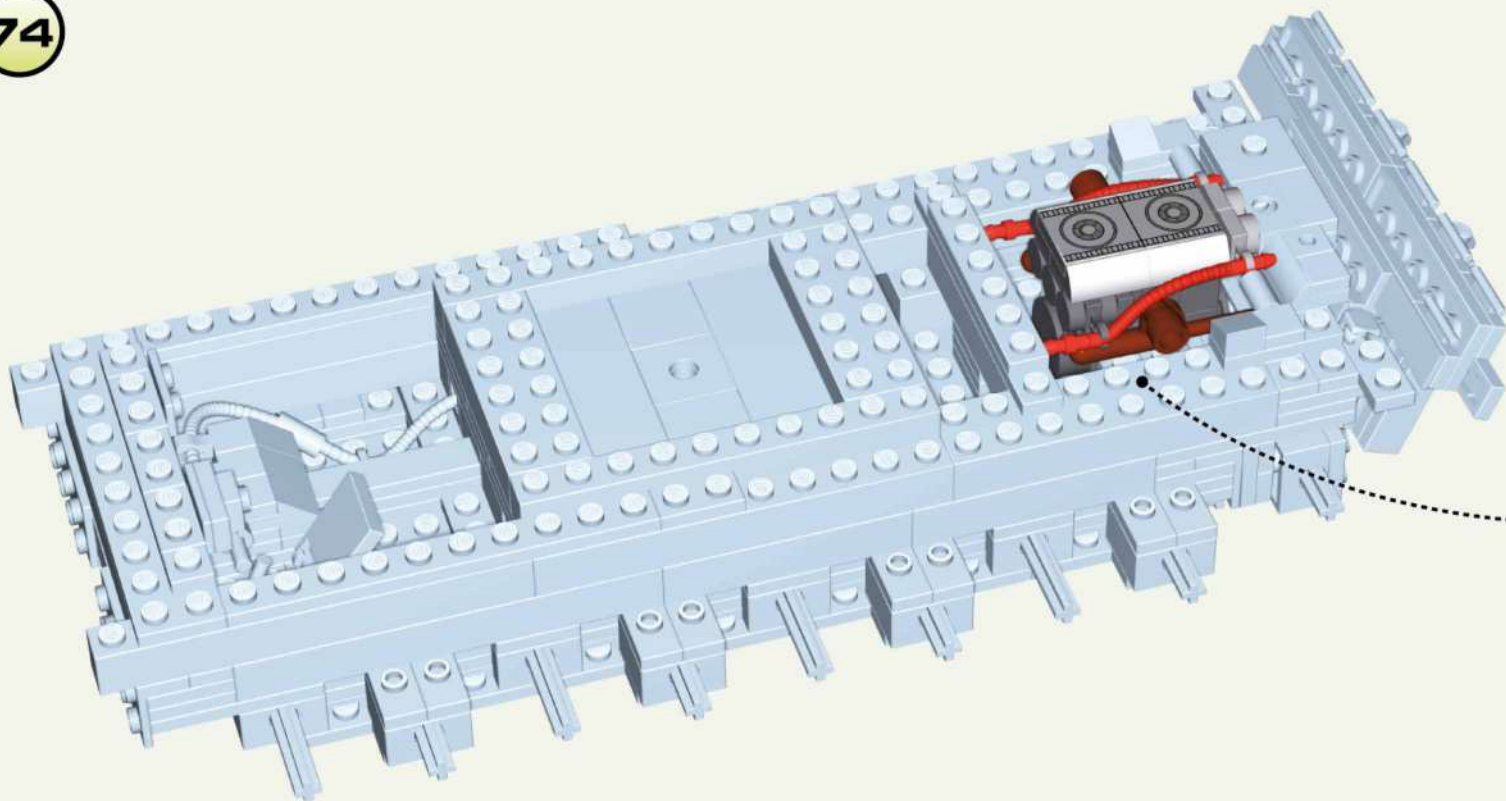

75

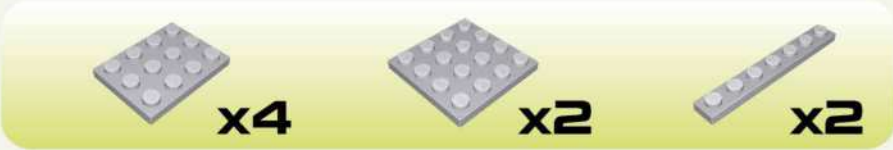
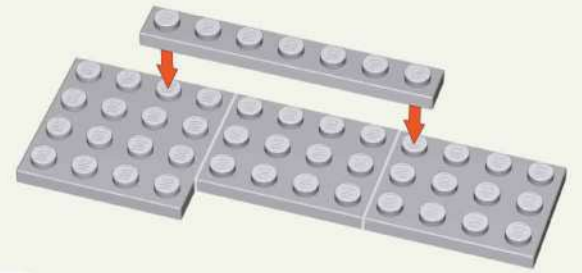
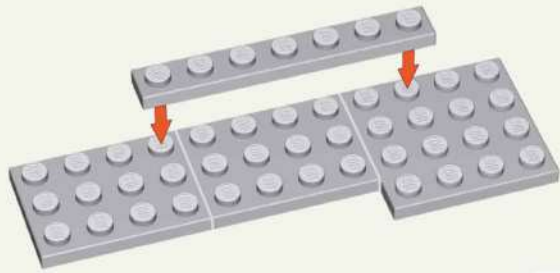

76

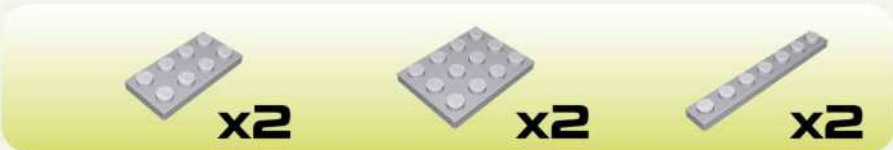
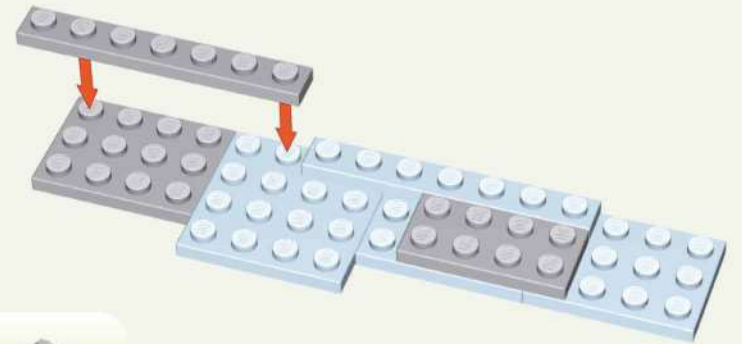
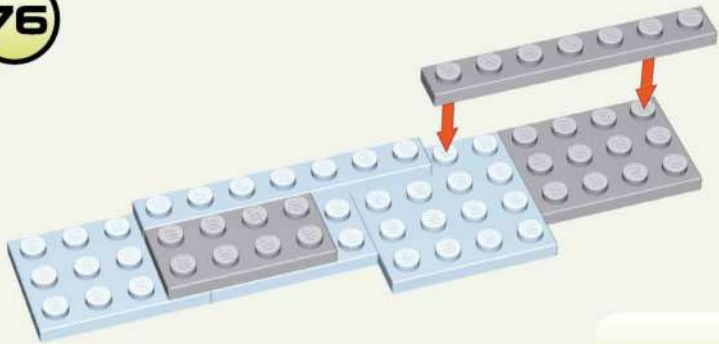

77

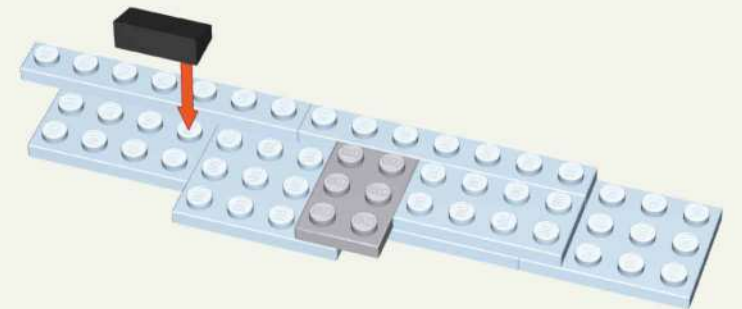

78



79



80

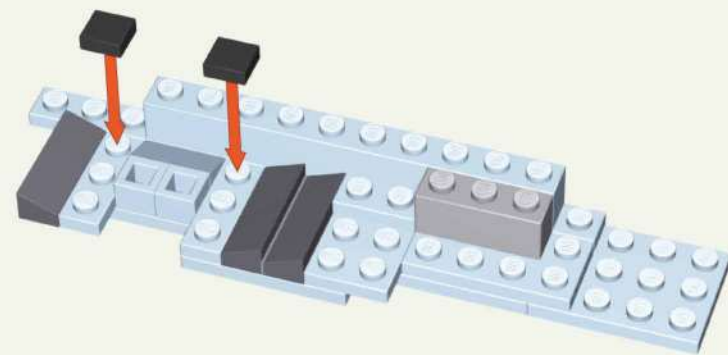
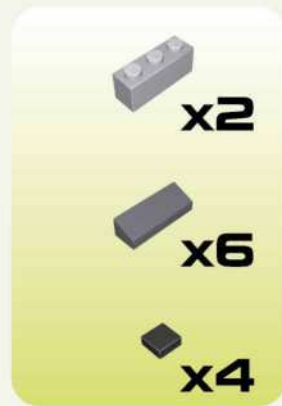
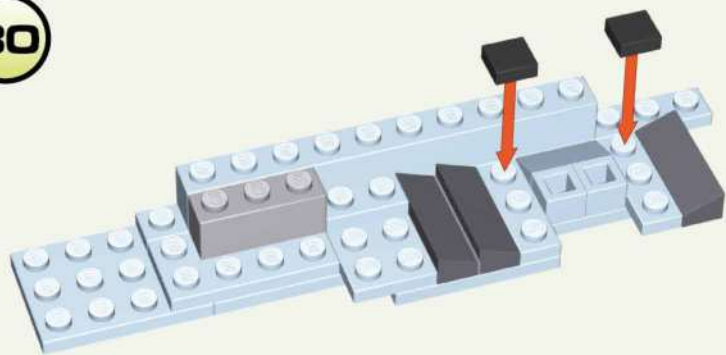

81

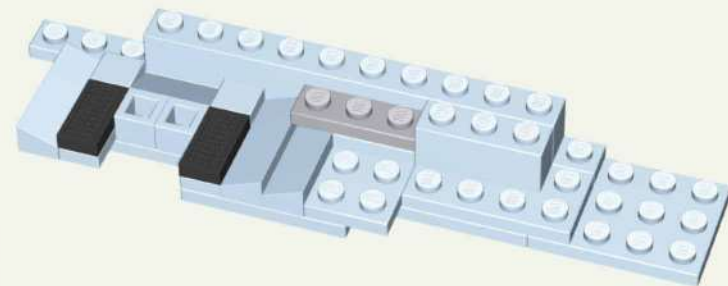

82

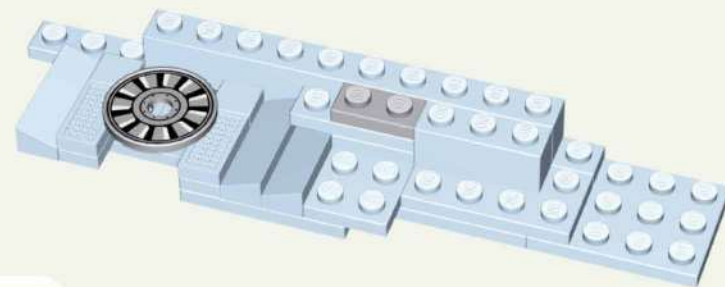

x2



x2

83

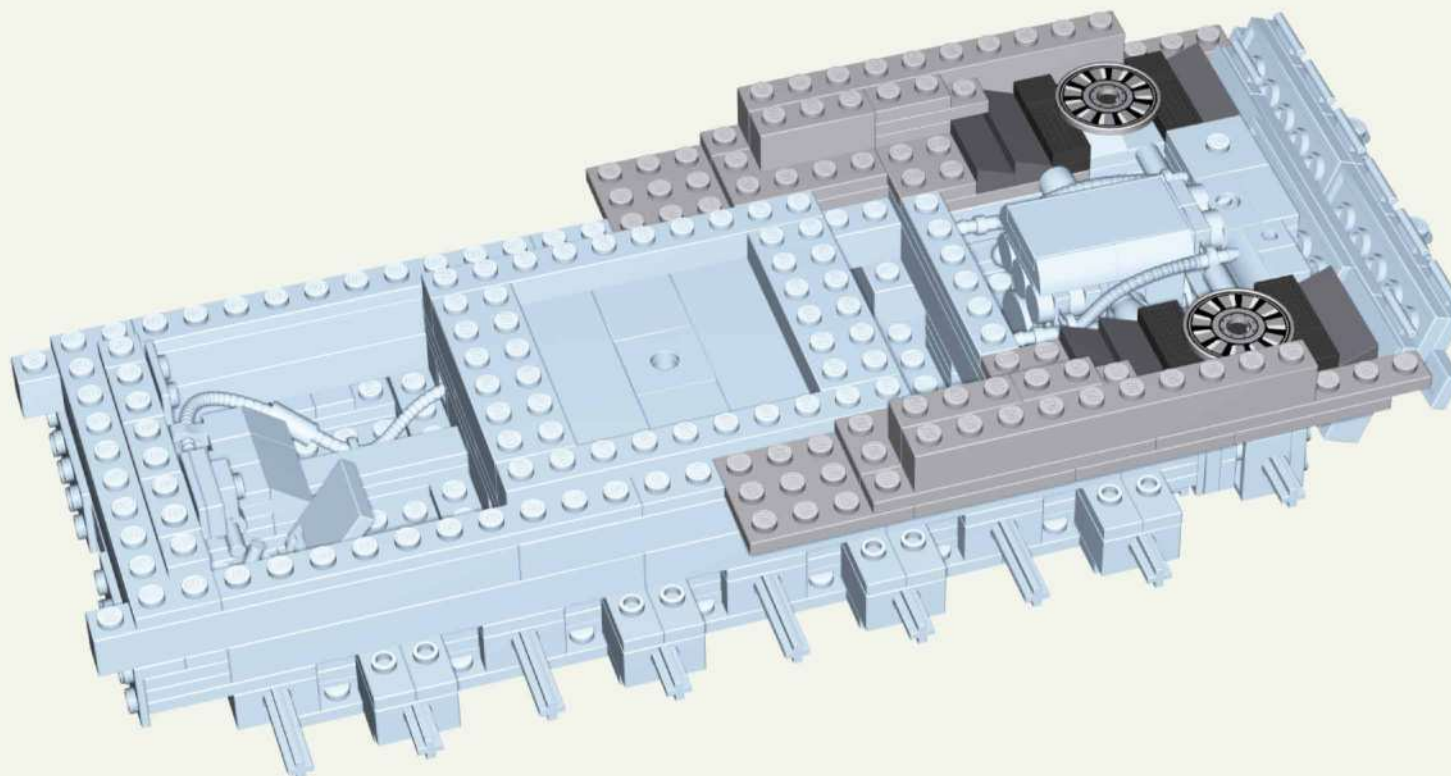

84

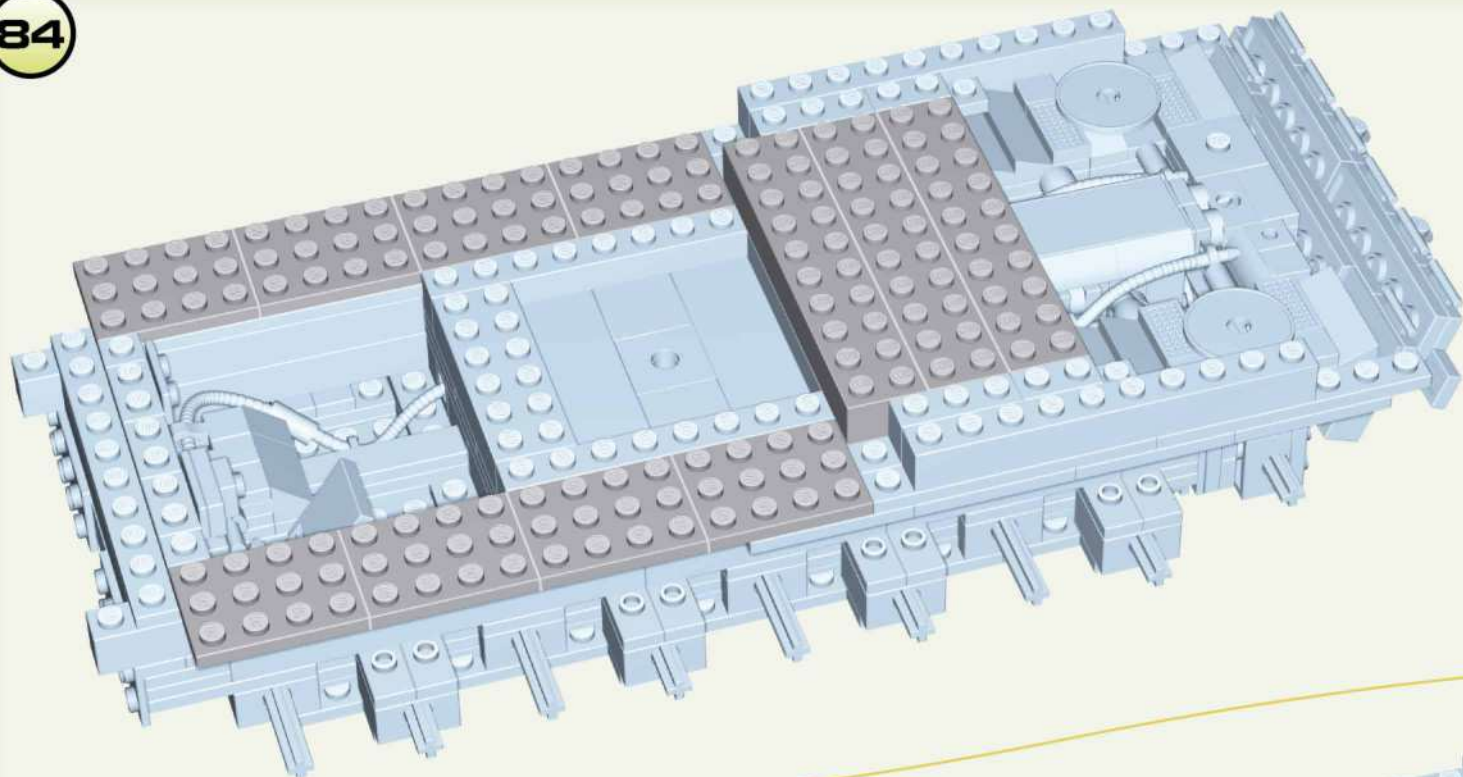

x3



x8

85

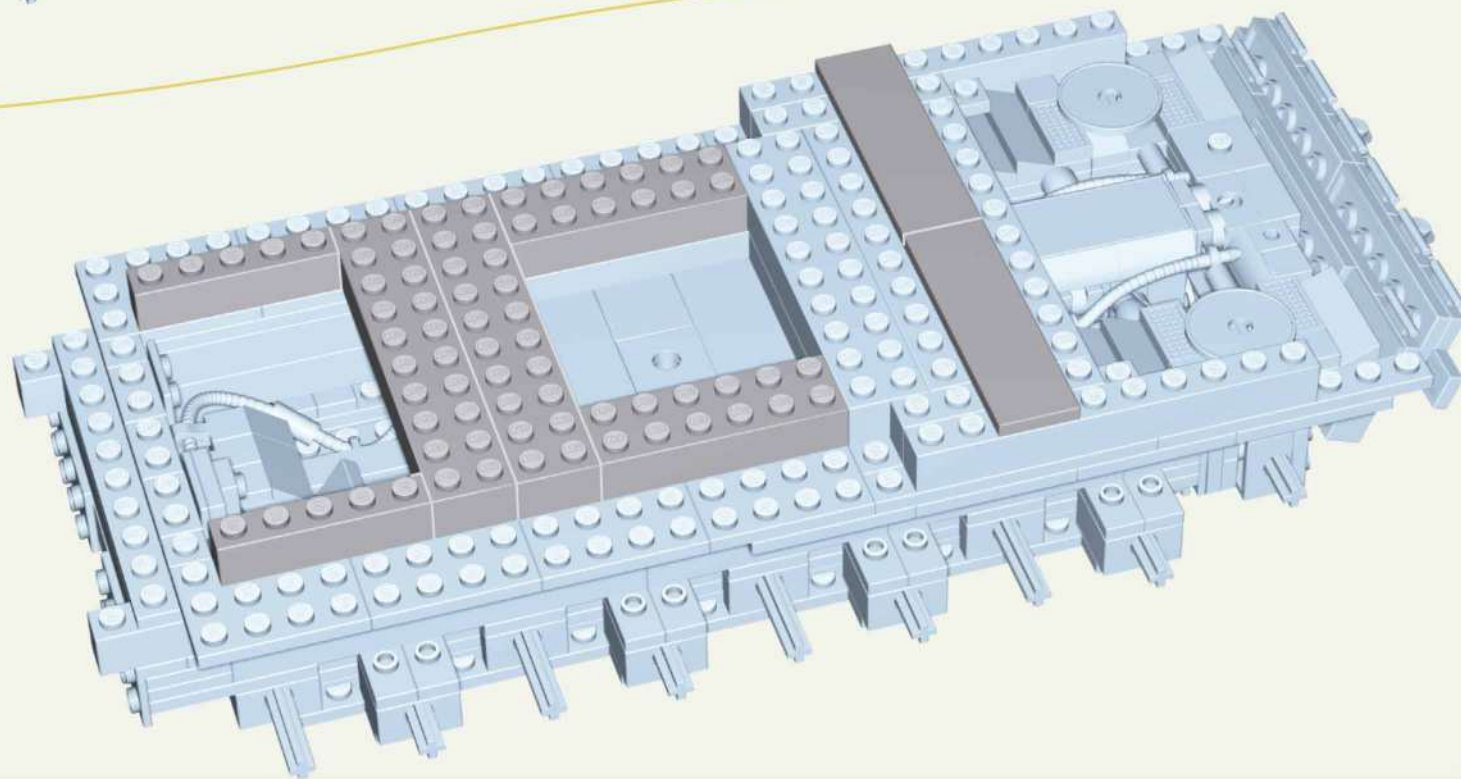

x2



x2



x2

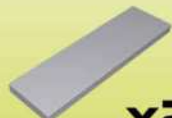

x2

86

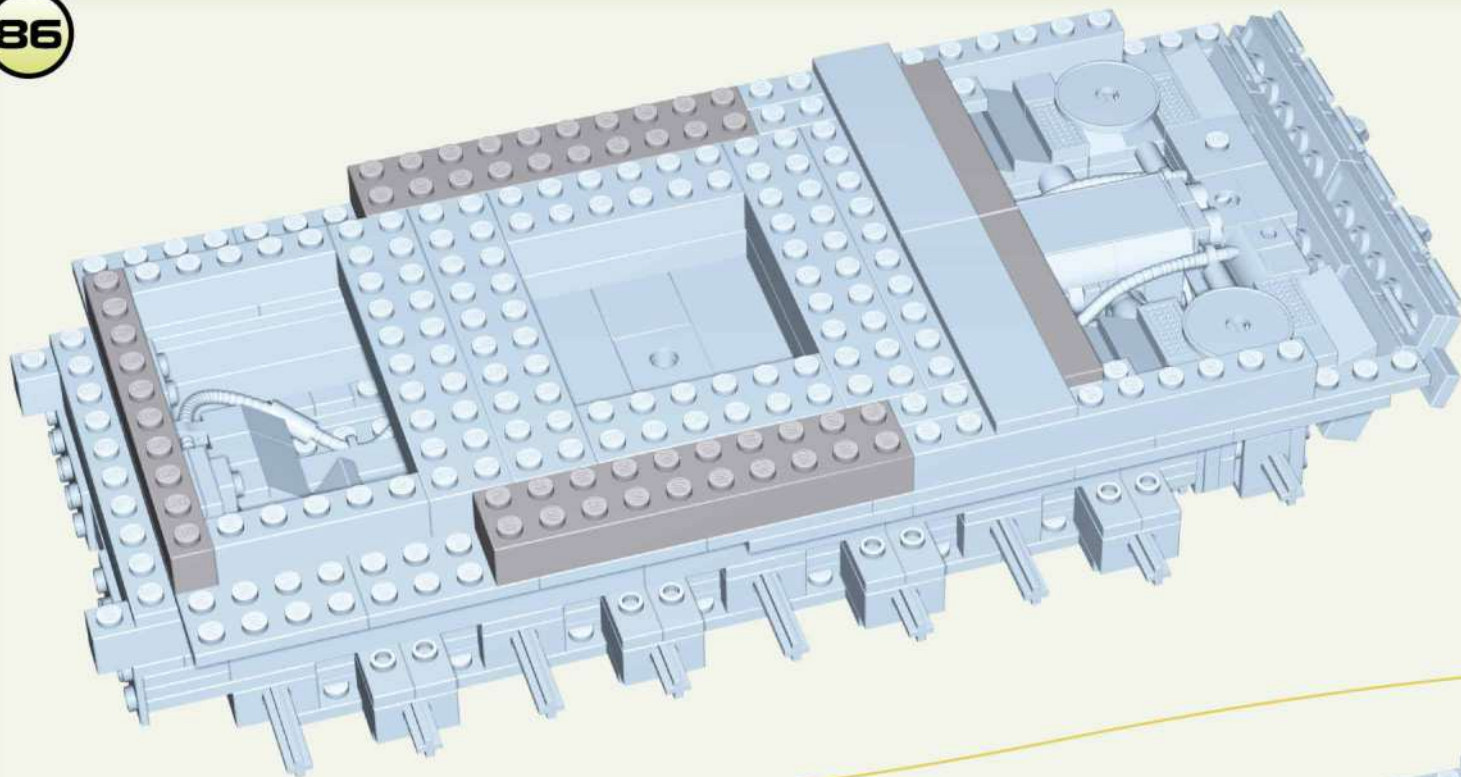

1:1



x2



x2

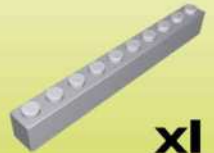

x1

87

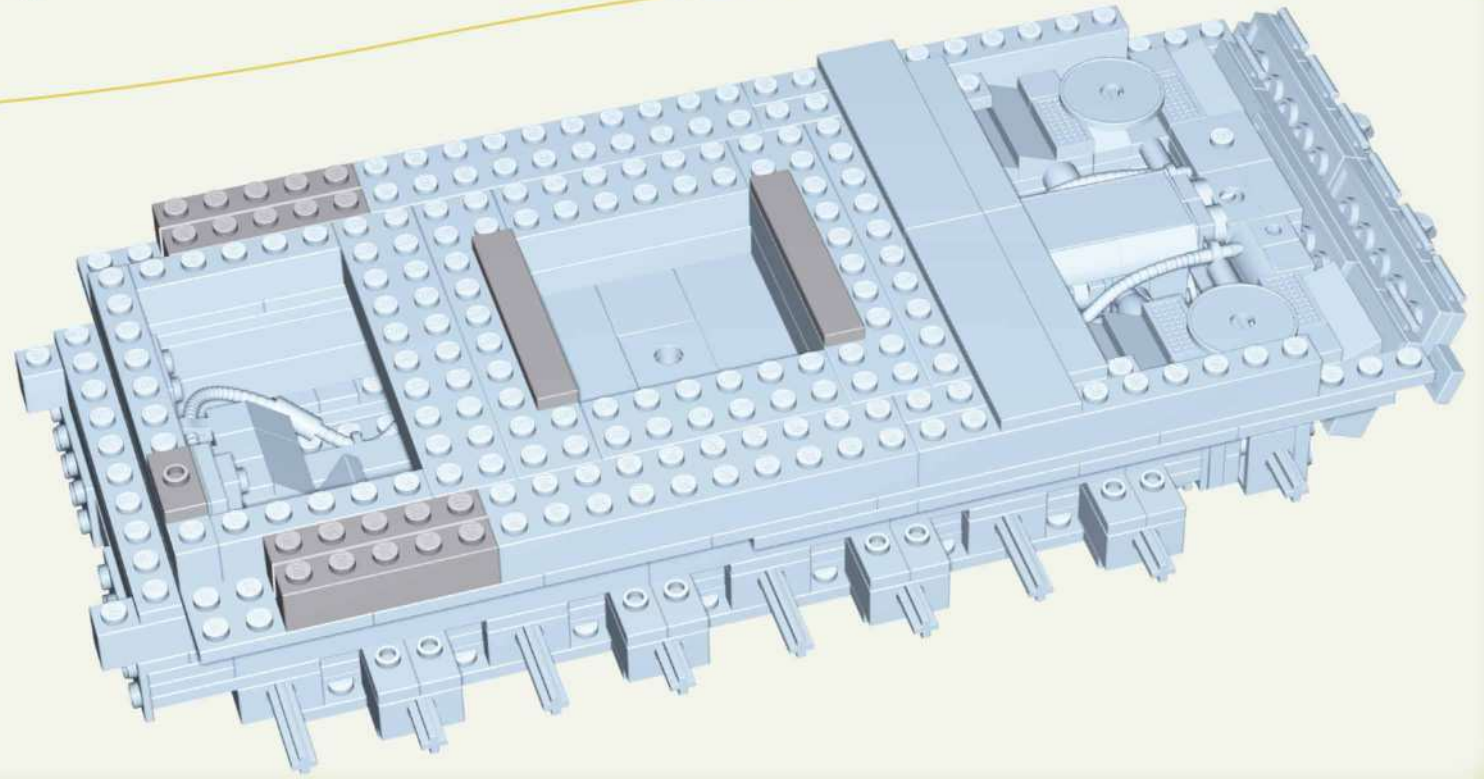

1:1



x2



x1



x4

88

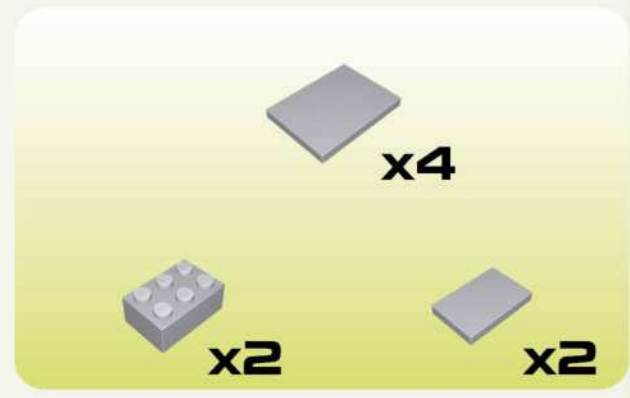
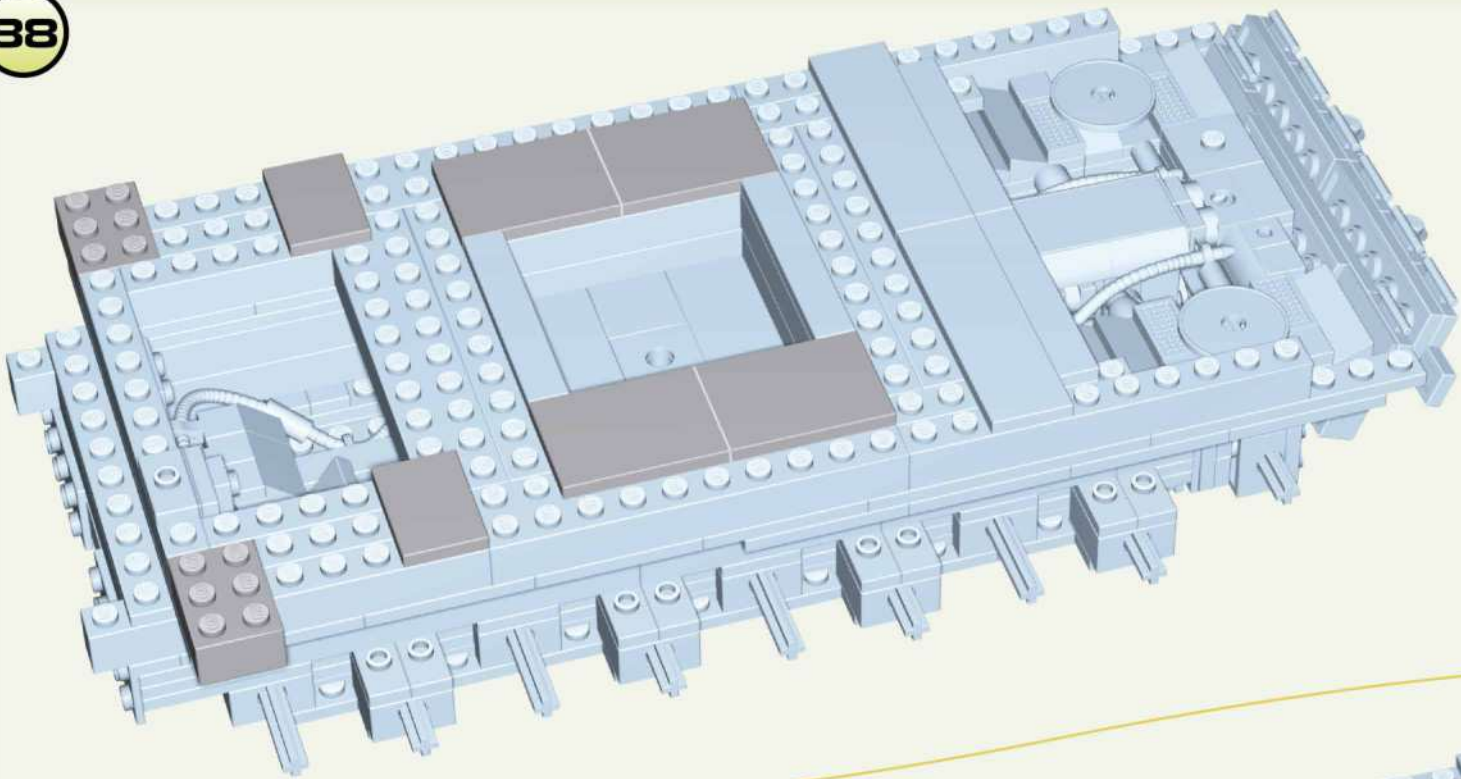

89

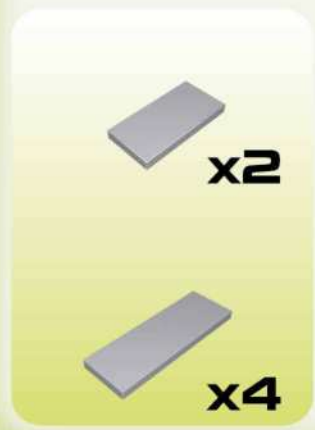
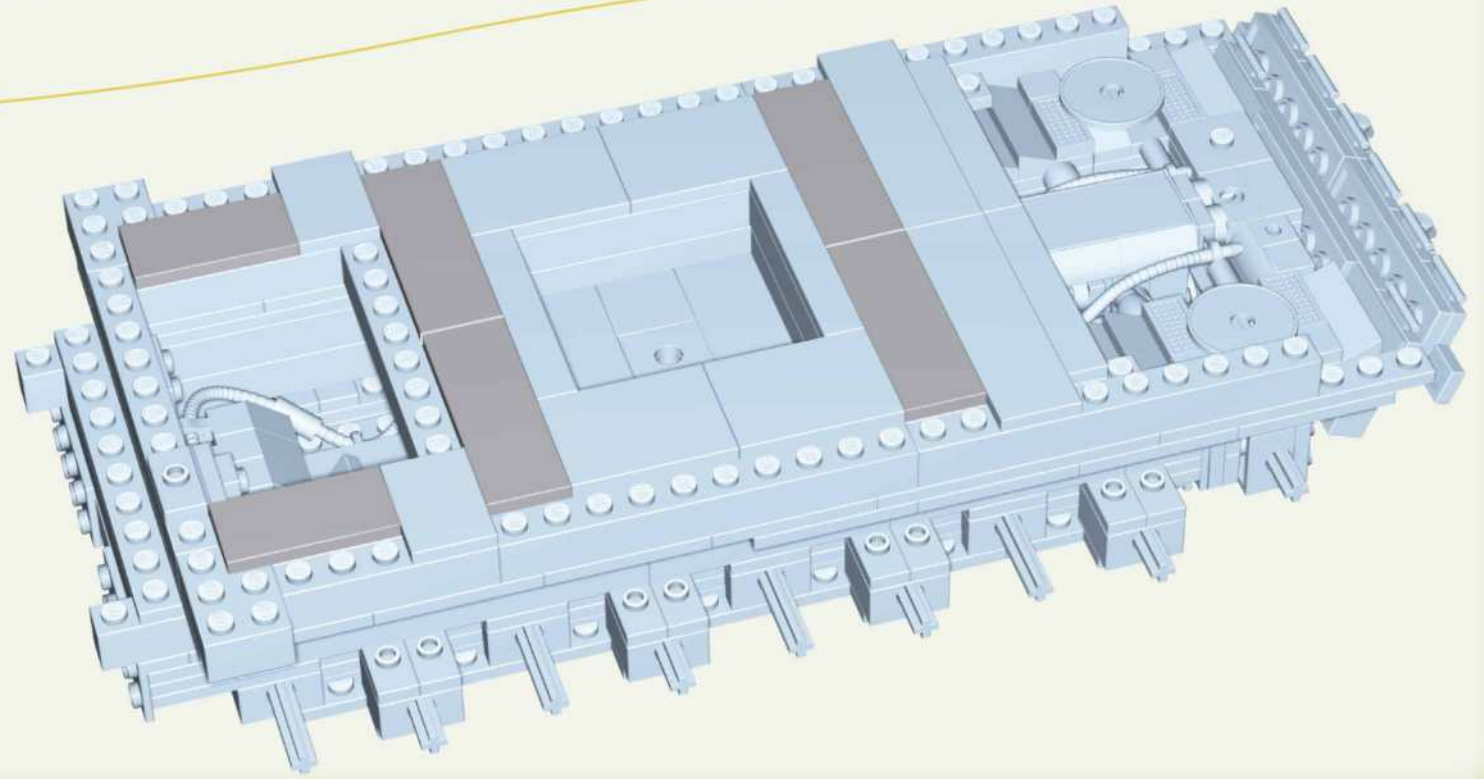

90



91

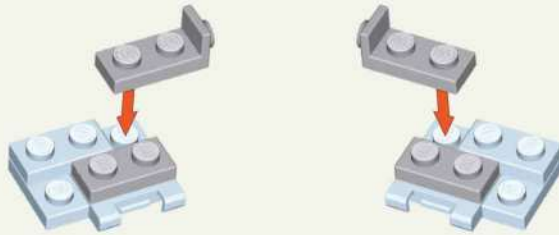

92

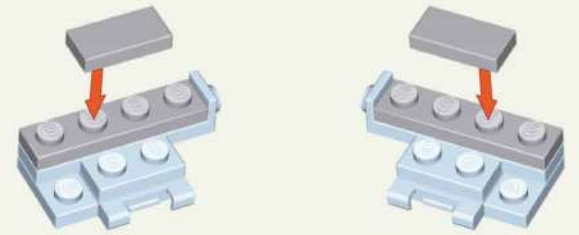

93



94

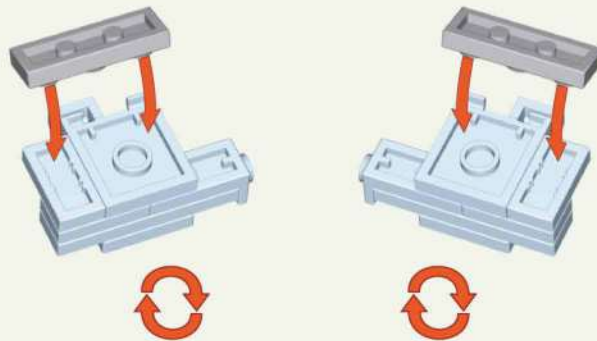

95

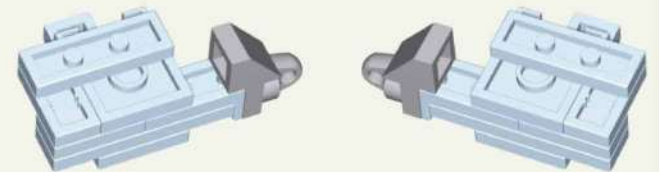

96

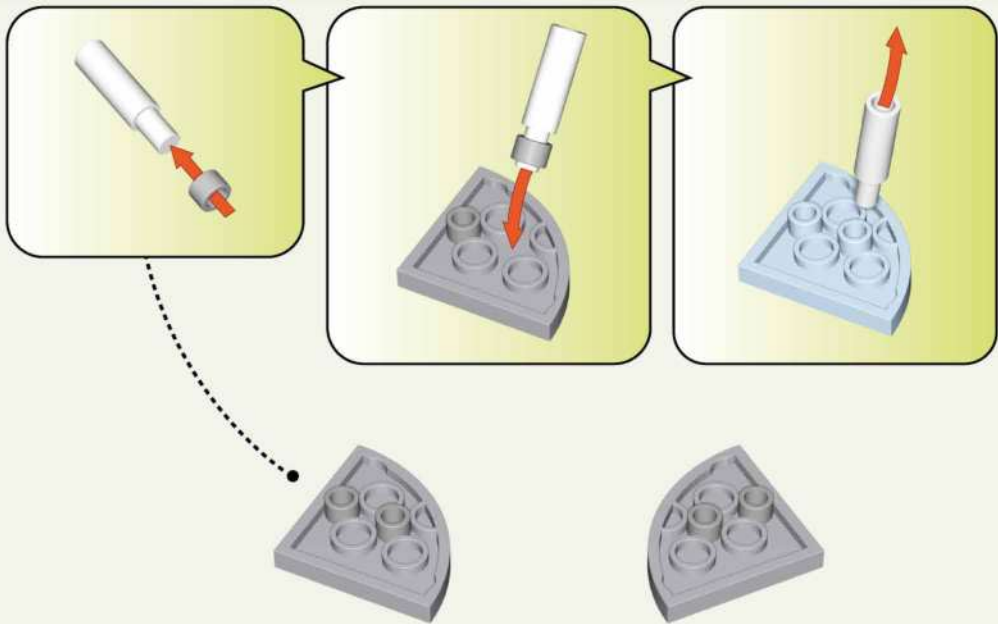

97



98



99



100

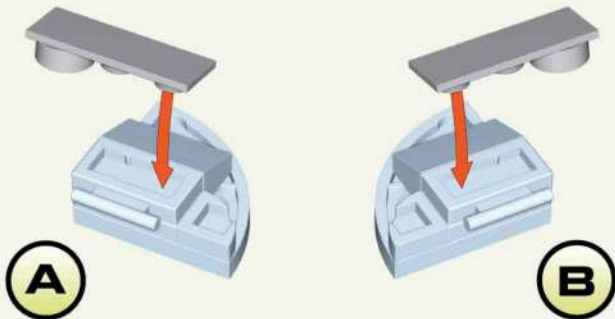
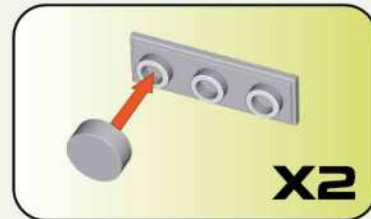

101

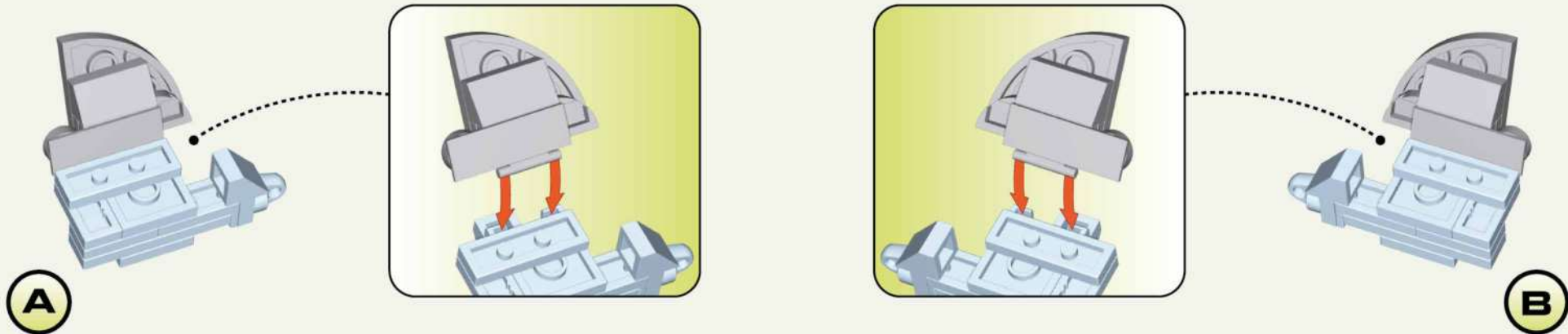

102

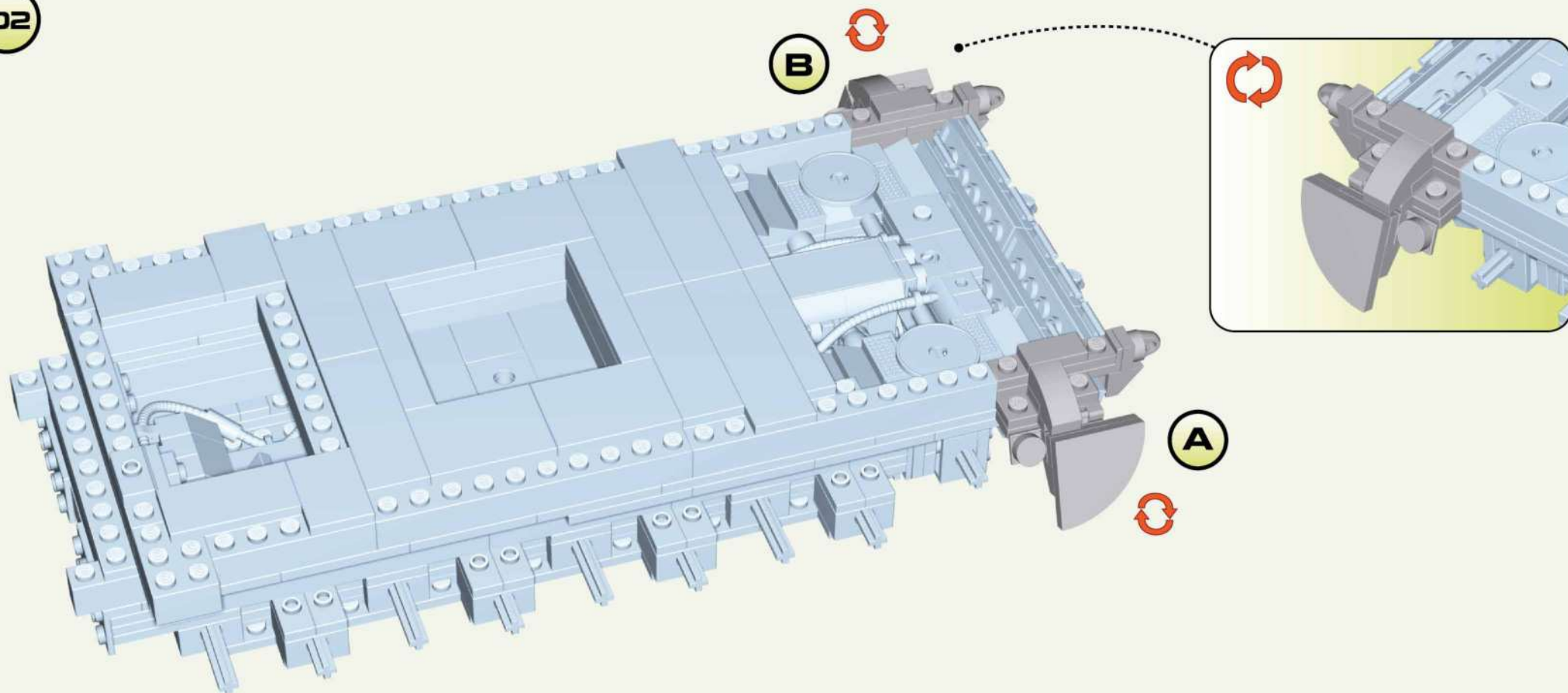

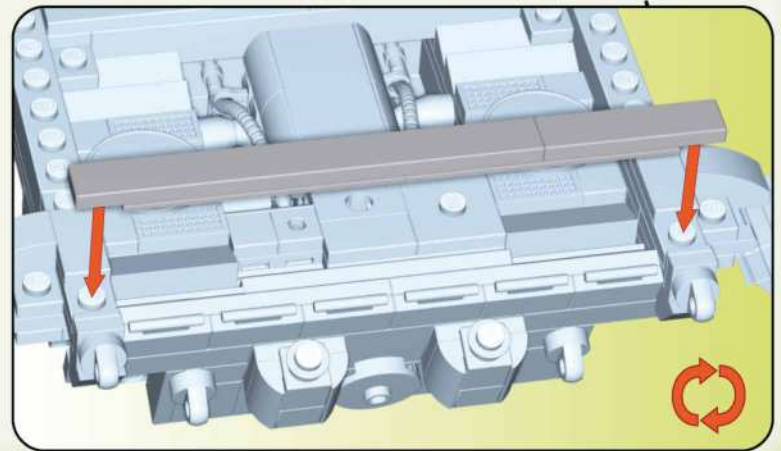
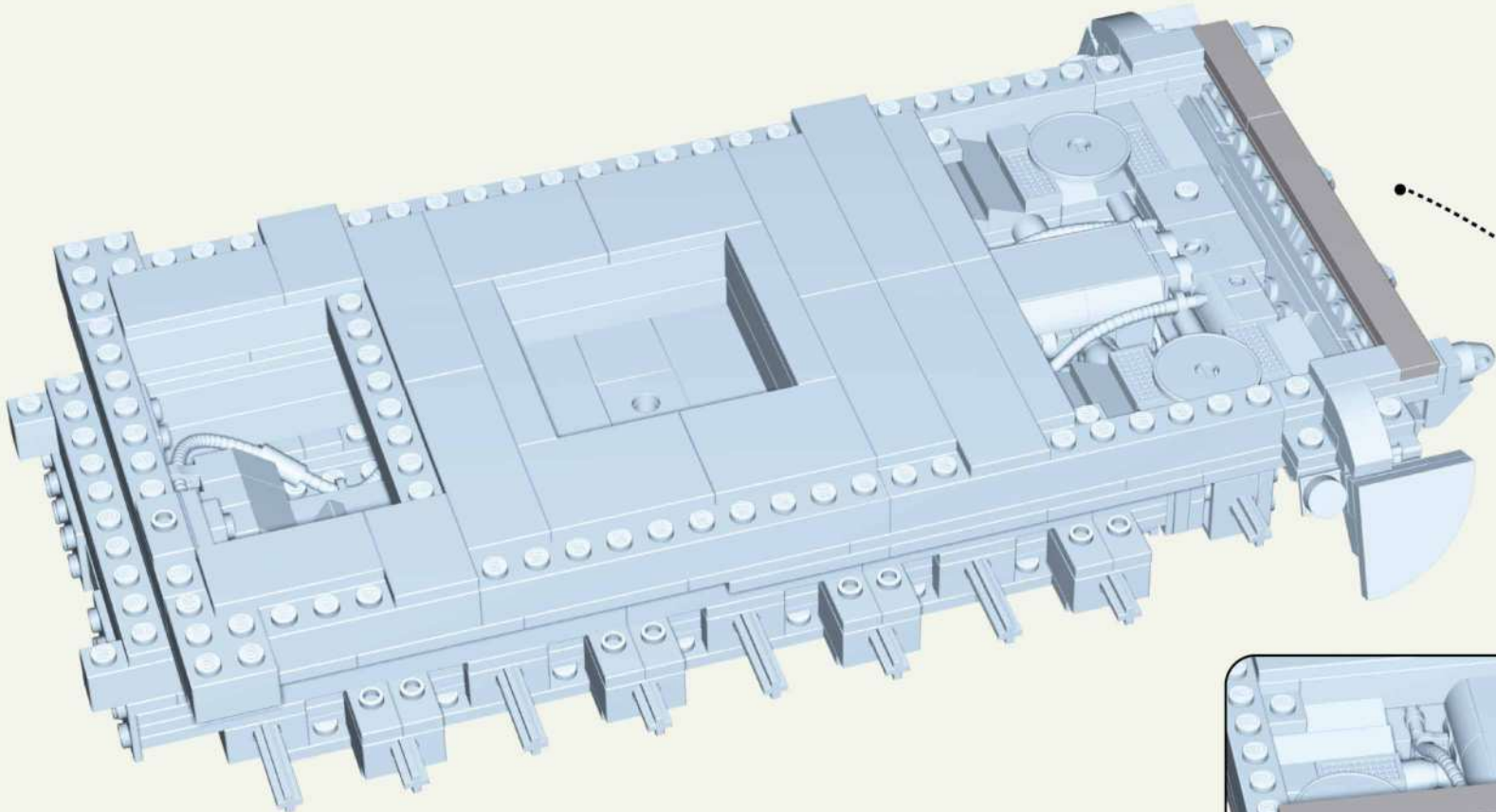
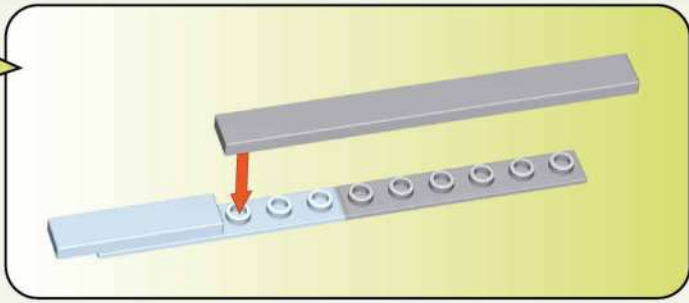
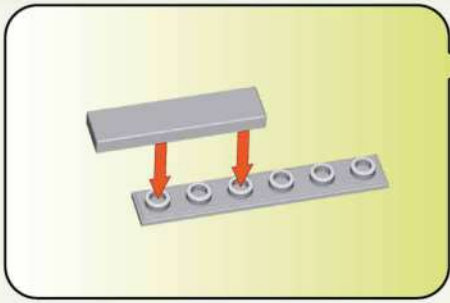

1:1

1:1



104

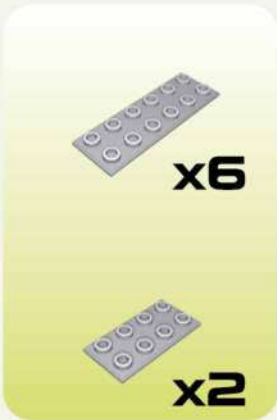
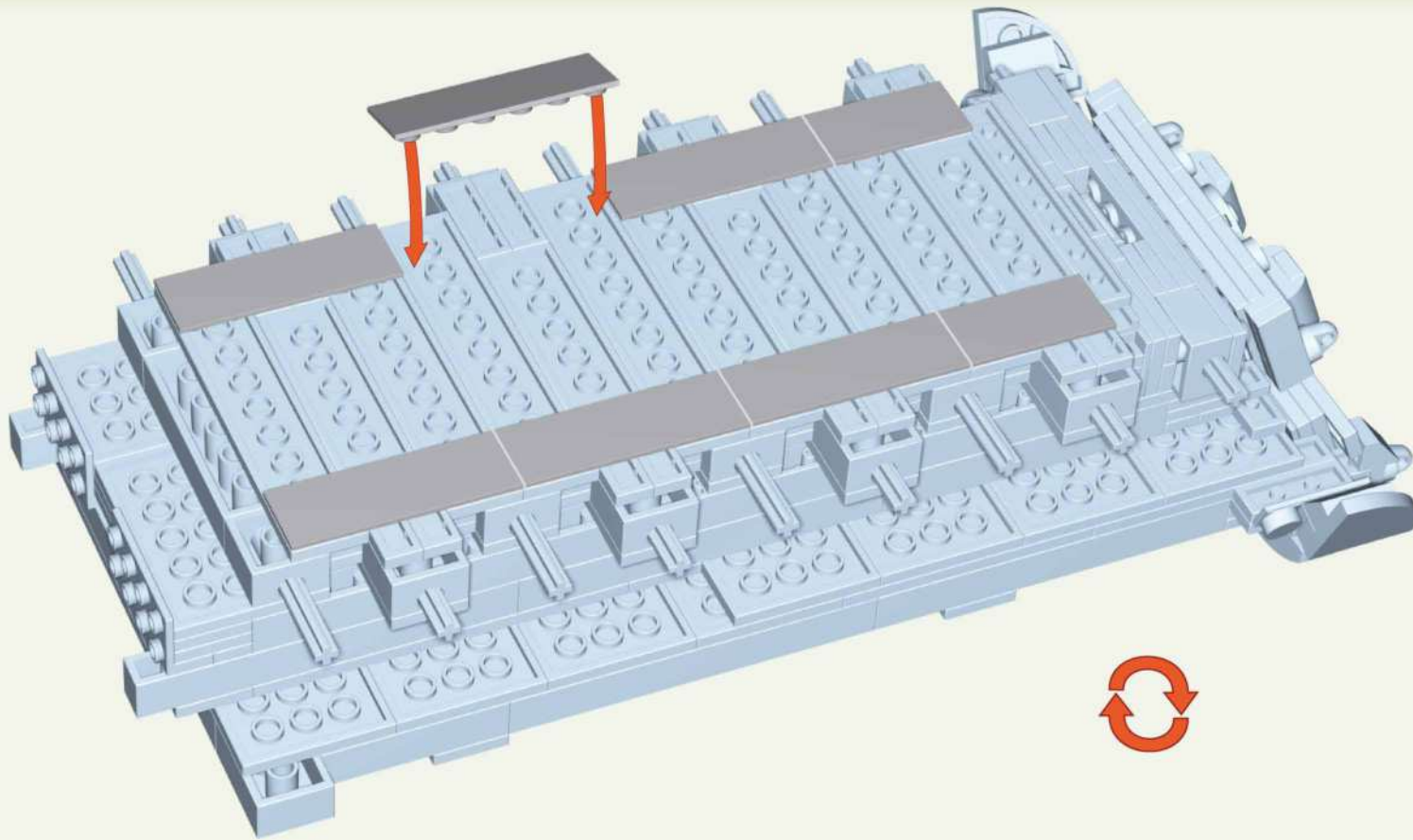

105

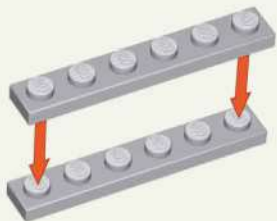

106

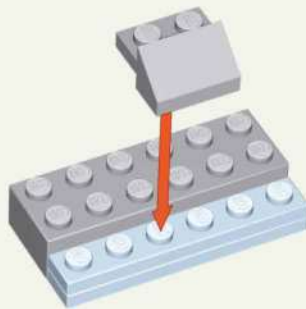

107

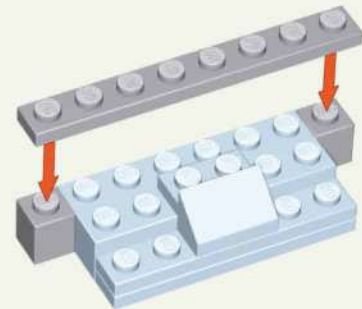

108



109

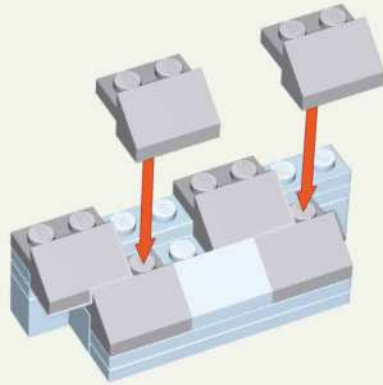

110

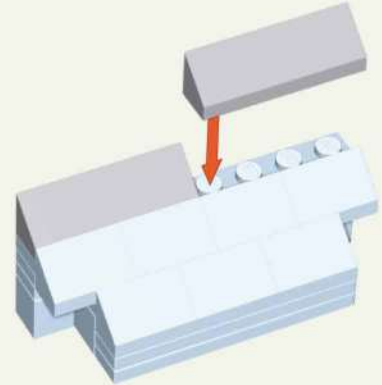

III

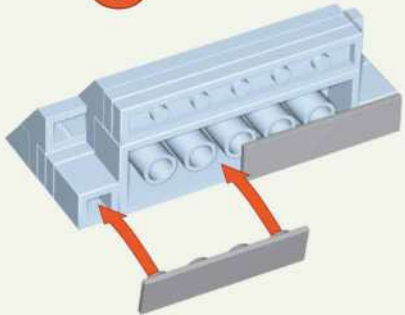

112

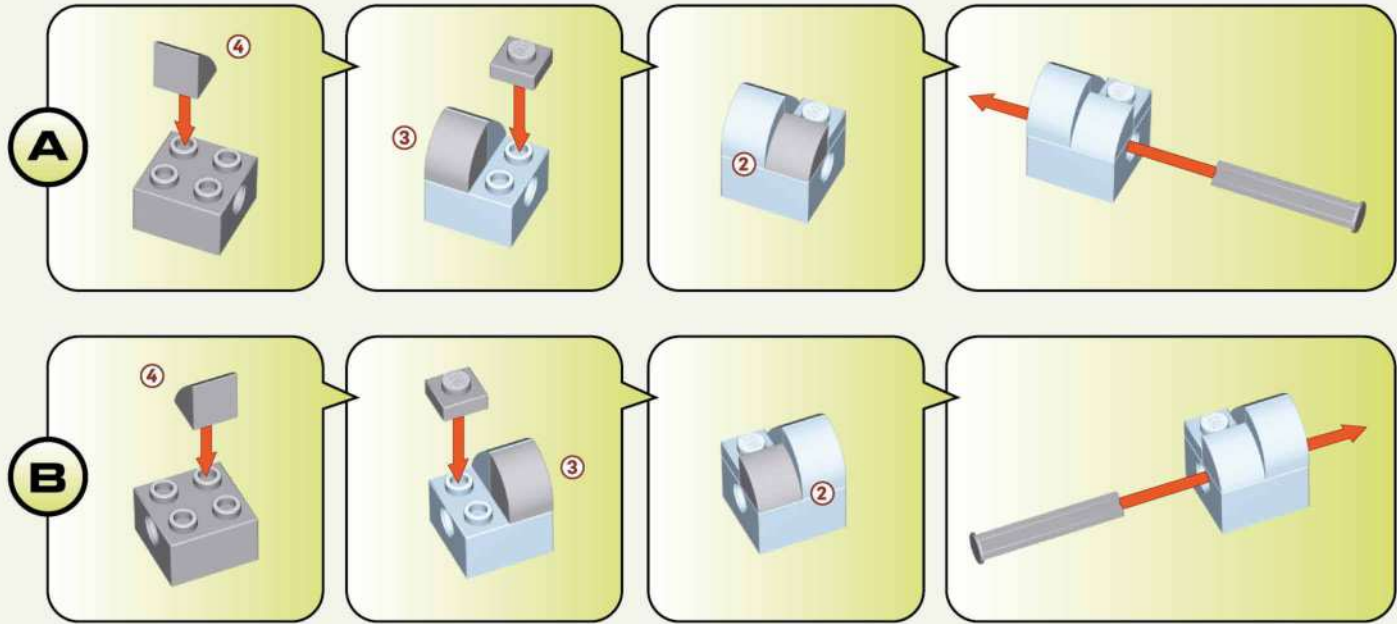

113

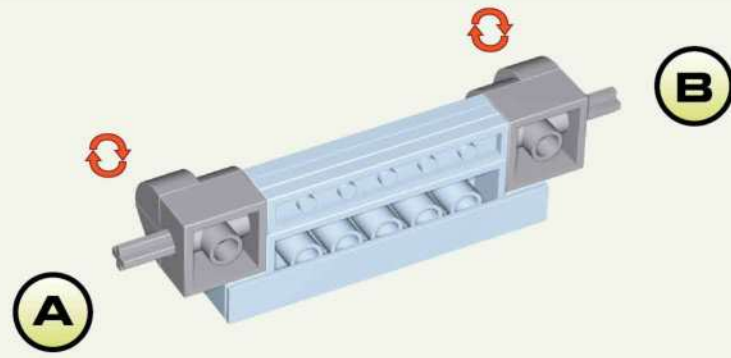

114

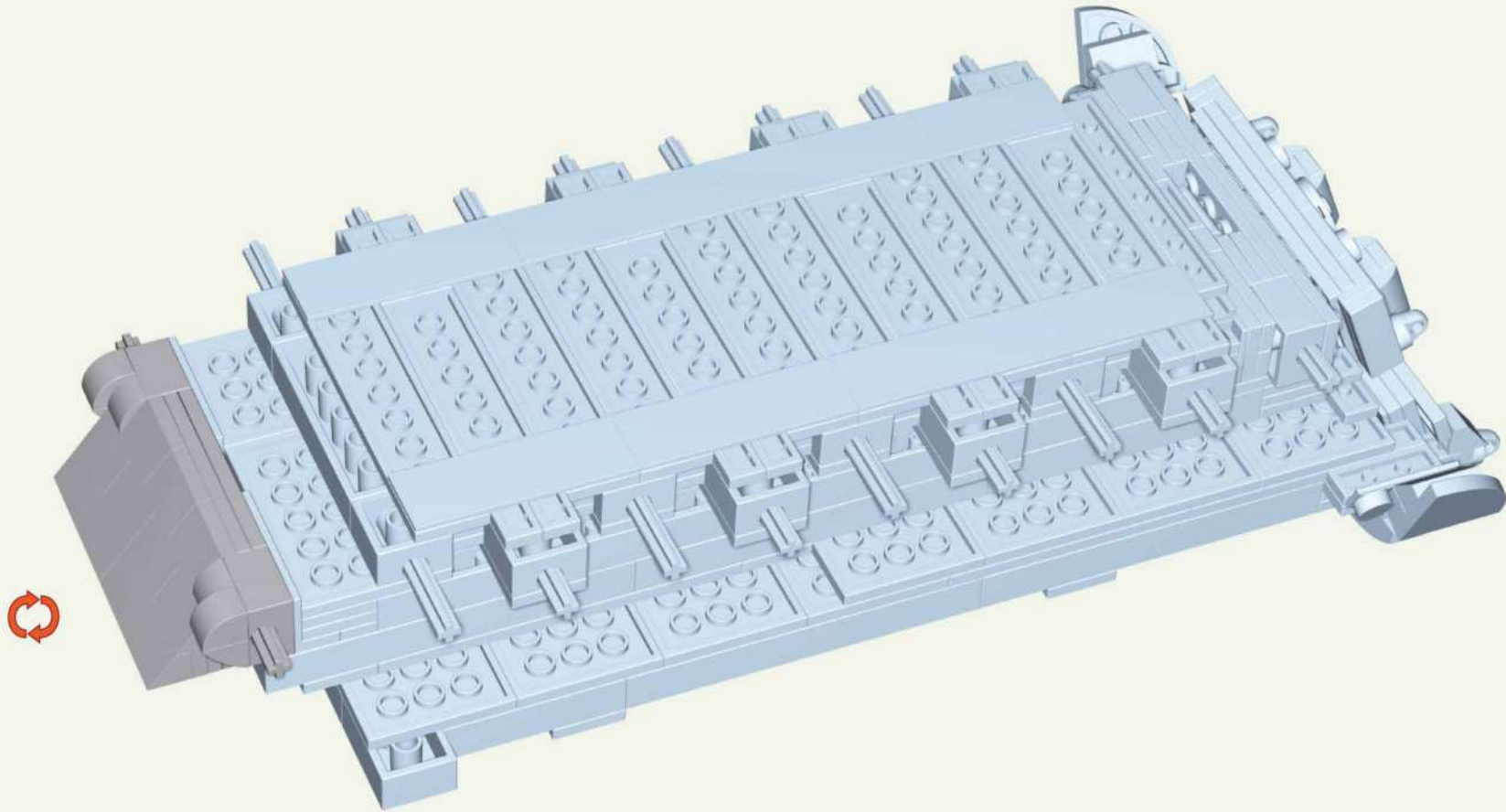

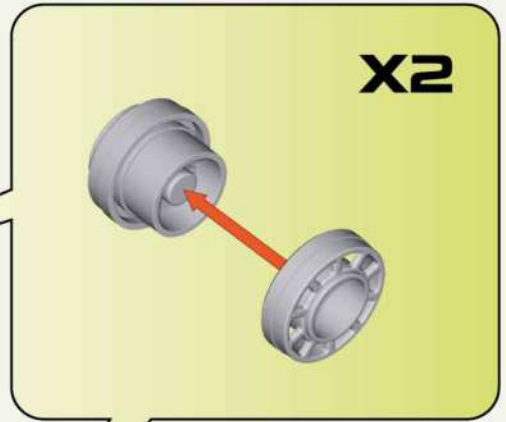
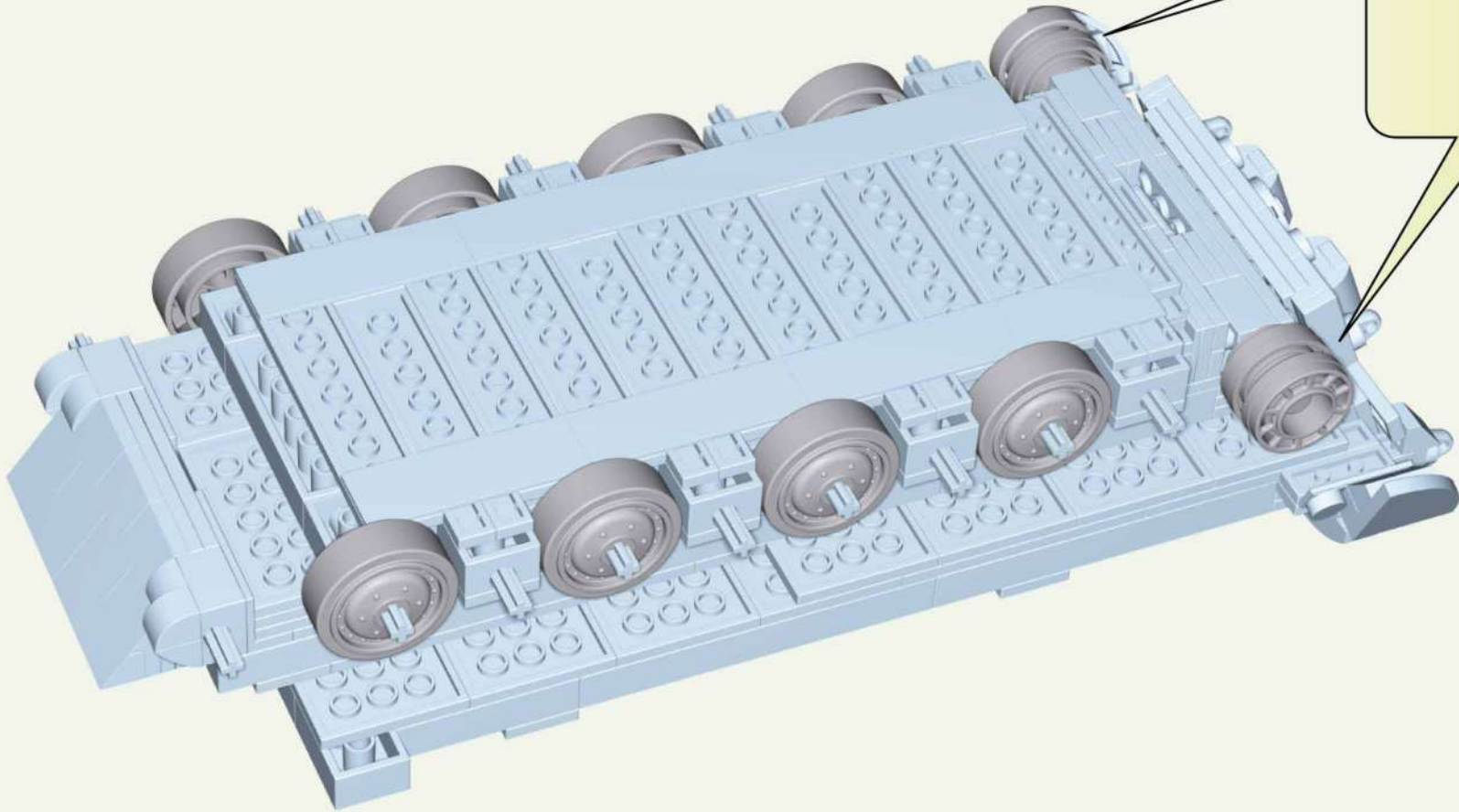

x8



x2



x2

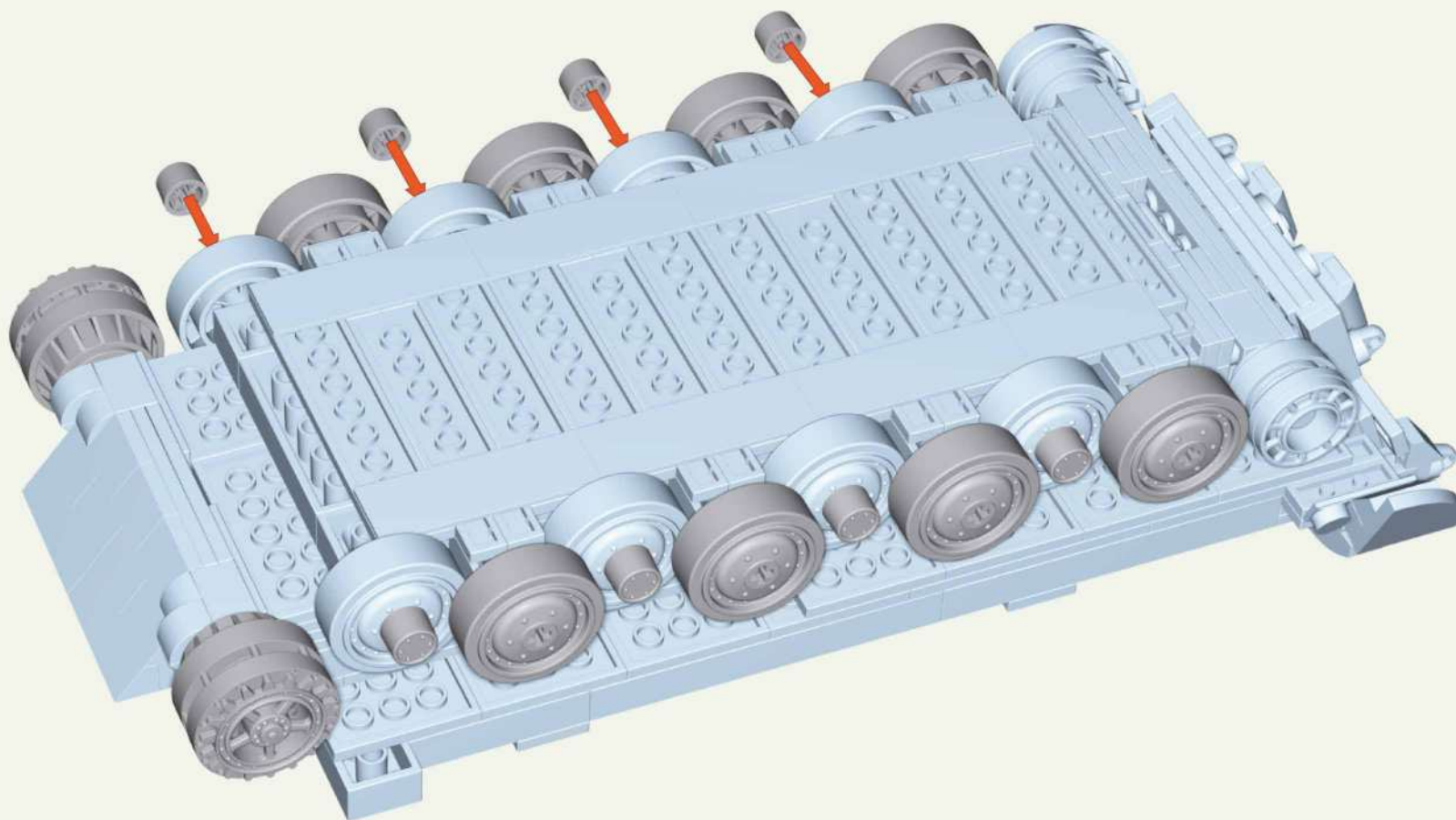
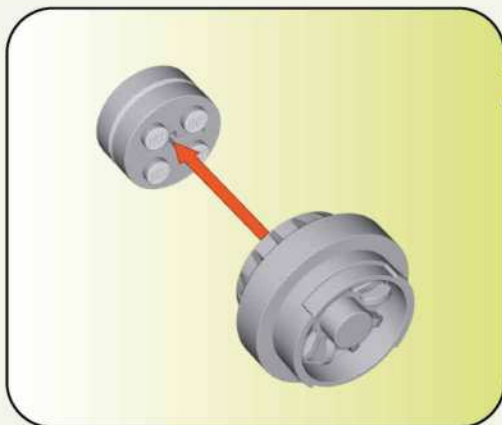

117

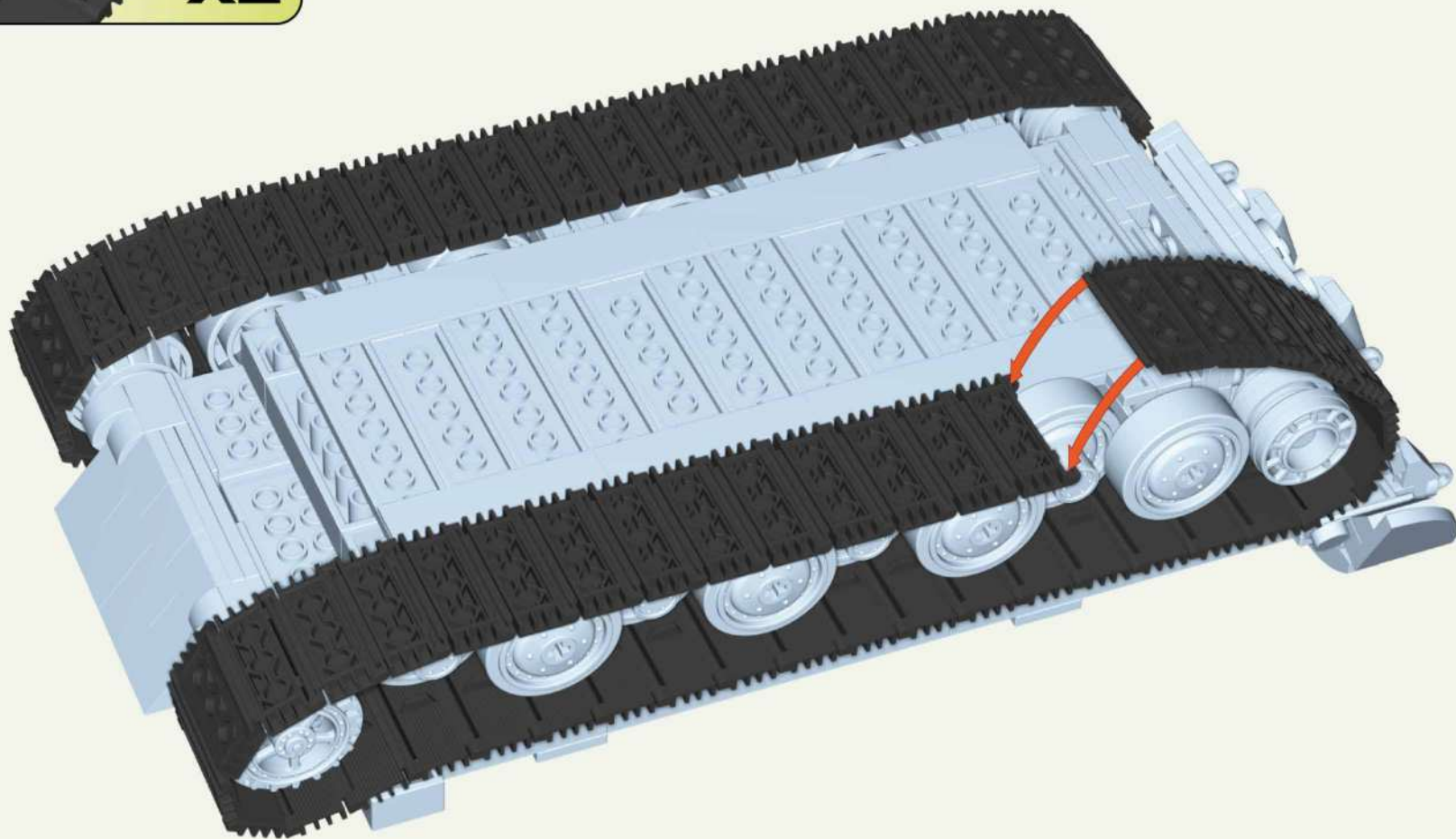
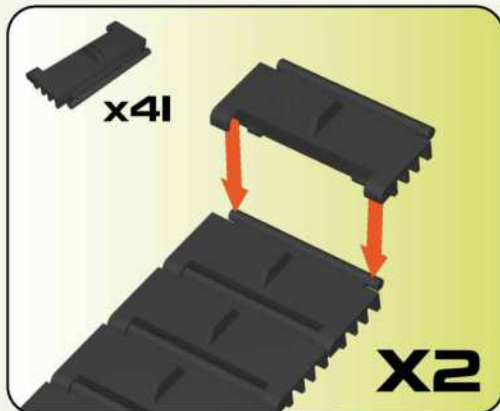

x82



118

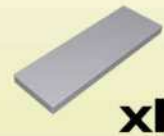
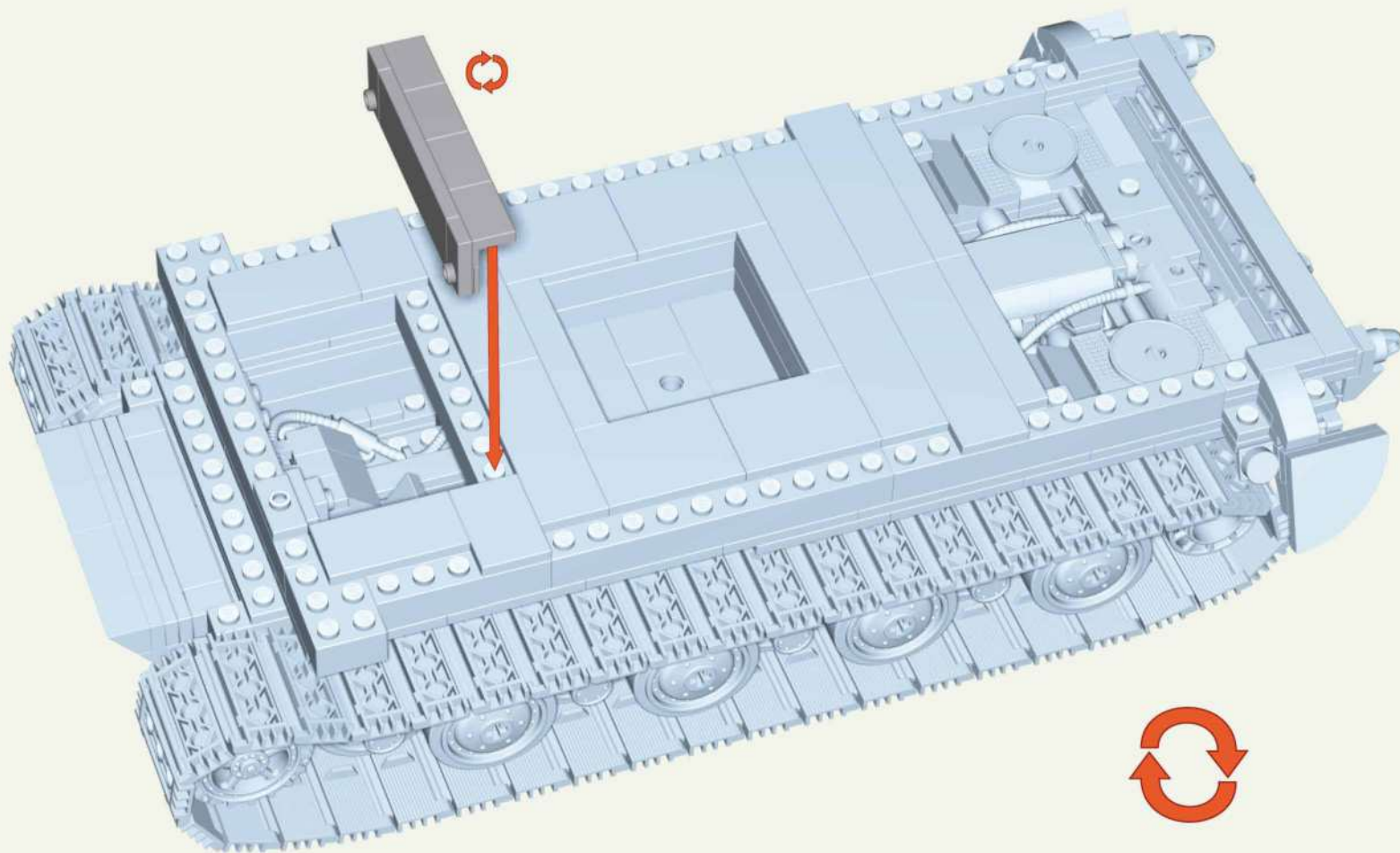
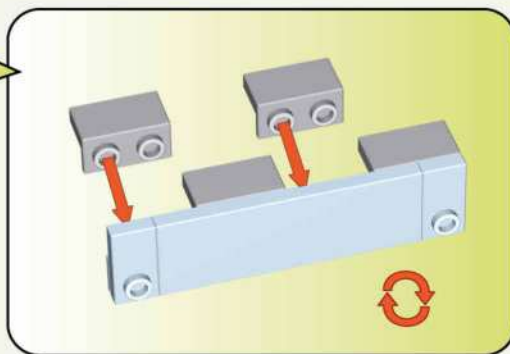
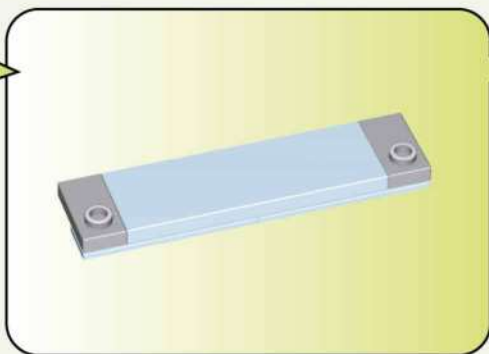
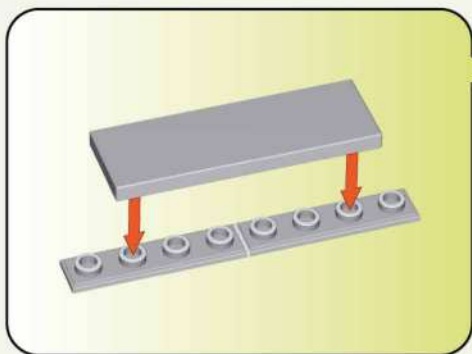

119

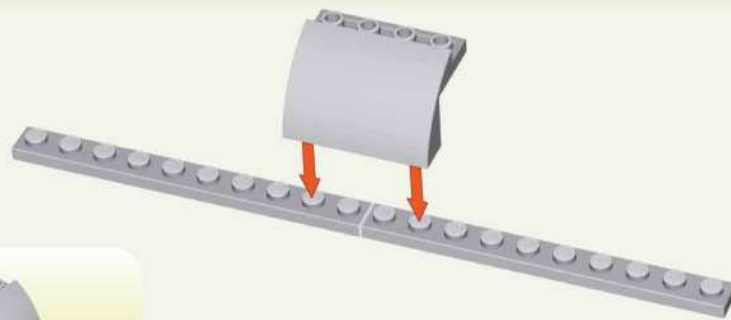
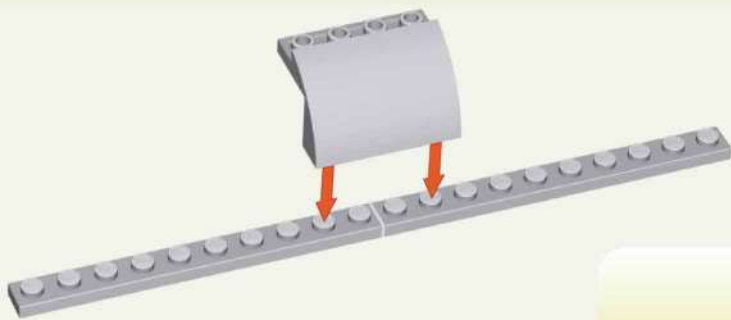

120

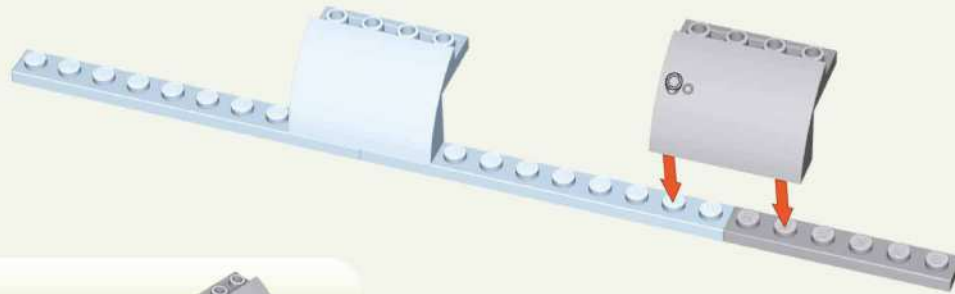
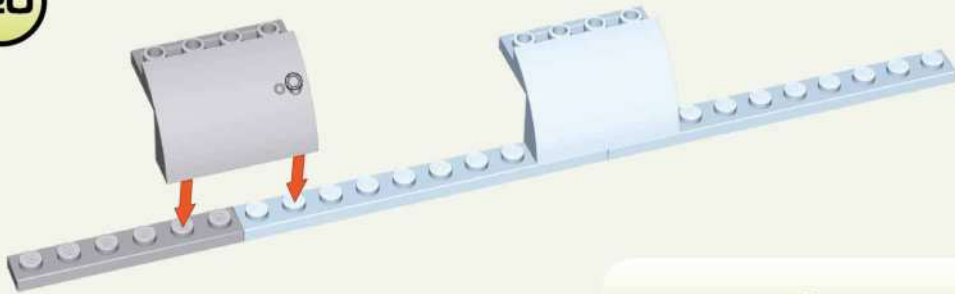

121

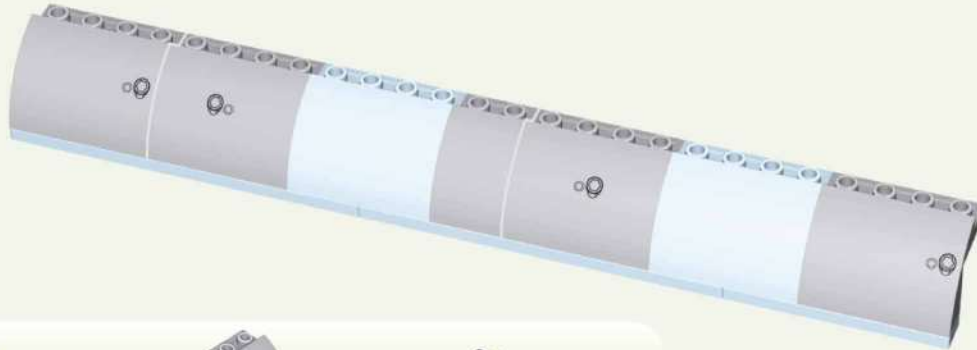

122

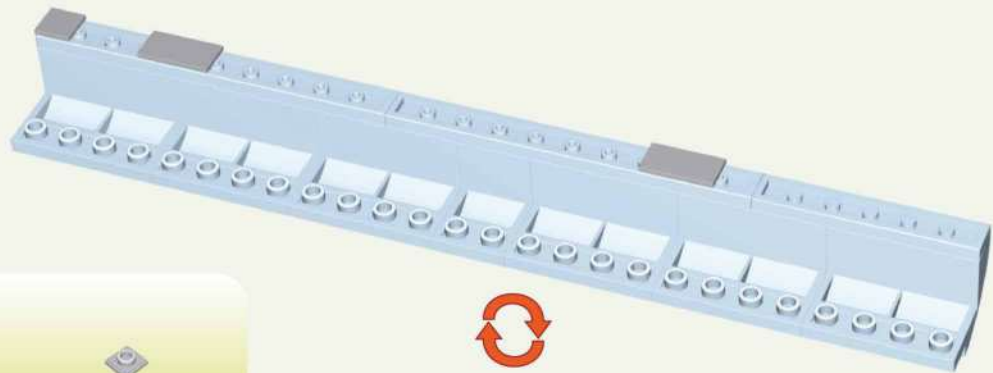

x4

x2

123

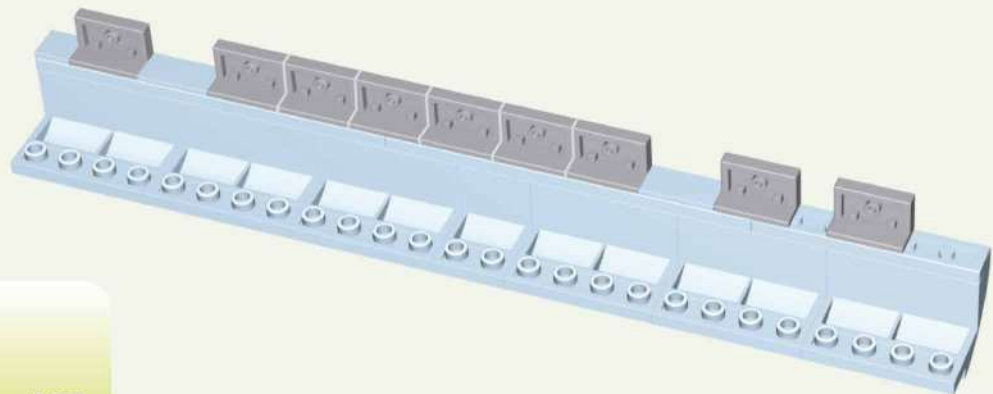
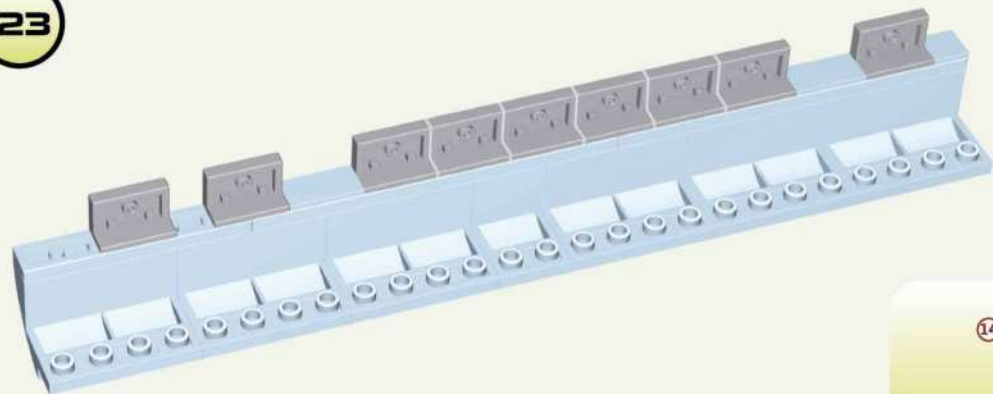

14

x18

124

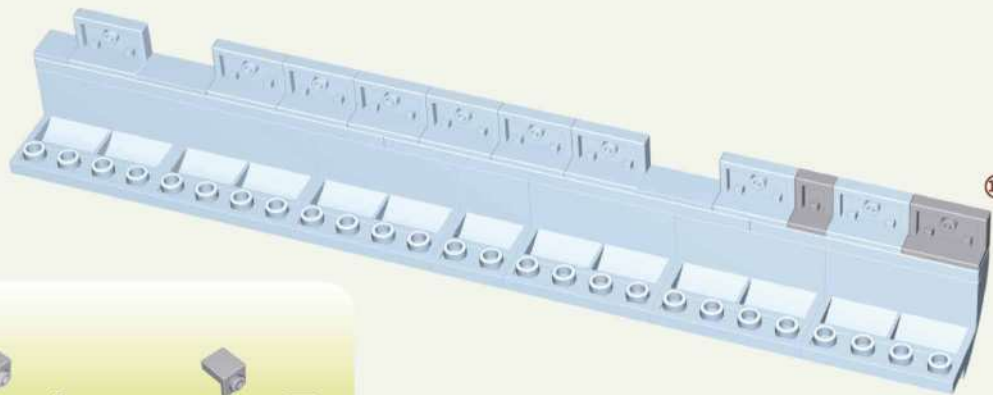
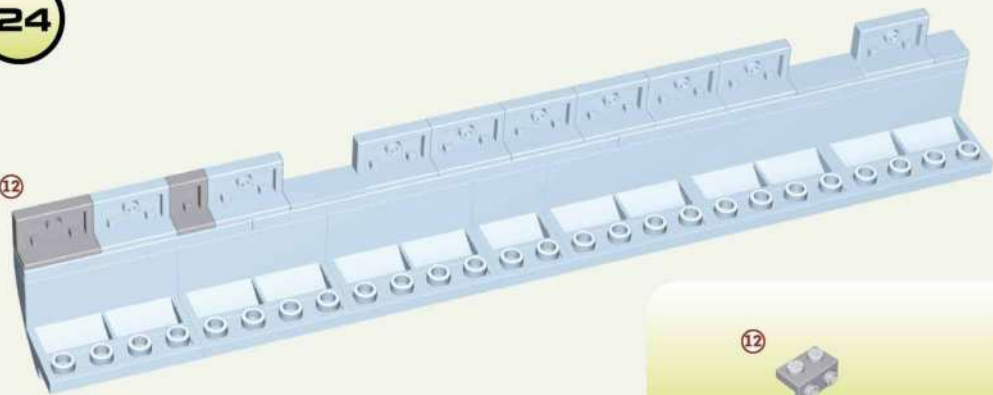

12

x1

14

x1

x2

125

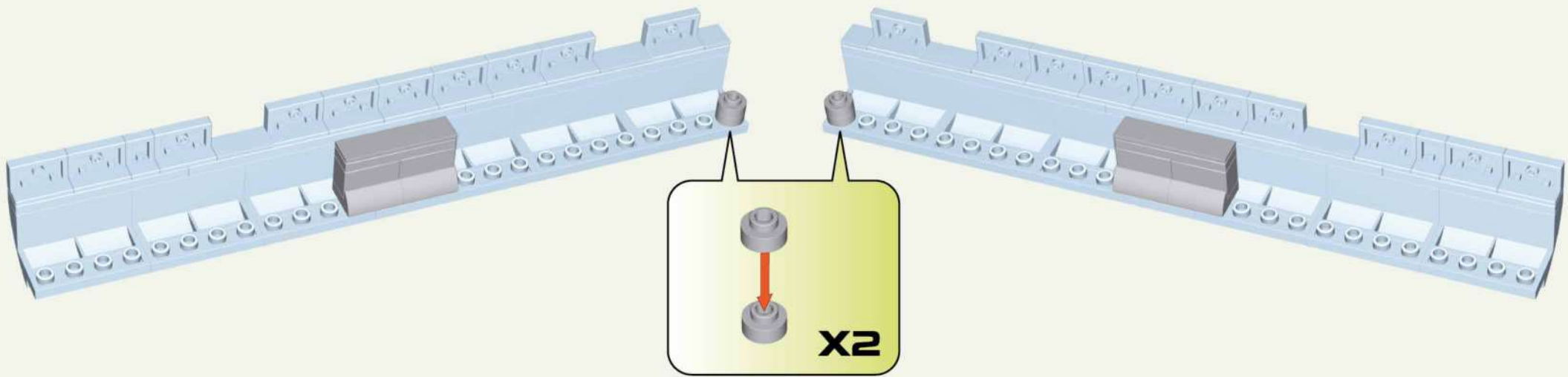
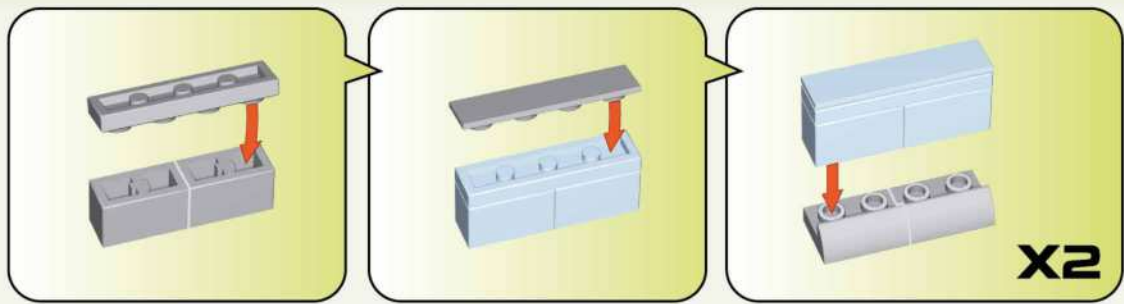

126

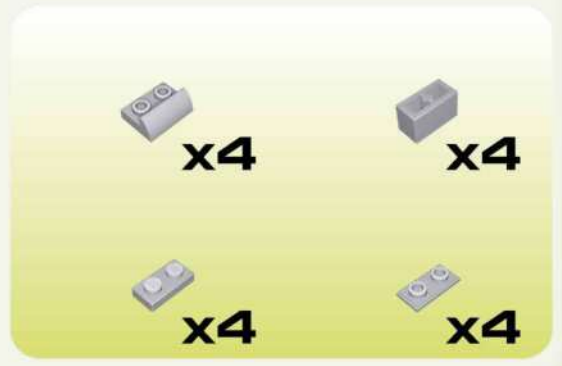
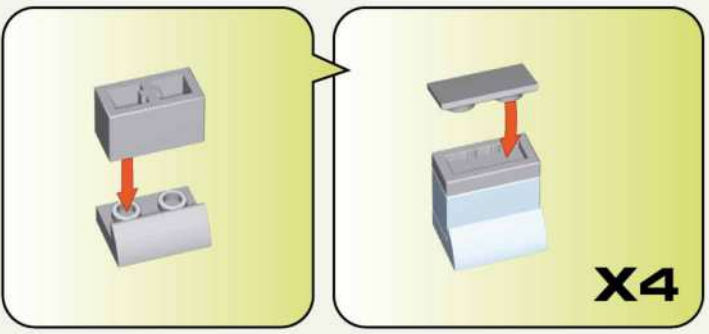

127

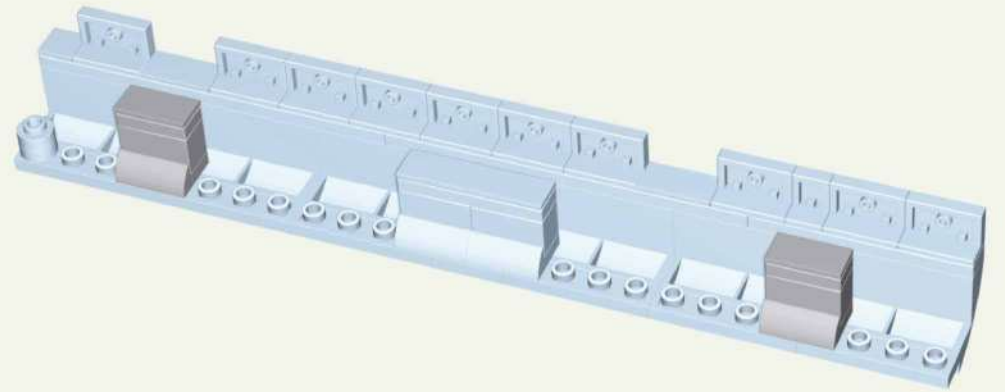
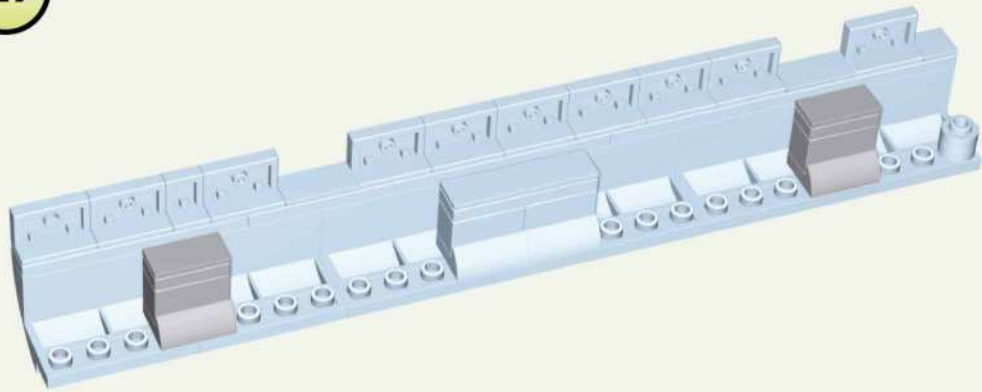

128

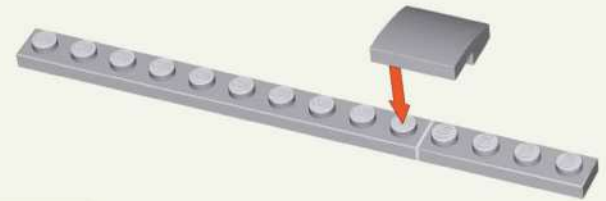
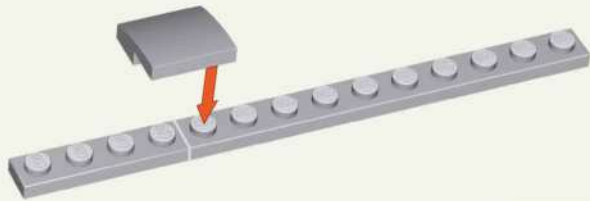

129

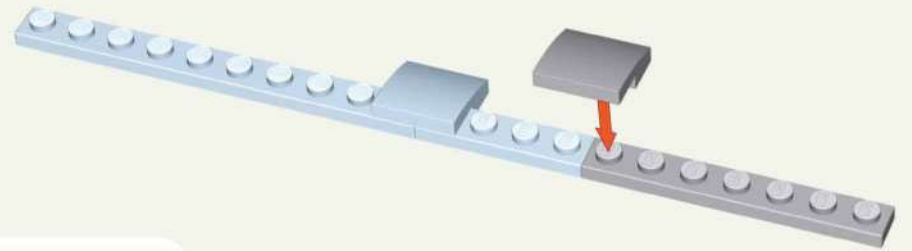
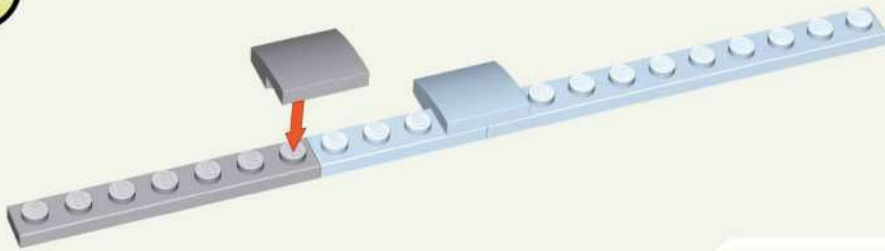

130

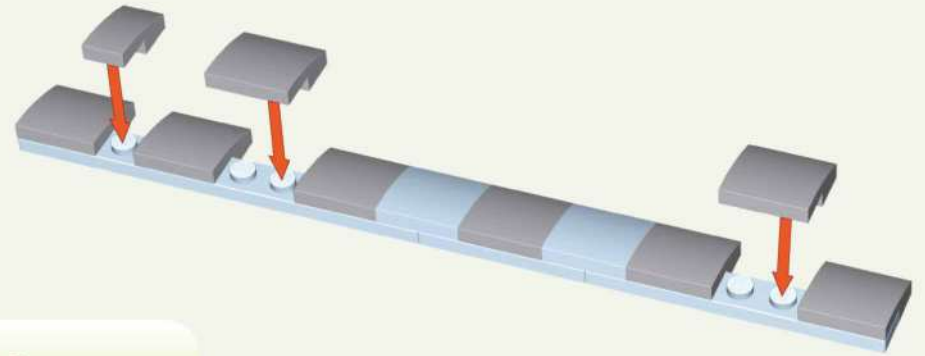
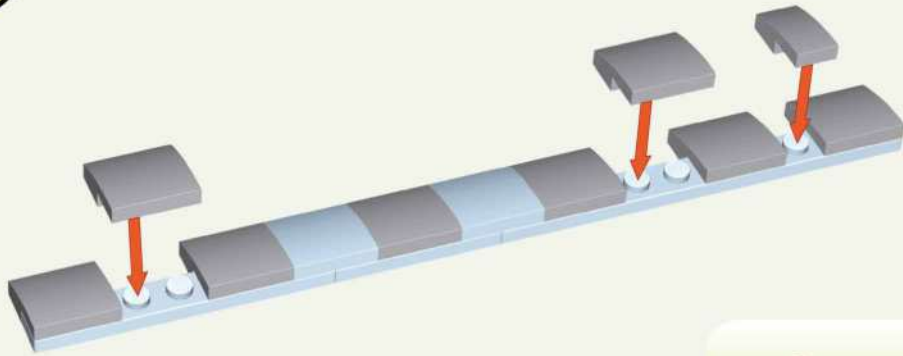

⑧ x16 ⑤ x2

131

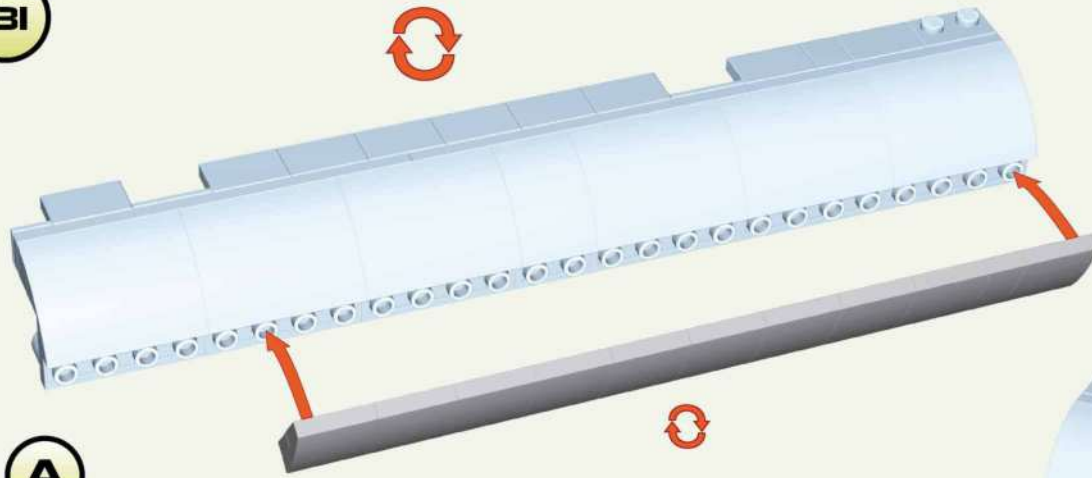

A

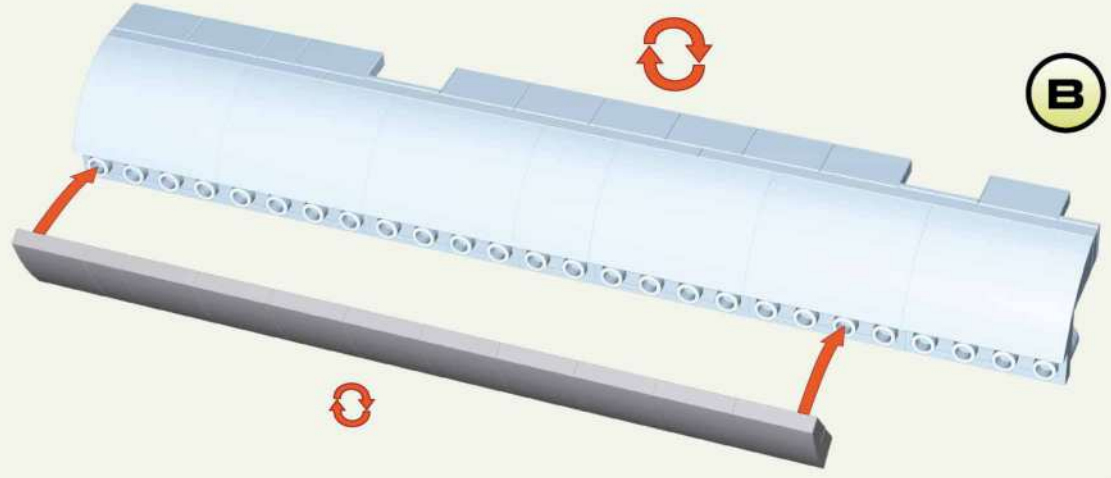

B

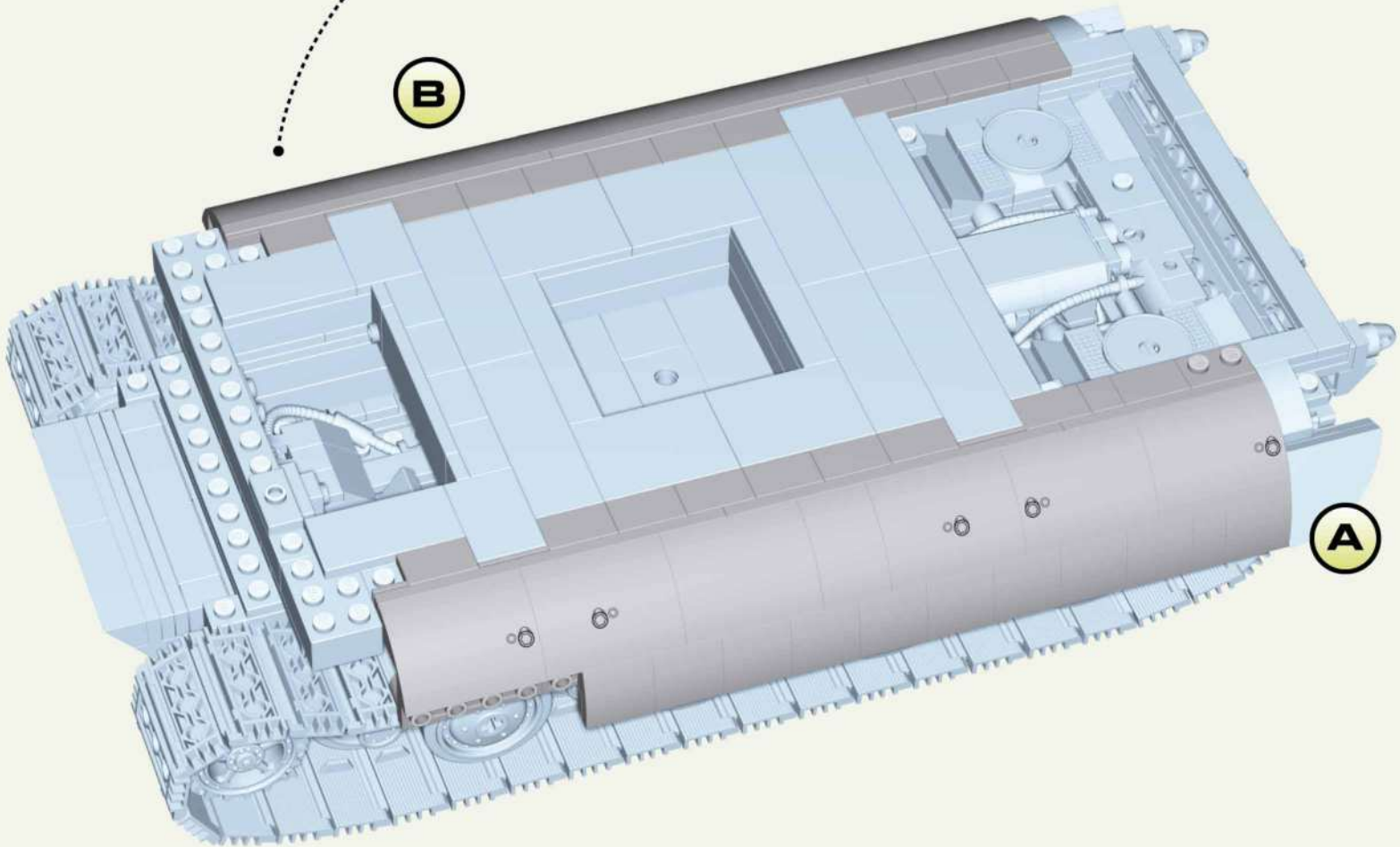
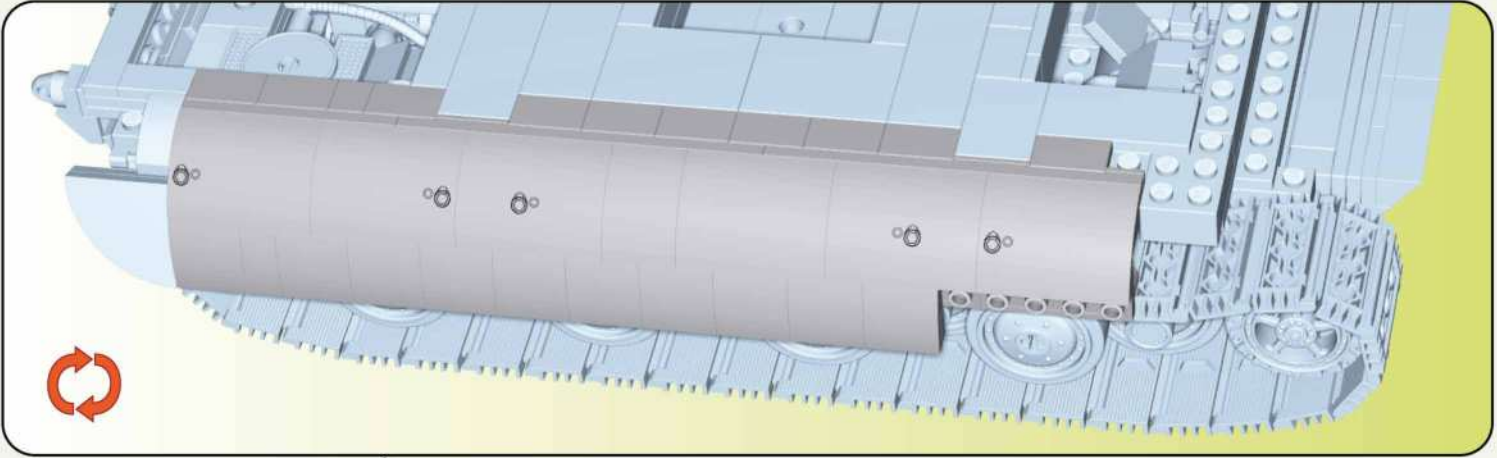

133

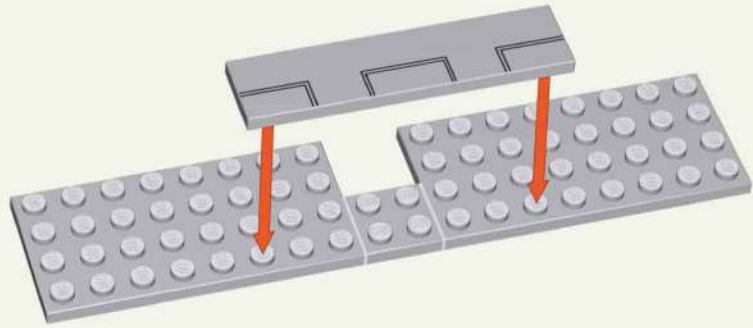

x2



x1

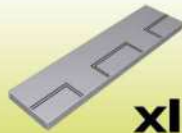

x1

134

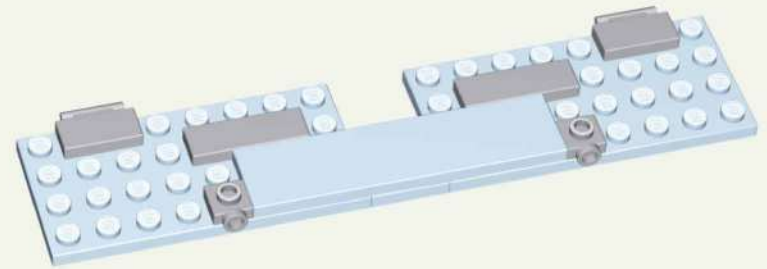

x2



x2



x2

1:1

135

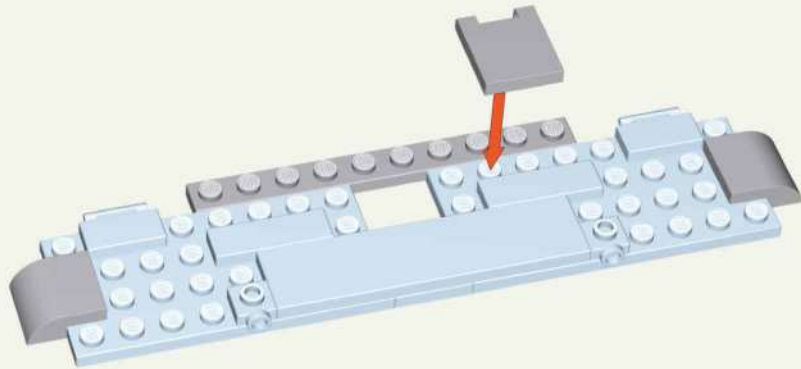

x1



x1

7



x2

136

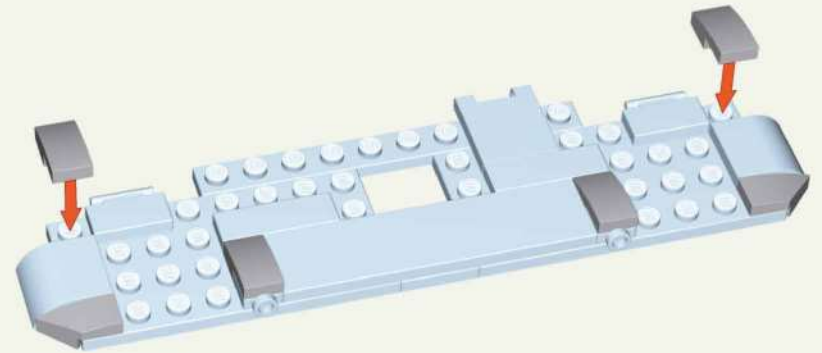

5



x4



x1



x1

137

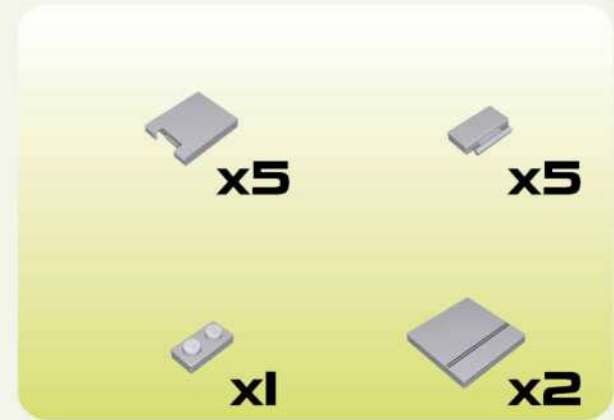
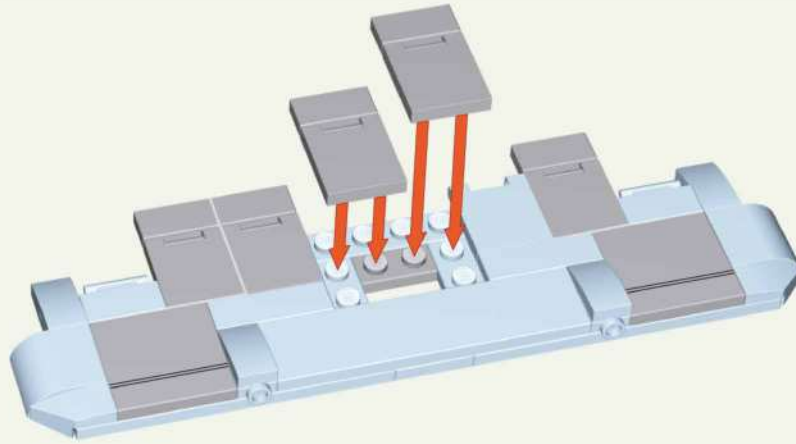
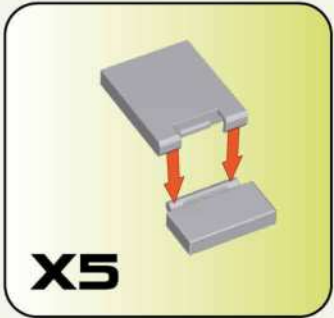

138

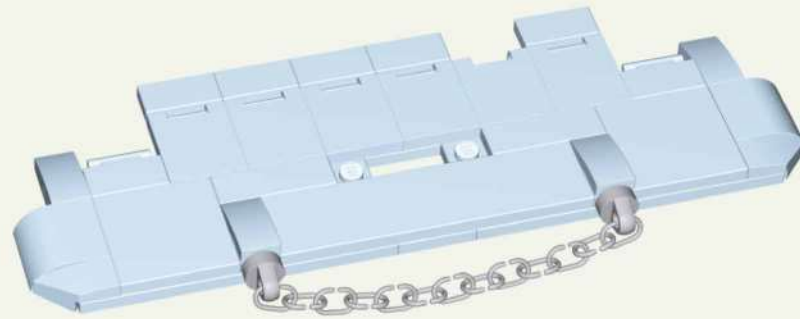
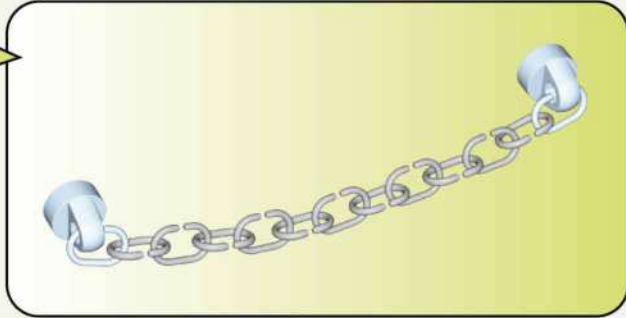

139

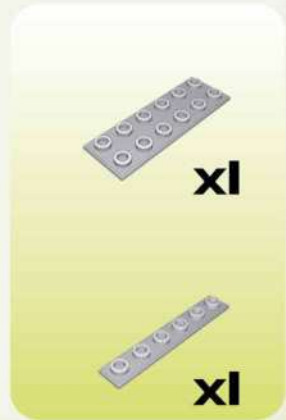
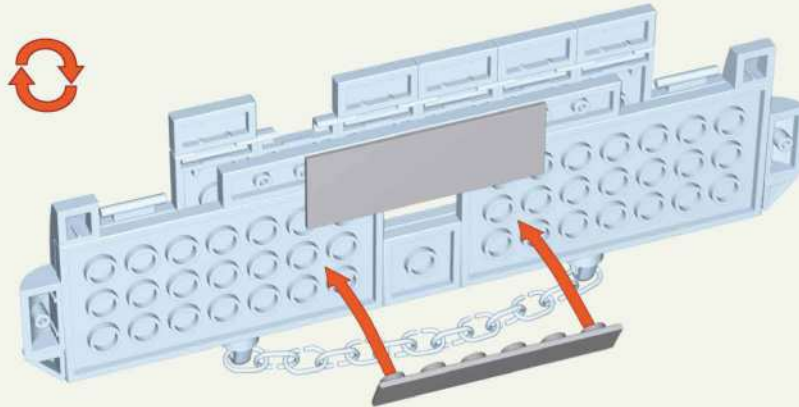

140

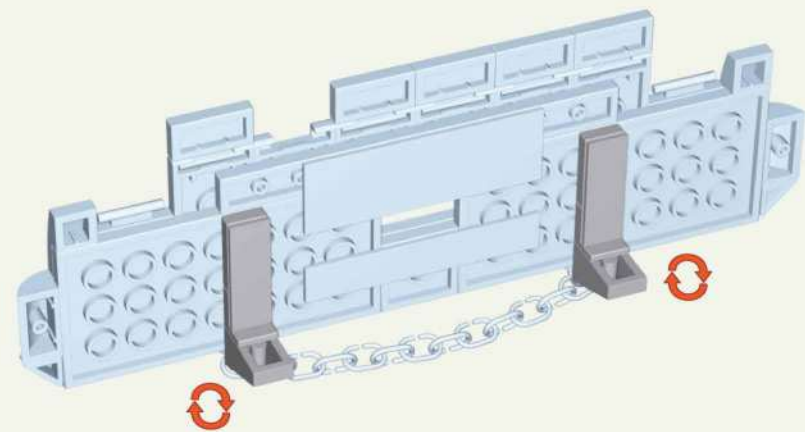
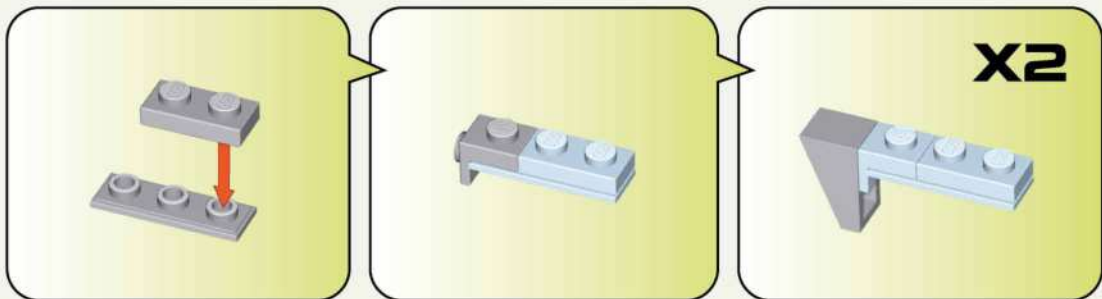

141

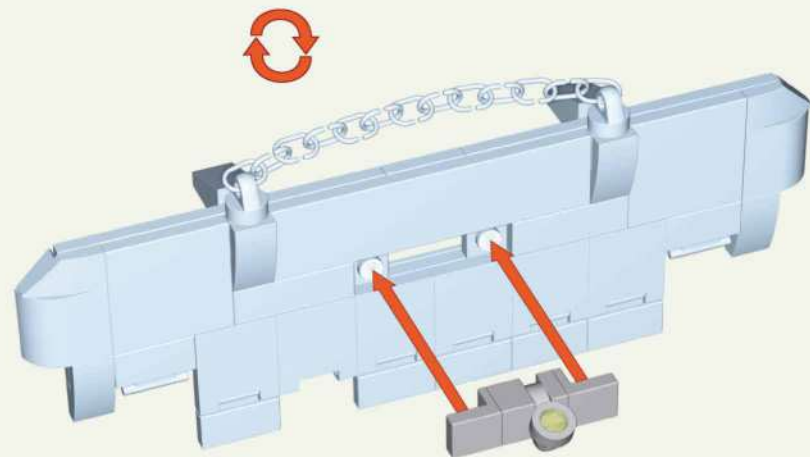
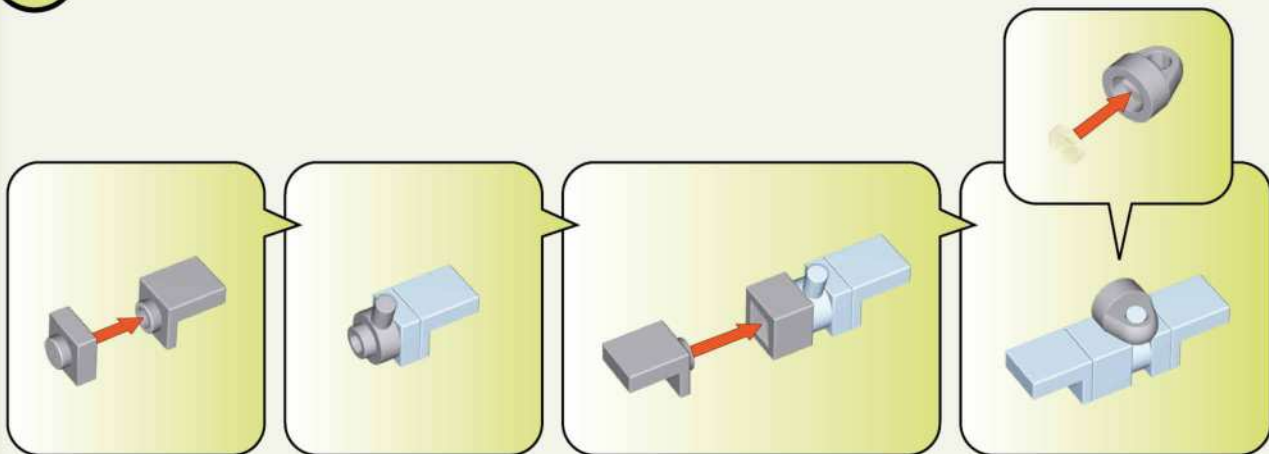

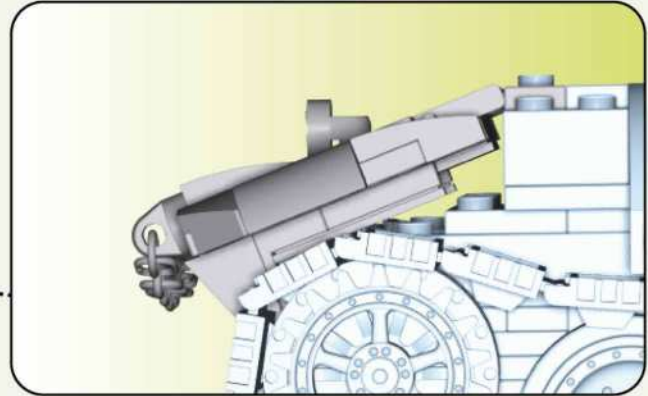
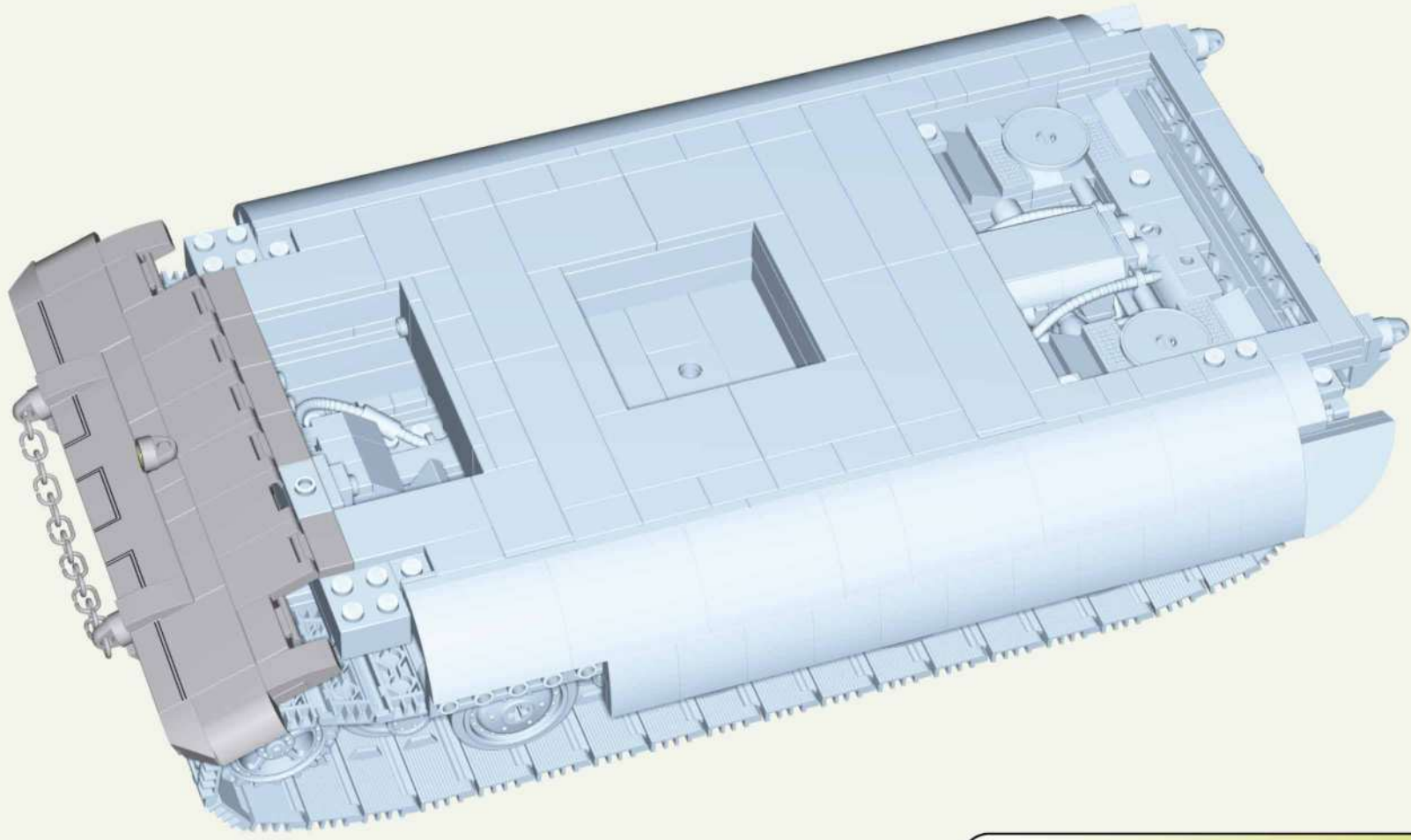

A

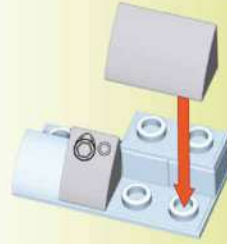
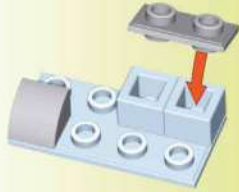
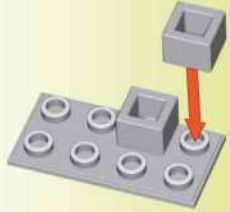

B

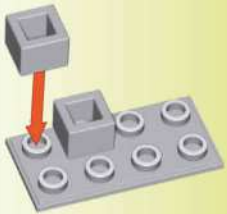

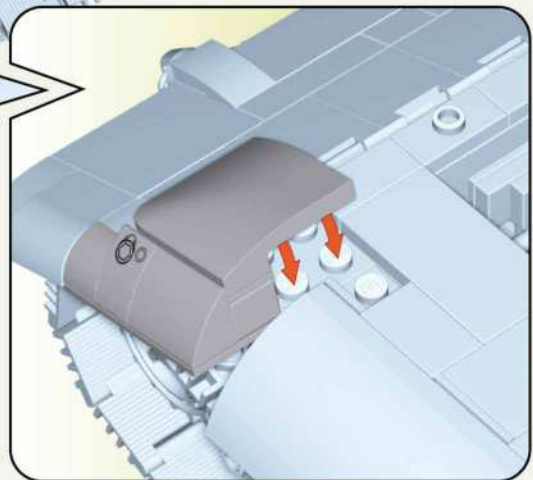
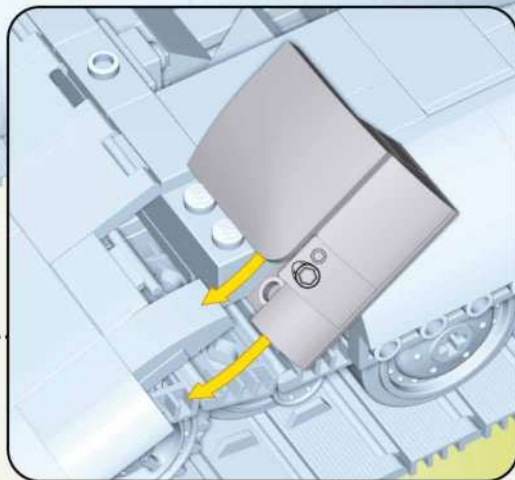
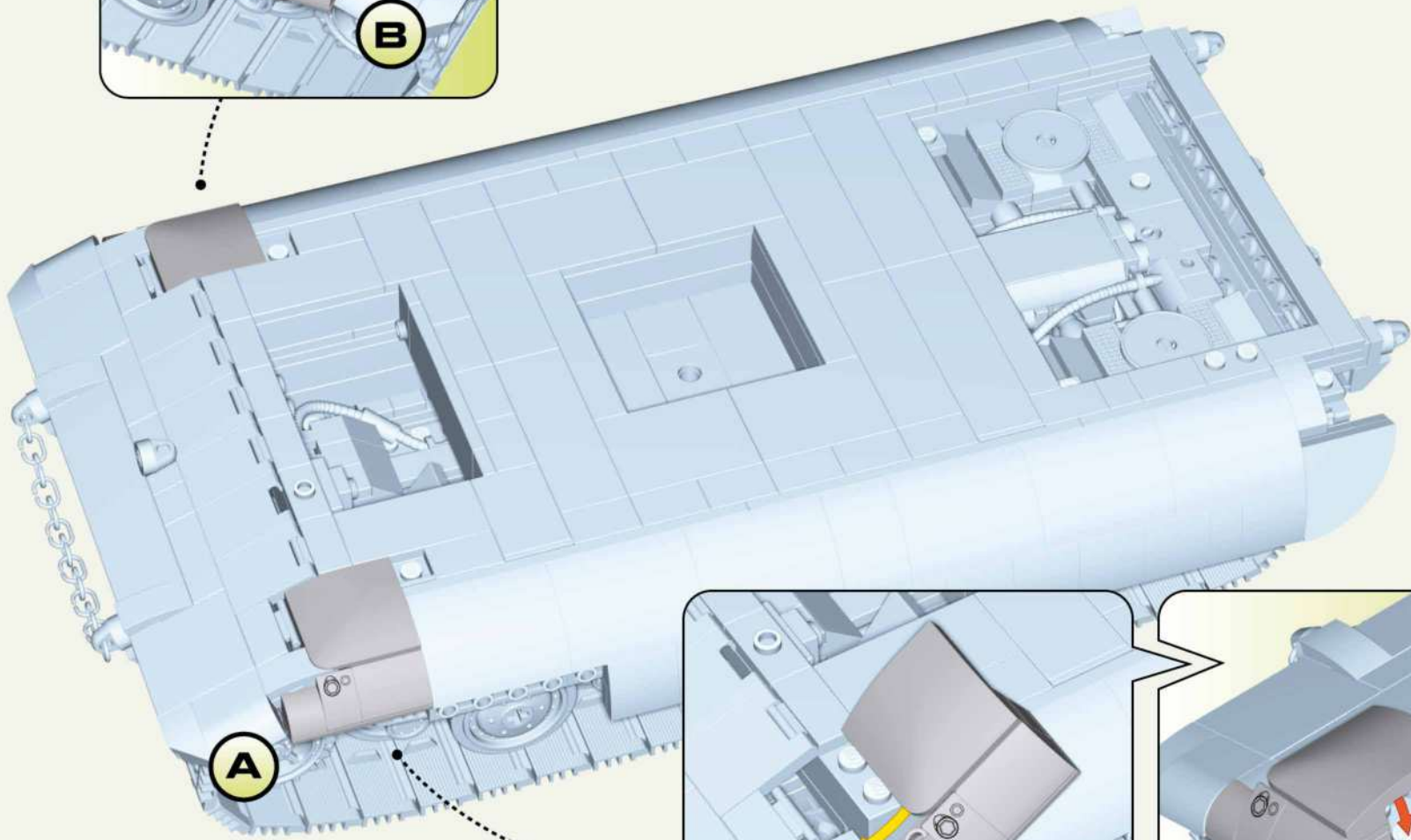
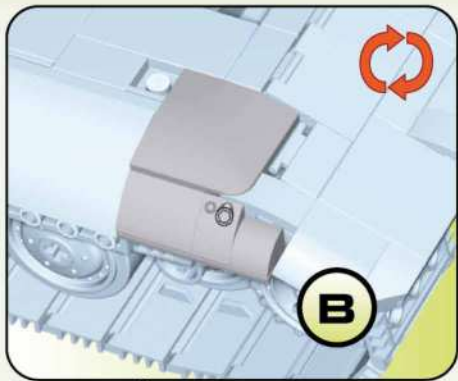

145

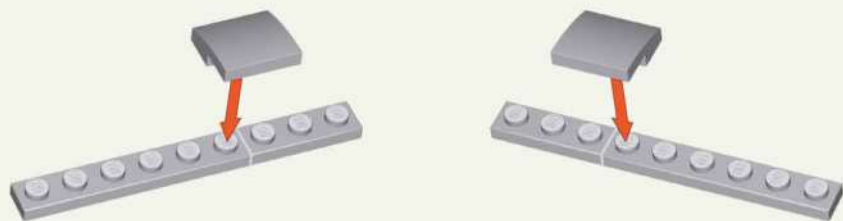

146

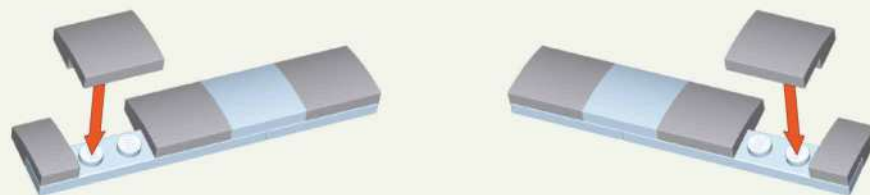

147

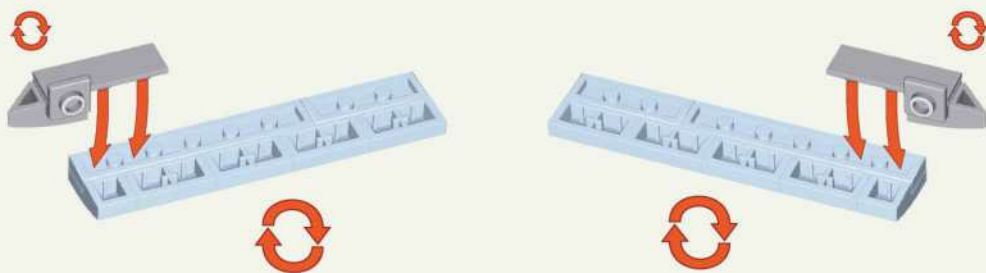
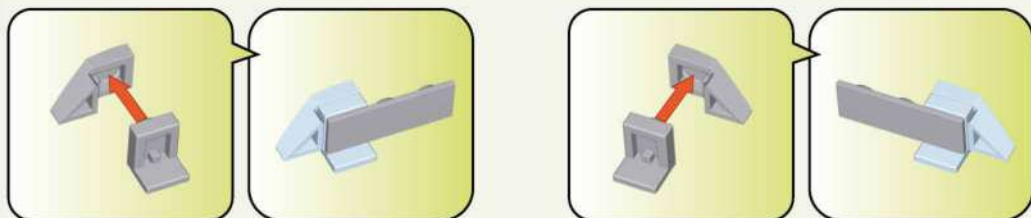

148

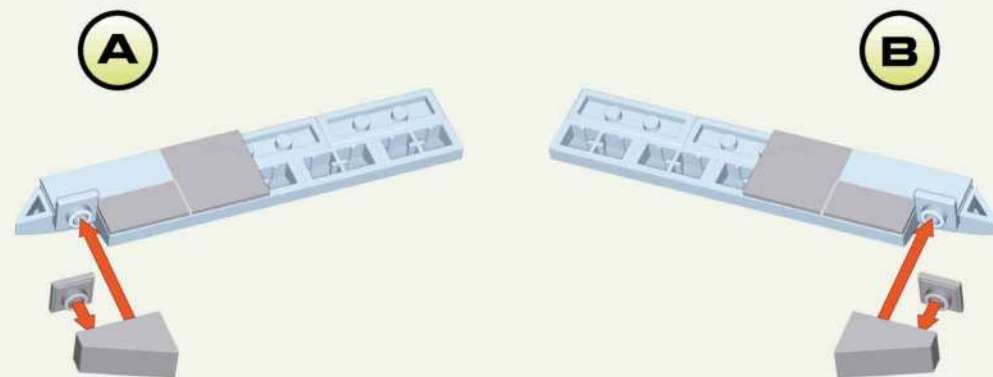

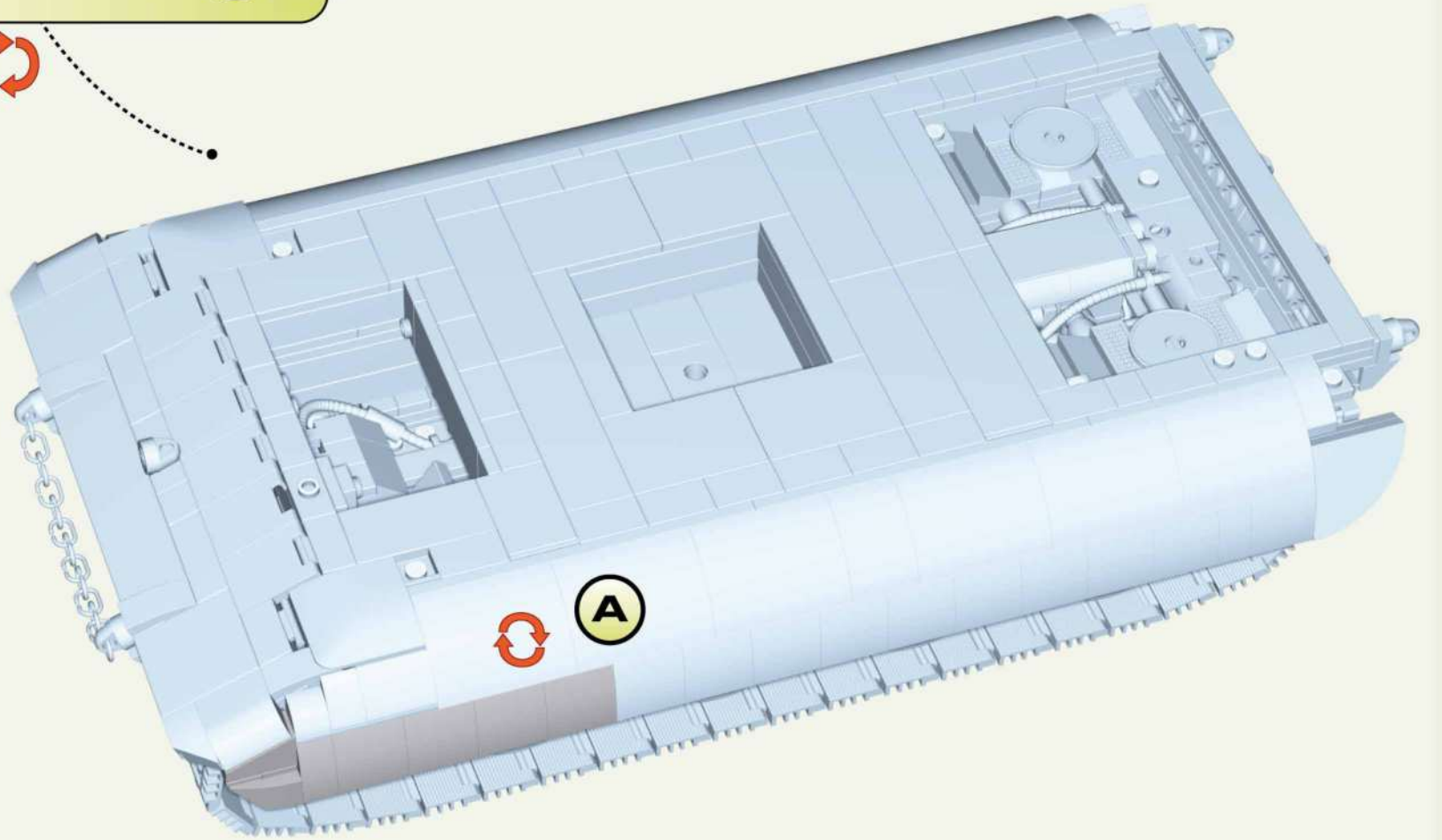
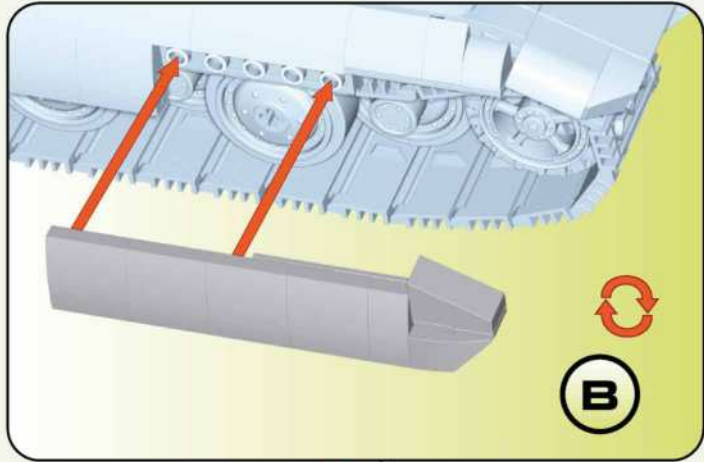

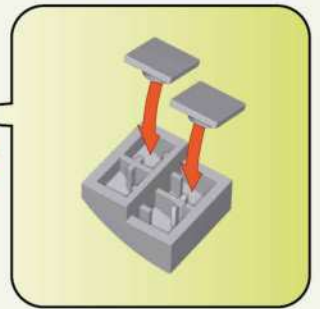
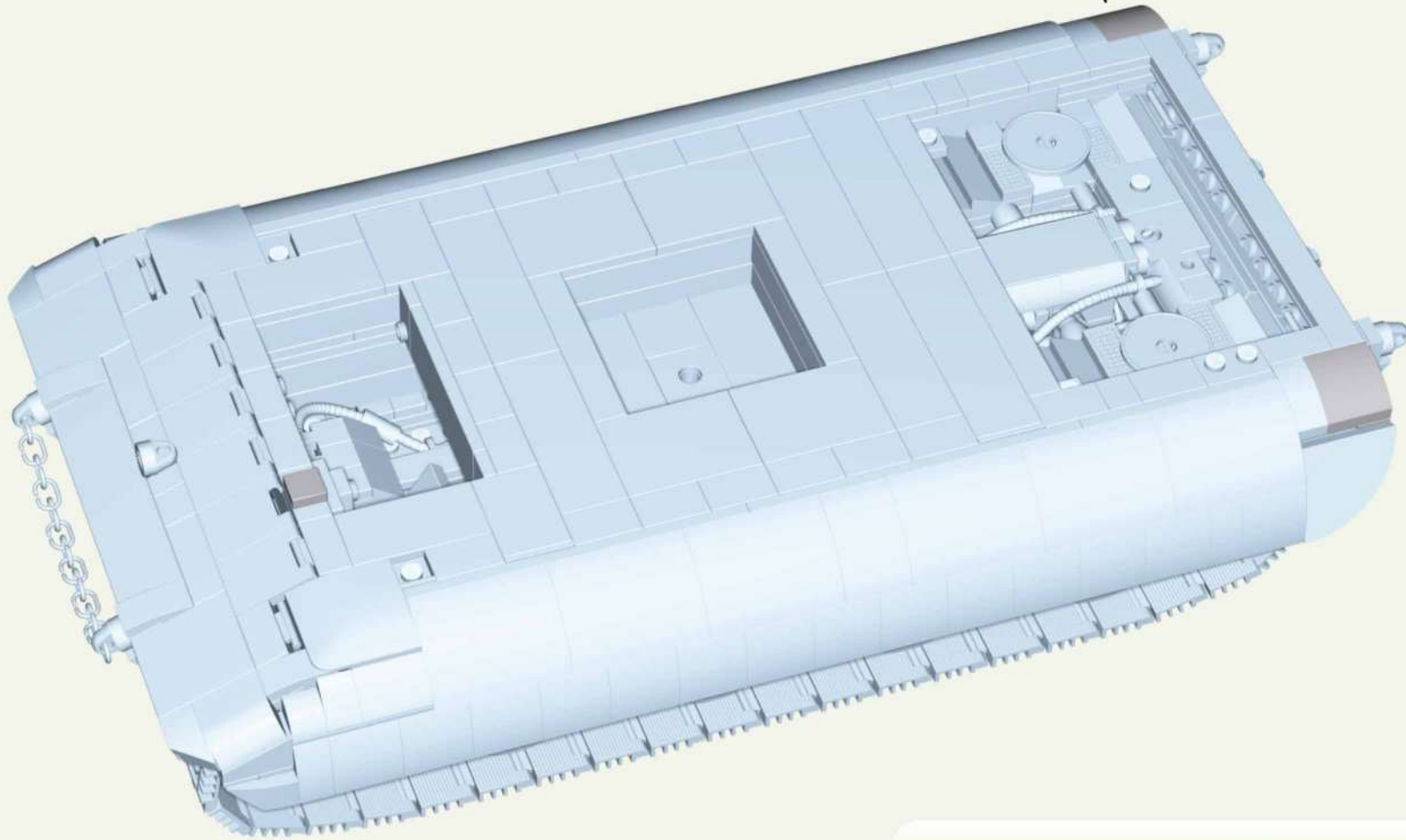
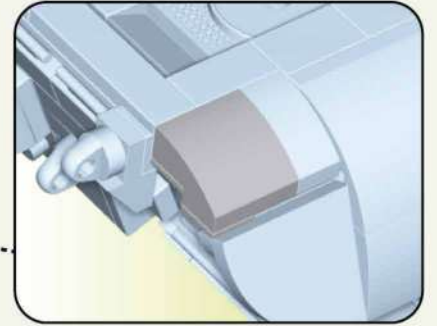
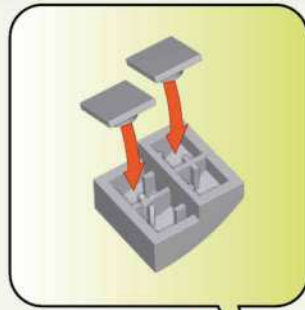

x1



x2



x4

151

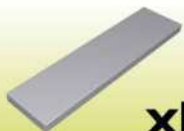
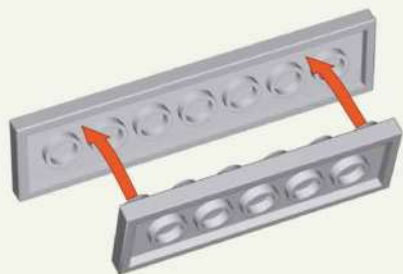

x1



x1

152

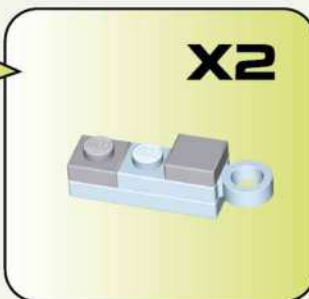
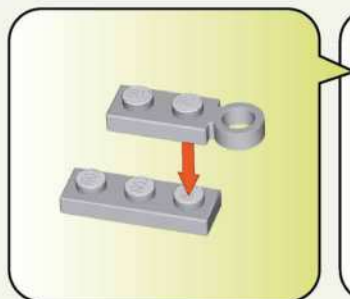

x2

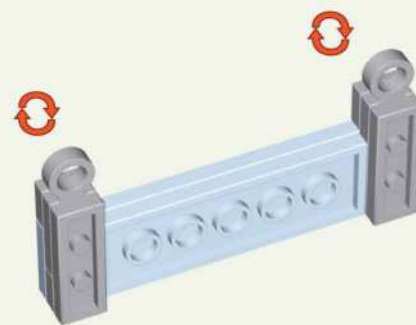

x2



x2



x2



x2

153

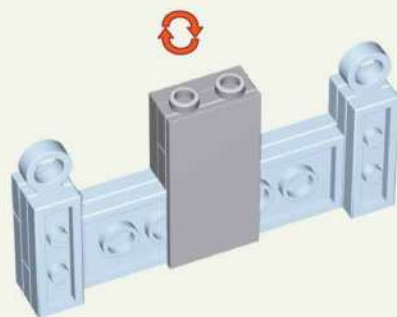
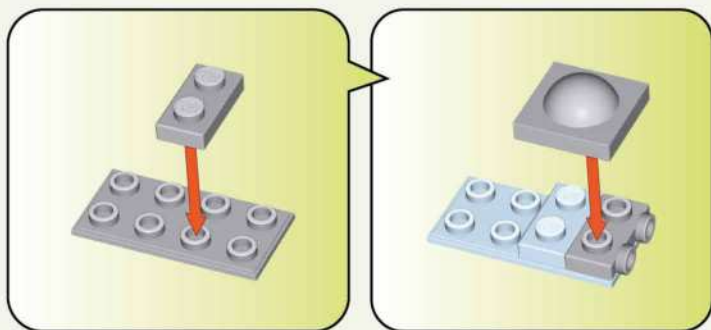

x1



x1



x1



x1

154



x2

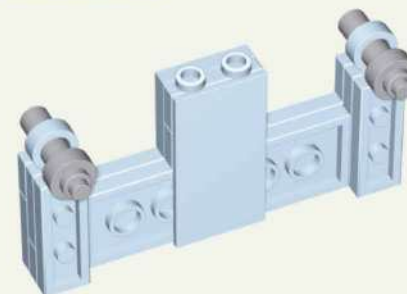







x2

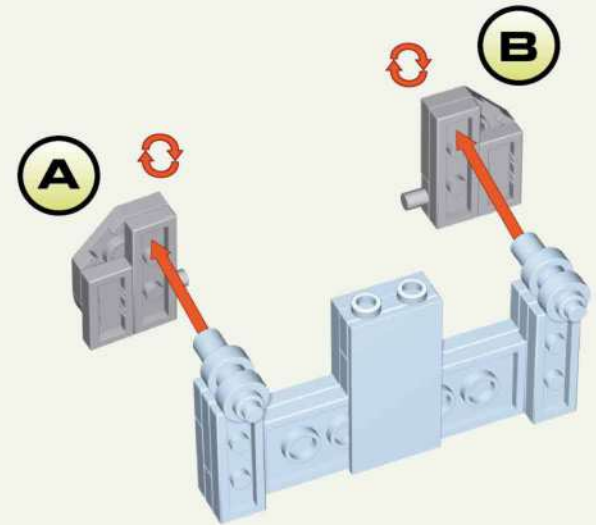
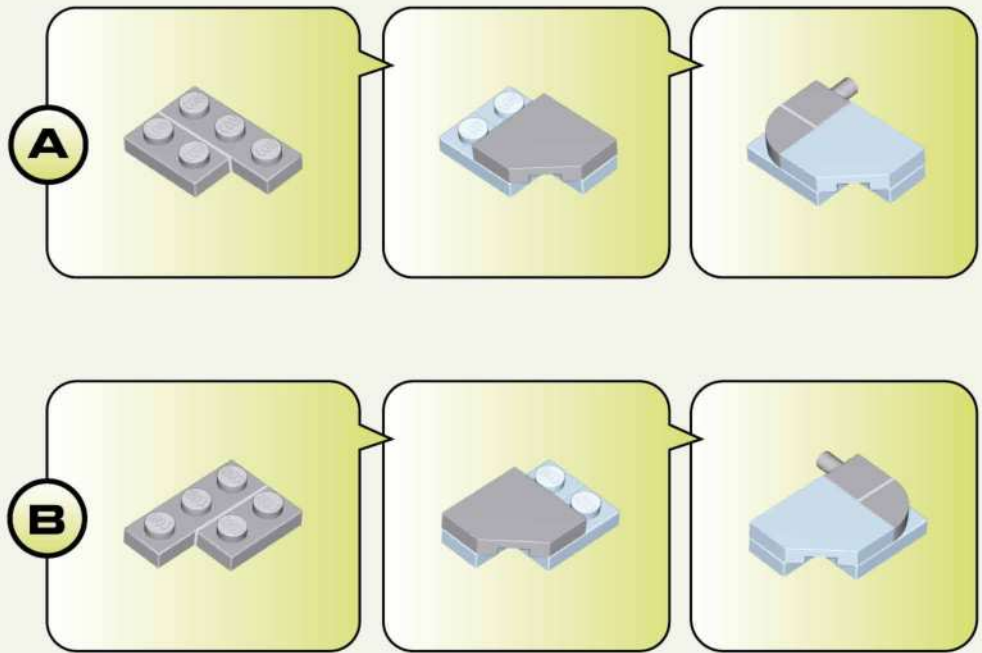

x2

155



-  x2
-  x2
-  x2
-  x2
-  x2

156

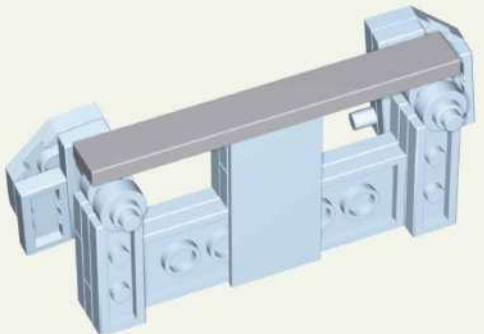

157

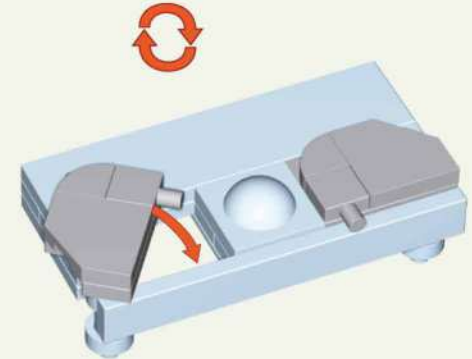

158

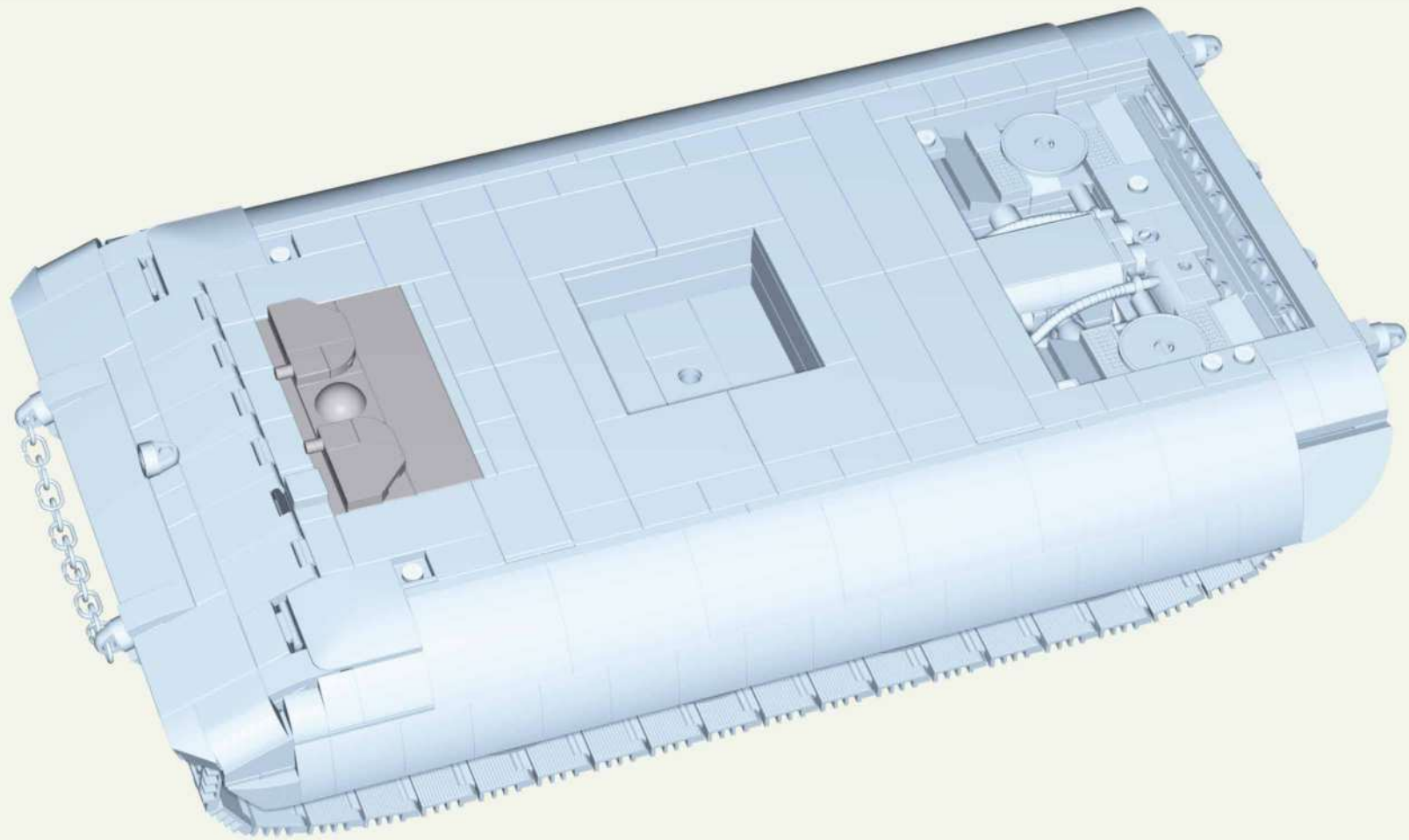

159

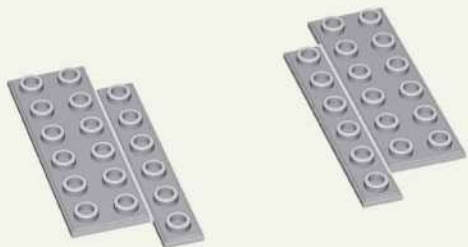

x2



x2

160

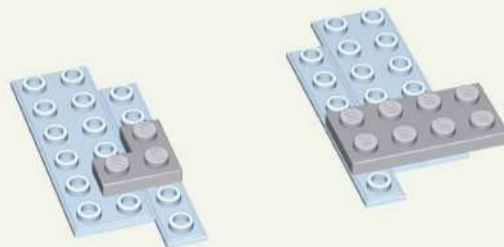

x1



x1

161

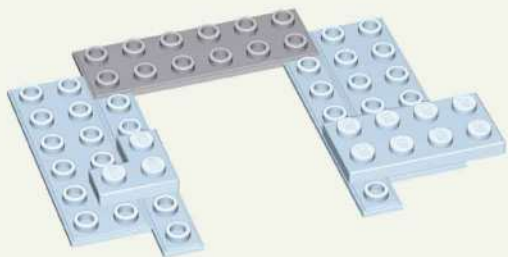

x1

162

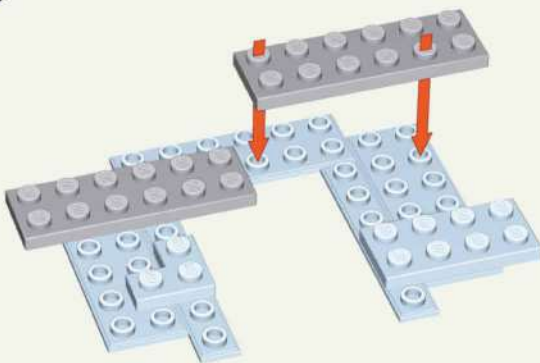

x2

163

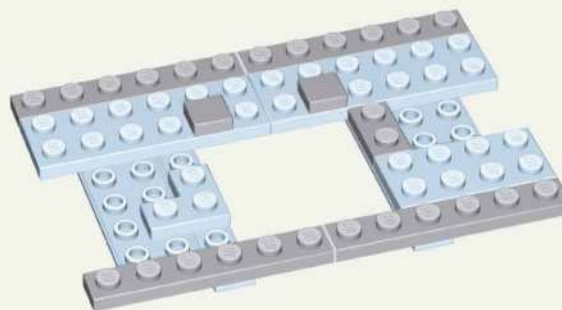

x4



x2



x1

164

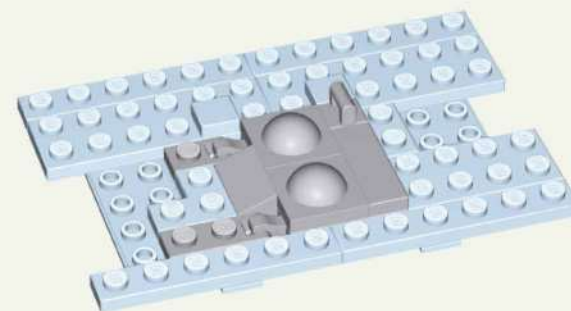
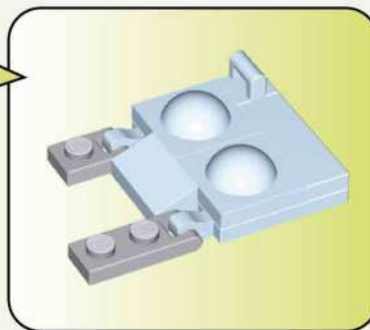
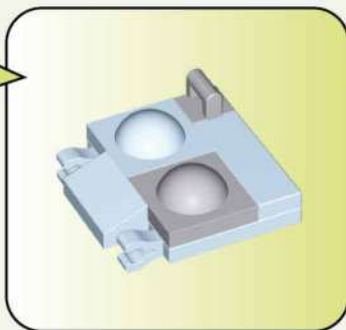
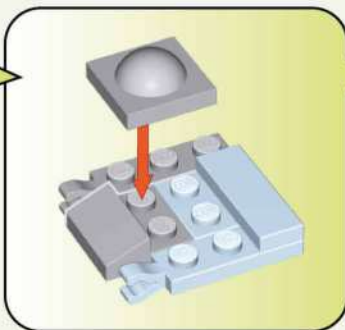
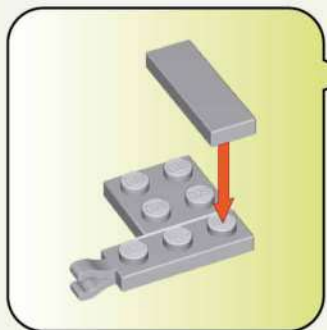

1:1



x1



x2



x1



x1



x2



x1



x1



x1

165

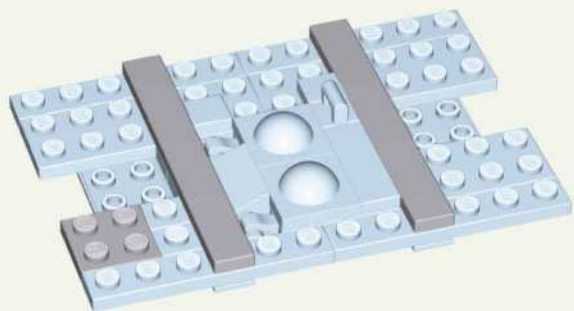

1:1



x1



x2

166

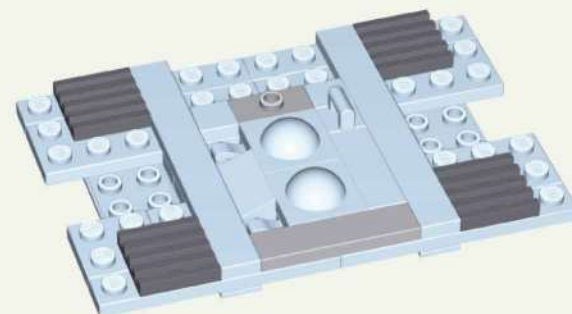

1:1



x4



x1



x1

167

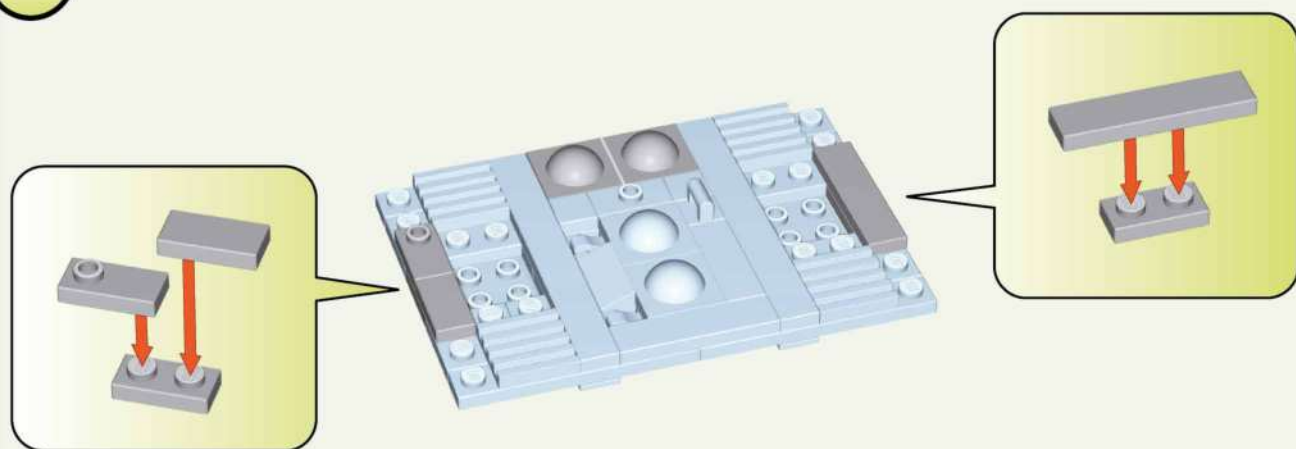

1:1



x2



x1



x1



x2



x1

1:1

168

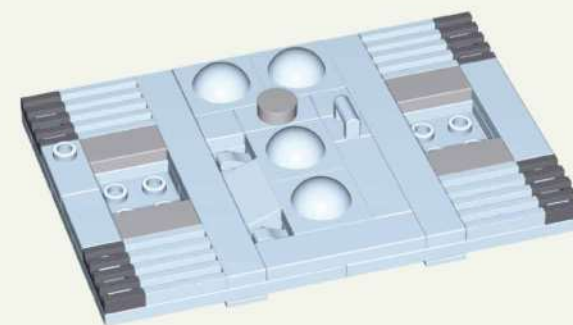

1:1



x4



x4



x1

169

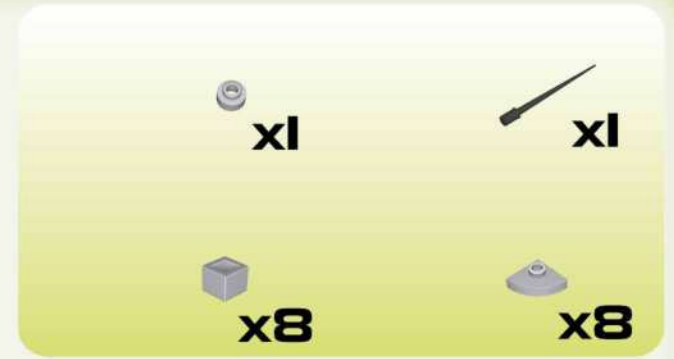
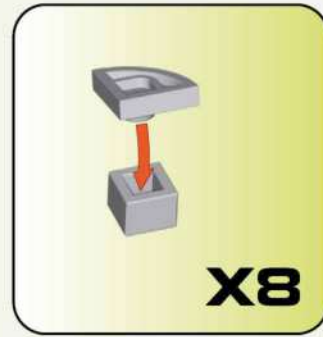
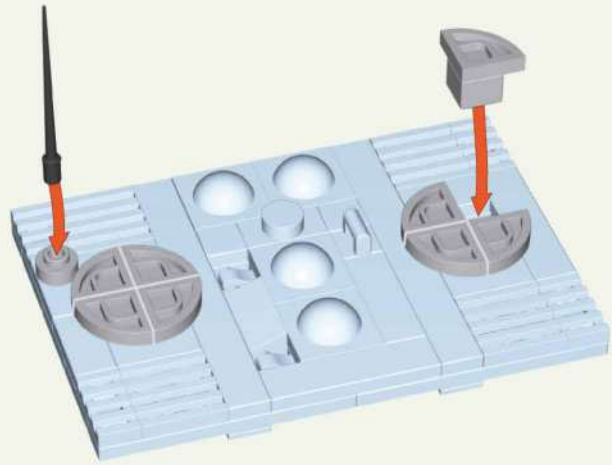

170

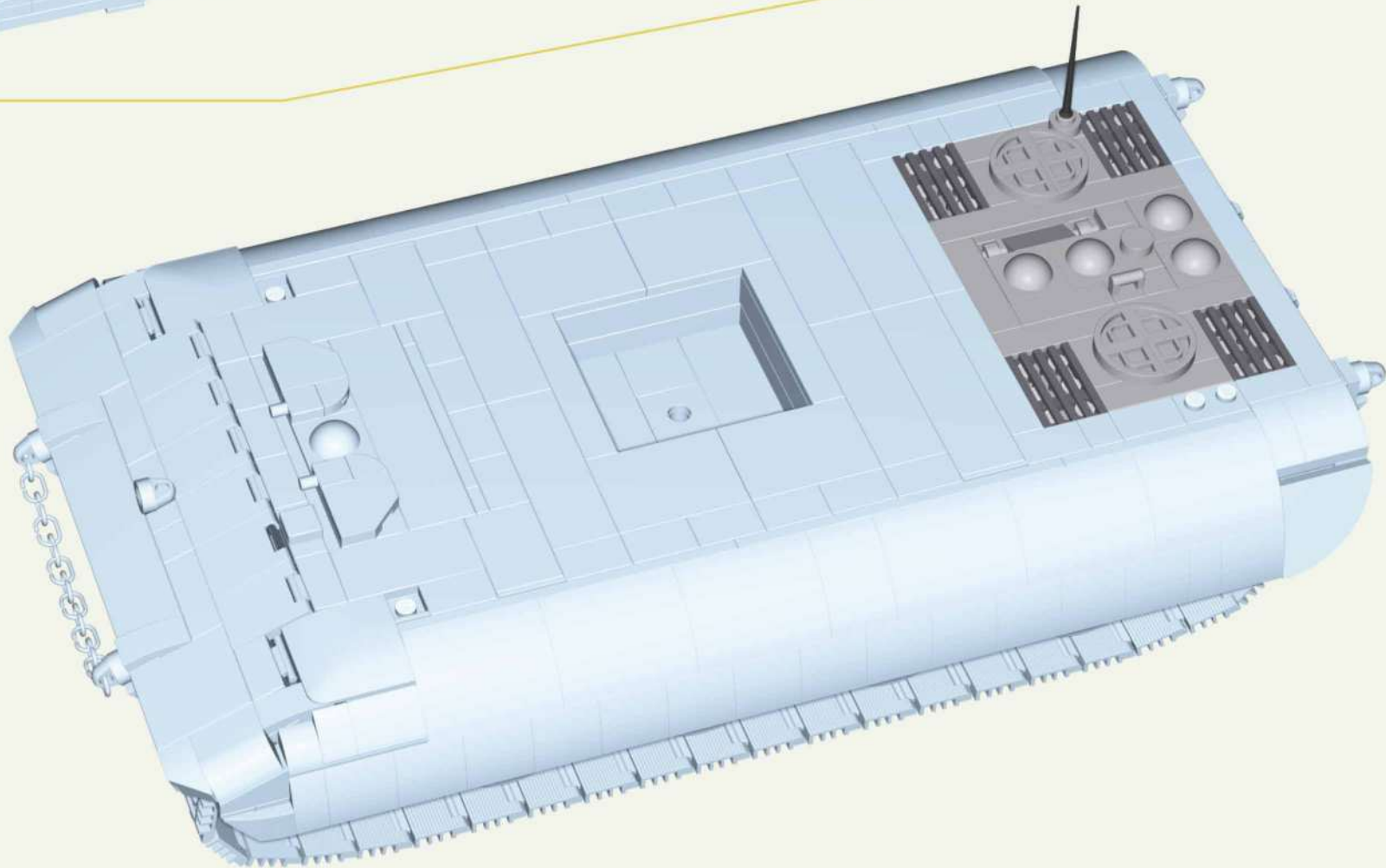

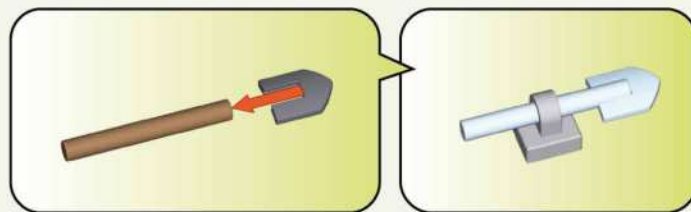
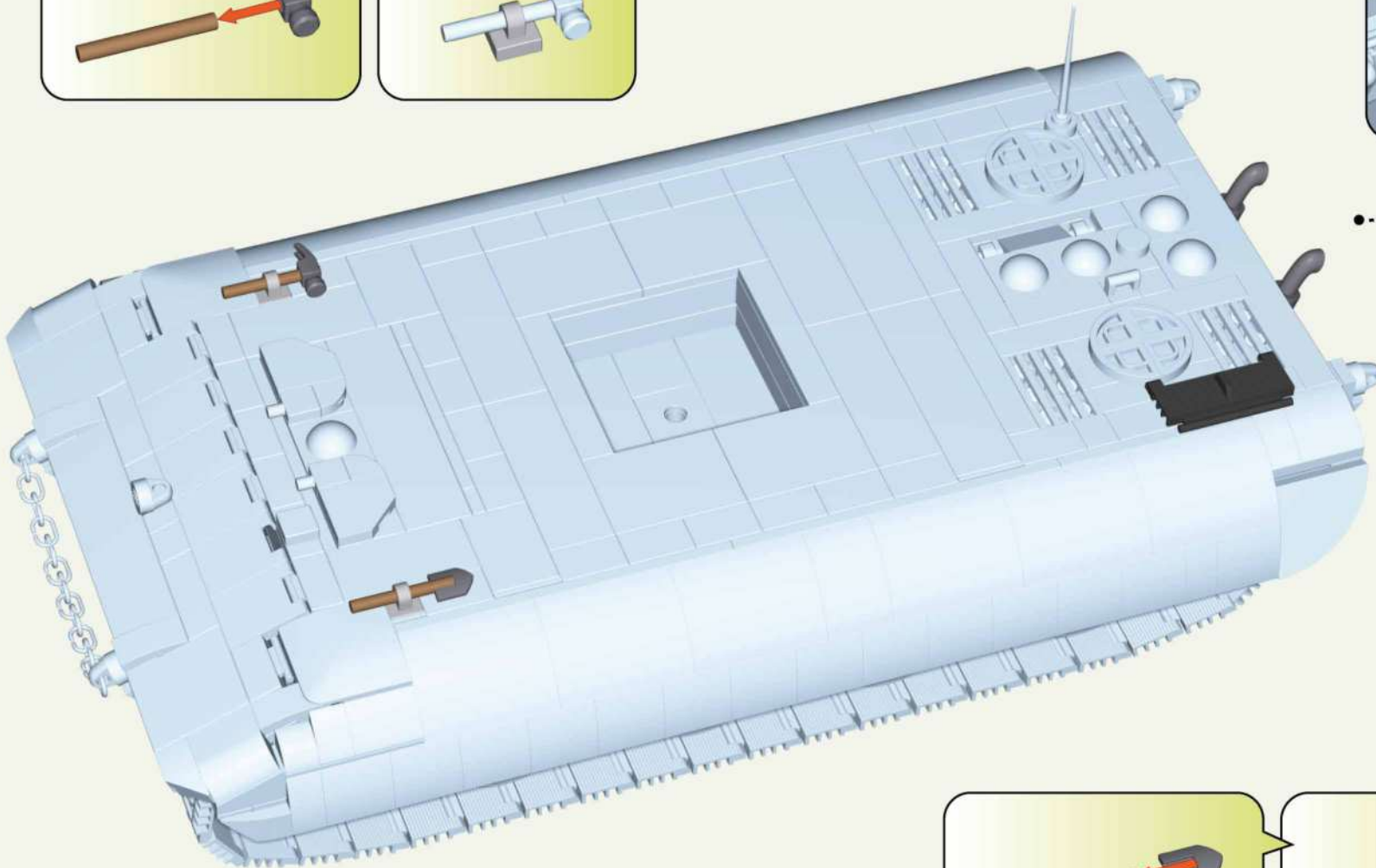
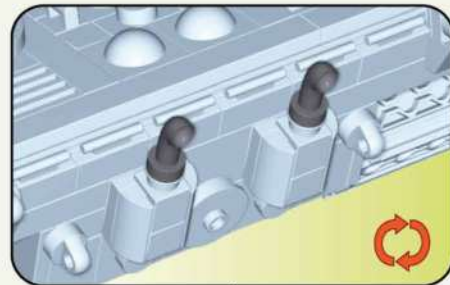
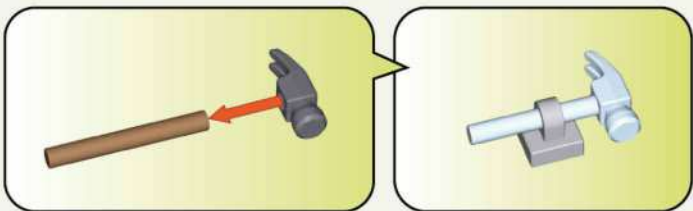

1:1





172

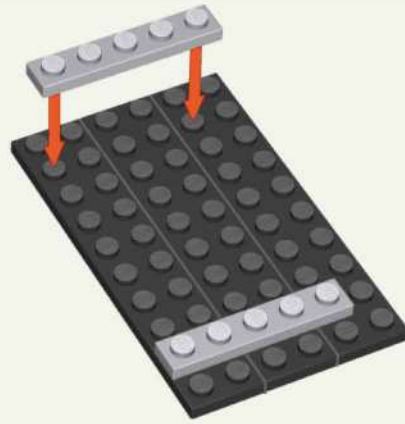

173

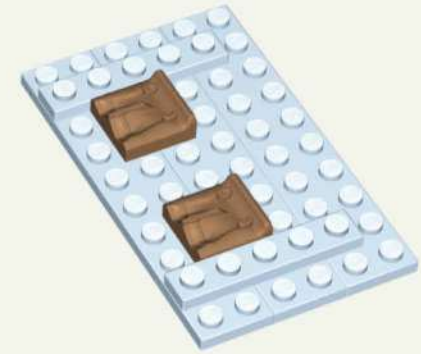

174

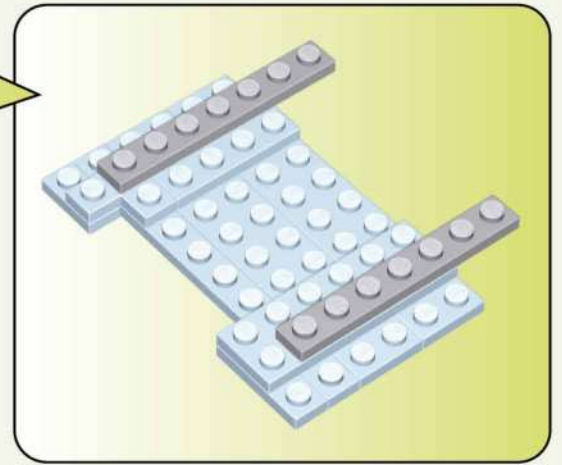
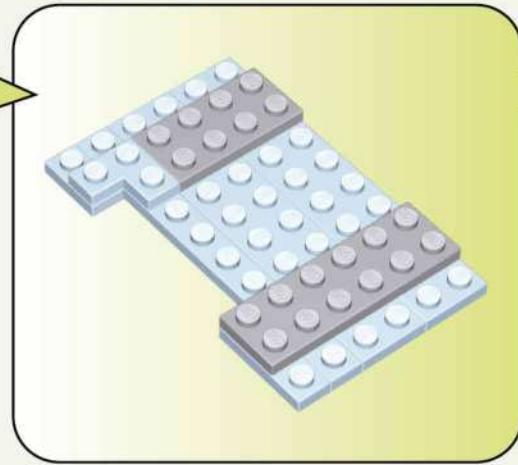
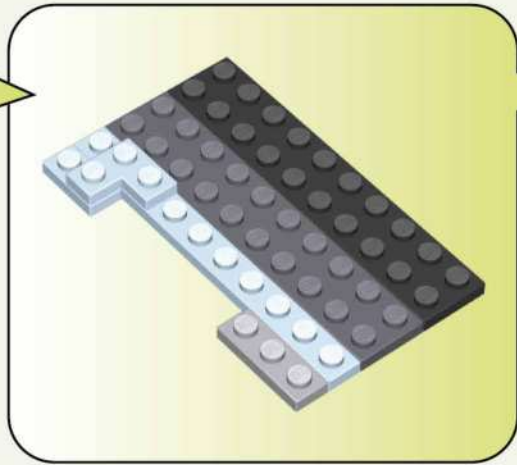
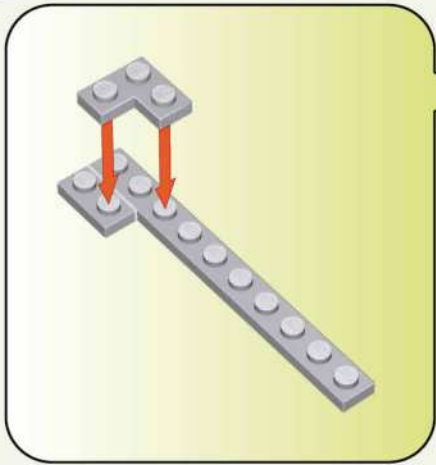

175

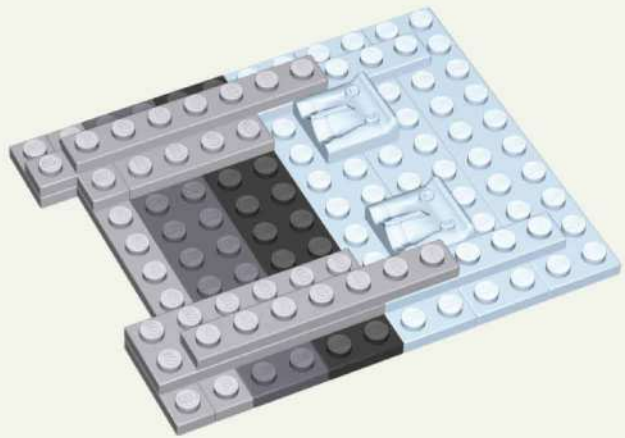

176

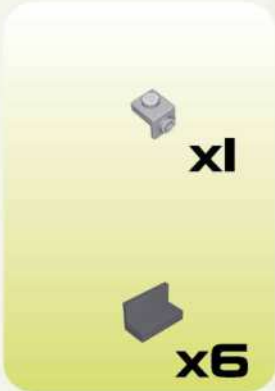
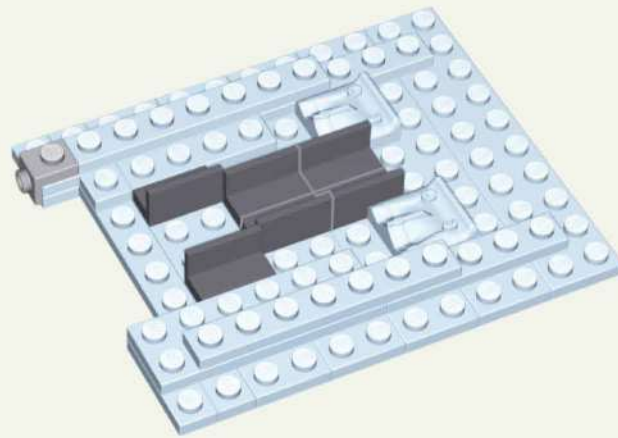

177

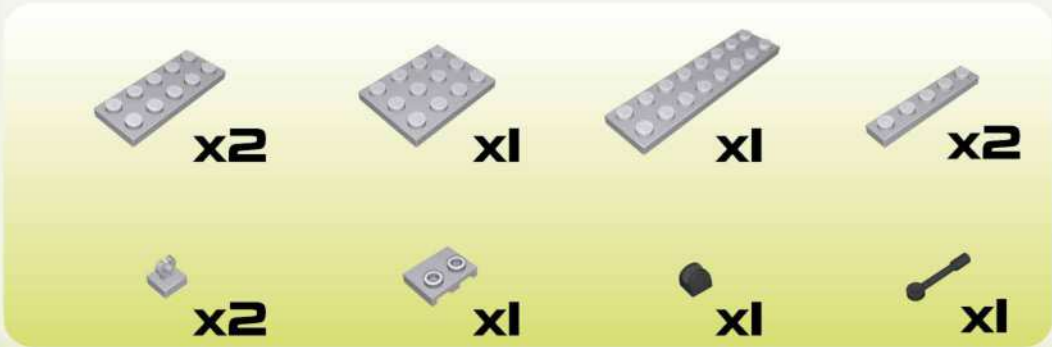
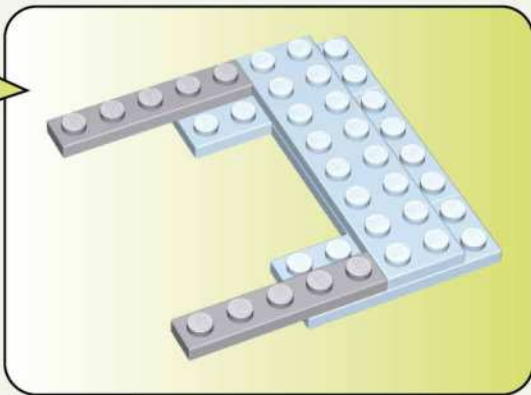
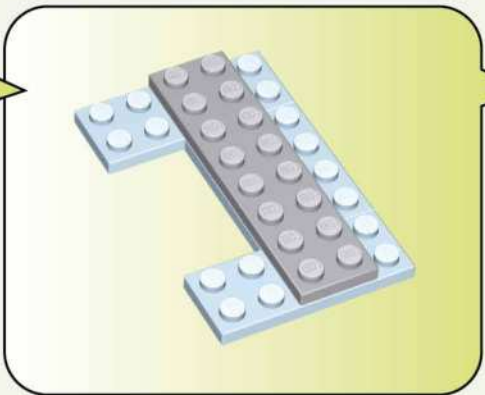
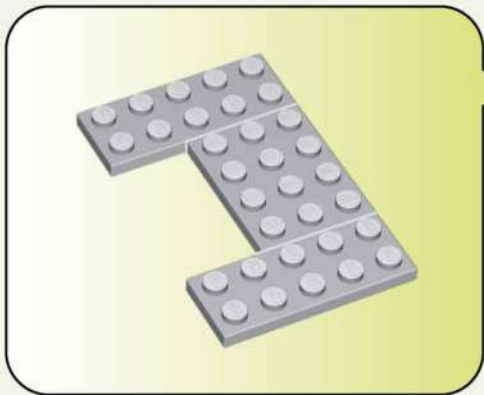

178

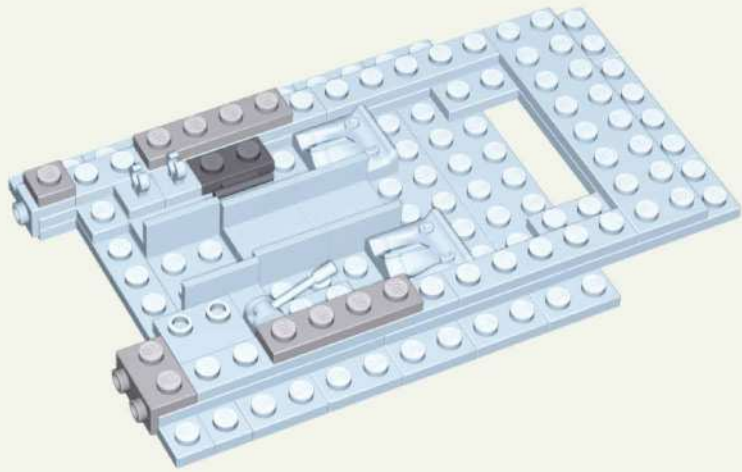

179

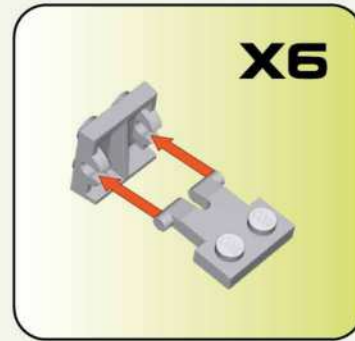

x6

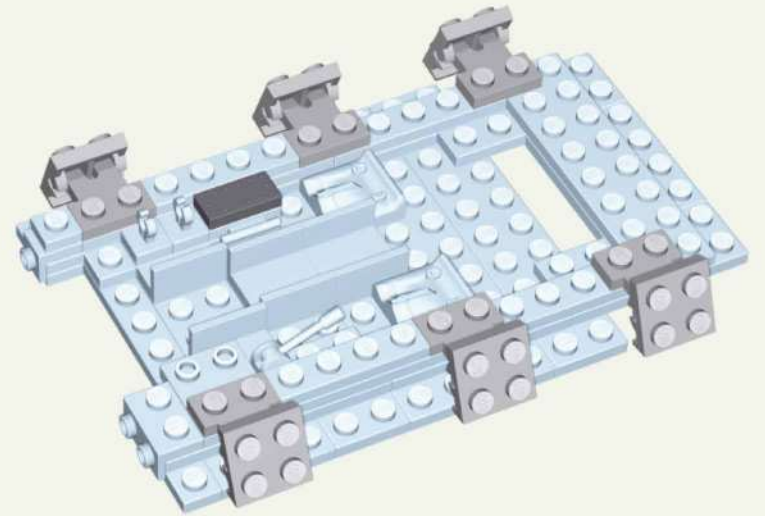

180

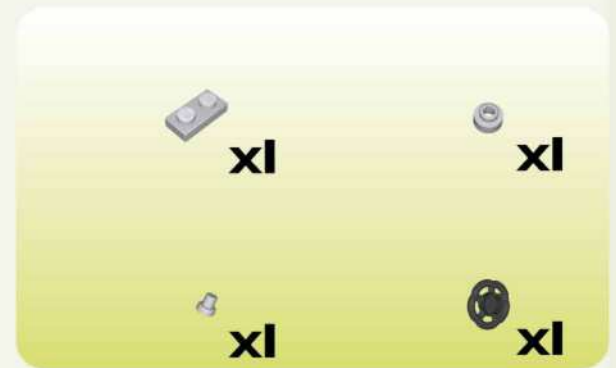
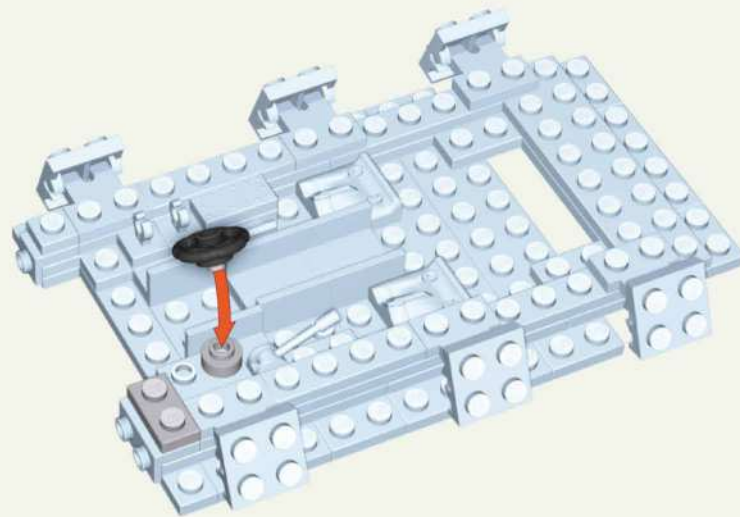

181

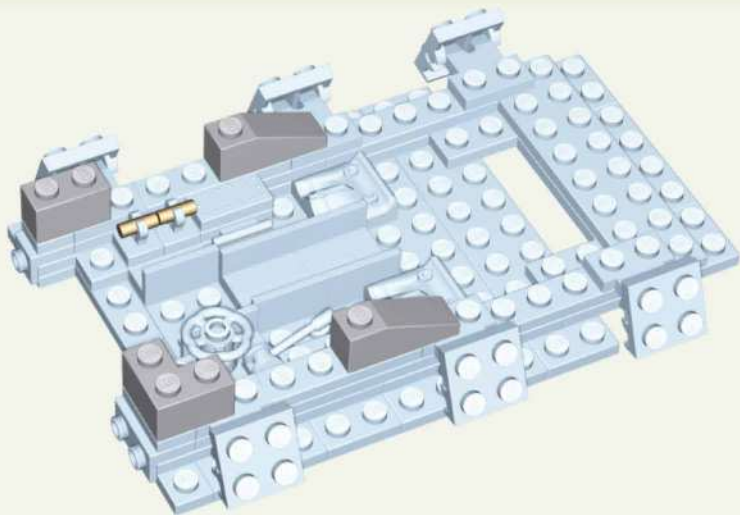

x1



x1



x2

1:1



x2

182

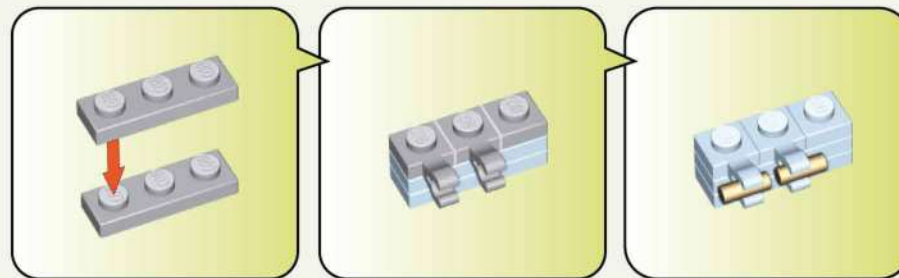

x2



x2



x1

1:1



x2

183

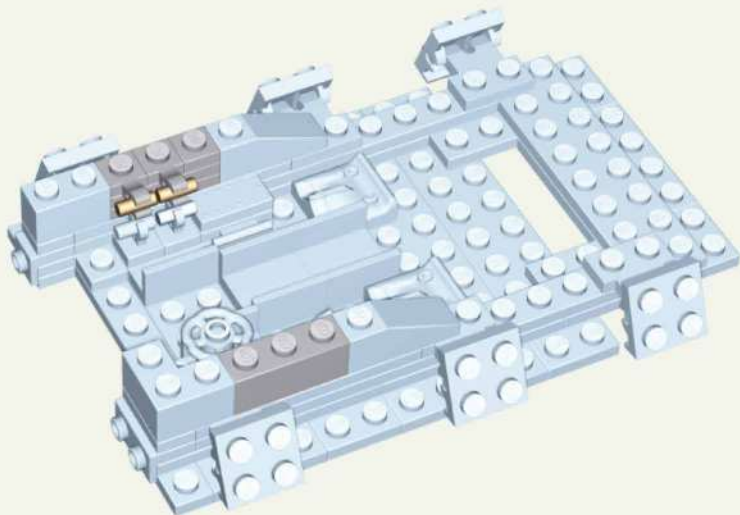

x1

184

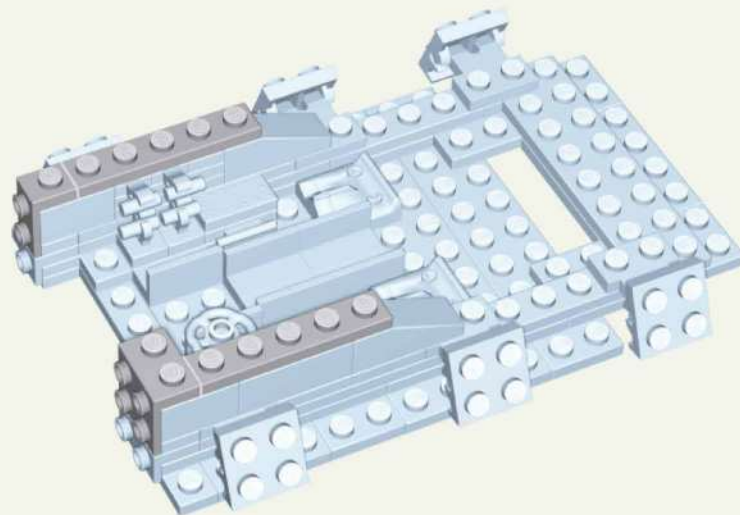

x1



x1



x2

185

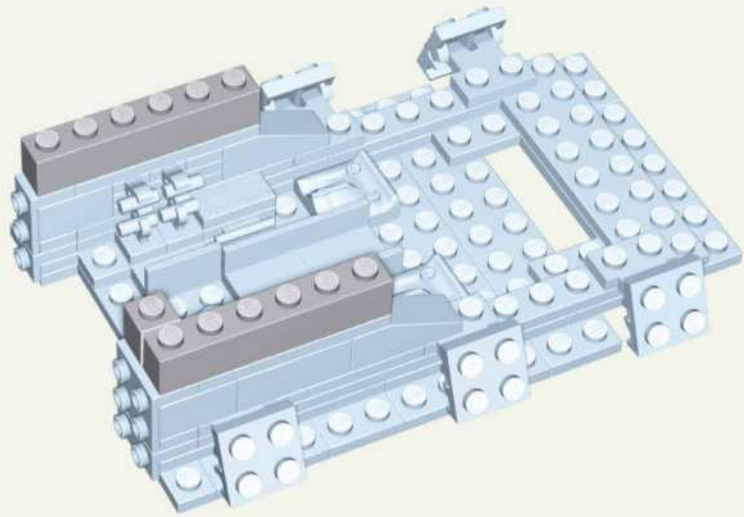

x2



x1

186

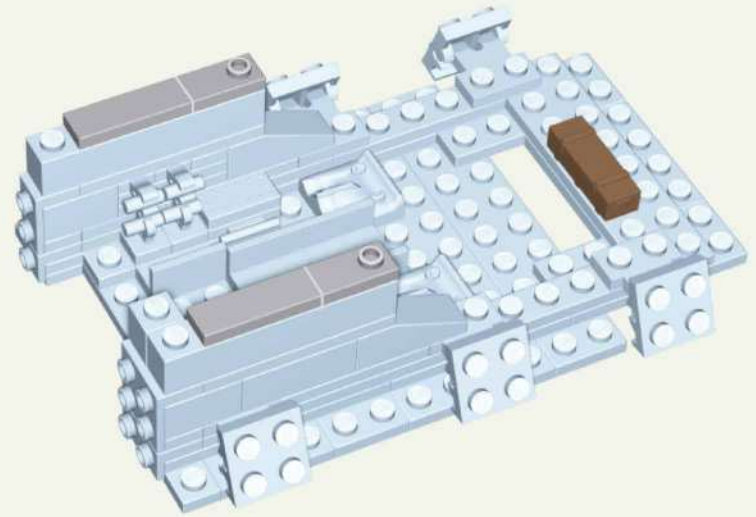

1:1



x2



x2



x1

187

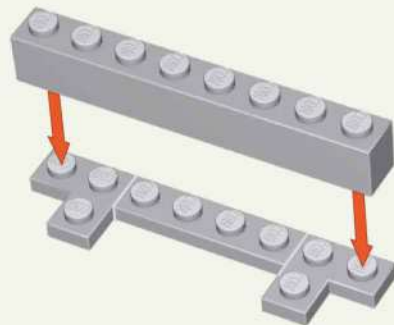

x2



x1



x1

188

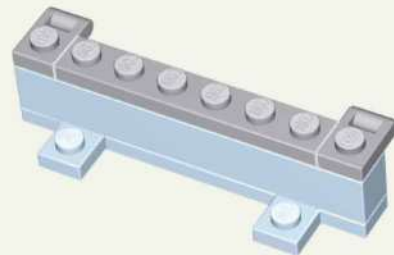

x2



x1

189

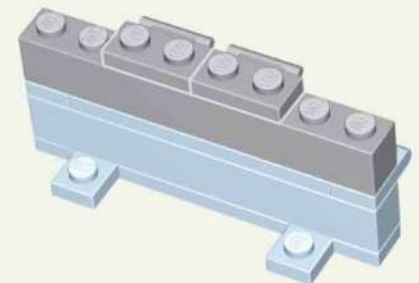

x1



x2

190



 x2  x2

191

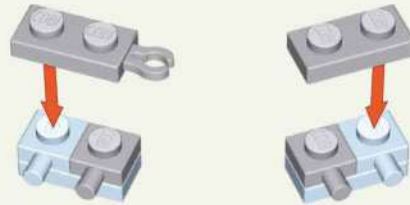

 x2  x1  x1

192

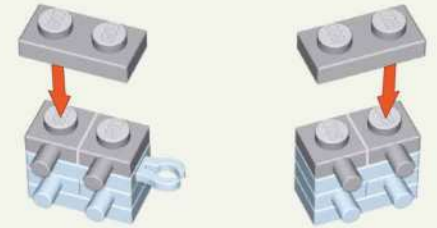

 x4  x2

193

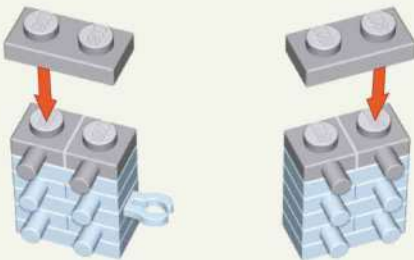

 x4  x2

194

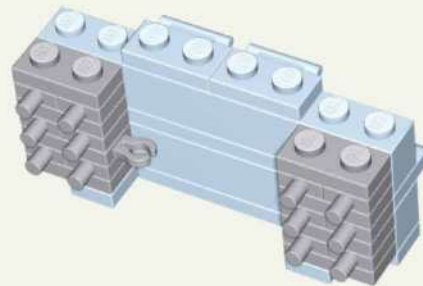

195

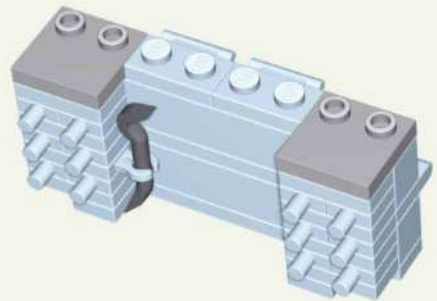

 x2  x1

196

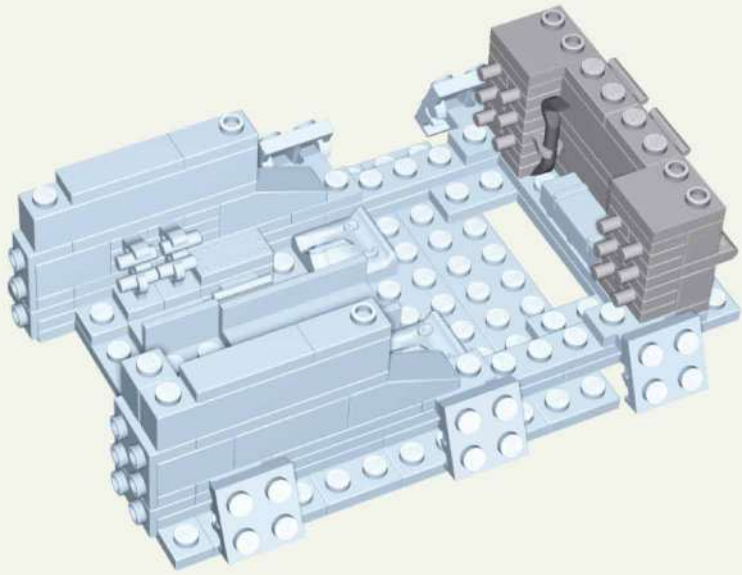

197

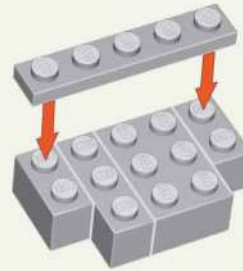

198

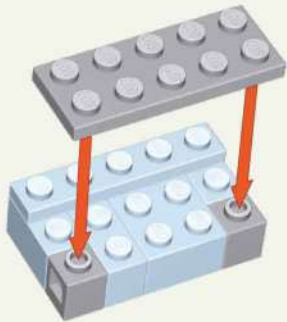

199

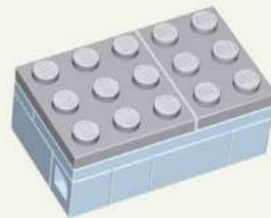

200



201

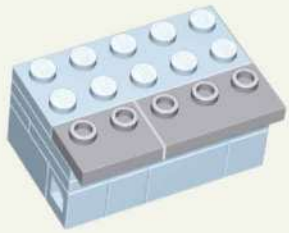

202

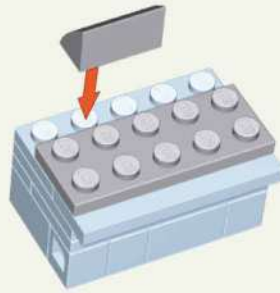

203

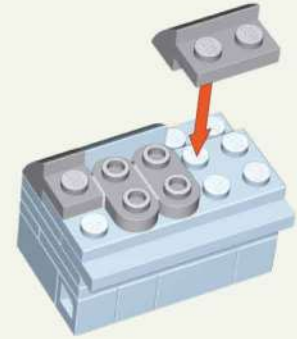

204

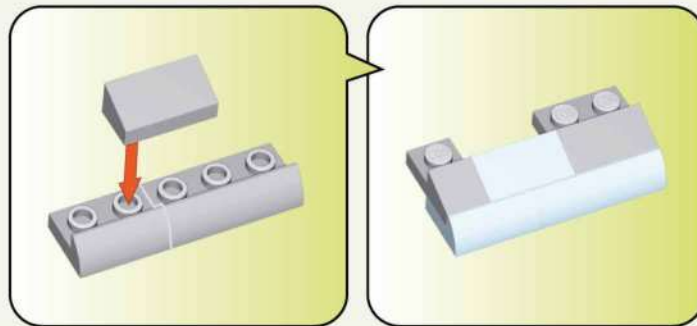

205



206

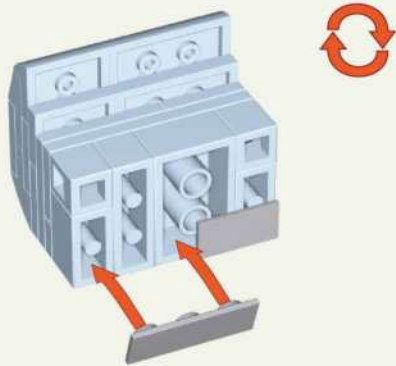

x1



x1

207

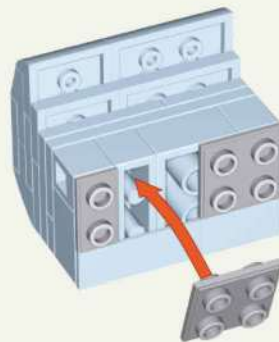

x2



x1

208

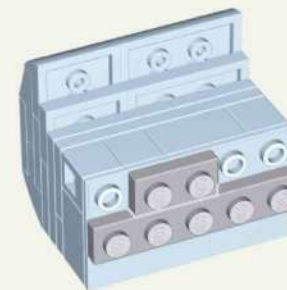

x1



x1

209

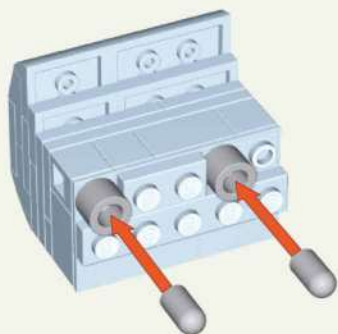

x2



x2

210

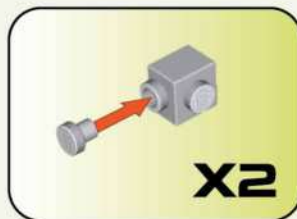

x2

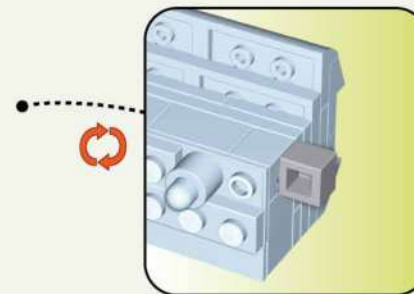
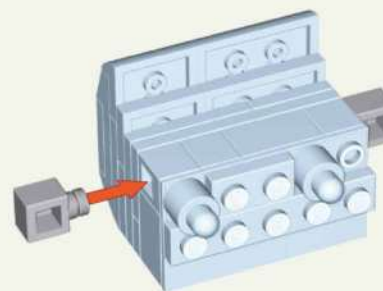

x2



x2

211

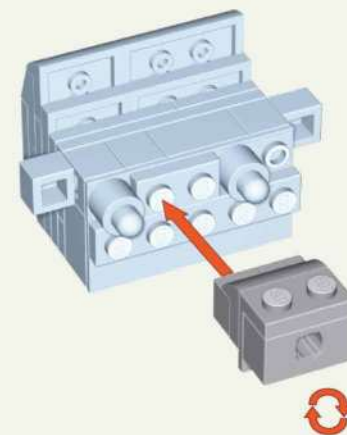
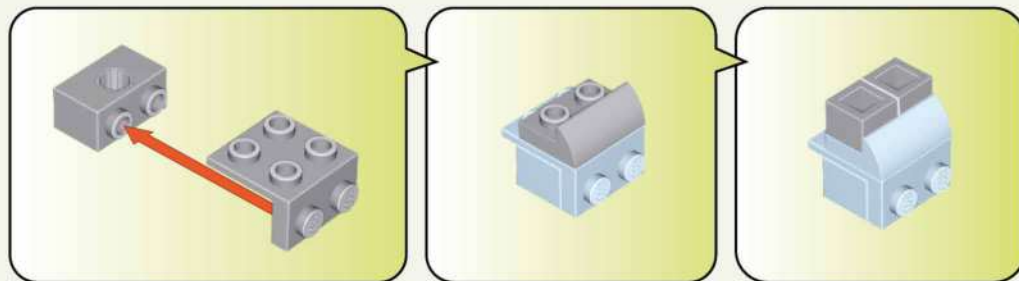

x1



x1



x1



x2

212

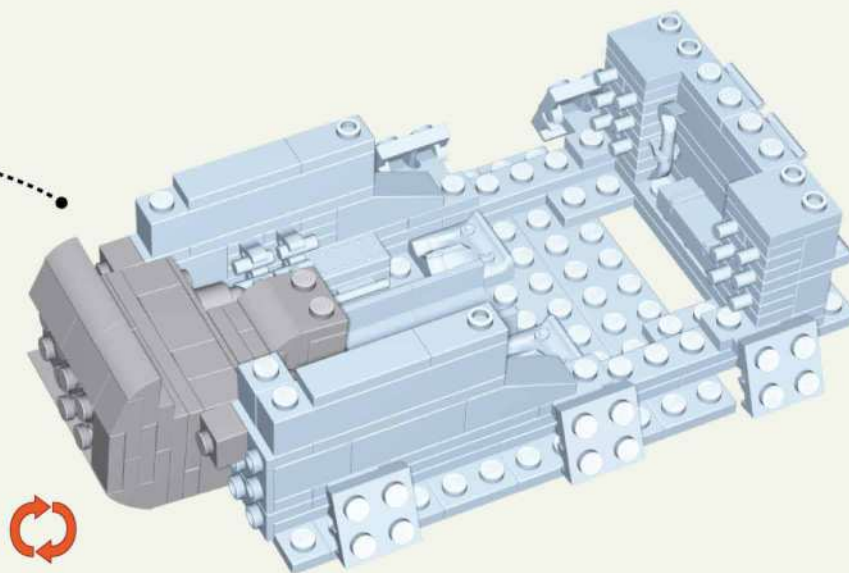
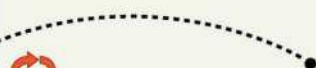
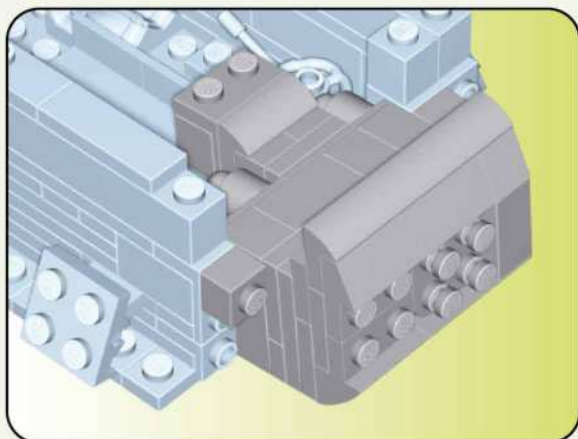

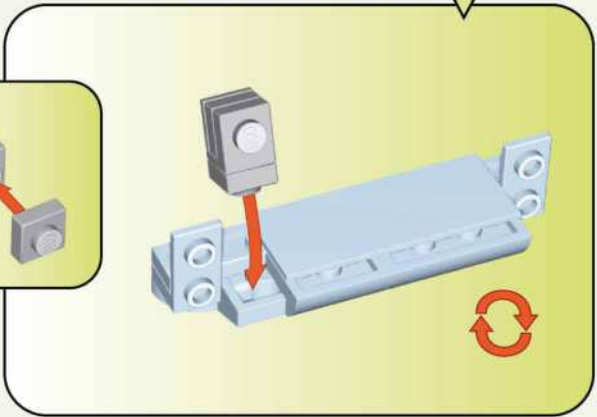
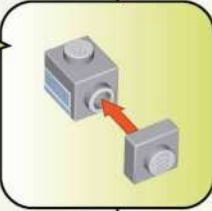
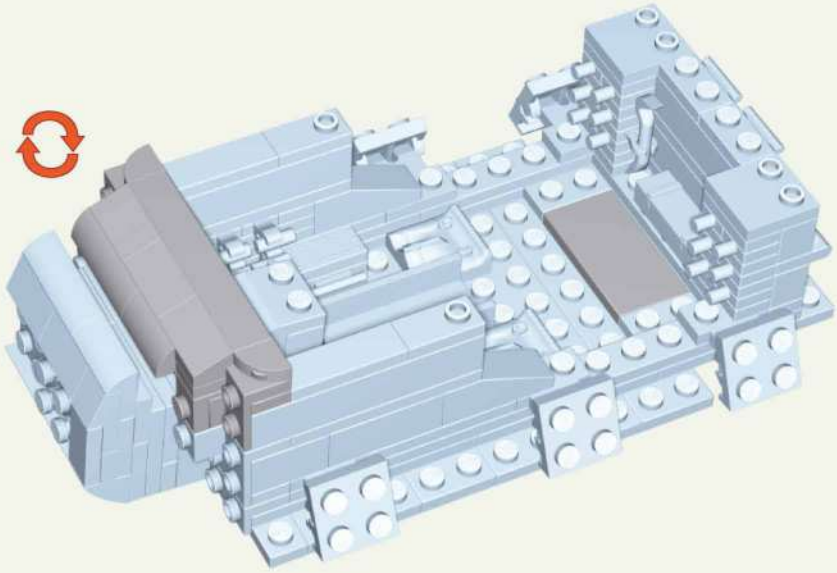
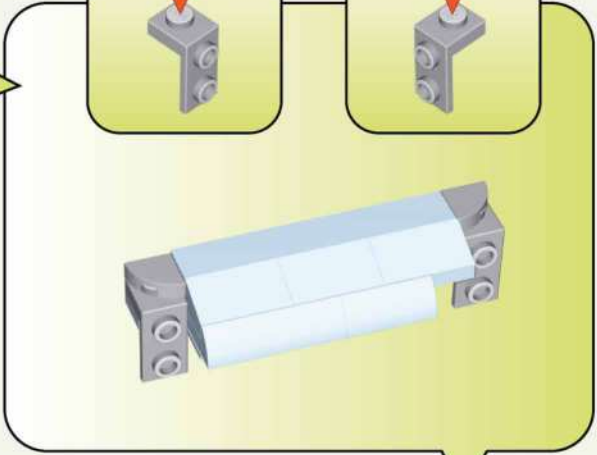
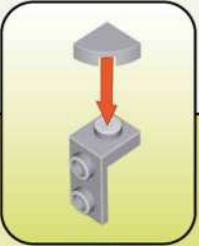
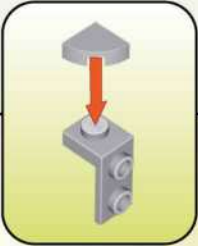
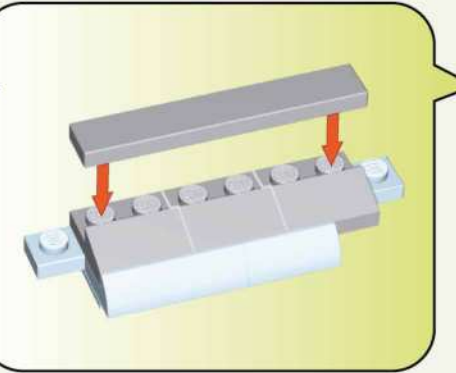
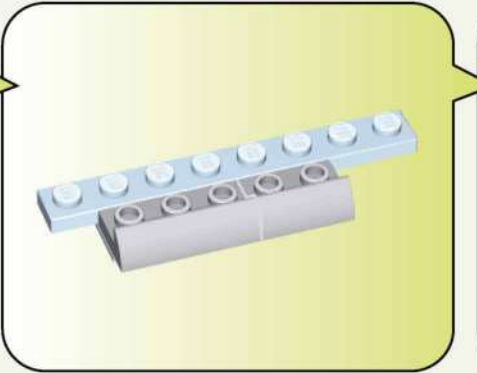
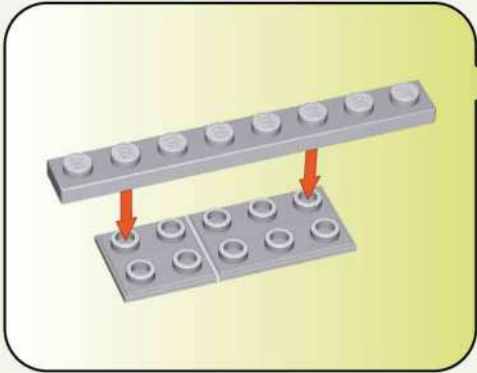

1:1



x1



x1



x1



x1



x1



x1



x3



x2



x2



x1



x2



x1



x1

214

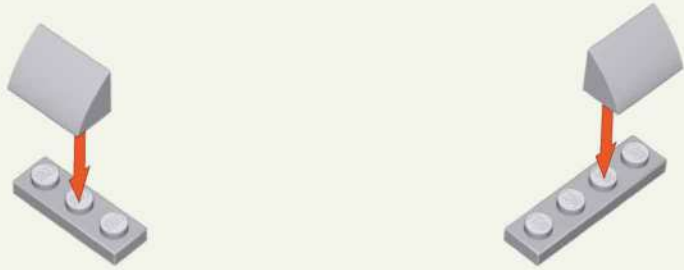

215

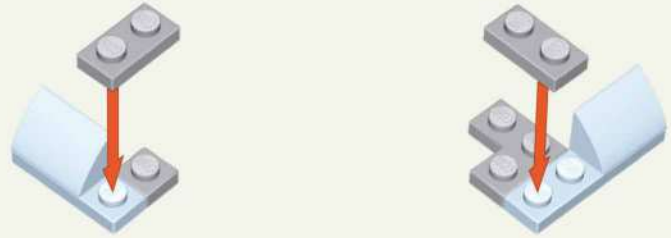

216

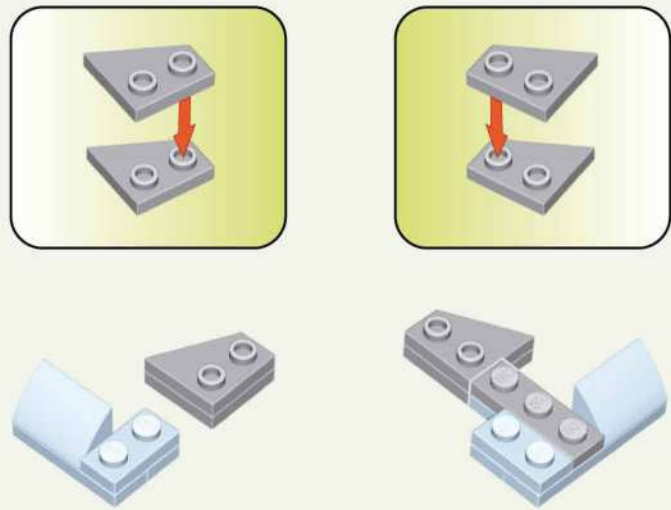

217

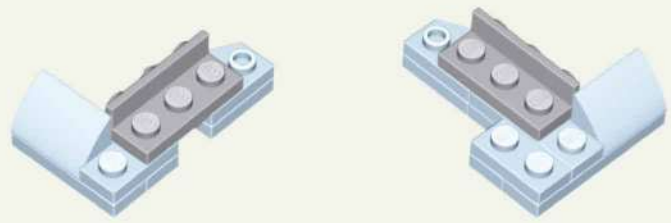

218

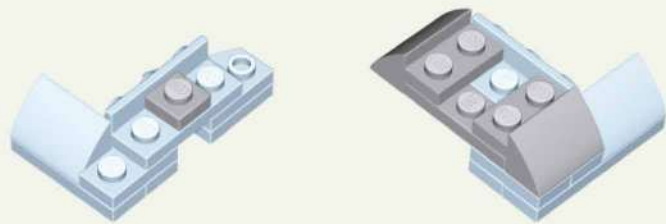
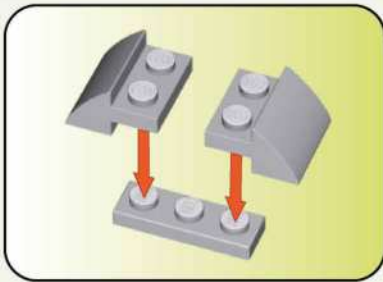

 x1
 
 x2
  x1

219

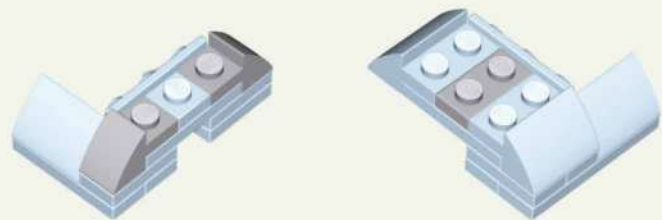

 x2
  x1

220

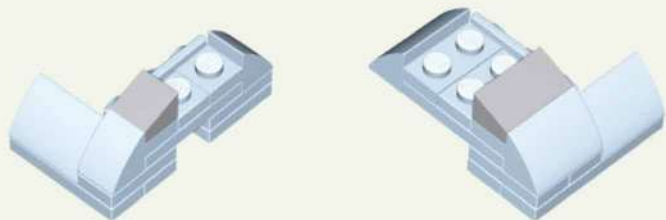

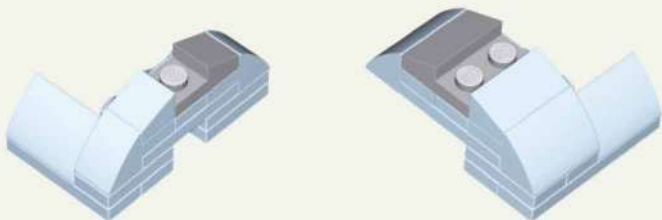

 x1
  x1

221

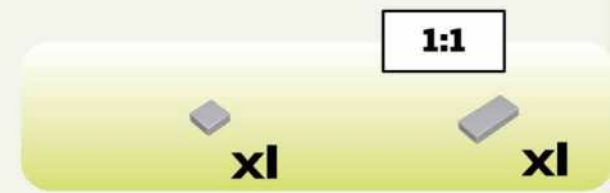
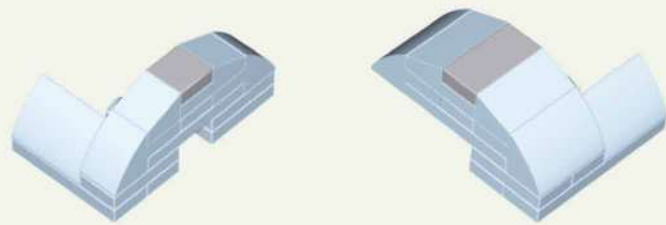

 x1
  x1

222



223

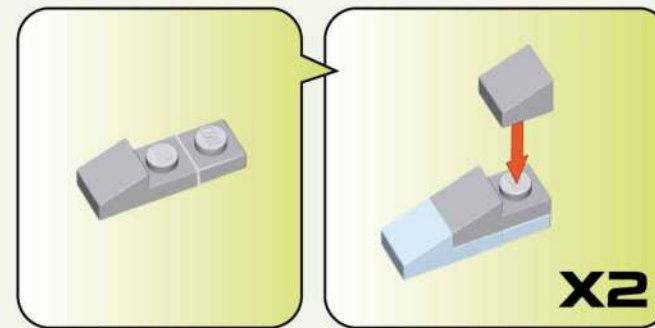
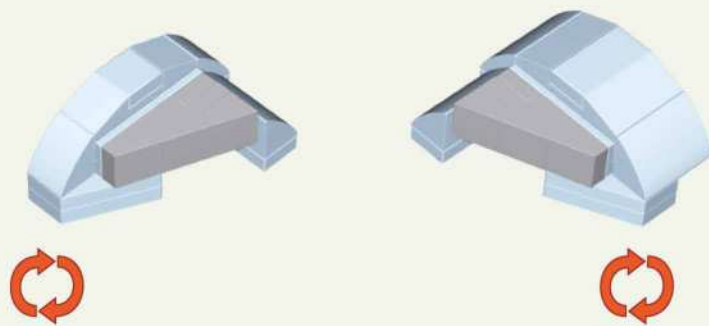

224

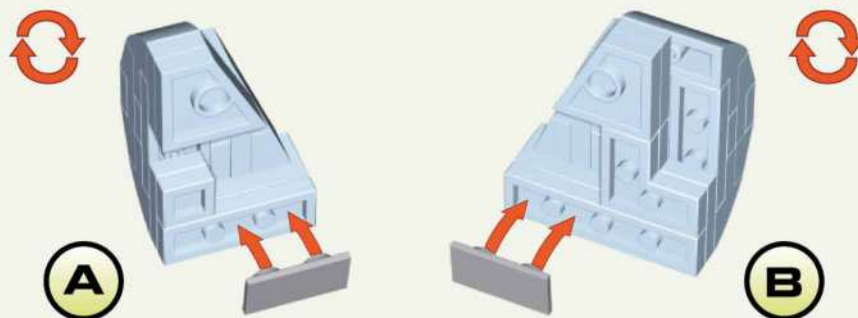

225

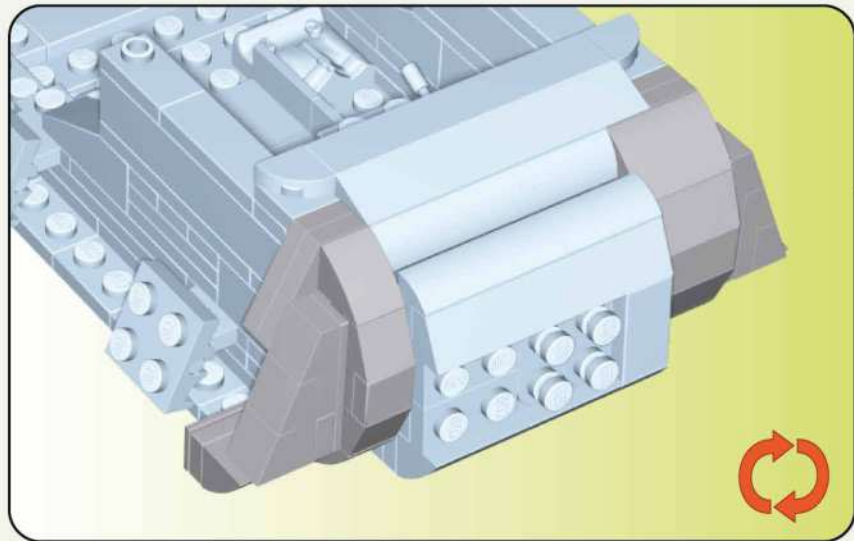

A

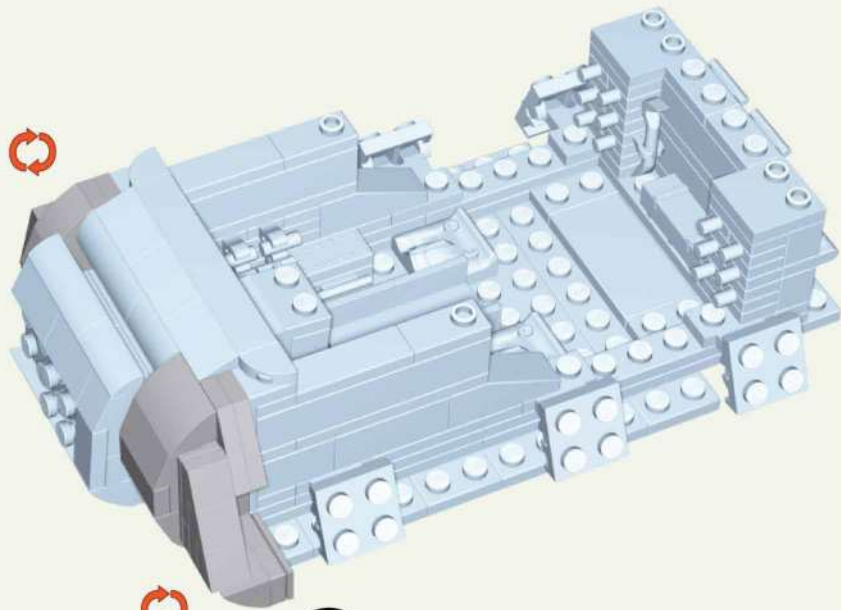

B

226

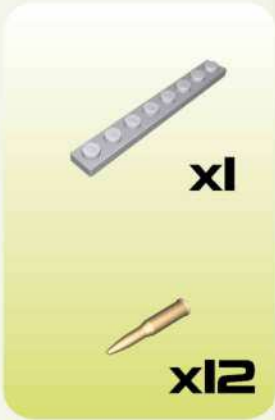
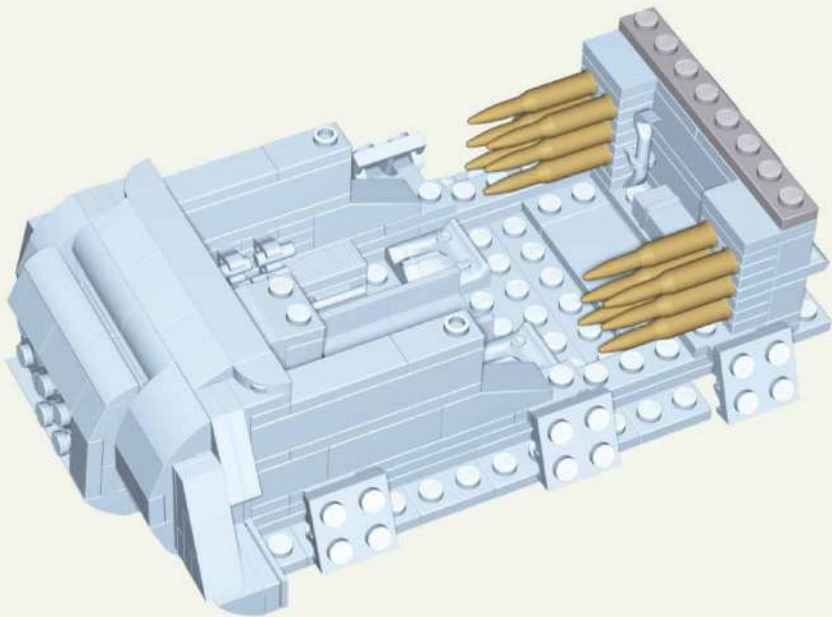

227

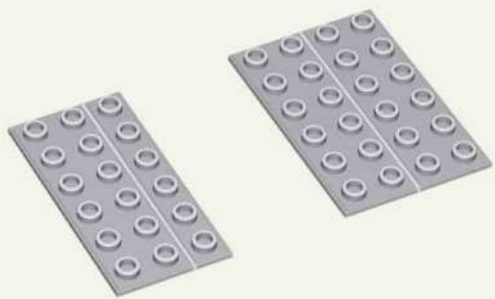

228

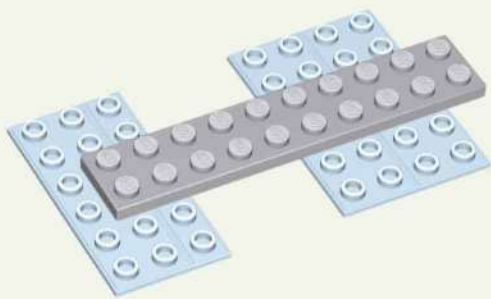

229

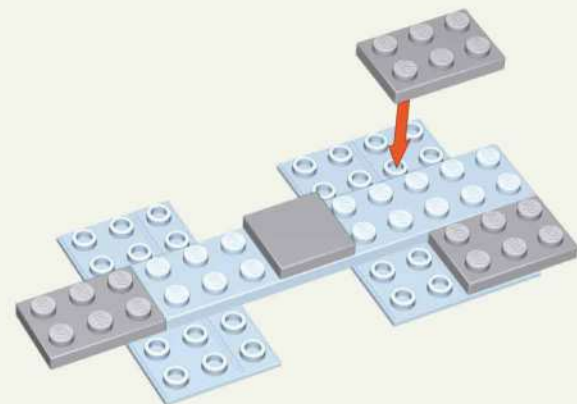

230

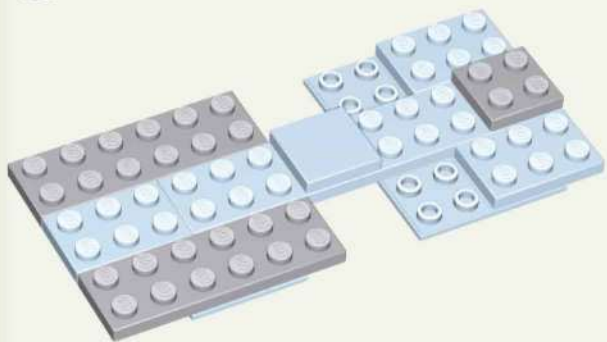

231

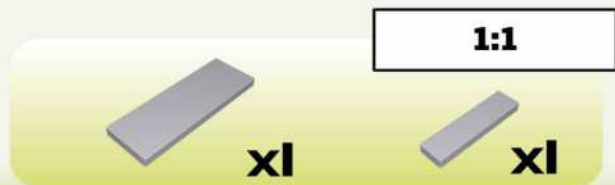
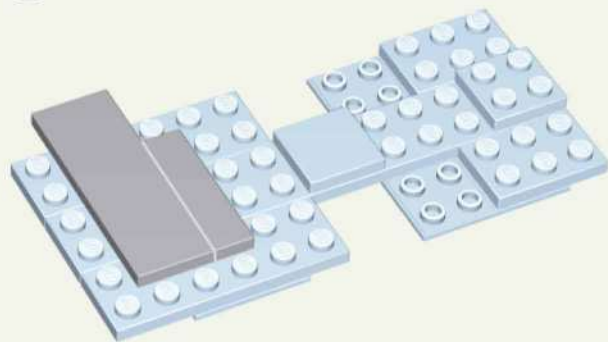

232

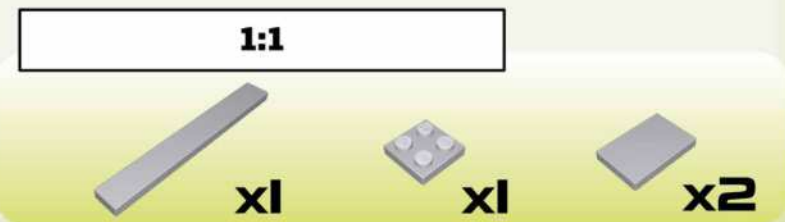
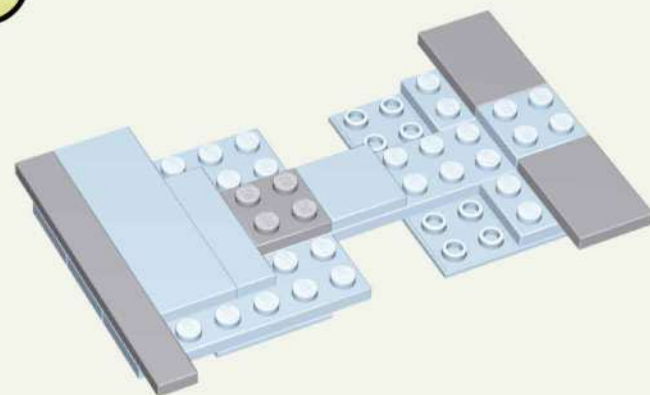

233

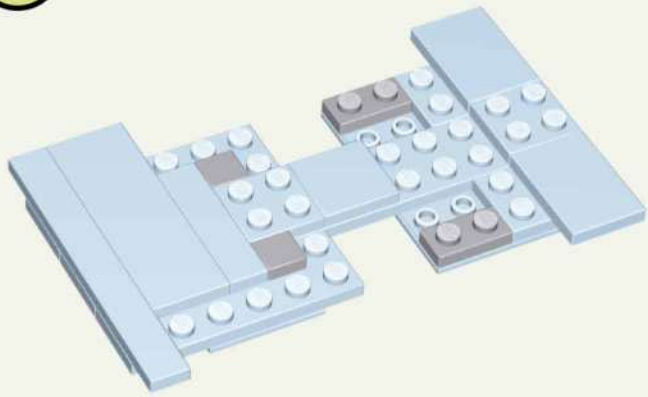

234

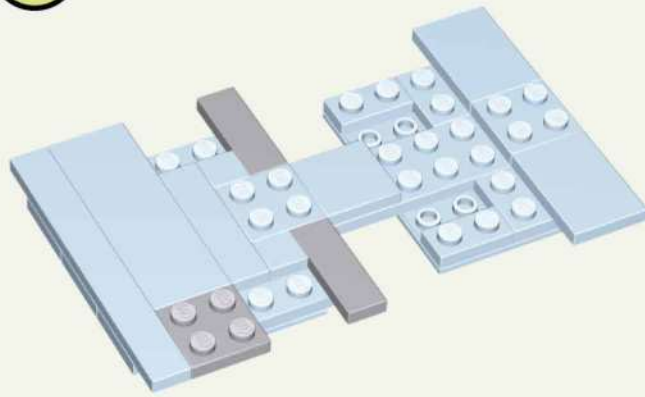

235

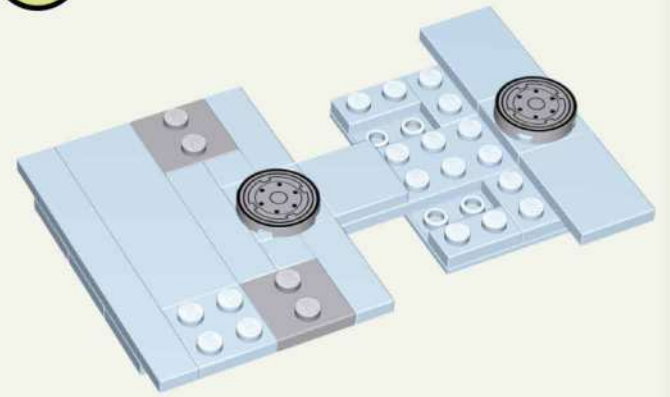

236

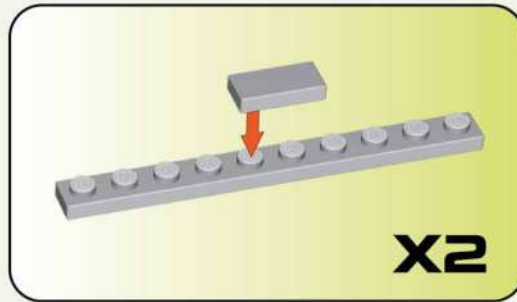
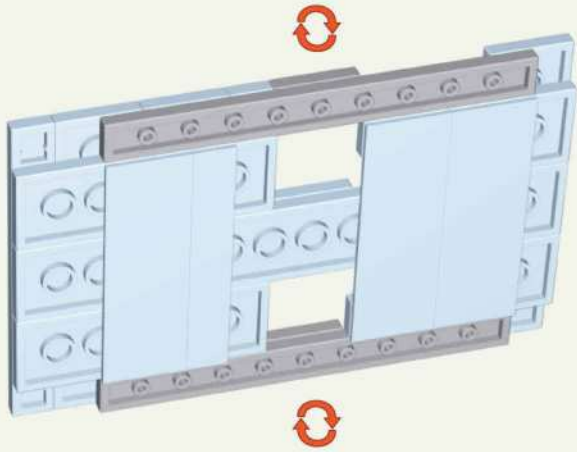

237

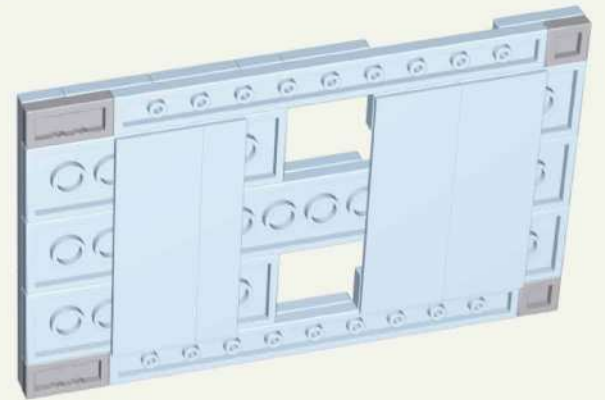

238

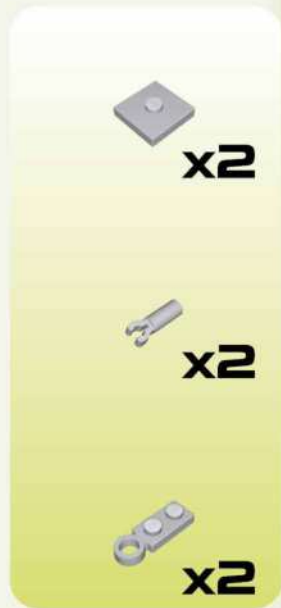
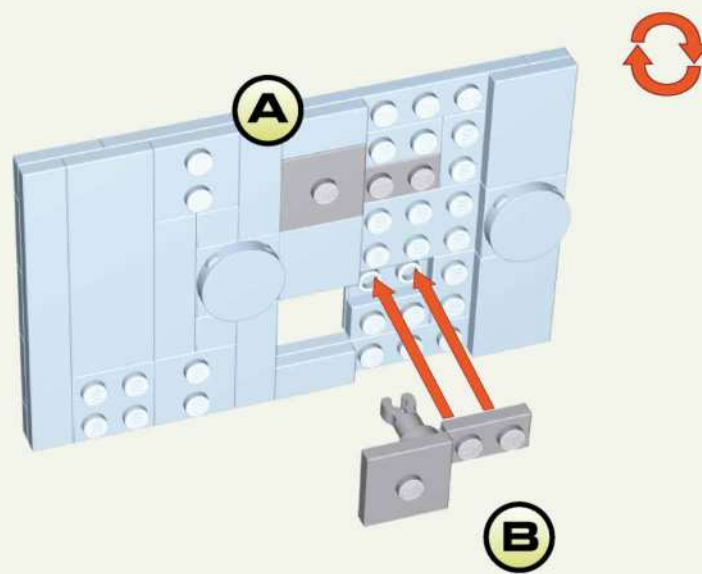
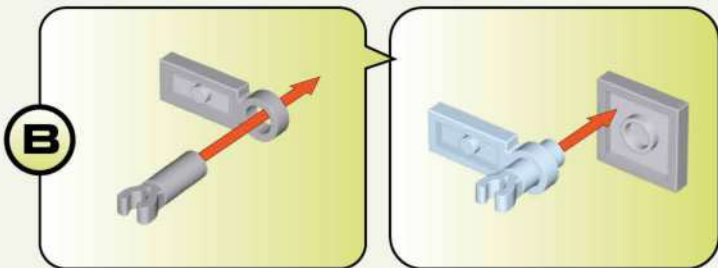
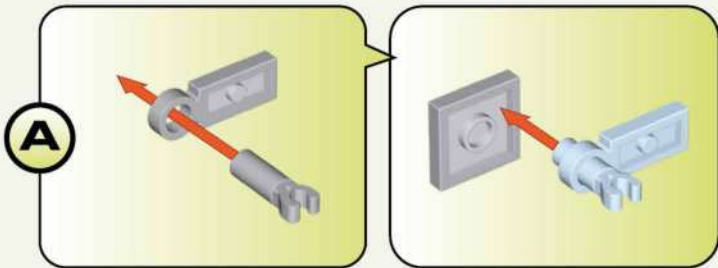

239

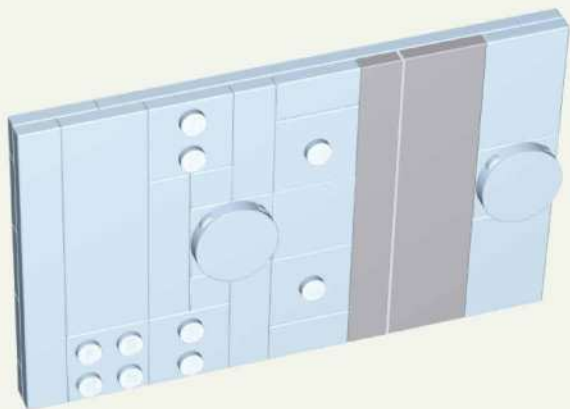

1:1

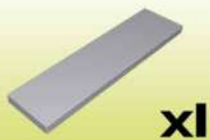

240

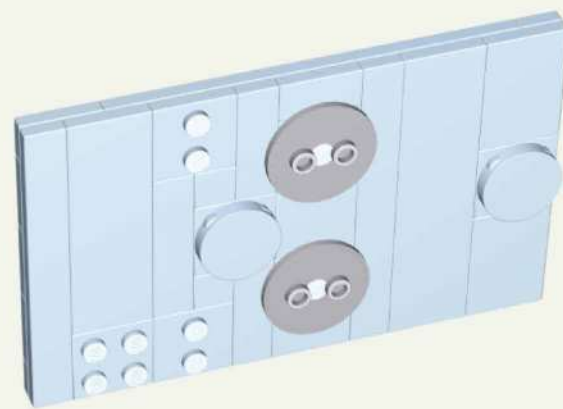

241

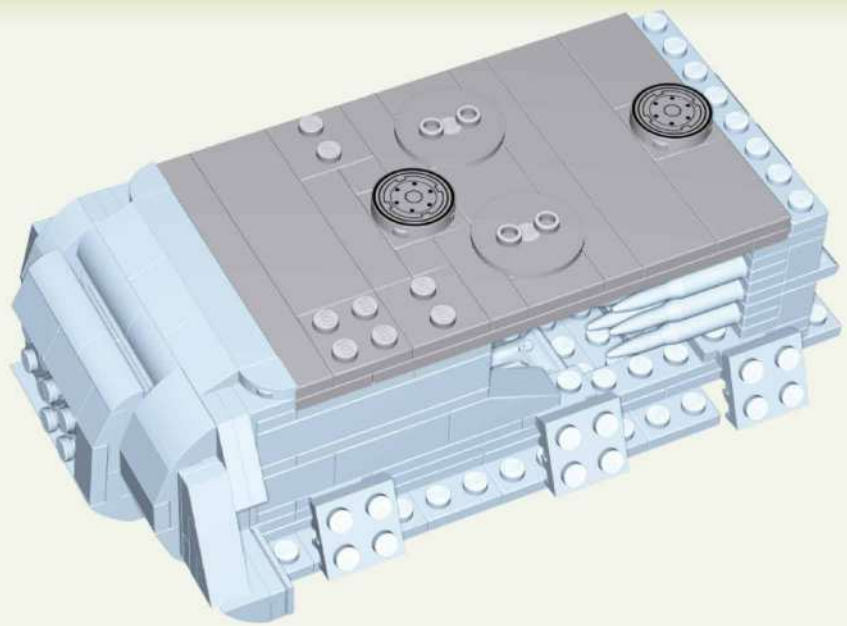

242

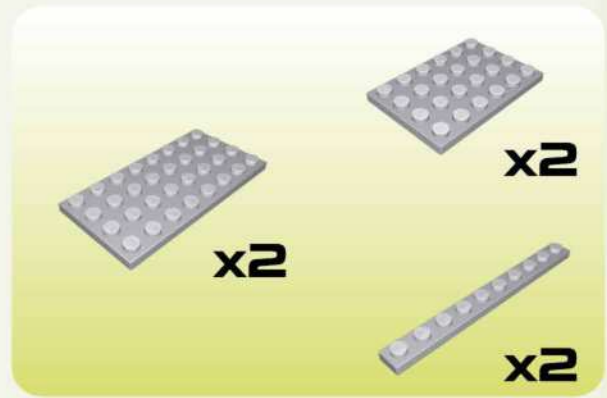
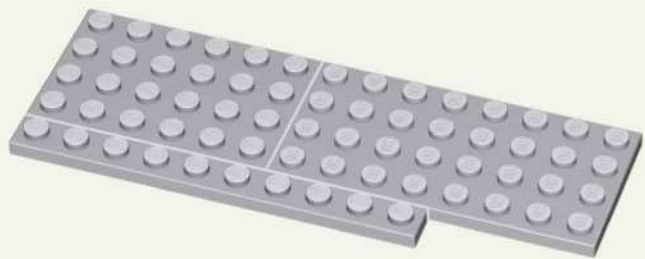

243

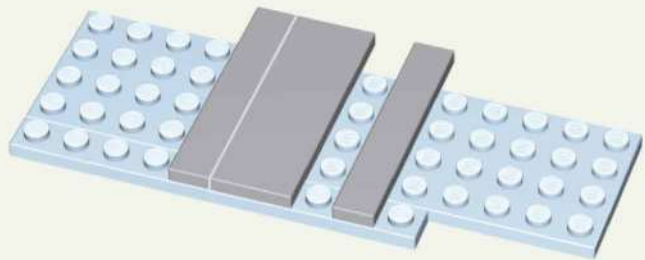
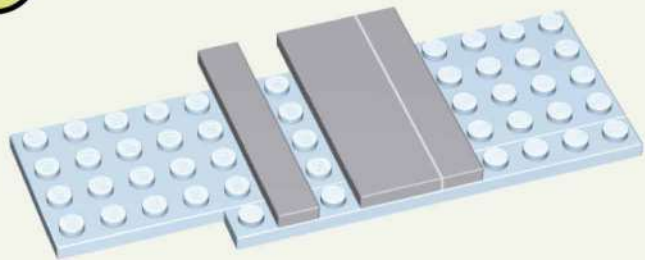

1:1

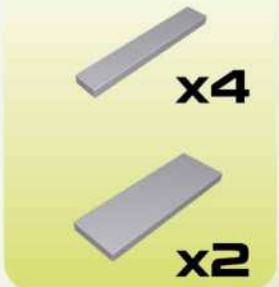

244

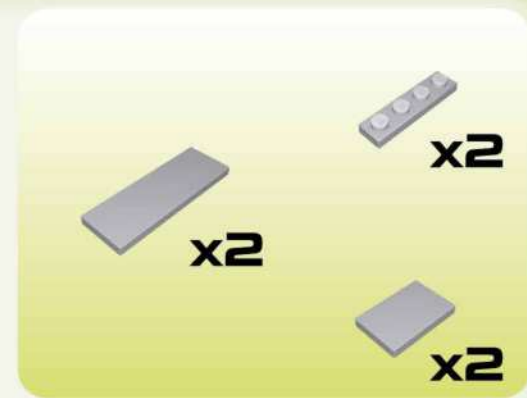
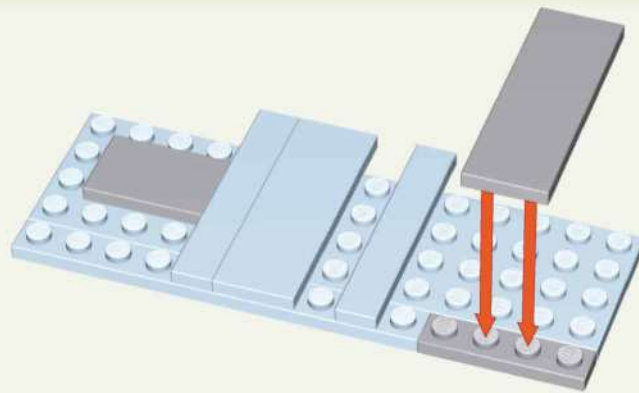
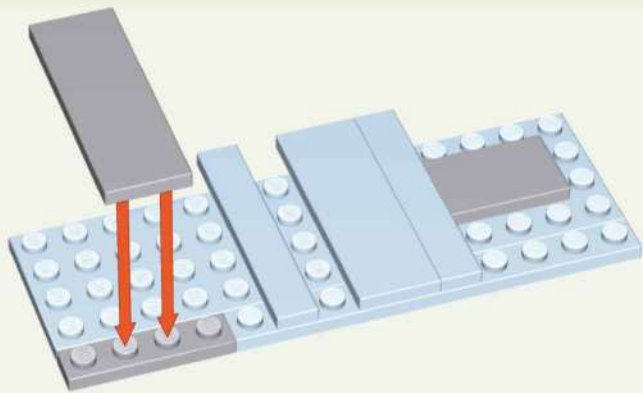

245

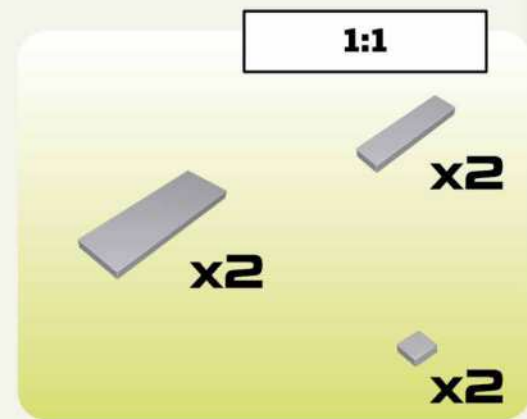
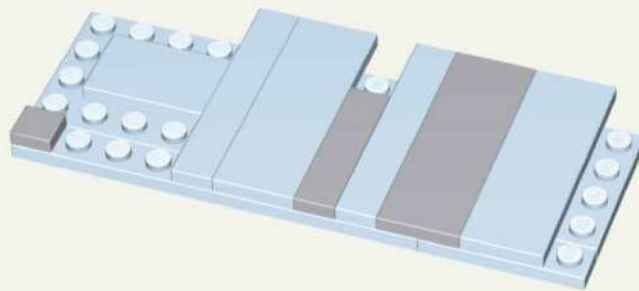
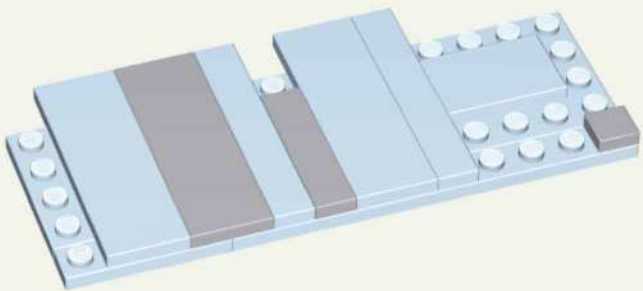

246

A

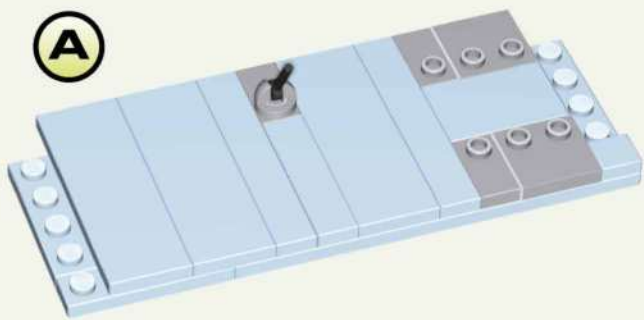



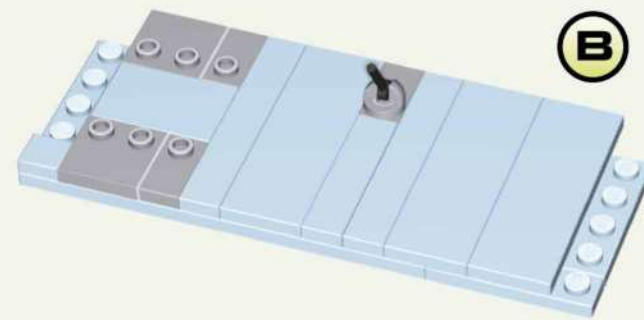

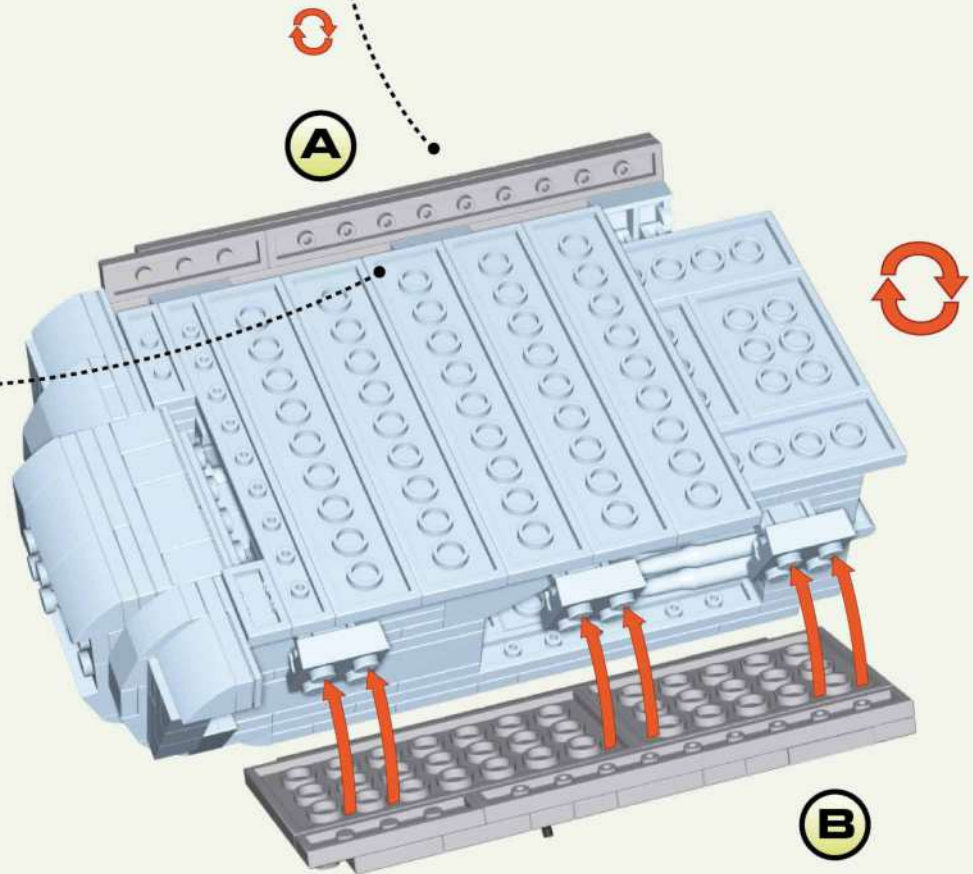
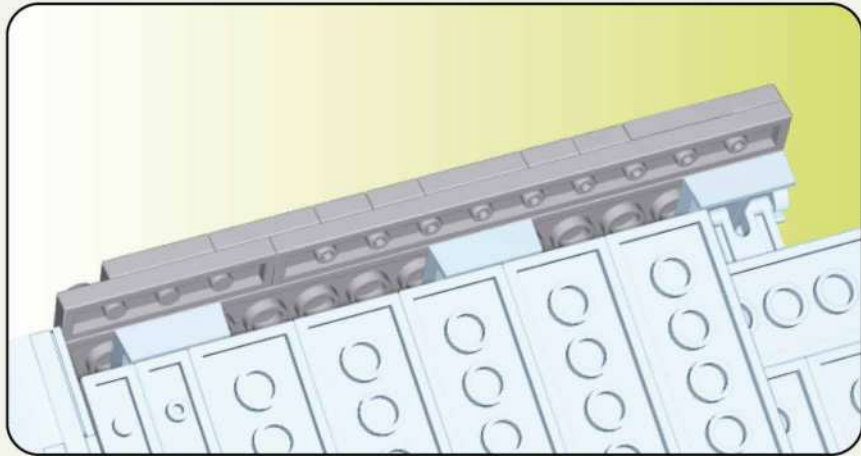
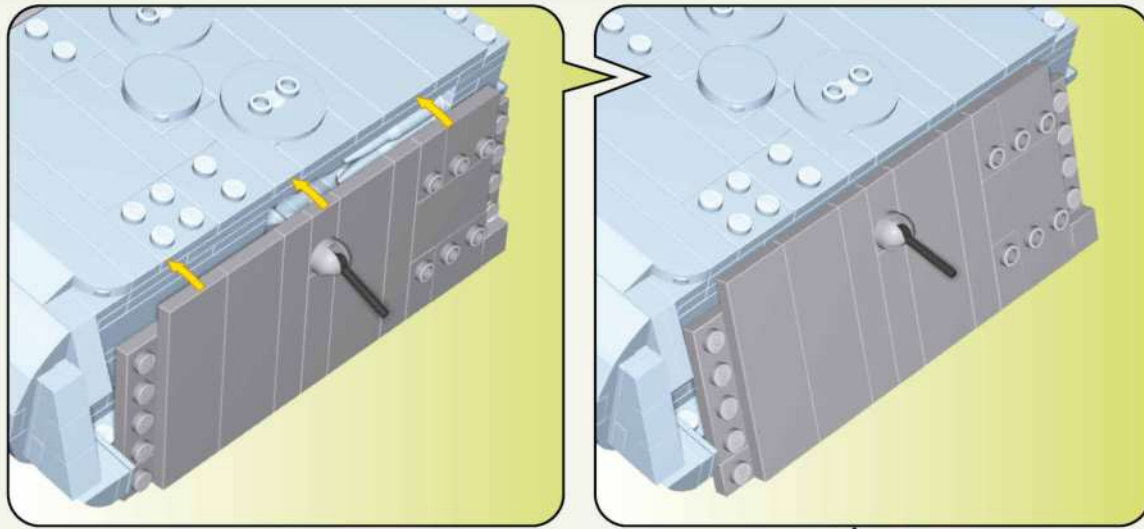
B



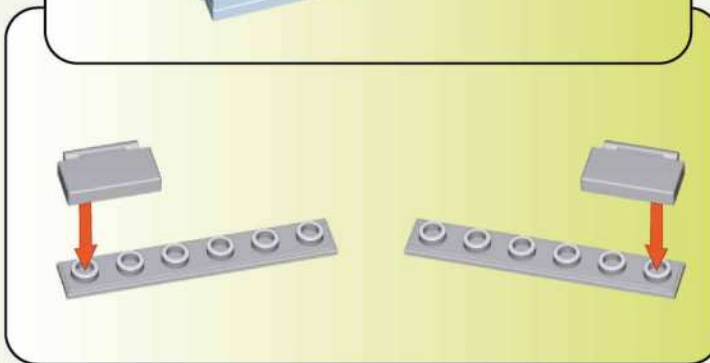
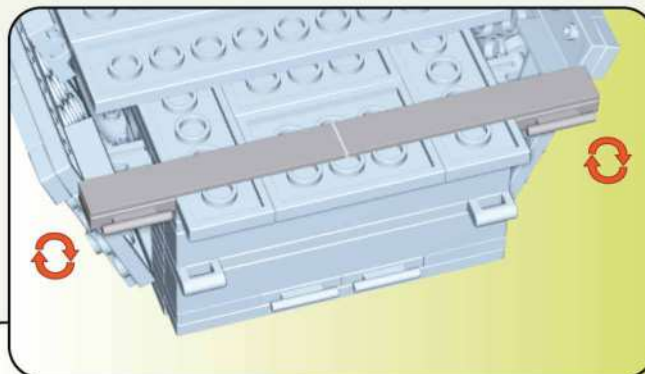
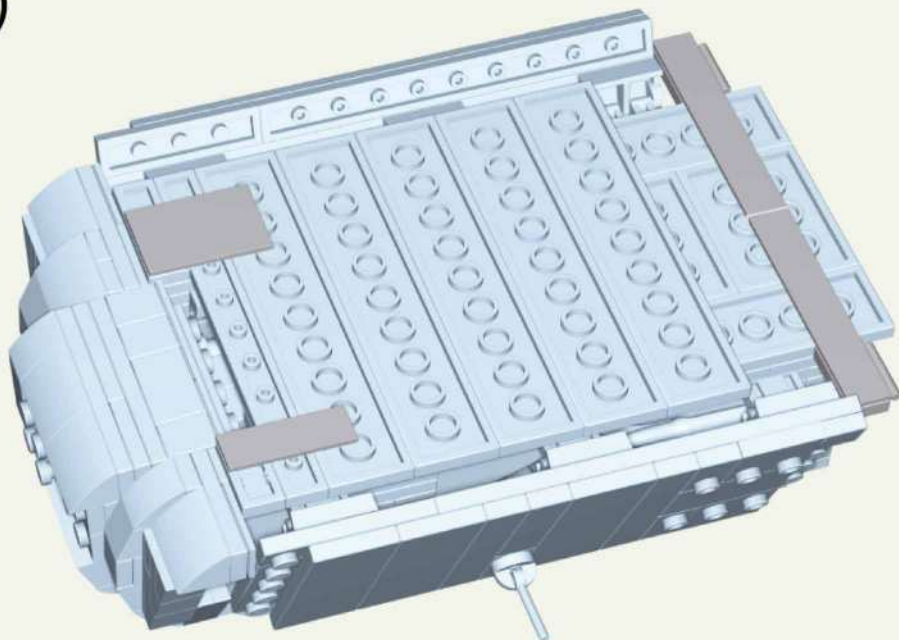

248



-  x1
-  x1
-  x2
-  x2

249

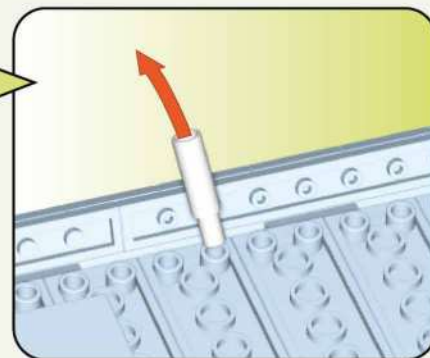
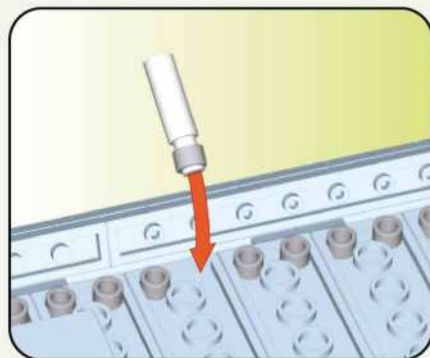
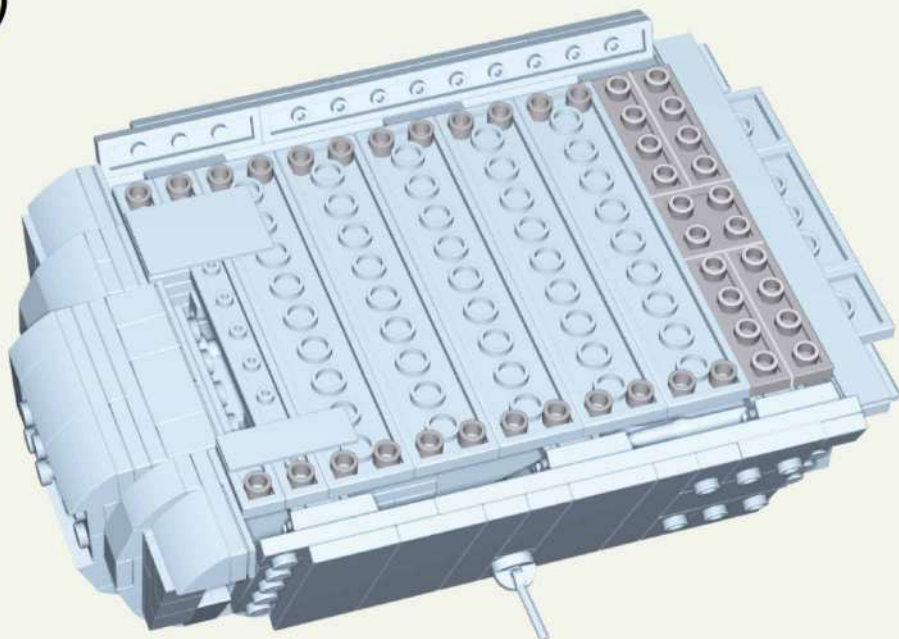

-  x24
-  x4
-  x1

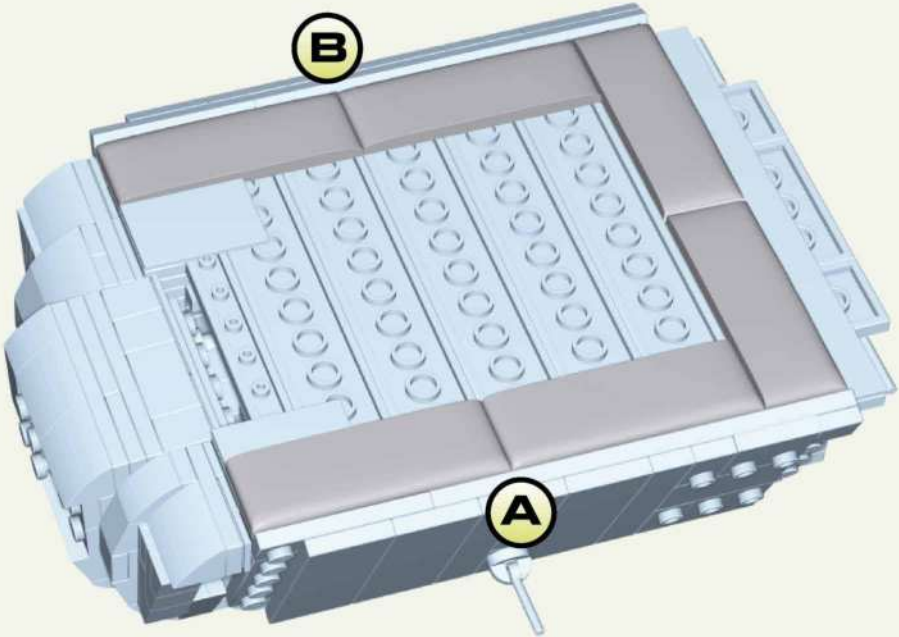
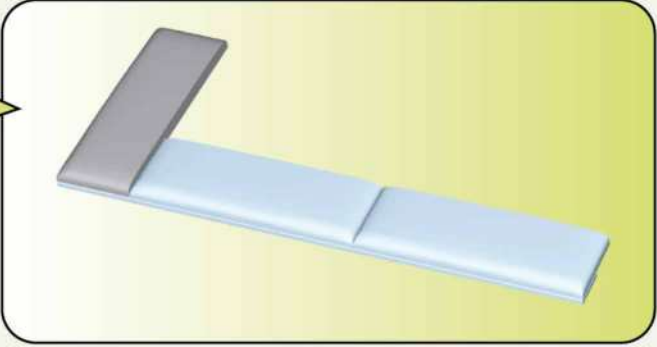
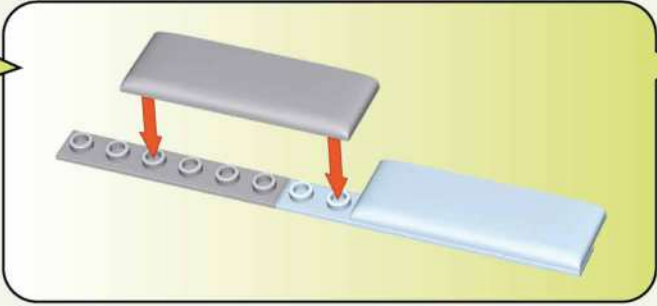
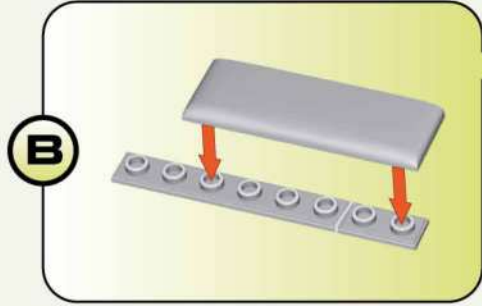
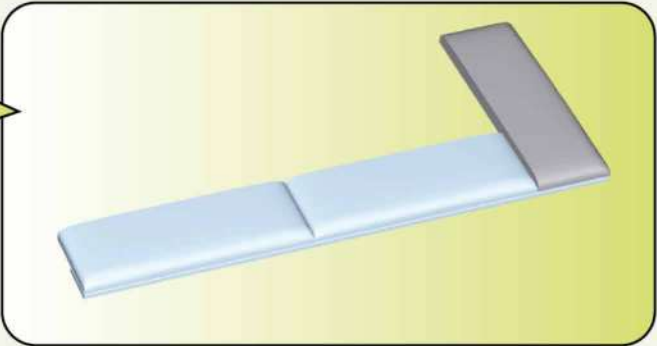
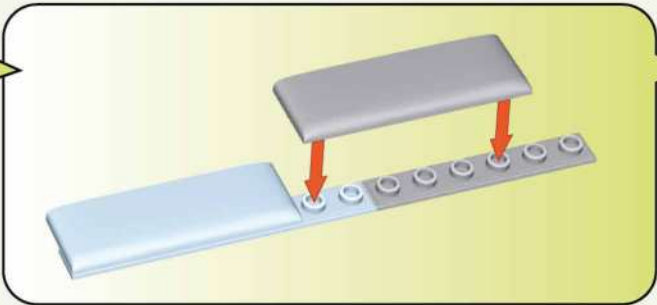
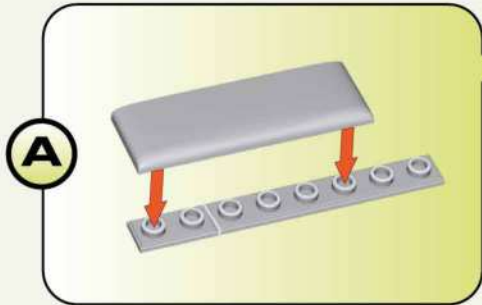

251

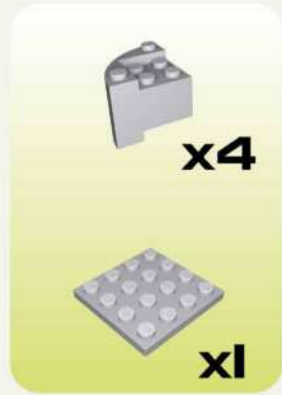
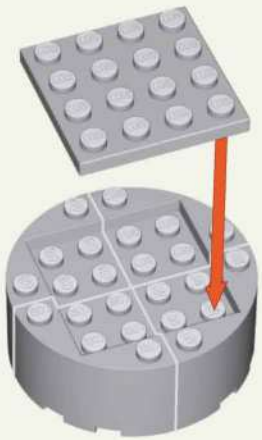

252

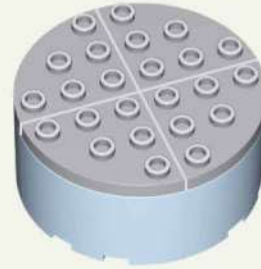

253

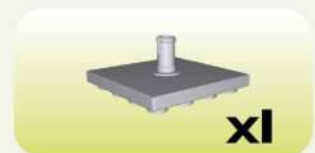
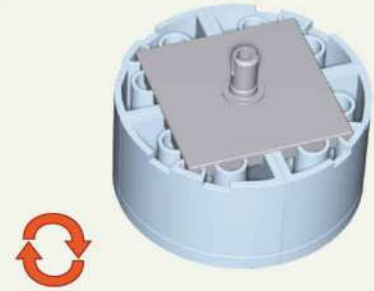

254

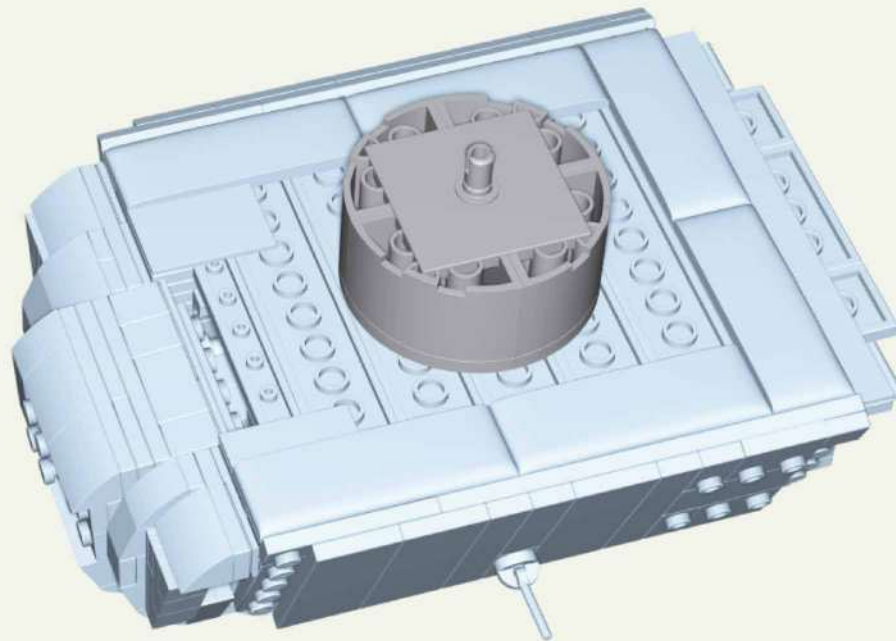

255

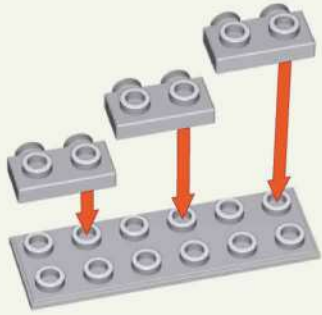

256



257



258

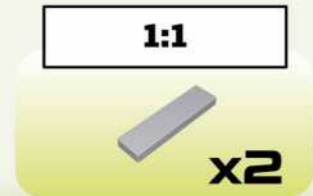

259

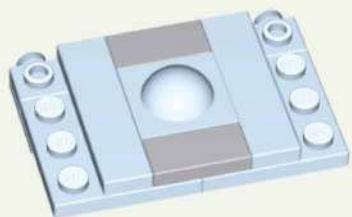

1:1



x2

260

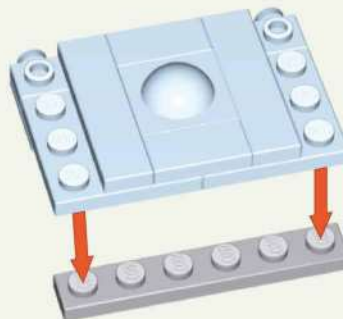

x1

261

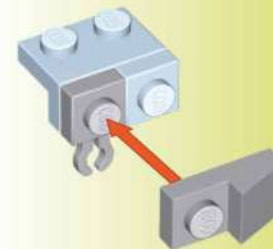
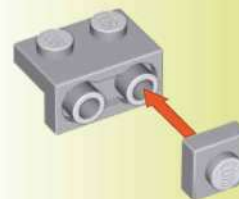
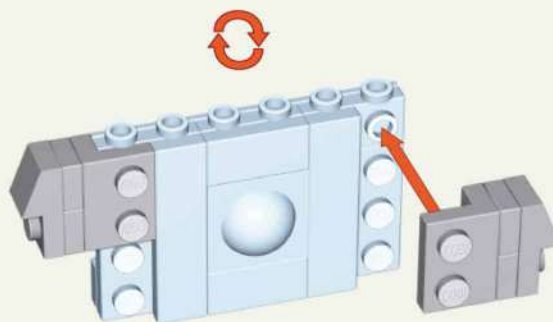
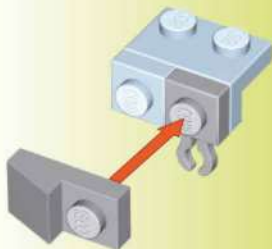
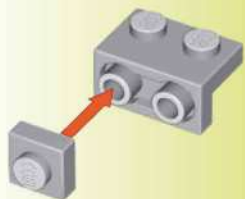

13



x2



x2



x2



x2

262

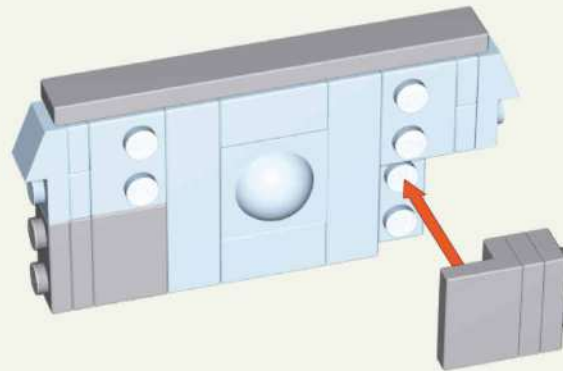
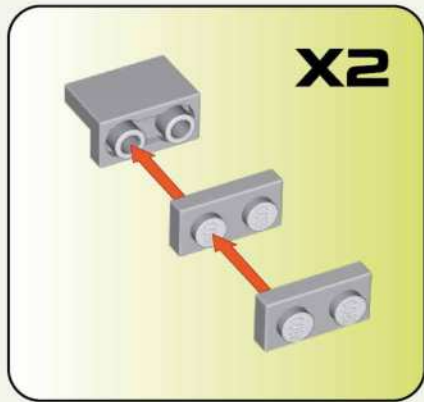

1:1

-  x1
-  x2
-  x4

263

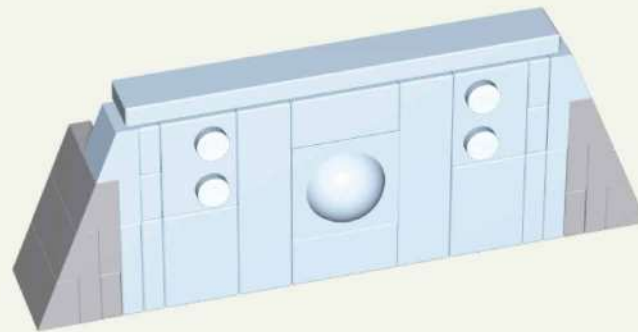
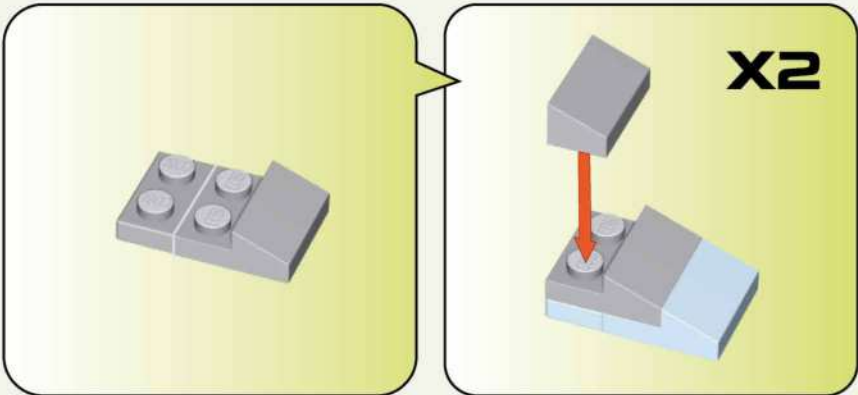

-  x2
-  x4
-  x2

264

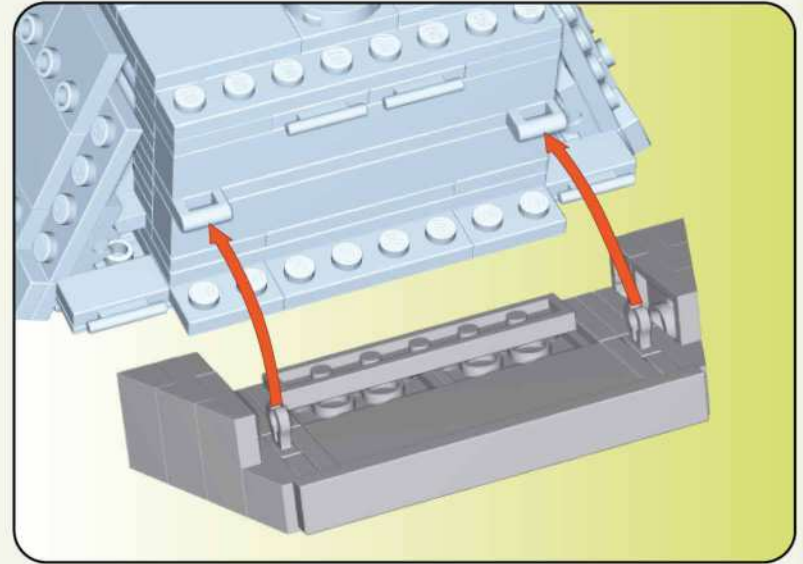
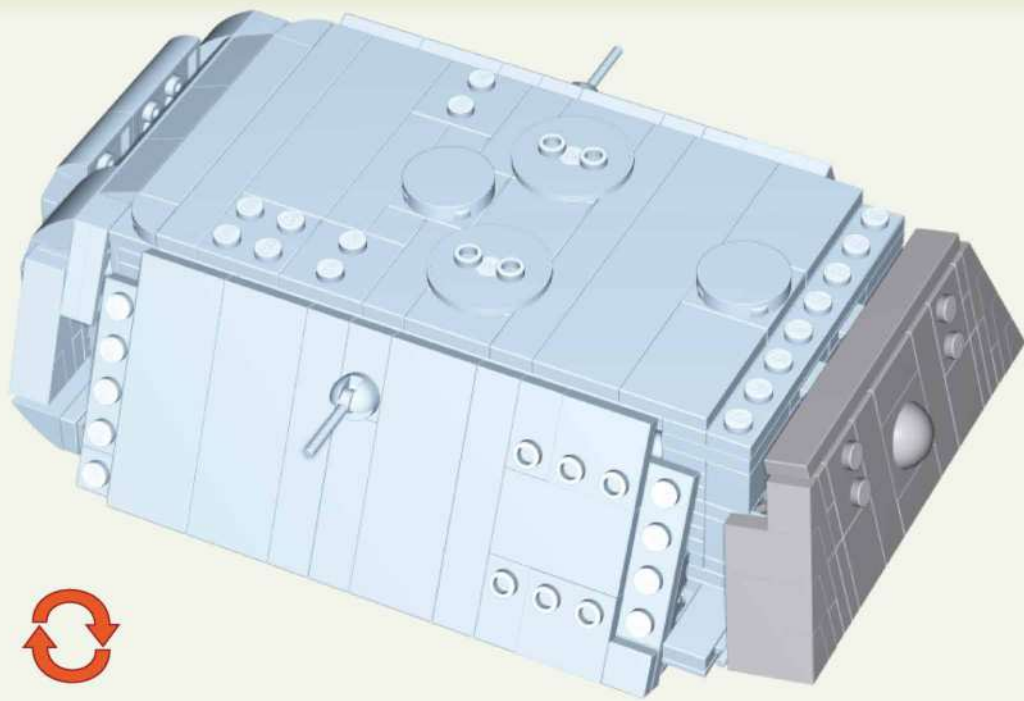

265

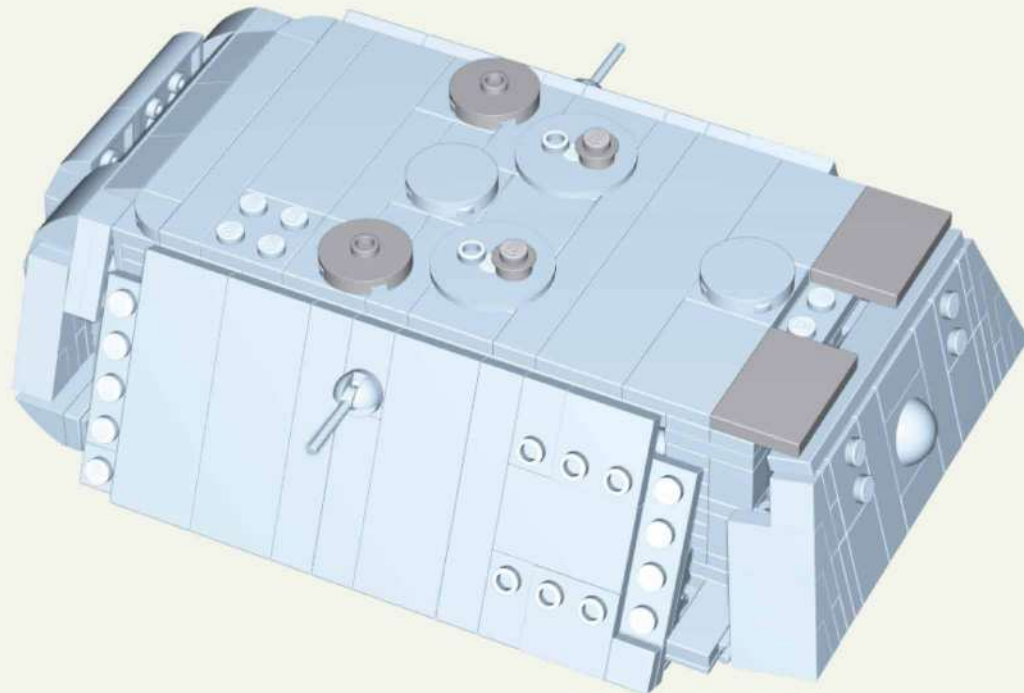

-  x2
-  x2
-  x2

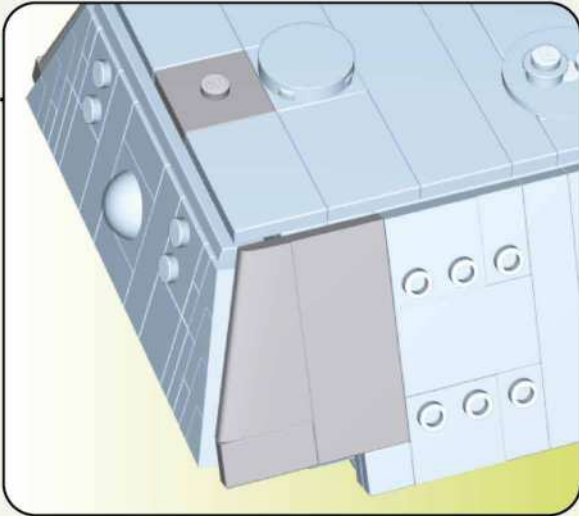
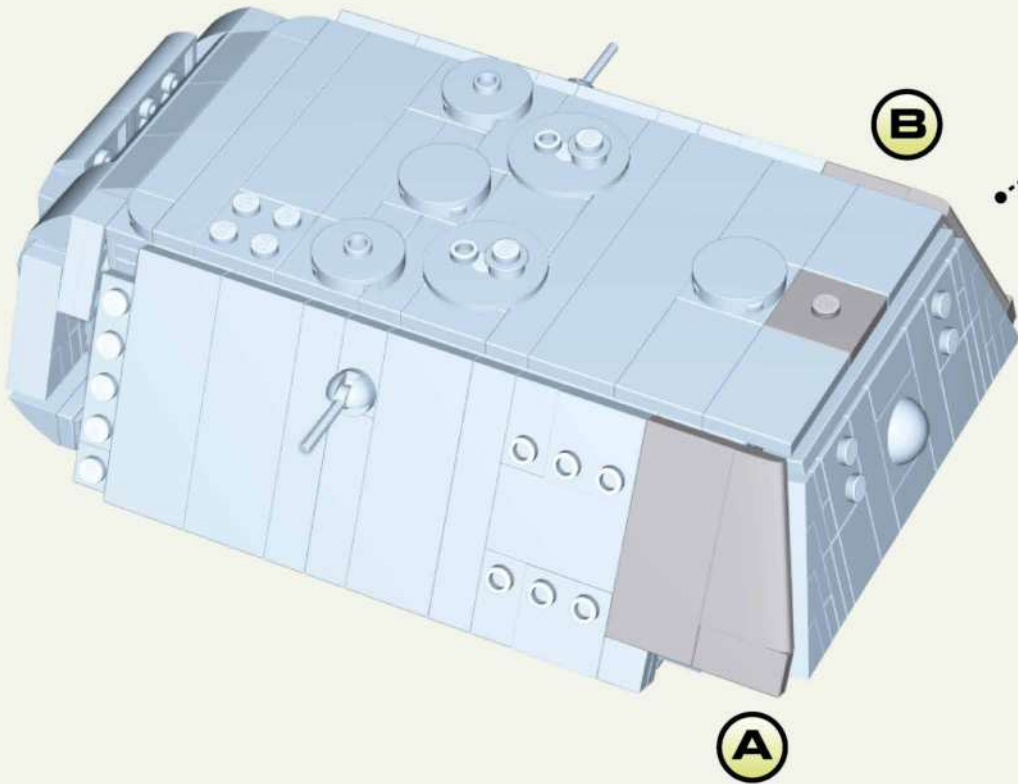
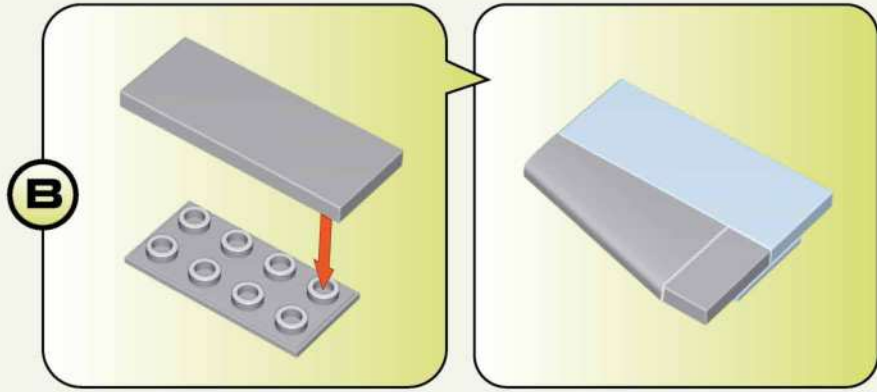
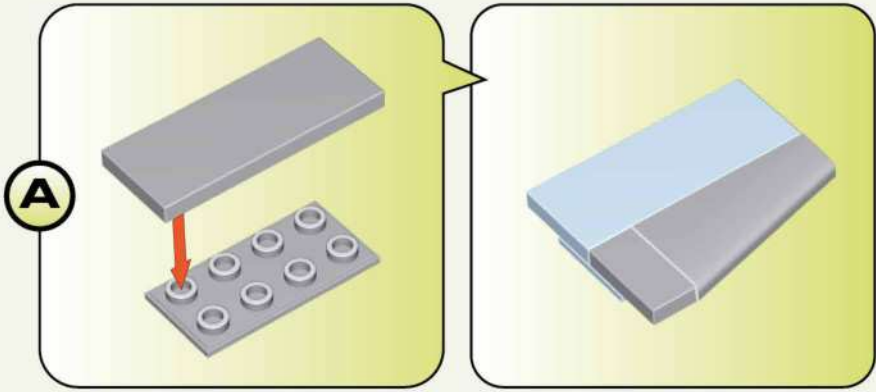

1:1

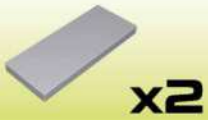

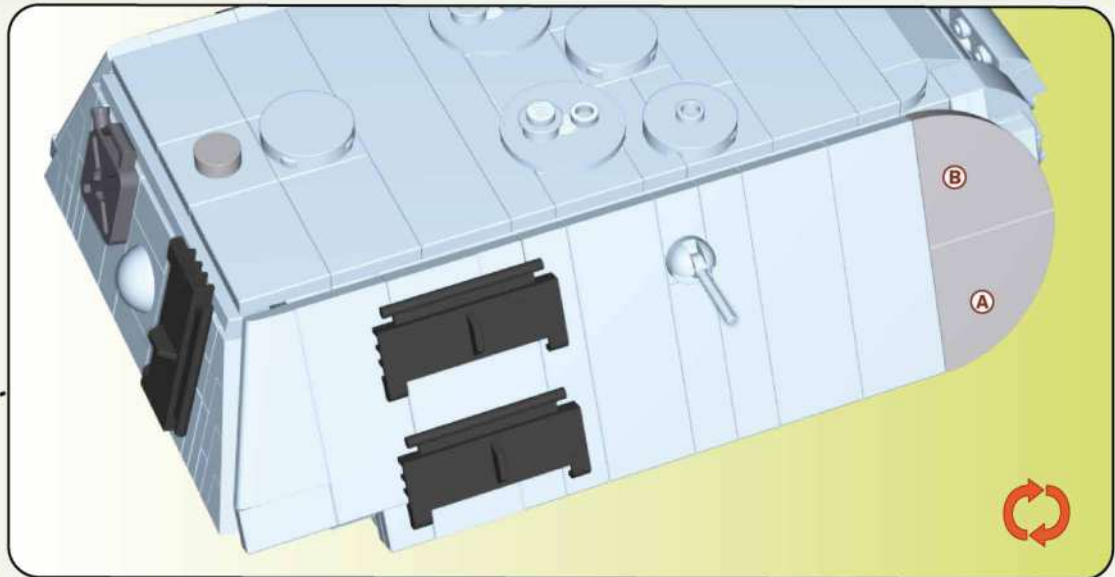

-  **x2**
-  **x2**
-  **x1**
-  **x5**
-  **x1**

268

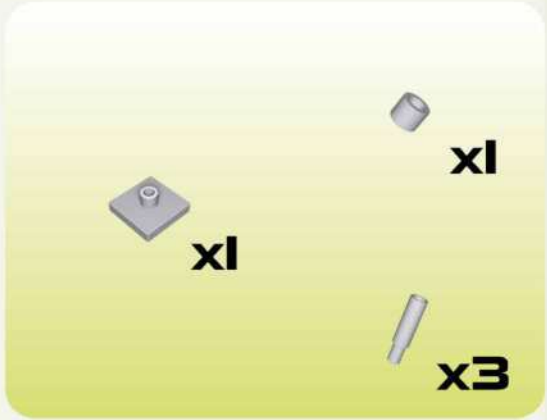
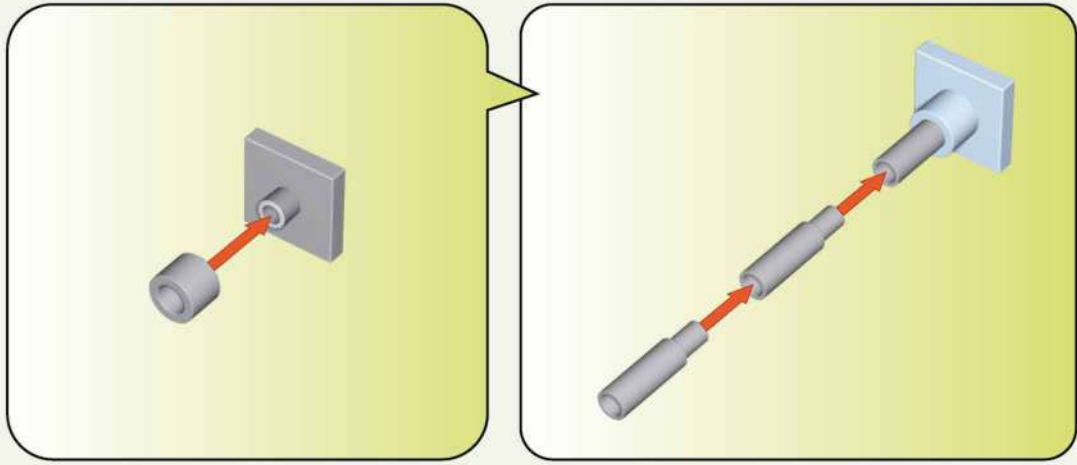

269

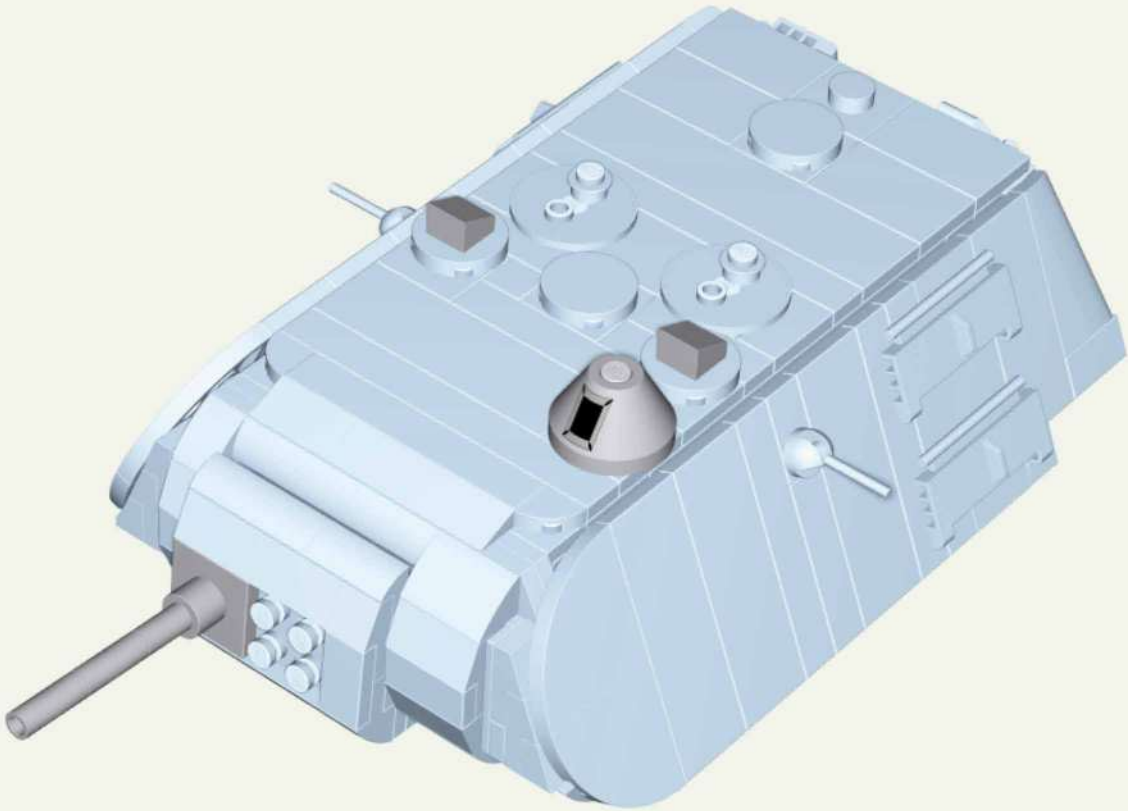

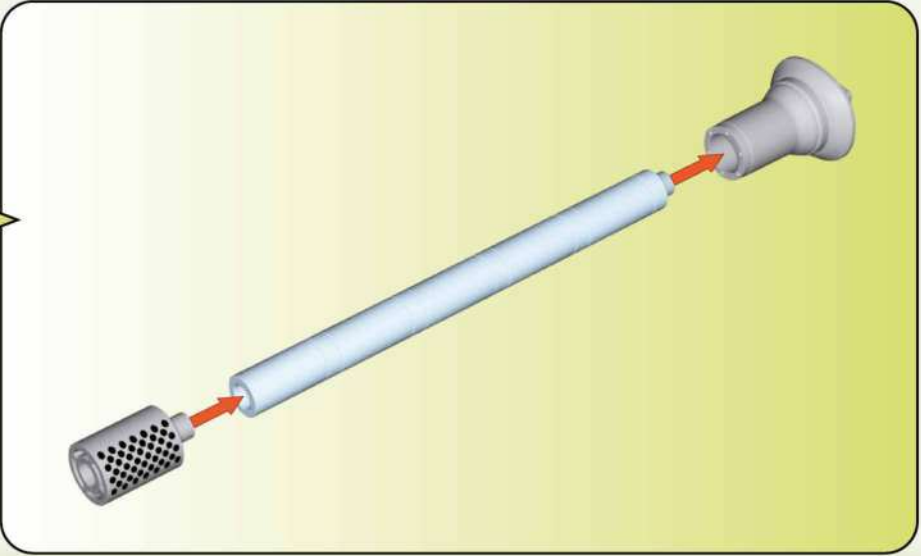
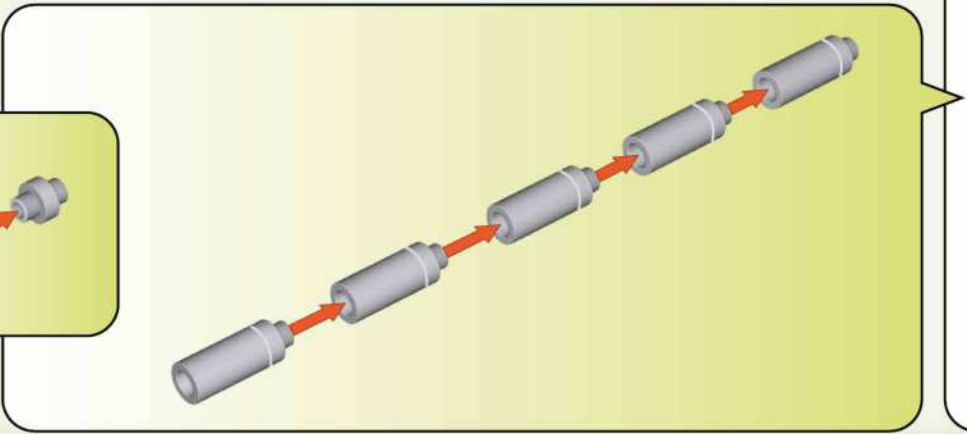
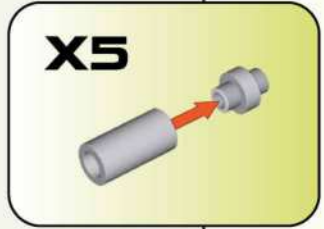
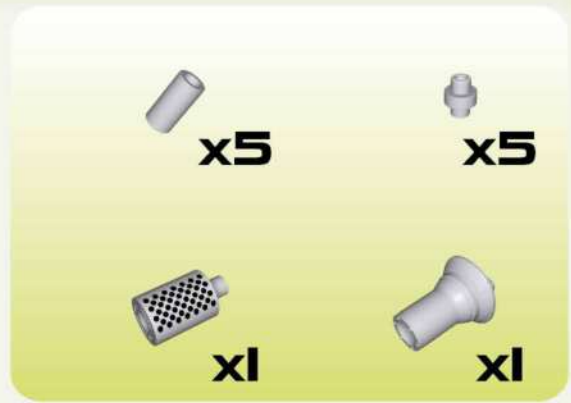

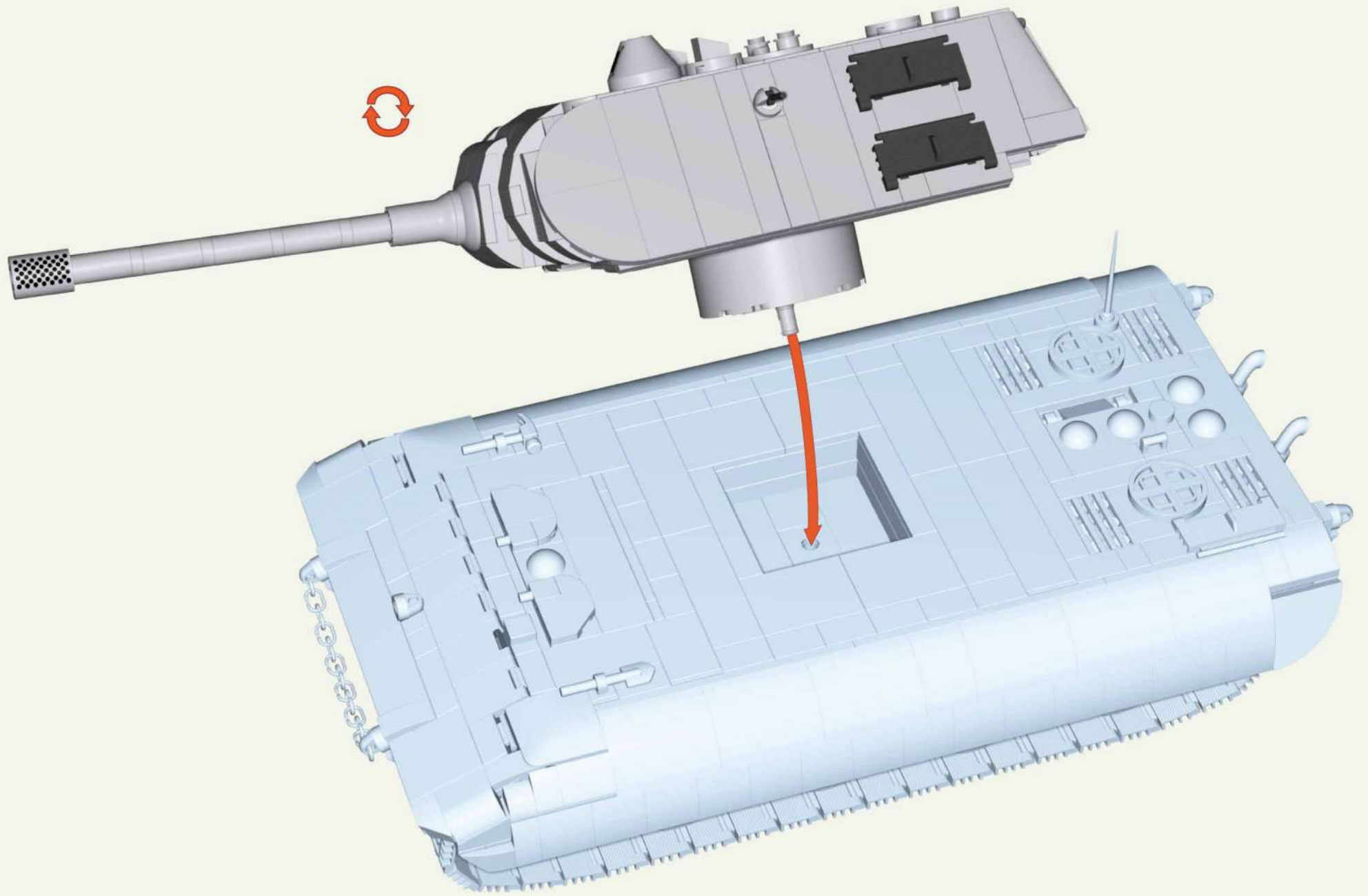

272 □ 274



272

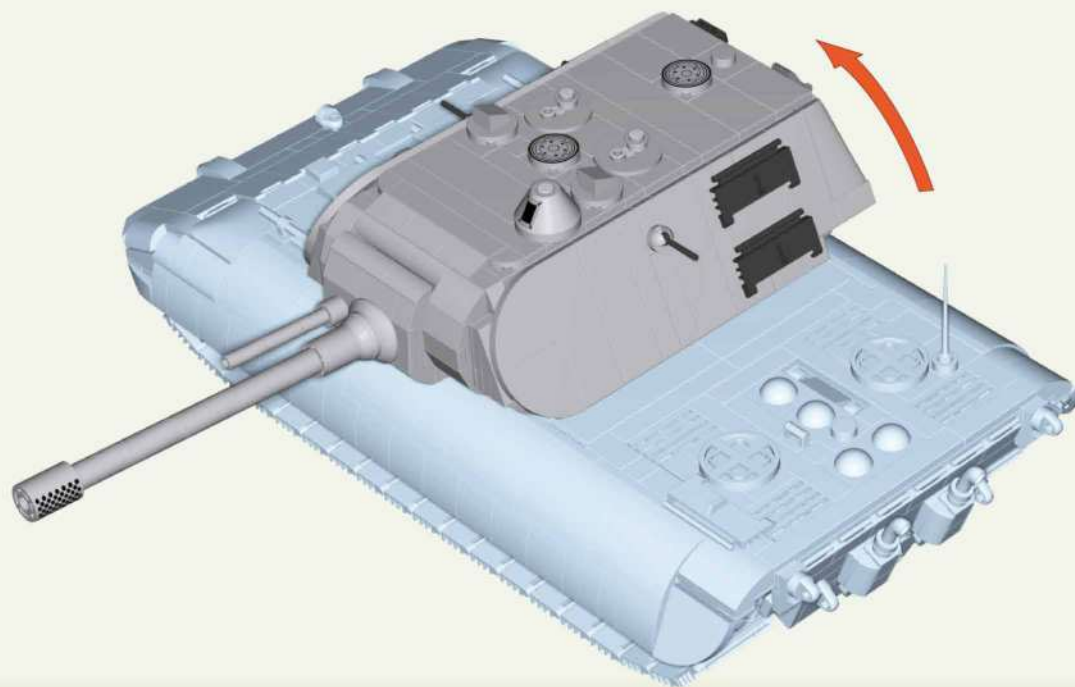

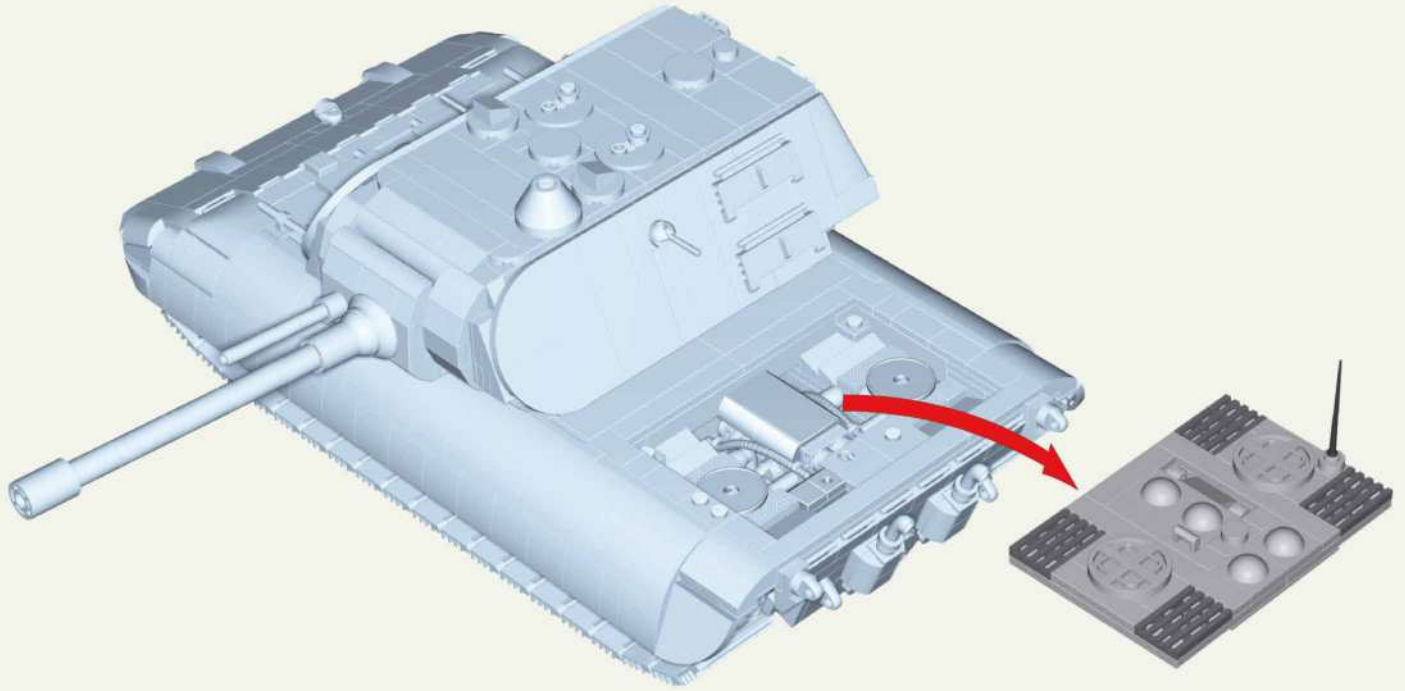
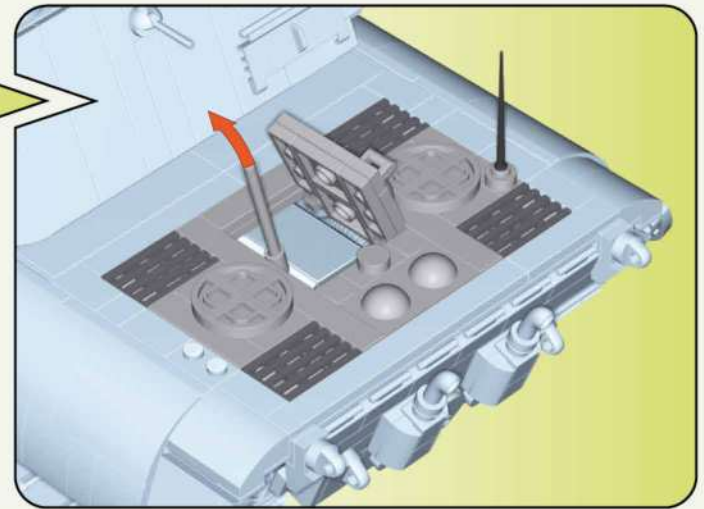
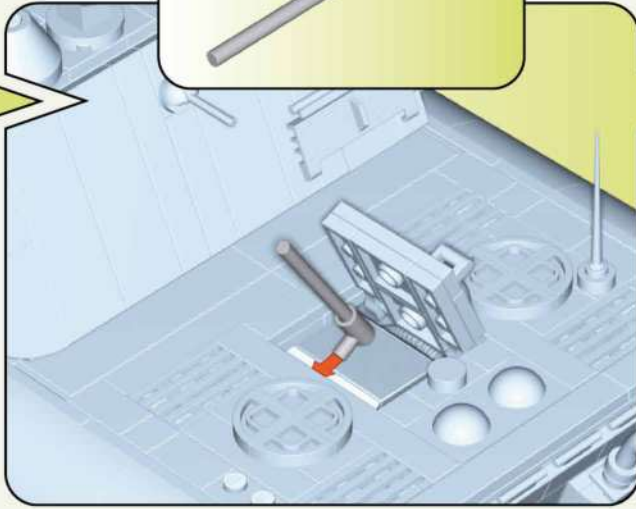
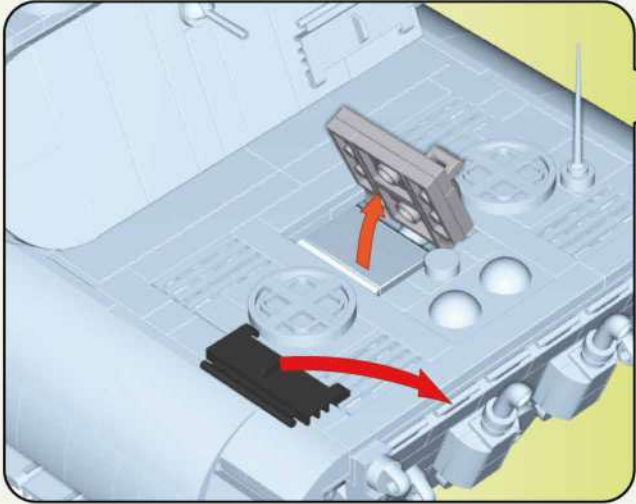
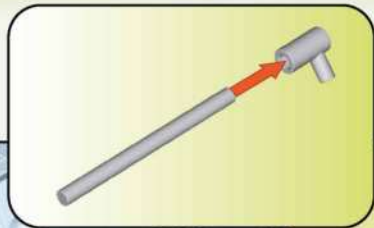

1:1



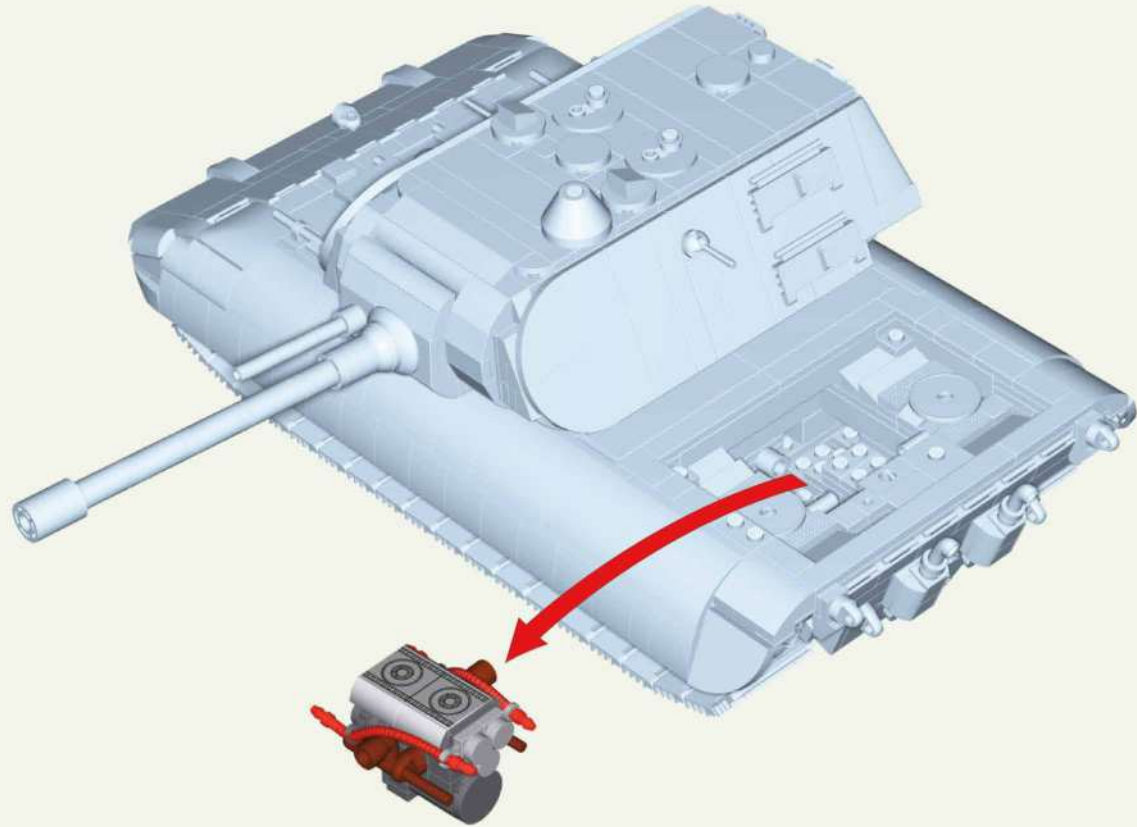

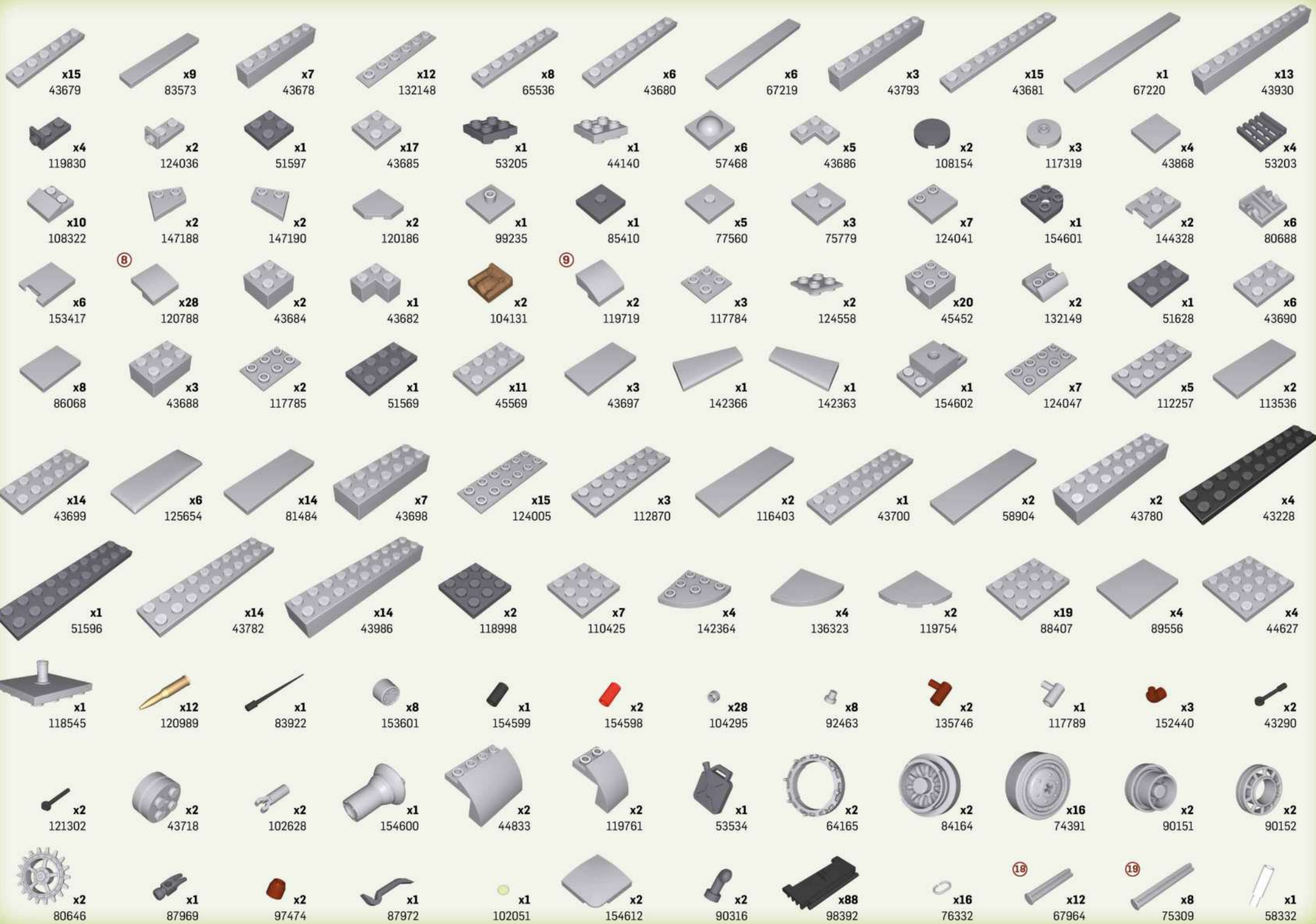

x15 43679 x9 83573 x7 43678 x12 132148 x8 65536 x6 43680 x6 67219 x3 43793 x15 43681 x1 67220 x13 43930

x4 119830 x2 124036 x1 51597 x17 43685 x1 53205 x1 44140 x6 57468 x5 43686 x2 108154 x3 117319 x4 43868 x4 53203

x10 108322 x2 147188 x2 147190 x2 120186 x1 99235 x1 85410 x5 77560 x3 75779 x7 124041 x1 154601 x2 144328 x6 80688

x6 153417 ⁸ x28 120788 x2 43684 x1 43682 x2 104131 ⁹ x2 119719 x3 117784 x2 124558 x20 45452 x2 132149 x1 51628 x6 43690

x8 86068 x3 43688 x2 117785 x1 51569 x11 45569 x3 43697 x1 142366 x1 142363 x1 154602 x7 124047 x5 112257 x2 113536

x14 43699 x6 125654 x14 81484 x7 43698 x15 124005 x3 112870 x2 116403 x1 43700 x2 58904 x2 43780 x4 43228

x1 51596 x14 43782 x14 43986 x2 118998 x7 110425 x4 142364 x4 136323 x2 119754 x19 88407 x4 89556 x4 44627

x1 118545 x12 120989 x1 83922 x8 153601 x1 154599 x2 154598 x28 104295 x8 92463 x2 135746 x1 117789 x3 152440 x2 43290

x2 121302 x2 43718 x2 102628 x1 154600 x2 44833 x2 119761 x1 53534 x2 64165 x2 84164 x16 74391 x2 90151 x2 90152

x2 80646 x1 87969 x2 97474 x1 87972 x1 102051 x2 154612 x2 90316 x88 98392 x16 76332 ¹⁸ x12 67964 ¹⁹ x8 75309 x1 58332





HISTORICAL COLLECTION



BATTLESHIP BISMARCK

 4841



BATTLESHIP TIRPITZ

 4839



DEWOITINE D.520
🇫🇷 5734

HISTORICAL COLLECTION



F4U-4™ CORSAIR®
⊕ 2417



NORTHROP GRUMMAN



JUNKERS JU-88
⊕ 5733



De HAVILLAND DH.98 MOSQUITO
🇬🇧 5735



CROMWELL MK.IV
🇬🇧 🇵🇱 2269



HISTORICAL COLLECTION



H.M.C M8 SCOTT
★ 2279



BM-13 KATYUSHA (ZIS-6)
★ 2280



MARDER III Ausf. M
+ 2282



Sd. Kfz. 9/1 „FAMO”
+ 2281



SHERMAN IC FIREFLY HYBRID
★ 🇬🇧 🇵🇱 2276

WWW.COBIBRICKS.COM

03-02572-1500

For news and special deals

Find us on:
f cobibricks
i cobiklocki
y COBI SA