

# HISTORICAL COLLECTION

## WORLD WAR II



**Sd.Kfz. 173 JAGDPANTHER**  
 IN SERVICE - 1944 - 1945  
 PLACE OF ORIGIN - GERMANY  
 TYPE - TANK DESTROYER  
 WEIGHT - 45t (100 000lb)  
 ARMOUR - 80mm (3.15") AT THE FRONT  
 ARMAMENT - 8,8cm (3.46") PAK 43 L/71,  
 1x 7,92mm (.312") MG34  
 ENGINE - MAYBACH HL230 P30, 520kw (700hp)  
 SPEED - 55km/h (34MPH)  
 RANGE - 250km (155mi)  
 CREW - 5



2574

**PAD PRINTED  
NO STICKERS**

**Printed in EU**



**WARNING: CHOKING HAZARD-**  
 Toy contains small parts.  
 Not for children under 3 years.

950 1

**Sd.Kfz. 173 JAGDPANTHER**

**SCALE 1:28**

BE CAREFUL: NOTICE THE DIFFERENCE

1



2



3



4



UWAGA: RÓŻNE KLOCKI



1

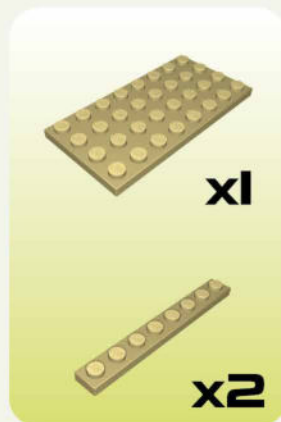
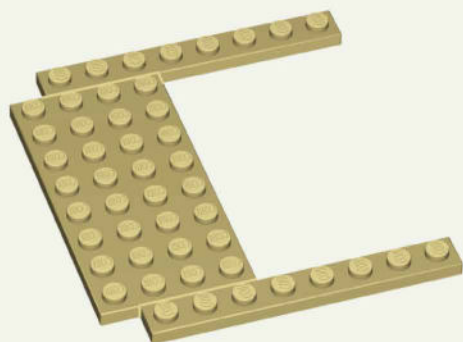

2

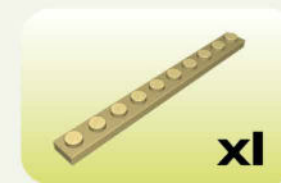
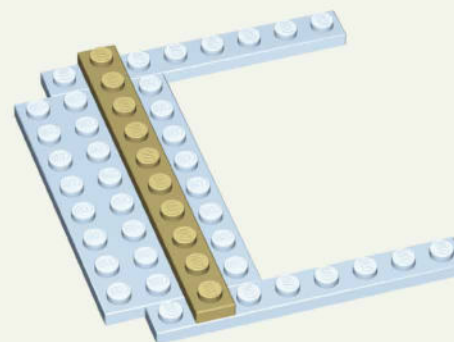

3

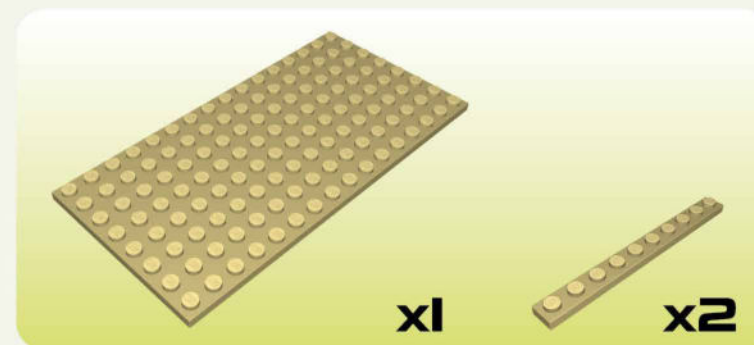
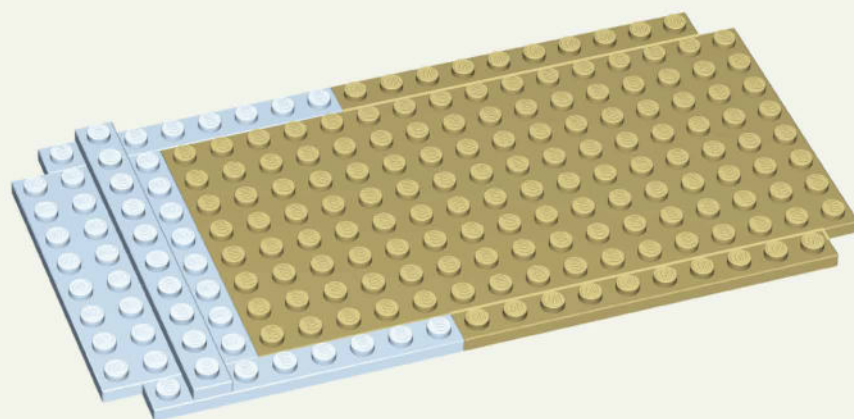



4

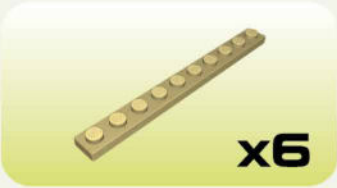
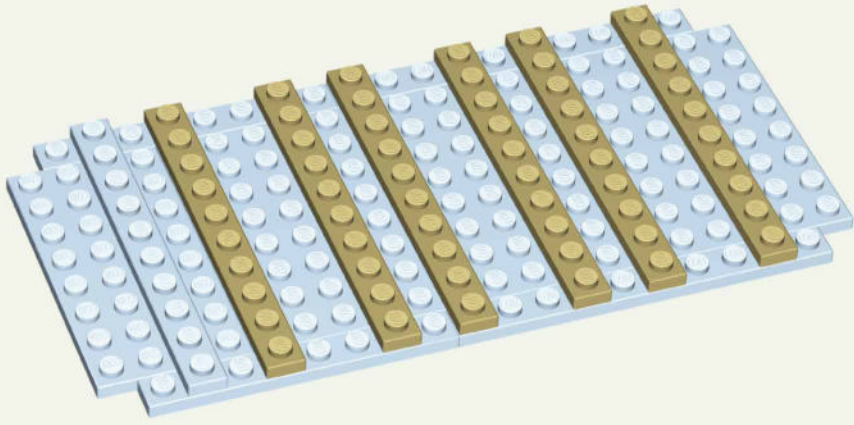

5

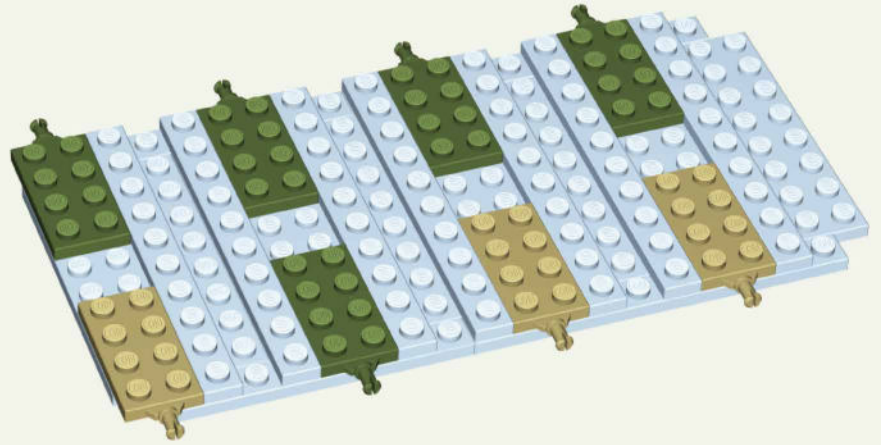

6

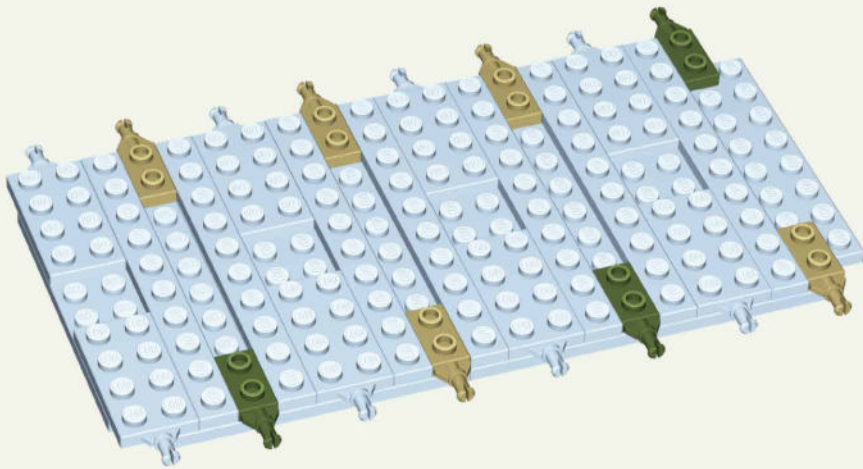





10

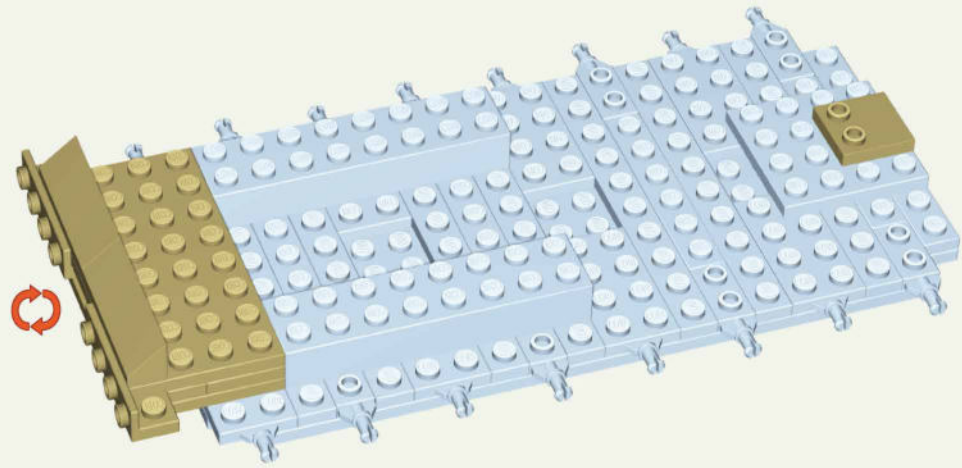
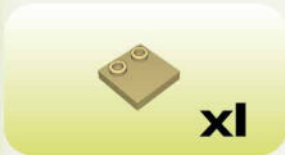

11

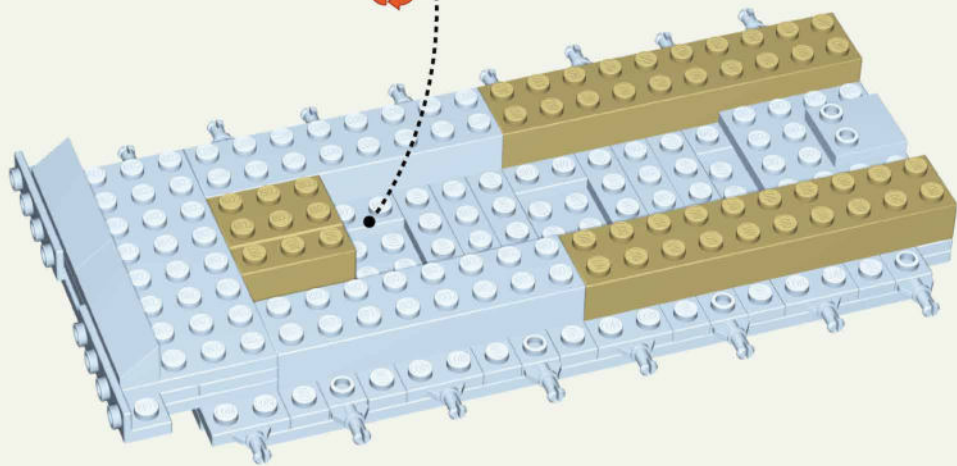
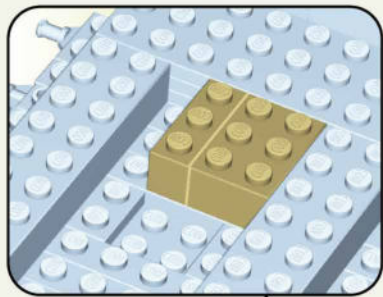

12

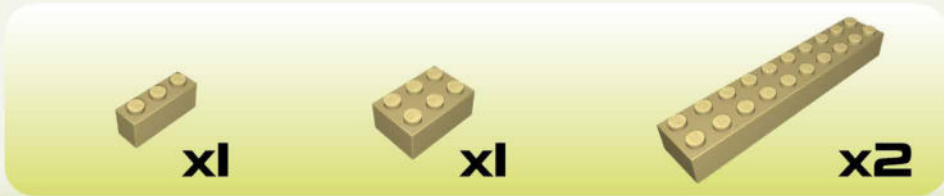
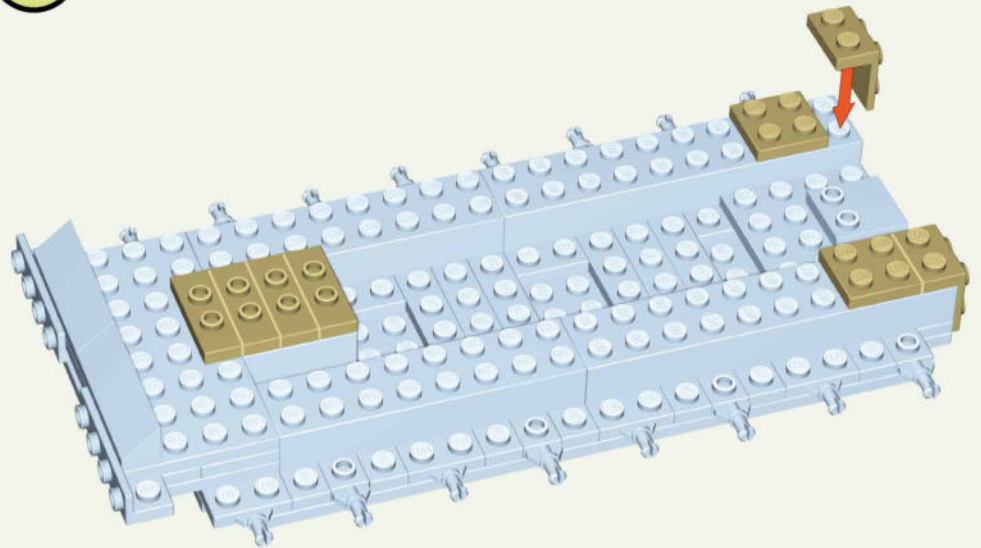

13

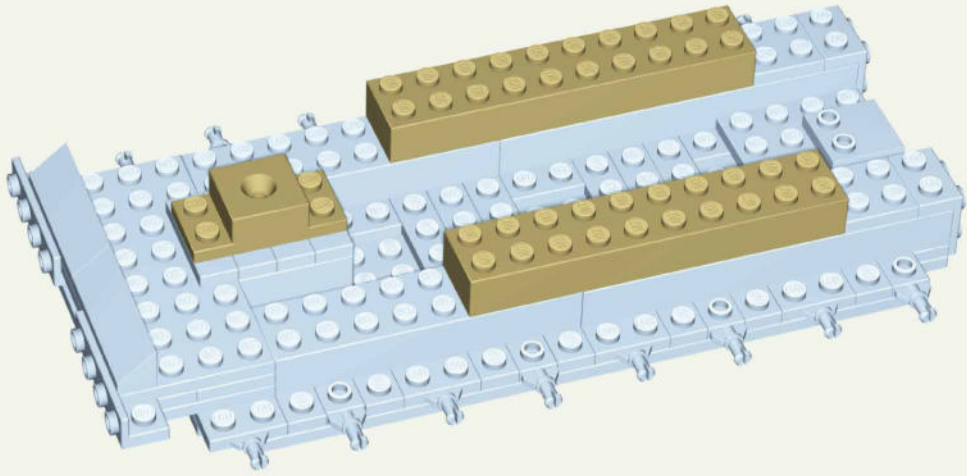

14

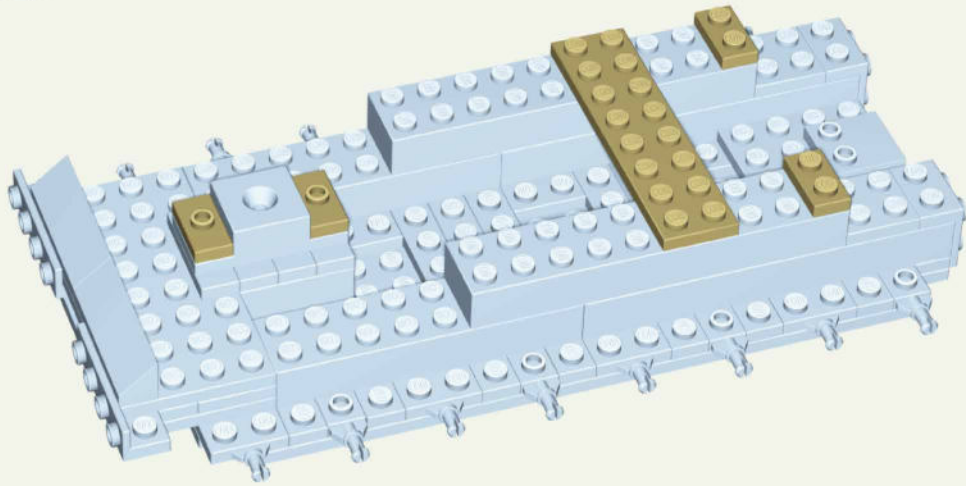

15

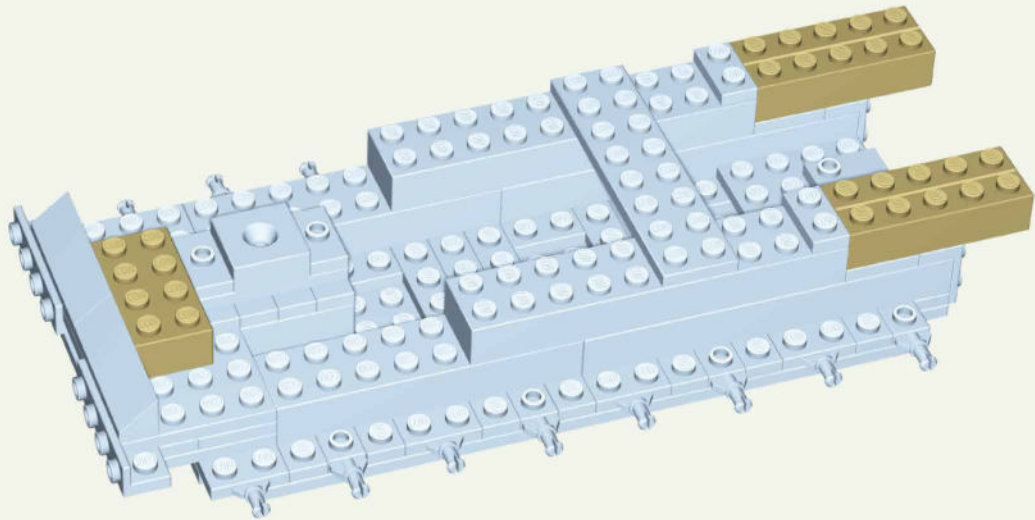





19

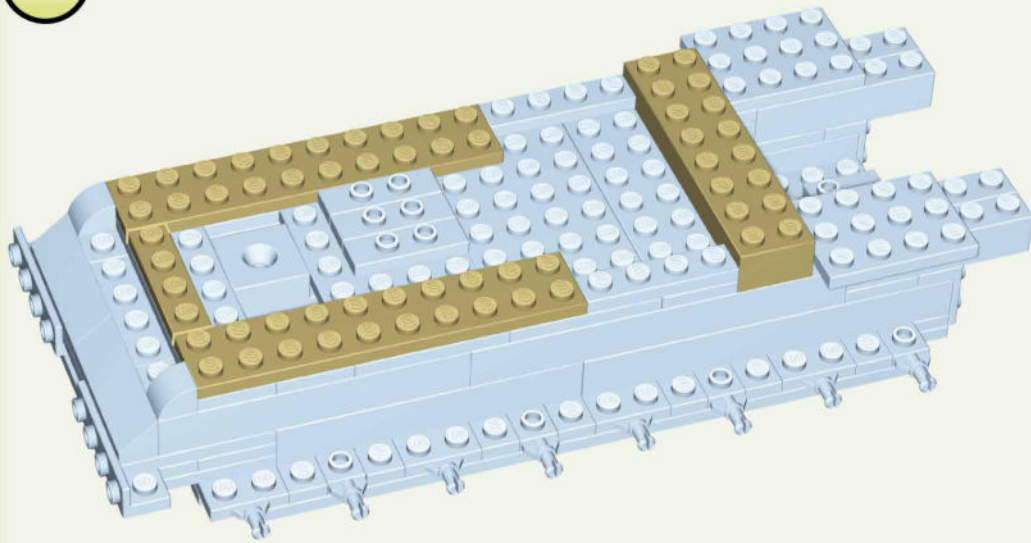

20

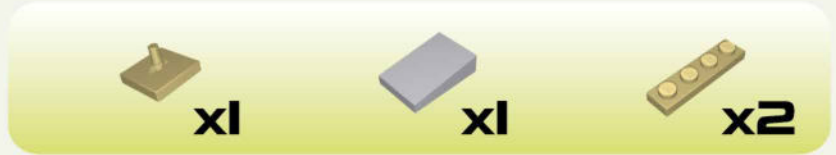
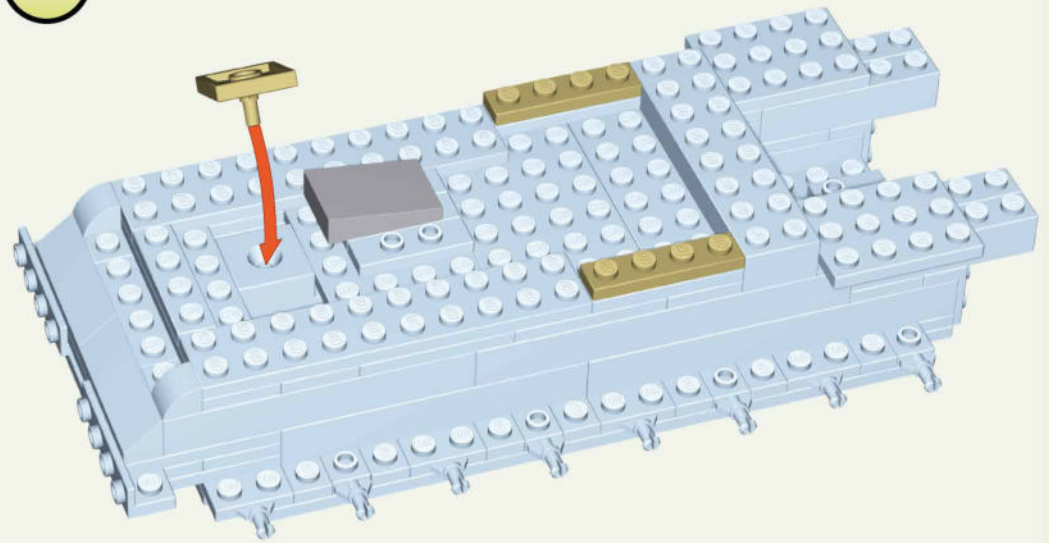

21

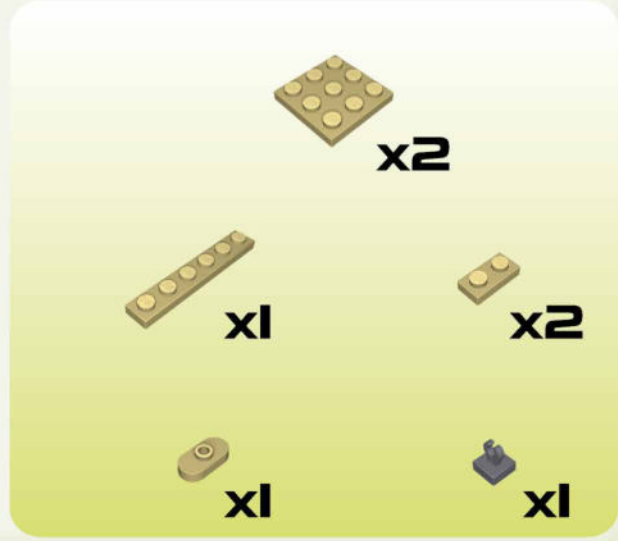
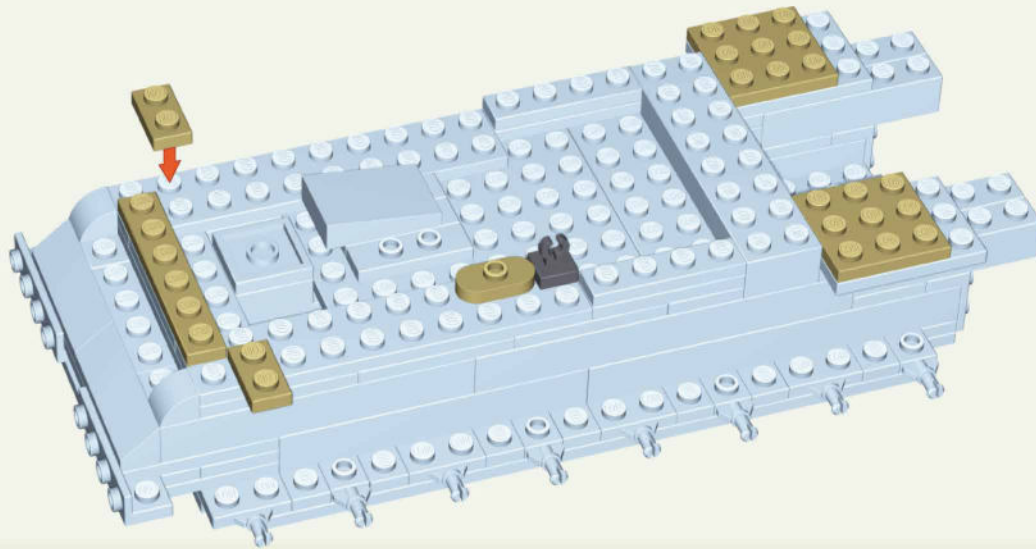



22



x1



x1

23

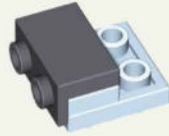

x1

24

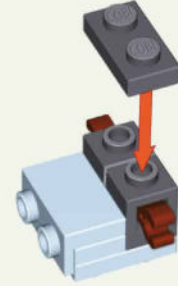

x2



x2



x2



x1

25



x1



x1

26

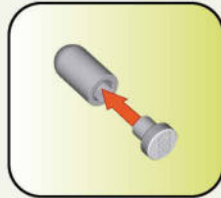
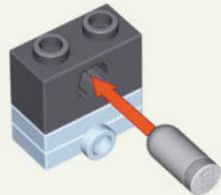

x1



x1



x1

27



x2

28

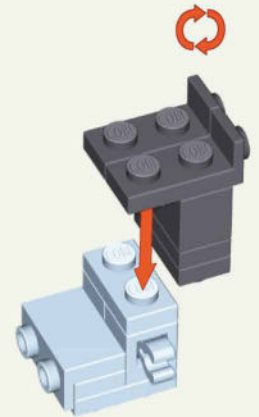

29

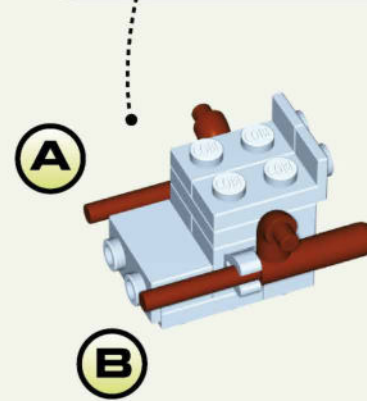
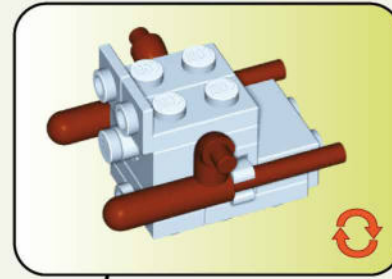
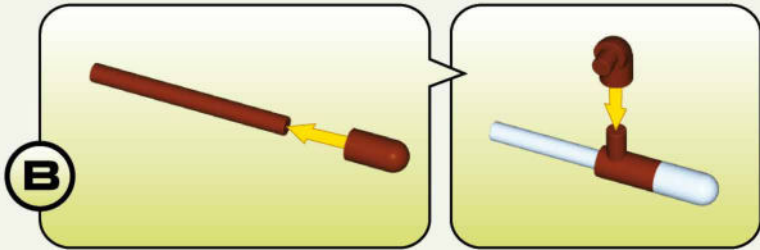
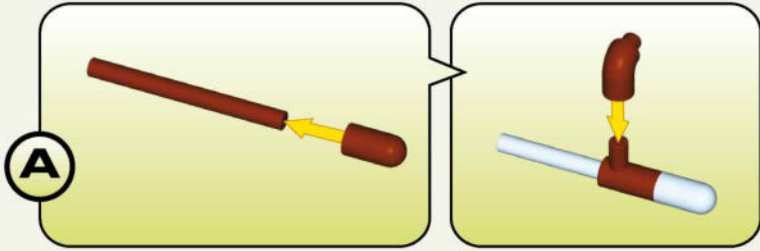

1:1



30

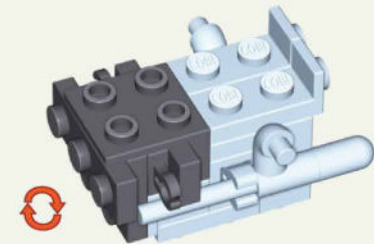
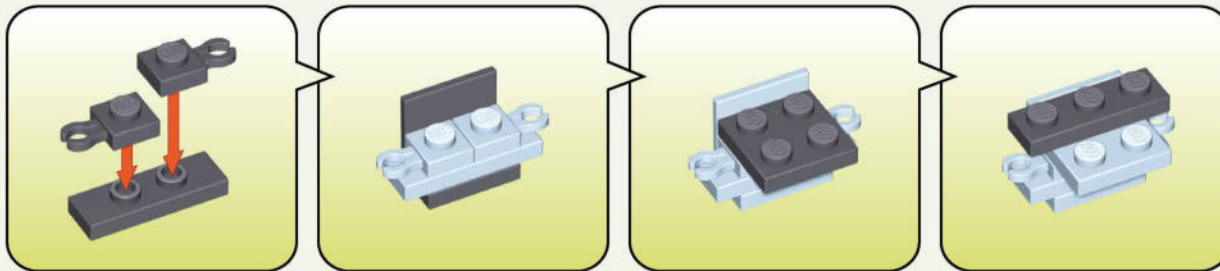



31

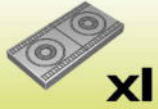
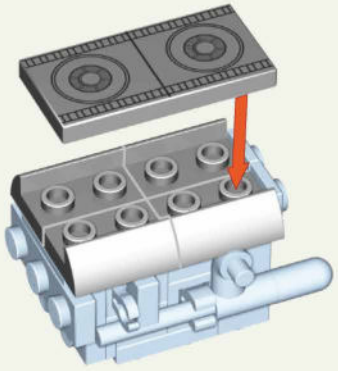

32

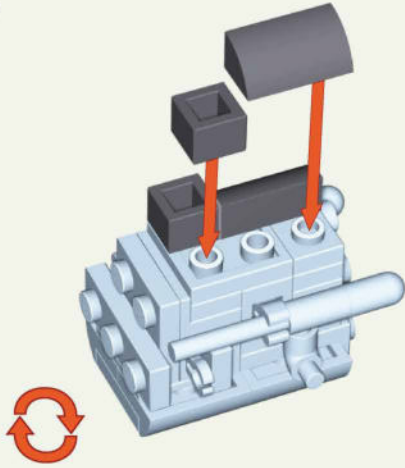

33

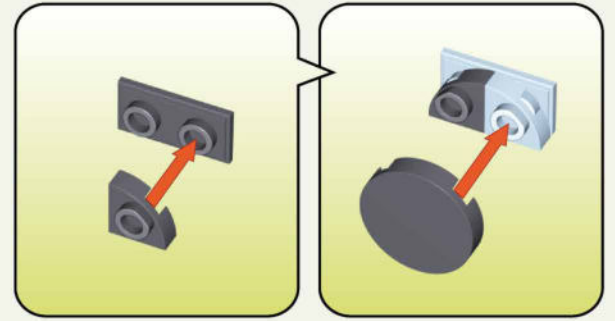

34

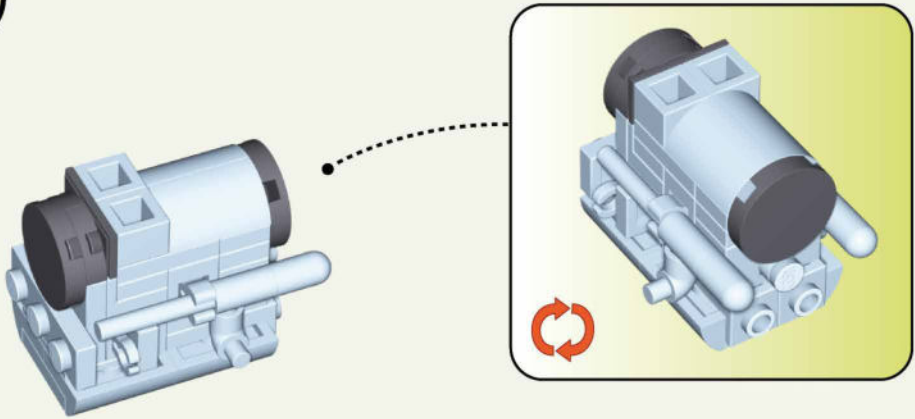

35

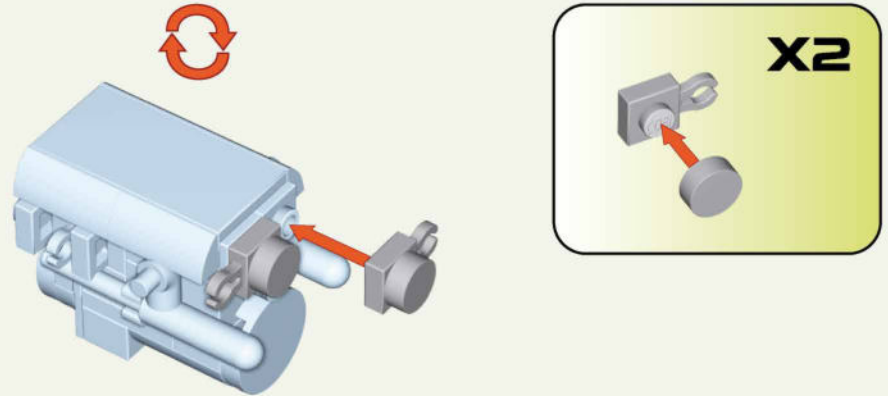

36

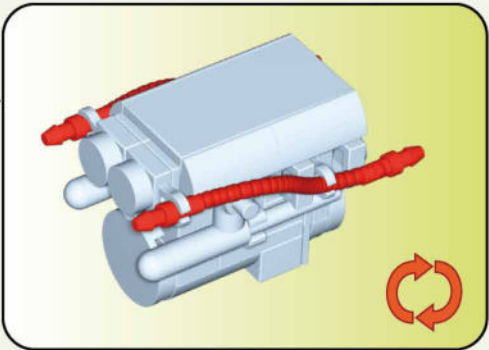
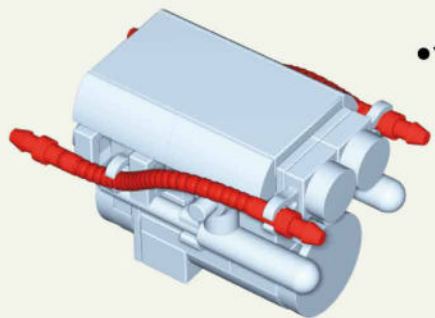

37

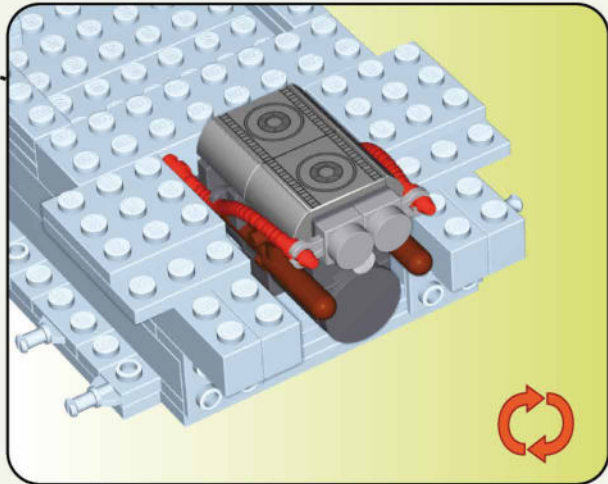
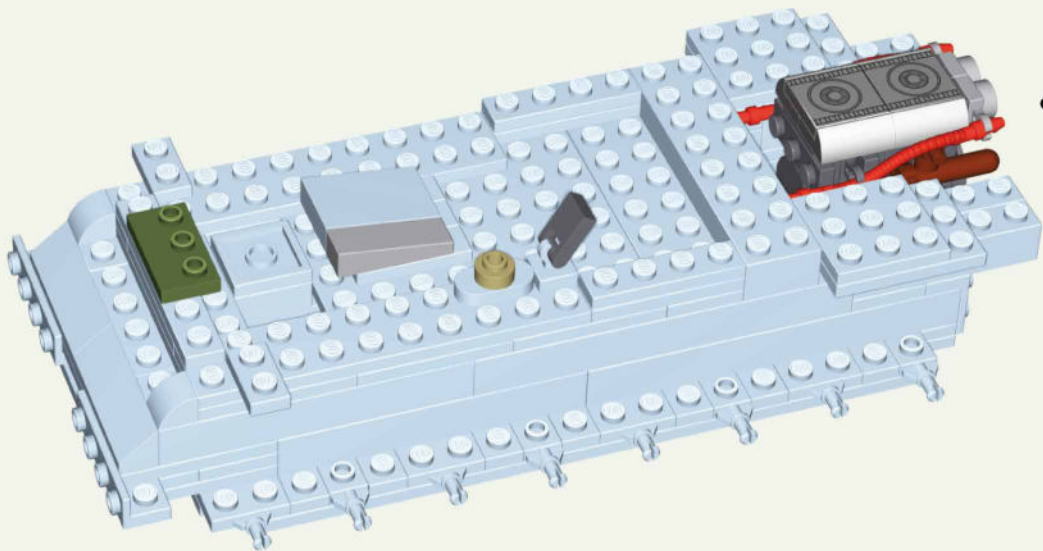



38

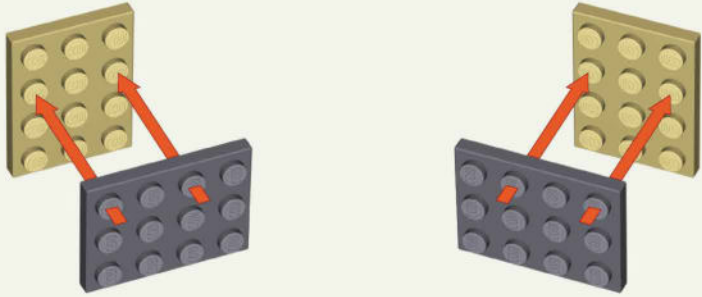

39

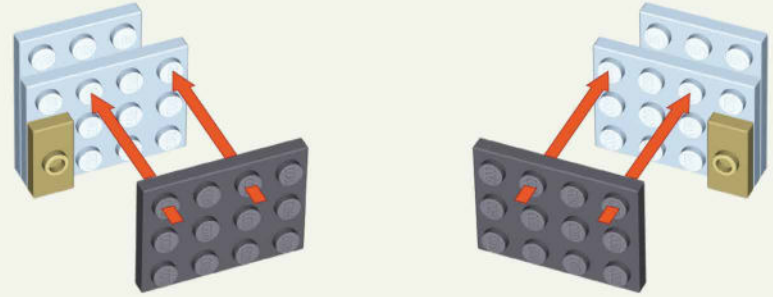

40

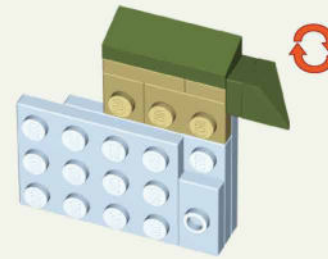
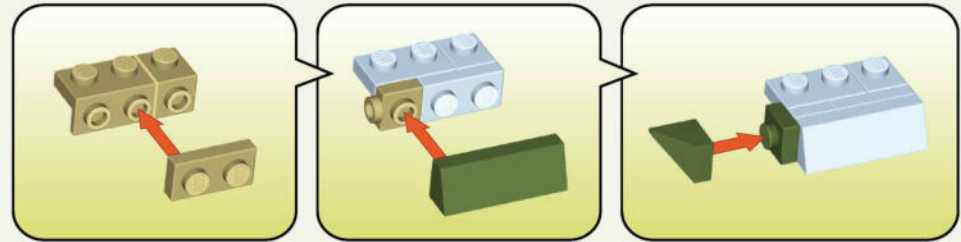
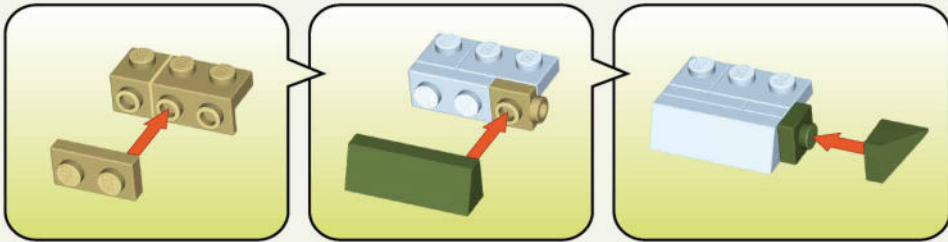

41

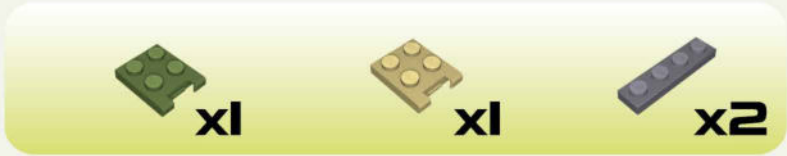
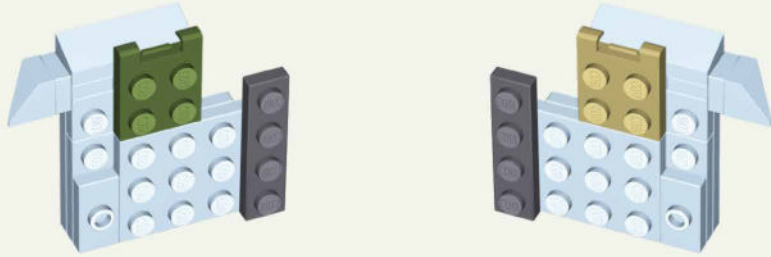

42

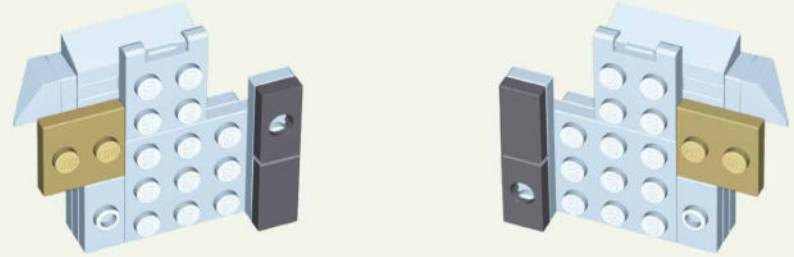

43

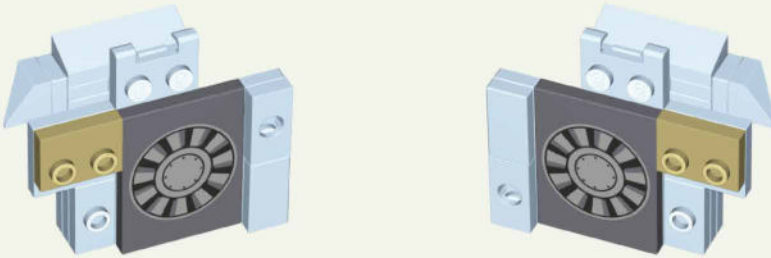

44

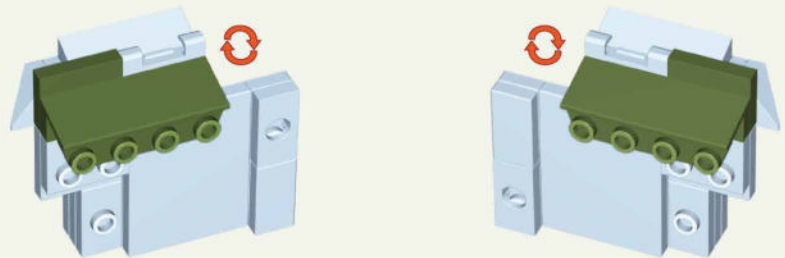
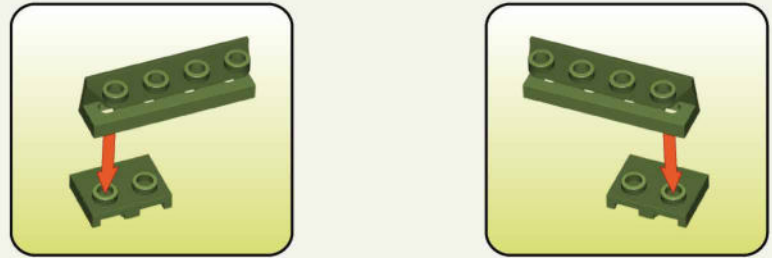

45

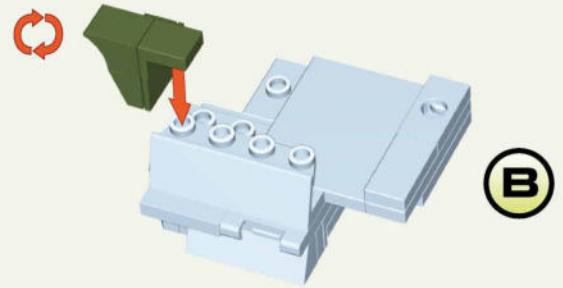
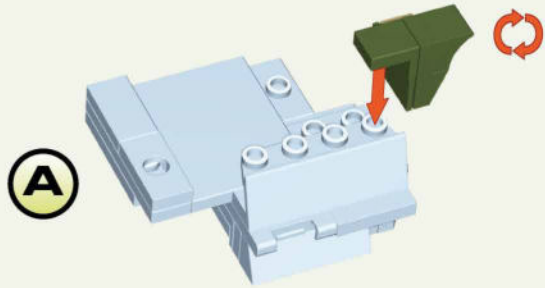
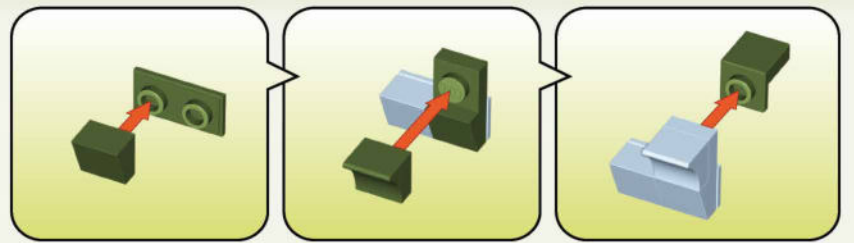
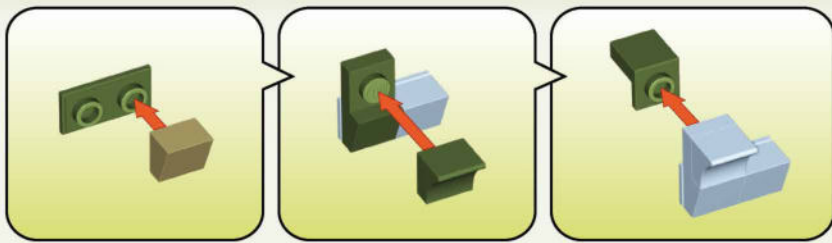

46

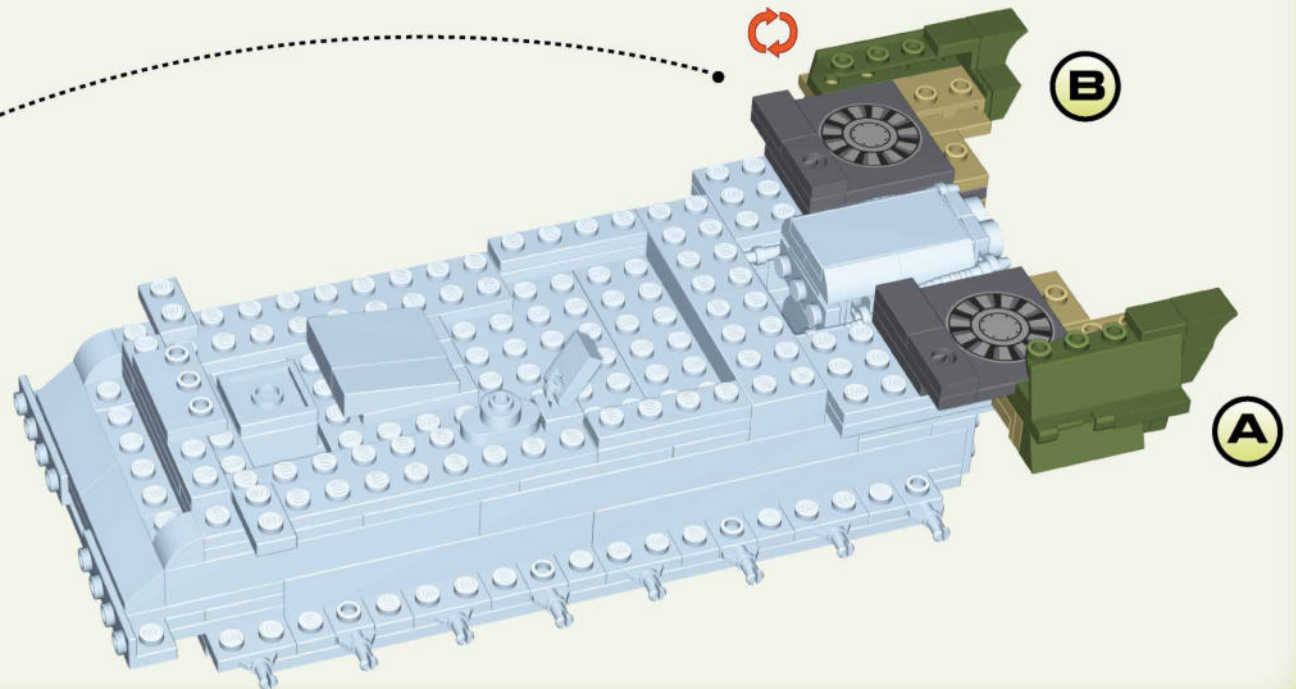
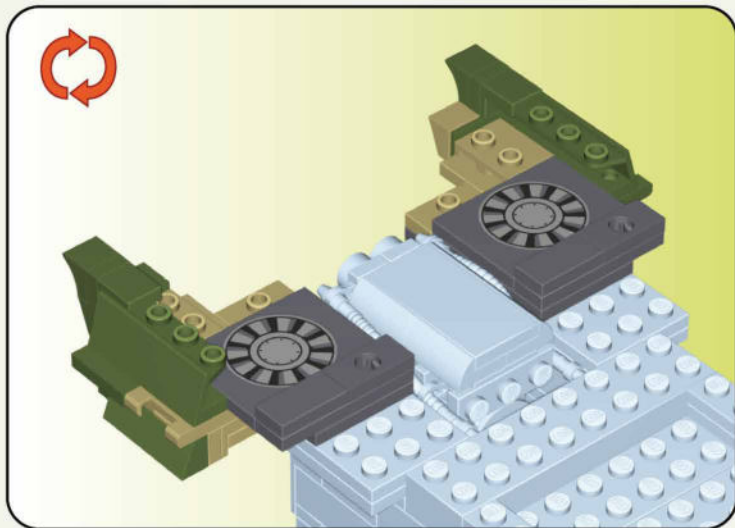



47

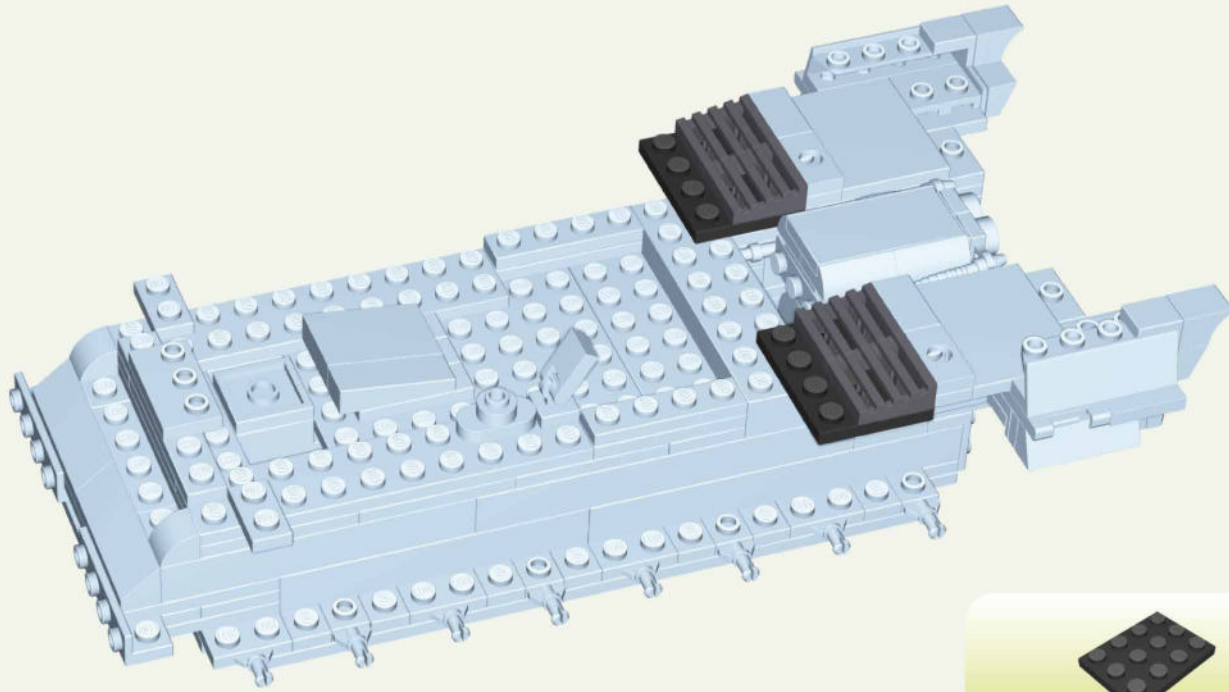
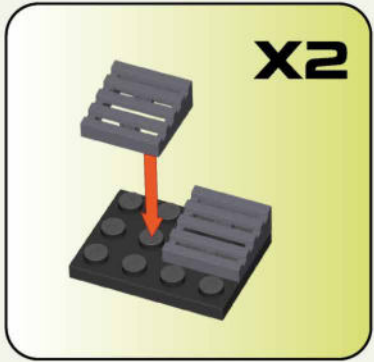

48

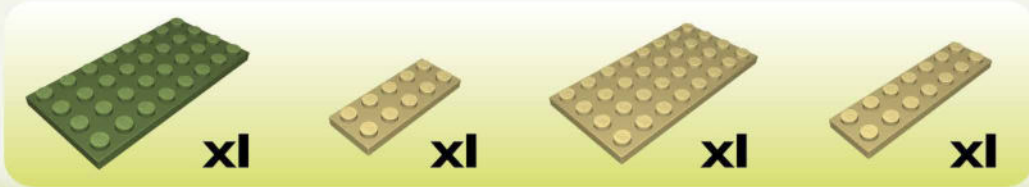
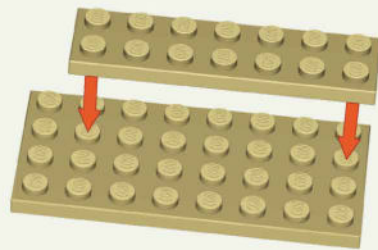
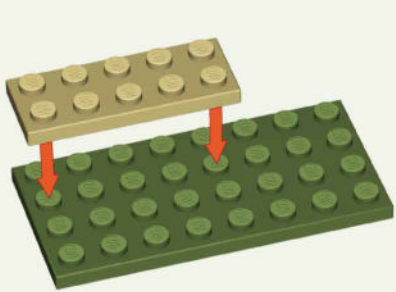

49

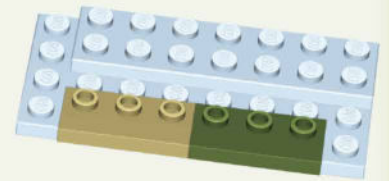

50



51

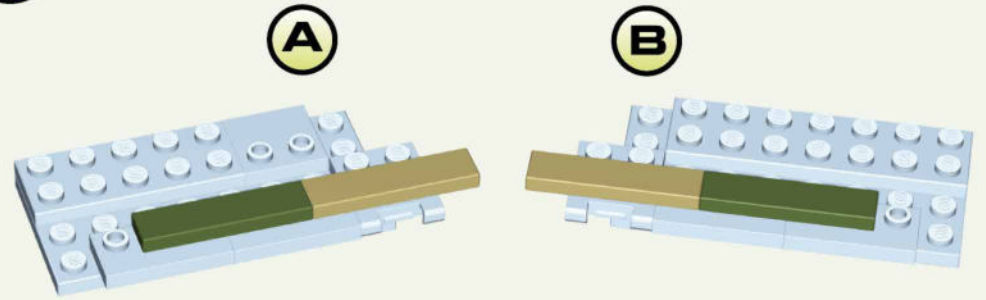

52

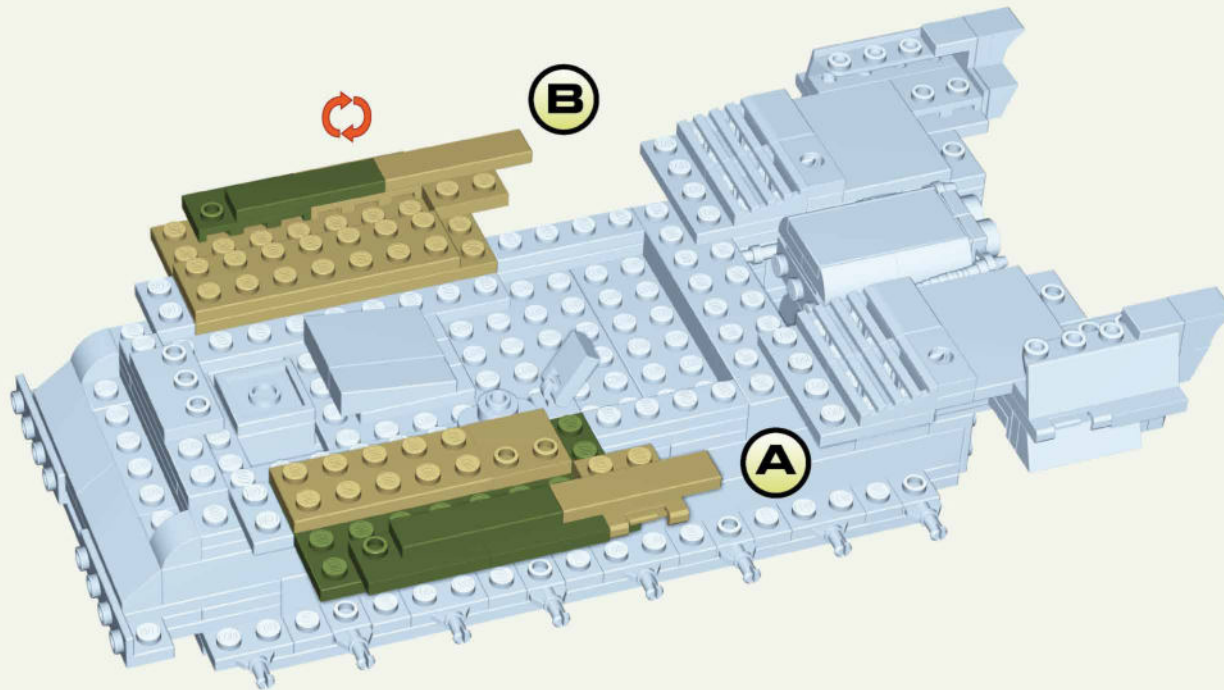

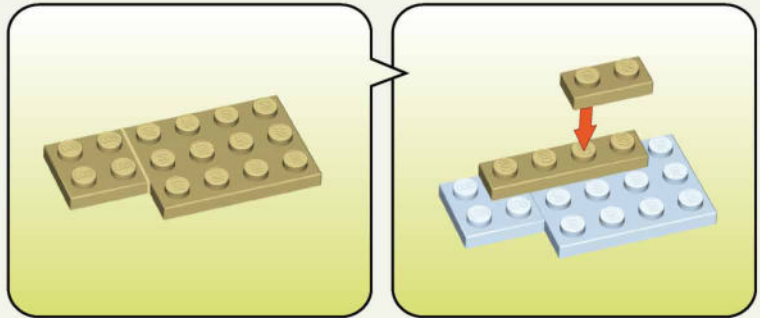
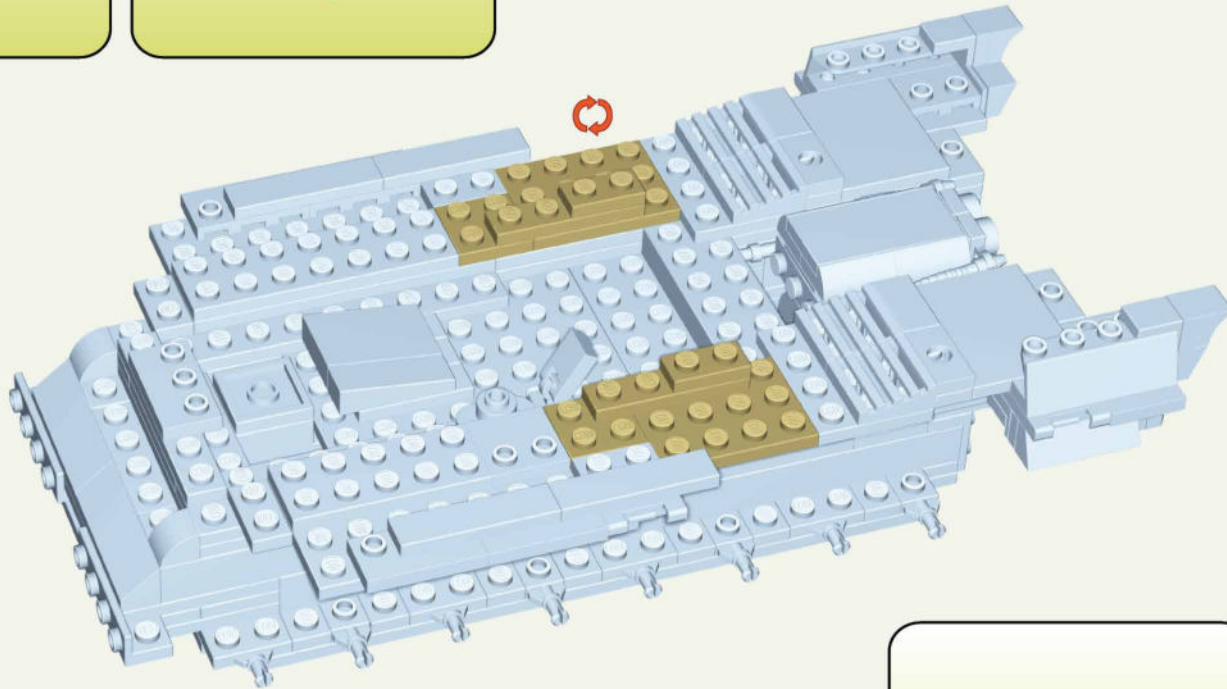
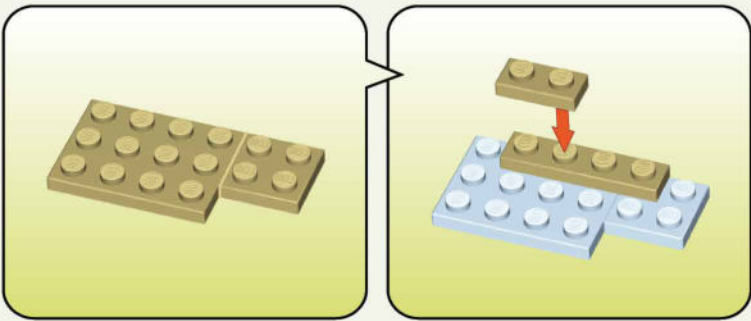

-  x2
-  x2
-  x2
-  x2



54

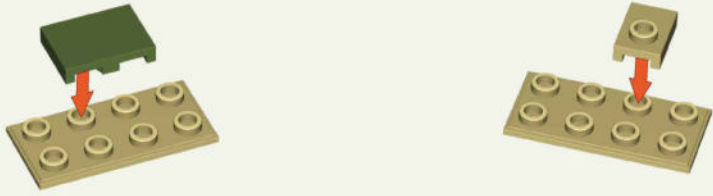

55



56

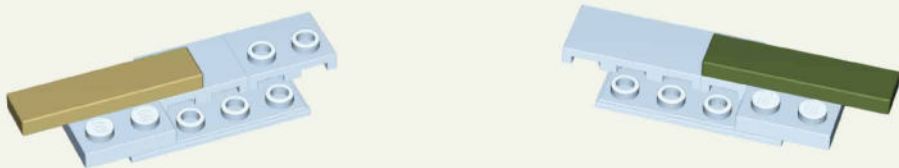

57

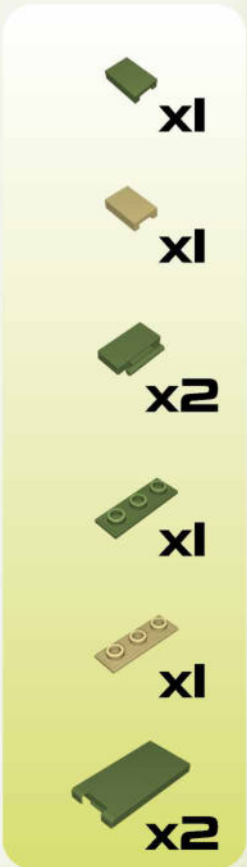
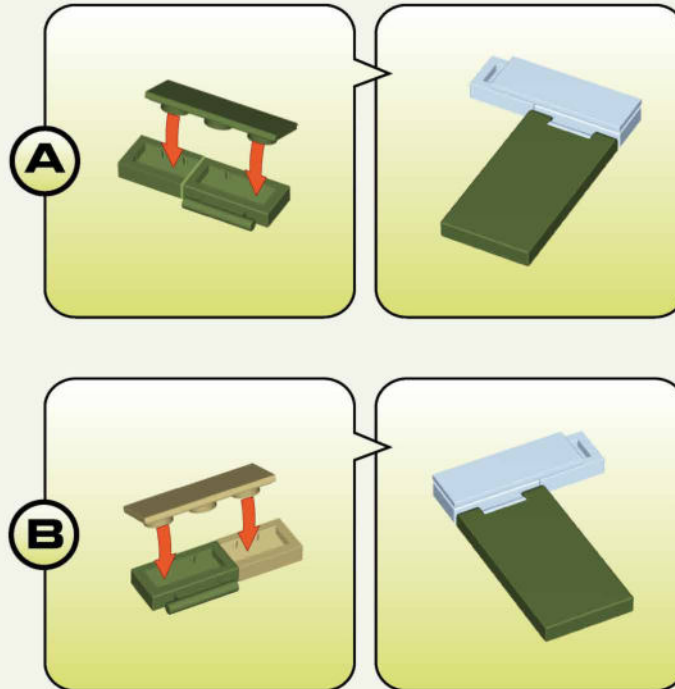

58

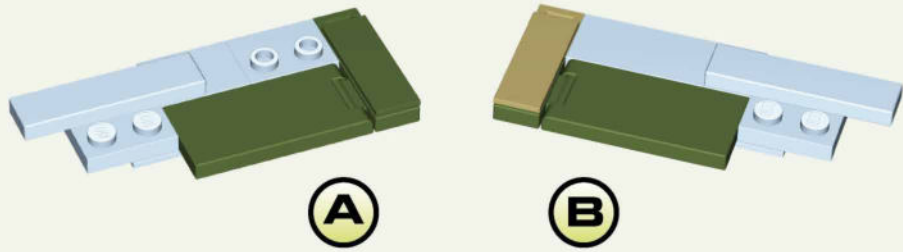

59

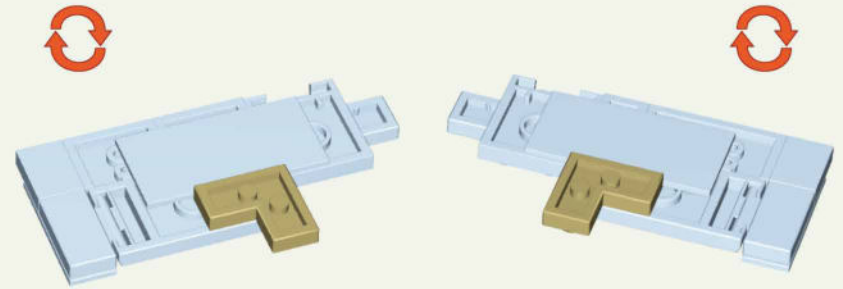



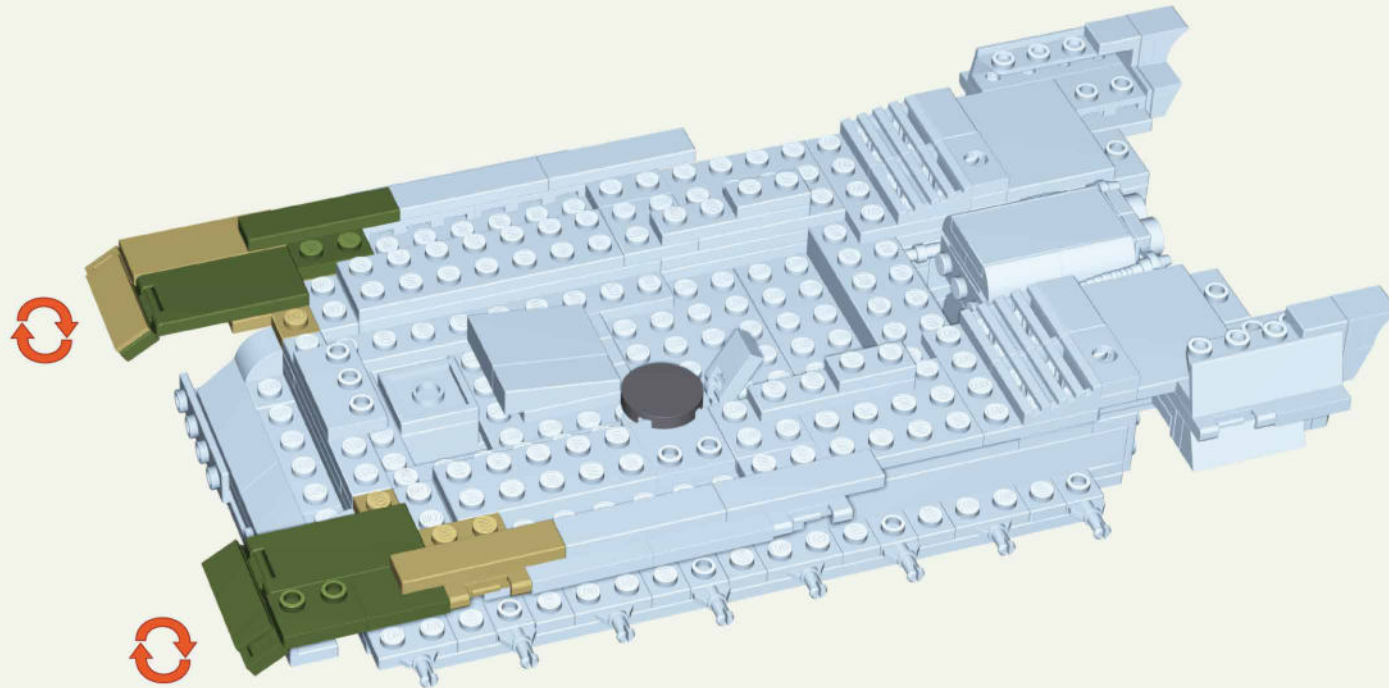

60



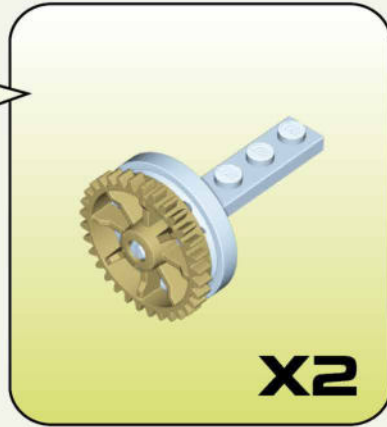
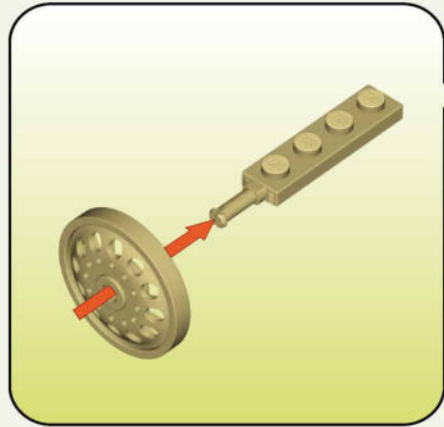



61



-  x2
-  x2
-  x2

62



-  x3
-  x5





63

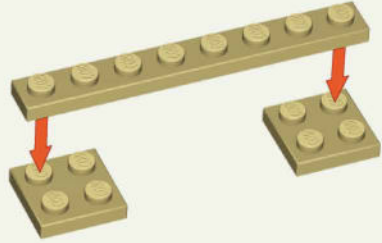

64

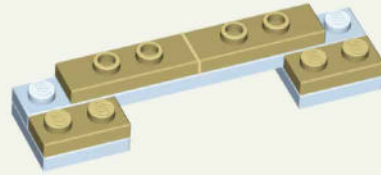

65

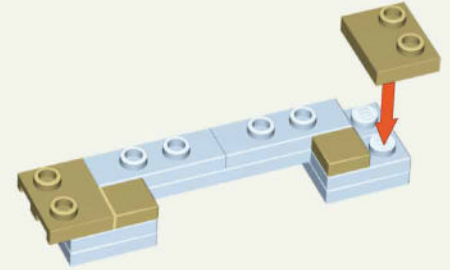

66

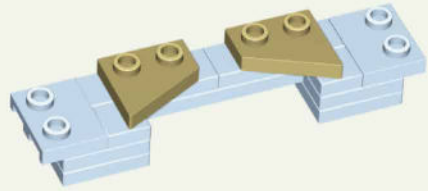

67

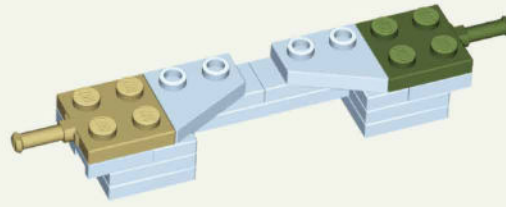

68

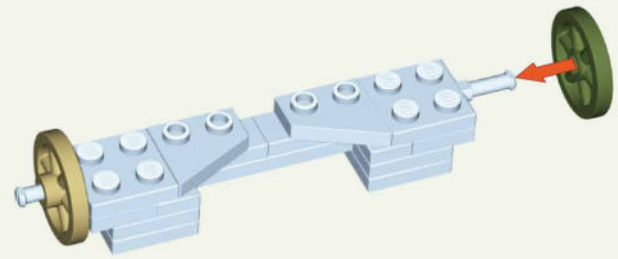

69

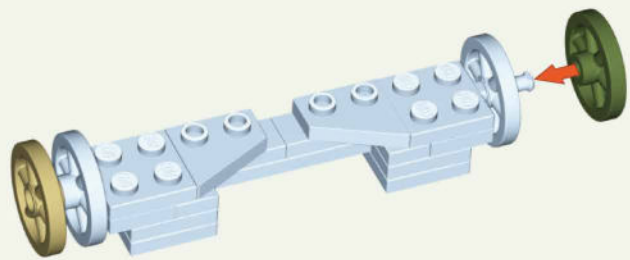

70

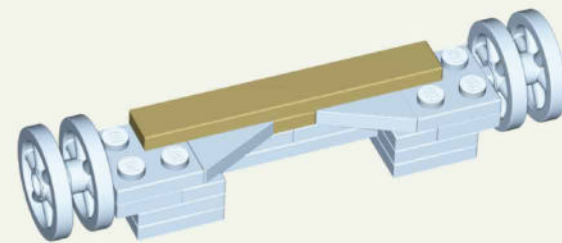
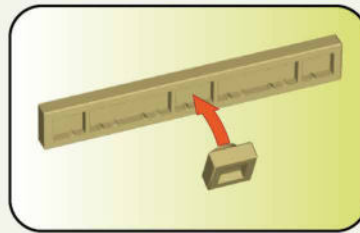

1:1



71

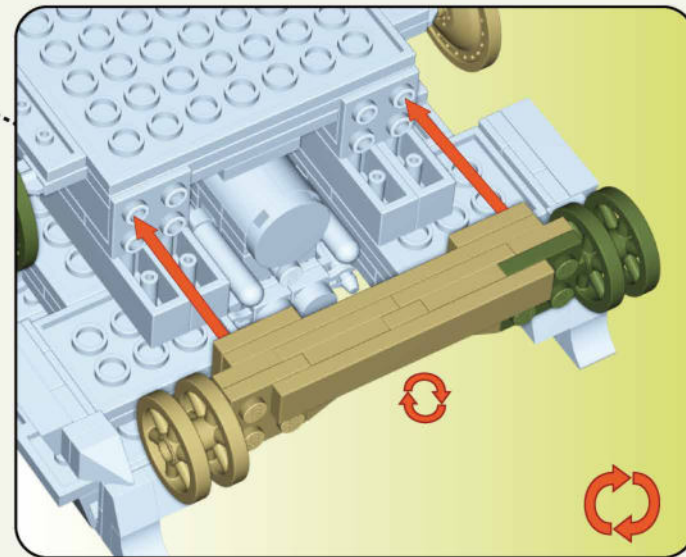
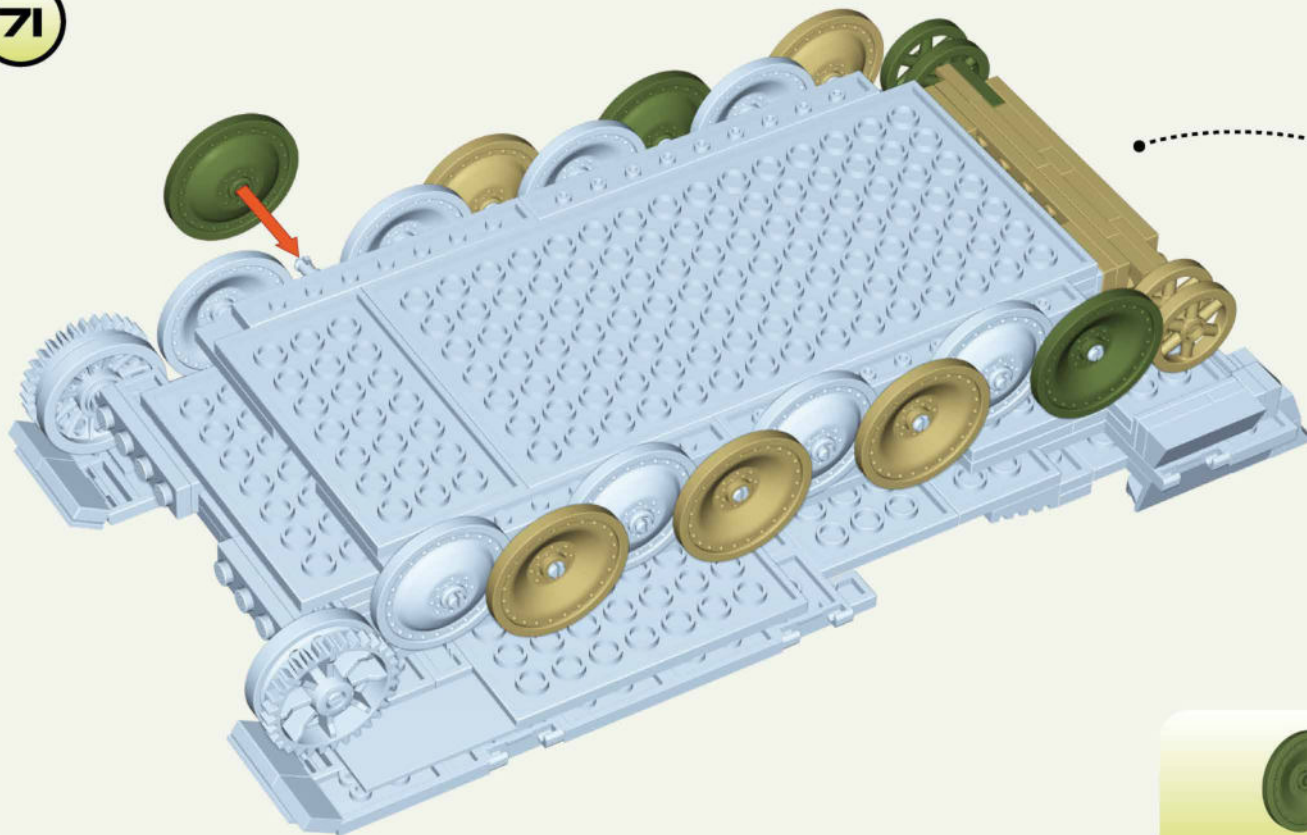

72

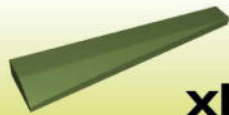
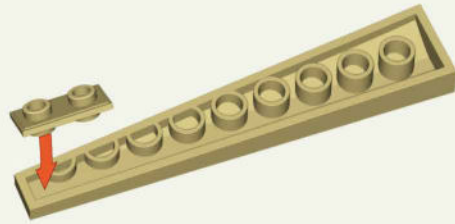

x1



x1



x1



x1

73

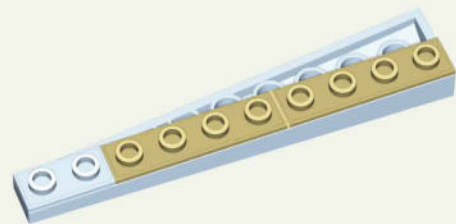
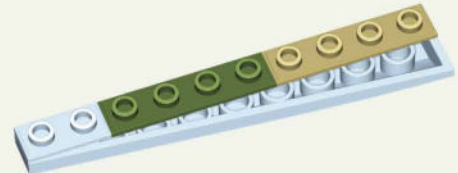

x1



x3

74

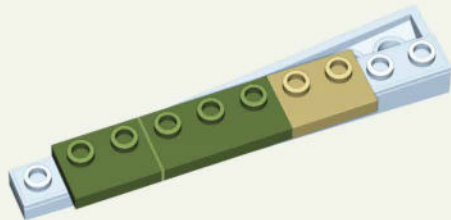
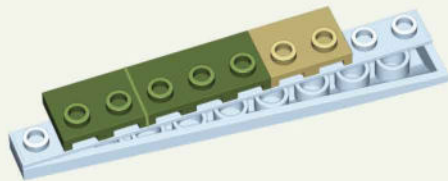

x2



x2



x2

75

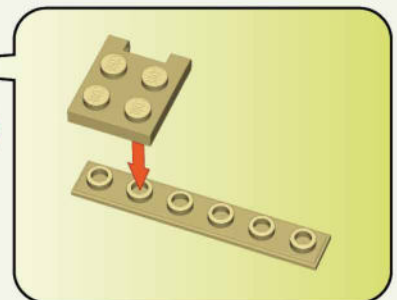
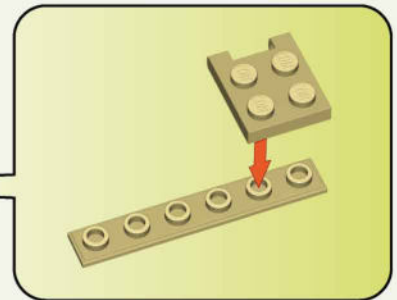
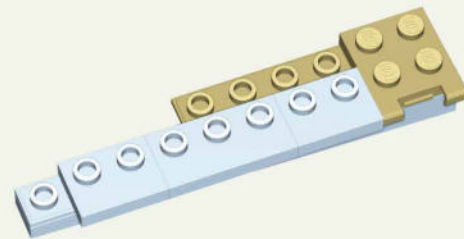

x2



x2



76

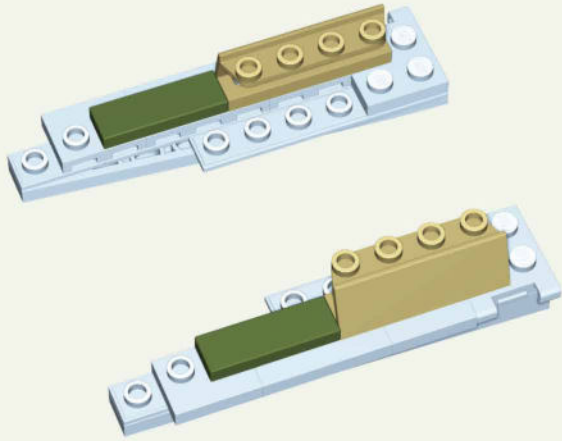

1:1



77

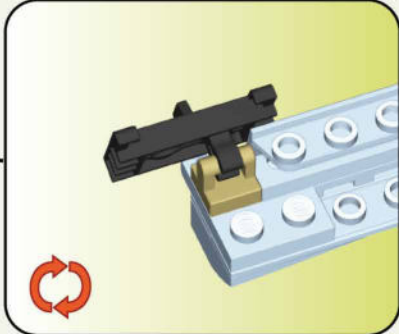

A

B

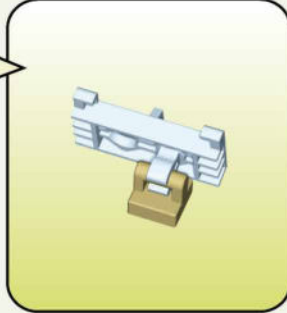
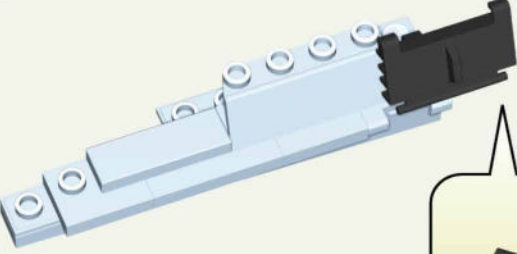

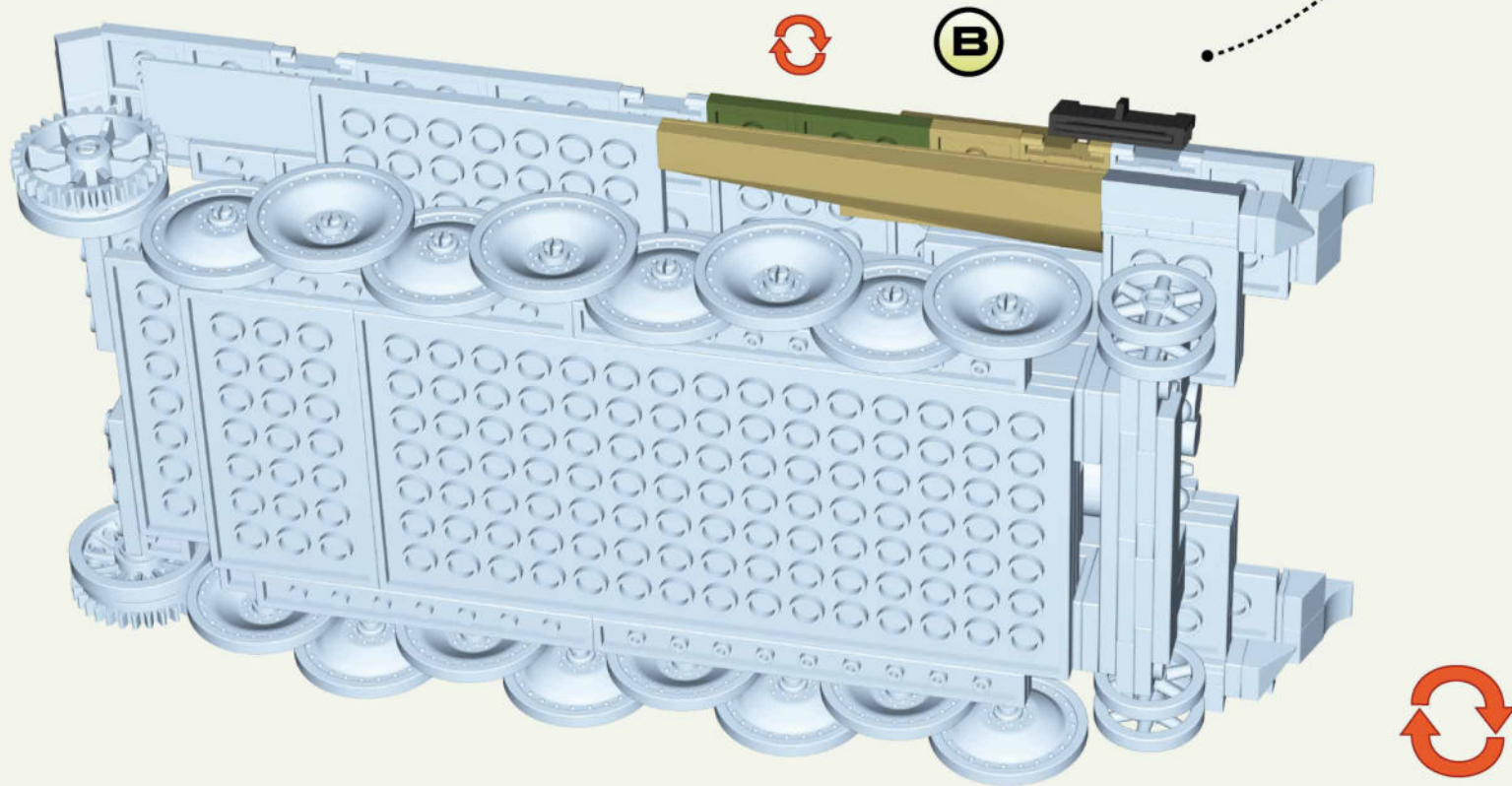
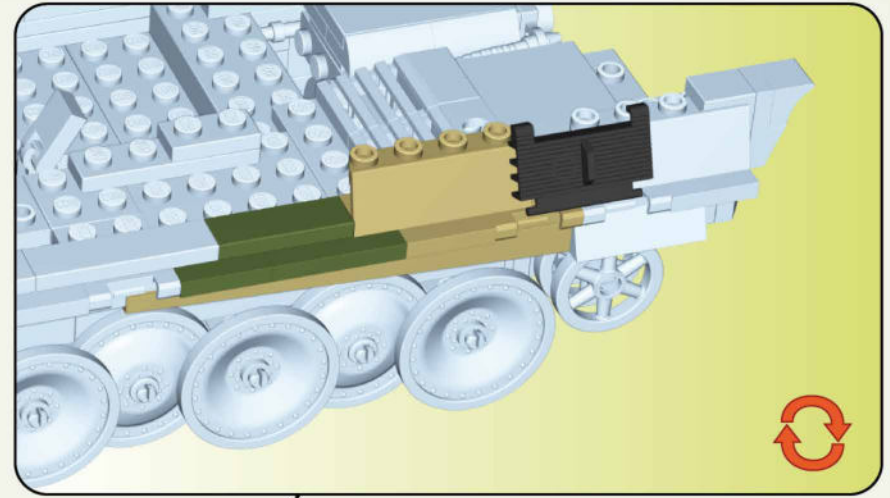

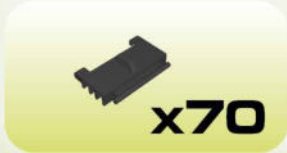
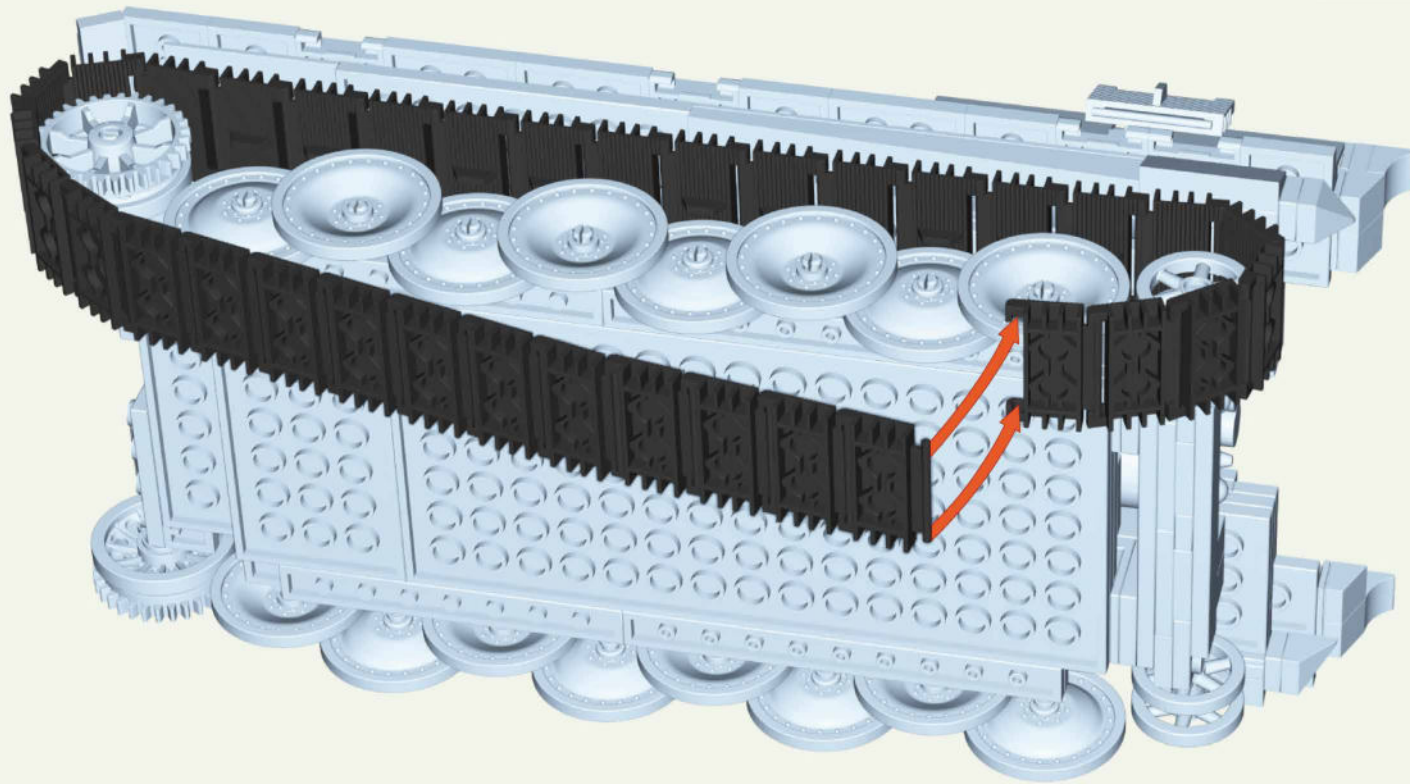
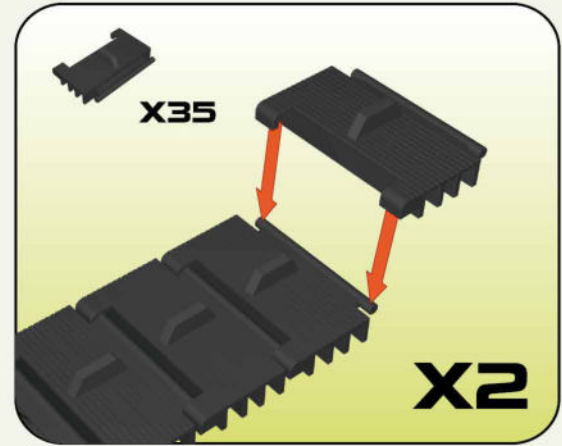



80

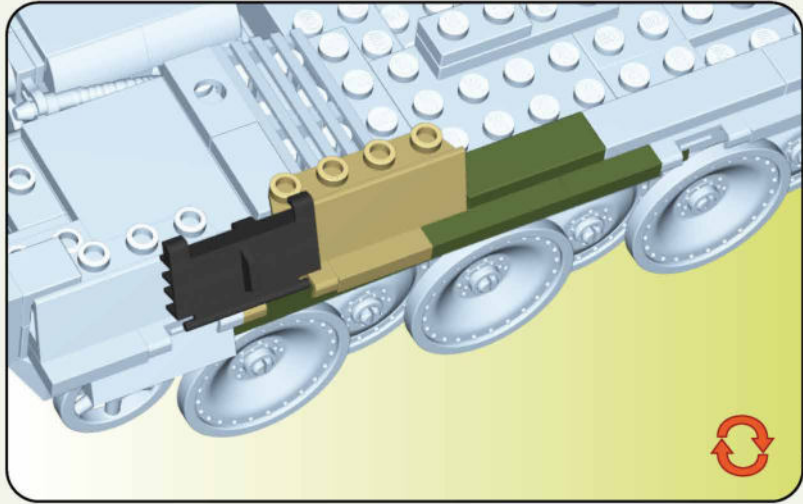

A

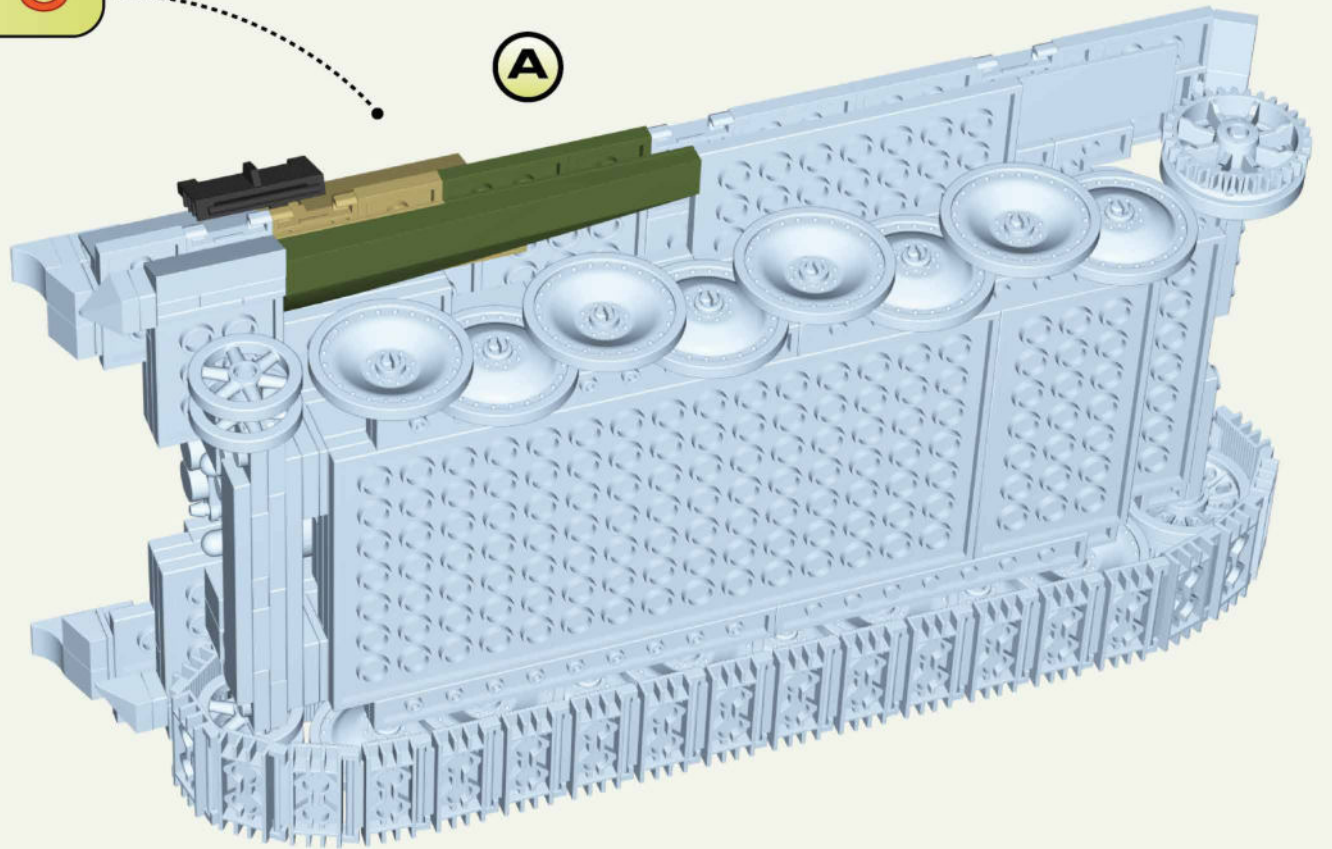

81

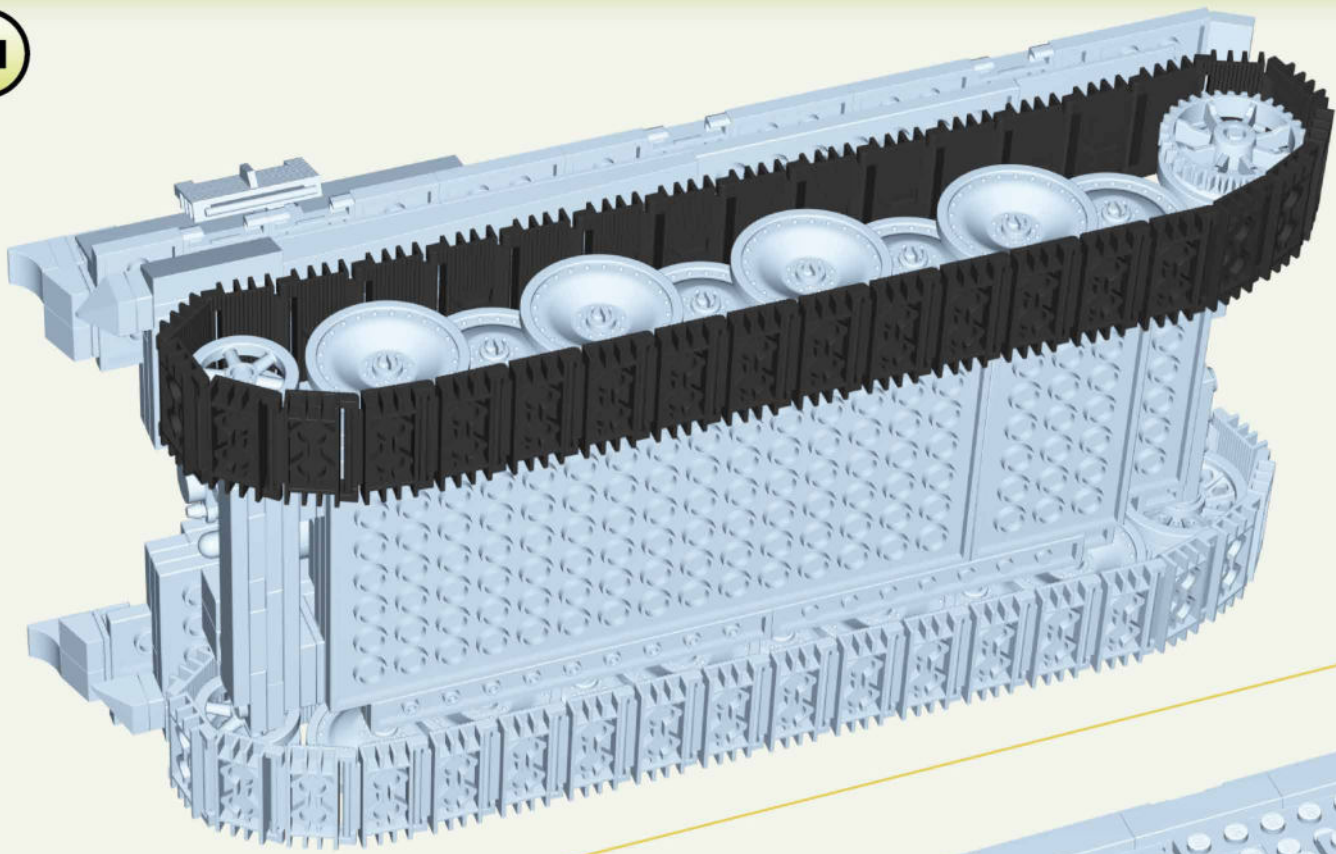

82

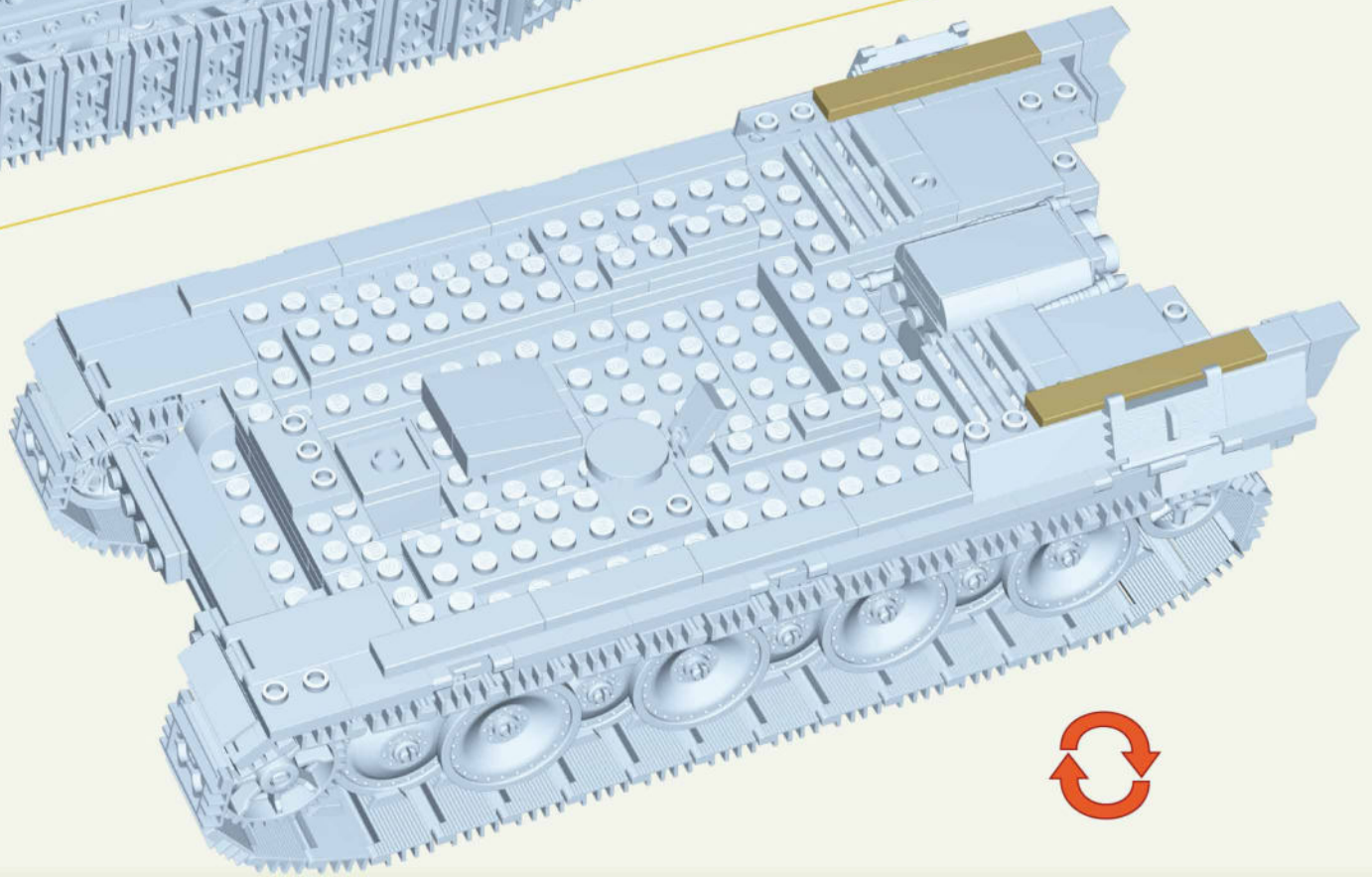

1:1



83

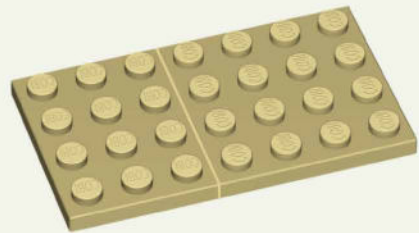

x1



x1

84



1:1

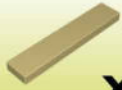

x1



x1

85

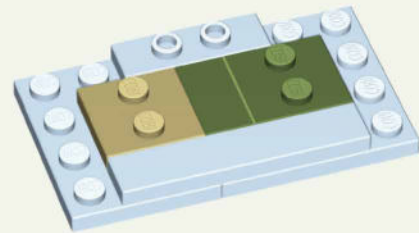

1:1



x1



x1



x1

86

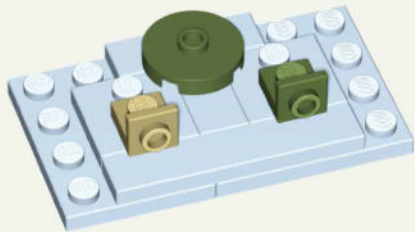

x1



x1



x1

87

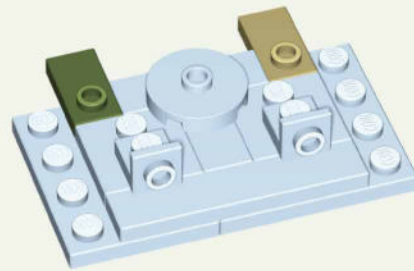

x1



x1

88

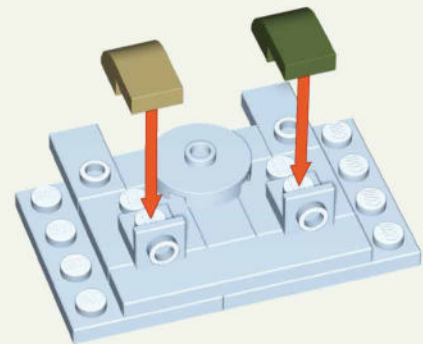

x1



x1



89

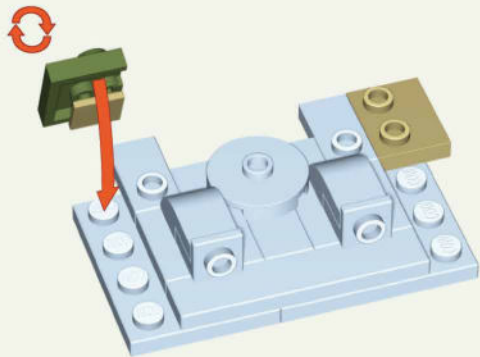

x1



x1



x1

90

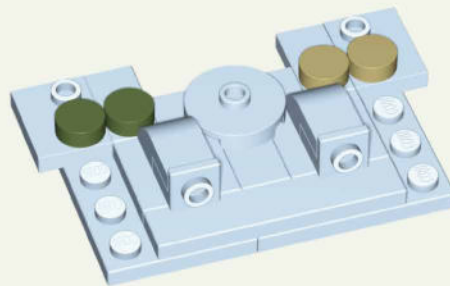

x2



x2

91

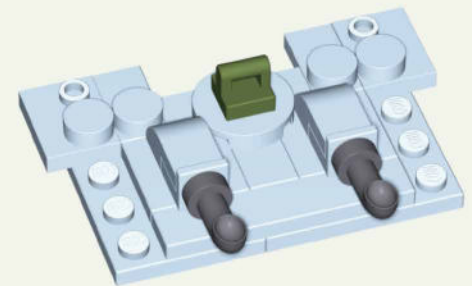

x1



x2

92

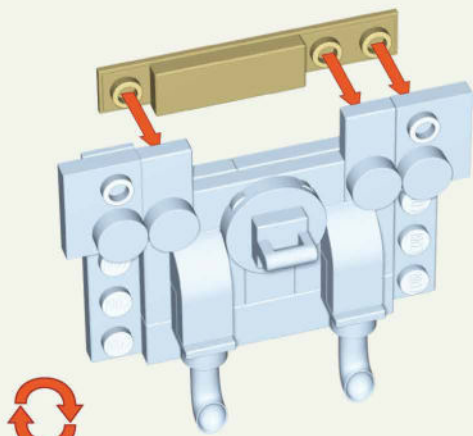
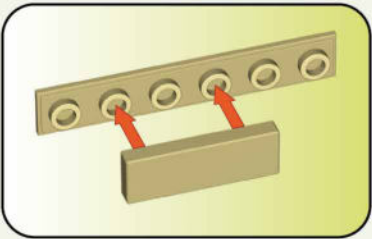

1:1



x1



x1

93

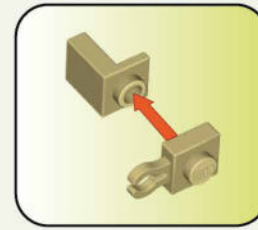
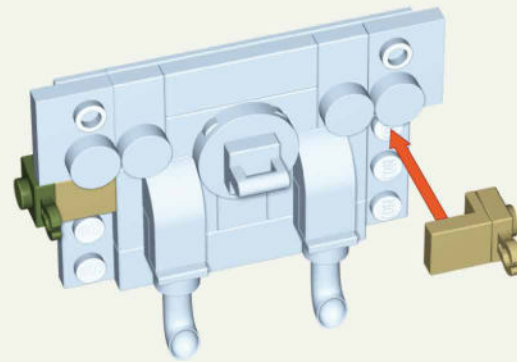
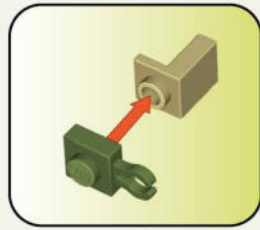

x2



x1



x1

94

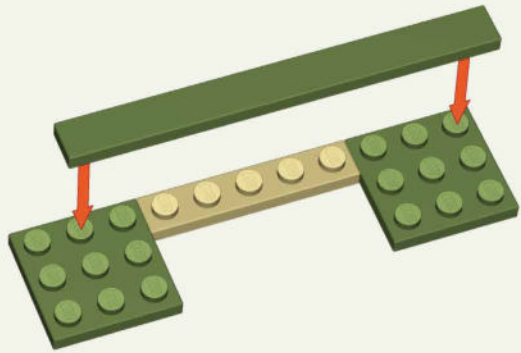

1:1



95

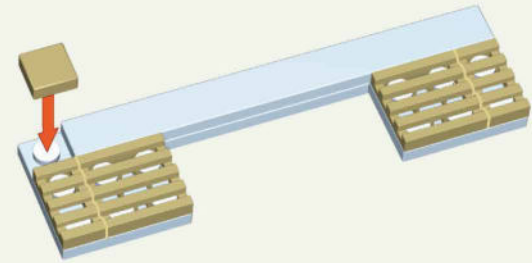

96

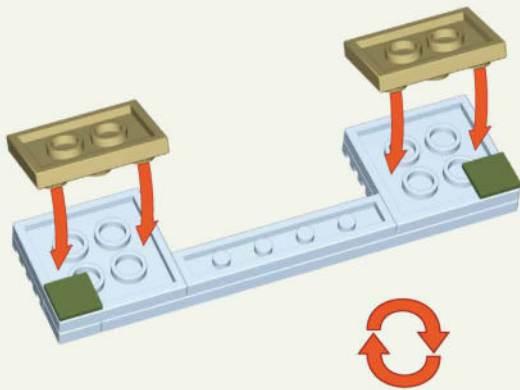

97

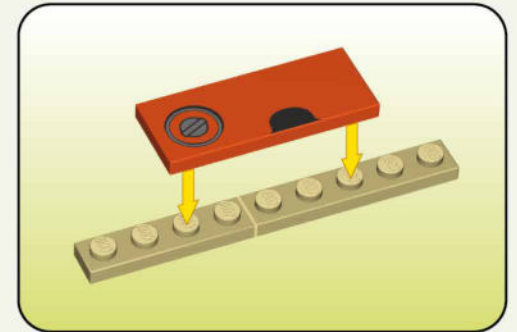
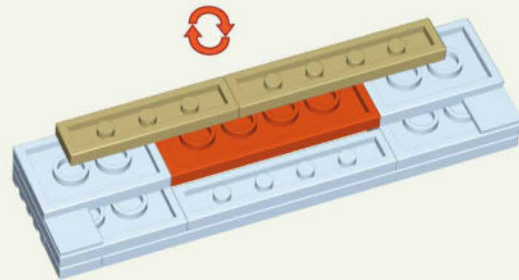

98

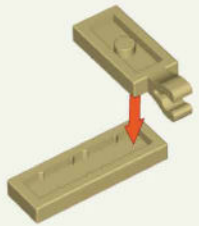

1:1



x1



x1

99



x2

100



x1



x1

101

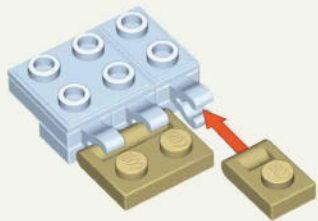

x1



x1

102

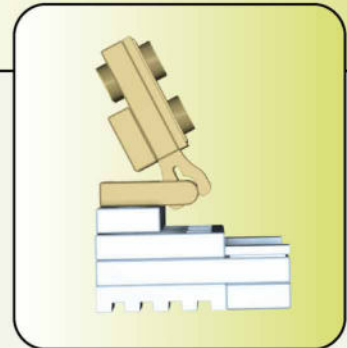
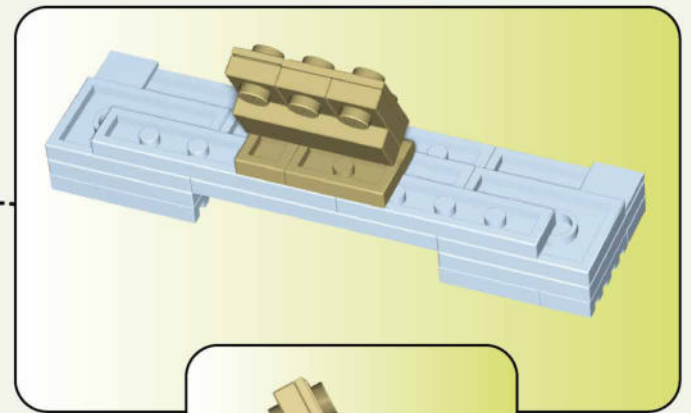
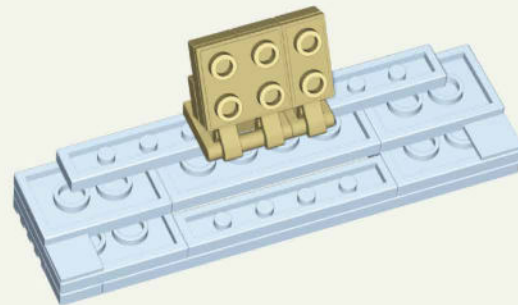



103

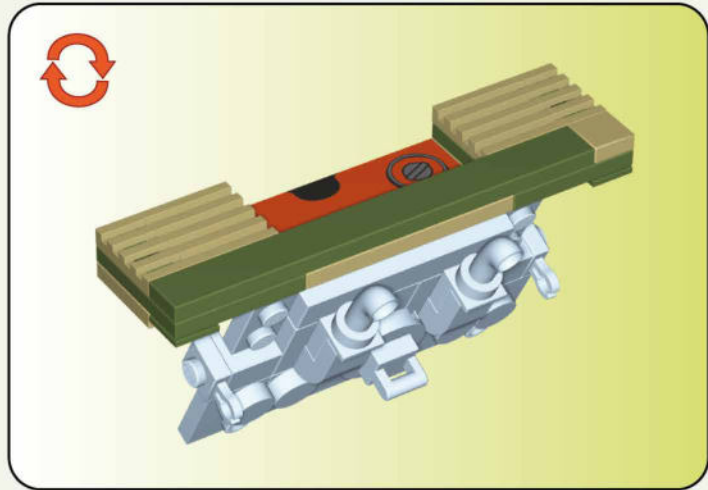
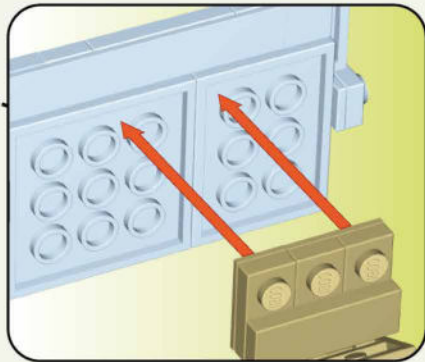
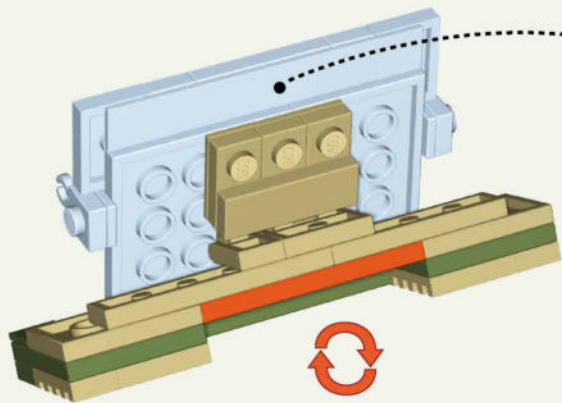

104

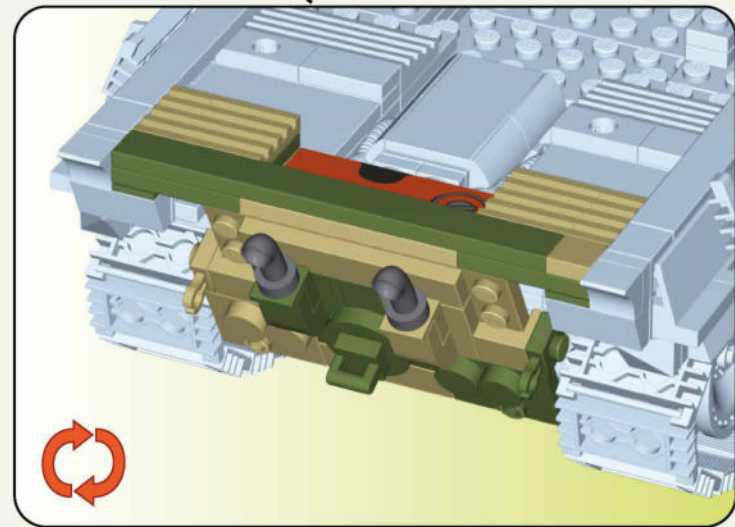
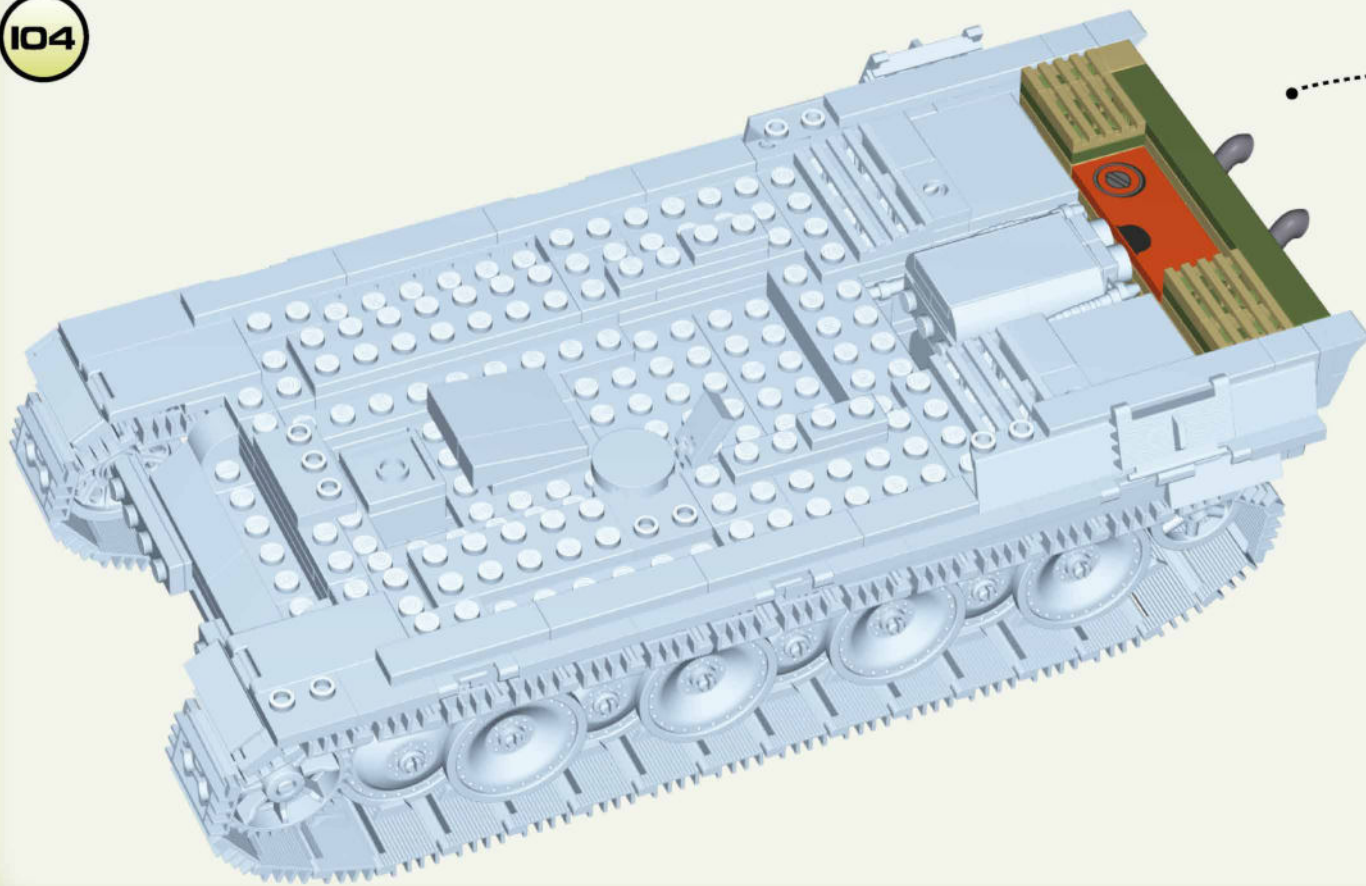

105

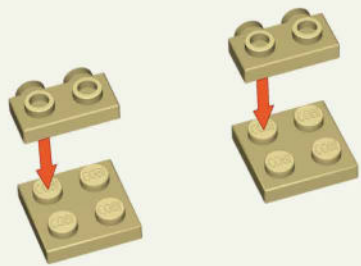

106

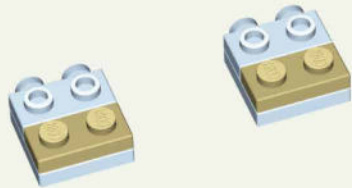

107

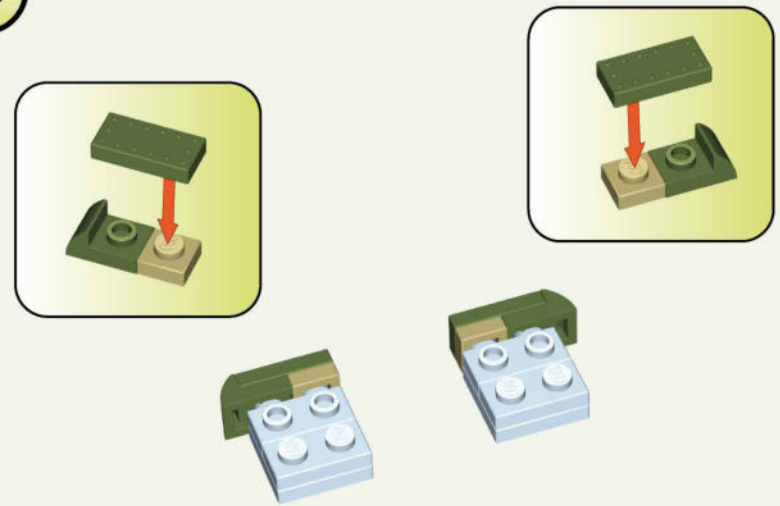

108

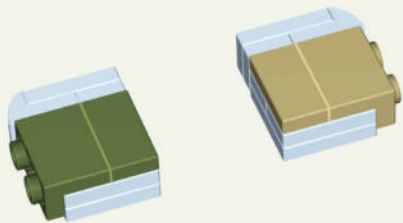

109

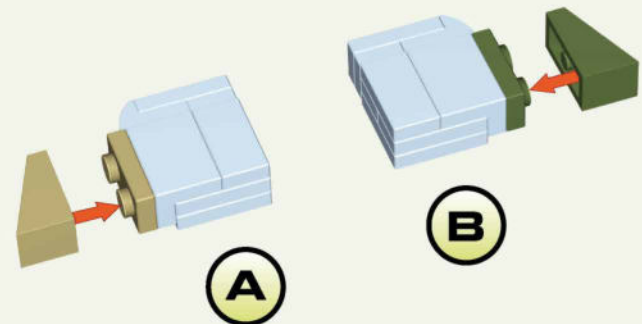

110

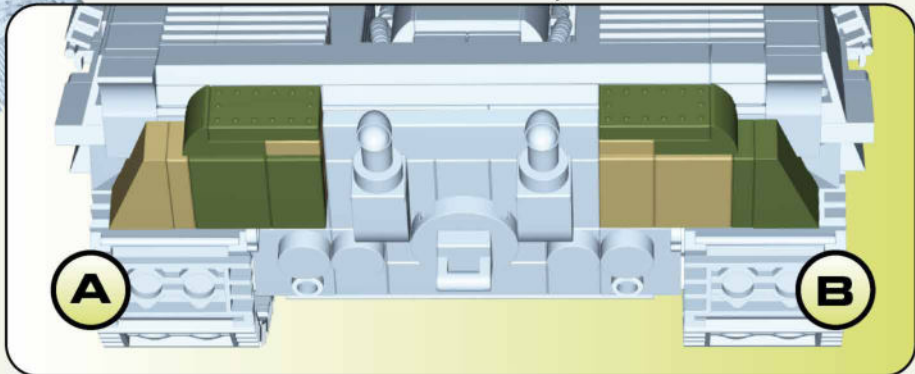
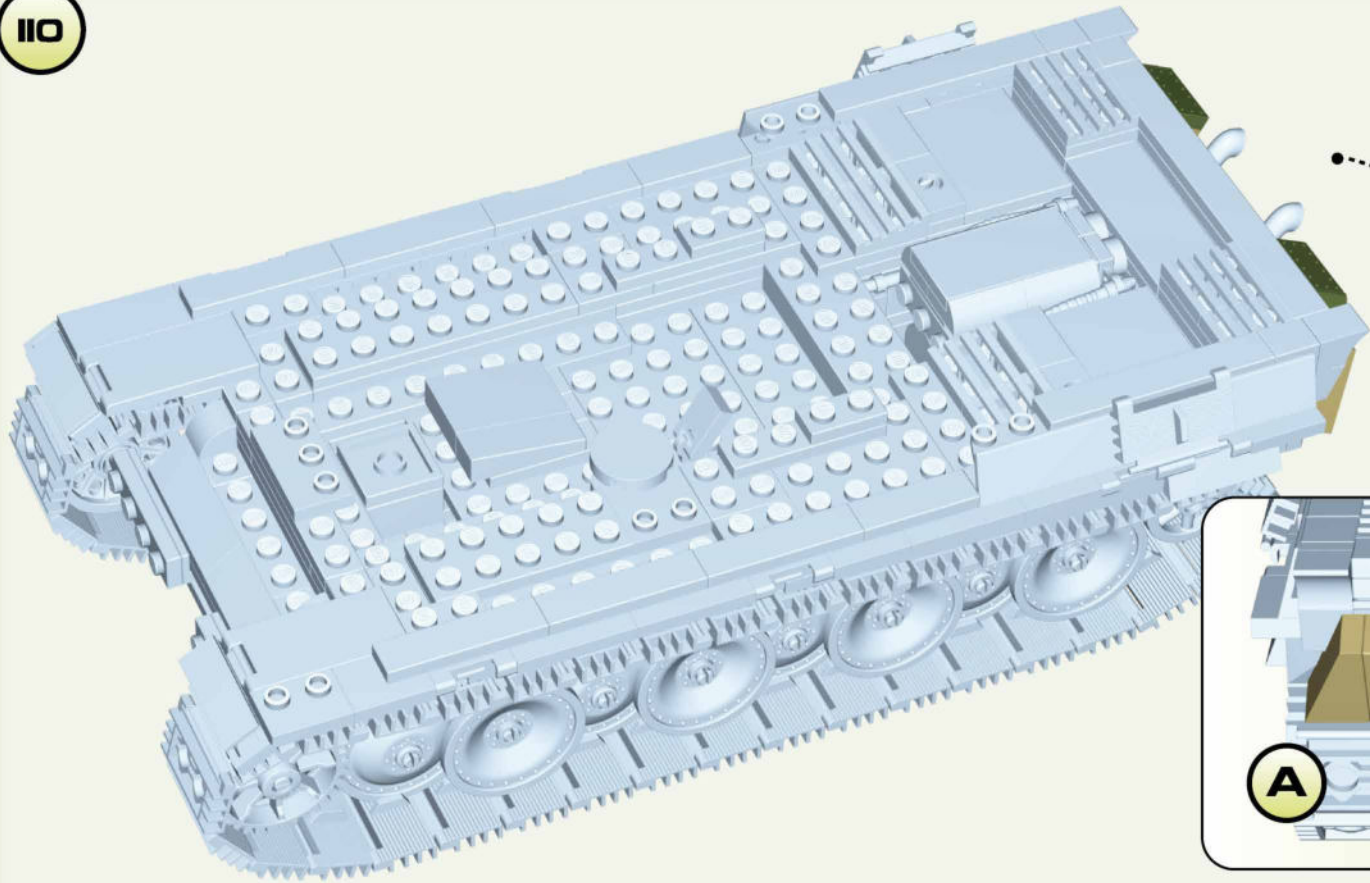

111

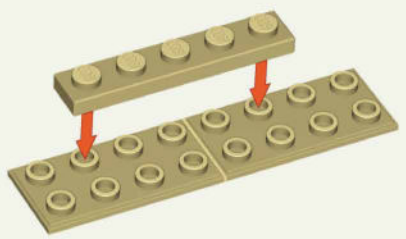

112

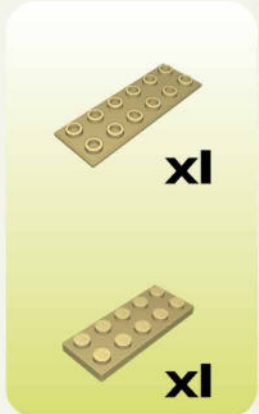
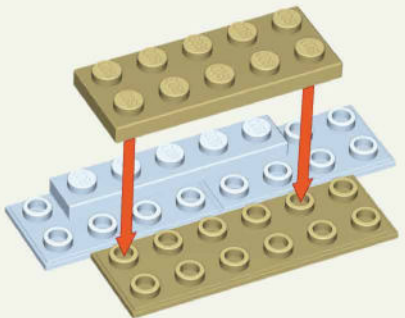





119

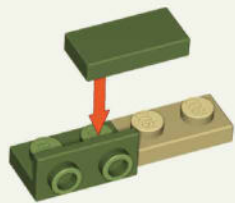

1:1



120

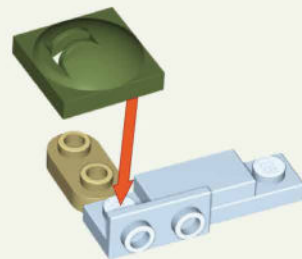

121

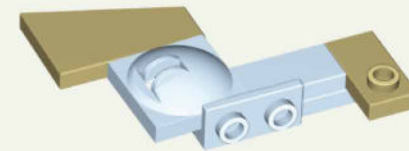

122

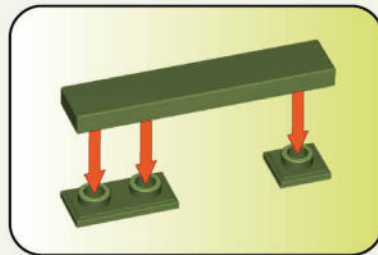
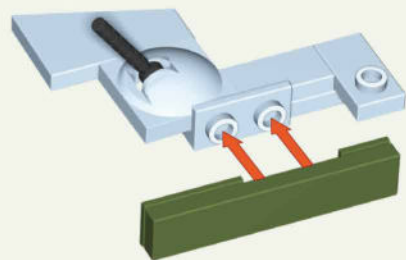

1:1



123

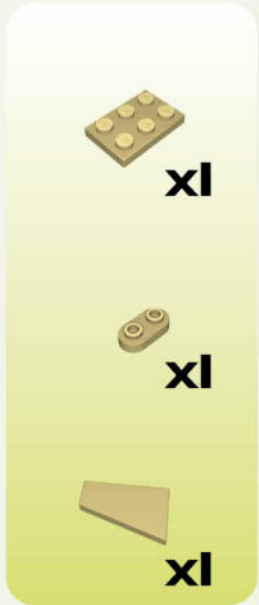
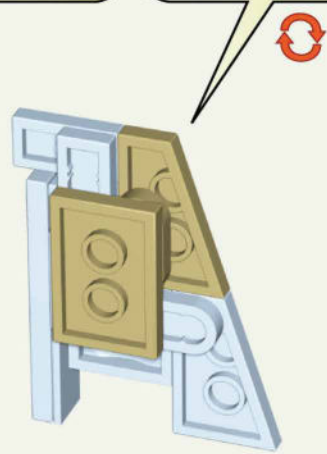
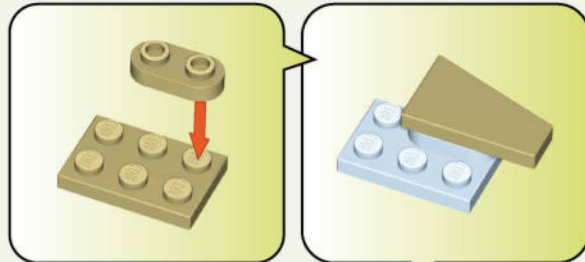

124

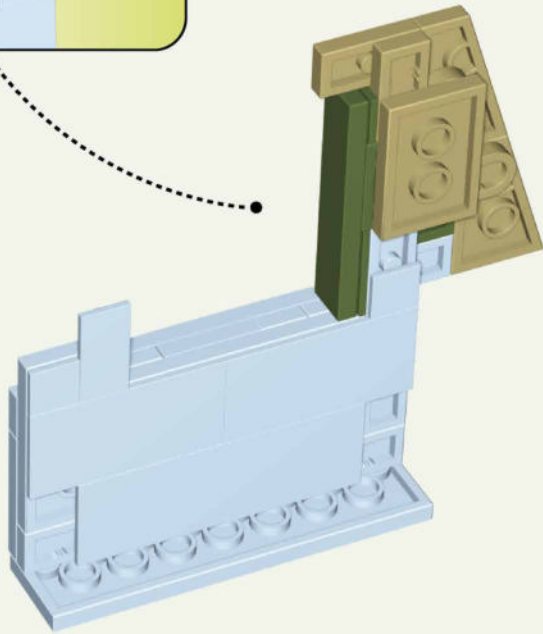
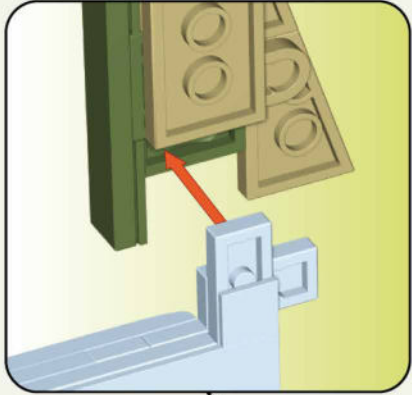

125

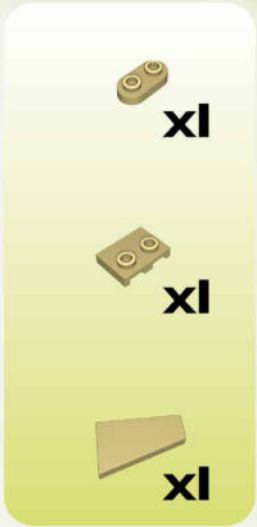
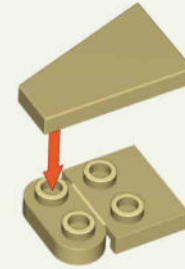

126

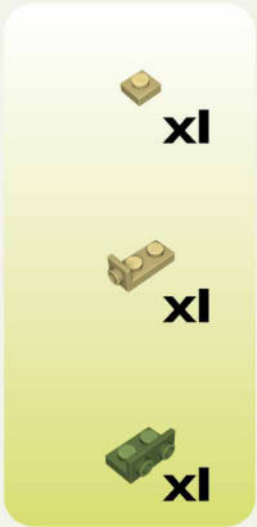

127

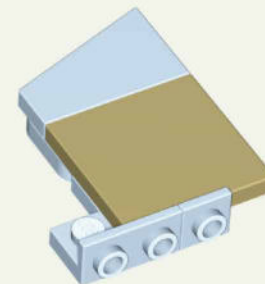



128

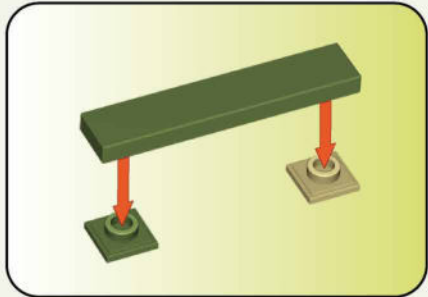
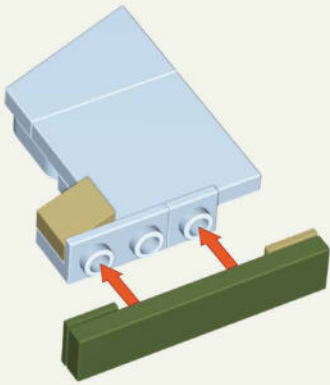

1:1

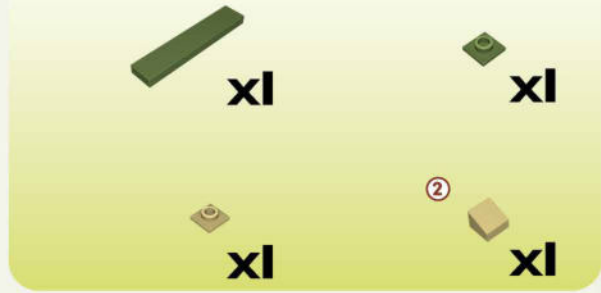

129

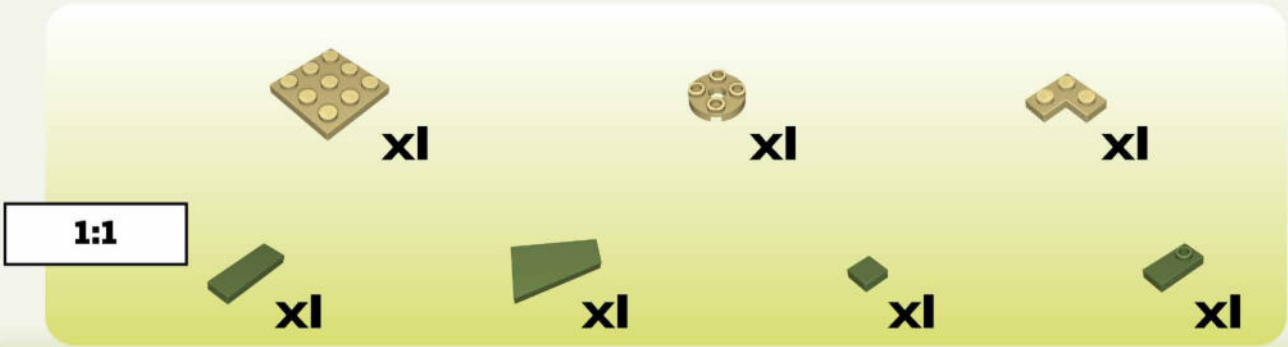
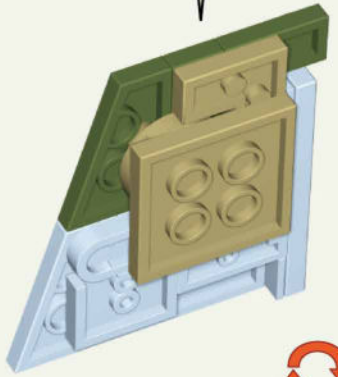
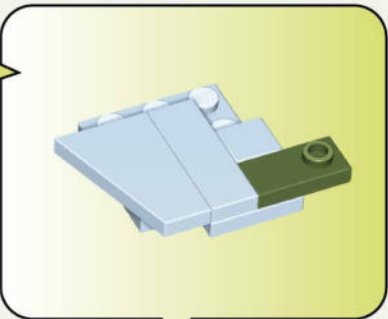
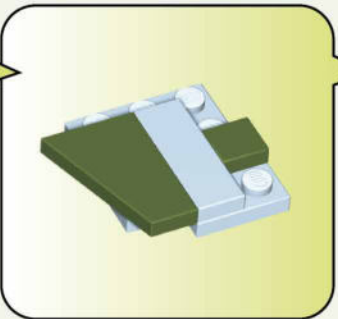
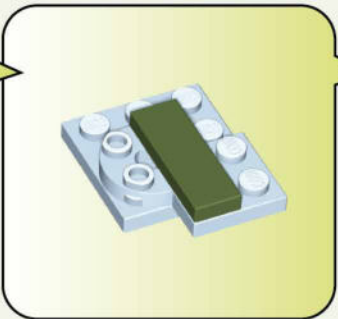
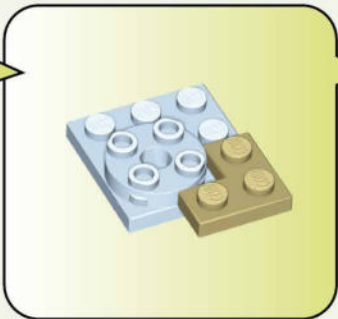
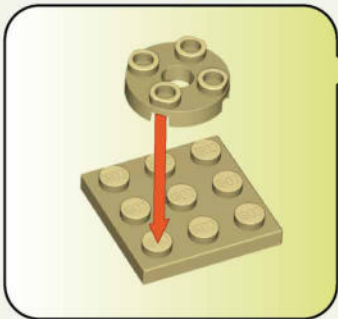

130

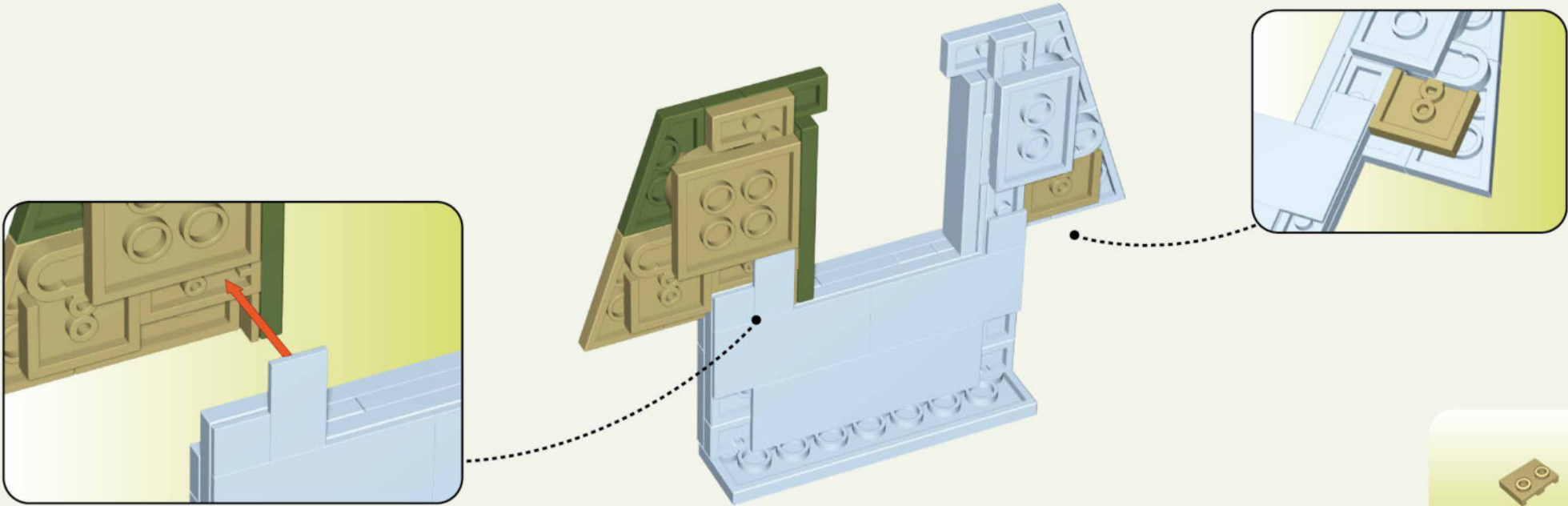

131

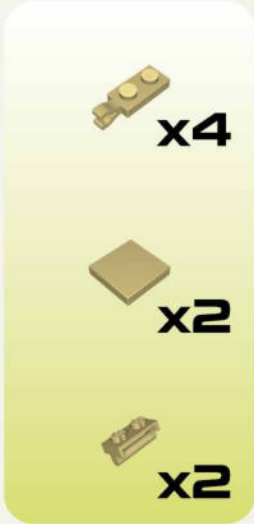
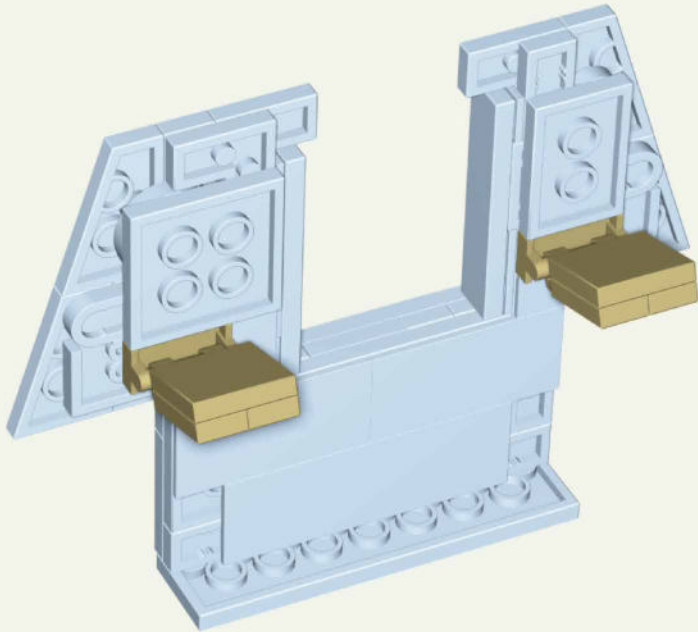
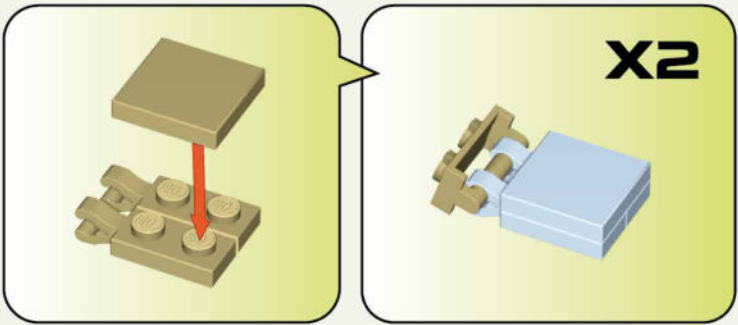

132

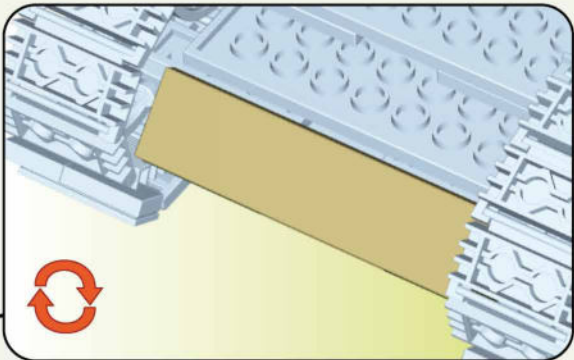
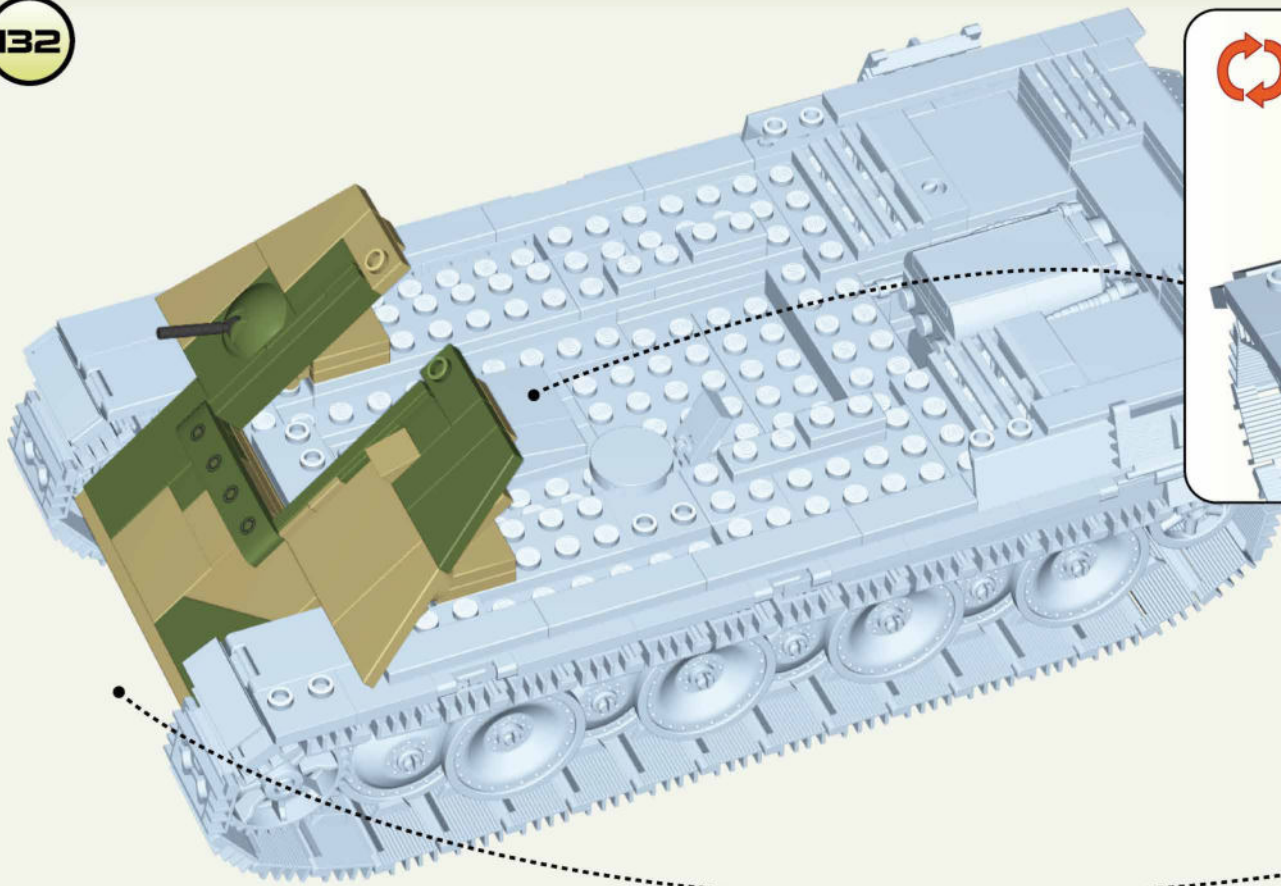

133

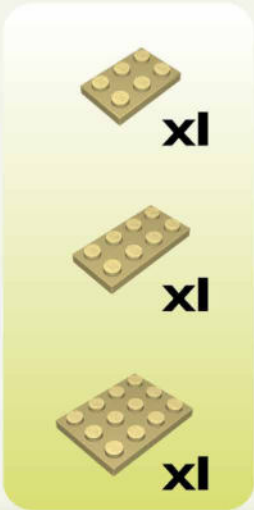

134

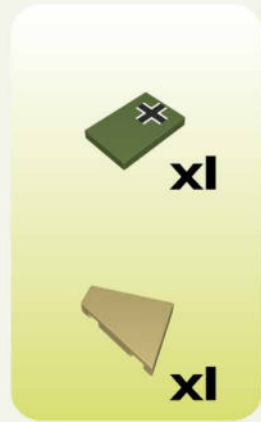
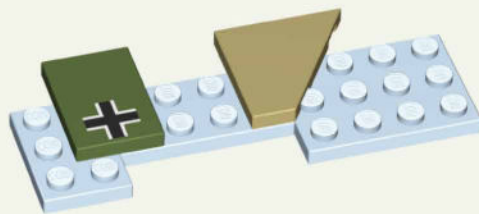



135

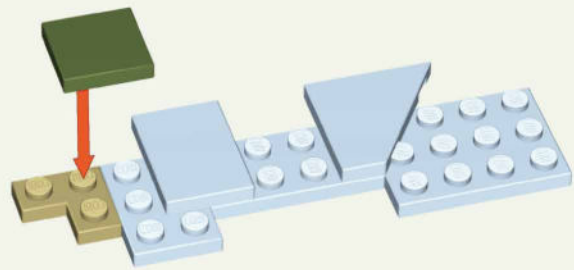

136

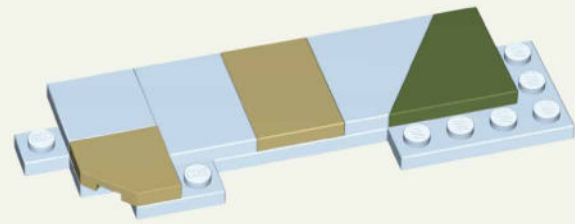

137

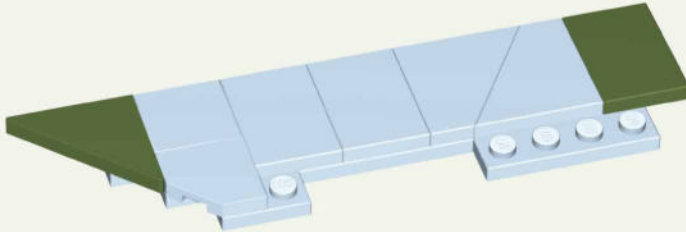

138

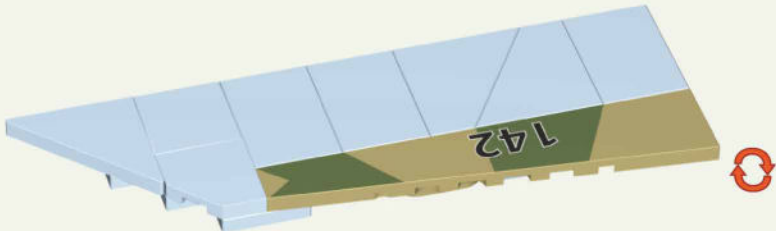
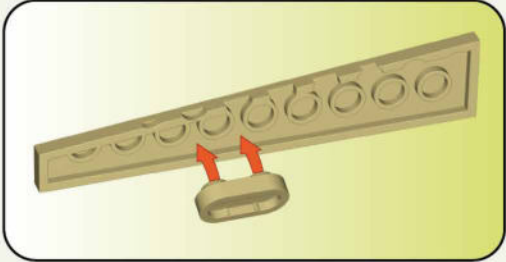

139

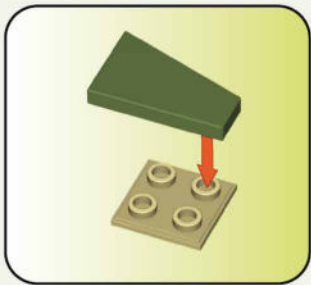

140

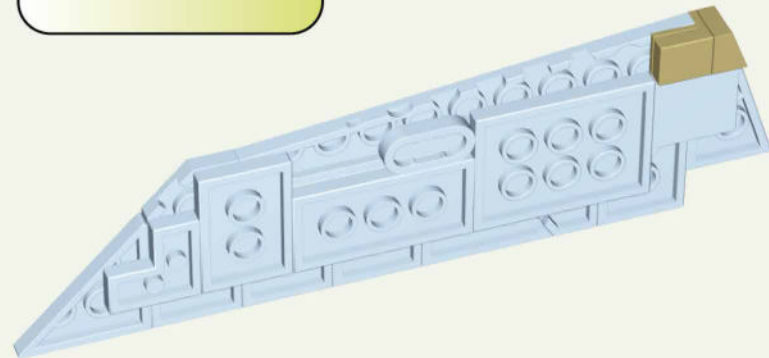
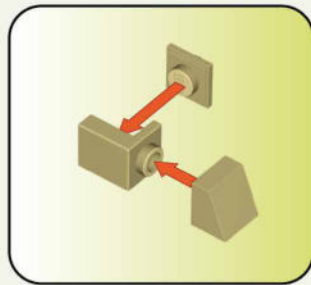

141

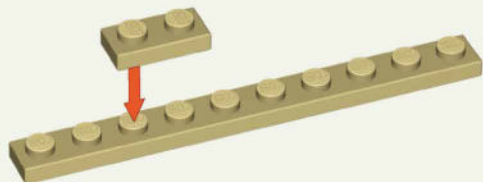

142

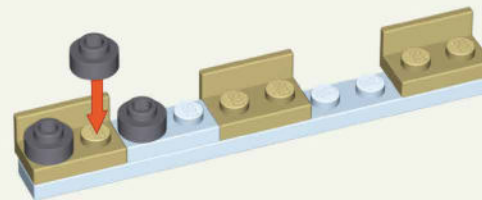

143

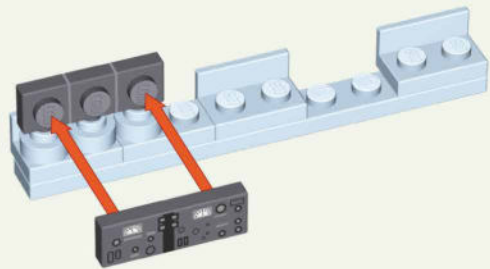

144

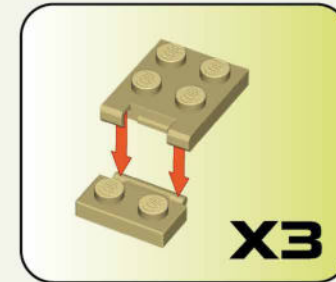

145

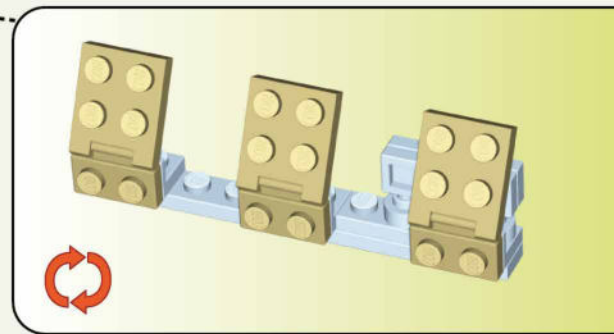
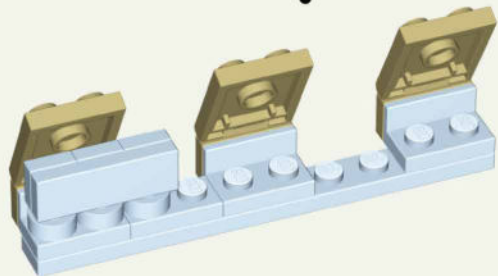

146

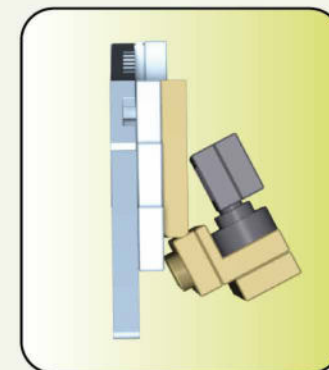
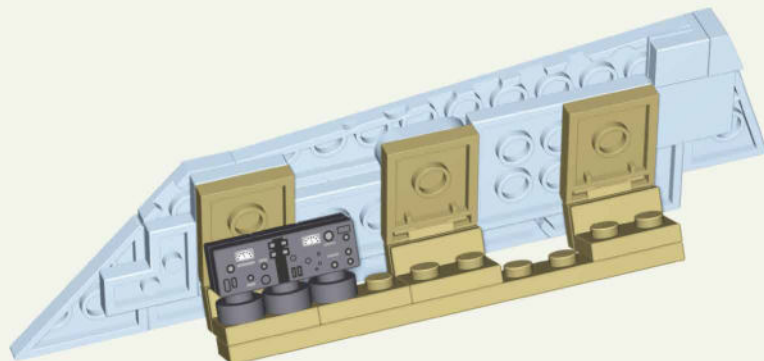



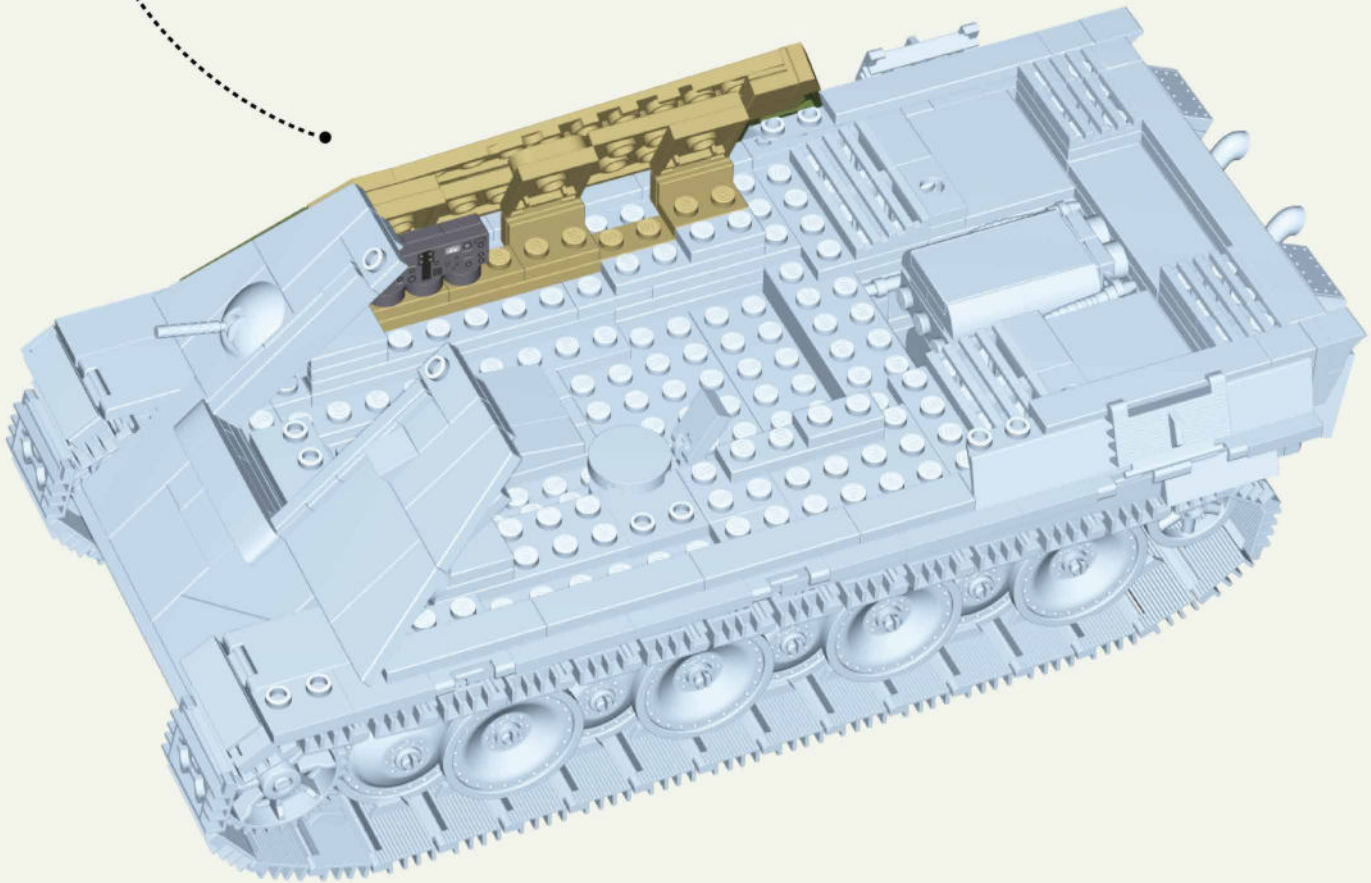
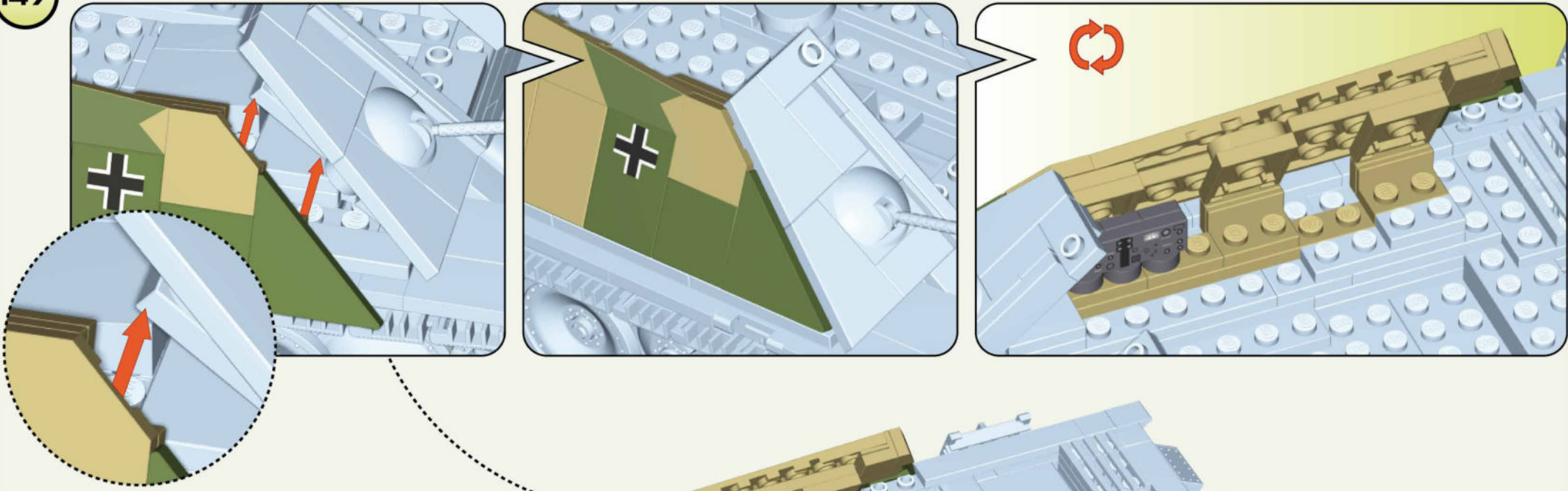

148



x1



x1



x1

149

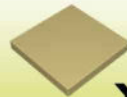
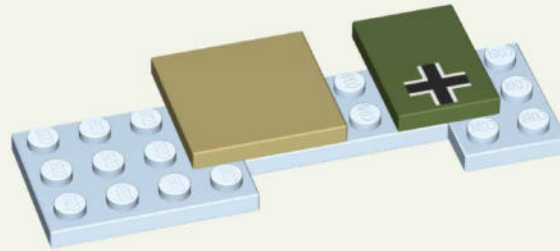

x1



x1

150

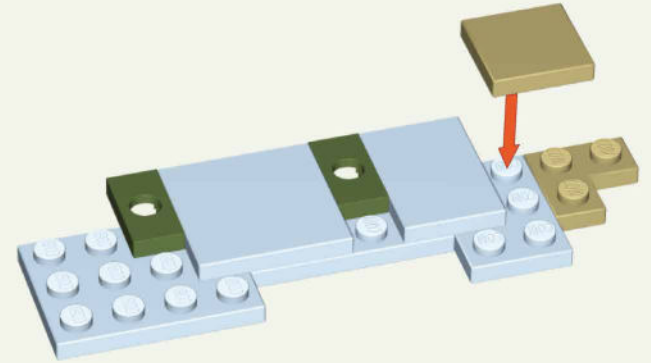

x2



x1



x1

151

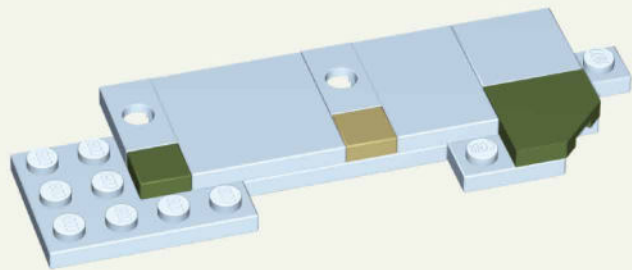

x1



x1



x1

152

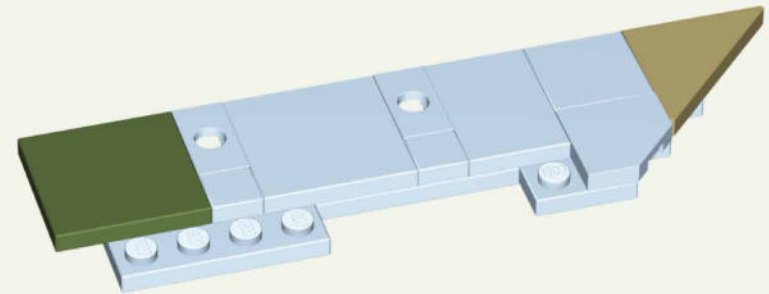

x1



x1

153

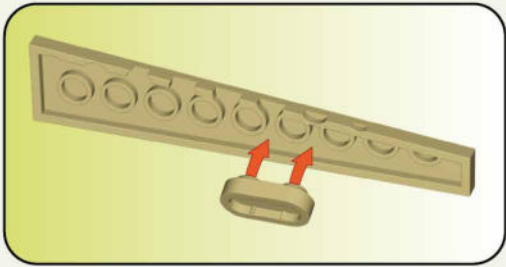

x1



x1

154

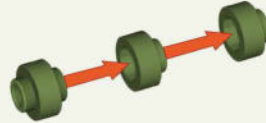

x1



x2

155

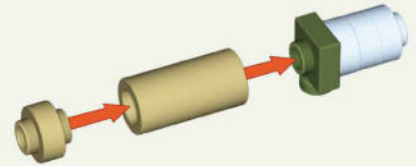

x1



x1



x1

156

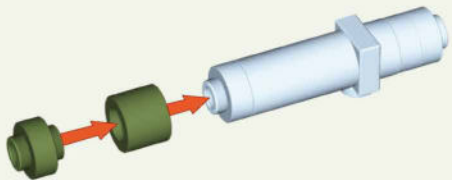

x1



x1

157

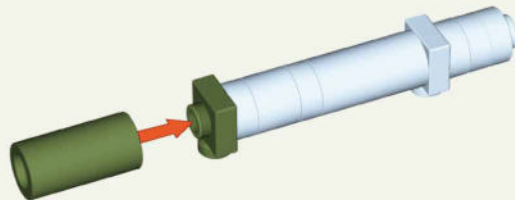

x1



x1

158

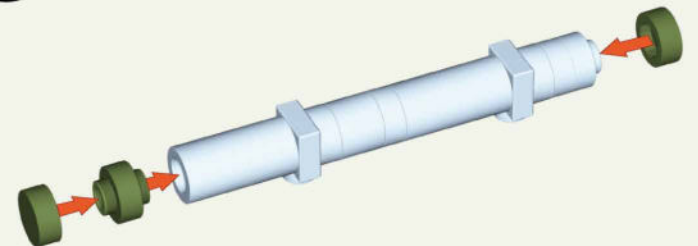

x1



x2



159

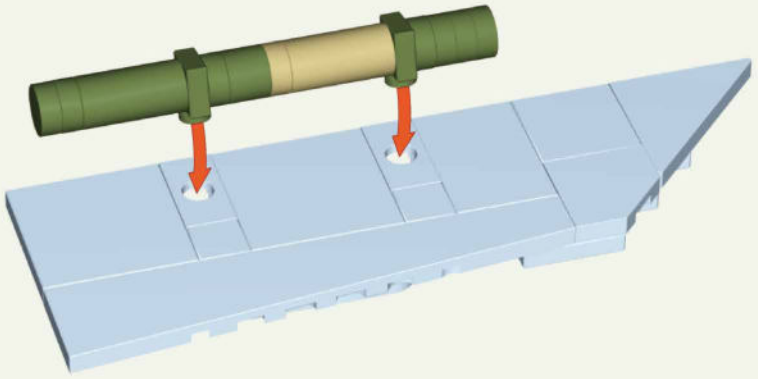

160

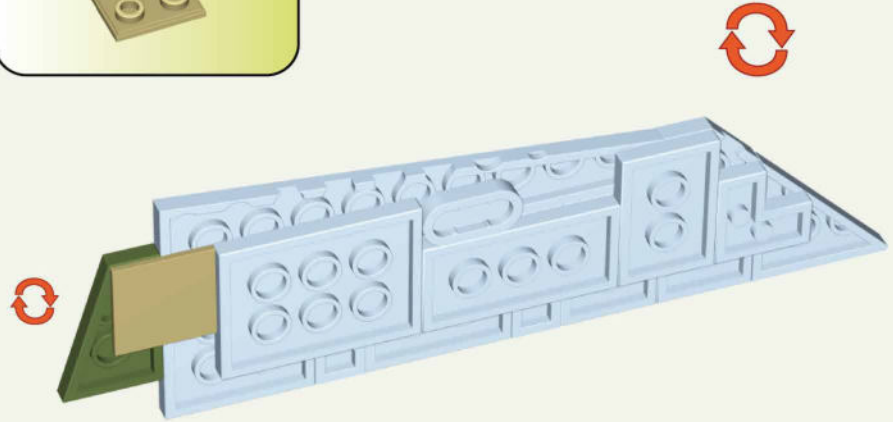
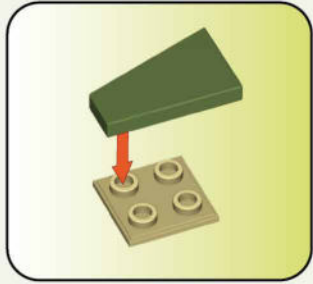

161

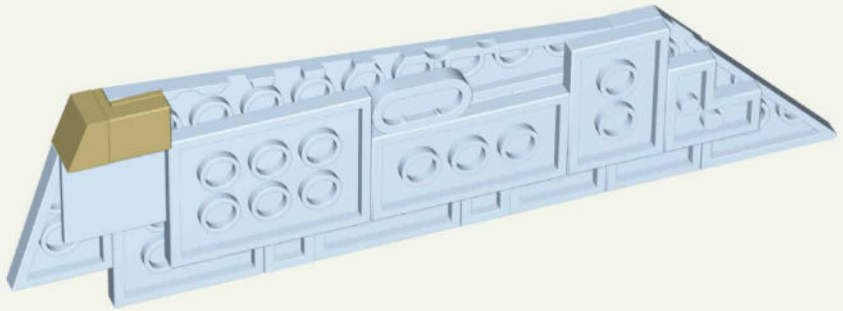
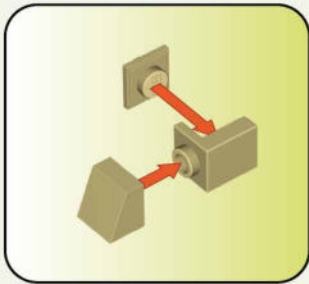

162

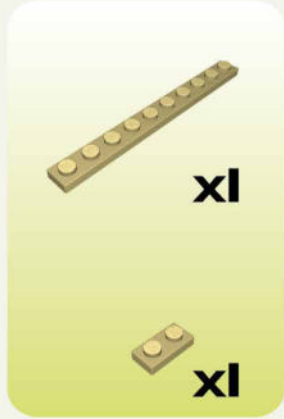
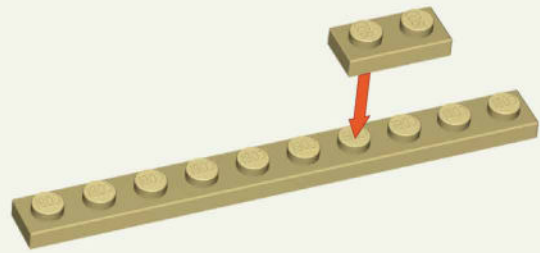

163

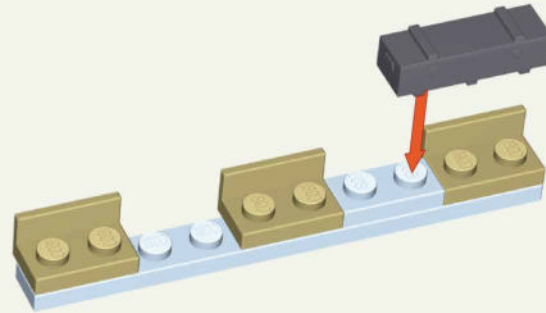

164

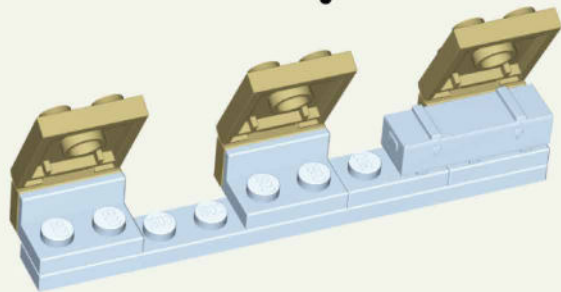
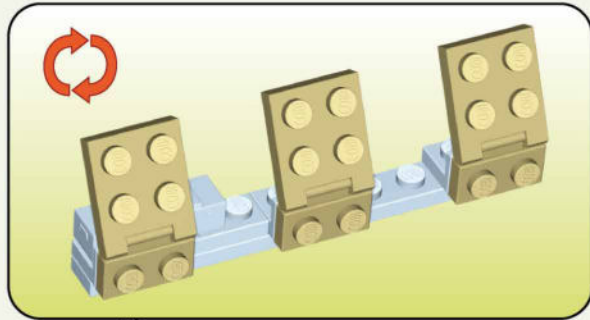
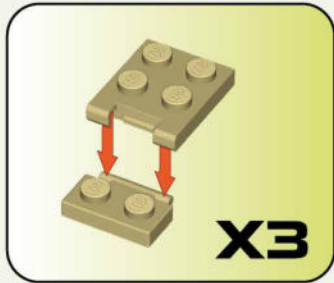

165

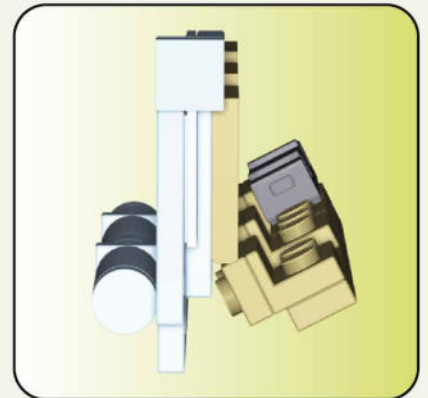
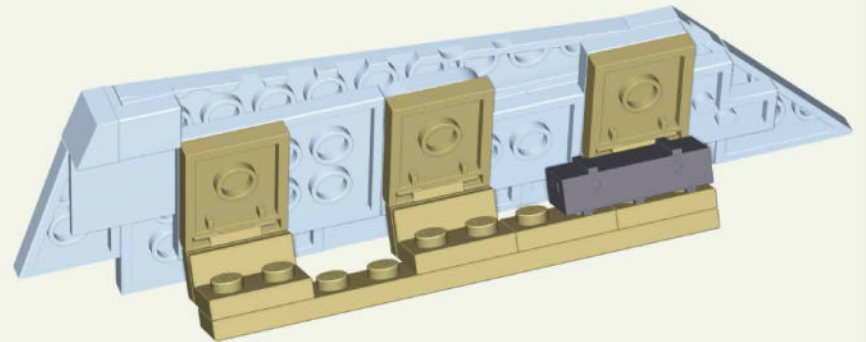

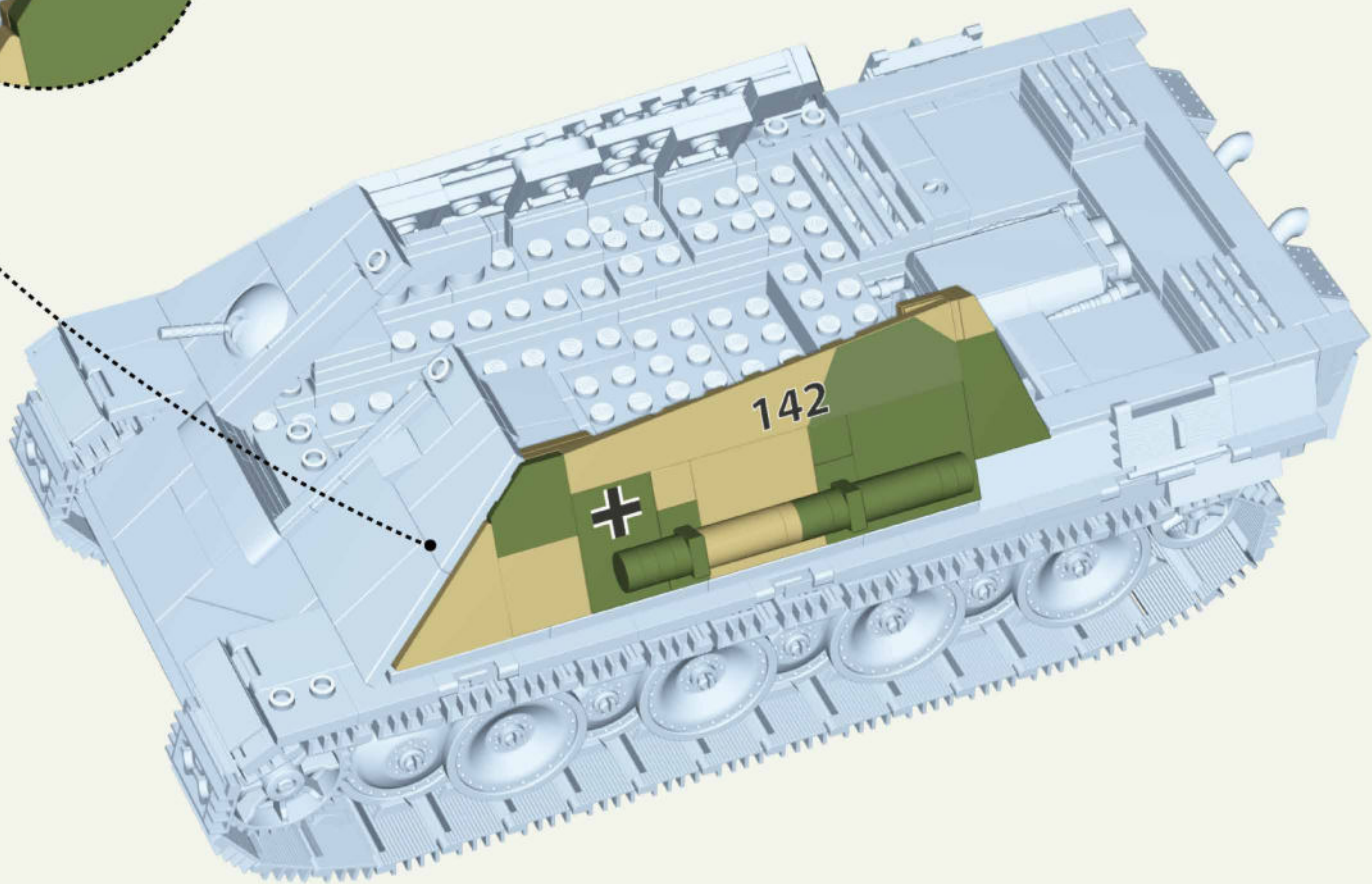
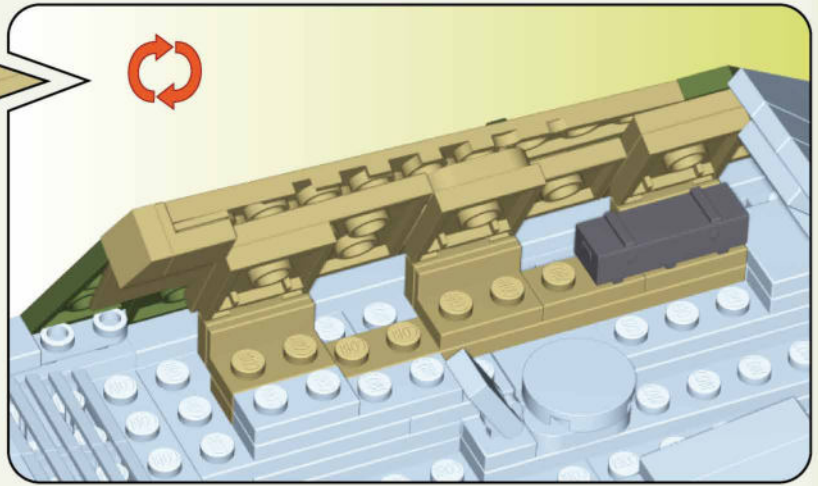
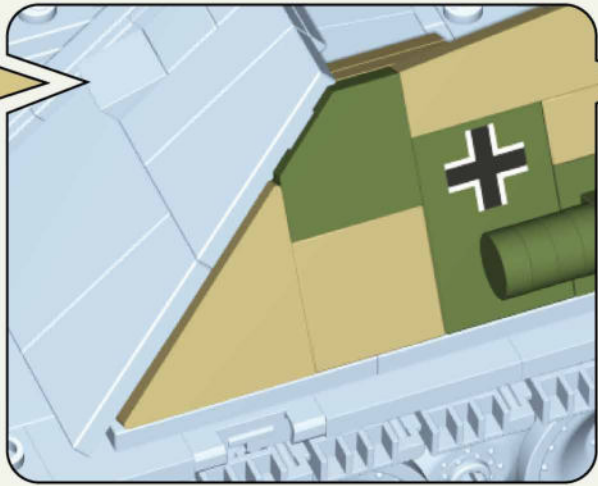
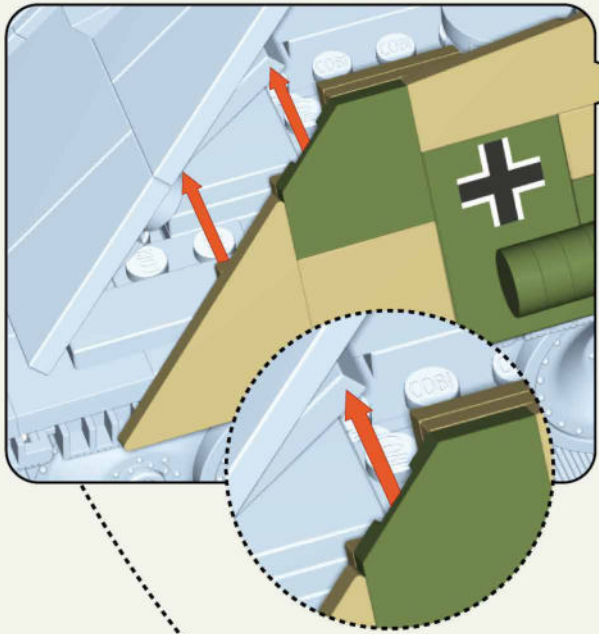







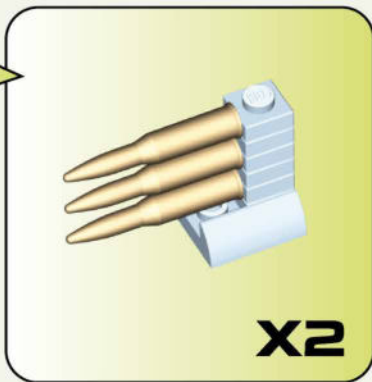
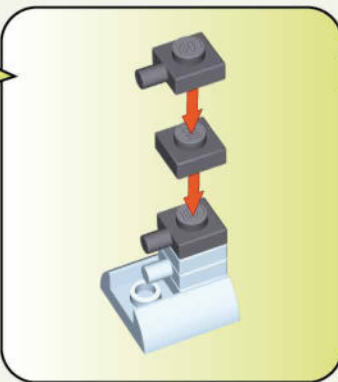
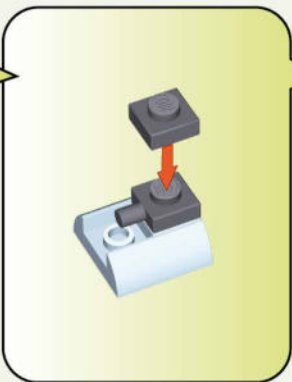
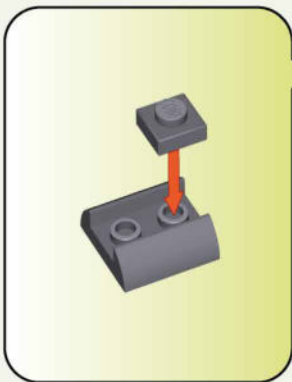

167

3



-  x2
-  x6
-  x6
-  x6

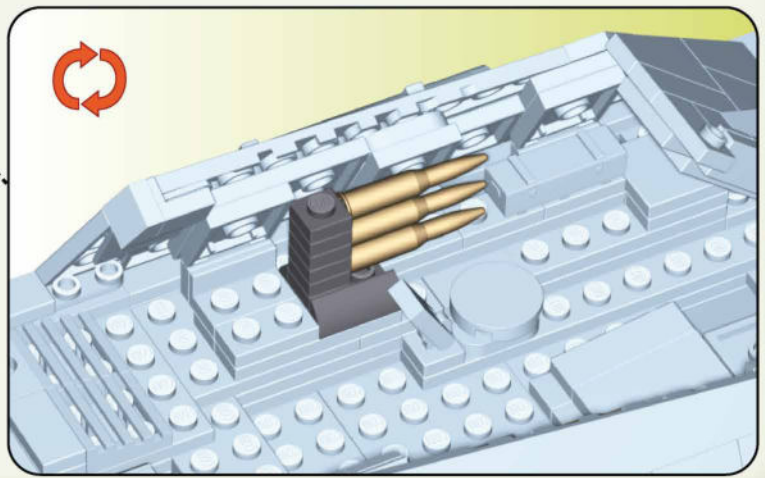
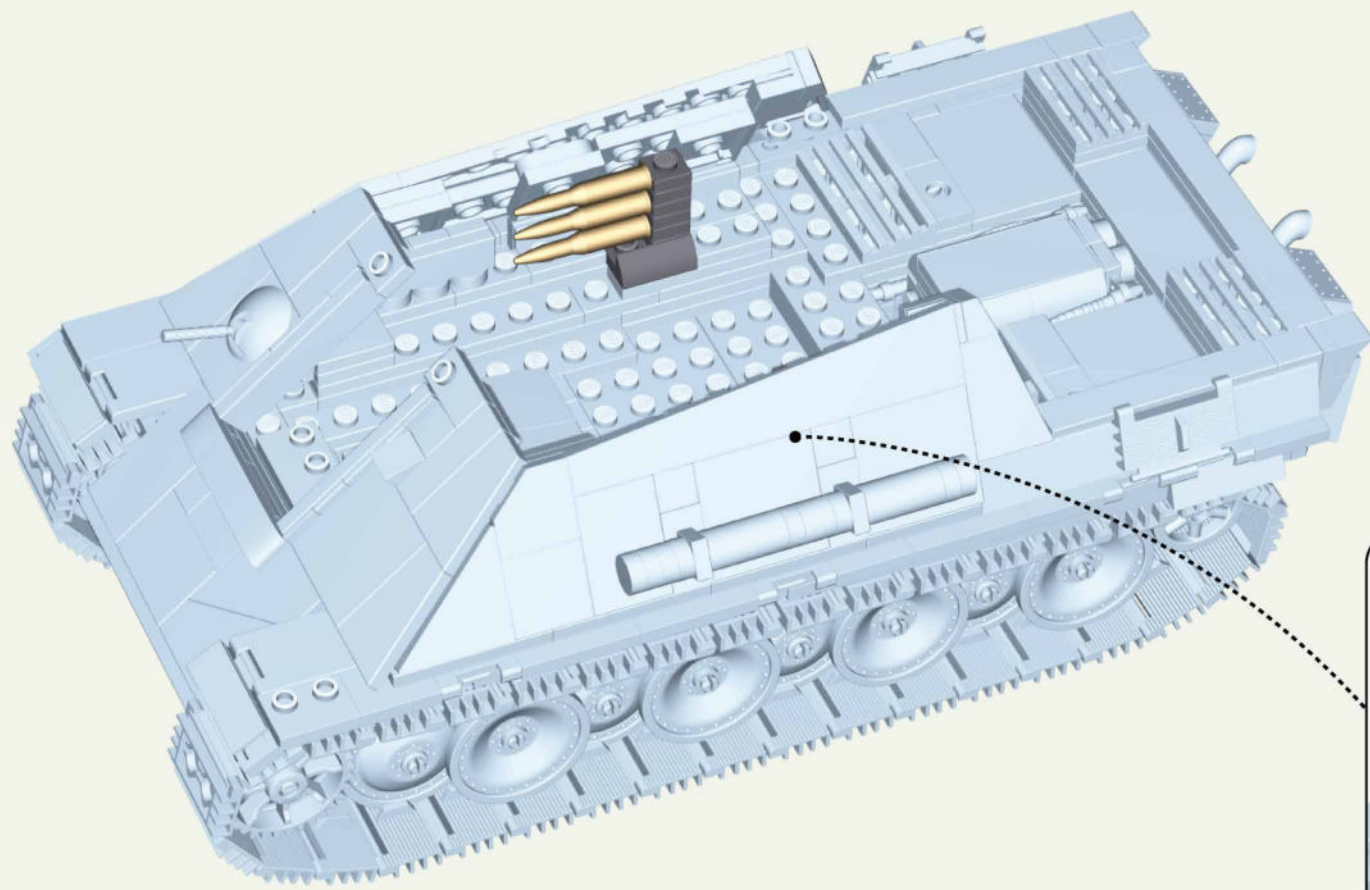

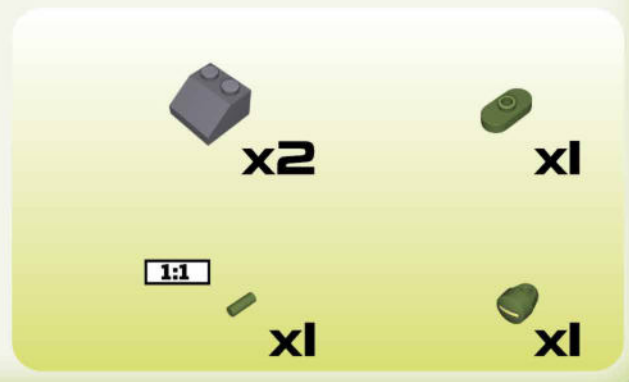
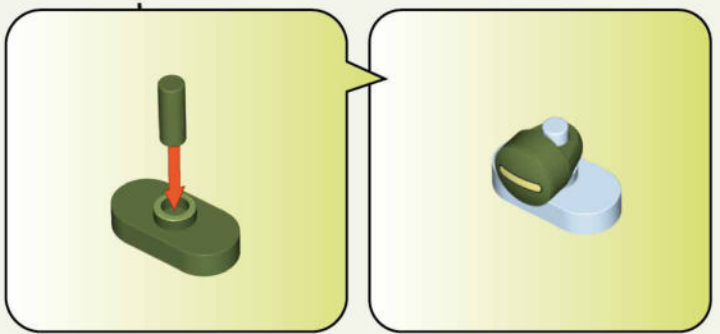
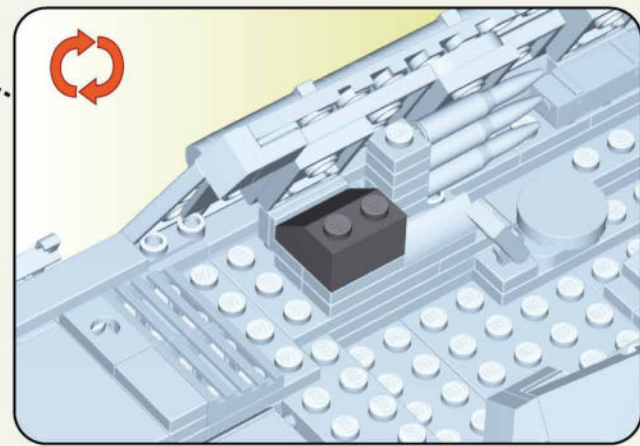
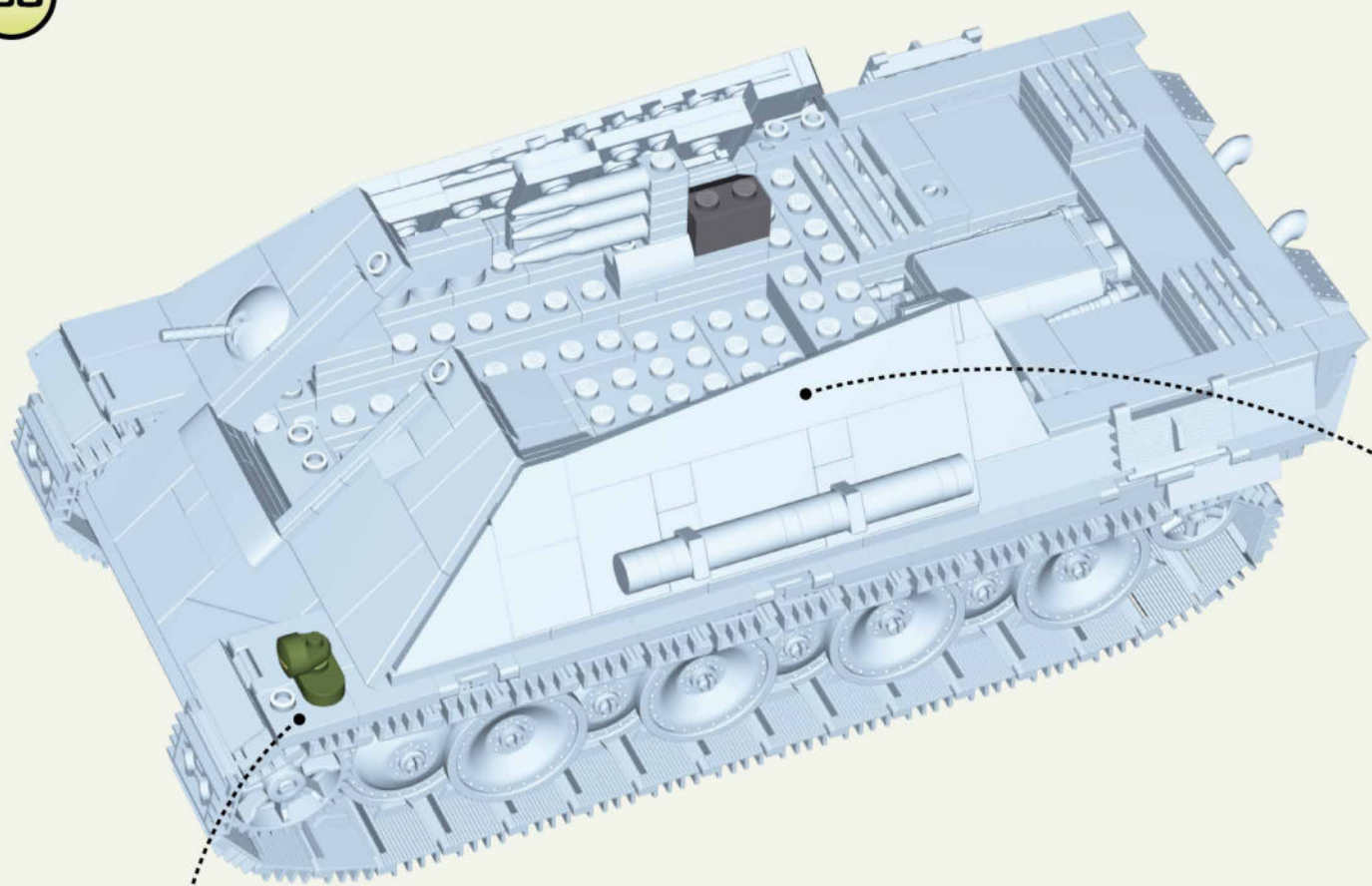

169

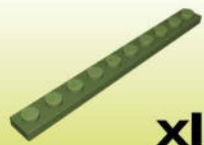
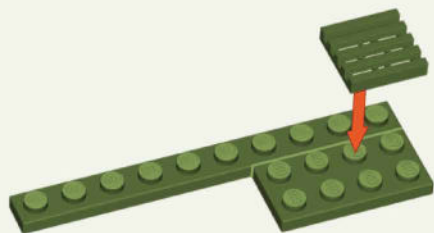

x1



x1



x1

170



1:1



x1



x1

171

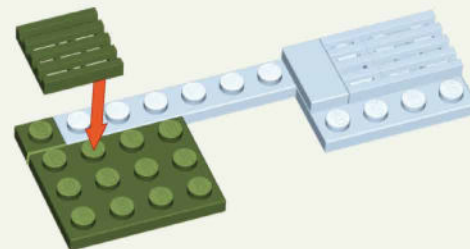

x1



x1



x1

172

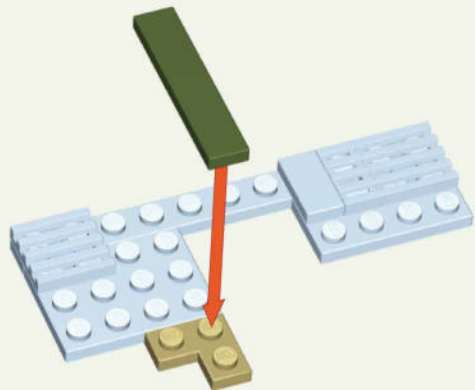

1:1



x1



x1

173

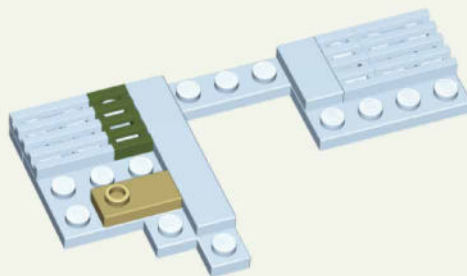

x1



x1

174

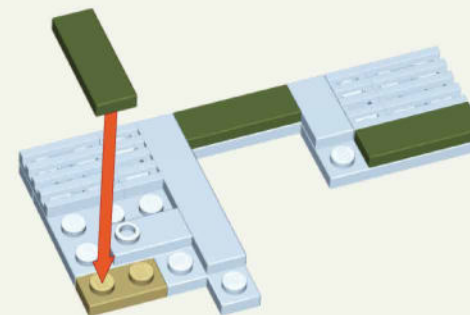

1:1



x1



x3



175

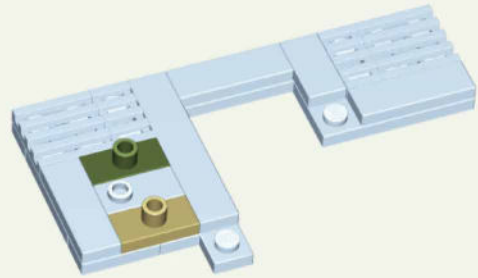

x1



x1

176

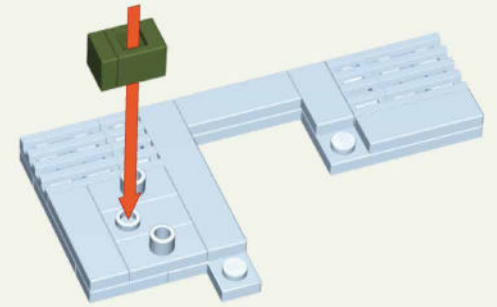
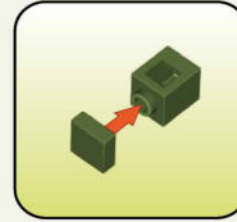

x1



x1

177

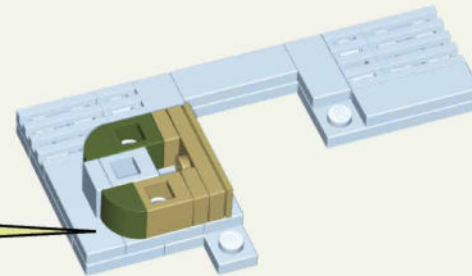
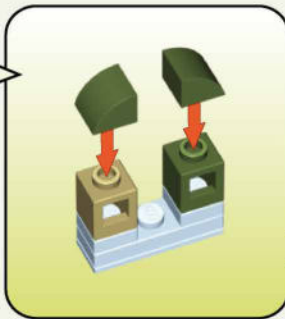
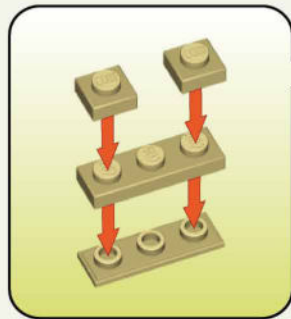

x1



x1



x2



x1



x1

①



x2

178

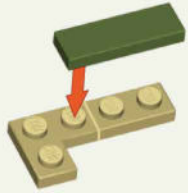

1:1



x1



x1



x1

179

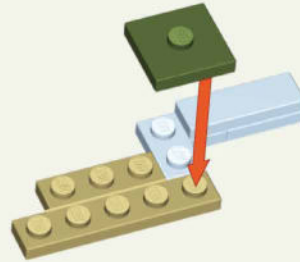

x1



x1



x1

180

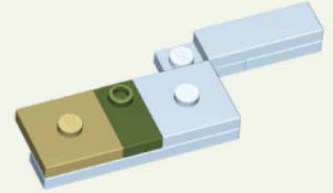

x1



x1

181

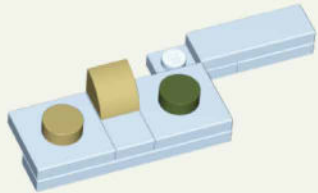

①



x1



x1



x1

182

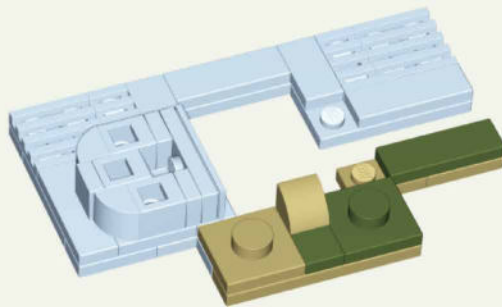

183

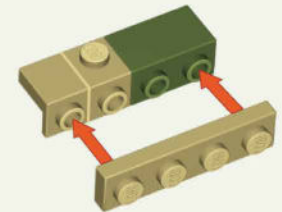

x1



x1

③



x1



x1

184

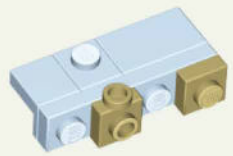

x1



x1

185

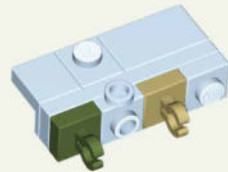

x1



x1

186

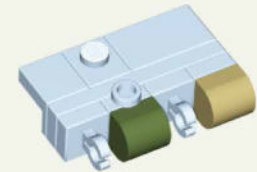

x1



x1

187

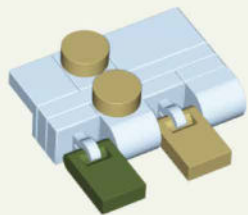

x2



x1



x1

188

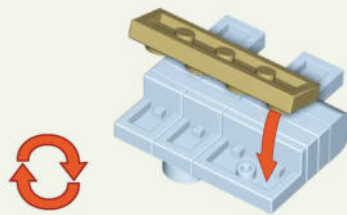

x1

189

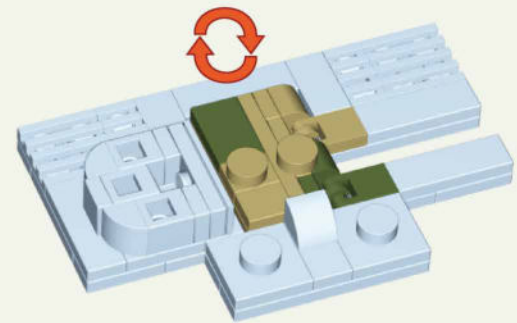



190

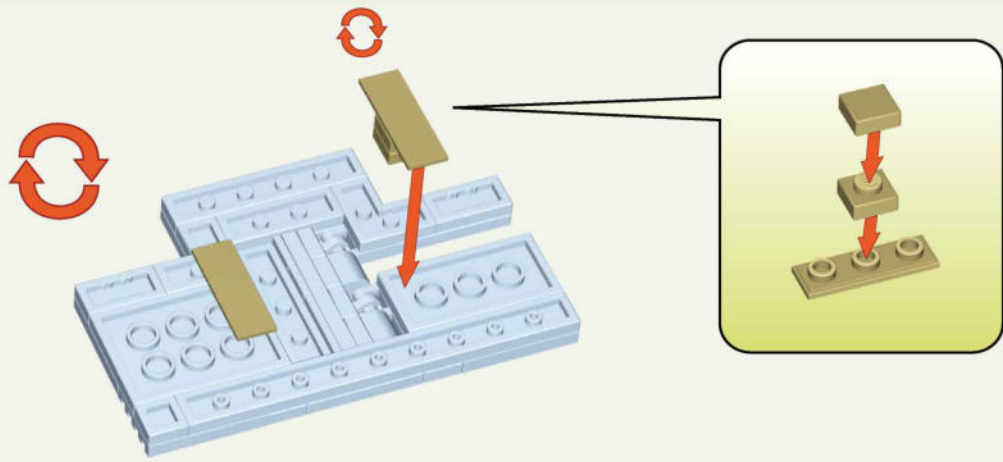

191

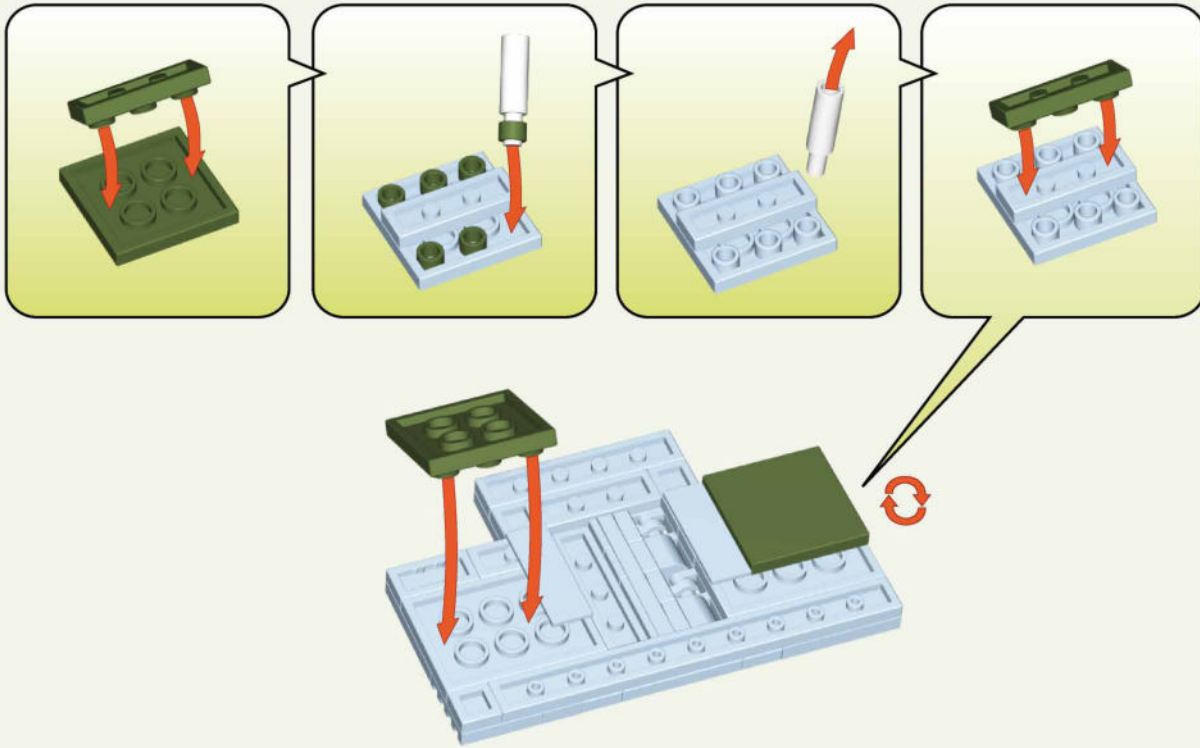

192

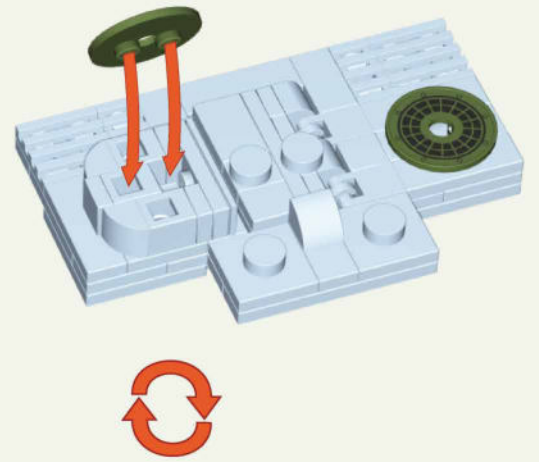

193

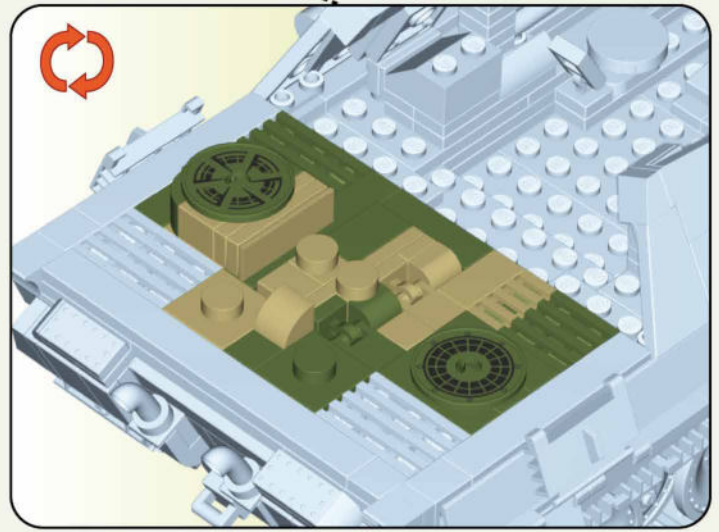
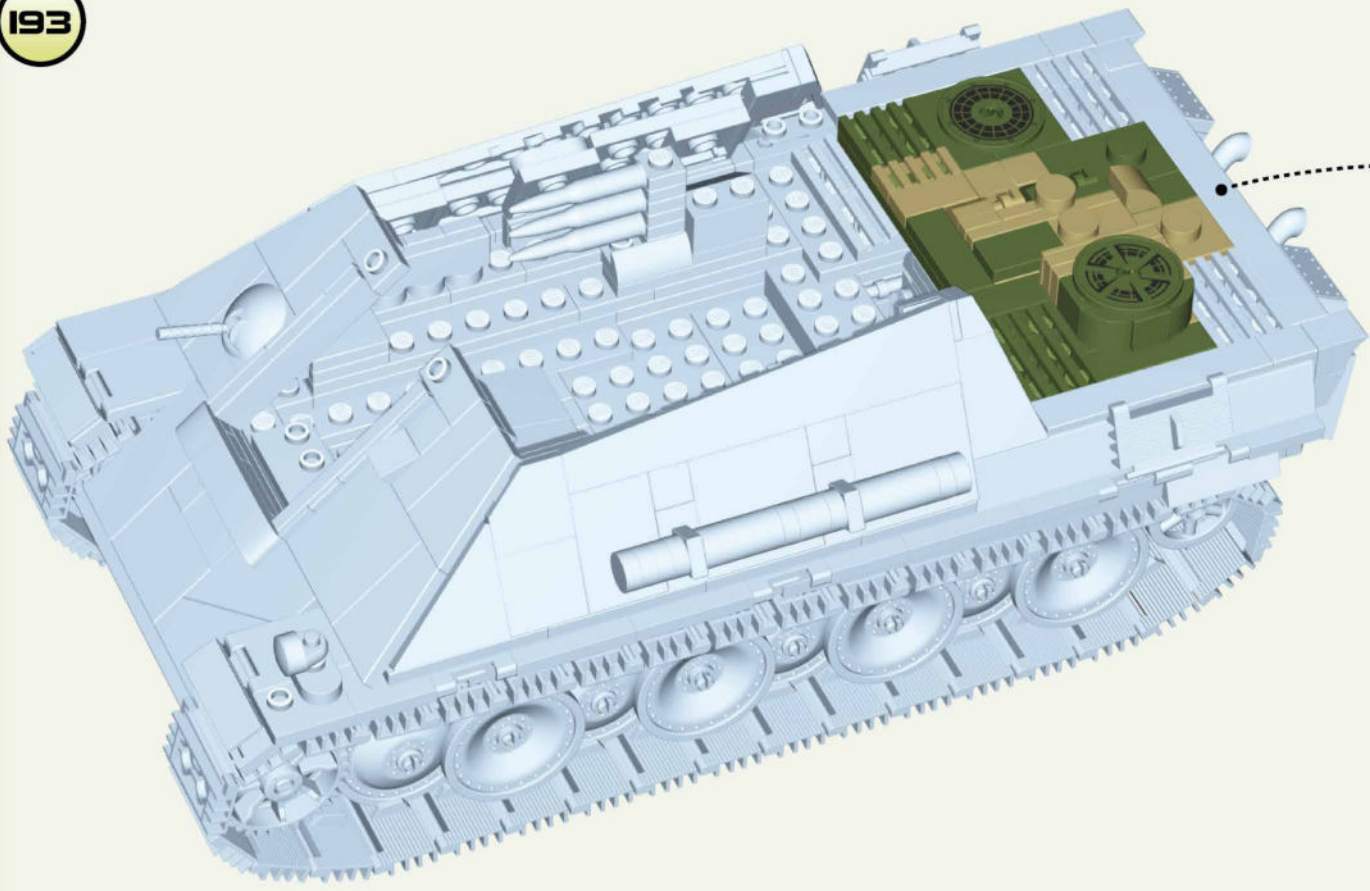

194

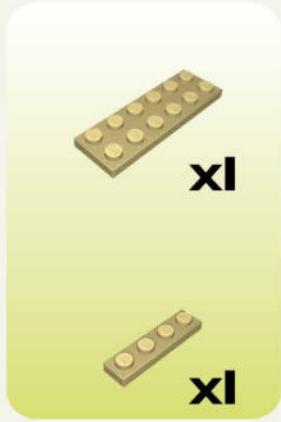
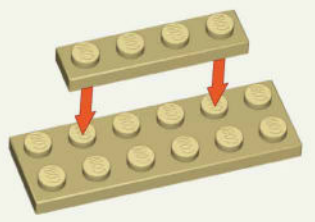

195

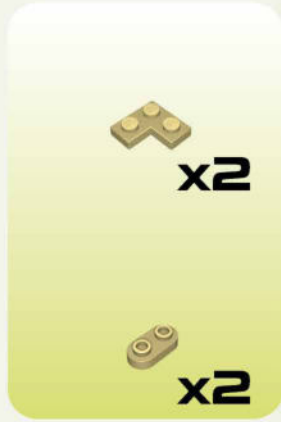
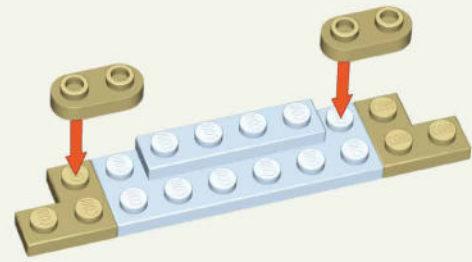

196

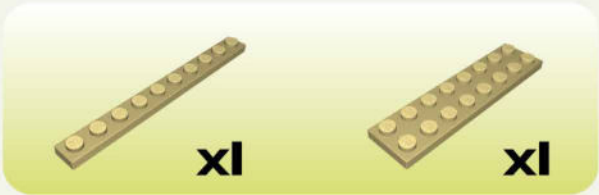
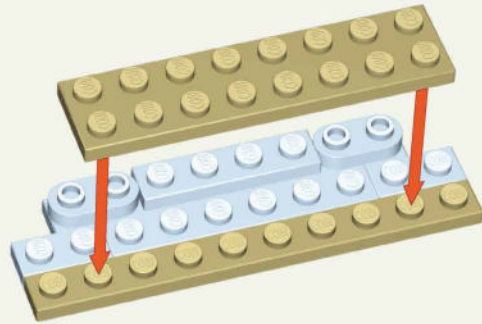

197



198

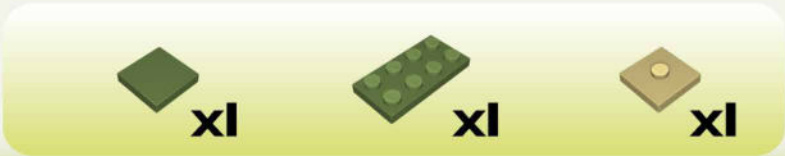
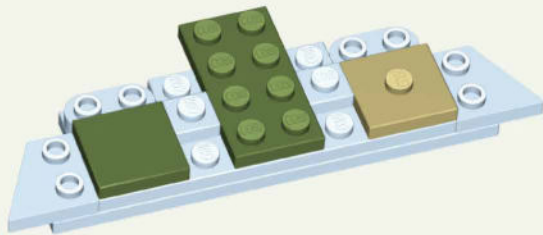

199

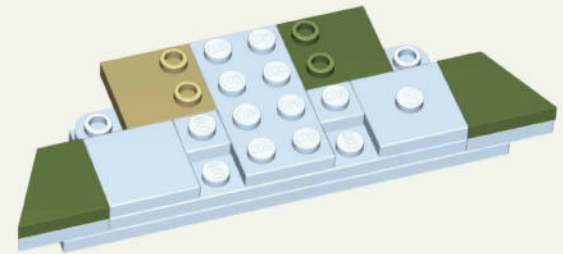



200

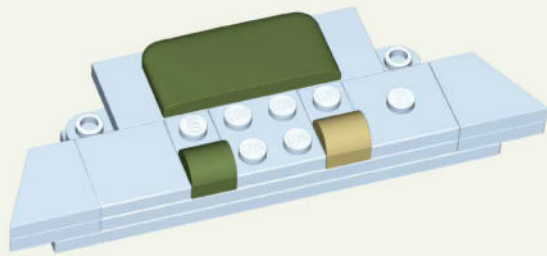

x1



x1



x1

201

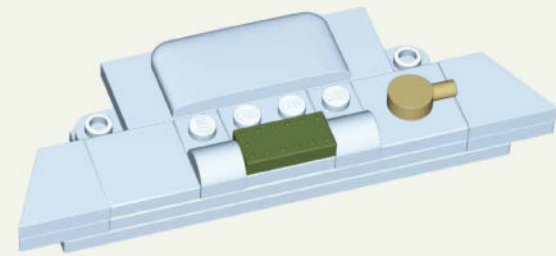

x1



x1

202

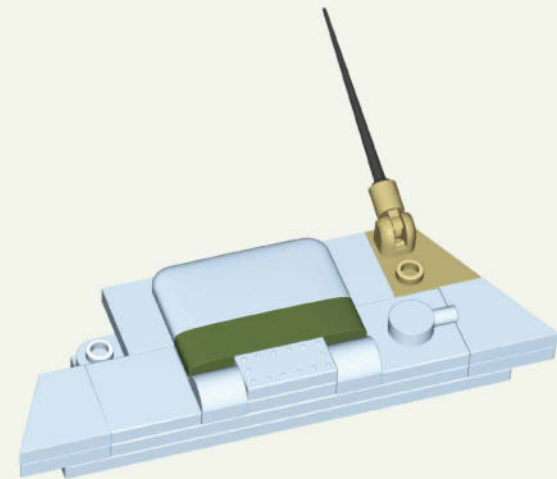
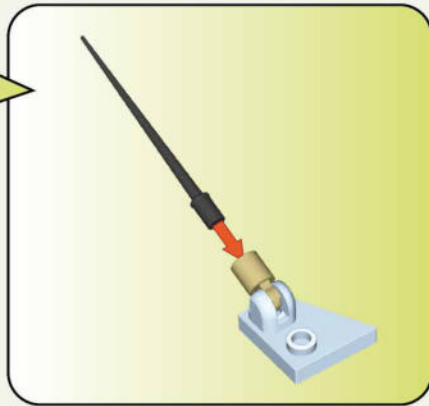

x1



x1



x1



x1



x1



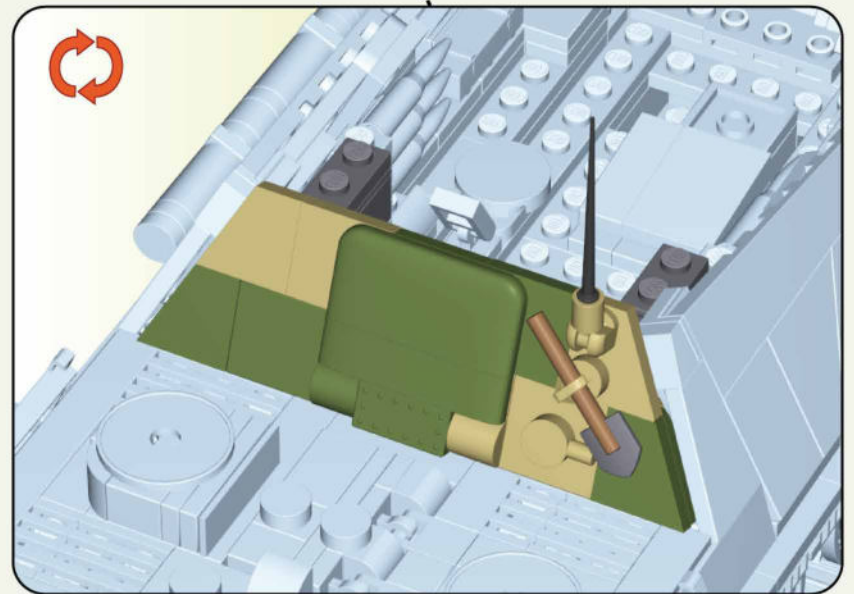
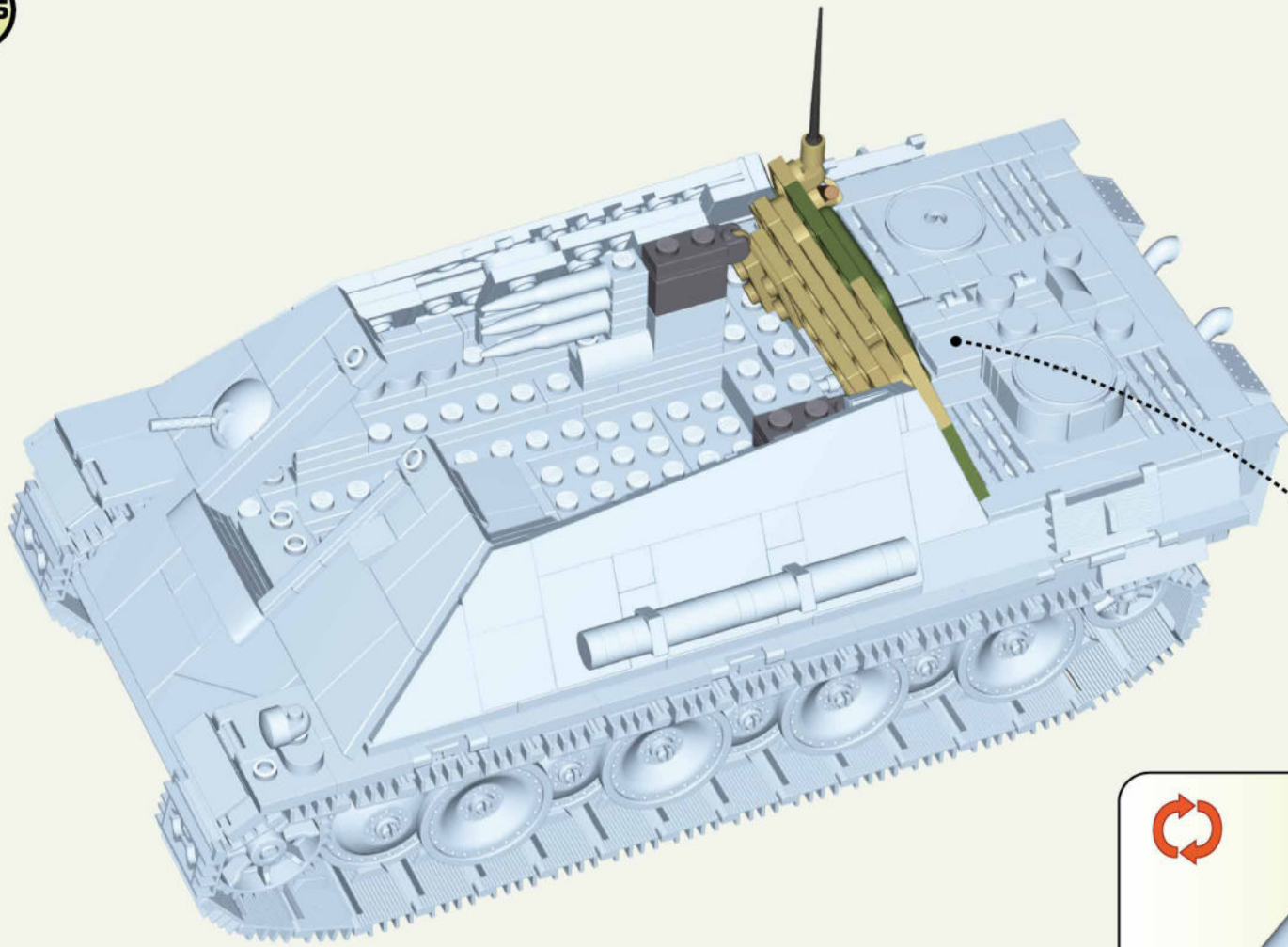



207



x1



x1

208



x2



x1

209



x3

210



x2



x2

211



x2

212



x1



x1



x1

213



x4



x1

214

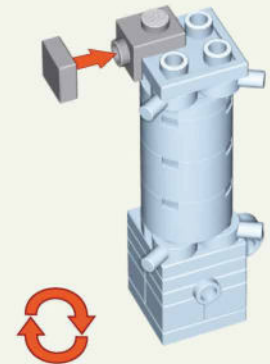

x1



x1

215

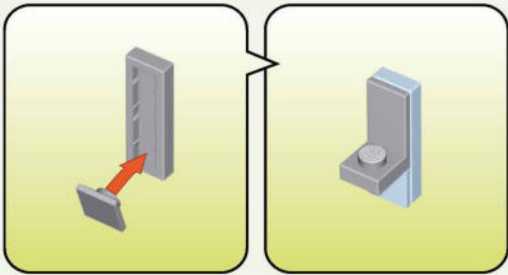

1:1



x1



x1



x1

216



1:1



x2



x2

217



x2



x2

218



x1

219

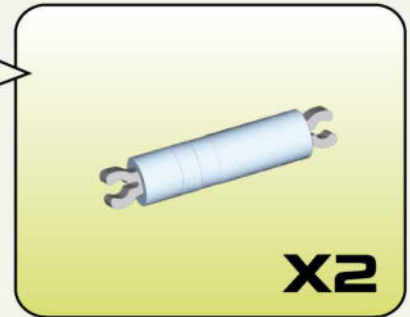
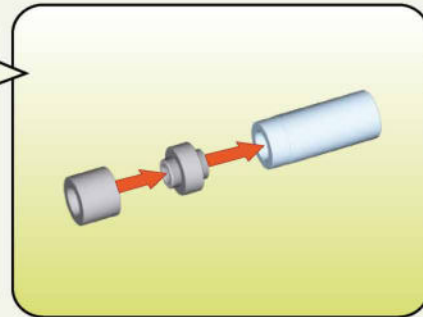
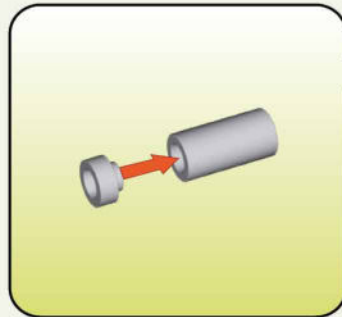

x2



x2



x2



x2



x2







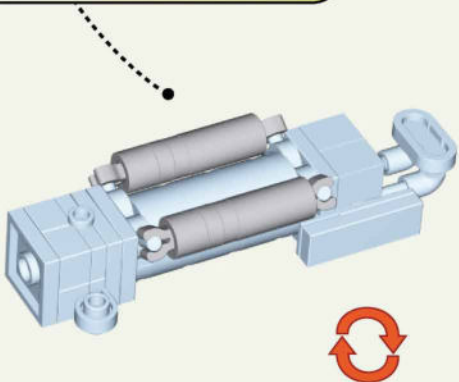
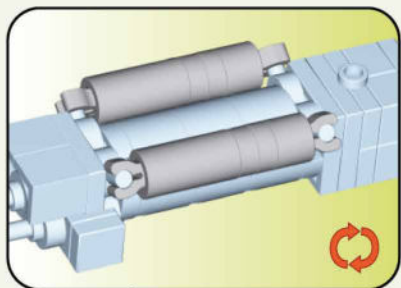

x4

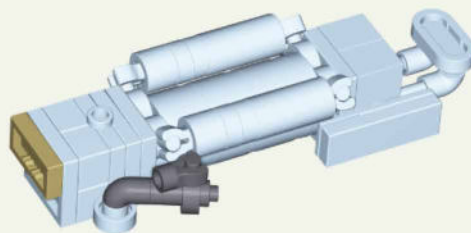
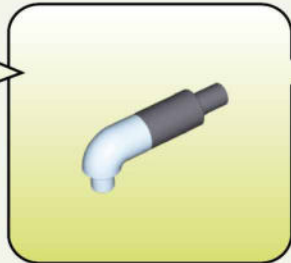
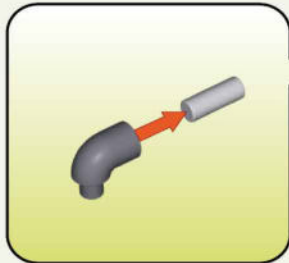
220







221

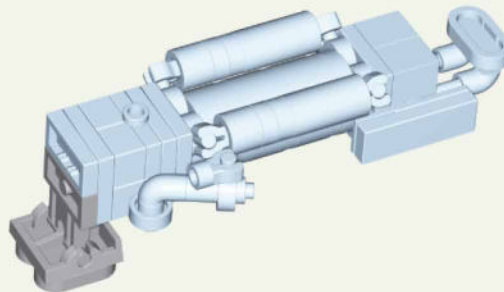
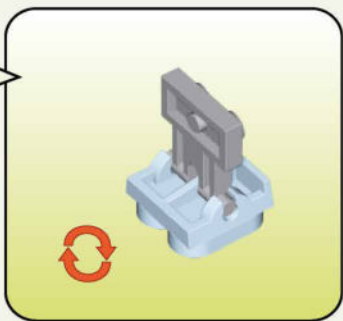
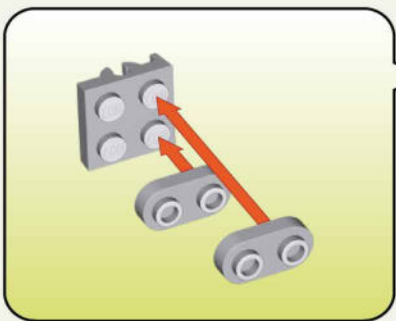

-  x1
-  x1
- 1:1  
 x1
-  x1
-  x1
-  x1

222



-  x2
-  x1
-  x1



223



x2

224



x1

225



x1

226



x2



x2

227

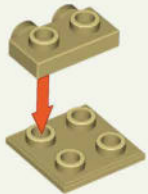

x1



x1

228



x1



x4

229

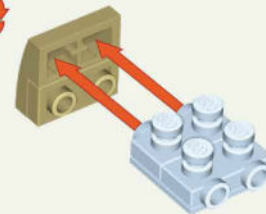

x1



x1

230

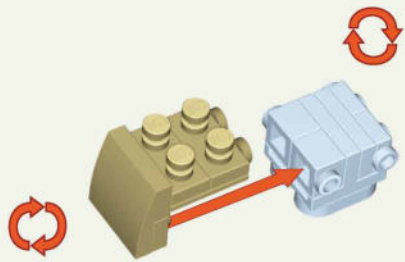

231

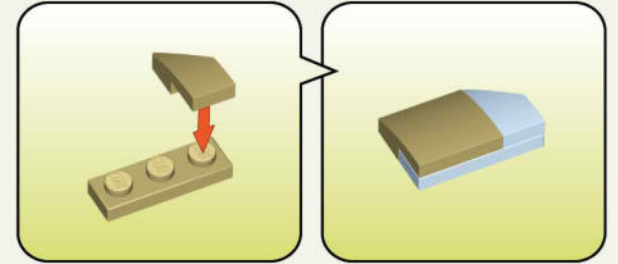
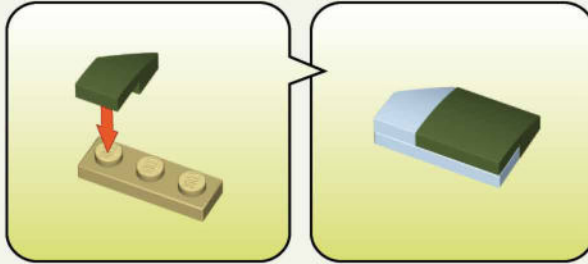

232

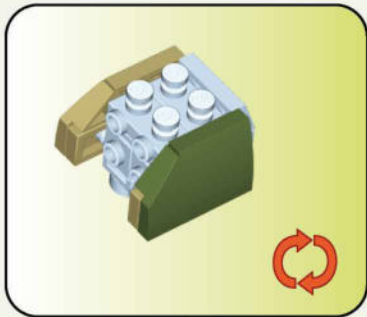

233

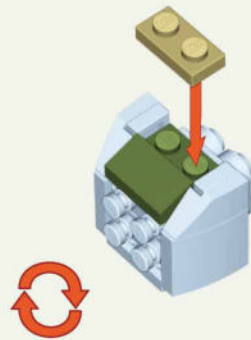

234

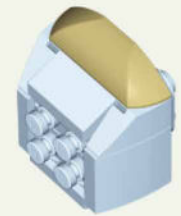

235

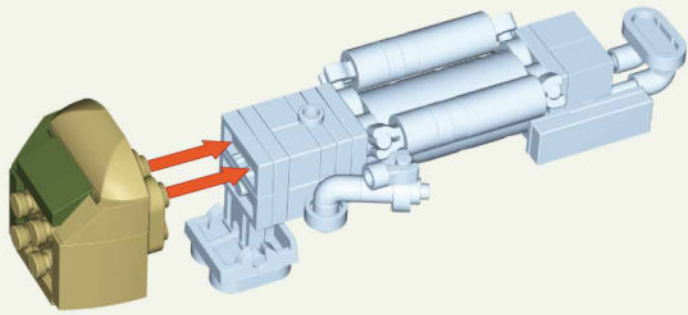

236

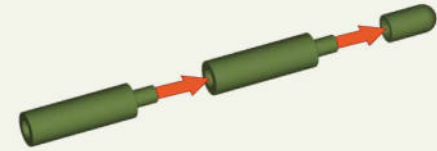

 x2

 x1

237

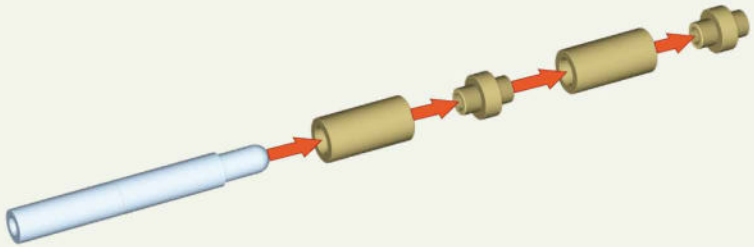

 x2

 x2

238

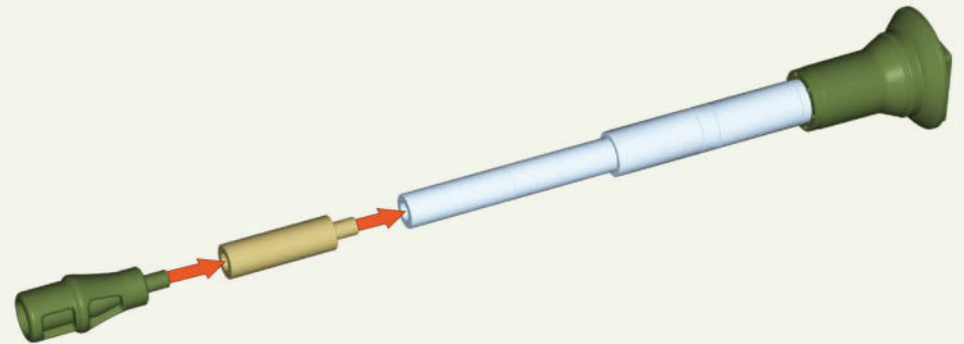

 x1

 x1

 x1

239

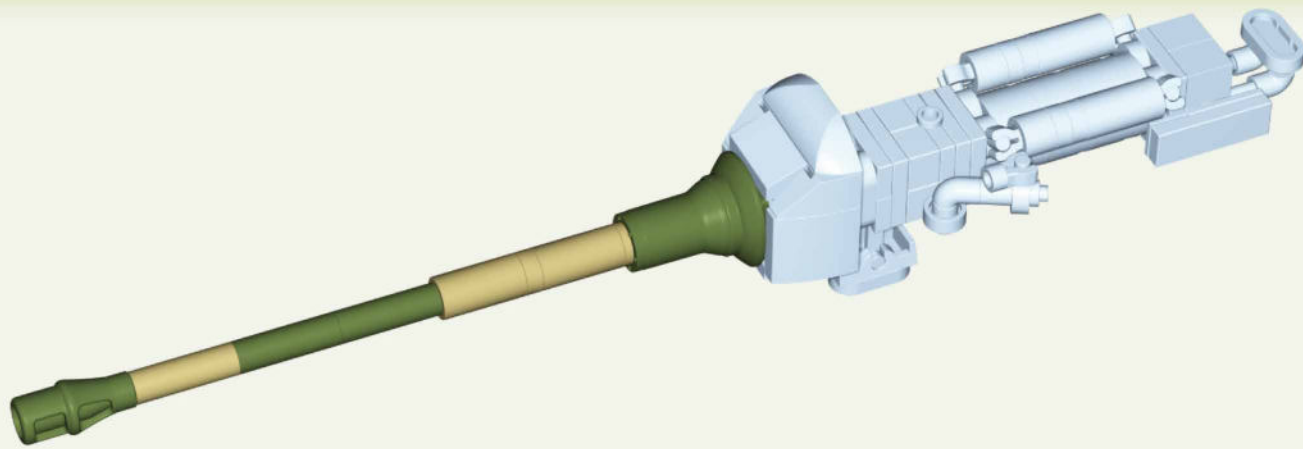

240

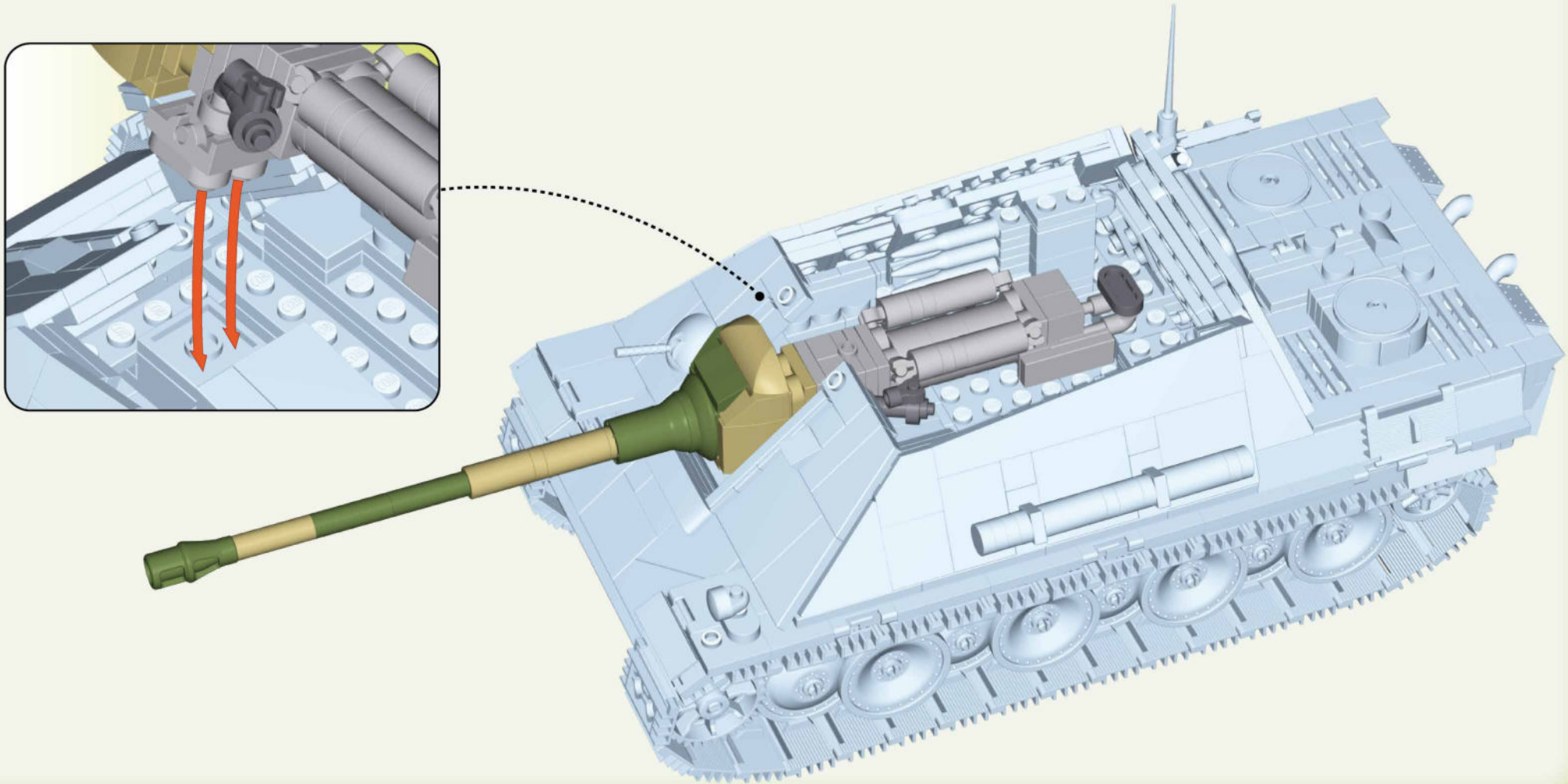



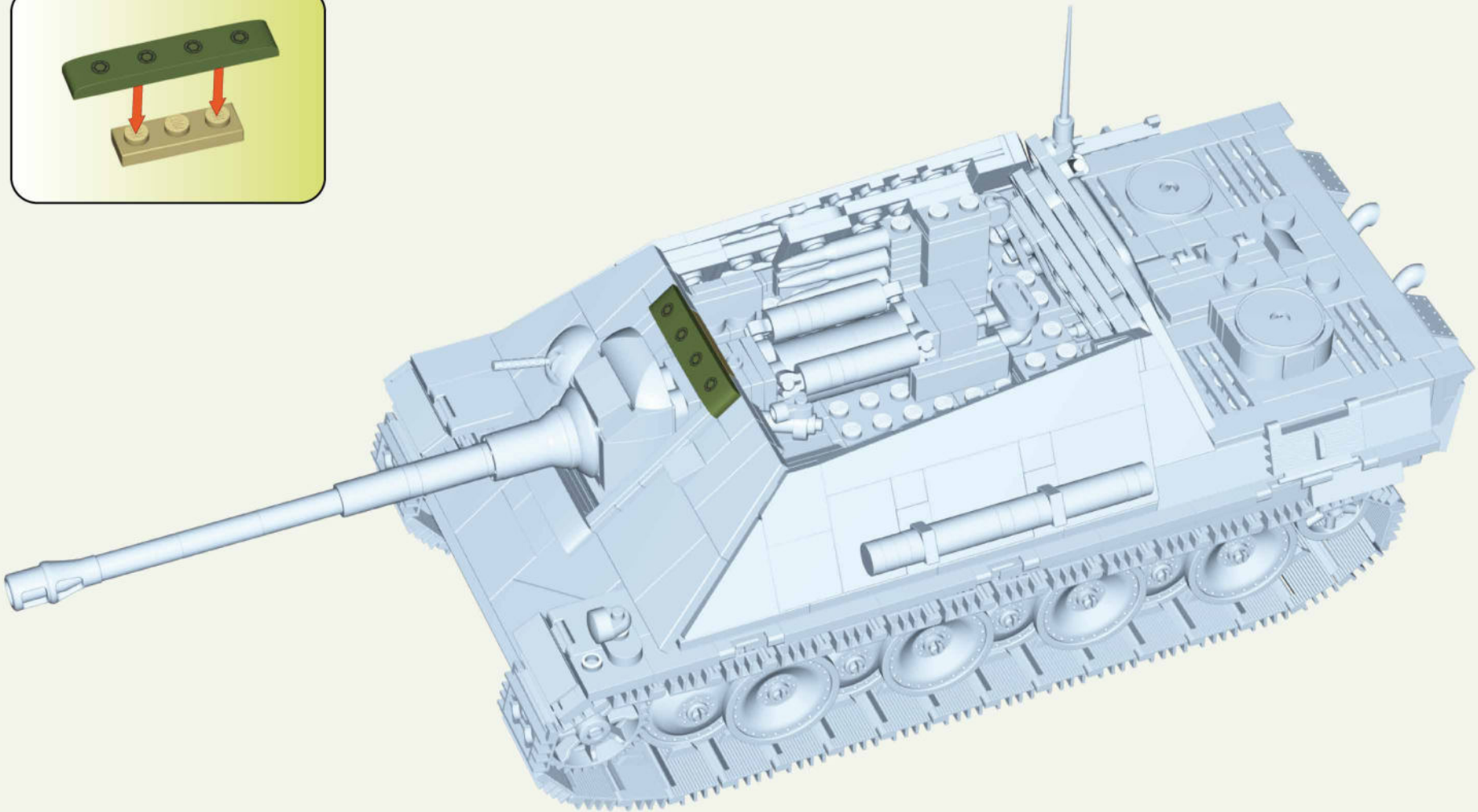
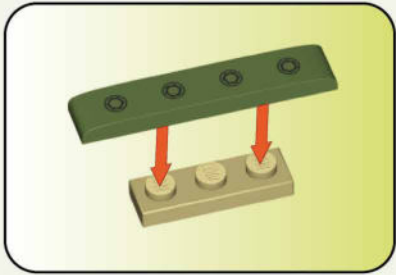

242

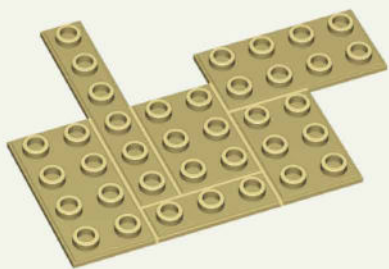

x2



x2



x1



x1

243

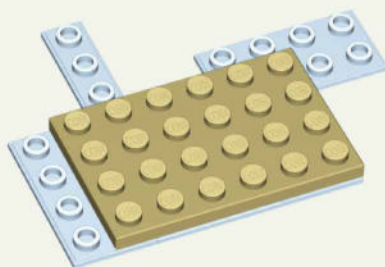

x1

244

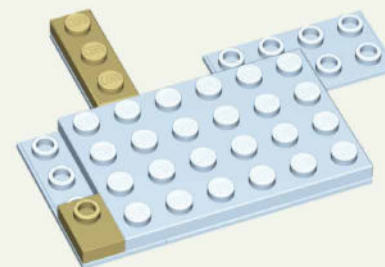

x1



x1

245

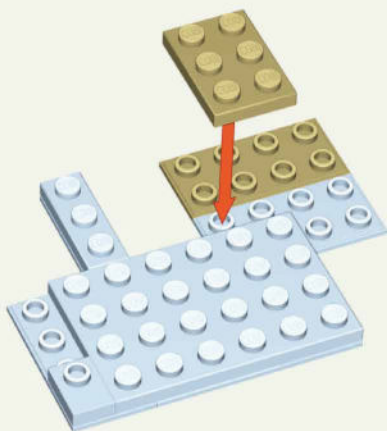

x1



x1

246

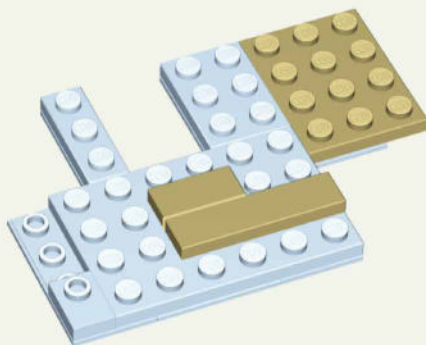

1:1

1:1



x1



x1



x1

247

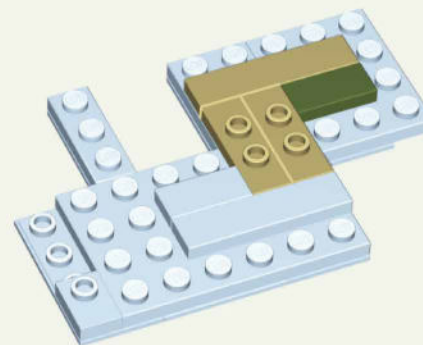

1:1

1:1



x1



x1



x2

248

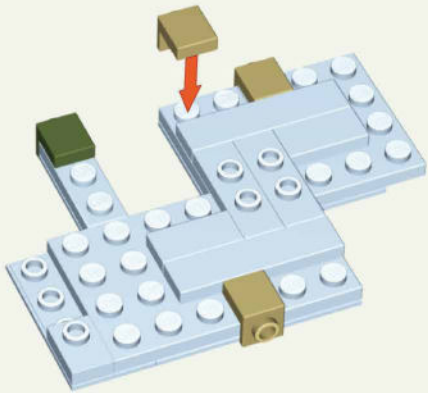

x1



x3

249

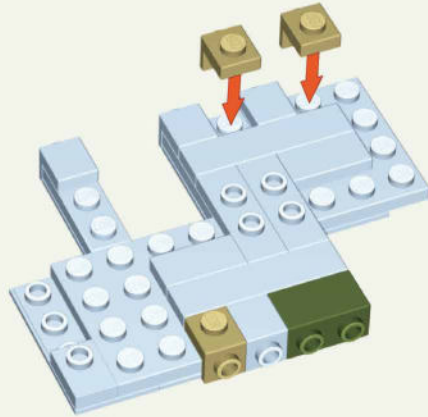

3



x1



x3

250

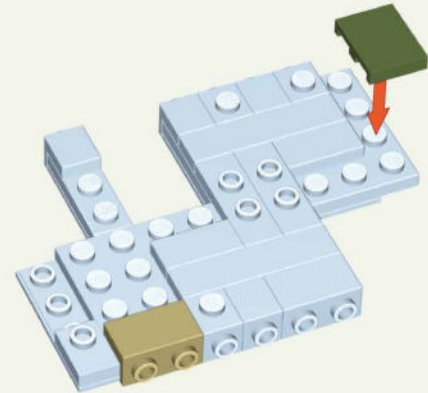

3



x1



x1

251

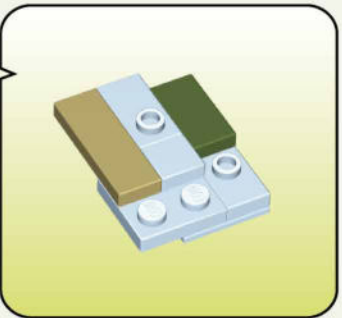
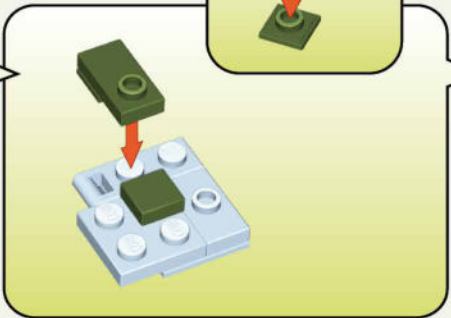
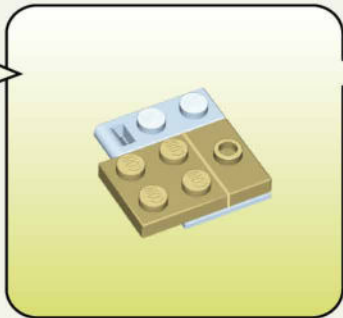
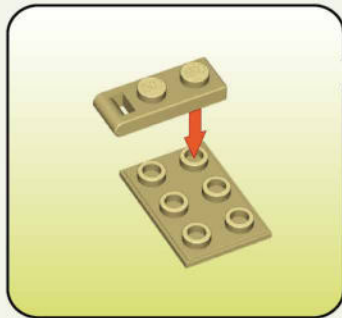

1:1

1:1



x1



x1



x1



x1



x1



x1



x1



x1



x1

252

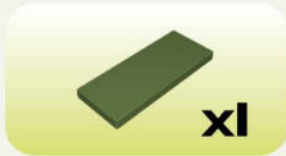
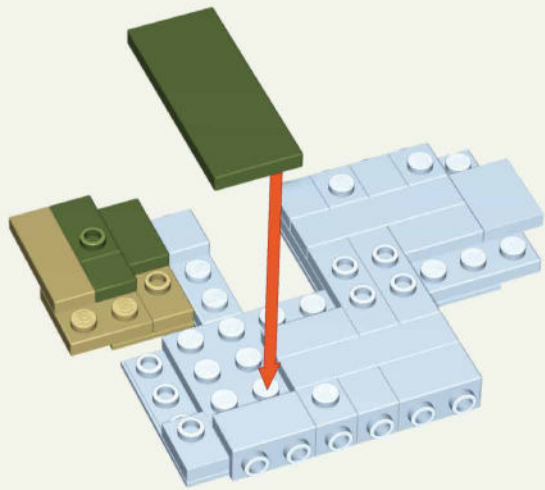

253

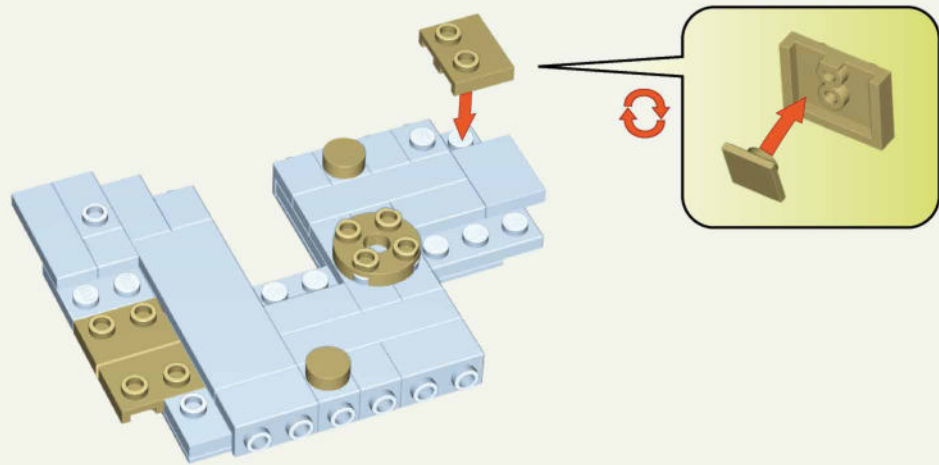

254

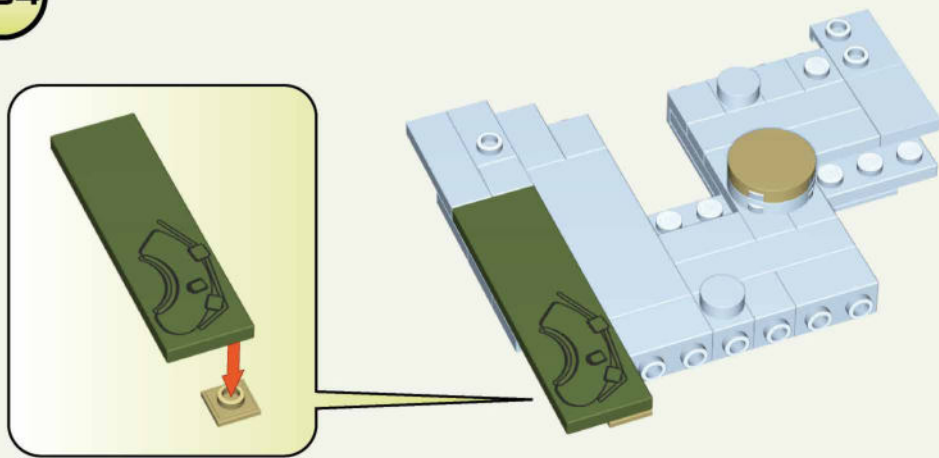

255

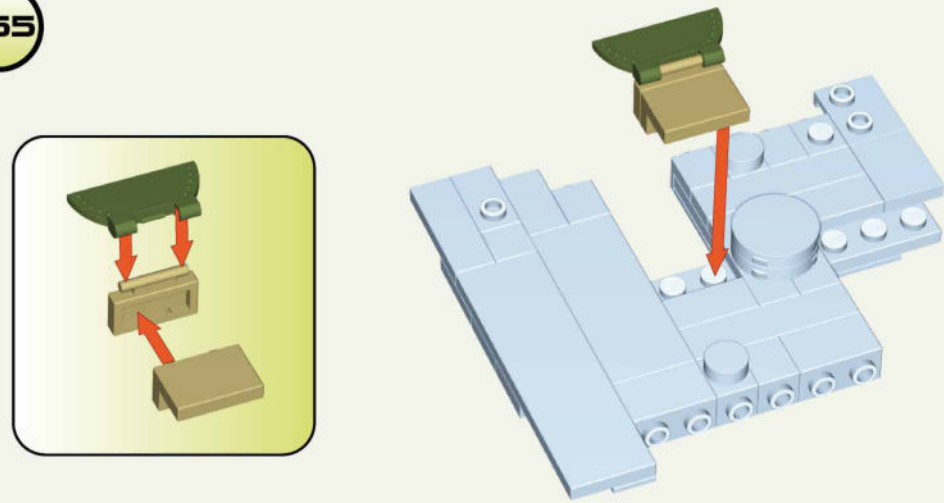



256

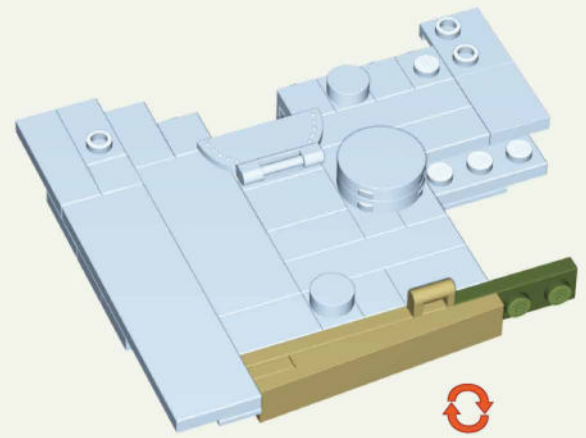
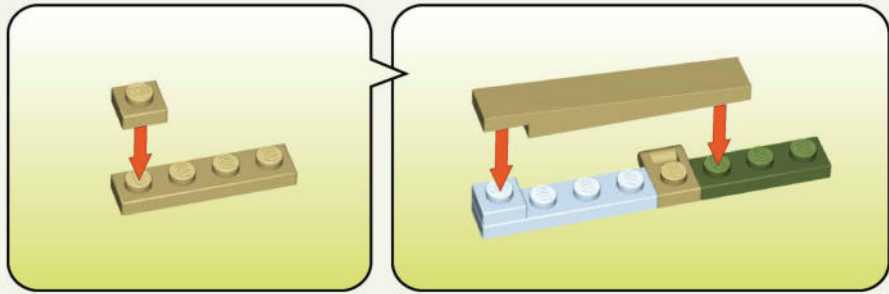

257

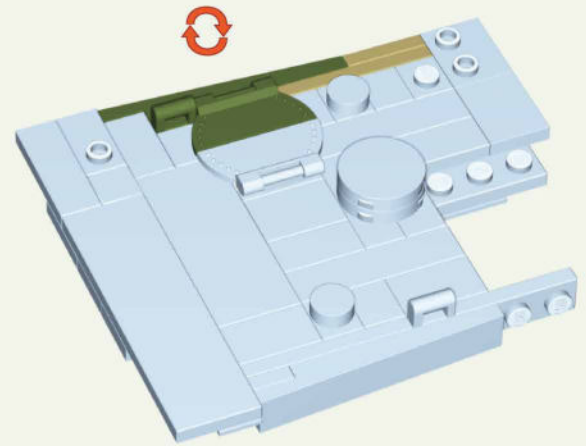
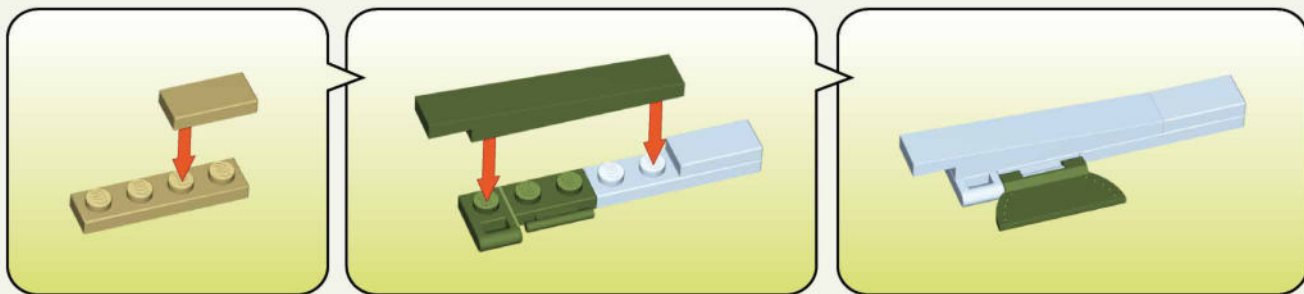

258

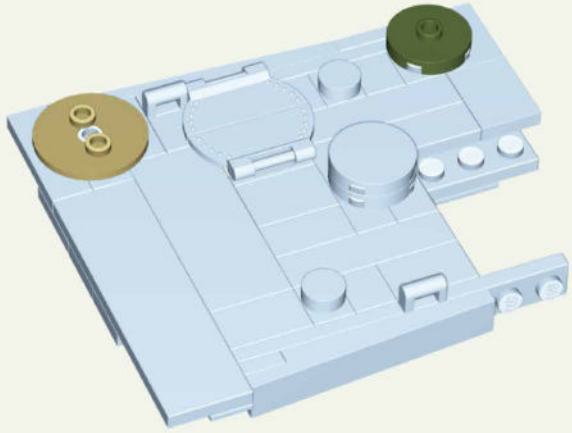

x1



x1

259

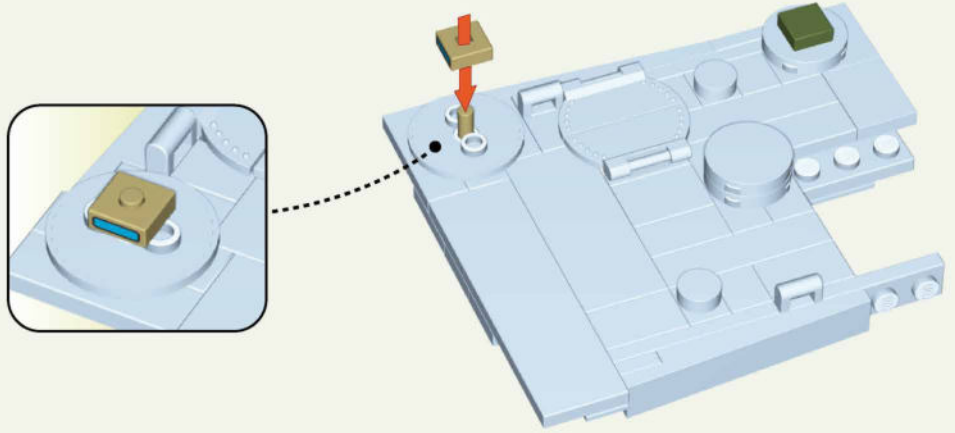

1:1



x1



x1



x1

260

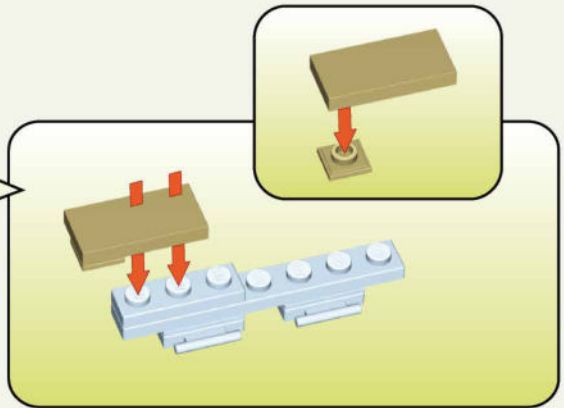
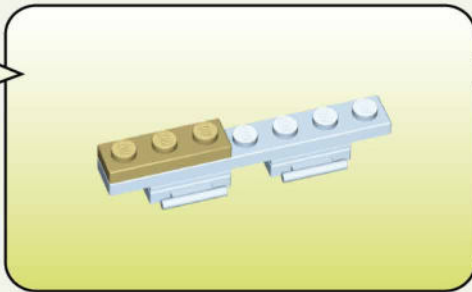
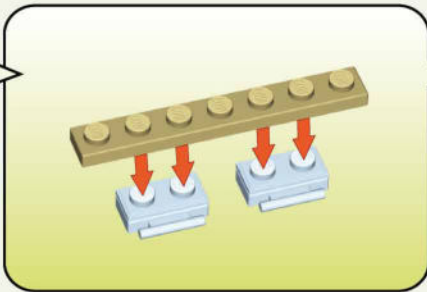
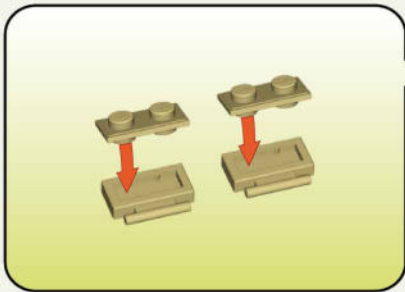

x2



x2



x1



x1



x1



x1

261

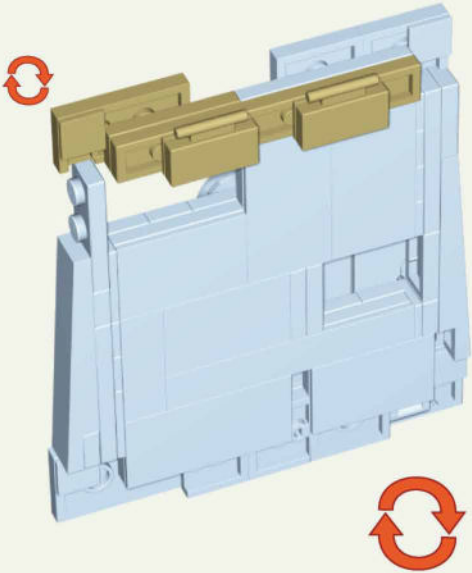

262

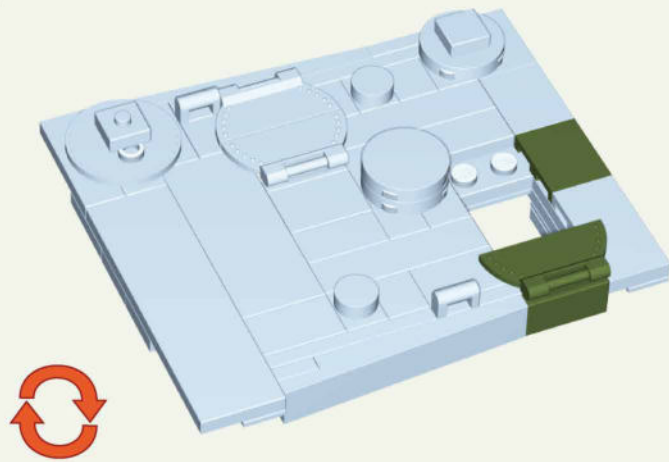

263

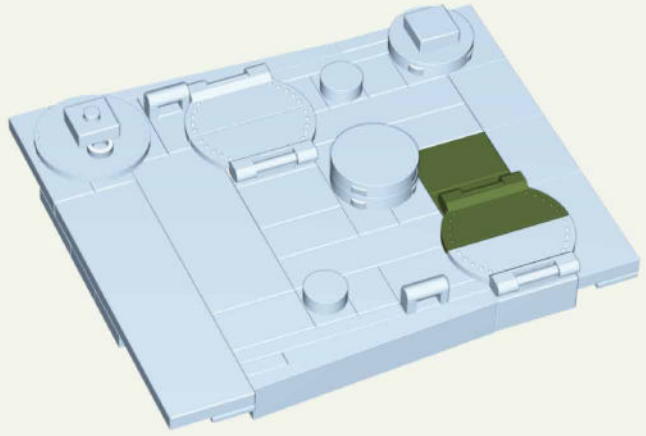
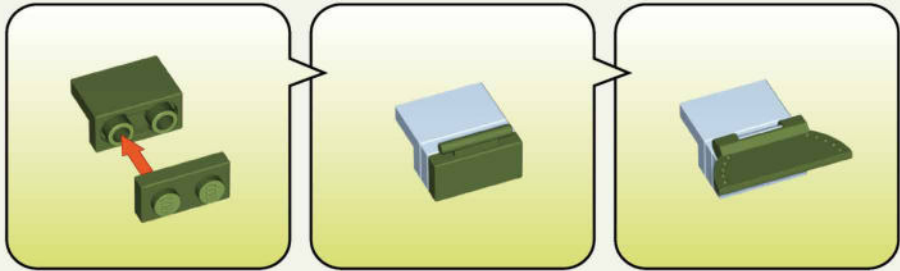

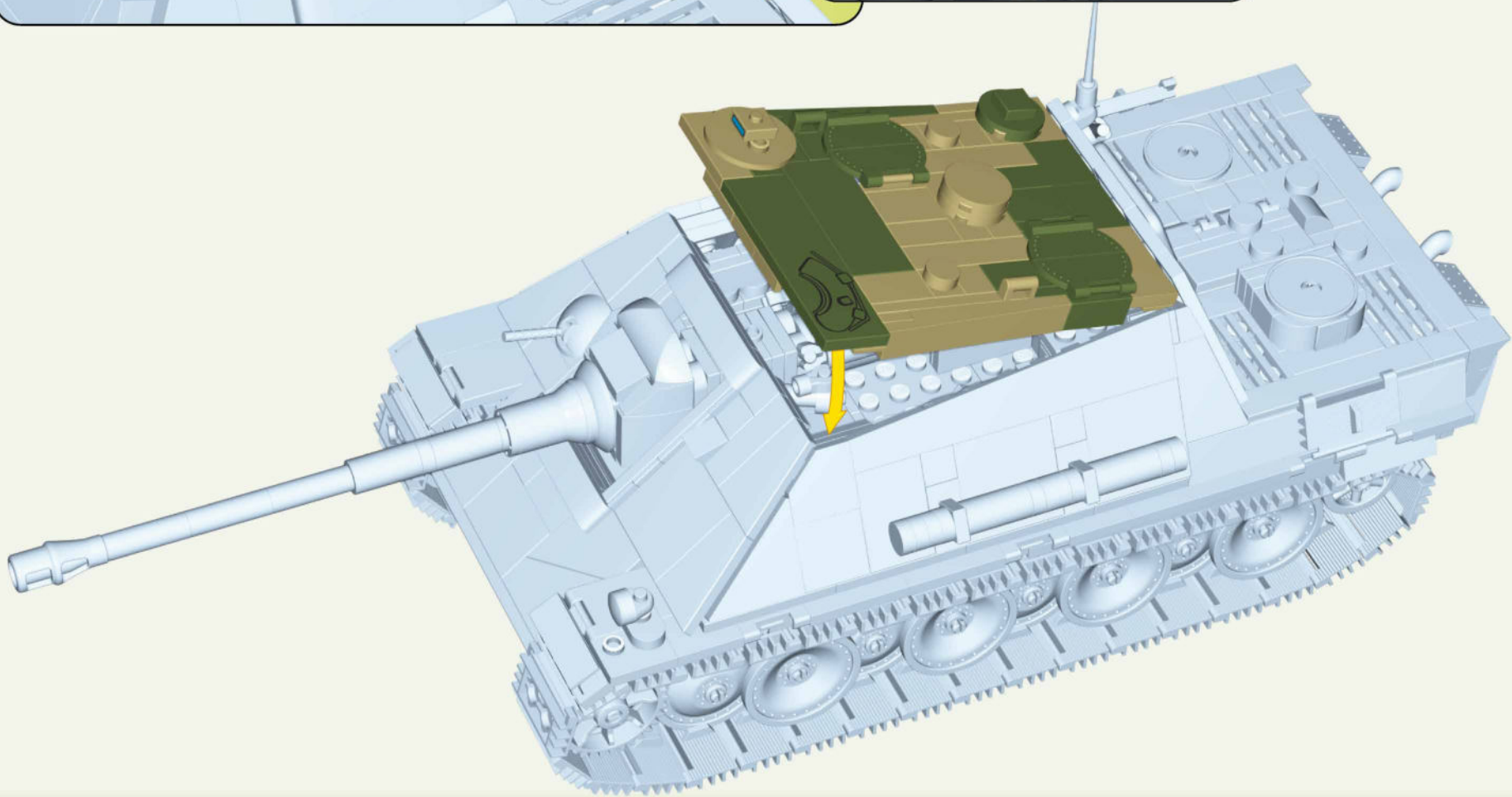
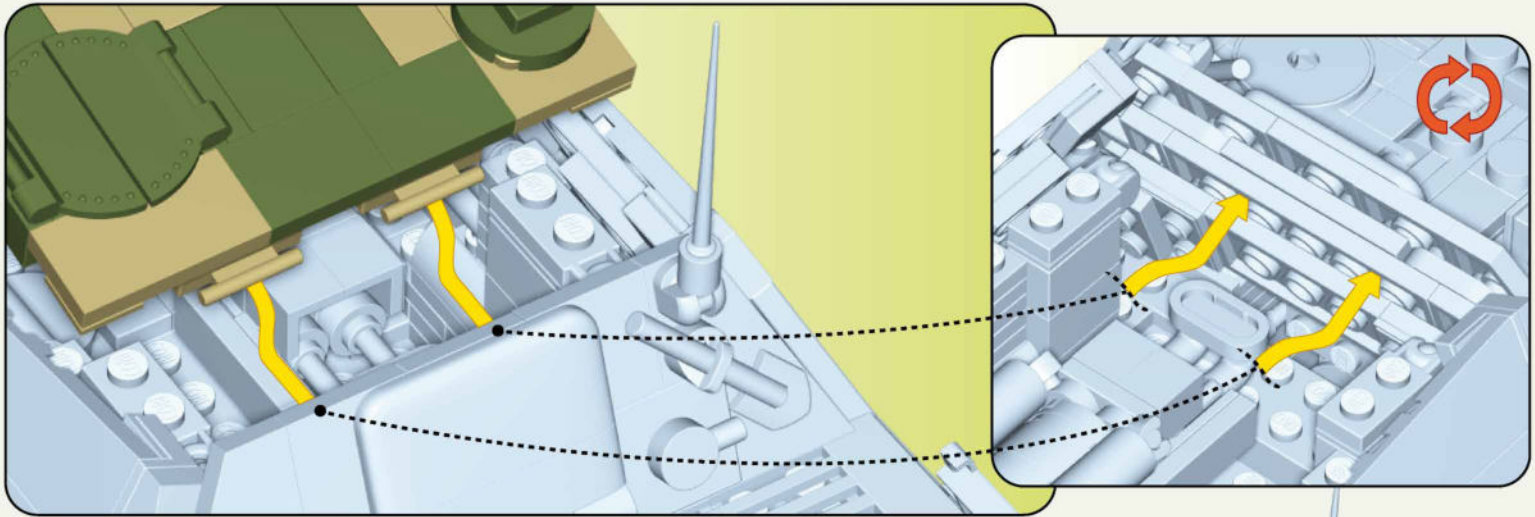



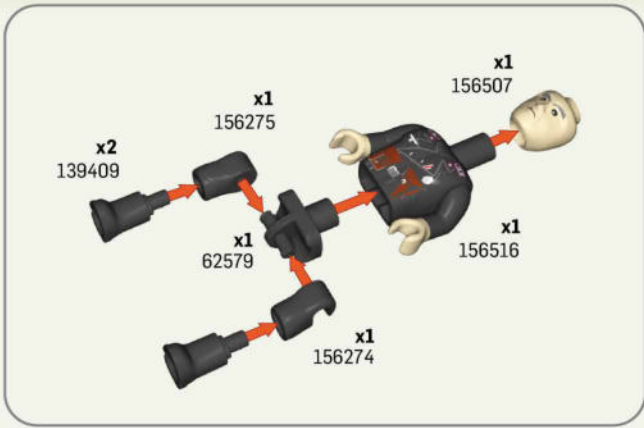

x2 141421	x6 128622	x12 155429	x3 155036	x4 144522	x6 128623	x1 155430
x2 155431	x3 44014	x6 54631	x1 43971	x11 155119	x2 141747	x2 140747
x3 44604	x2 43785	x1 154994	x2 156883	x9 106151	x1 42875	x2 65673
x2 43795	x1 155145	x1 107100	x6 155148	x3 147889	x8 154987	x1 150744

x1 118376	x1 155112	x1 155139	x2 125256	x3 127156	x4 124064	x1 155012	x1 149863	x4 154603	x5 42882	x1 43668	x5 154991
x5 96758	x2 97309	x7 156824	x2 124111	x1 125333	x2 154981	x2 150425	x5 155106	x1 117237	x2 44879	x1 53330	x1 155122
x2 152826	x2 110977	x4 97658	x2 115046	x2 155434	x2 155115	x2 92239	x3 156864	x1 125894	x1 156830	x1 86091	x4 155100
x2 105890	x5 132984	x1 132144	x7 155009	x2 155123	x2 120783	x2 111084	x1 155152	x2 155021	x1 153389	x1 155140	x2 42931
x2 51554	x21 154999	x1 57219	x1 155117	x7 155435	x2 156863	x2 155159	x1 113934	x2 106765	x6 155436	x2 134976	x1 135616
x1 155104	x2 142143	x2 155086	x3 154639	x5 155092	x1 133044	x3 118461	x9 154983	x1 125205	x1 156865	x6 45540	x2 51590
x4 155109	x2 143658	x2 146610	x1 98906	x3 156833	x2 94039	x2 141879	x1 153163	x1 145255	x8 155153	x1 92369	x1 156880
x2 155154	x3 91424	x5 155439	x5 106342	x3 155114	x1 45647	x6 155157	x1 80689	x4 83632	x3 155149	x1 143654	x1 156881
x2 53530	x2 112151	x1 56008	x1 155441	x3 111481	x1 109698	x1 155110	x1 132618	x2 135615	x4 156832	x1 111091	x3 42959



x1 57130 x7 155000 x7 93457 x1 93456 x3 155107 x1 115502 x1 116337 x3 113420 x8 155156 x1 156859 x2 94649 x1 147990

x1 109733 x5 155101 x2 51558 x13 155087 x1 100145 x2 156850 x3 64202 x5 155050 x2 156897 x2 155442 x2 128234 x2 156900

x1 148707 x3 155082 x5 155089 x3 85566 x1 156906 x4 155074 x5 155090 x2 156901 x1 130483 x1 156887 x4 155443 x1 155085

x1 156904 x5 155444 x1 43048 x12 155079 x1 70940 x2 119830 x1 155008 x1 51597 x3 43685 x11 156858 x1 53205

x1 44140 x1 156889 x9 155095 x1 107485 x2 156869 x3 108154 x1 156879 x2 123441 x2 43114 x3 156874 x2 54893 x2 156831

x1 111485 x1 122046 x1 123424 x1 156877 x1 150046 x2 156827 x1 150047 x1 156828 x1 118379 x1 155445 x1 79994 x1 77561

x2 156885 x1 77515 x3 155162 x1 124559 x4 156862 x1 97401 x1 156896 x1 156851 x2 156860 x12 155164 x1 80688 x1 121919

x2 156884 x4 156861 x3 110701 x2 156891 x3 155103 x3 155163 x2 138843 x6 155088 x1 86989 x2 155054 x2 74224 x1 156853

x1 58886 x3 154977 x2 43168 x3 155446 x1 106743 x1 43174 x5 99328 x3 155447 x1 156852 x1 156854 x7 155448 x2 155084

x1 113535 x1 155449 x1 155450 x1 155075 x5 155452 x1 156898 x5 156855 x2 155081 x4 156857 x1 100381 x1 156899

x3 109913 x3 155078 x2 108326 x2 156905 x1 44756 x1 155453 x1 44757 x1 155454 x1 128823 x1 156893 x2 87252 x1 89462







# HISTORICAL COLLECTION



FOCKE-WULF FW 190 A-3  
+ 5741



FOCKE-WULF FW 190 A5  
+ 5722



PZL P.11c  
+ 5742



P-47 THUNDERBOLT™  
⊕ 5737

**NORTHROP GRUMMAN**





# HISTORICAL COLLECTION



PANZERKAMPFWAGEN E-100  
+ 2572

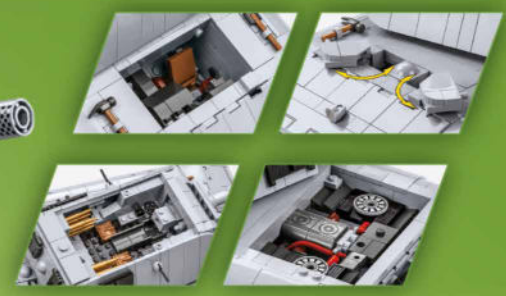

BATTLE OF ARRAS (1940)  
MATILDA II vs PANZER 38(t)  
+ 2284



15cm NEBELWERFER 41  
+ 2291



Sd. Kfz. 9/1 „FAMO“  
+ 2281



BM-13 KATYUSHA (Zis-6)  
★ 2280



ZiS-3 SOVIET GUN  
★ 2293





# HISTORICAL COLLECTION



FIELD KITCHEN (HF.14)  
+ 2290



H.M.C M8 SCOTT  
2279



MARDER III Ausf. M  
+ 2282



Sd.Kfz. 251/9 "STUMMEL"  
+ 2283



Sd.Kfz.7 HALF-TRACK  
+ 2275



10,5cm leFH 18  
+ 2292

