

HISTORICAL COLLECTION

WORLD WAR II



STURMGESCHÜTZ IV
 IN SERVICE - 1944 - 1945
 PLACE OF ORIGIN - GERMANY
 TYPE - ASSAULT GUN
 WEIGHT - 23T (50700LB)
 ARMOUR - 10-80MM (0.4' - 3.1')
 ARMAMENT - 1x 7,5cm STUK 40 L/48,
 1x 7,92mm (.312') MG 34
 ENGINE - MAYBACH HL 120 TRM, 220KW (300HP)
 MAX SPEED - 38KM/H (23,6MPH)
 RANGE - 210KM (130MI) ON THE ROAD
 CREW - 4



Sturmgeschütz IV
 Sd.Kfz. 167

PAD PRINTED
NO STICKERS

Printed in EU

2576



WARNING: CHOKING HAZARD-
 Toy contains small parts.
 Not for children under 3 years.

952

STURMGESCHÜTZ IV

SCALE 1:28



1

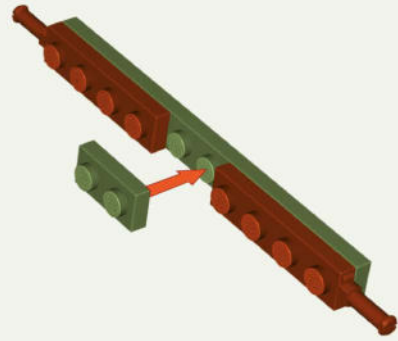

2

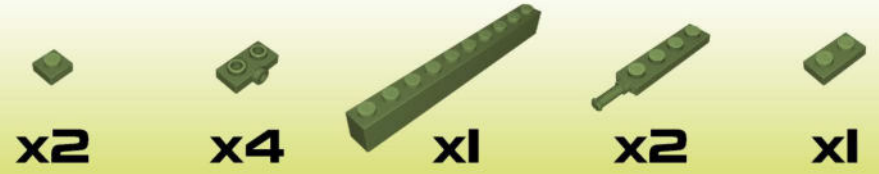
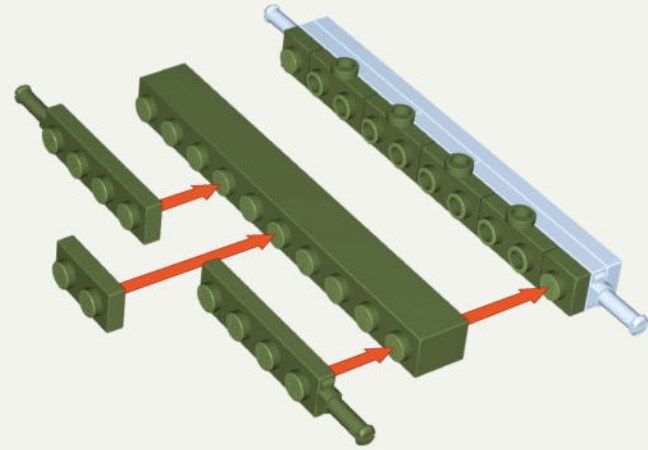

3

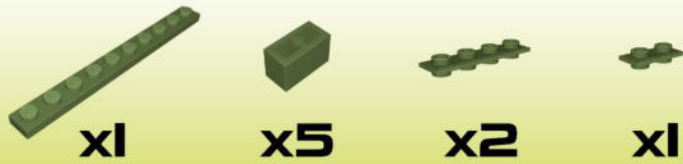
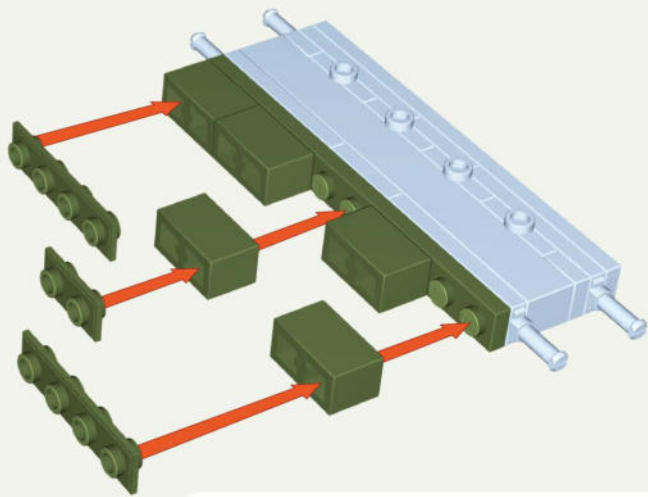

4

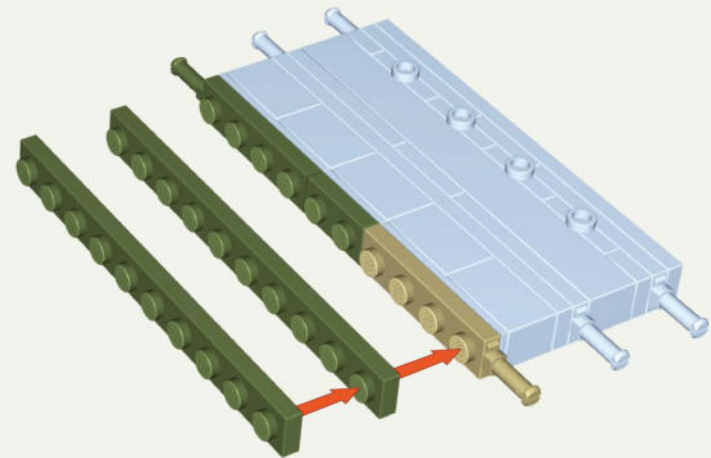

5

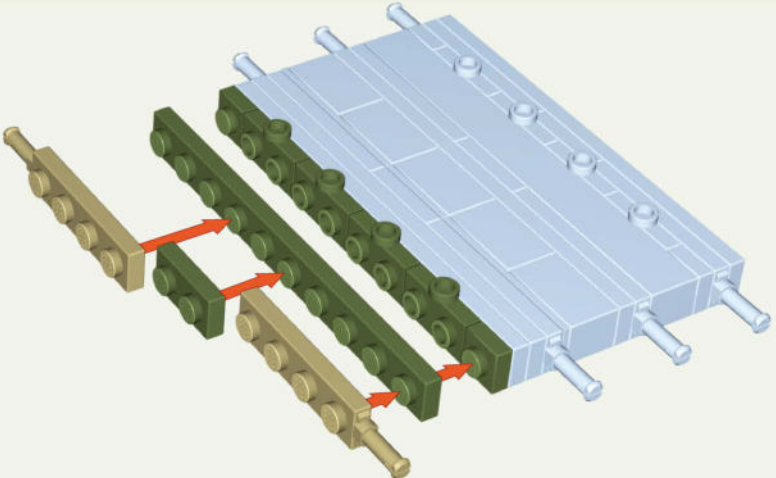

6

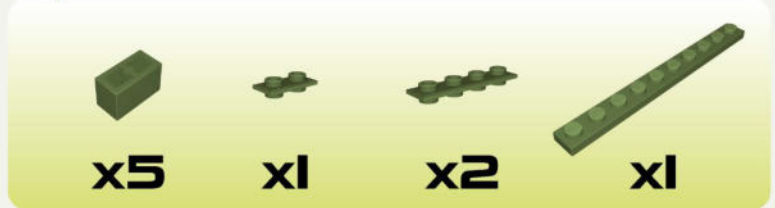
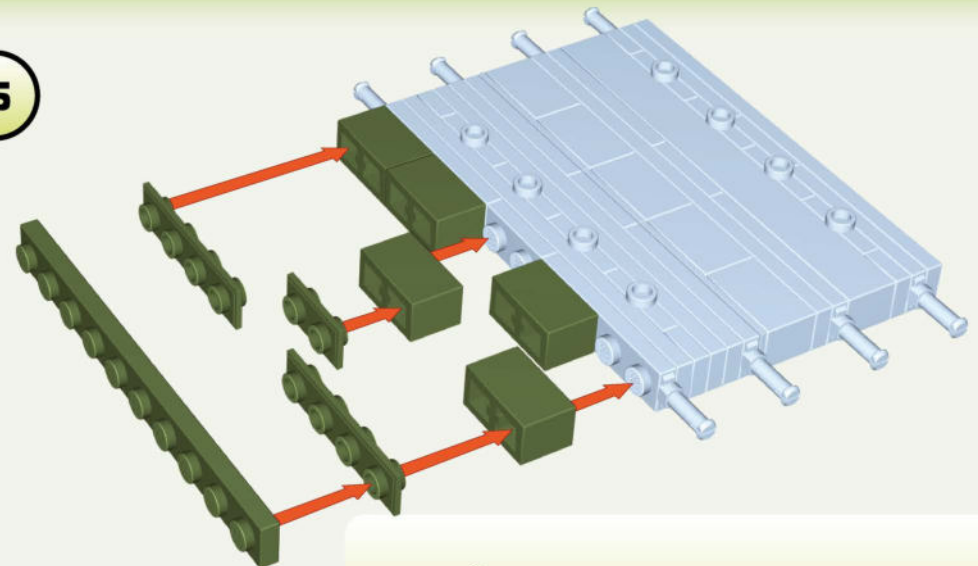

7

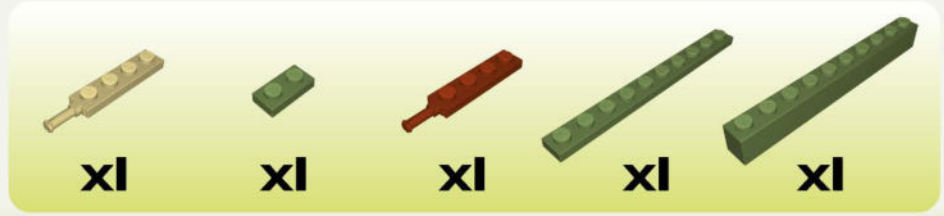
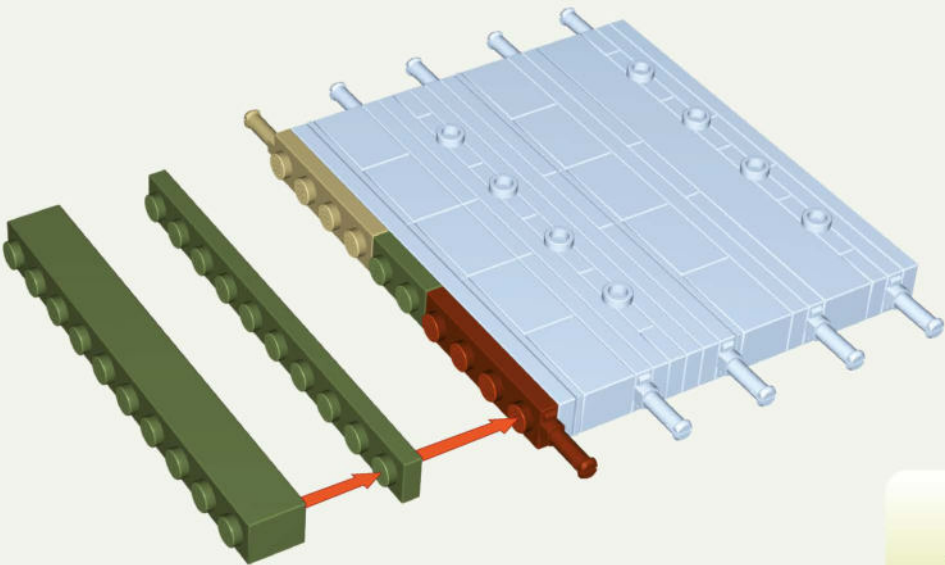



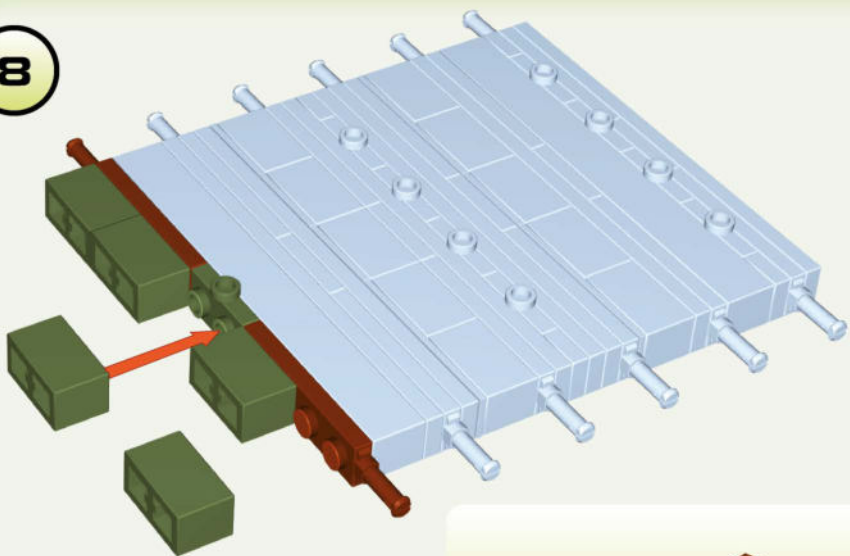



8

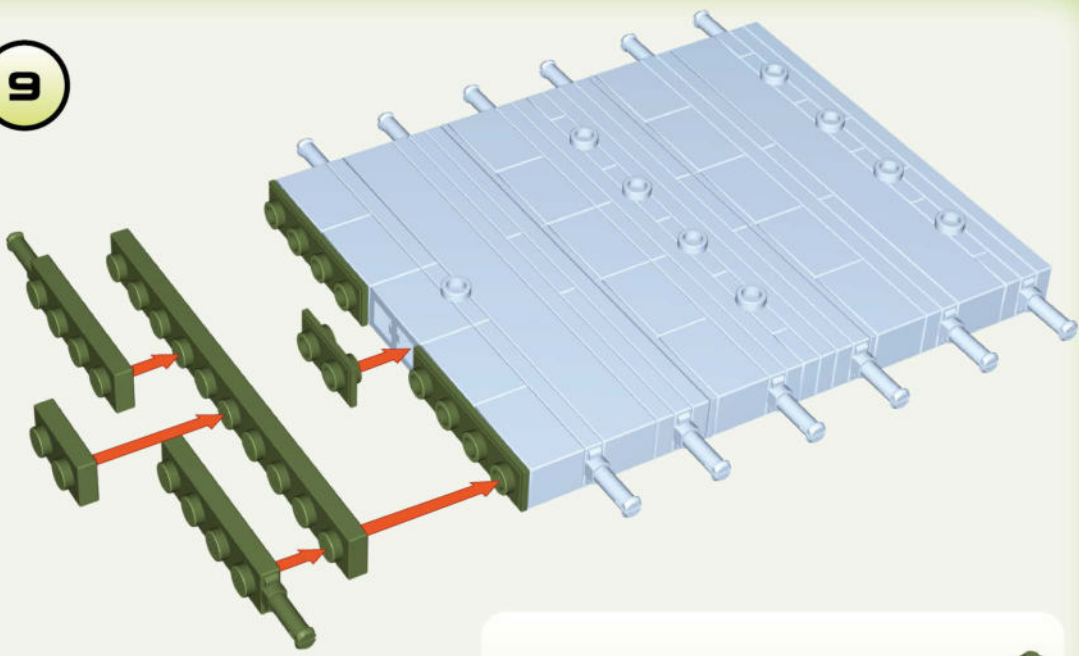

 x1
  x2
  x5





9

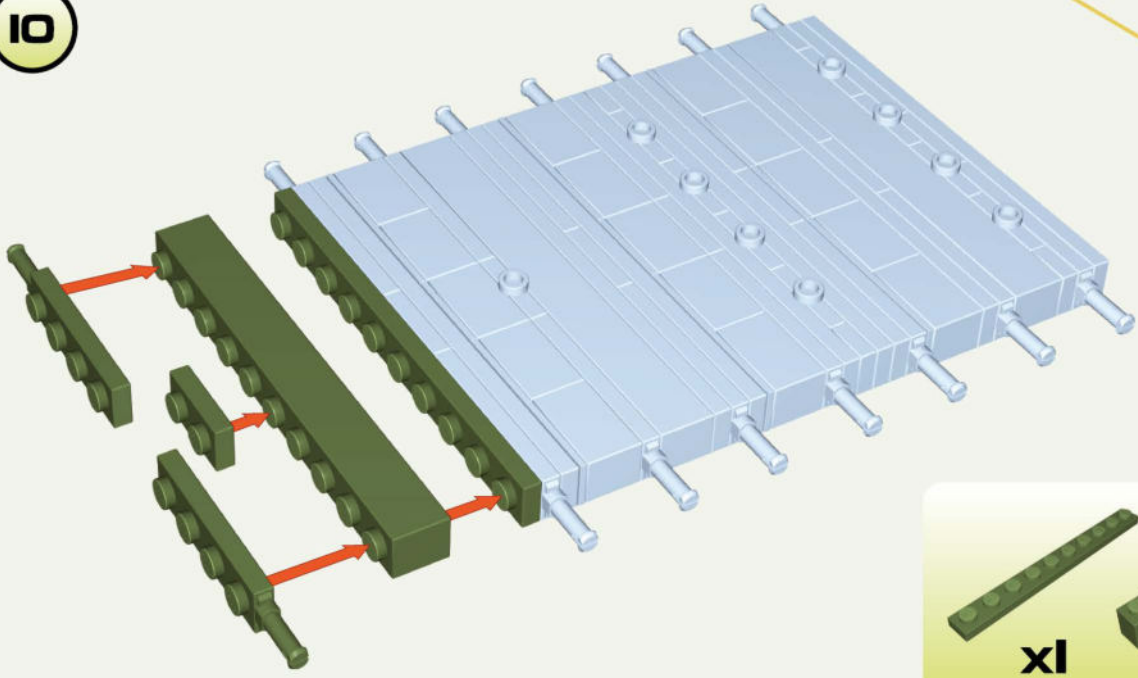

 x2
  x1
  x1
 x2
  x1

10



 x1
  x1
  x1
  x2

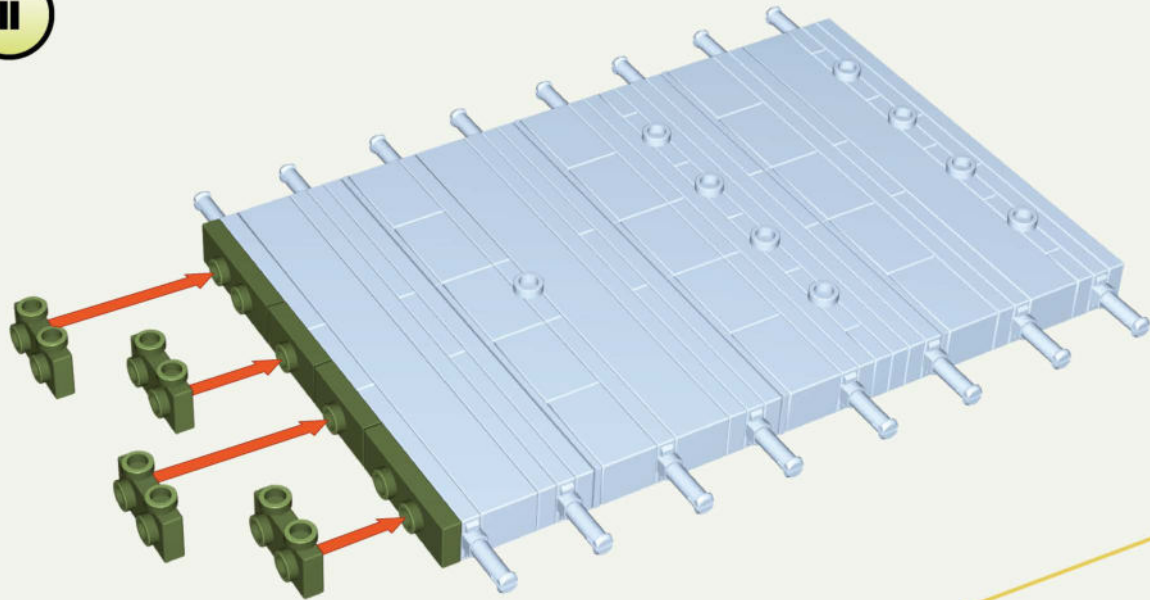

11

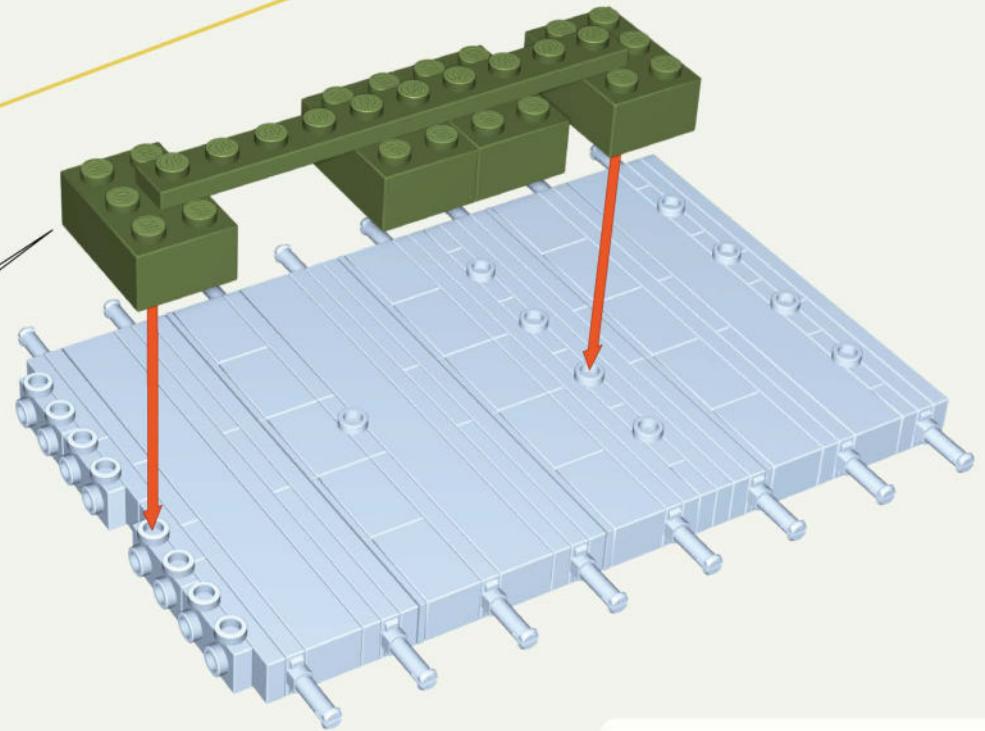
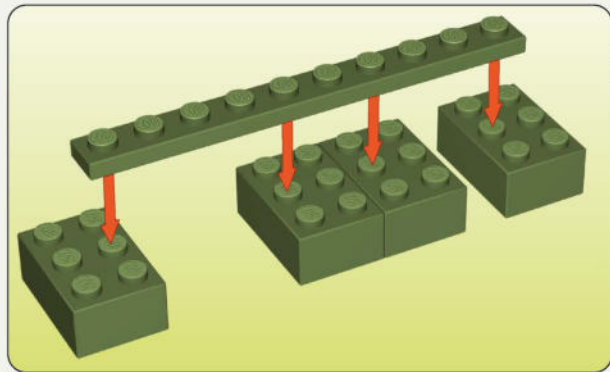

		
x2	x2	x4

12



	
x4	x1

13

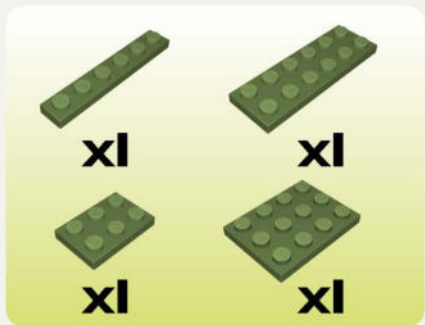
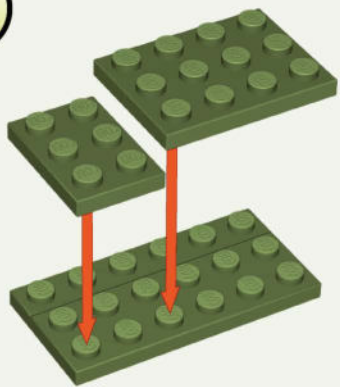

14

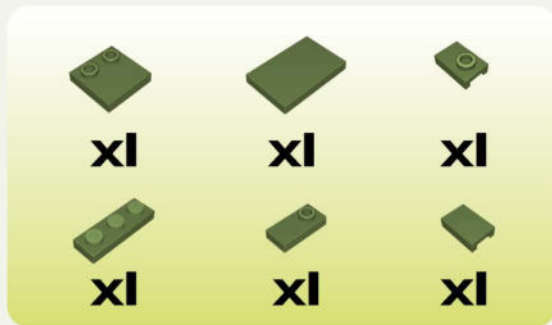
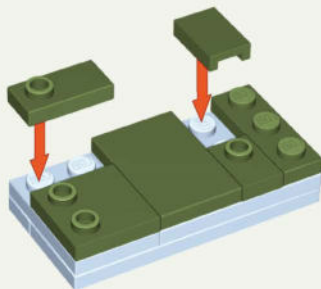

15

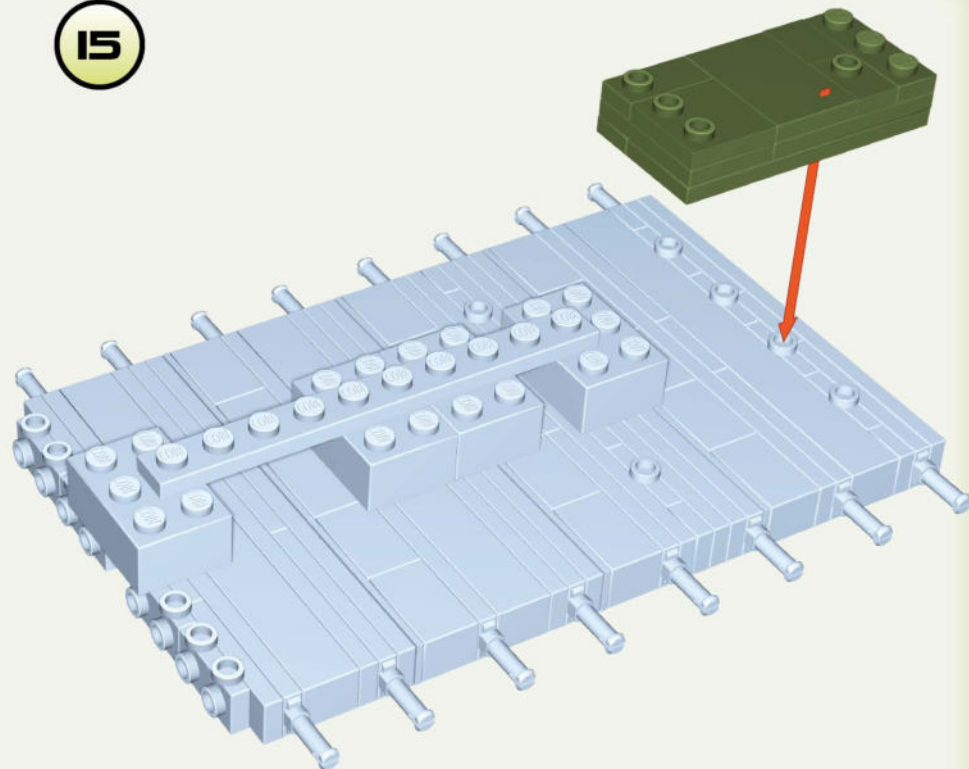

16

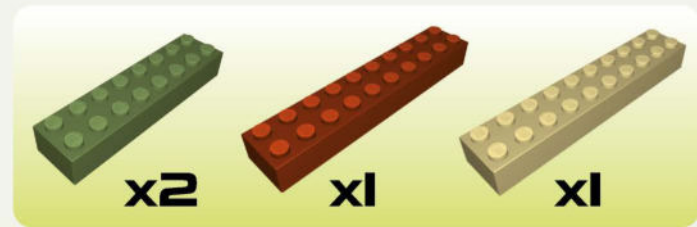
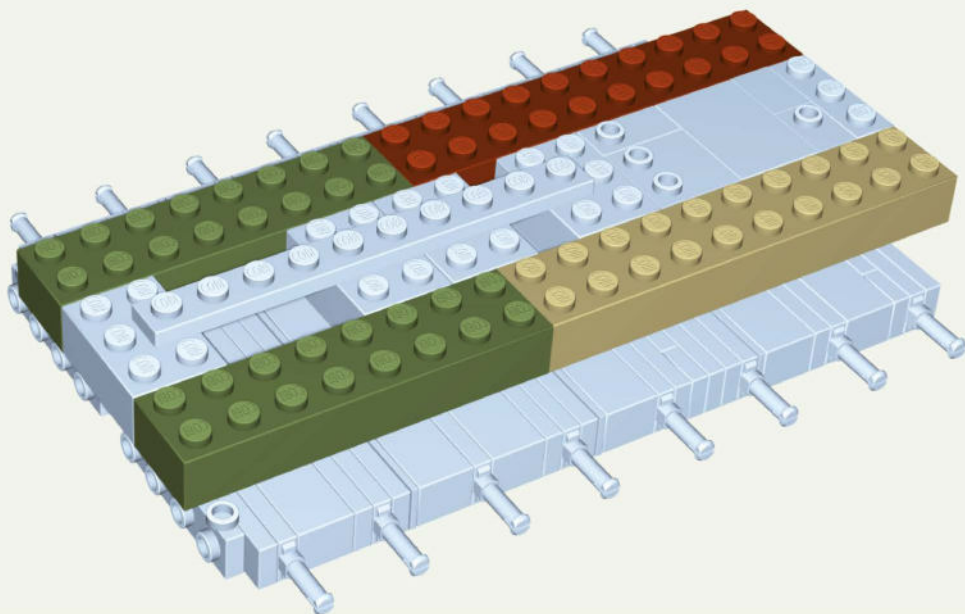

17

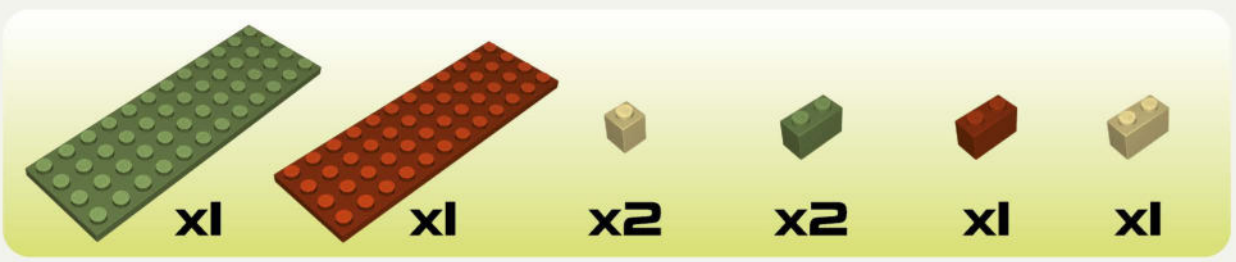
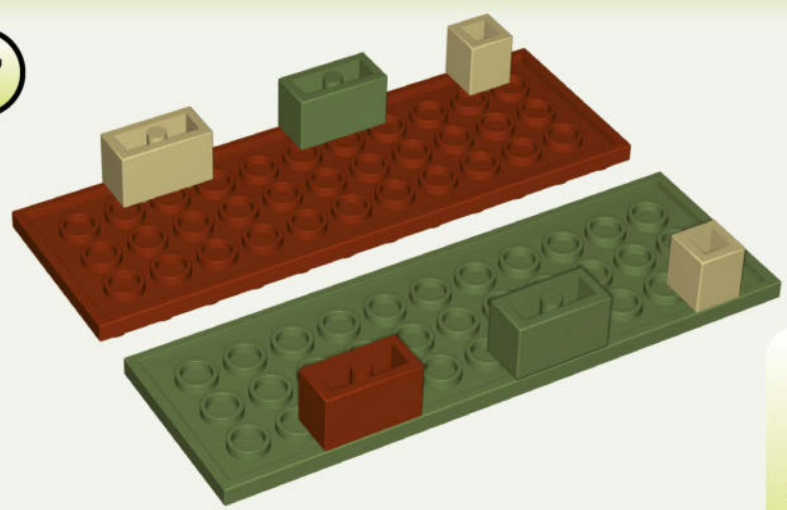

18

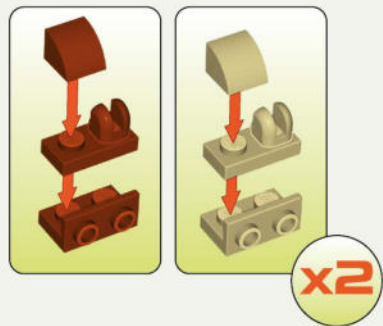
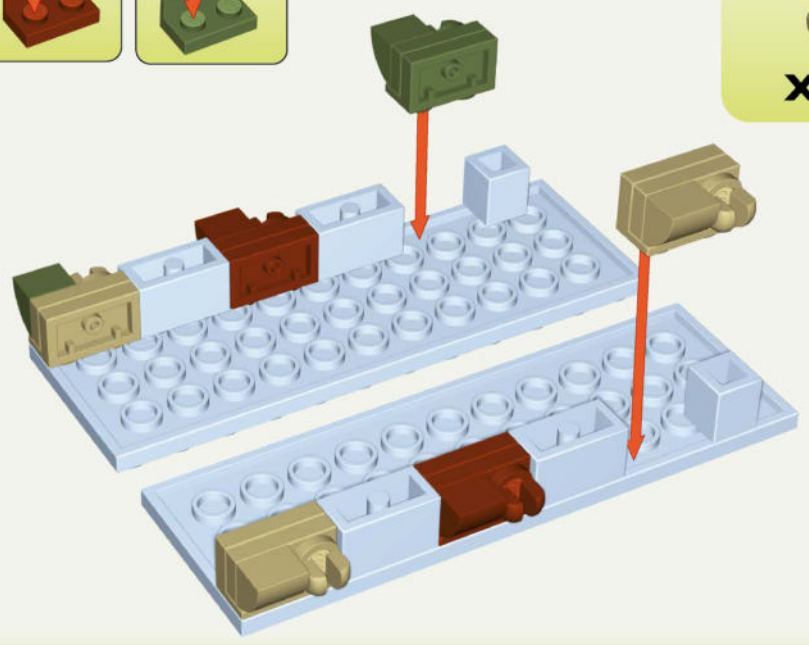
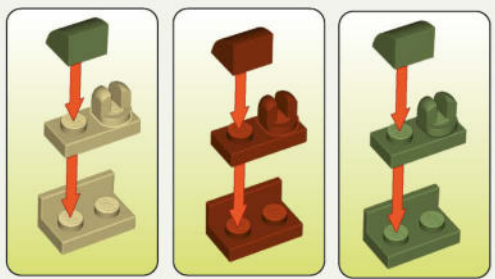

19

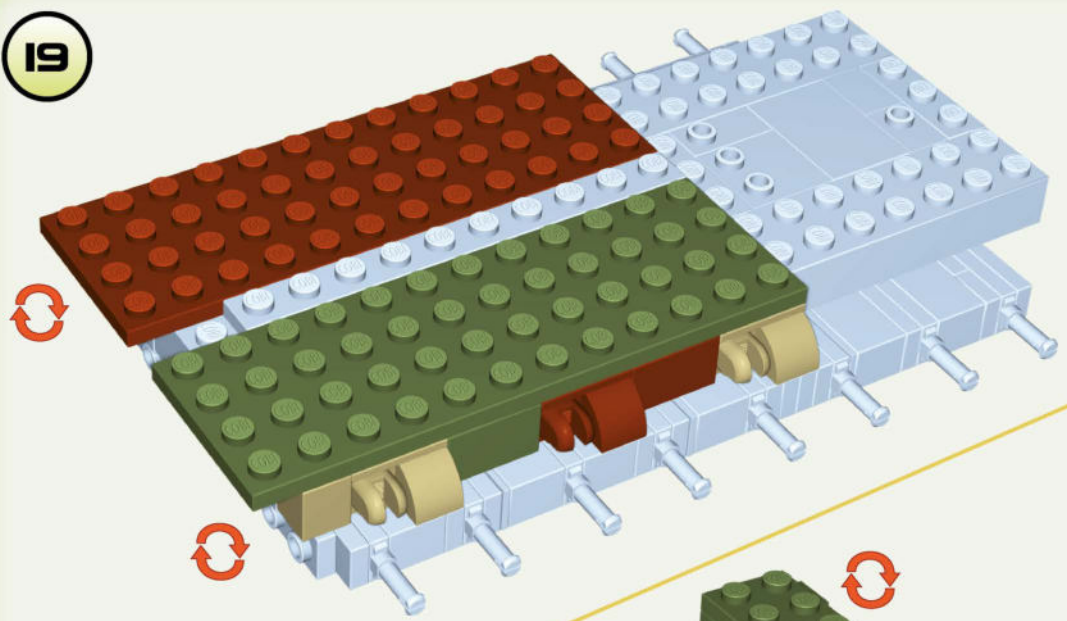

20

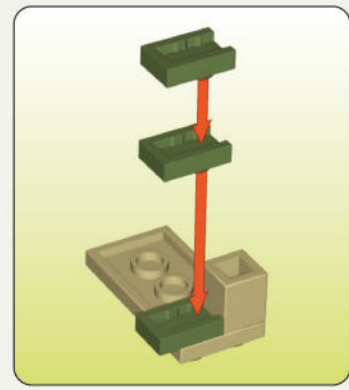
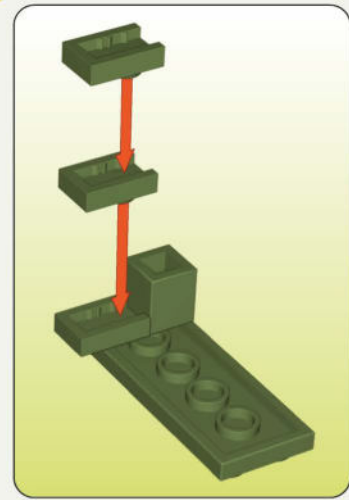
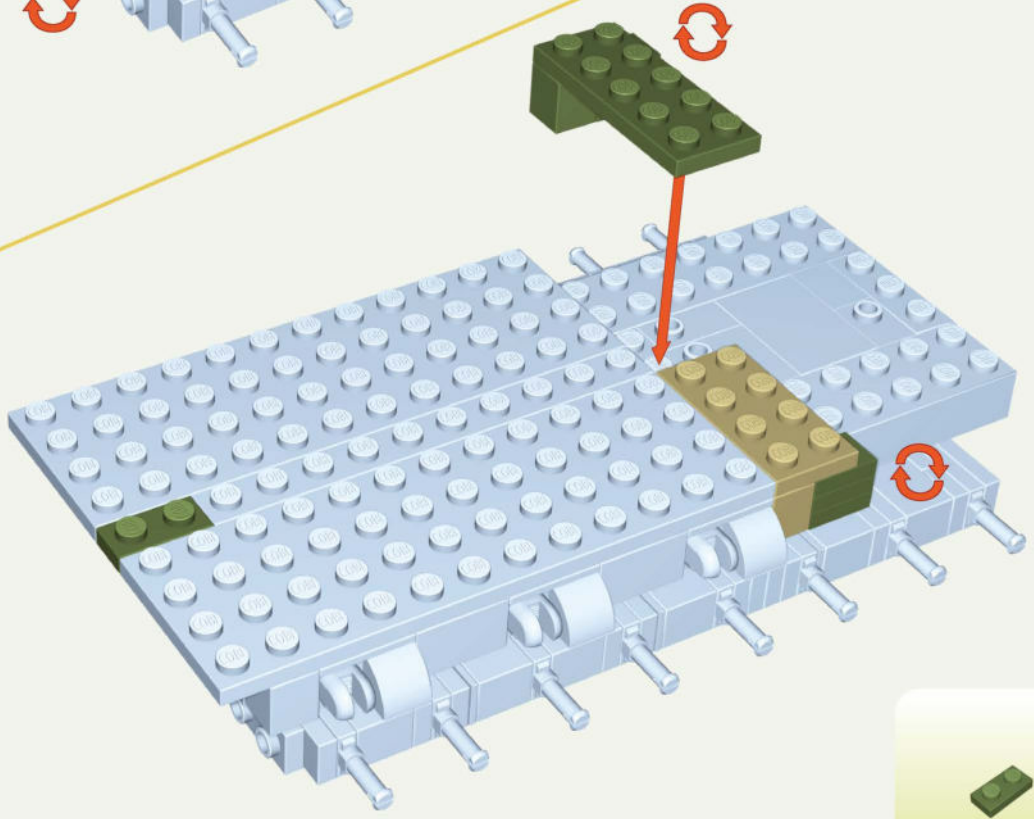

x1



x1



x1



x1







x1

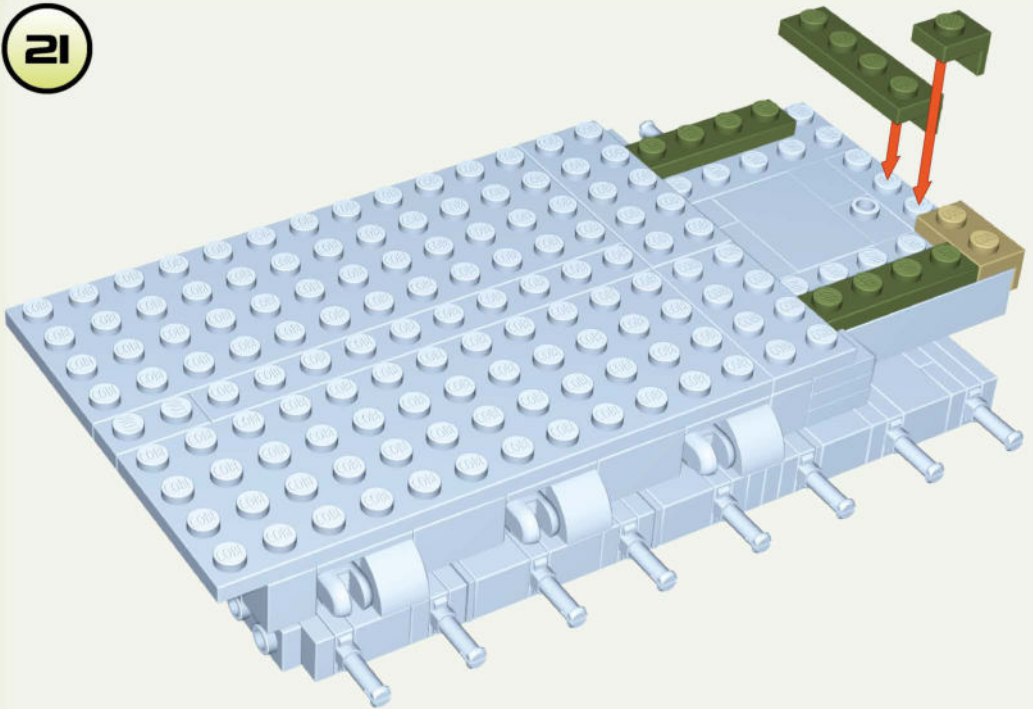

x6



21



- 
x2
- 
x1
- 
x1
- 
x1

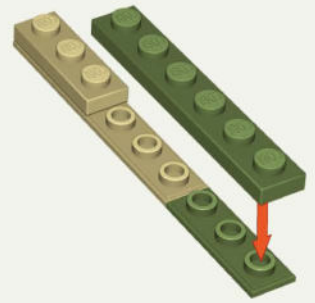

22

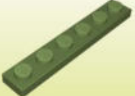

- 
x1
- 
x1
- 
x1
- 
x1

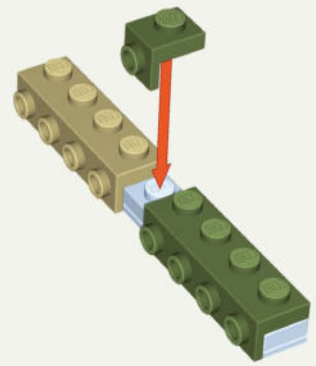

23

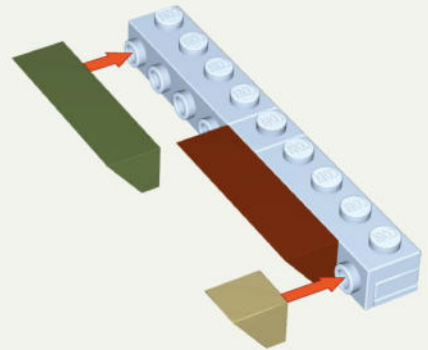

- 
x1
- 
x1
- 
x1

24



- 
x1
- 
x1
- 
x1

25

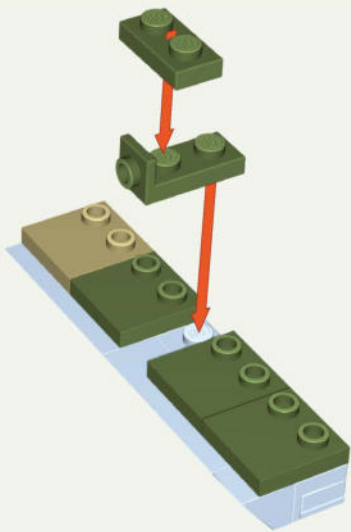

x3



x1



x1



x1

26

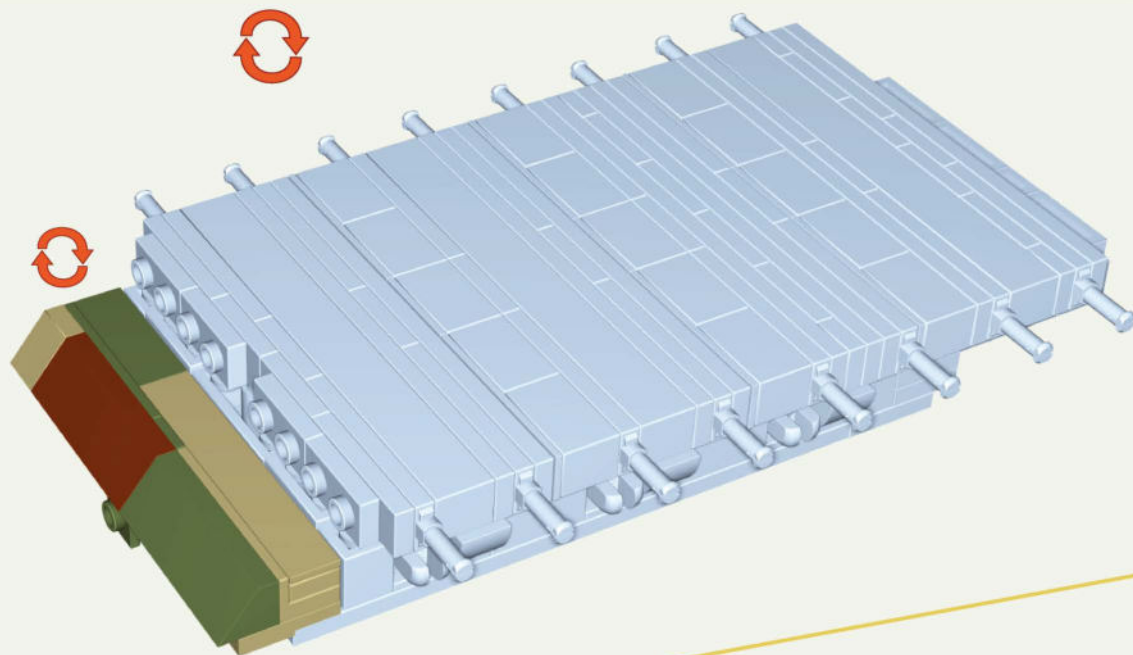

27

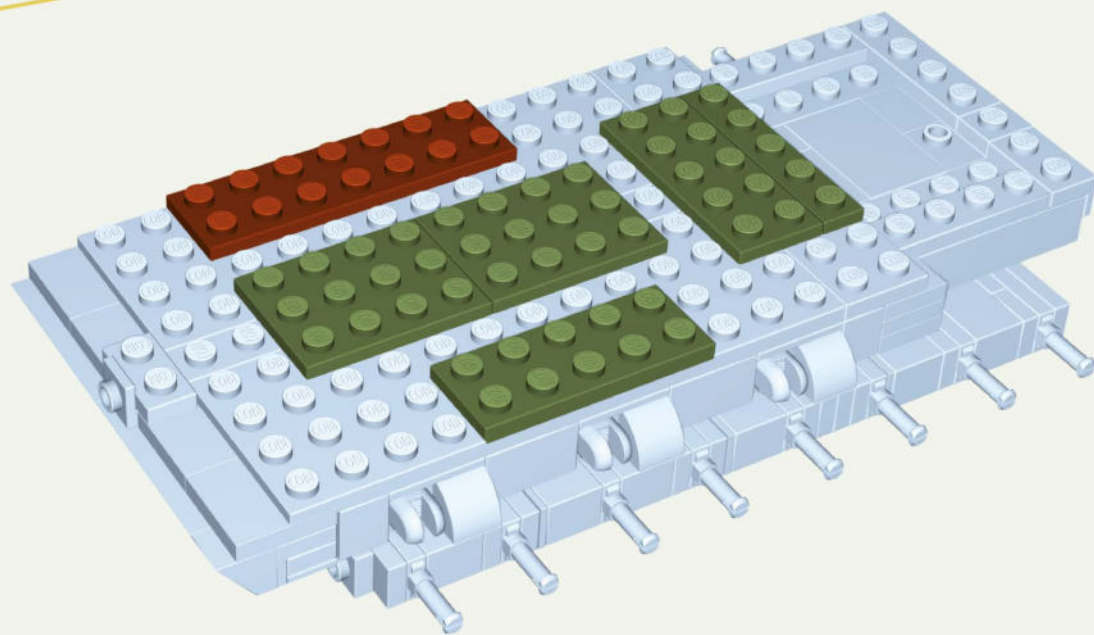

x2



x2



x1



x1

28

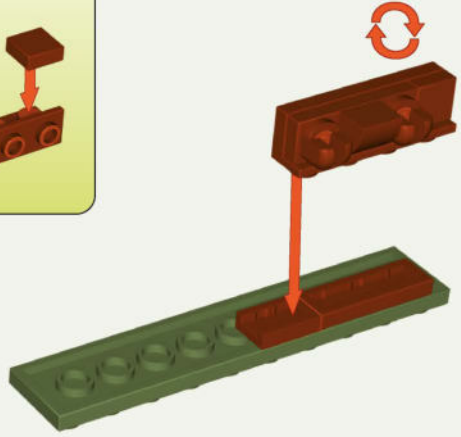
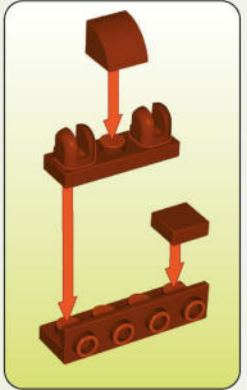

- | | | | |
|--|----|--|----|
| | x1 | | x1 |
| | x1 | | x1 |
| | x1 | | x1 |
| | x2 | | x1 |

29

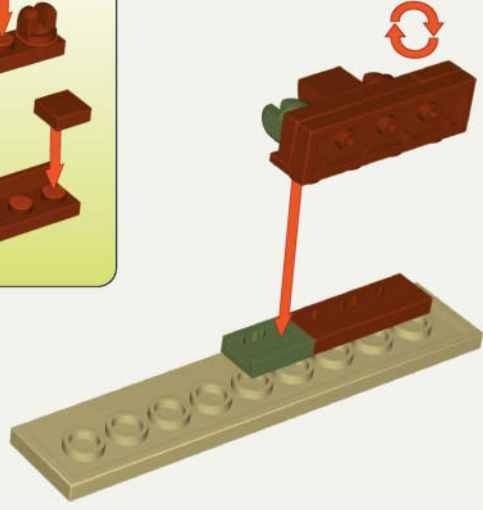
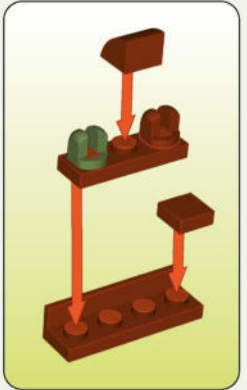

- | | | | |
|--|----|--|----|
| | x1 | | x1 |
| | x1 | | x1 |
| | x1 | | x1 |
| | x1 | | x1 |
| | | | x1 |

30

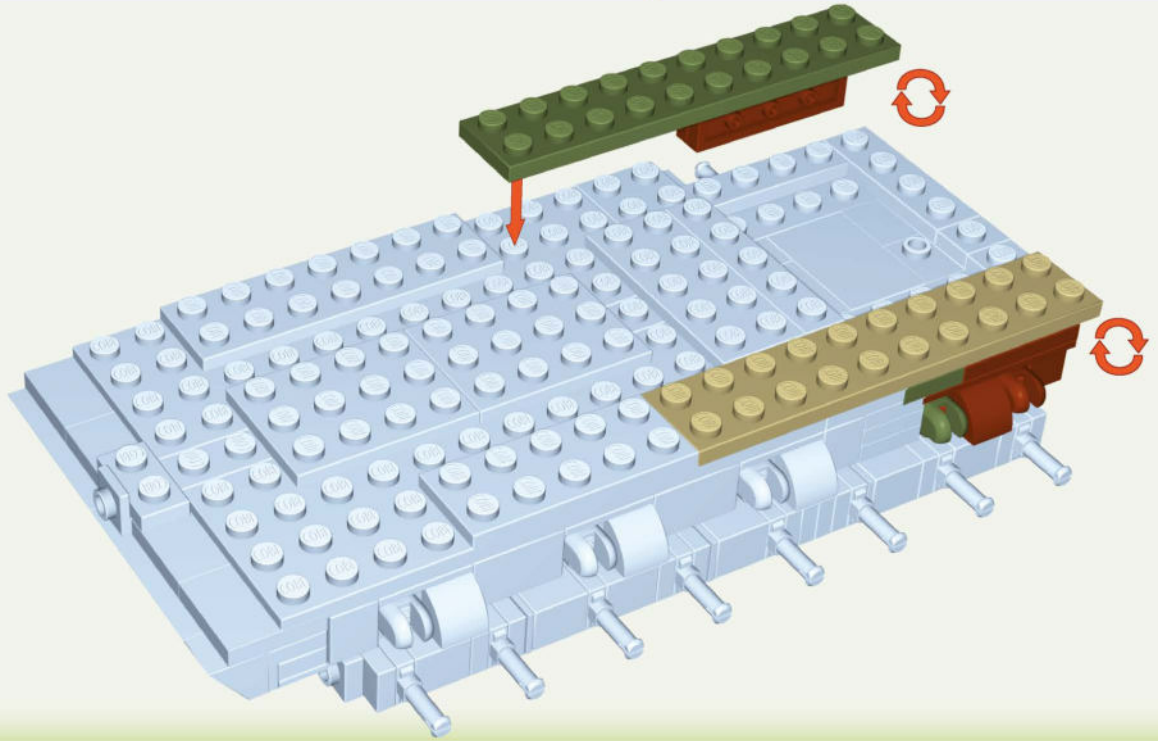

31

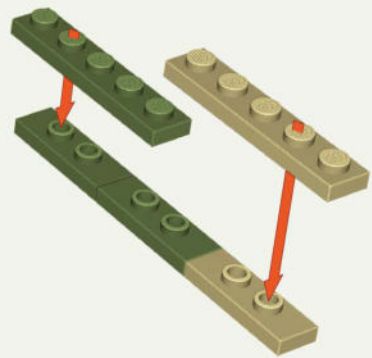

x2



x1



x1



x1

32

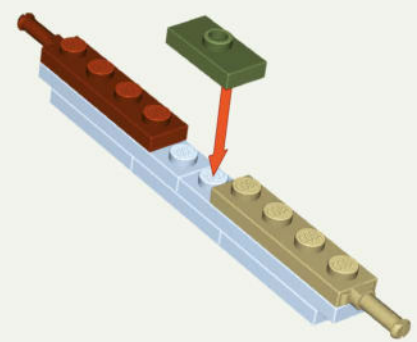

x1



x1



x1

33

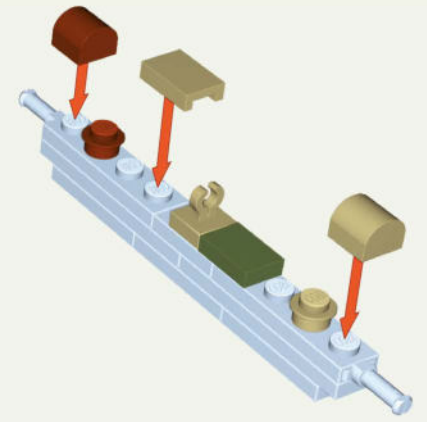

x1



x1



x1



x1



x1



x1



x1

34

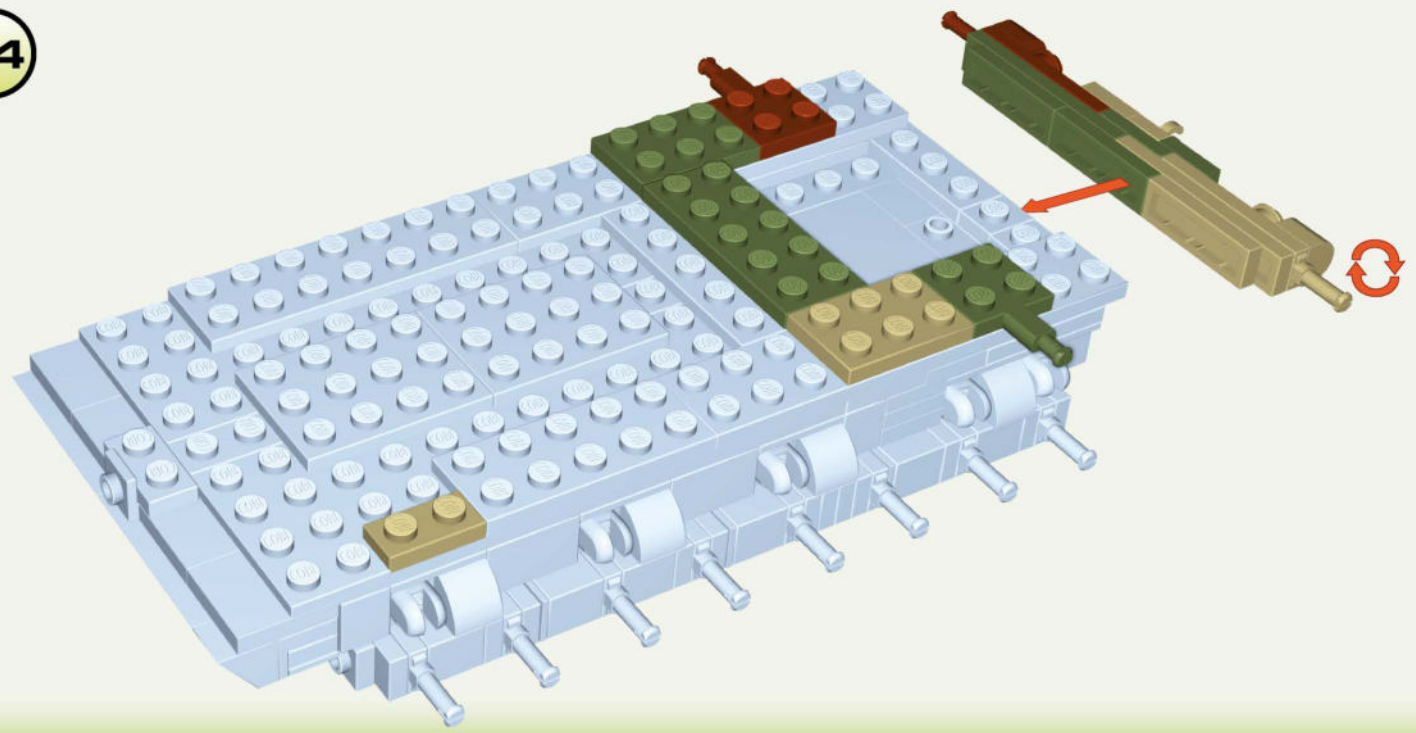

x1



x1



x1



x1









x1

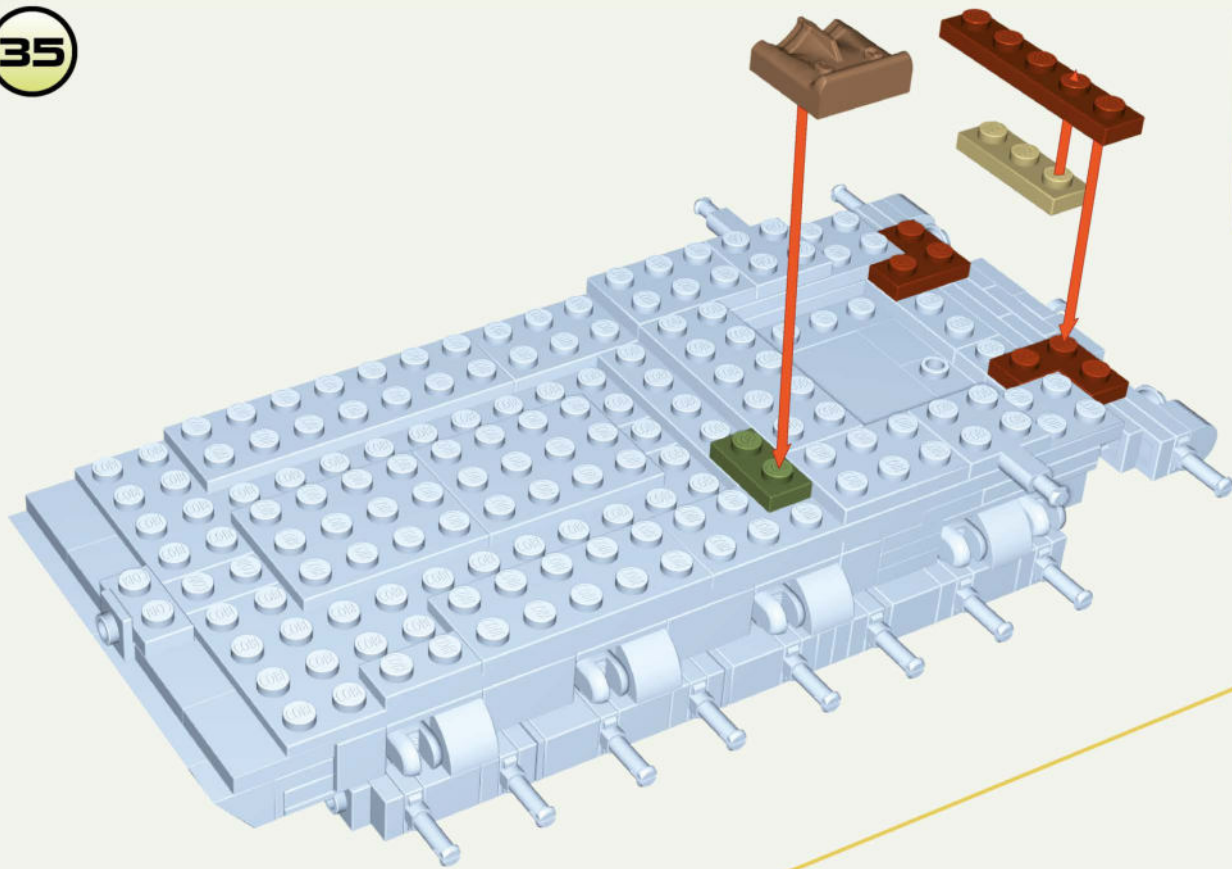





x1

35



				
x2	x1	x1	x1	x1



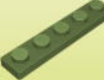

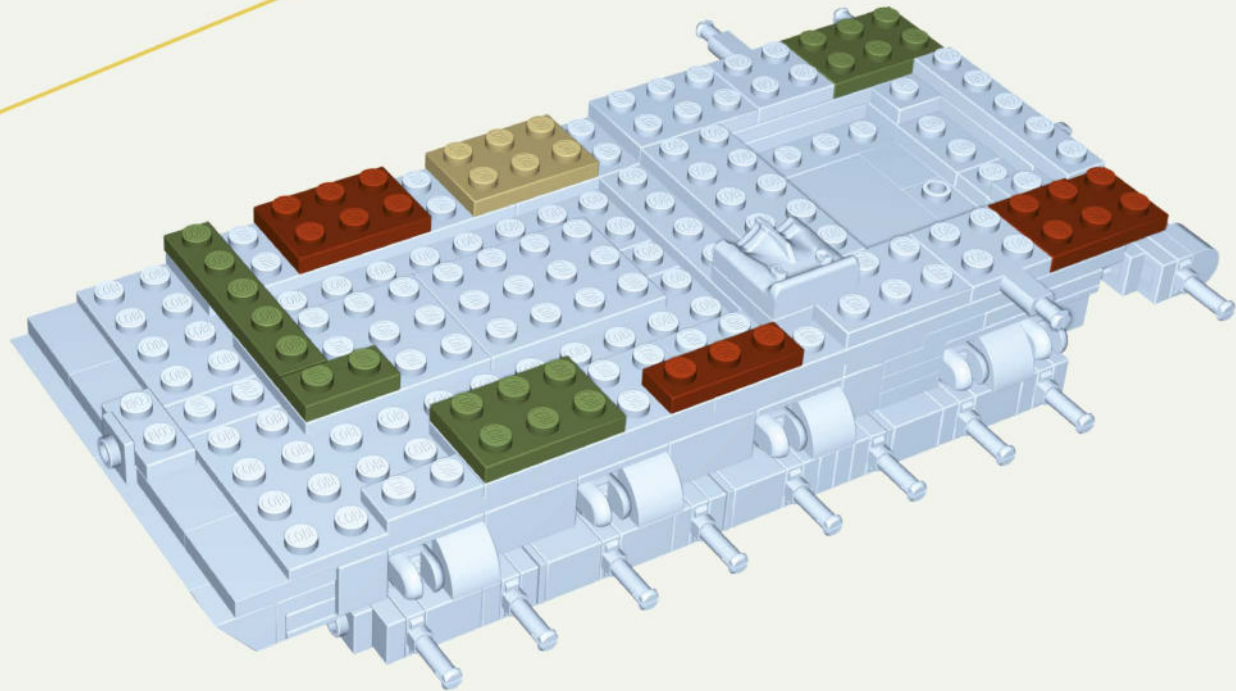

36

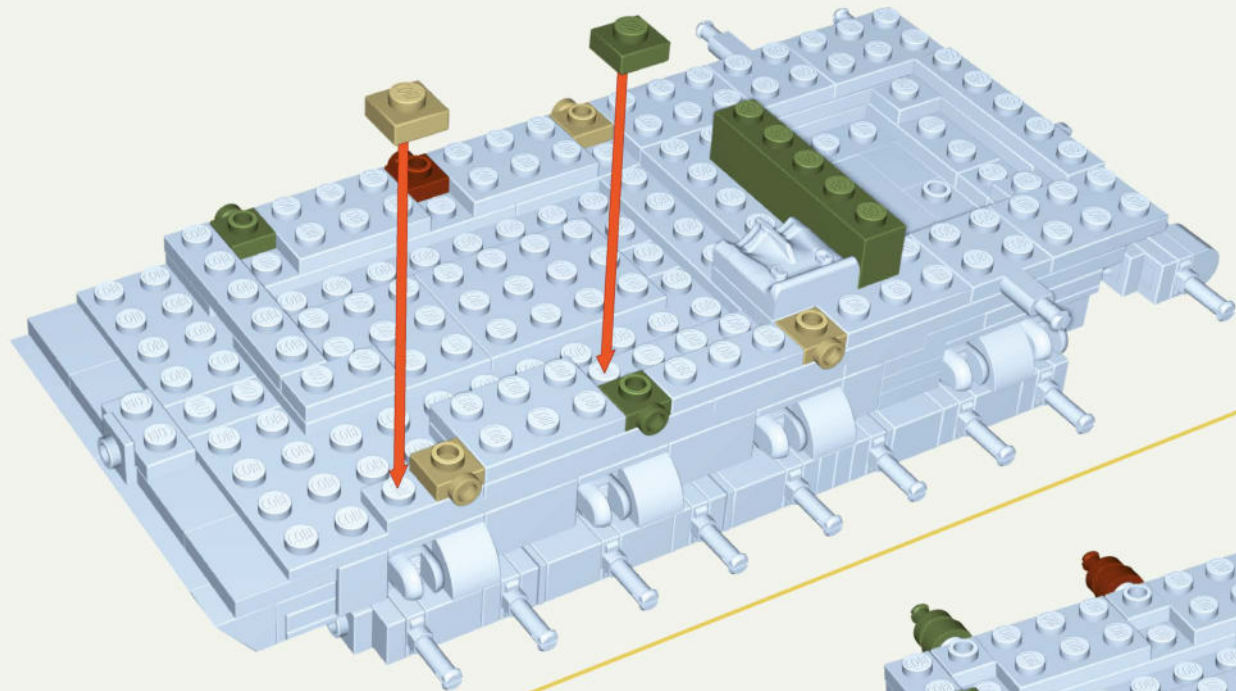
		
x2	x1	x2
		
x1	x1	x1









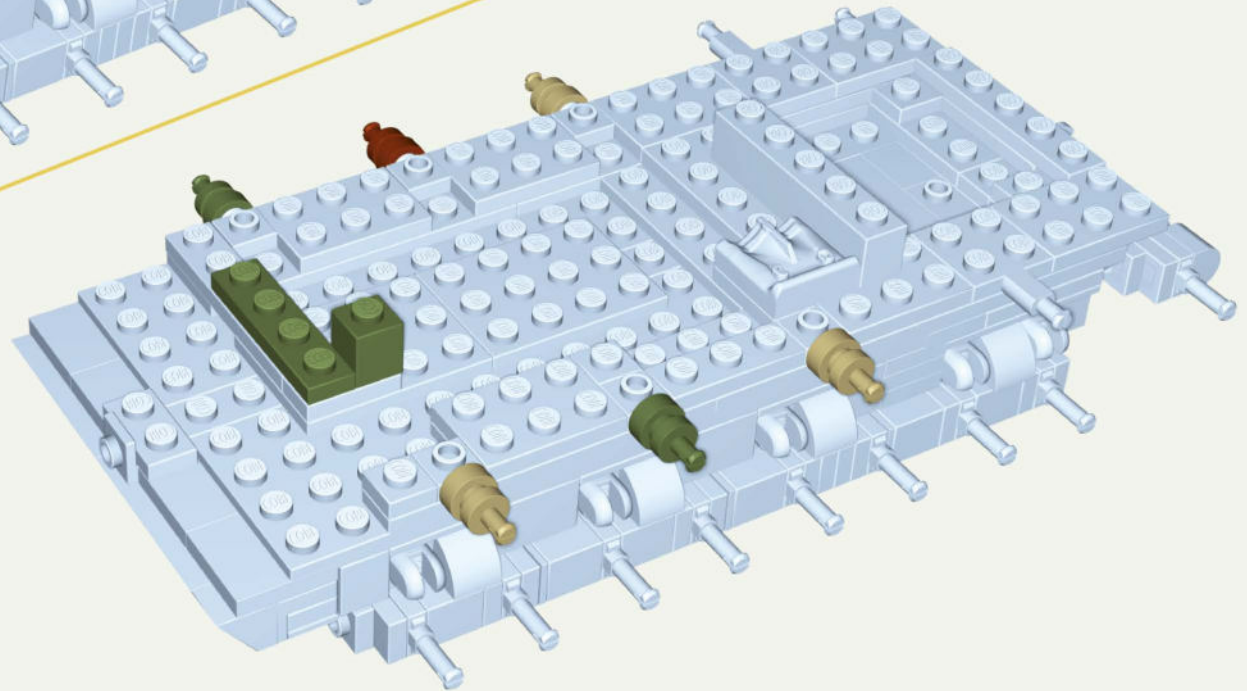

37





-  x3
-  x2
-  x1
-  x1
-  x1
-  x1

38





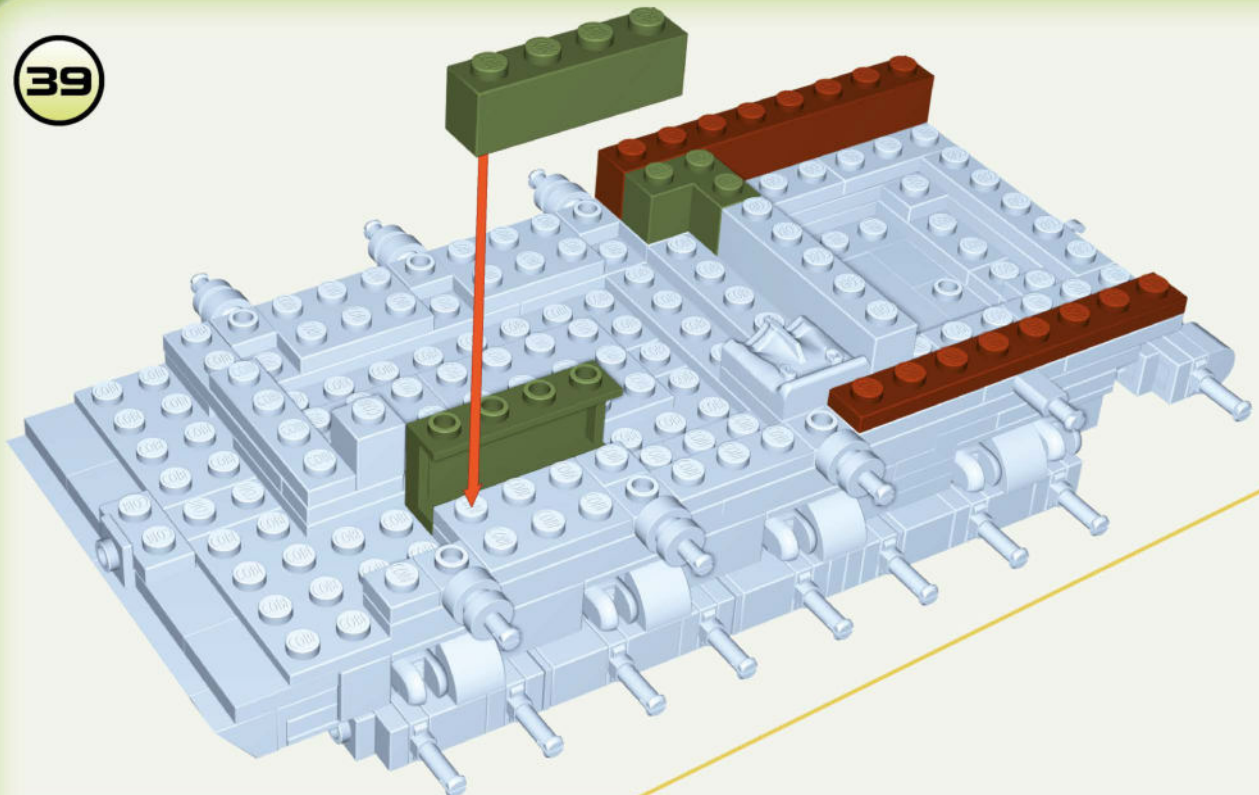

-  x1
-  x1
-  x2
-  x2
-  x3
-  x3
-  x1
-  x1

-  x2
-  x3
- 

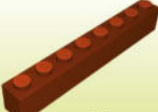





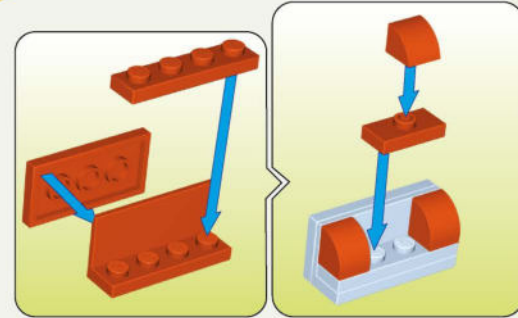

39



- 
x1
- 
x1
- 
x1
- 
x1
- 
x1



40

- 
x1
- 
x1
- 
x1
- 
x1
- 
x2
- 
x1
- 
x1
- 
x1
- 
x1

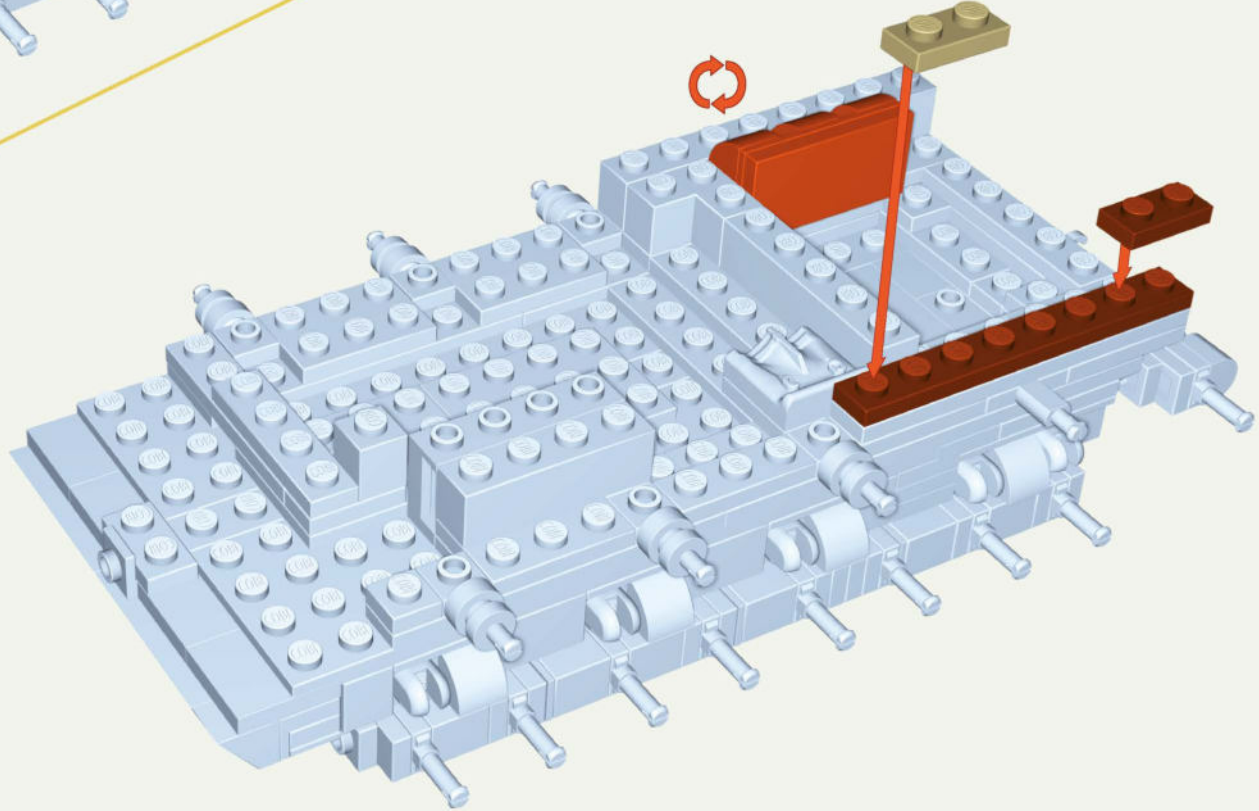



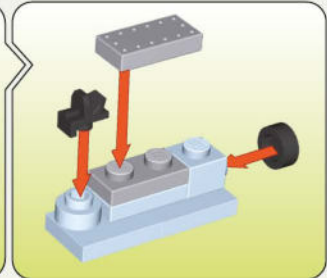
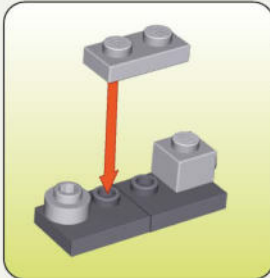
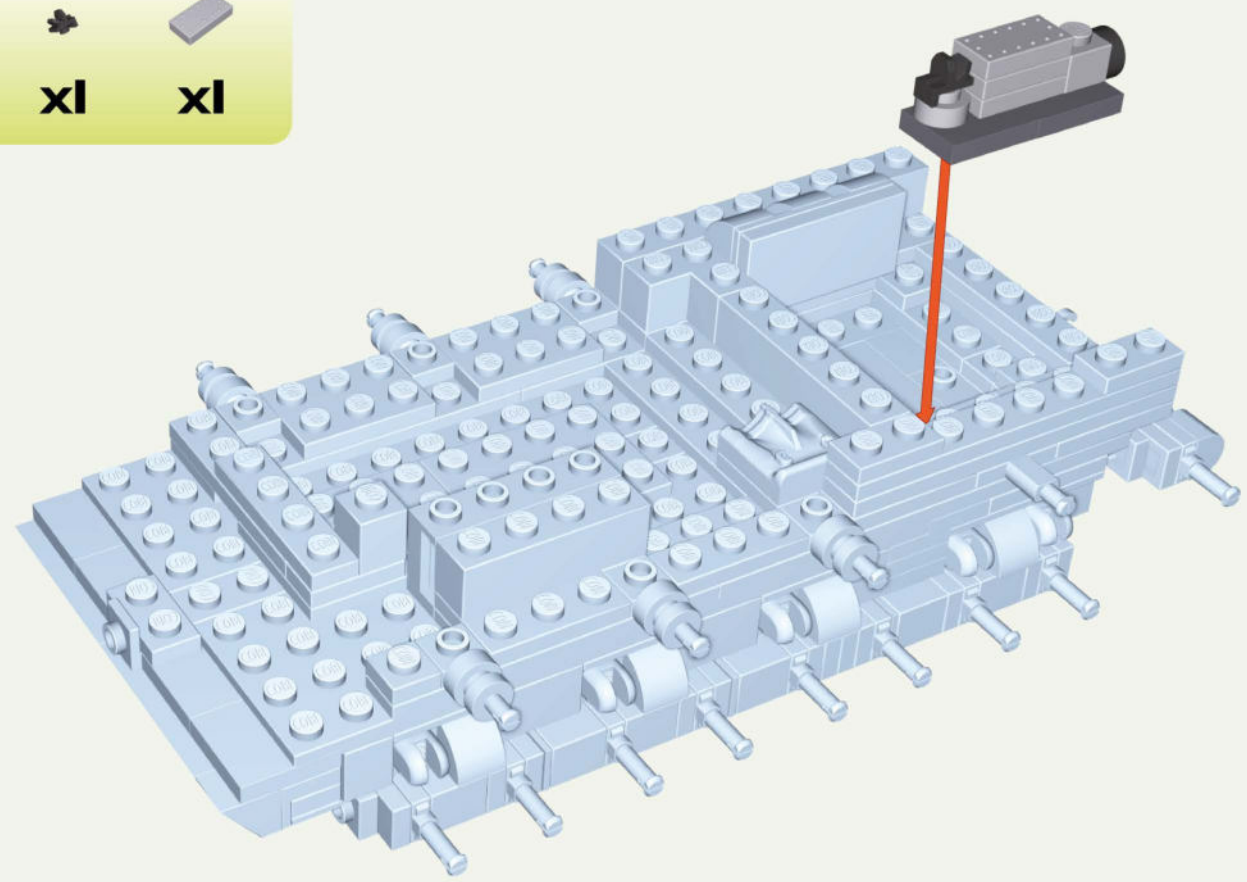
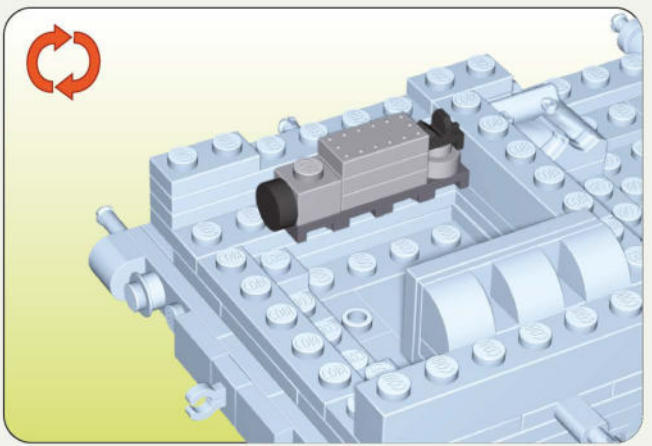

41

- 
x2
- 
x1
- 
x1
- 
x2
- 
x1
- 
x1
- 
x1

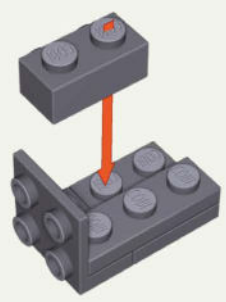





42

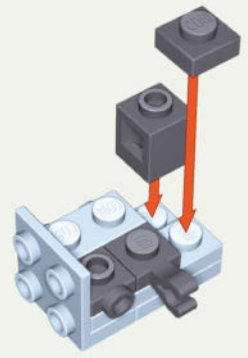

- 
x1
 - 
x1
- 
x1
 - 
x1

43



- 
x1
 - 
x1
- 
x1
 - 
x1



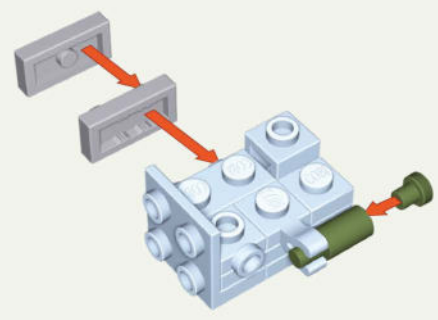

44

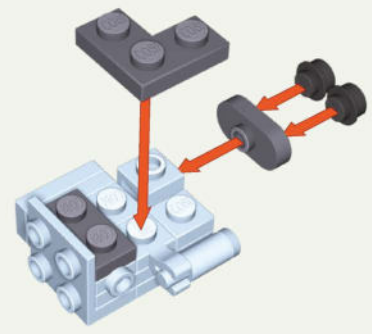

	
x1	x1
	
x1	x1



45



	
x1	x1
	
x1	x2

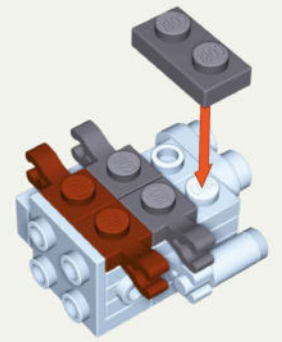

46

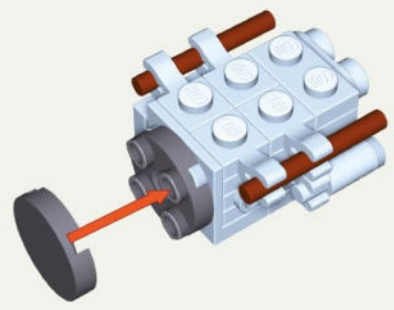

	
x2	x2
	
	x1

47



	
x2	x1
	
	x1



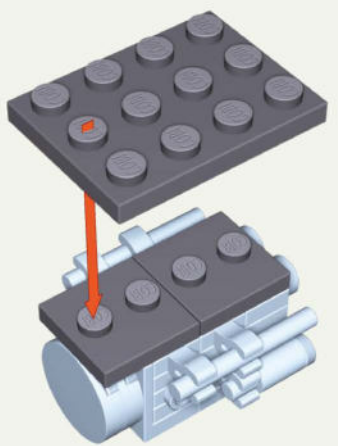

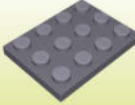
48

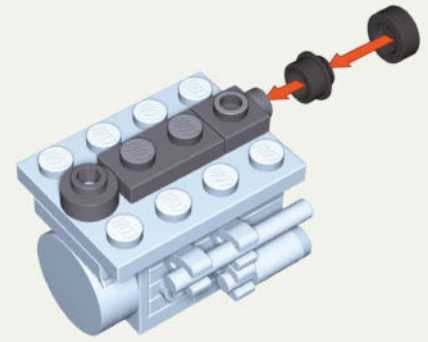

	
x2	x1

49



		
x1	x1	x1
		
x1	x1	

50

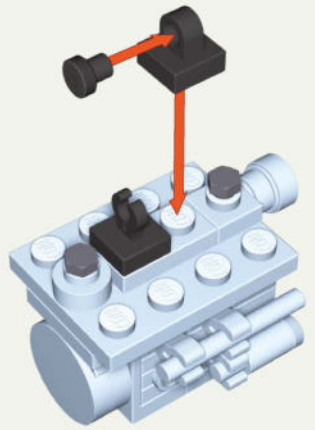

- x1
- x1
- x2
- x1

51

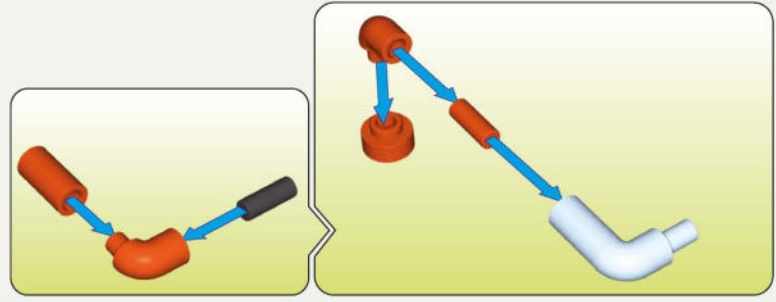
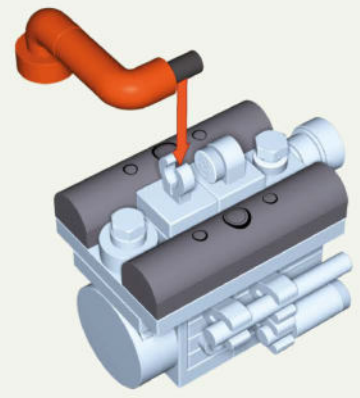

- x2
- x2
- x1
- x1
- x1
- x1

52

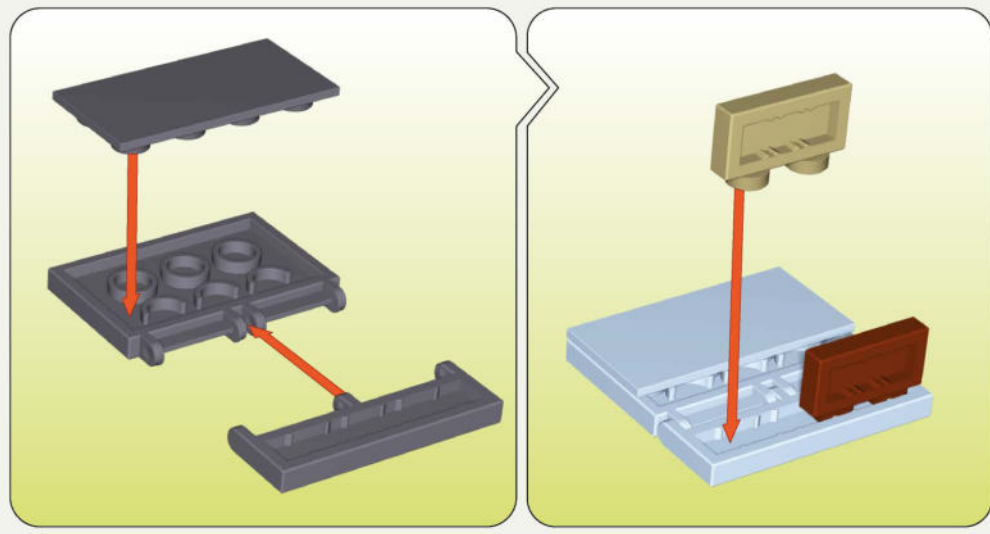

- x1
- x1
- x1
- x1
- x1

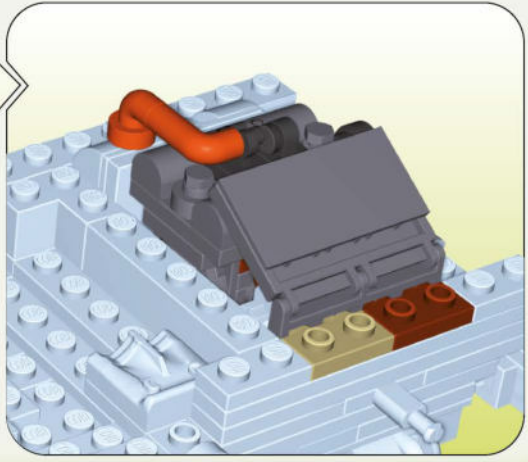
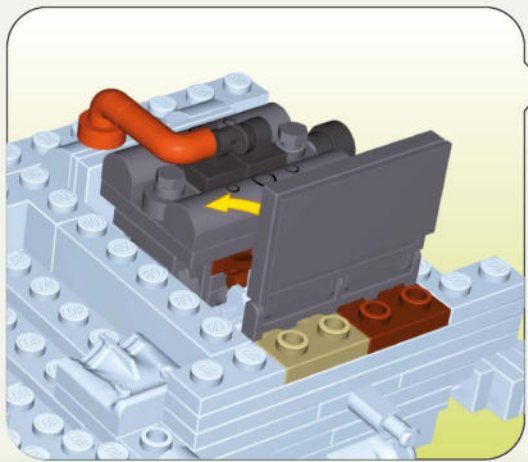
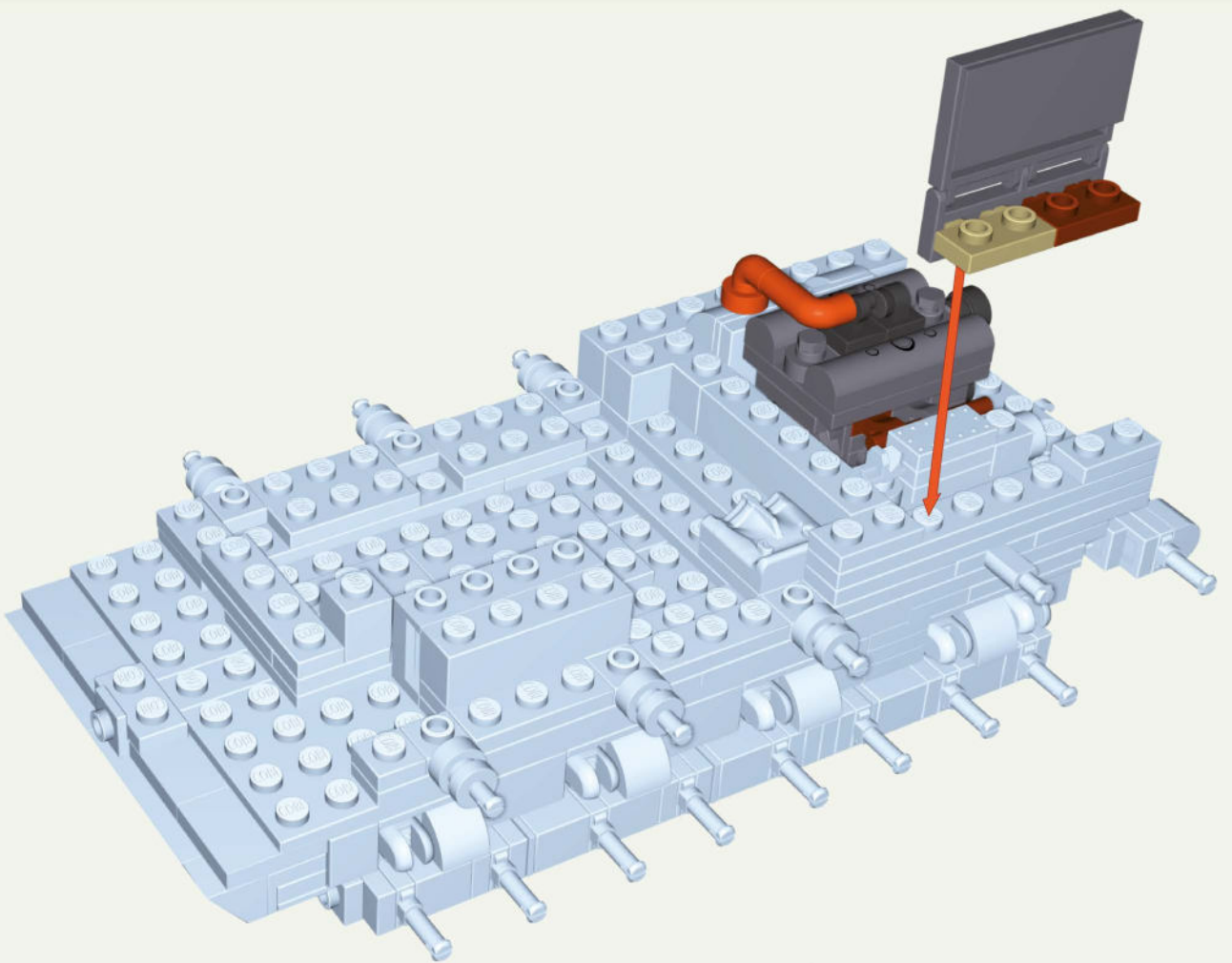
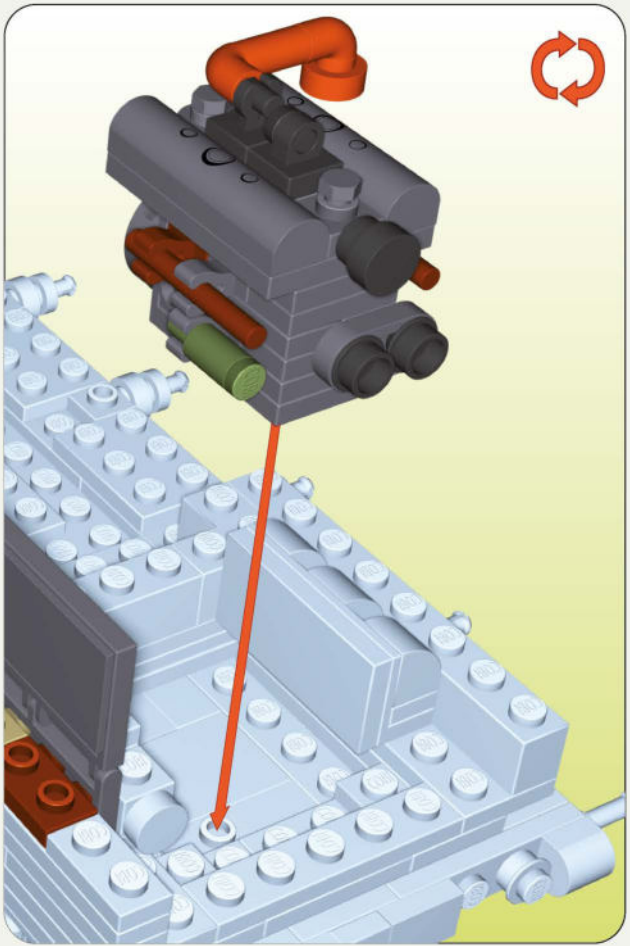



54

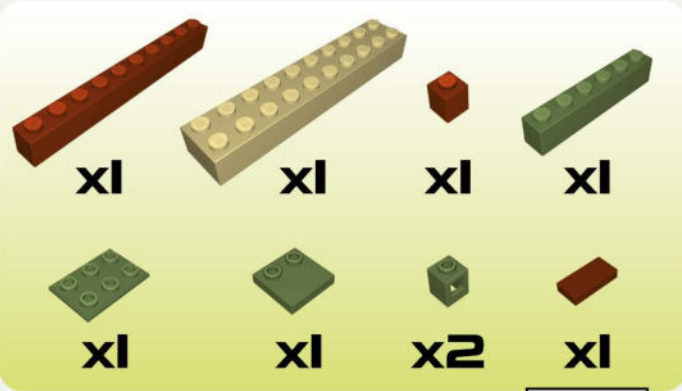
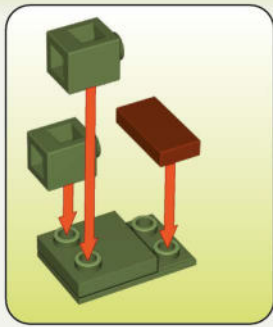

1:1

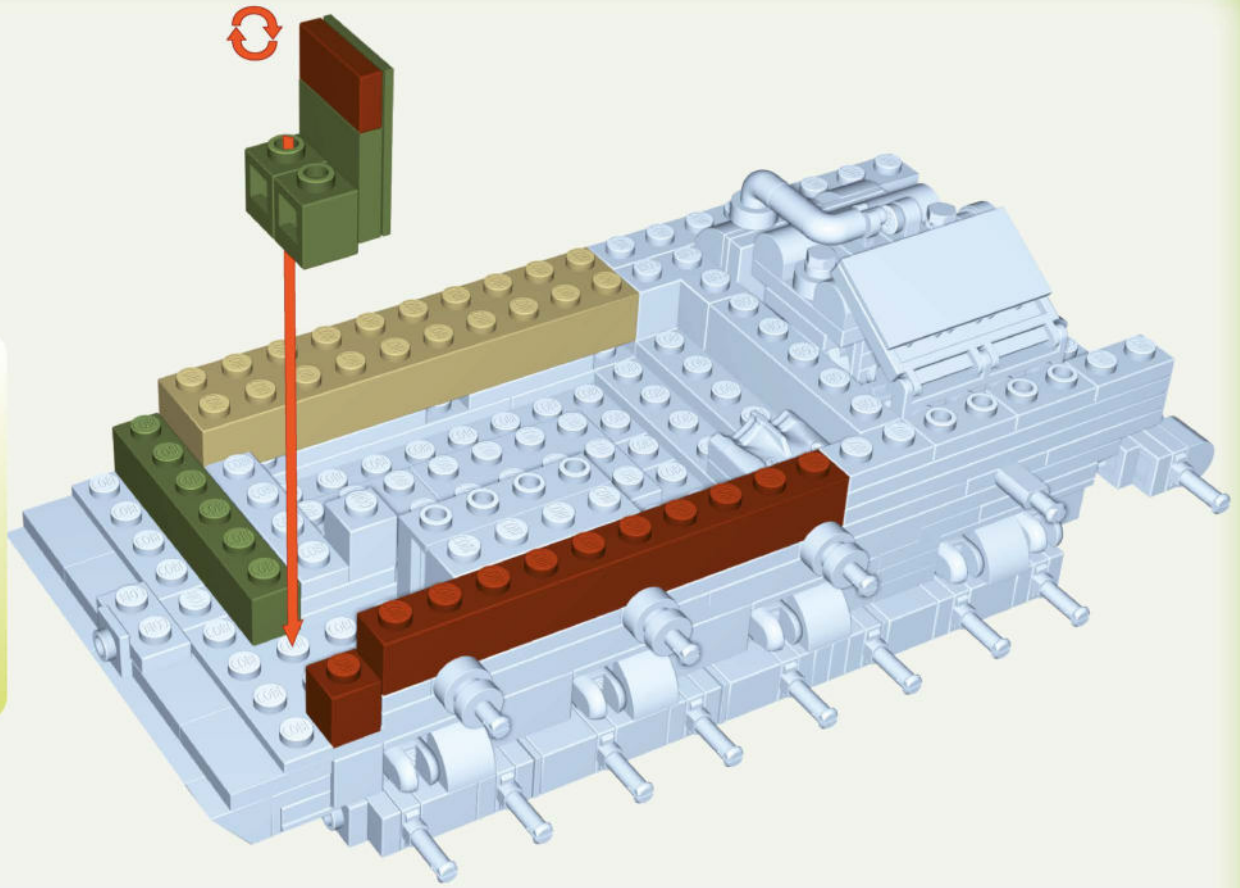



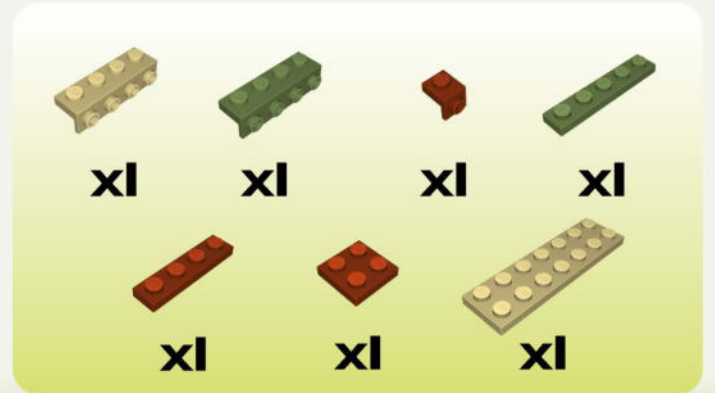
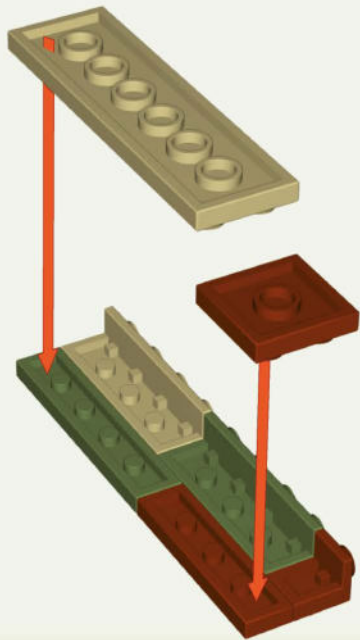



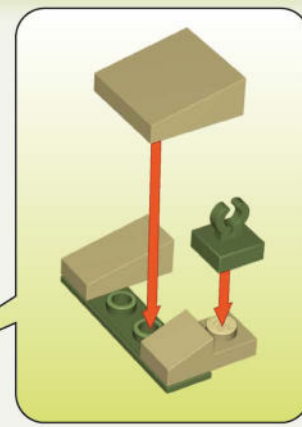
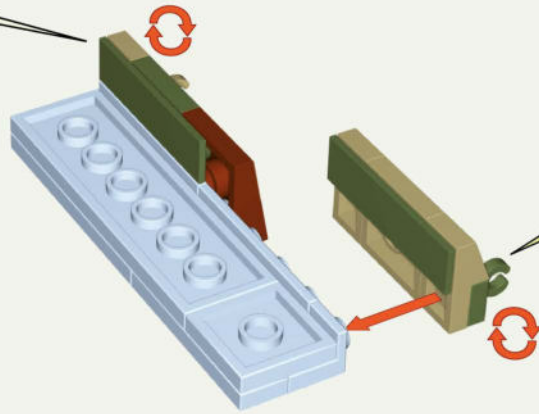
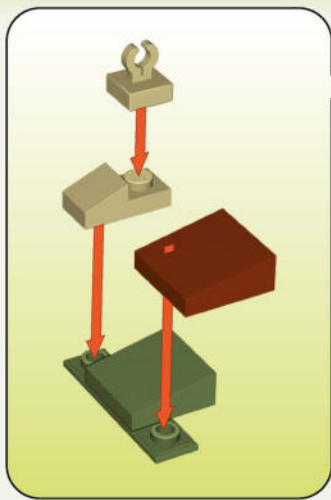

55







56

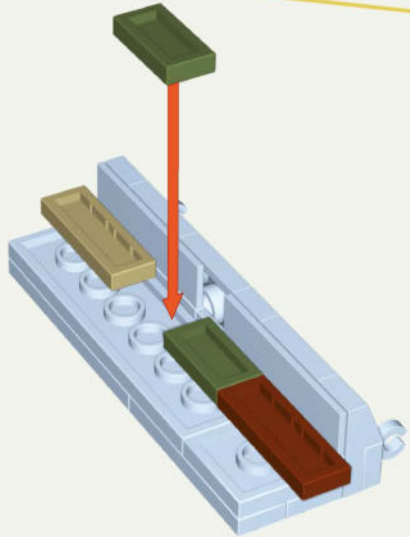

- | | | | |
|---|---|---|---|
|  |  |  |  |
| x2 | x1 | x2 | x1 |
|  |  |  |  |
| x1 | x1 | x1 | x1 |





57

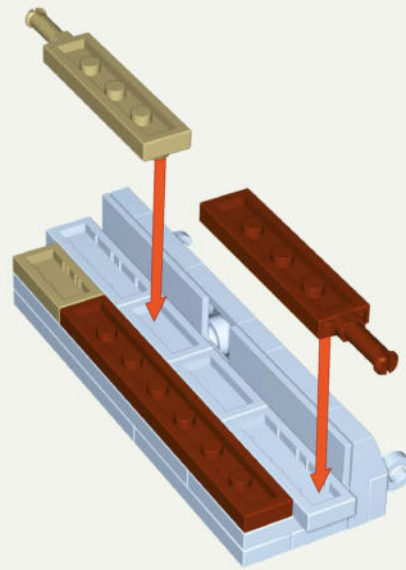

- | | | |
|---|---|---|
|  |  |  |
| x1 | x1 | x2 |

58



- | | | | |
|---|---|---|---|
|  |  |  |  |
| x1 | x1 | x1 | x1 |

59

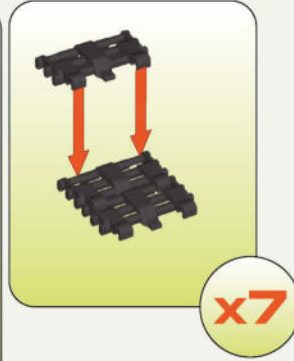
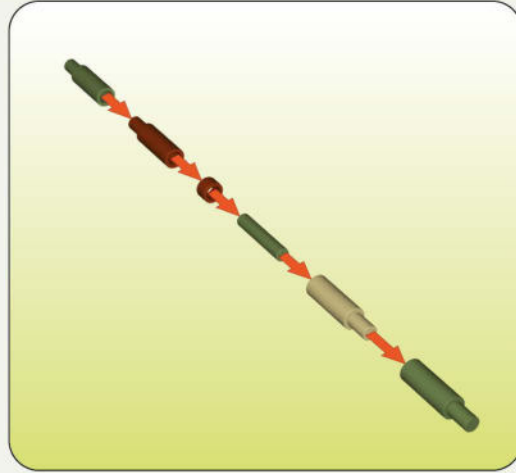
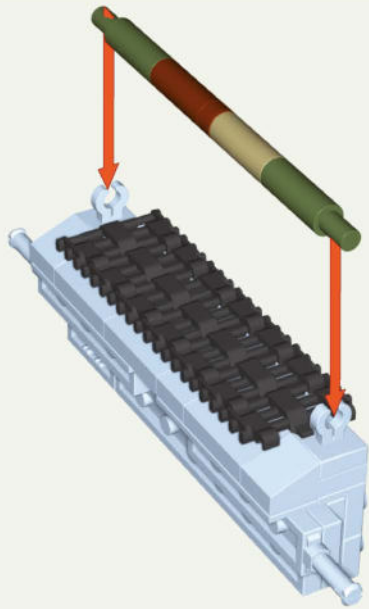

- | | | |
|-----------|-----------|-----------|
| | | |
| x7 | x2 | x1 |
| | | |
| x1 | x1 | x1 |

60

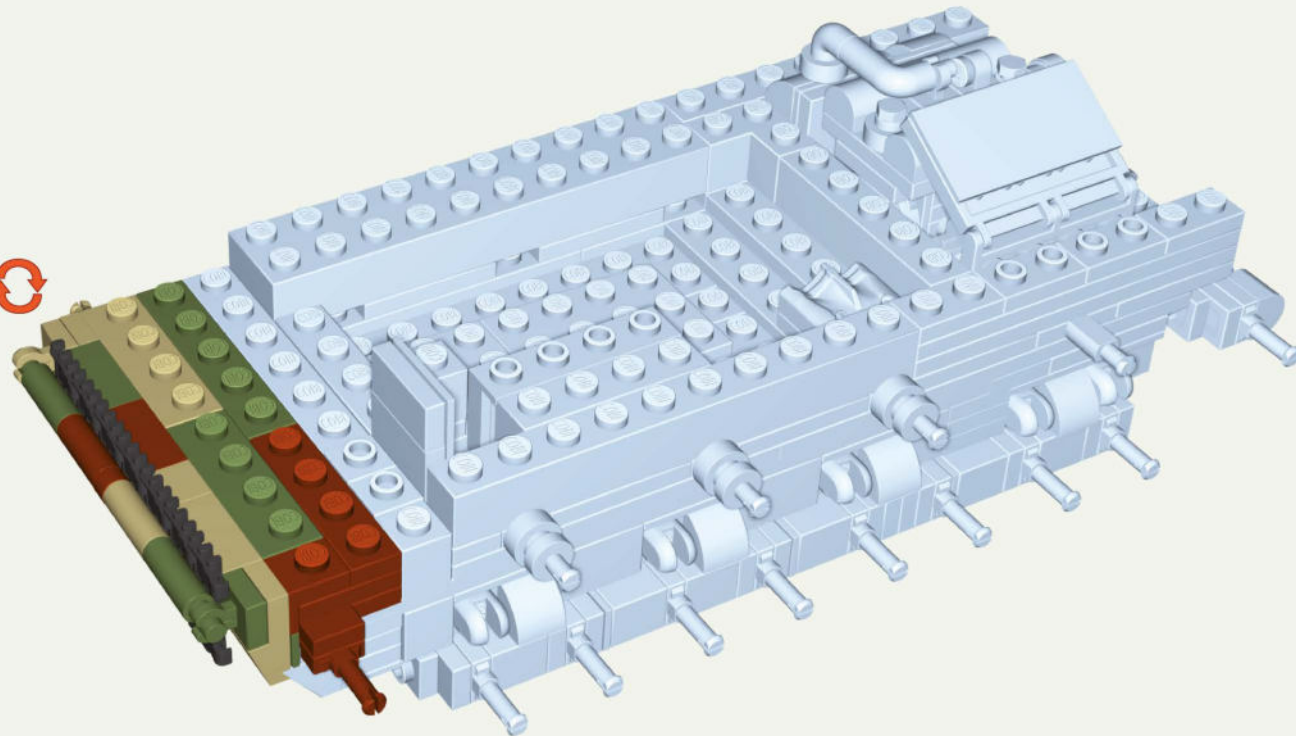

61



x1



x1



x1



x1



x1



x2



x1

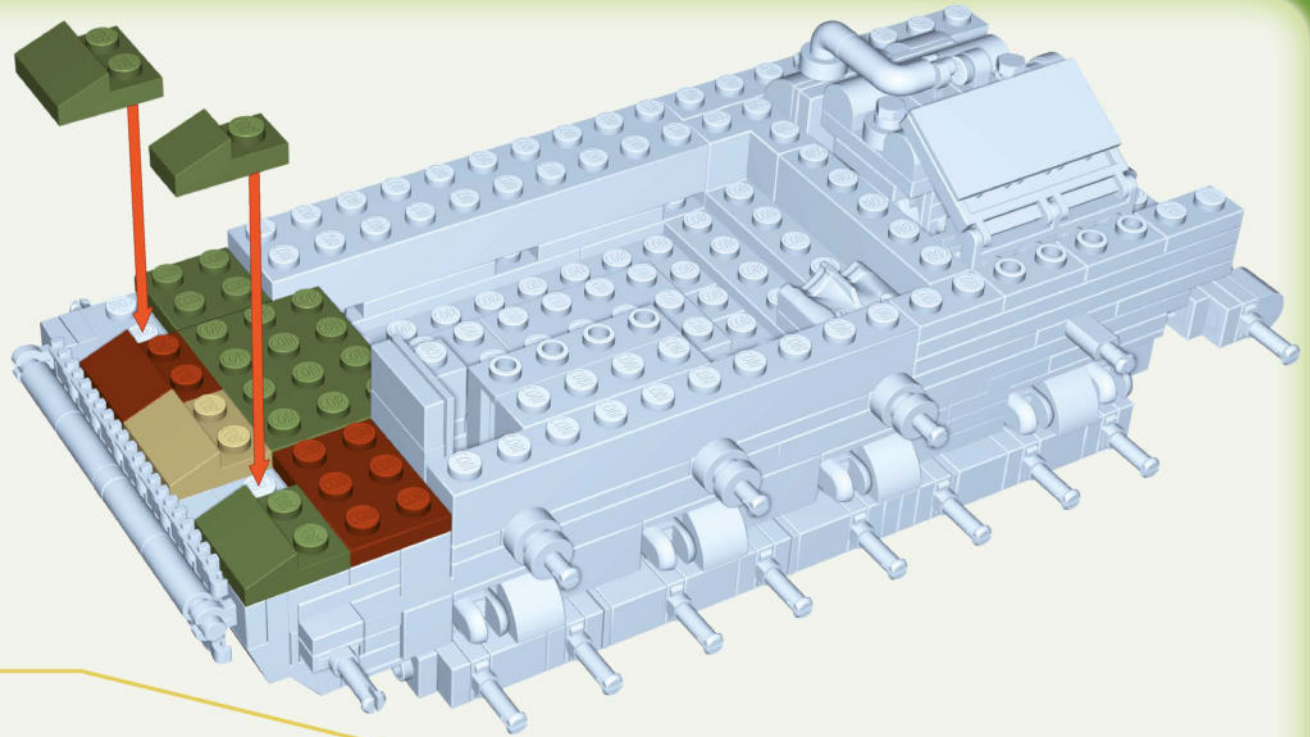

62

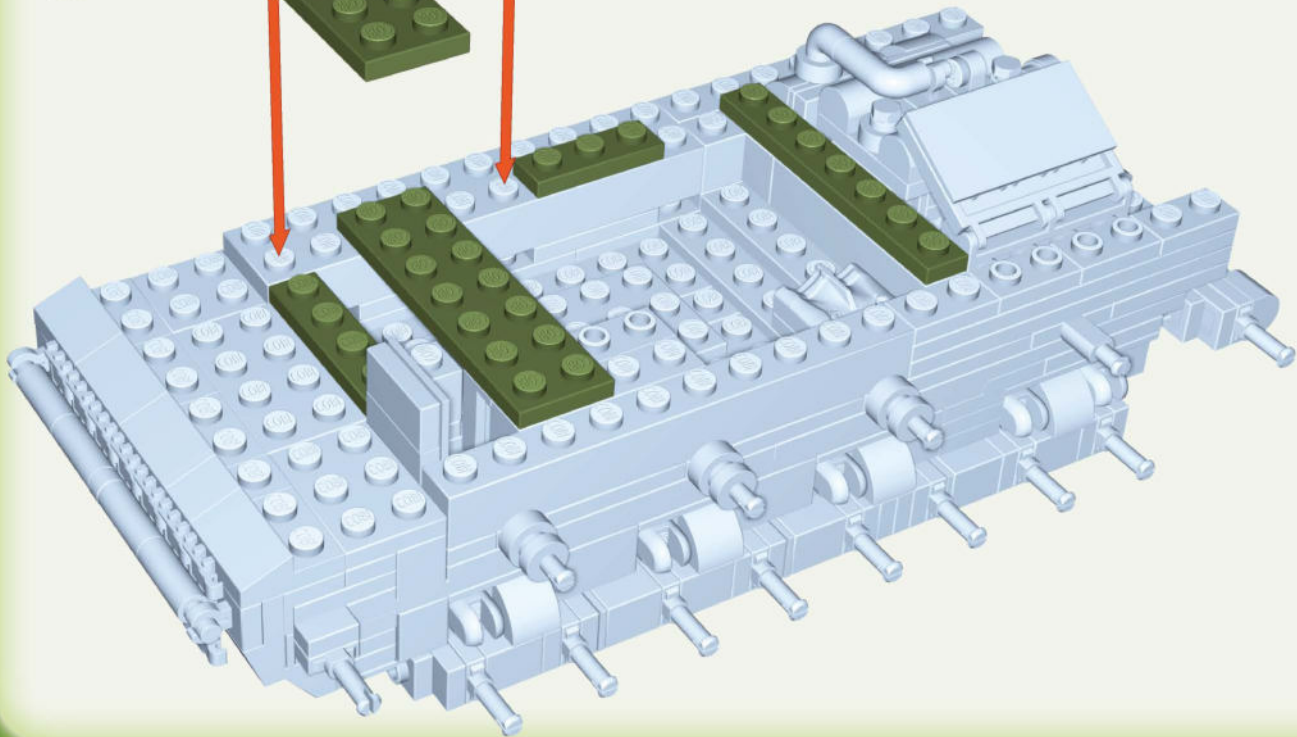

x1



x1



x1



x1



x1





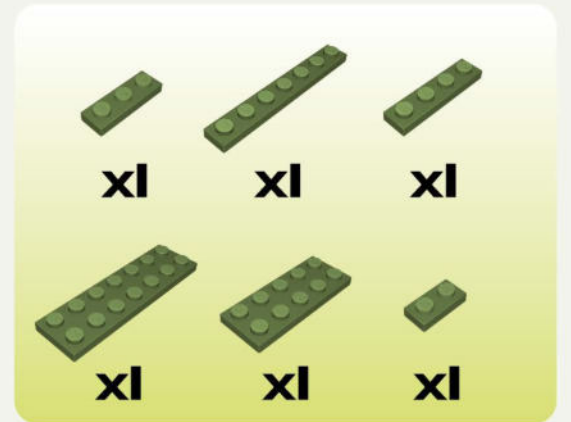

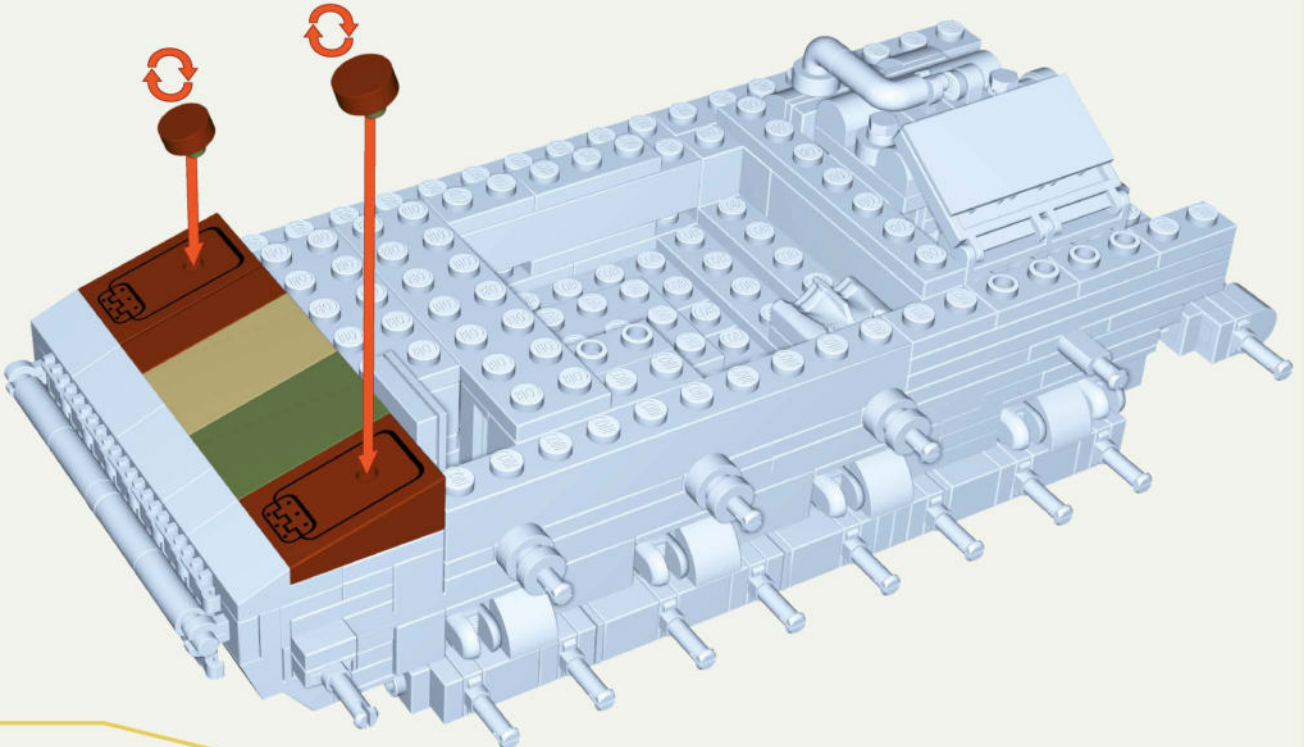
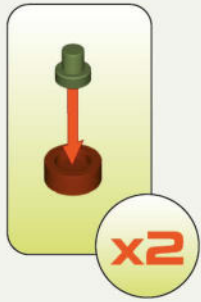

x1



63



		
x1	x1	x1
		
x2	x2	x2

64

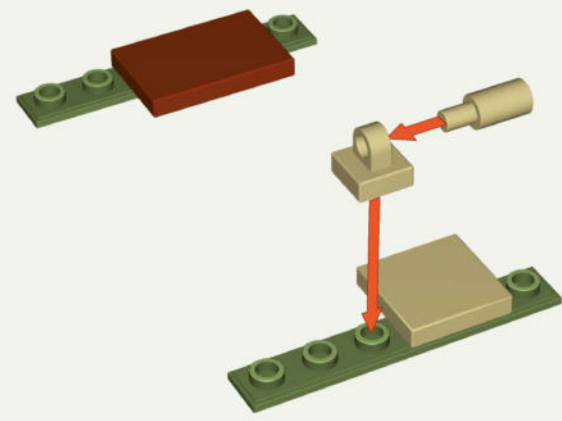





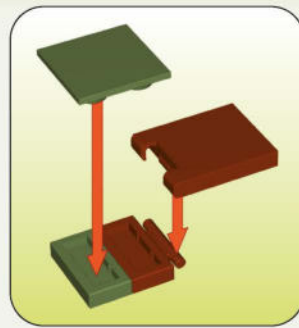
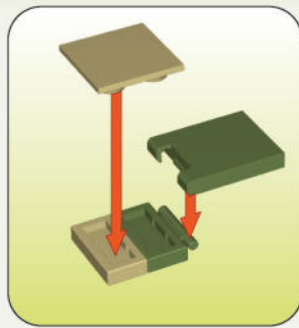
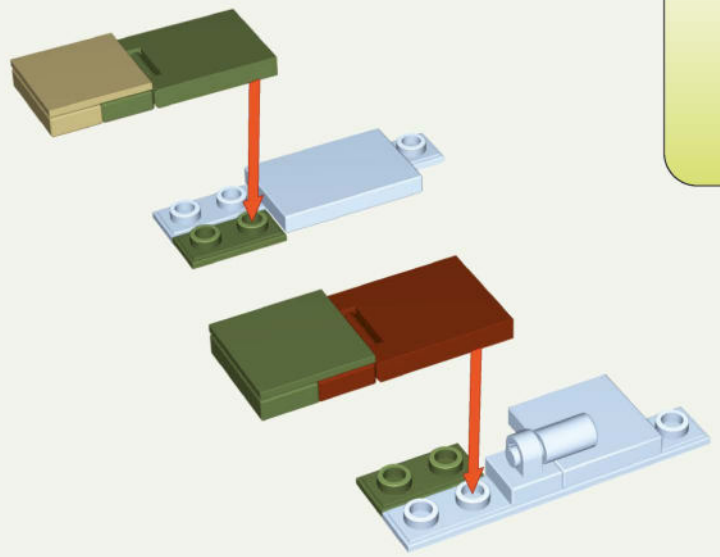



				
x2	x1	x1	x1	x1

65







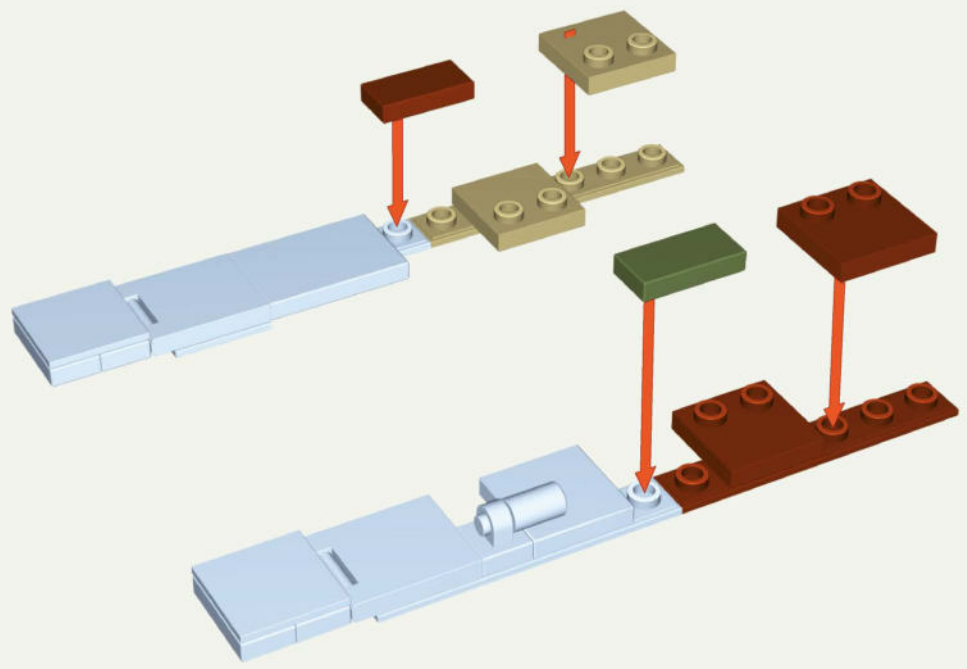

1:1

- 
x2
- 
x1
- 
x1
- 
x1
- 
x1
- 
x1
- 
x1
- 
x1
- 
x1

66







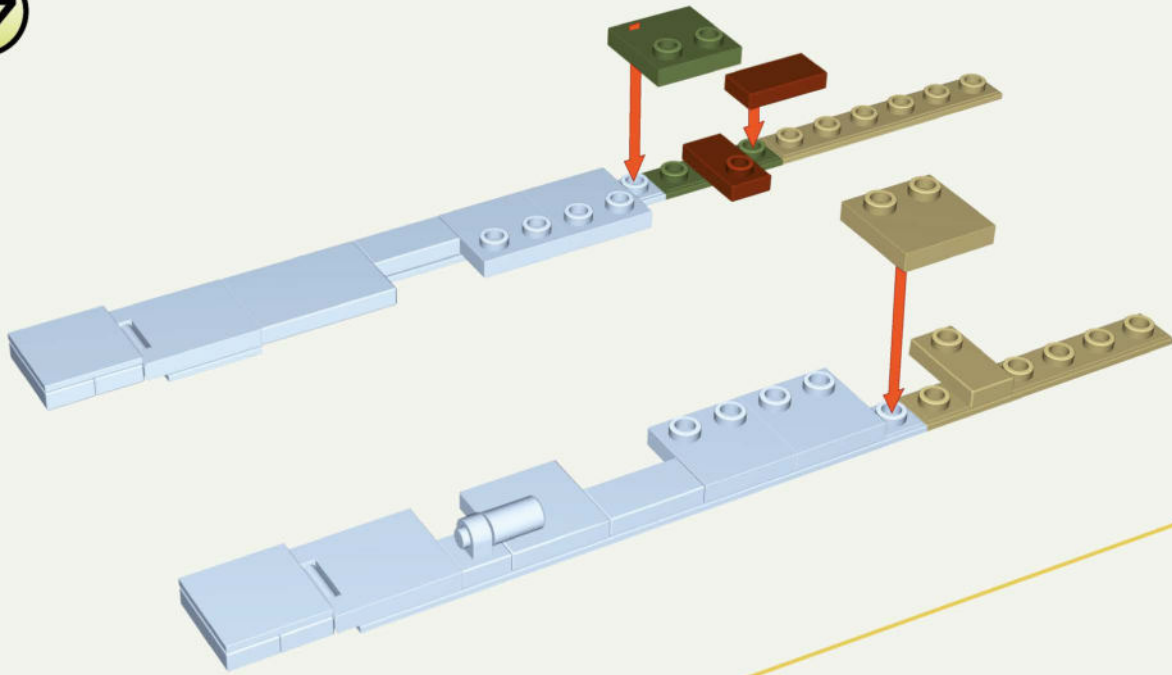

1:1

- 
x1
- 
x1
- 
x2
- 
x2
- 
x1
- 
x1

67



			
x2	x1	x1	x1
			
x1	x1	x1	

1:1

68

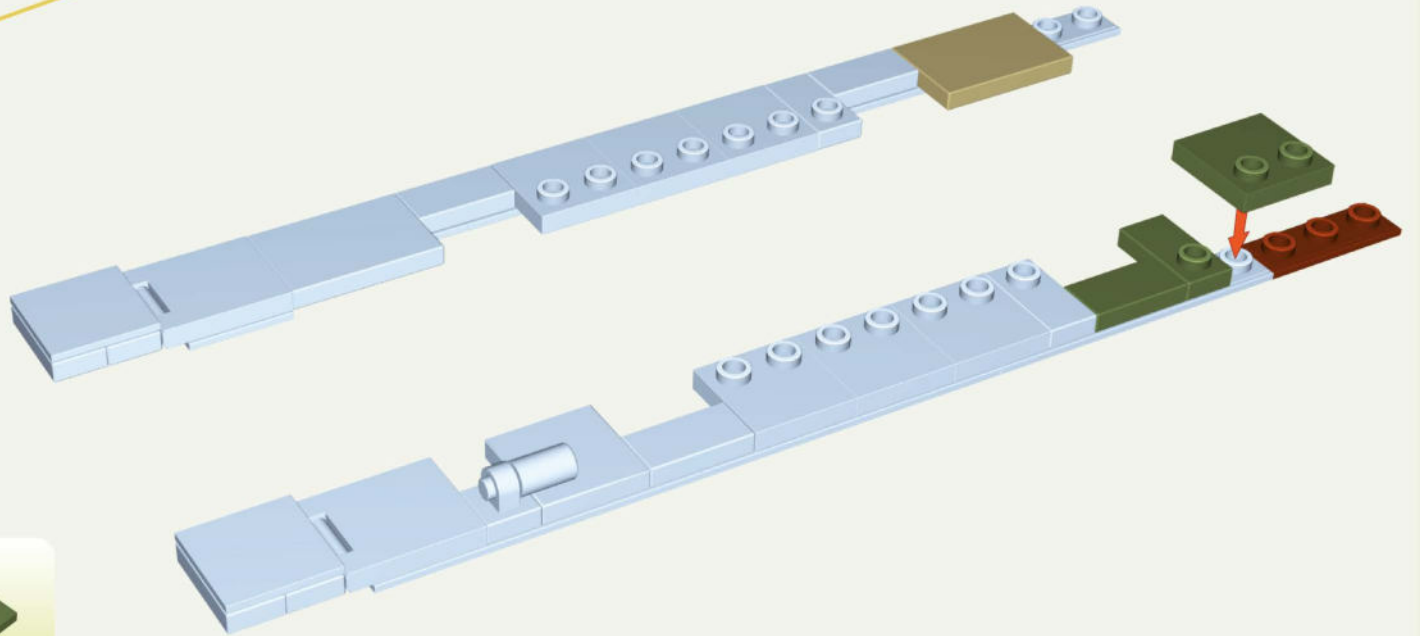

1:1

				
x1	x1	x1	x1	x1

69

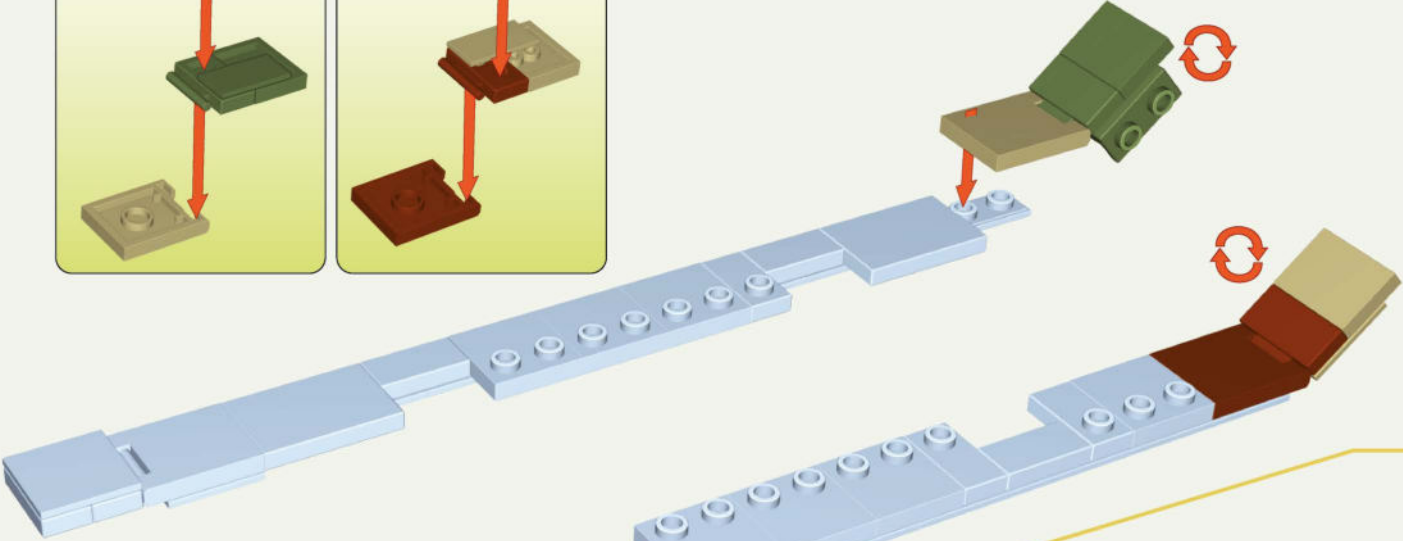
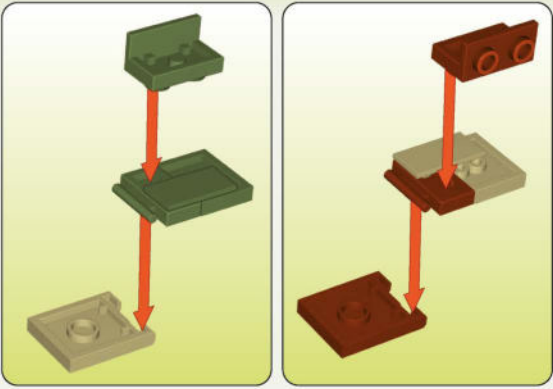

- | | | | |
|-----------|-----------|-----------|-----------|
| | | | |
| x1 | x1 | x1 | x1 |
| | | | |
| x1 | x1 | x1 | x1 |
| | | | |
| x1 | x1 | | |

70

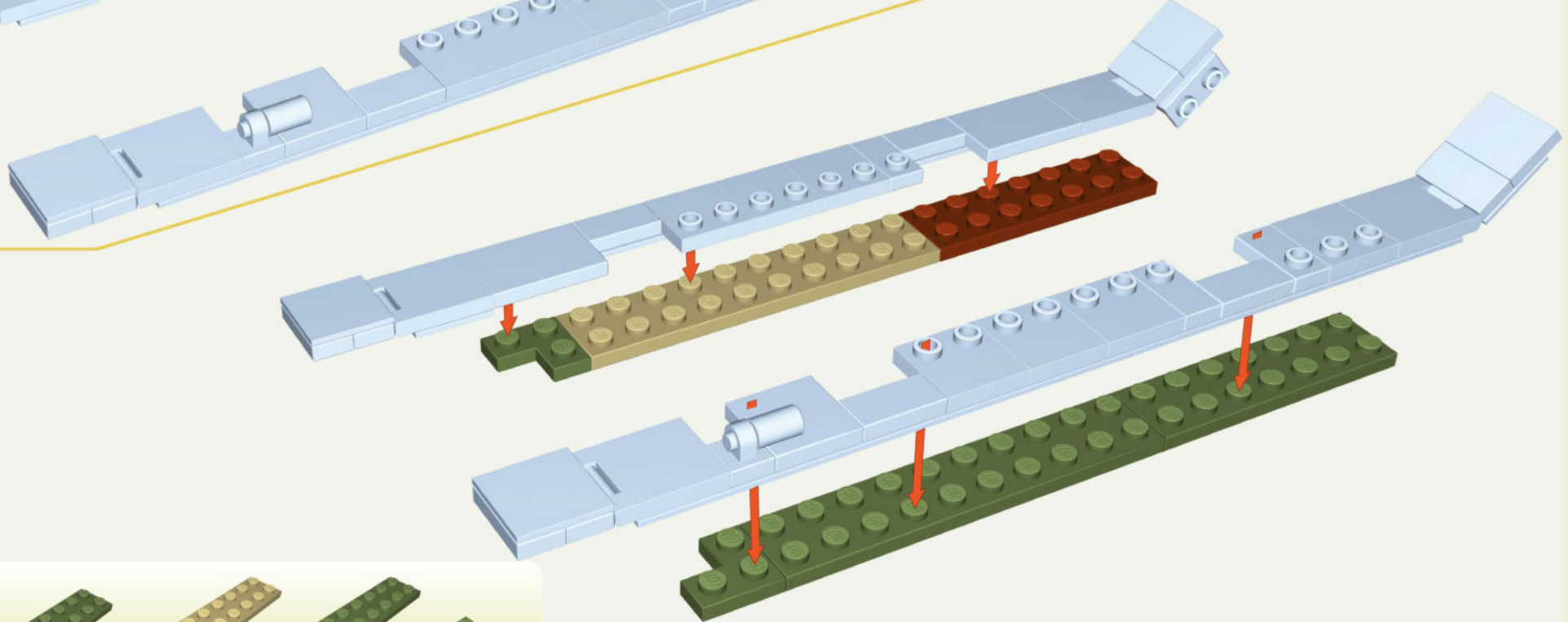

- | | | | | |
|-----------|-----------|-----------|-----------|-----------|
| | | | | |
| x1 | x1 | x1 | x1 | x2 |

73

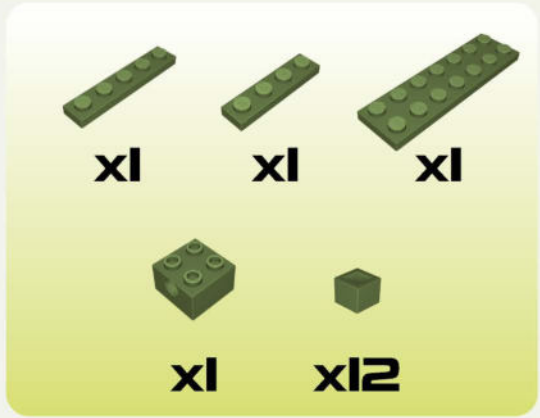
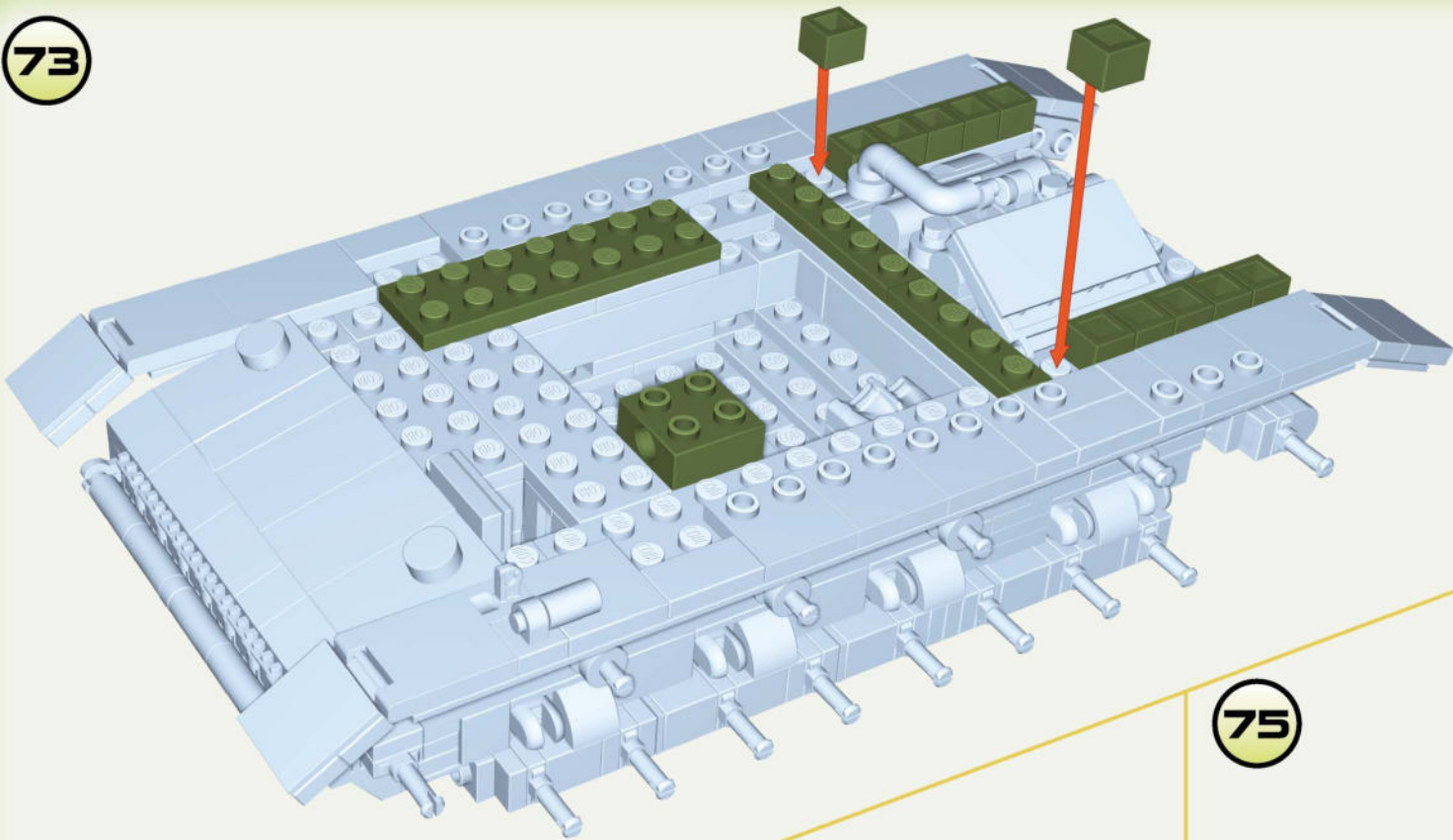

74

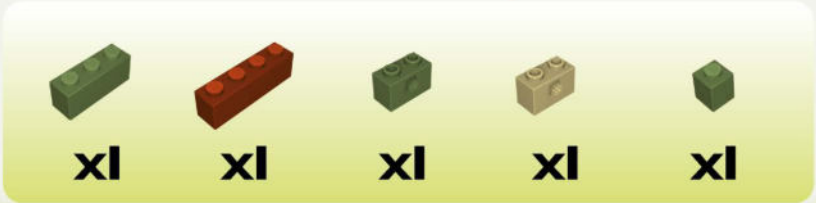
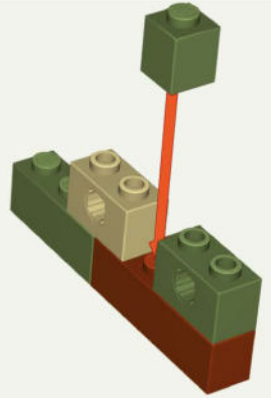

75

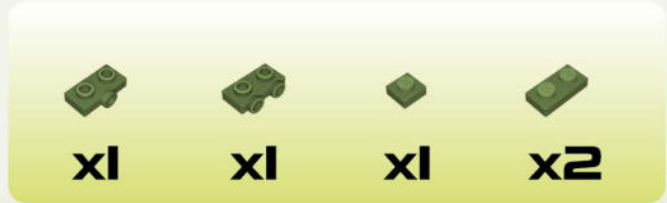
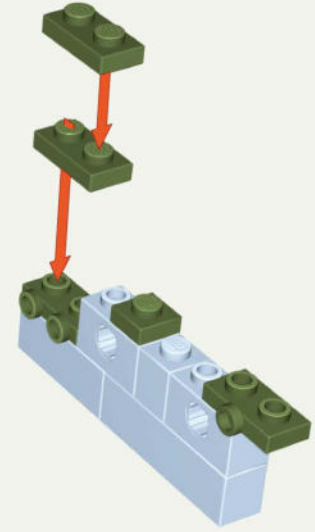

76

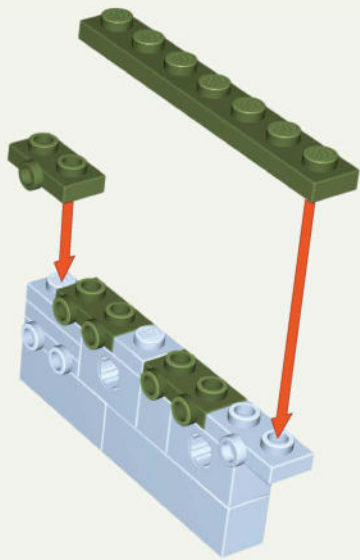

x2



x1



x1

77

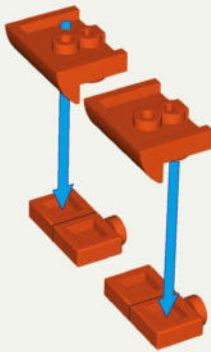

x2



x2



x2

78

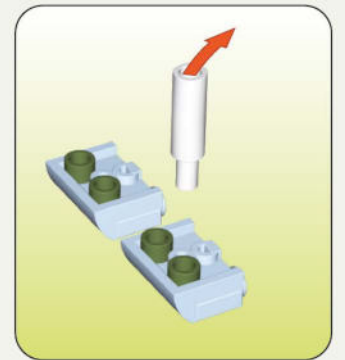
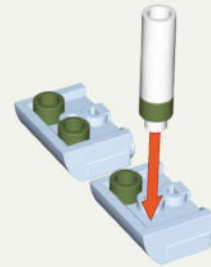

x4

79

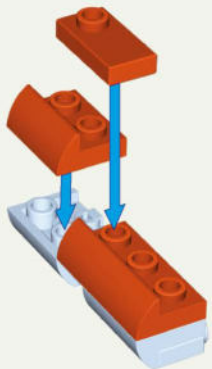

x1



x1



x1

80

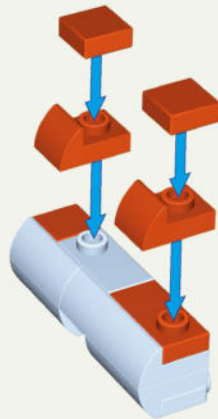

x1



x3



x2

81

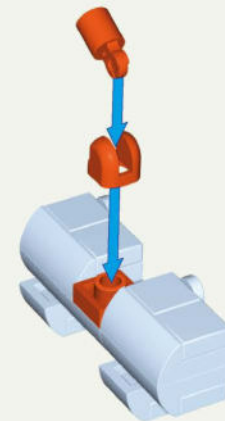

x1



x1



x1

82

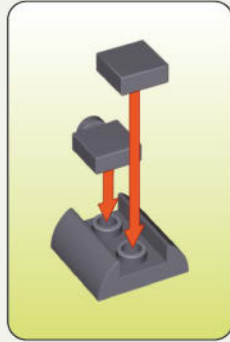
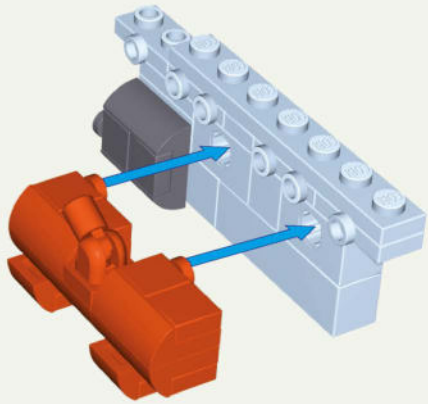

x1	x1	x1

83

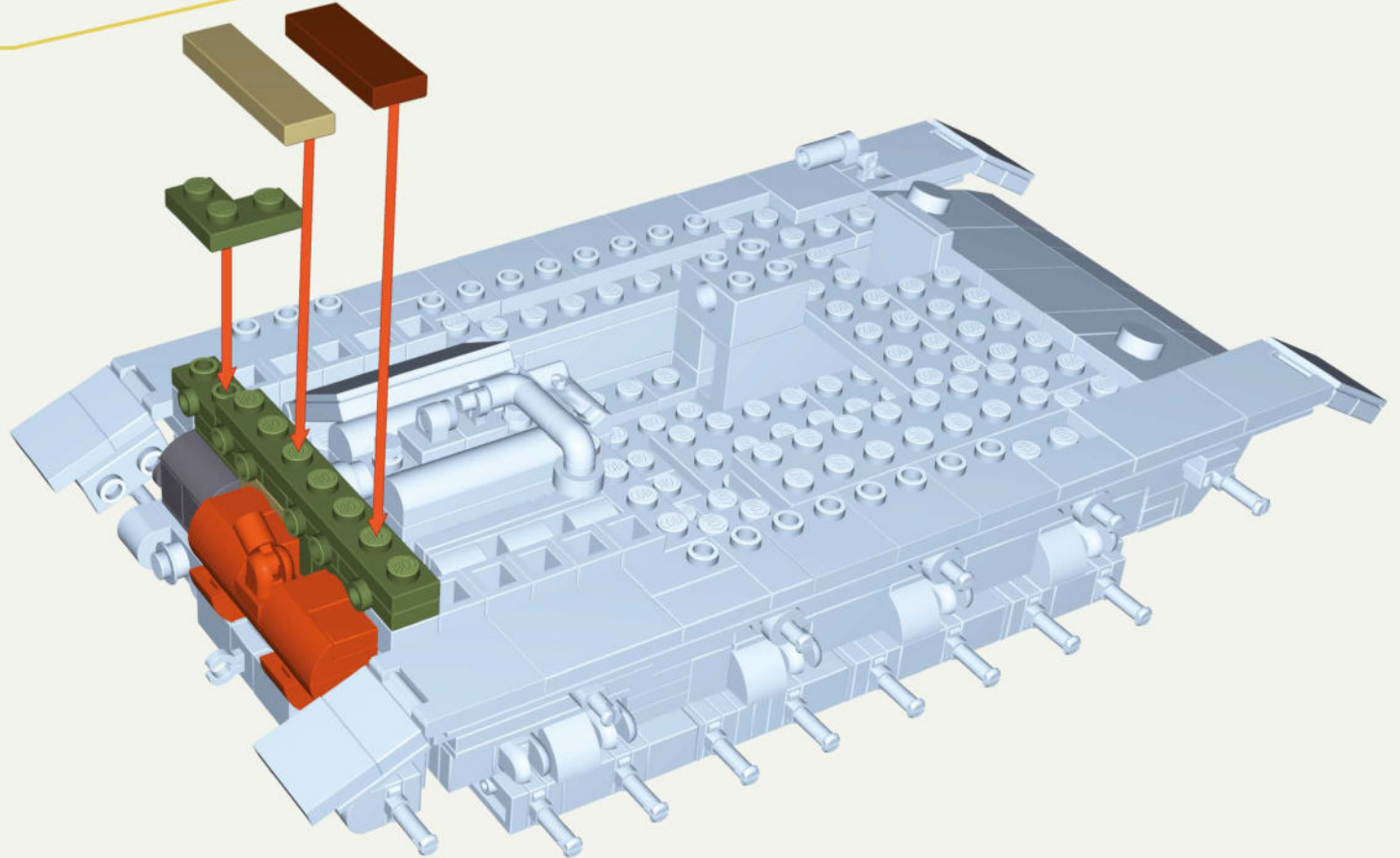

1:1	1:1
------------	------------

x1	x1	x1

84

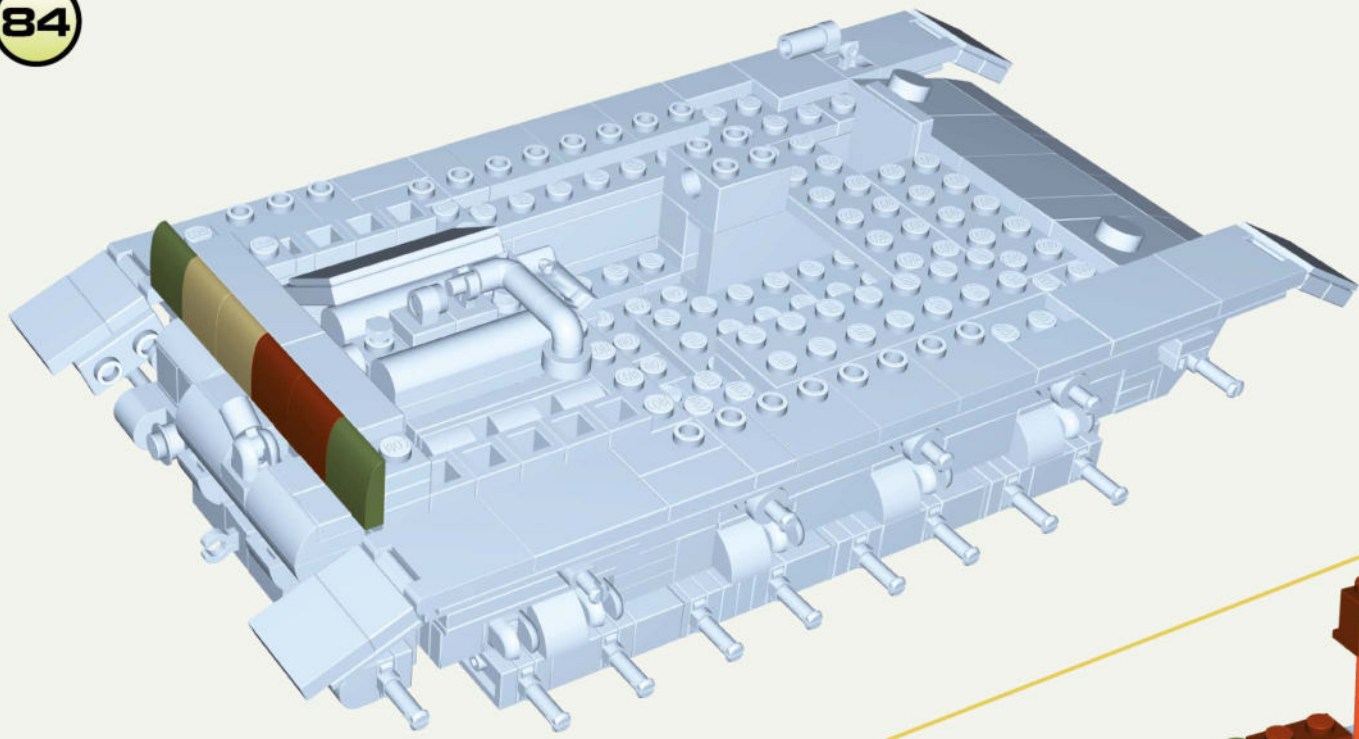

x2	x2	x2

85

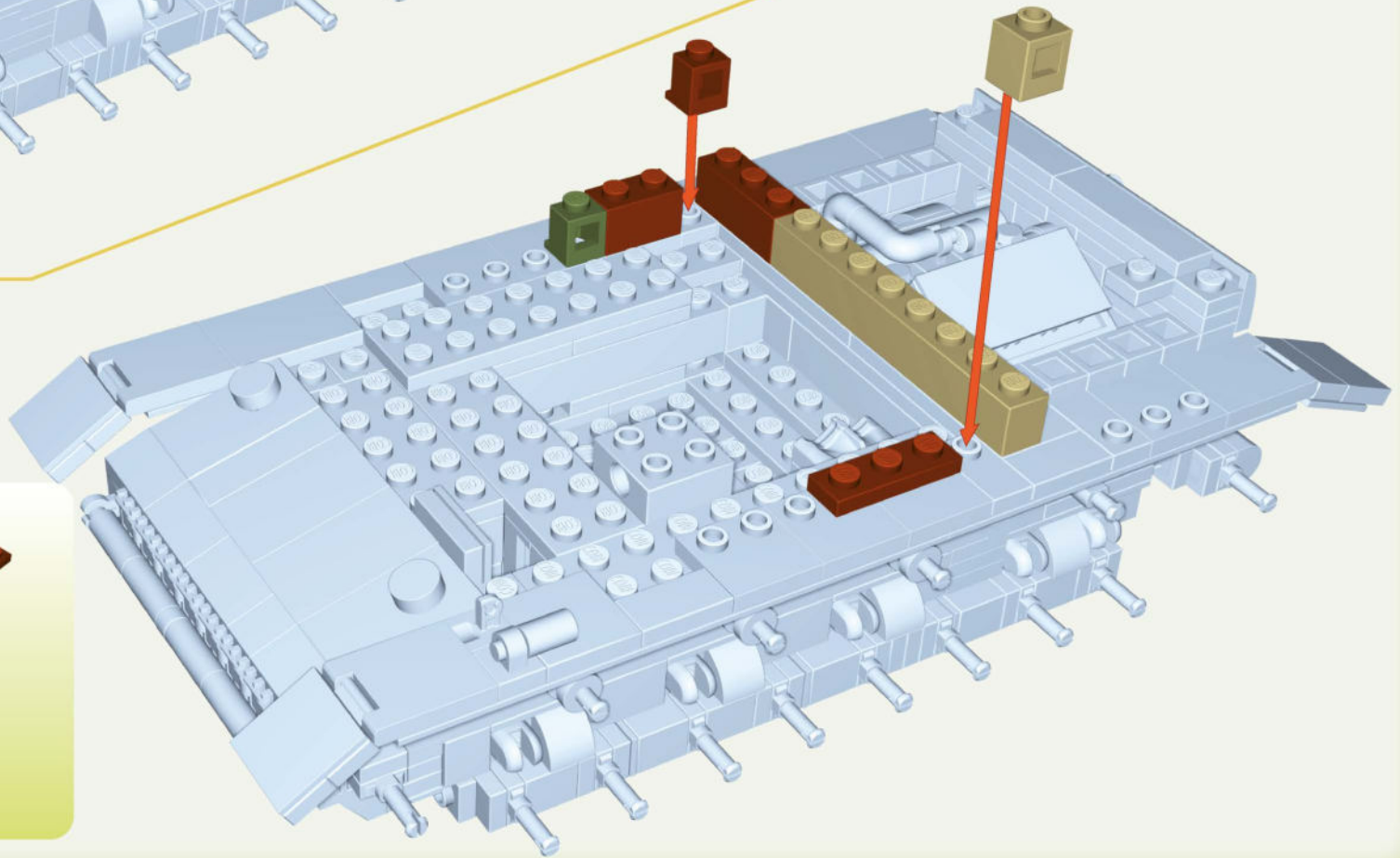

x1	x1	x1	x1
x1	x1	x1	

86

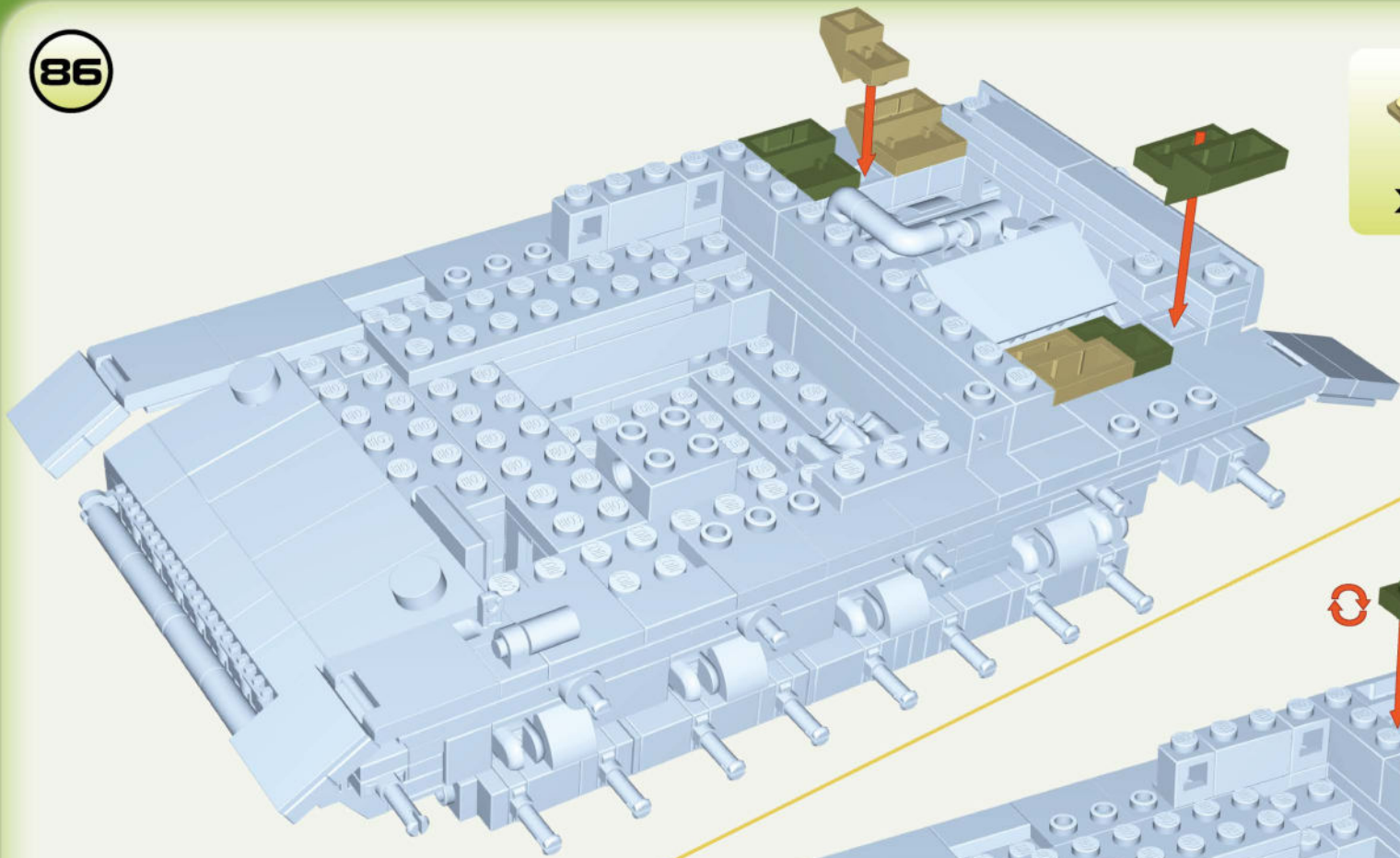

x2	x1	x1	x2

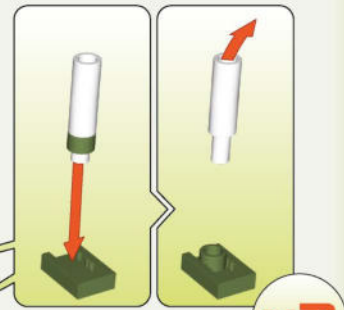

x2



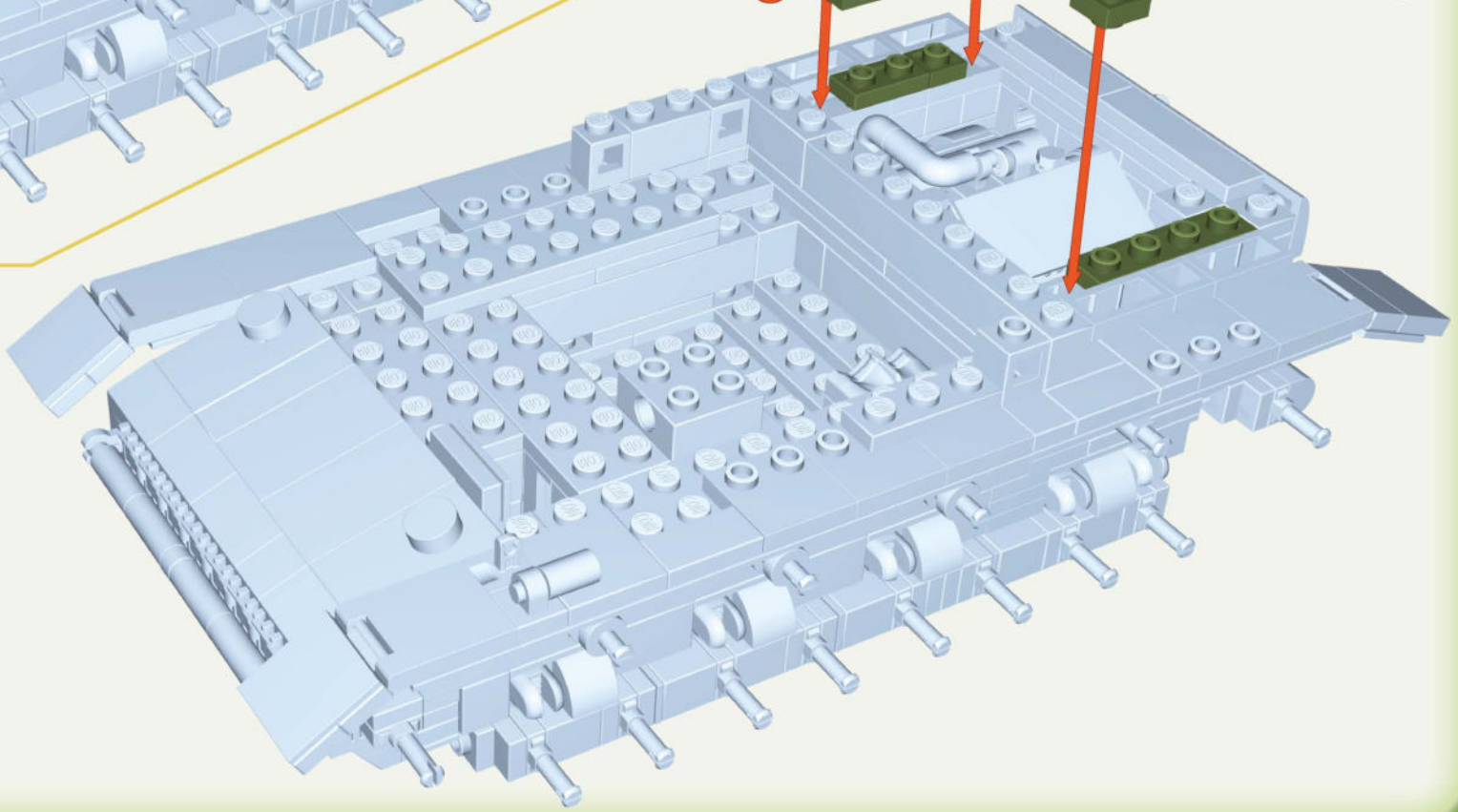

87

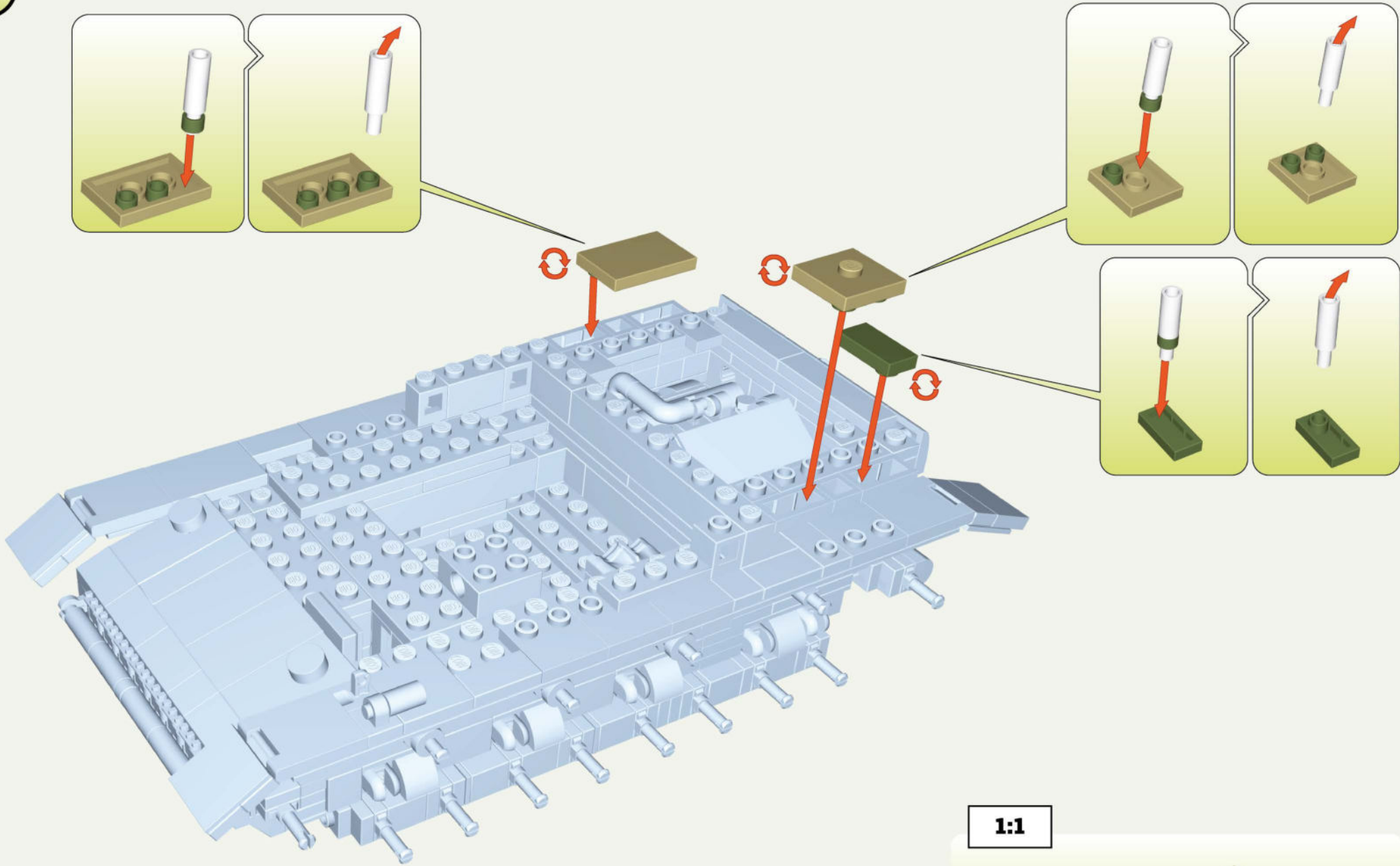

x1	x1	x2
x2	x2	







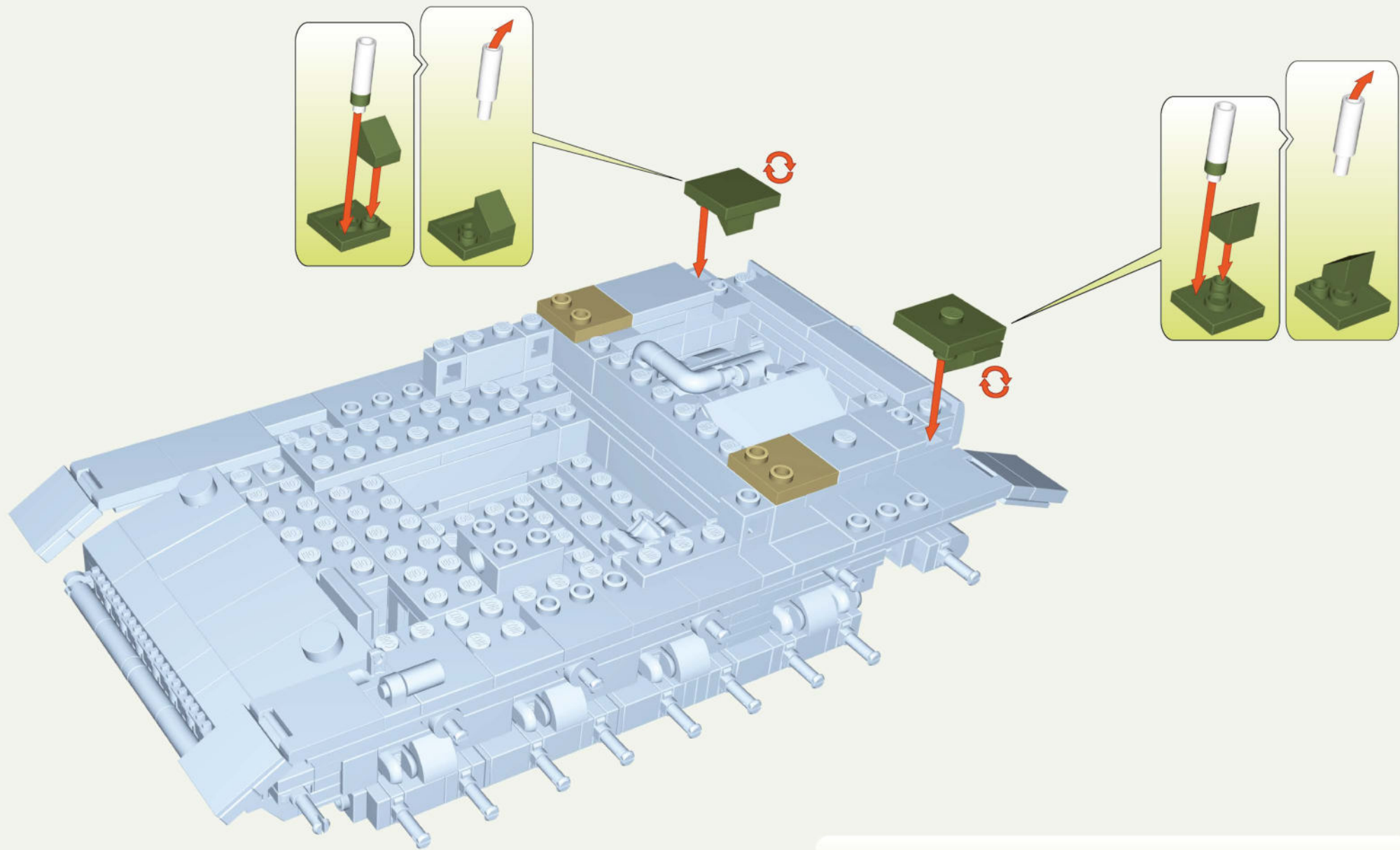

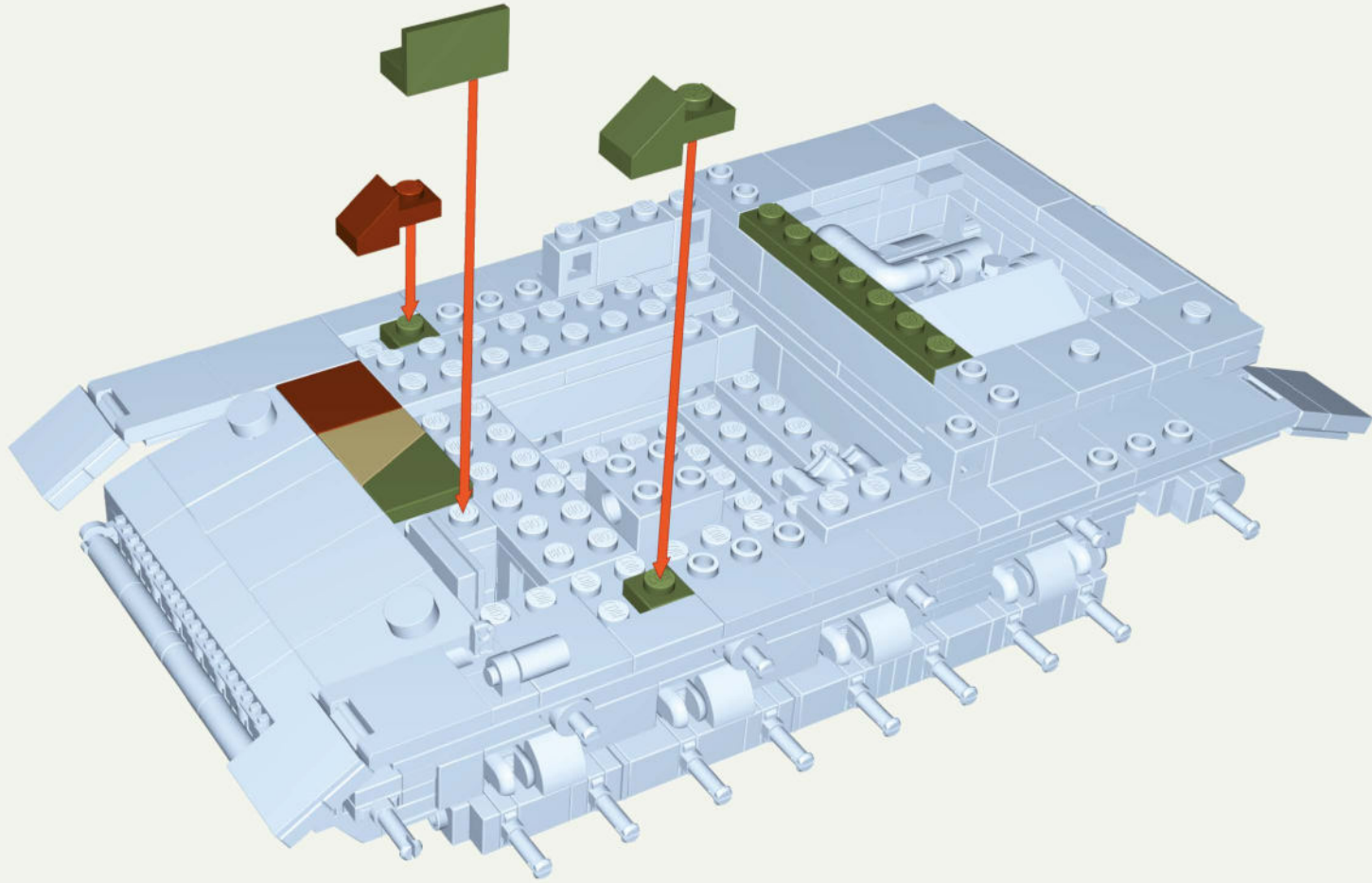

1:1

			
x1	x1	x1	x6







-  x2
-  x1
-  x1
-  x2
-  x4

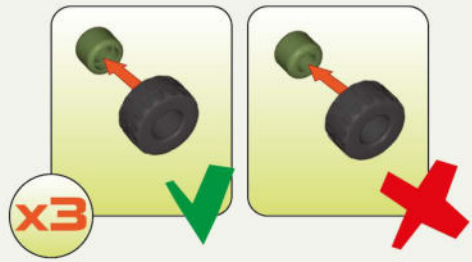
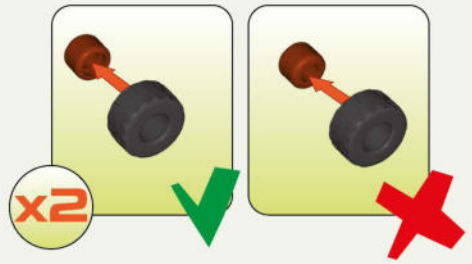
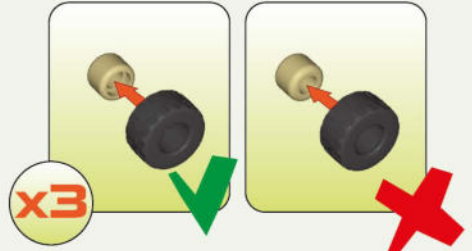
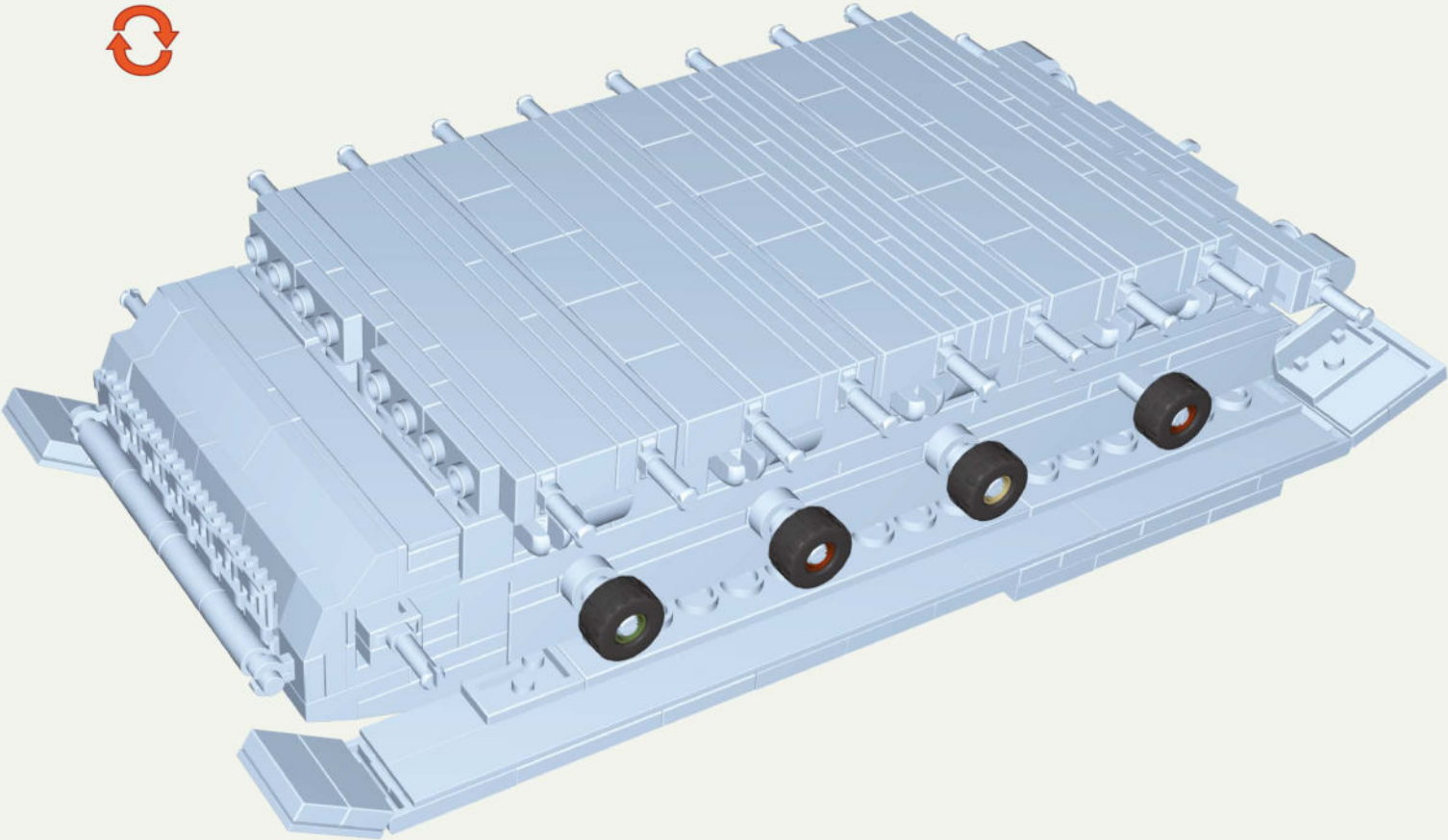

- | | | | |
|---|---|---|---|
|  |  |  |  |
| x2 | x1 | x1 | x1 |
|  |  |  |  |
| x1 | x1 | x1 | x1 |



-  x3
-  x2
-  x3
-  x8

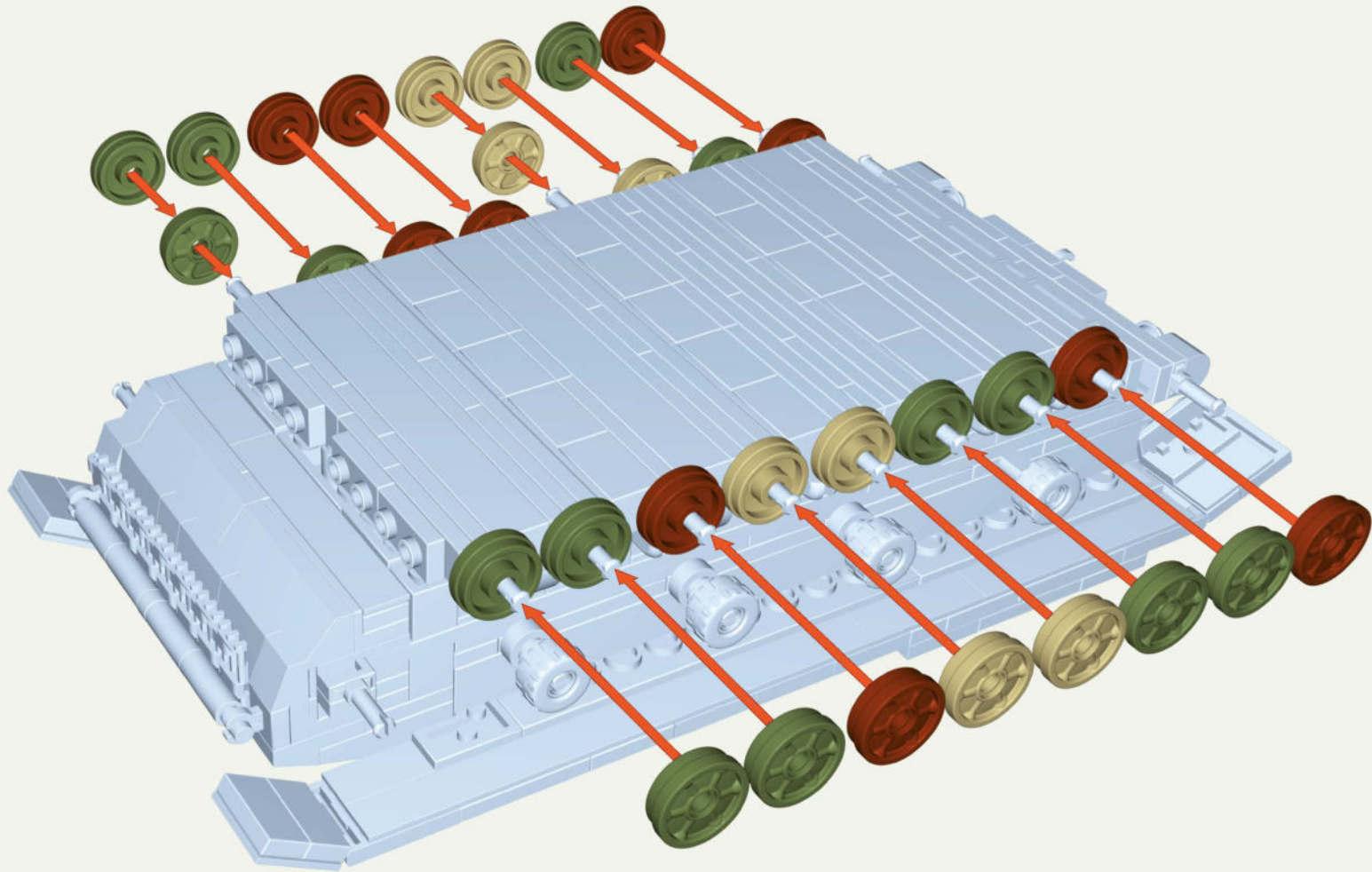

		
x10	x14	x8

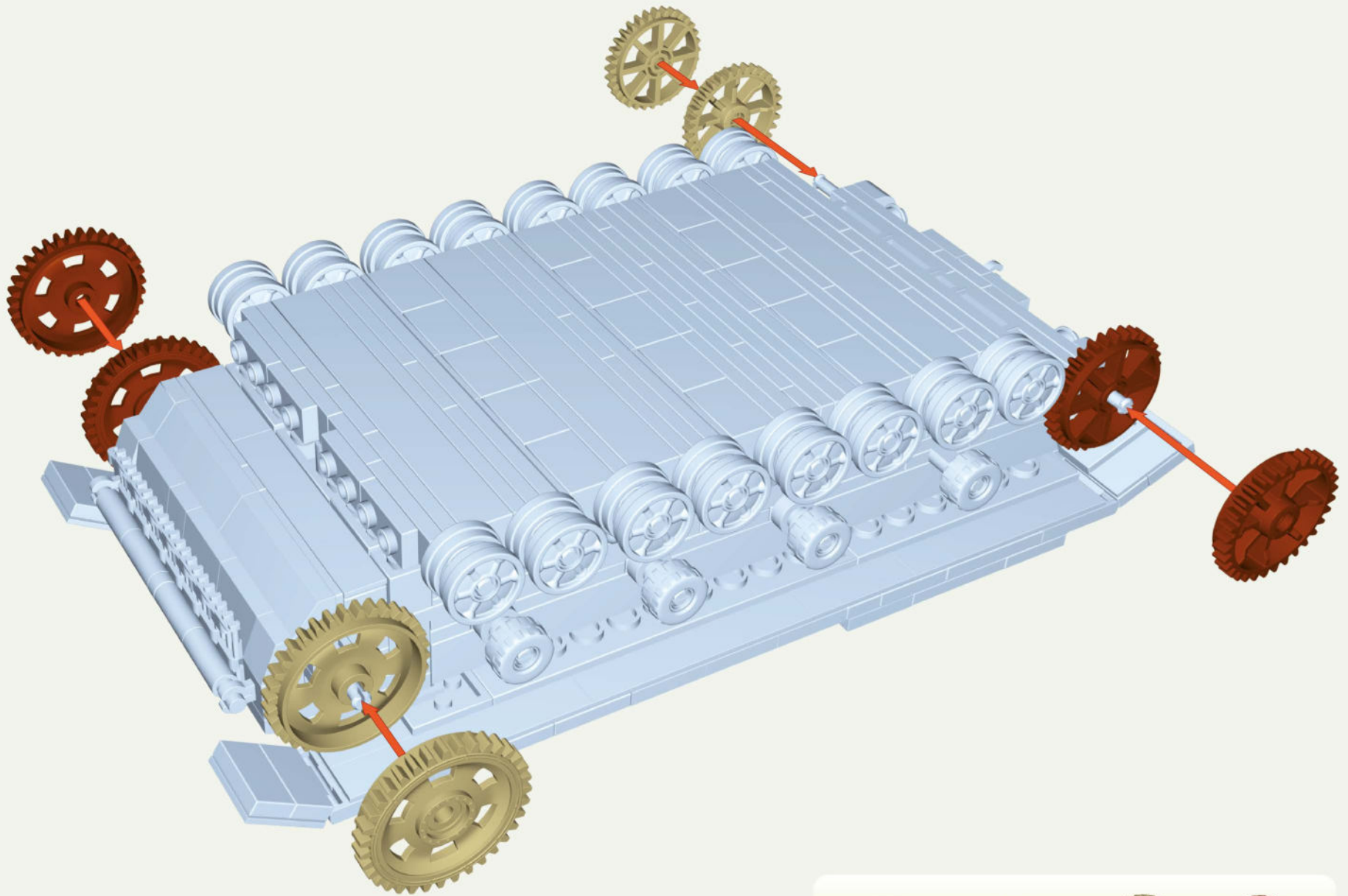

-  x2
-  x2
-  x2
-  x2

94



3

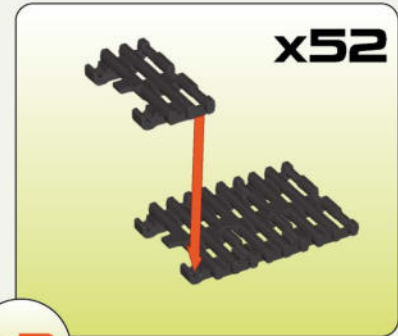
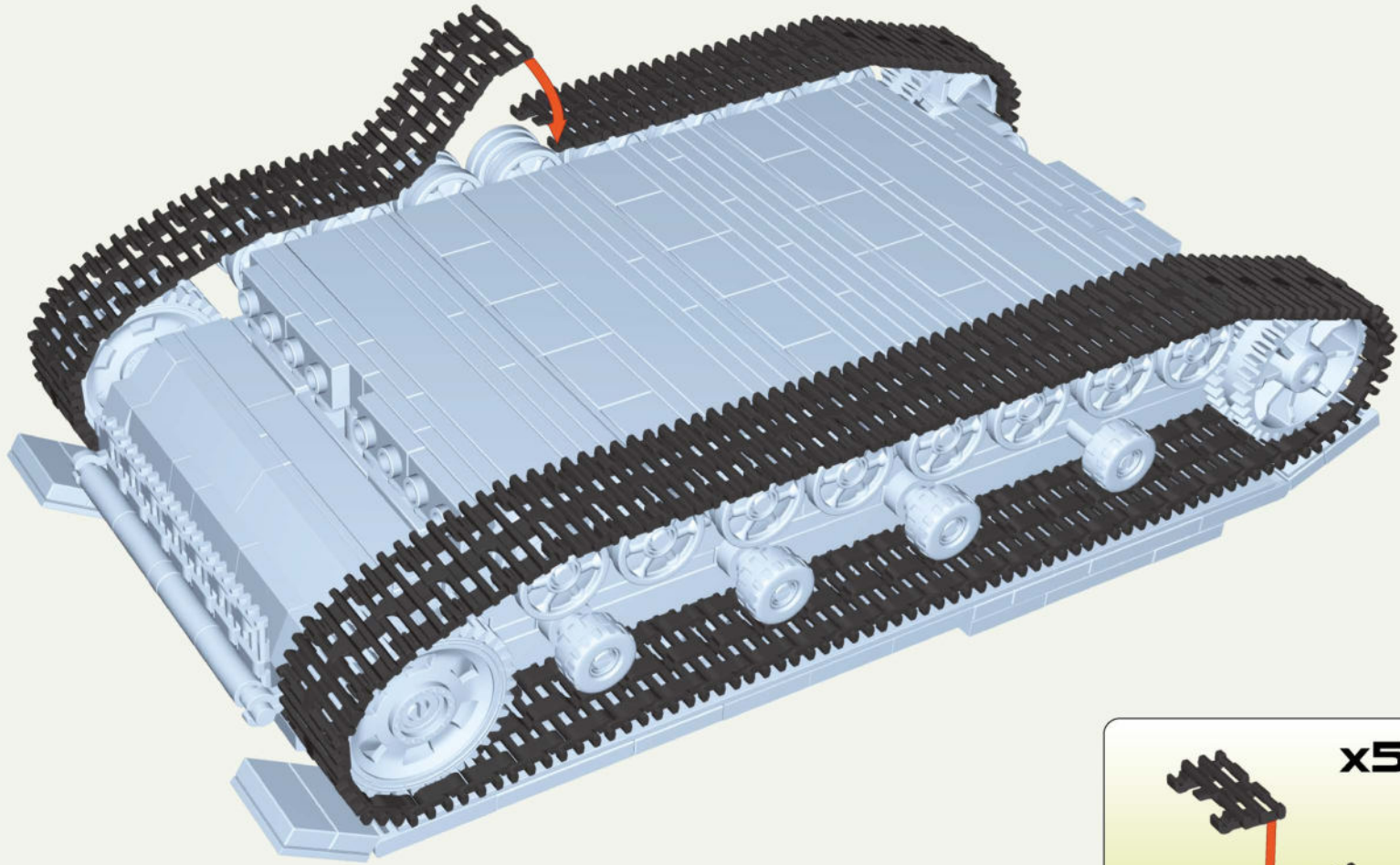

x52

x2



x104



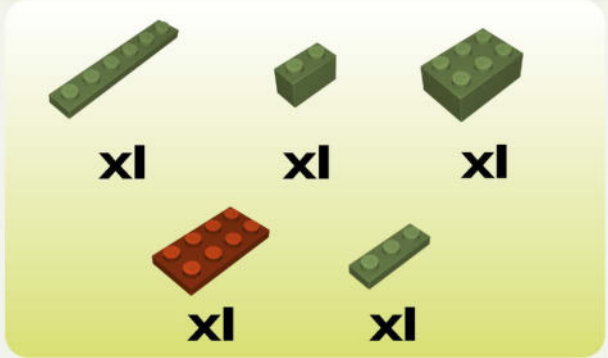
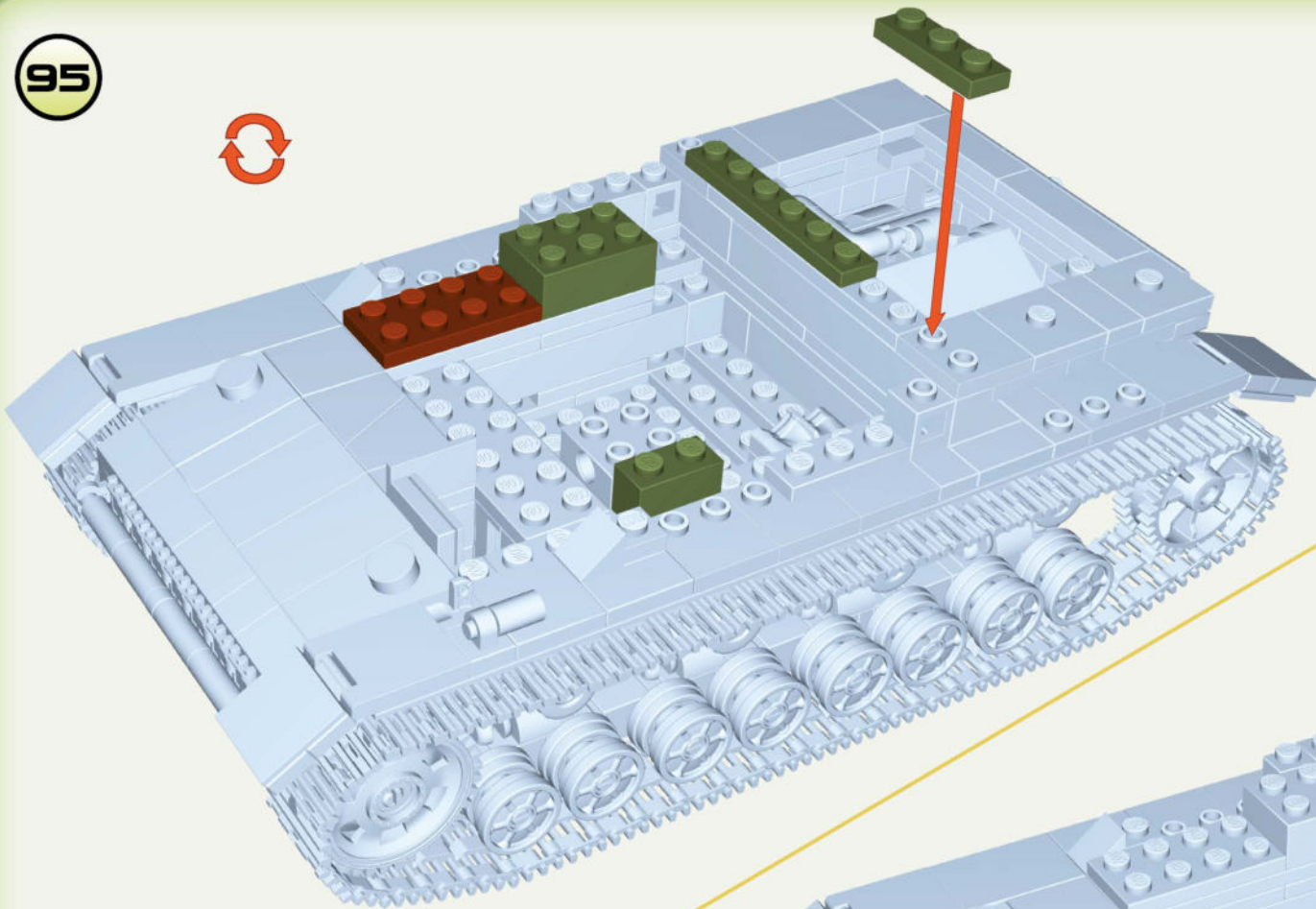



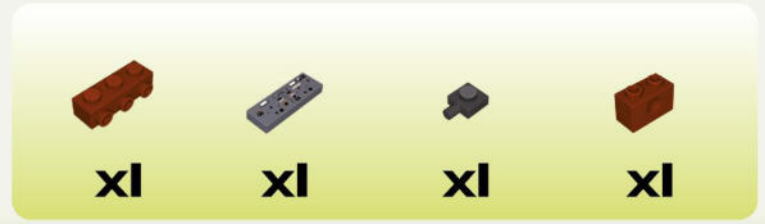
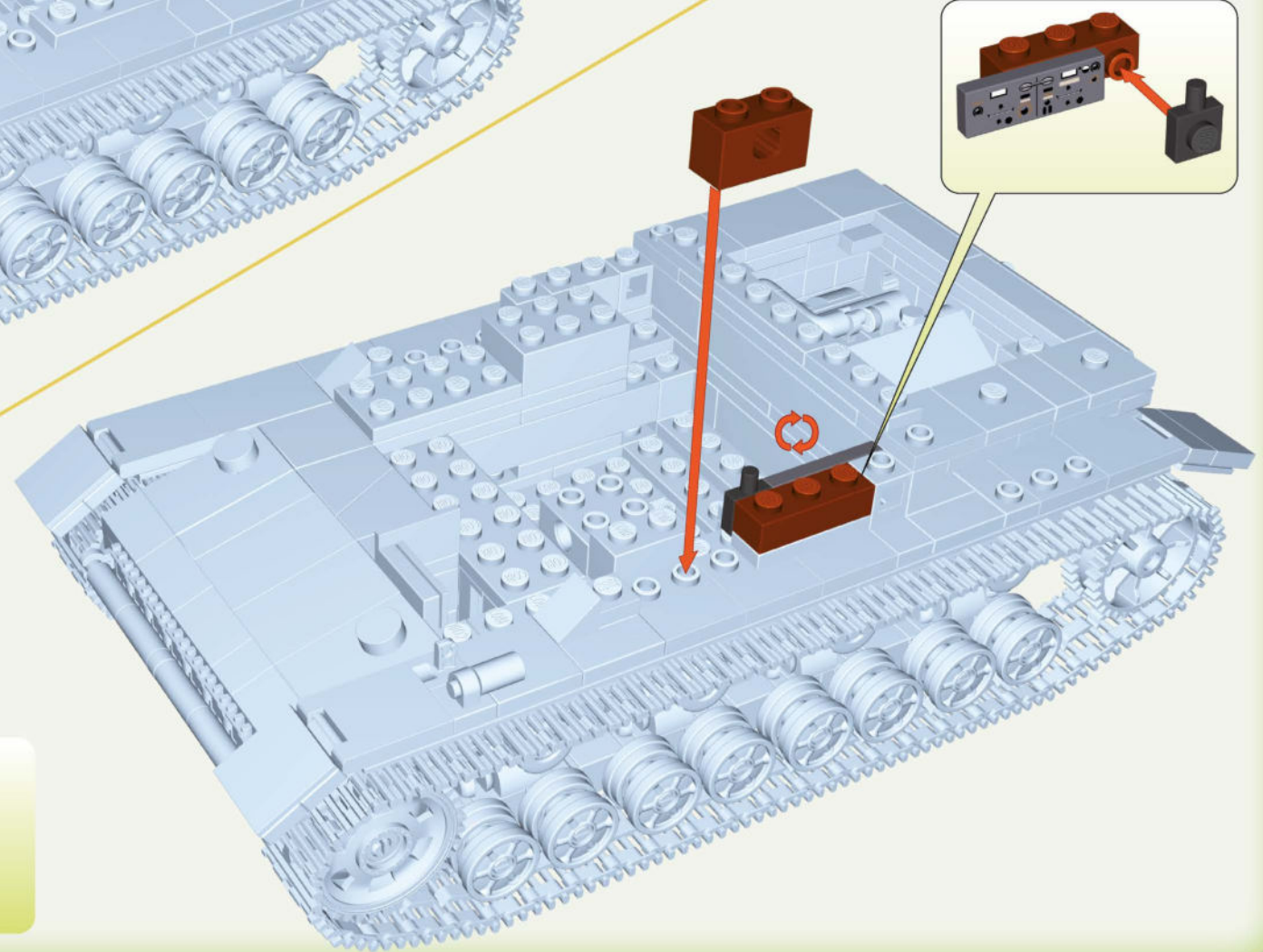

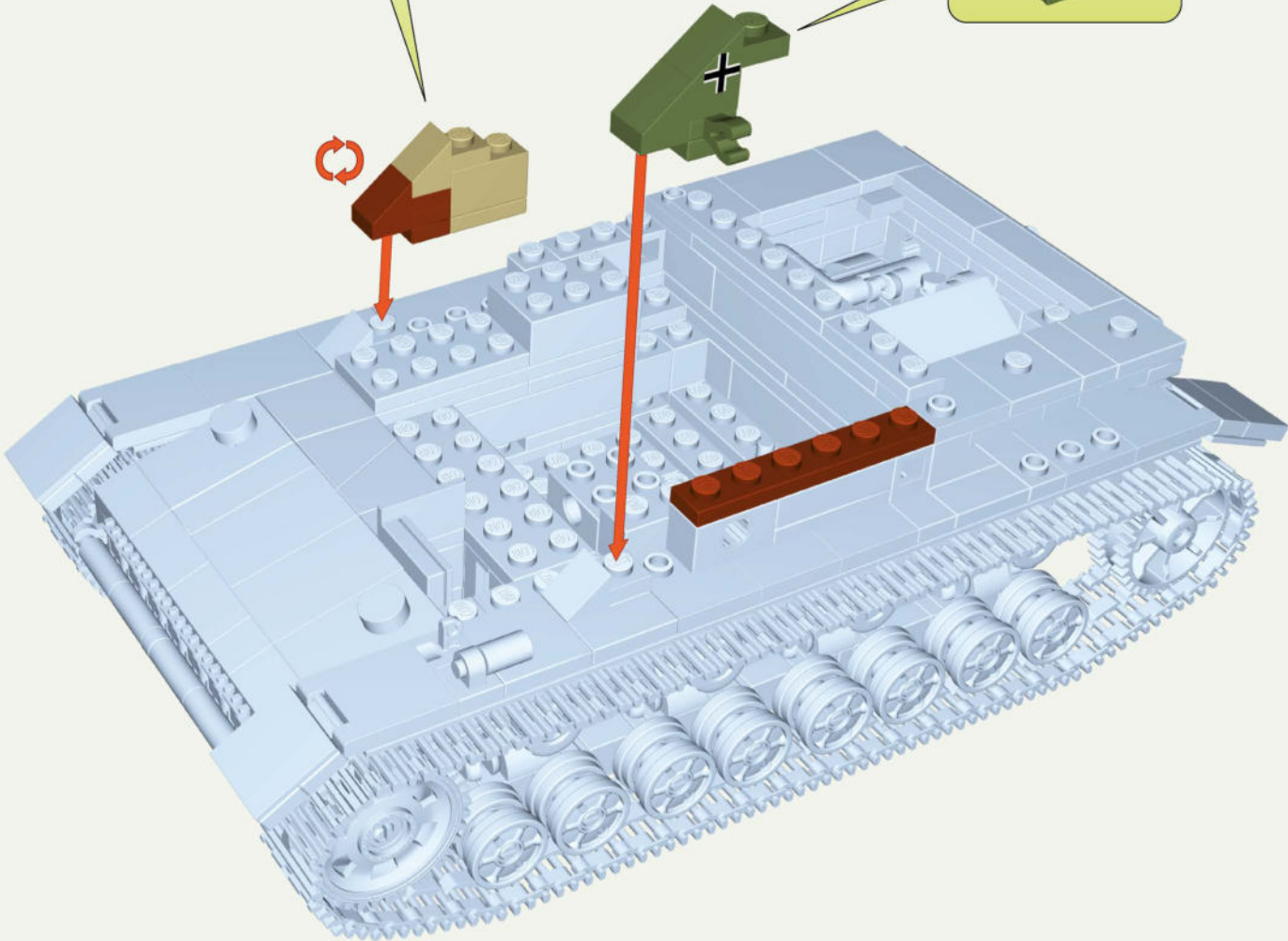
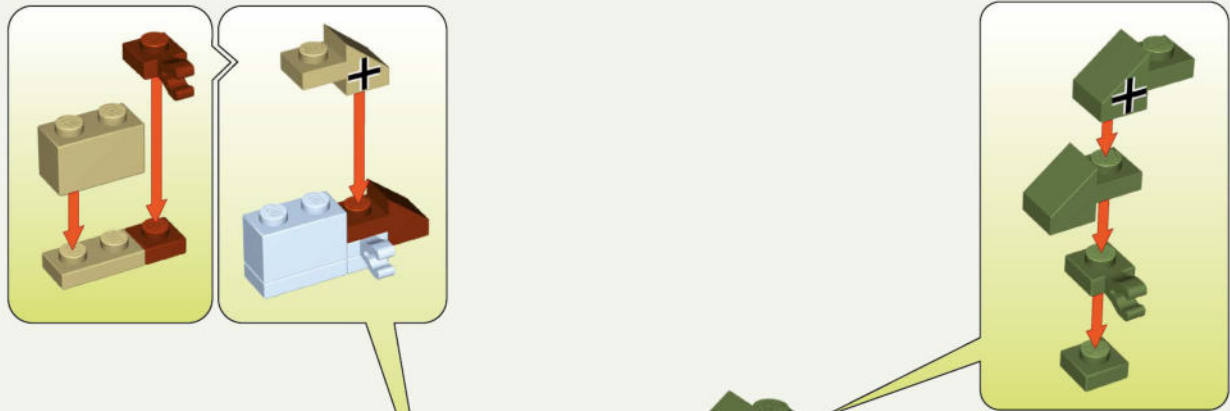

95



96







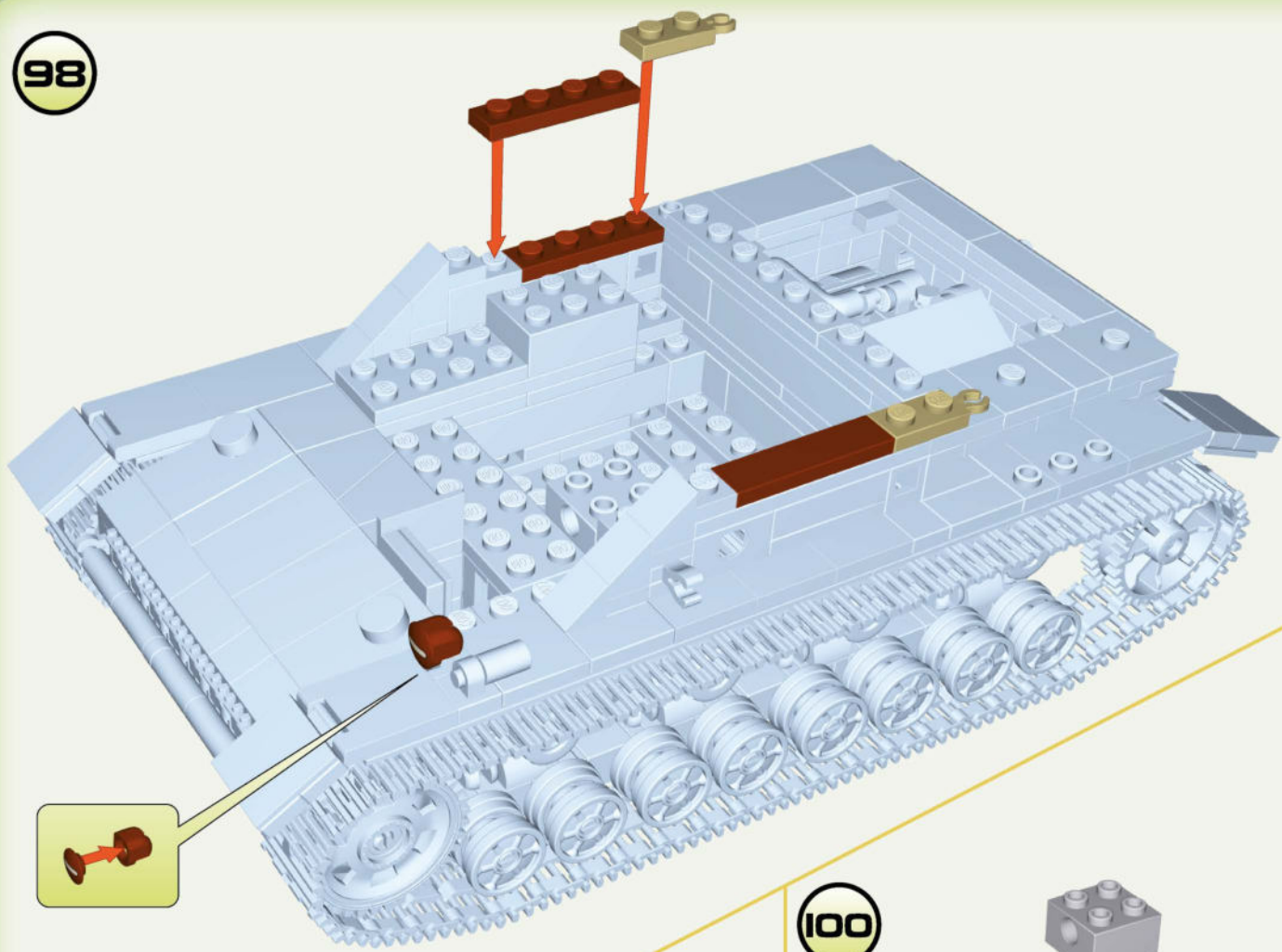

- | | | |
|---|---|---|
|  |  |  |
| x1 | x1 | x1 |
|  |  |  |
| x1 | x1 | x1 |
|  |  |  |
| x1 | x1 | x1 |
|  |  | |
| x1 | x1 | |

98



			
x1	x1	x2	x2
1:1			





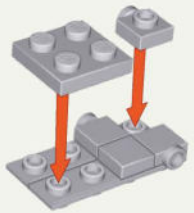

99

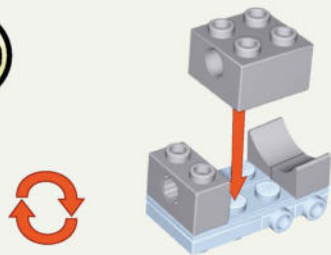

				
x2	x1	x2	x1	x1

100



		
x2	x1	x1

101

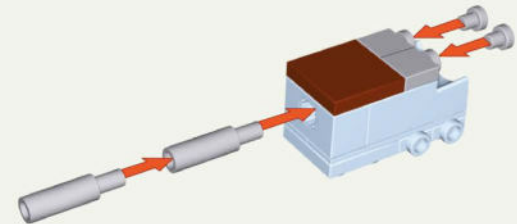

			
x1	x2	x2	x2

102

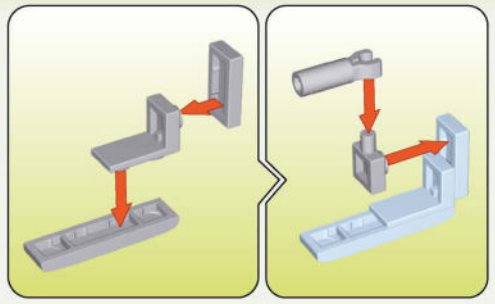
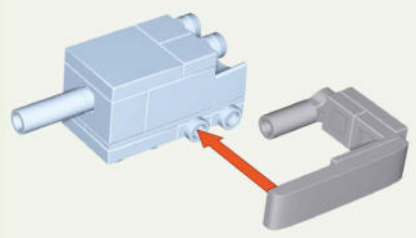

1:1

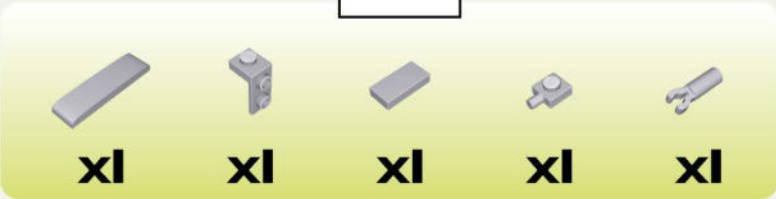

103

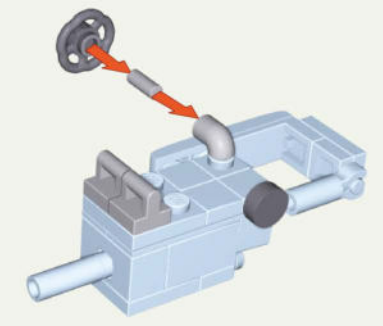

104

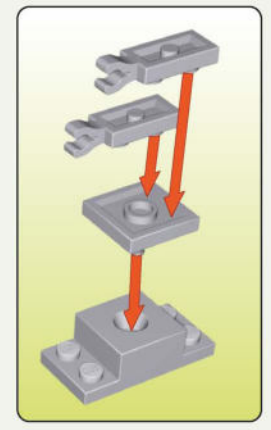
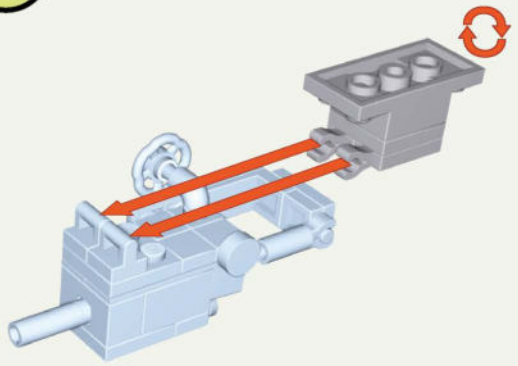



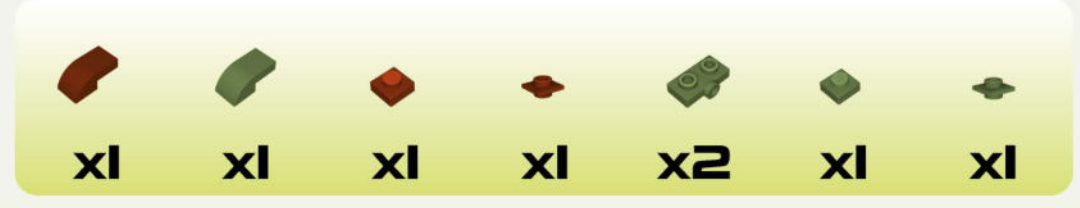
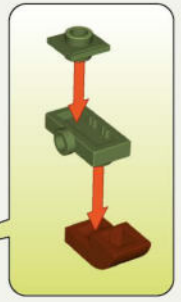
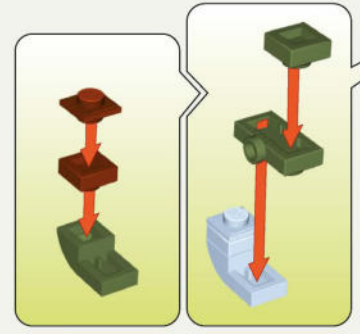
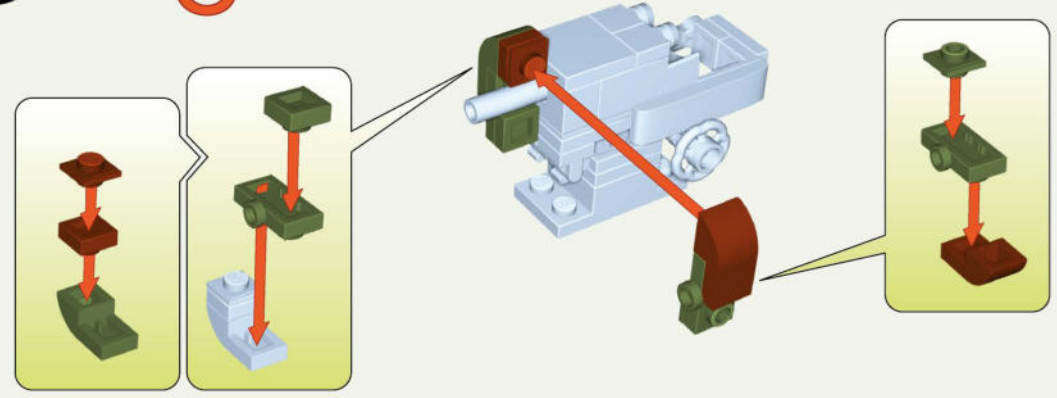

105

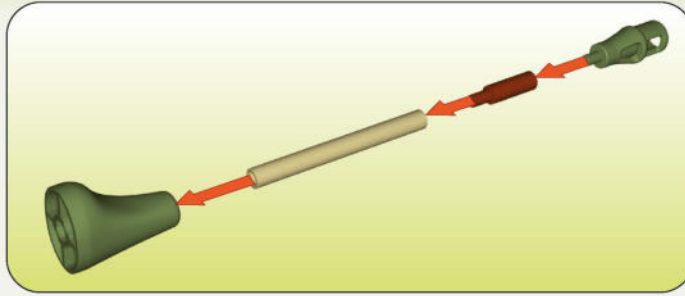
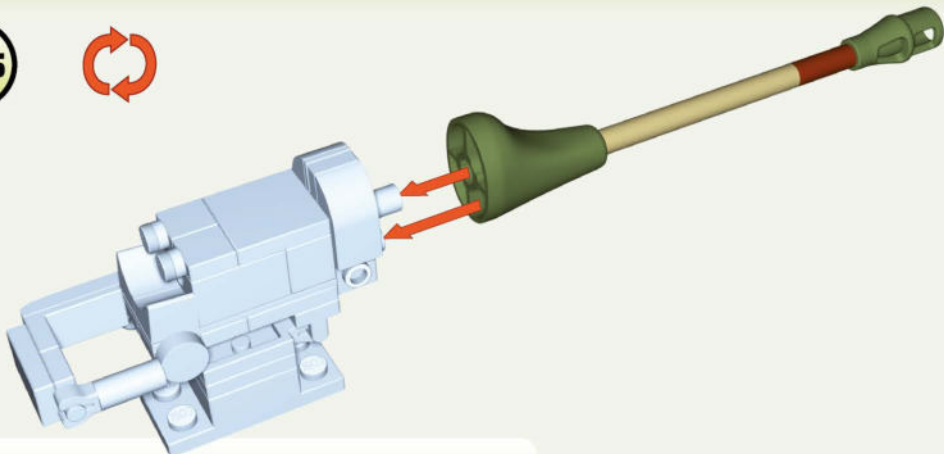

106



 **x1**
  **x1**
  **x1**
  **x1**

107

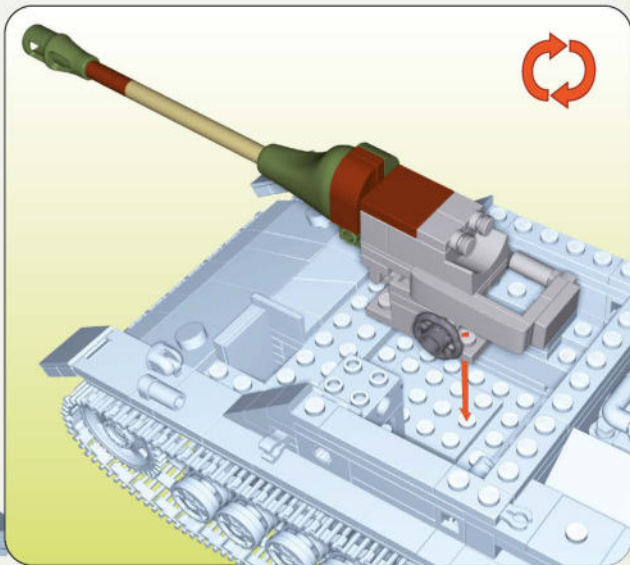
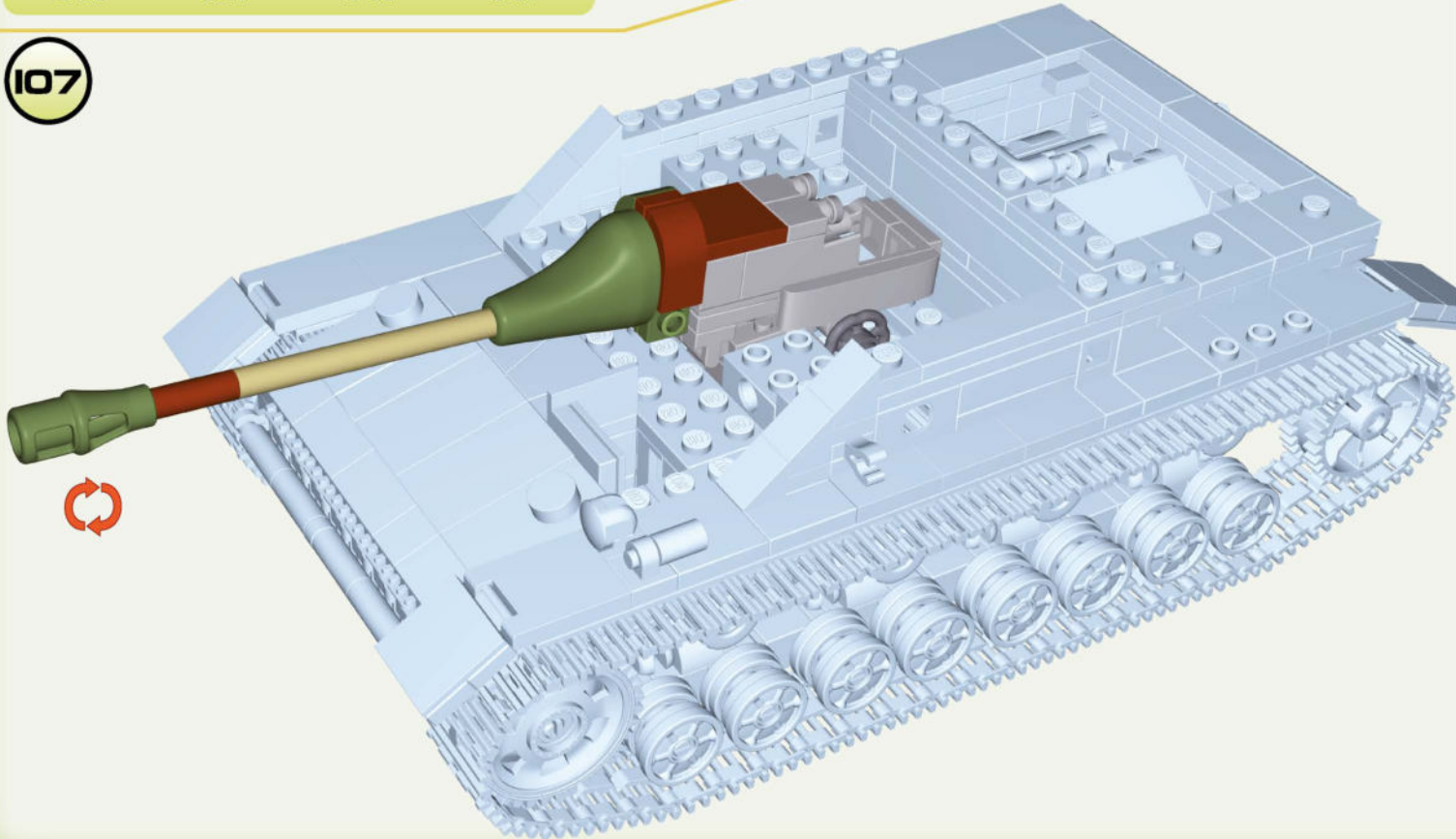

108

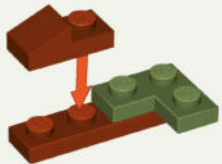

109

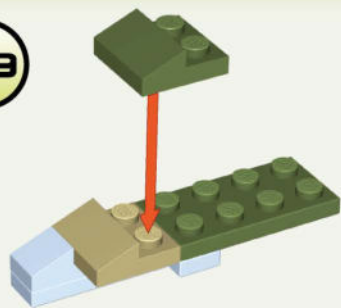

110

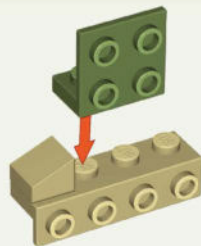

111

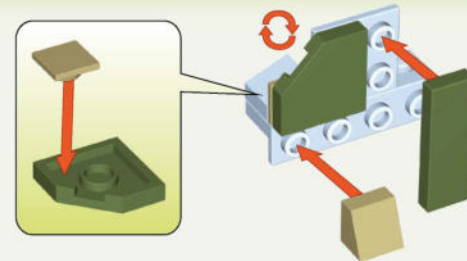

1:1

112

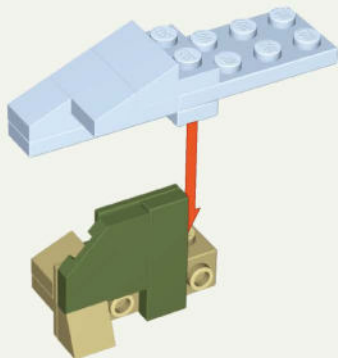





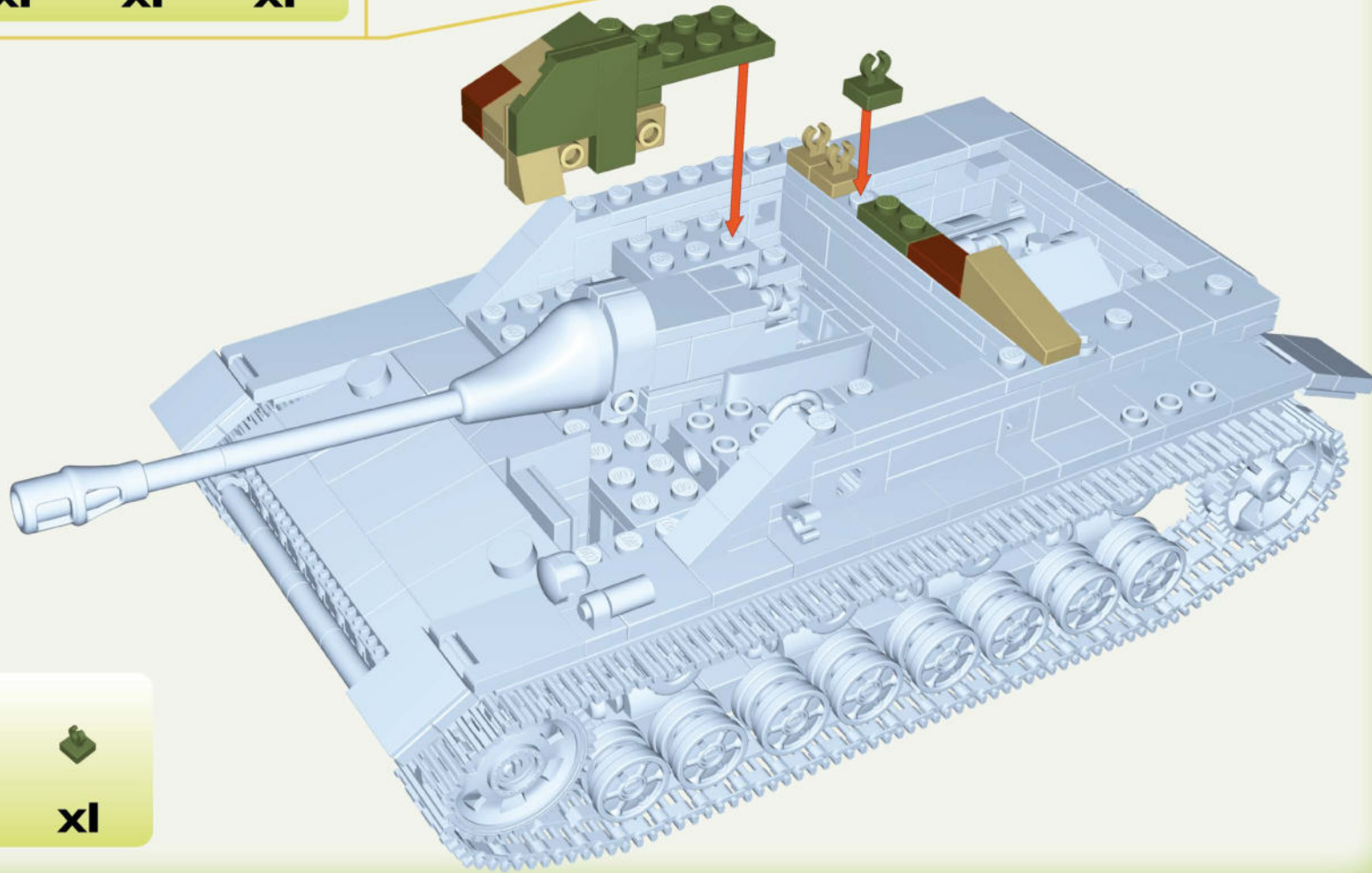

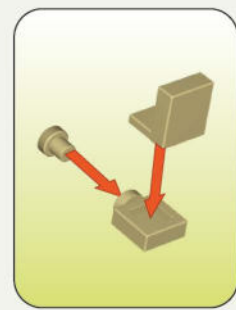
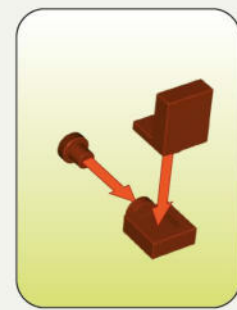
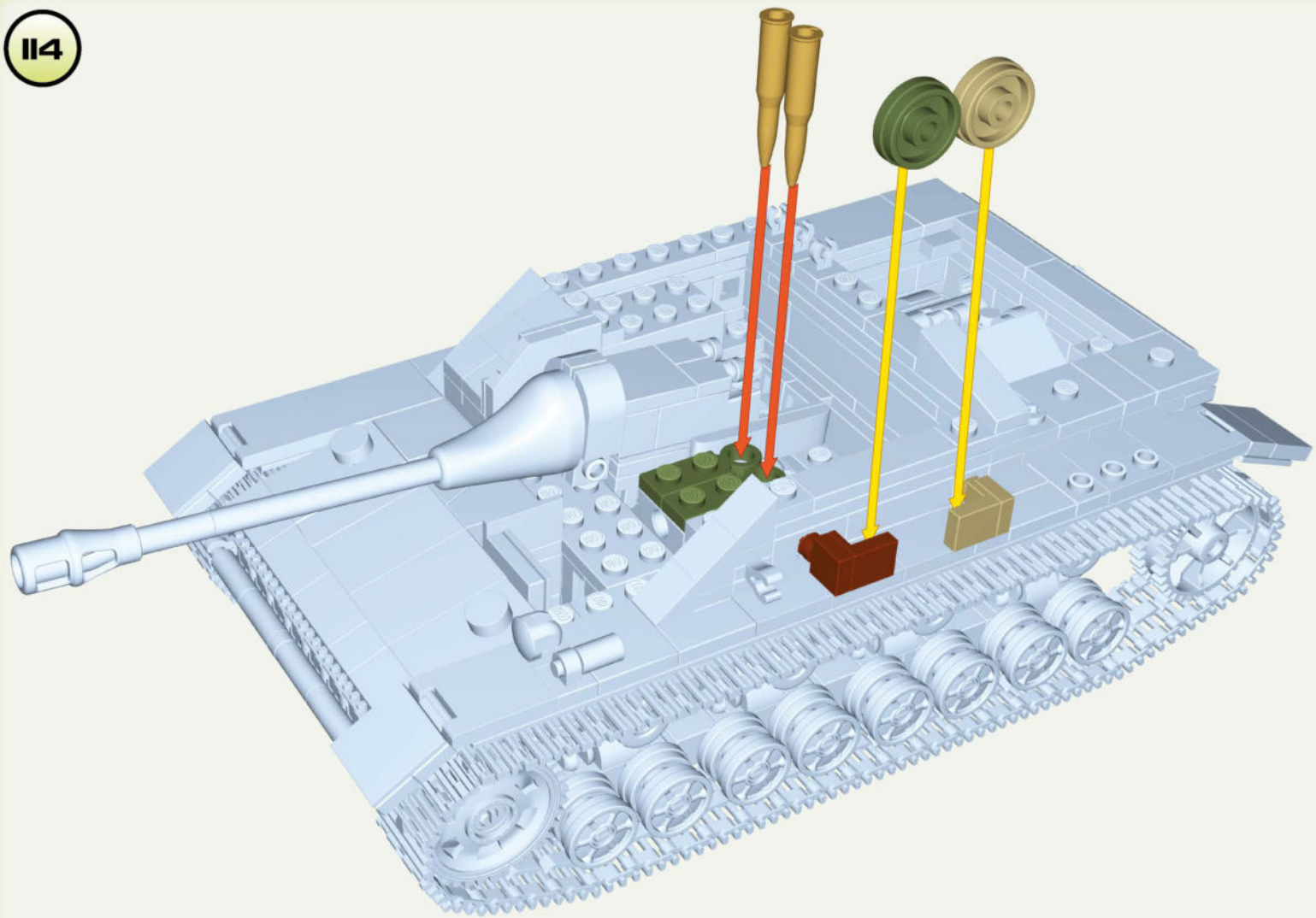



113

1:1





- | | | | | |
|---|---|---|---|---|
|  |  |  |  |  |
| x2 | x1 | x1 | x2 | x1 |
|  |  |  |  |  |
| x1 | x1 | x1 | x1 | x1 |

115

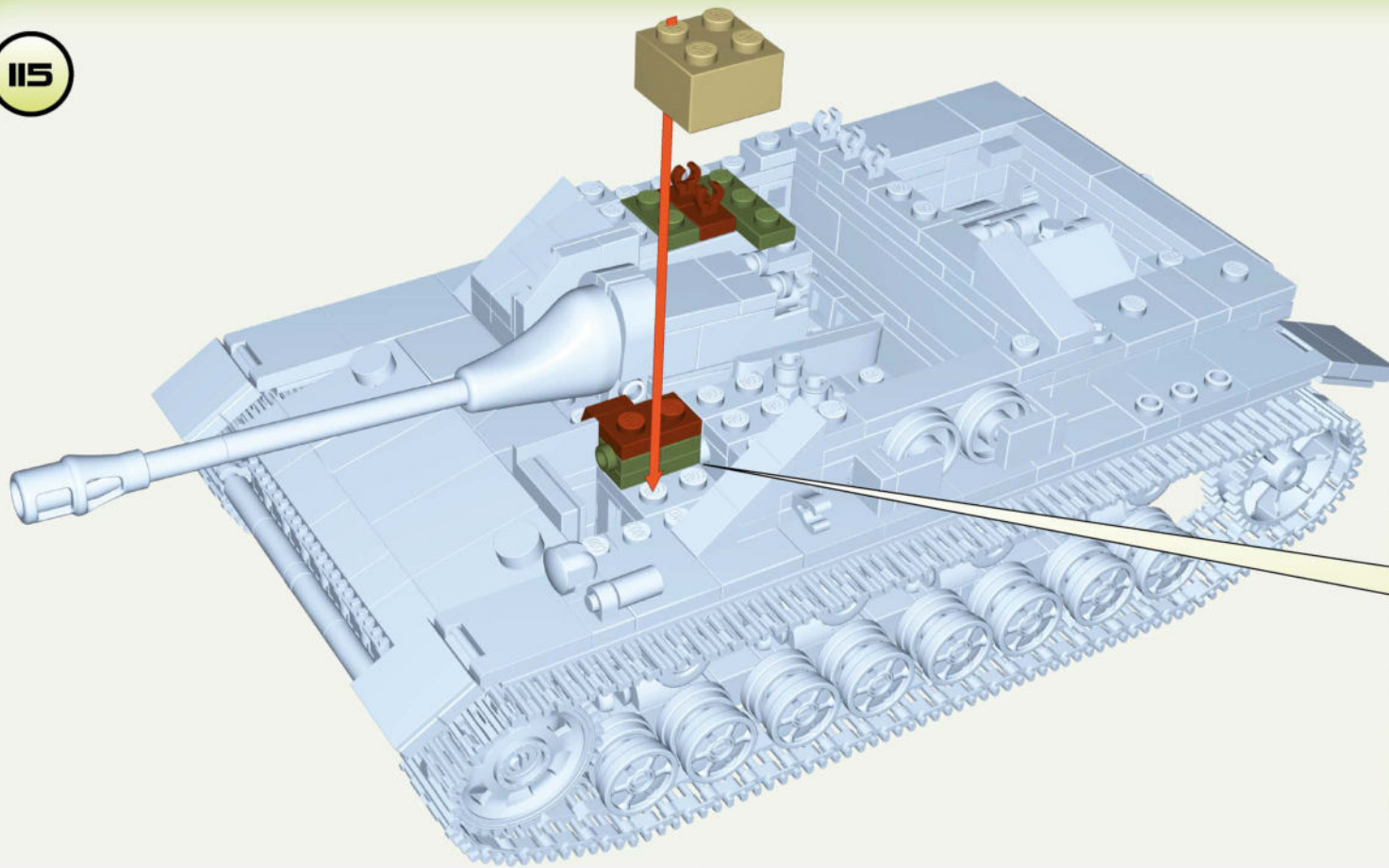

- | | | | |
|----|----|----|----|
| | | | |
| x1 | x2 | x2 | x1 |
| | | | |
| x1 | x1 | x1 | x1 |

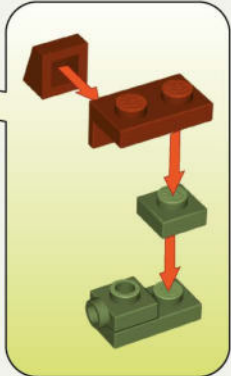

116

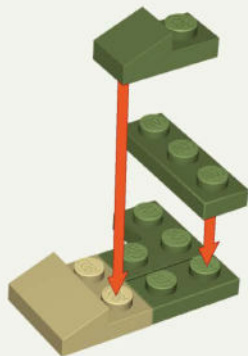

- | | | | | |
|----|----|----|----|----|
| | | | | |
| x1 | x1 | x1 | x1 | x1 |

117

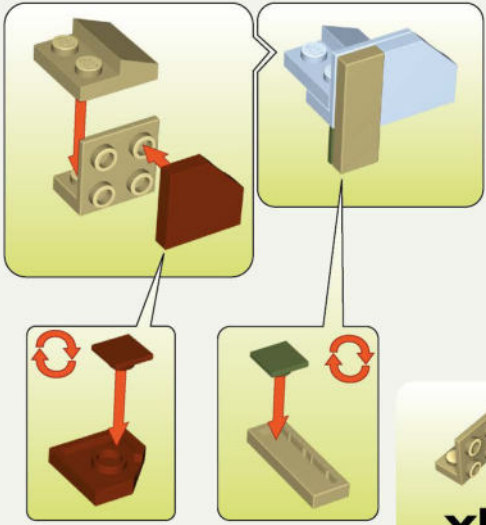

- | | | | | | |
|----|----|----|----|----|----|
| | | | | | |
| x1 | x1 | x1 | x1 | x1 | x1 |

1:1

118

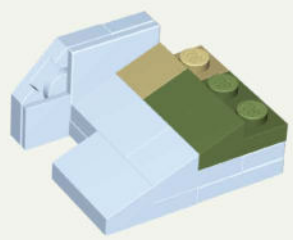



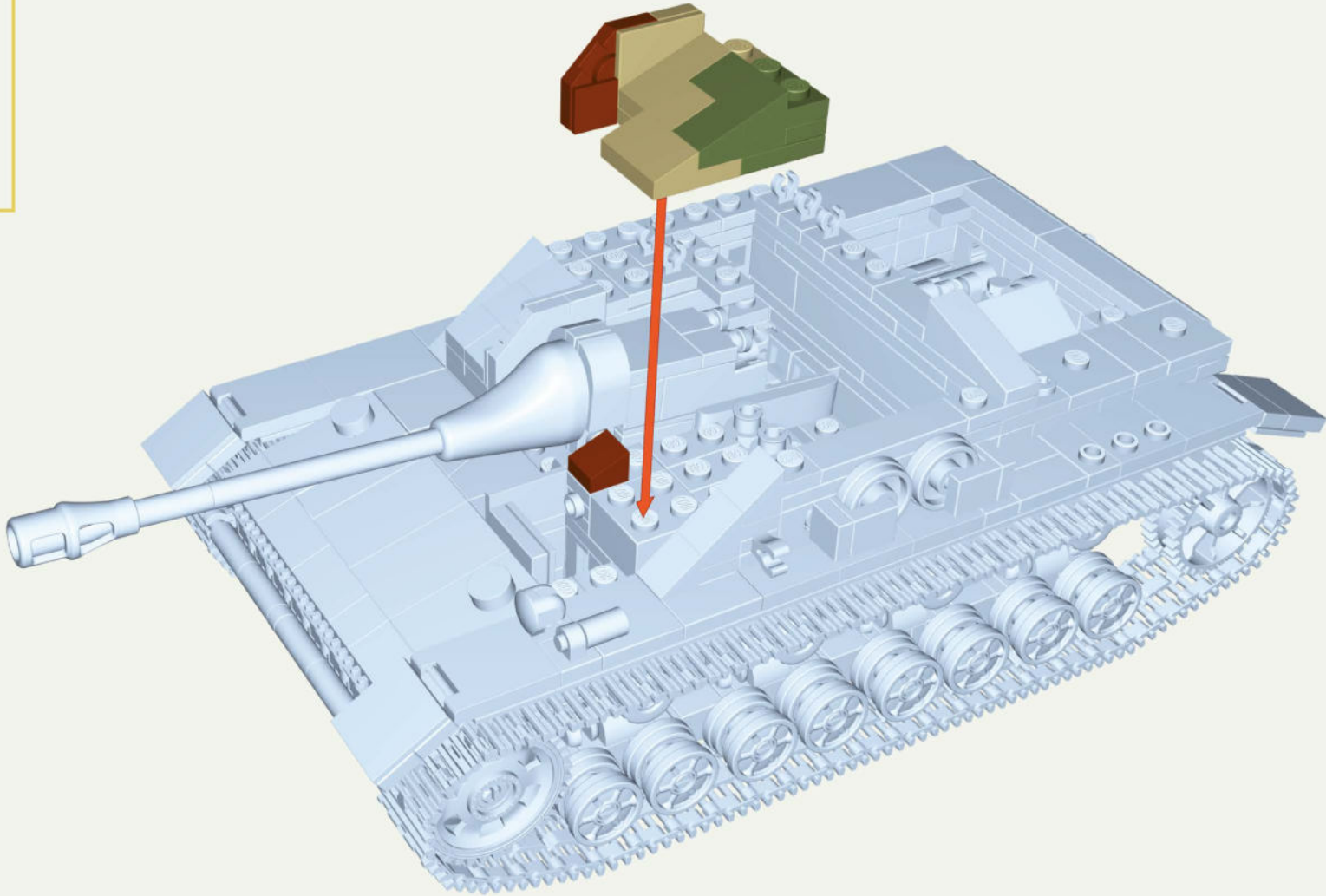

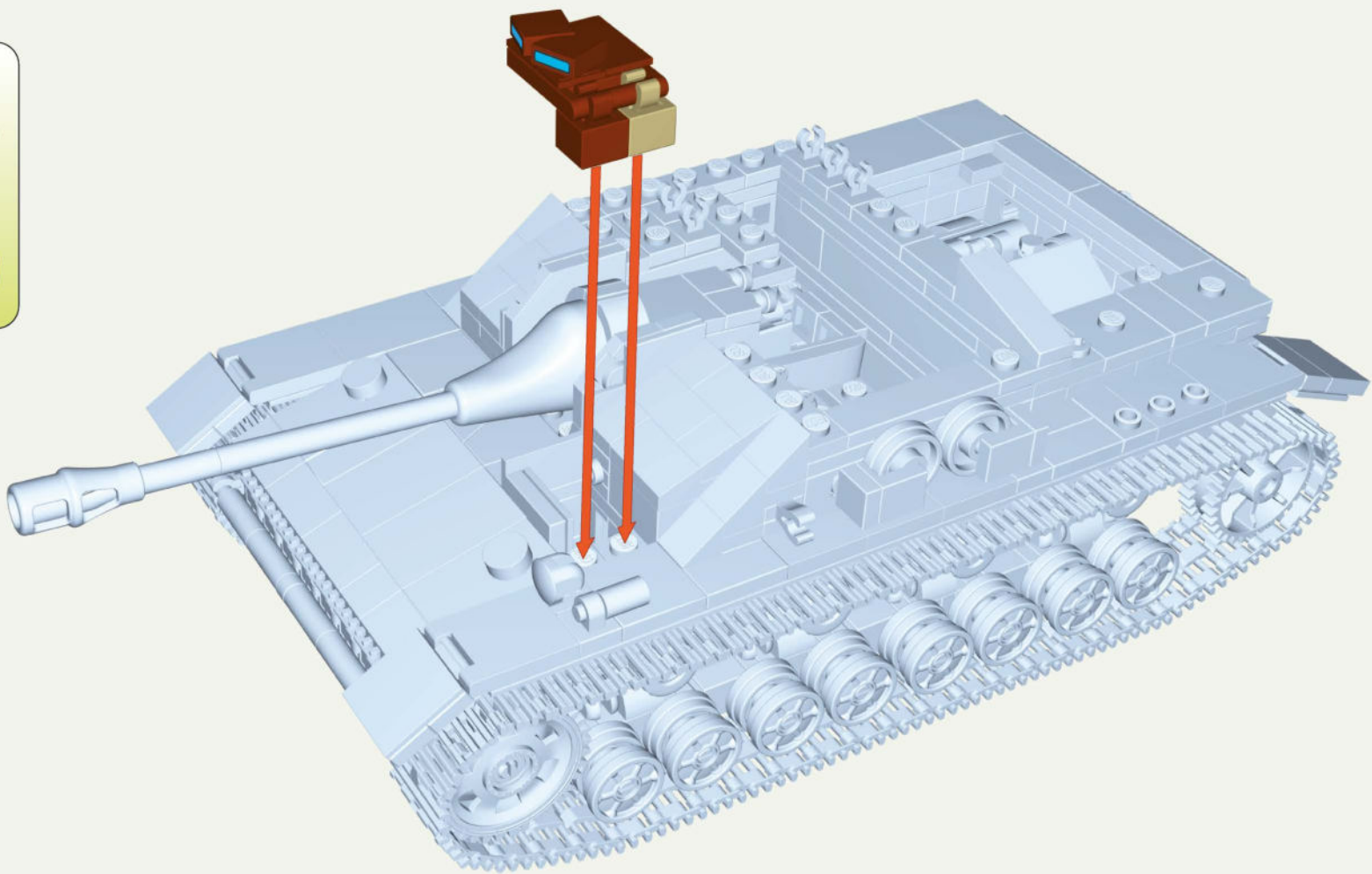
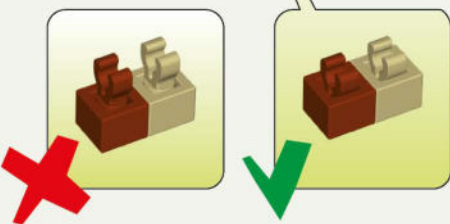
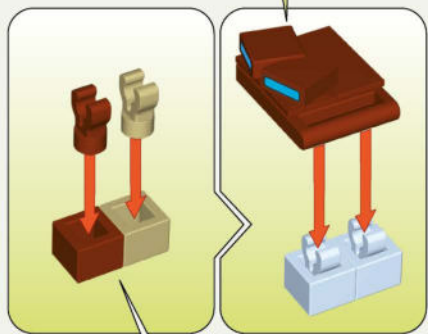
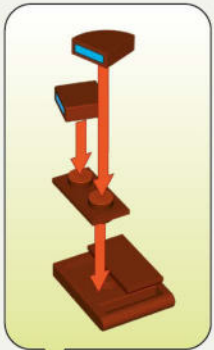

119







- | | | | | |
|----|----|----|----|----|
| | | | | |
| x1 | x1 | x1 | x1 | x1 |
| | | | | |
| x1 | x1 | x1 | x1 | |

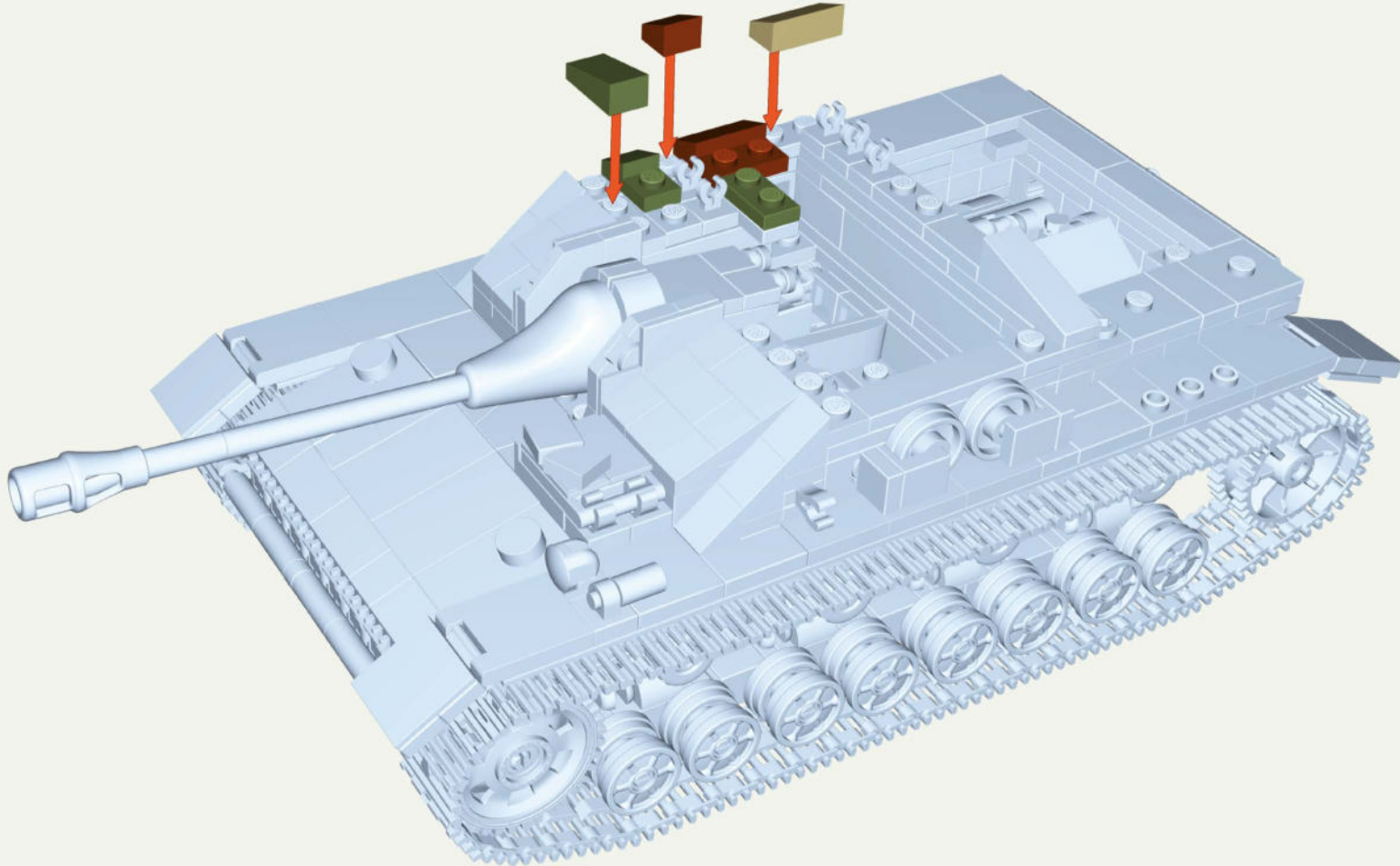

					
x1	x1	x1	x1	x1	x1



			
x1	x1	x1	x1

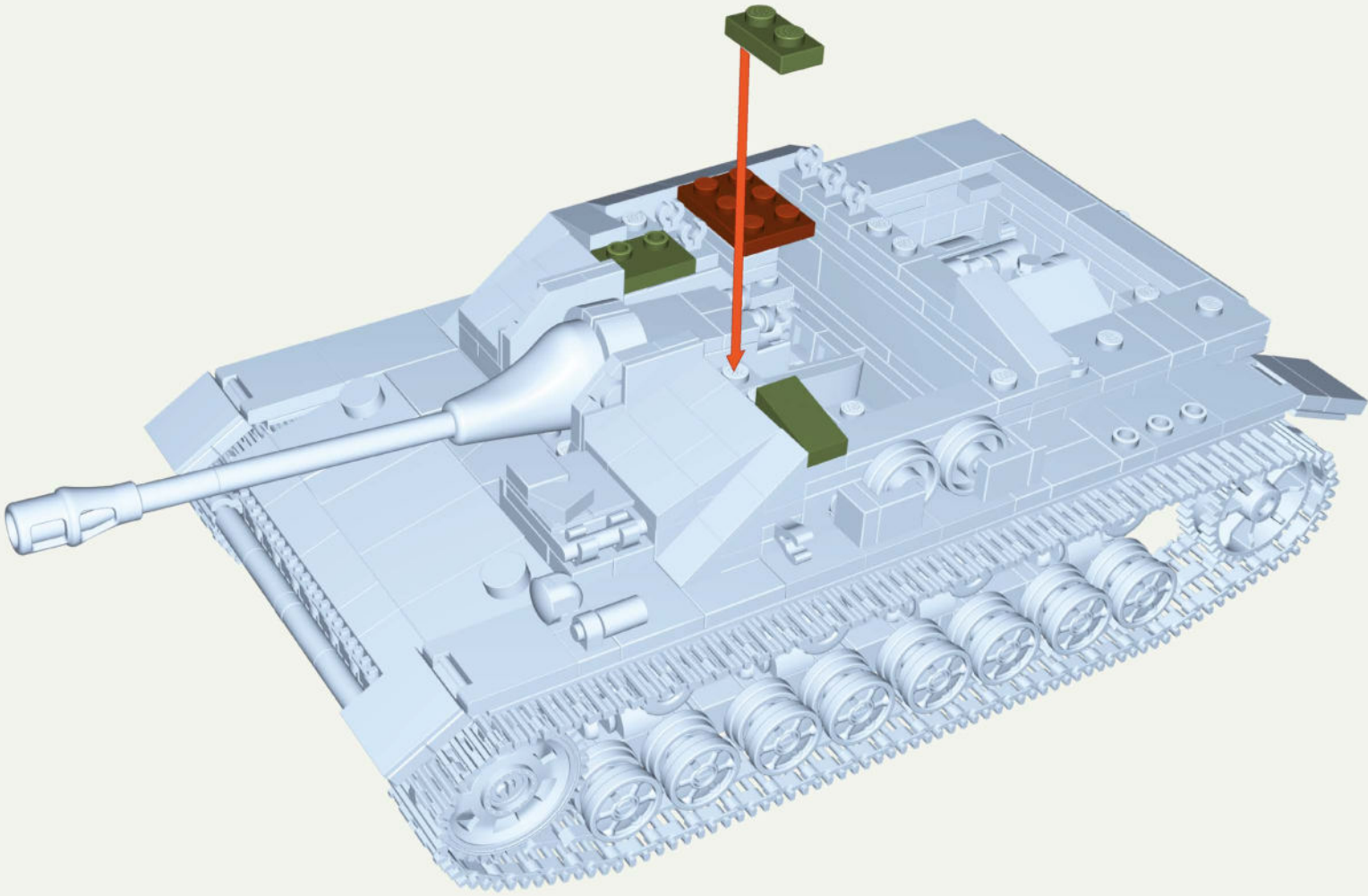

1:1

1:1

-  x1
-  x1
-  x1
-  x1
-  x1
-  x1
-  x1
-  x1
-  x1

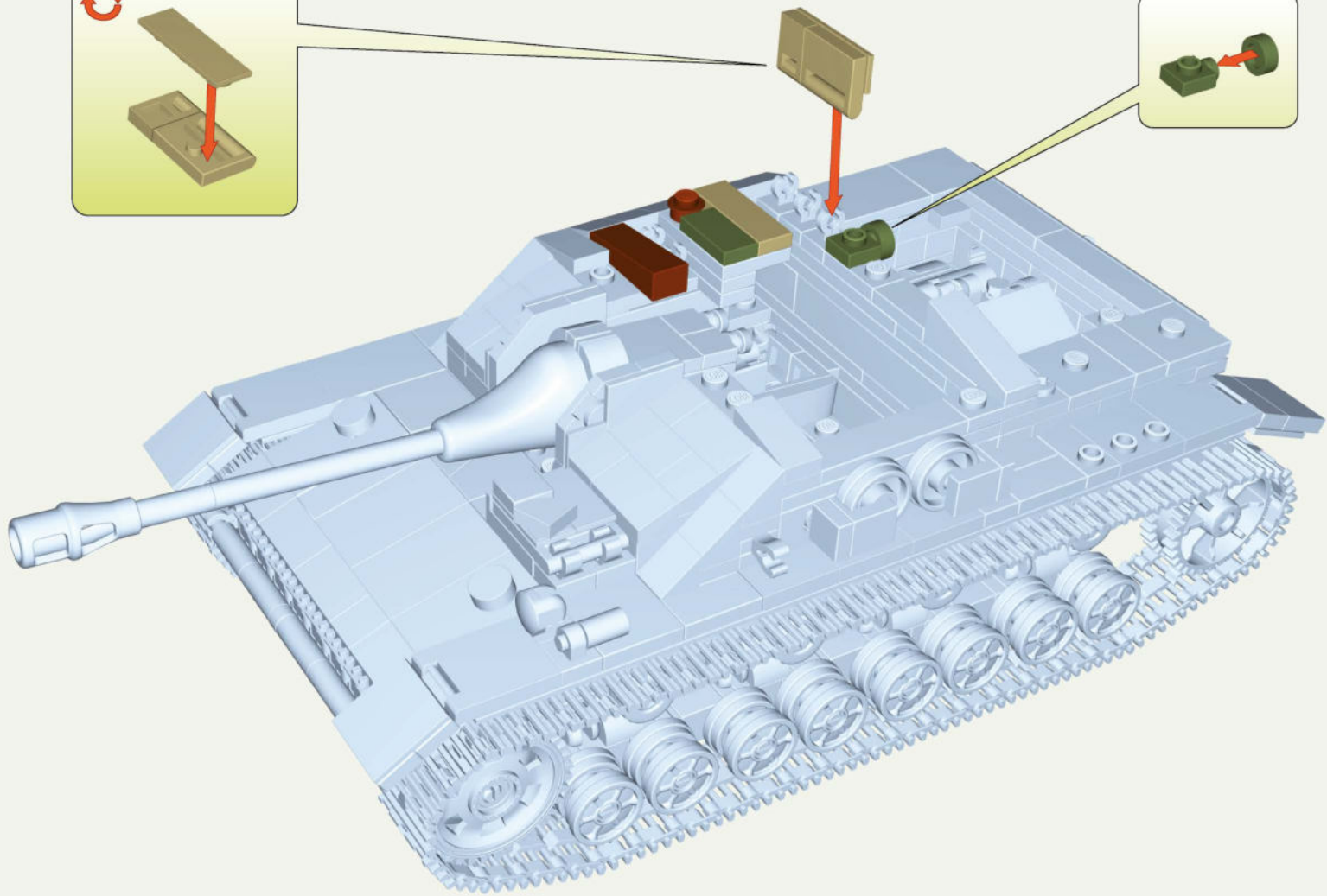
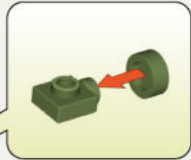
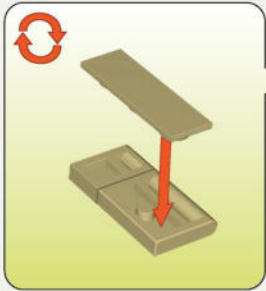

1:1

1:1

-  **x1**
-  **x1**
-  **x1**
-  **x1**
-  **x1**

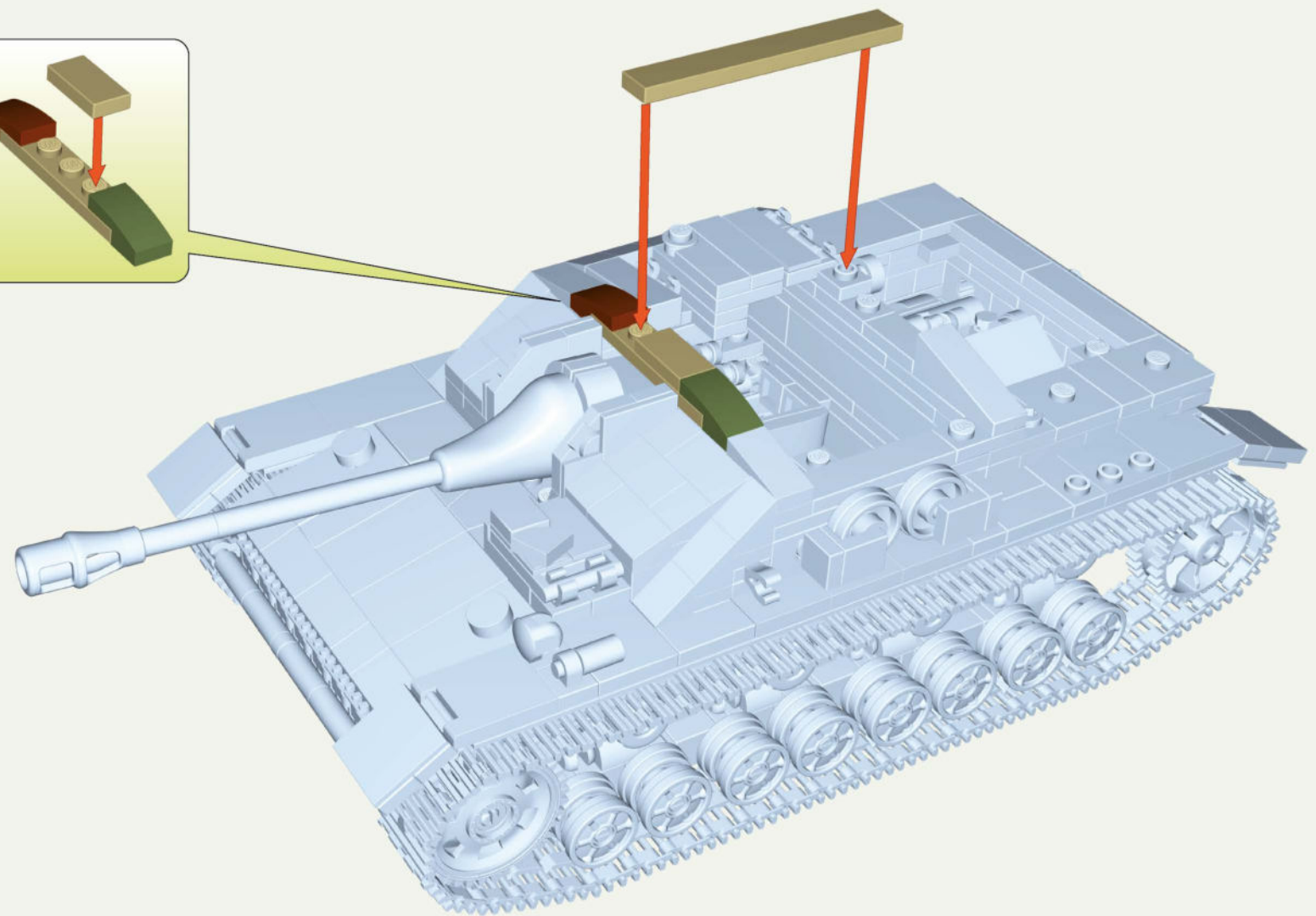
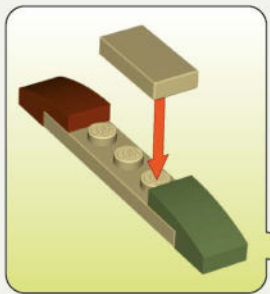

-  **x1**
-  **x1**
-  **x1**
-  **x1**
-  **x1**
-  **x1**
-  **x1**

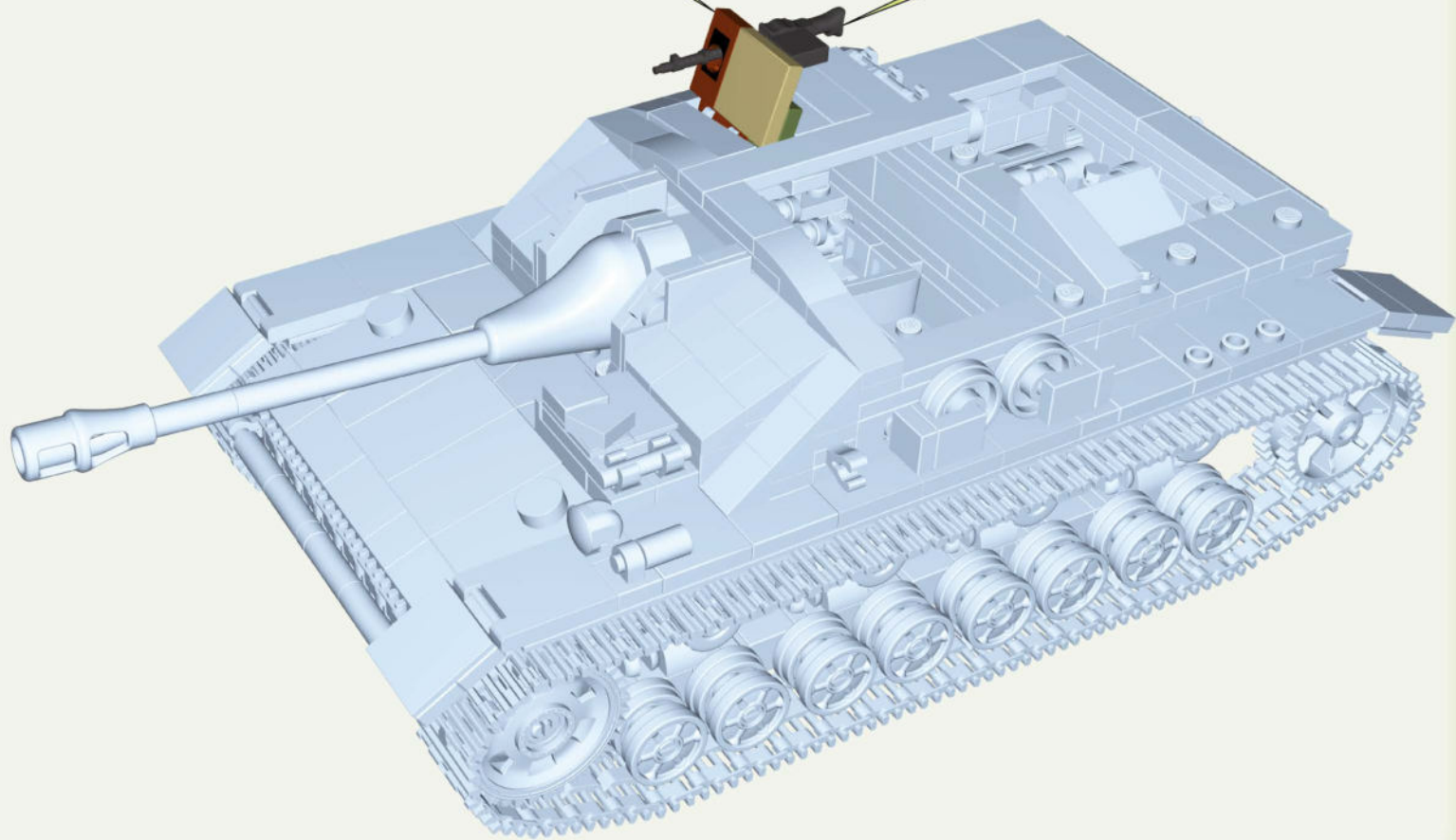
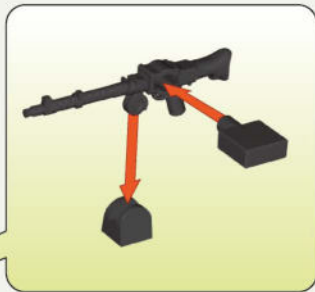
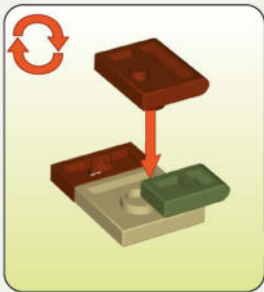
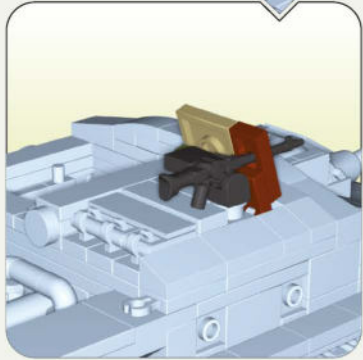
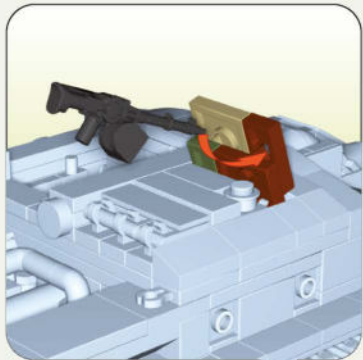

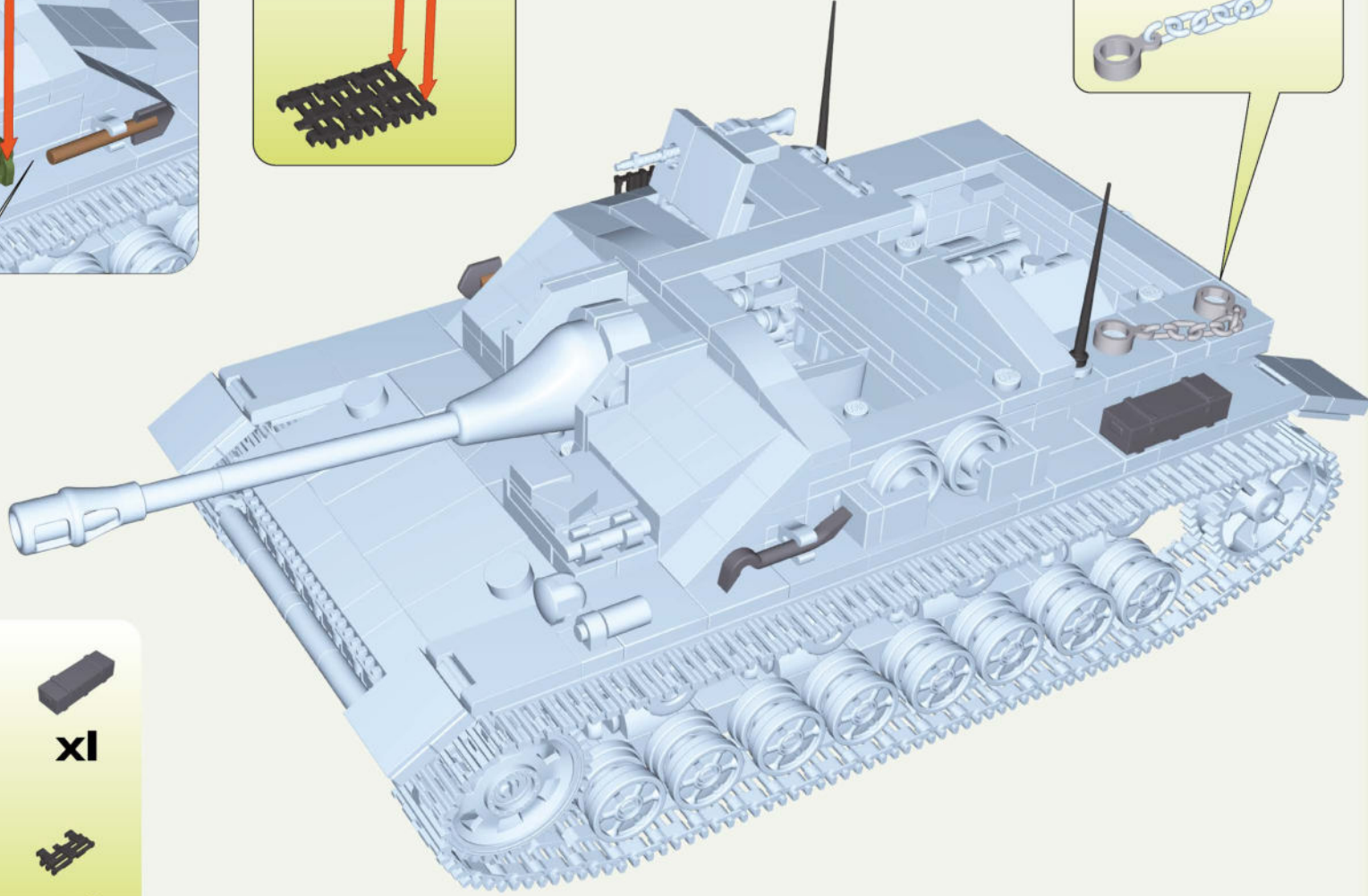
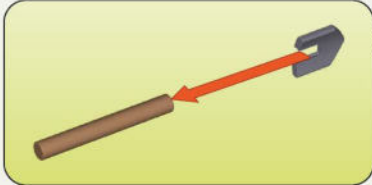
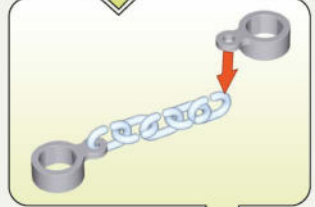
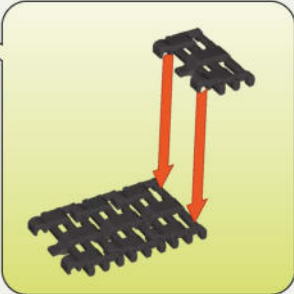
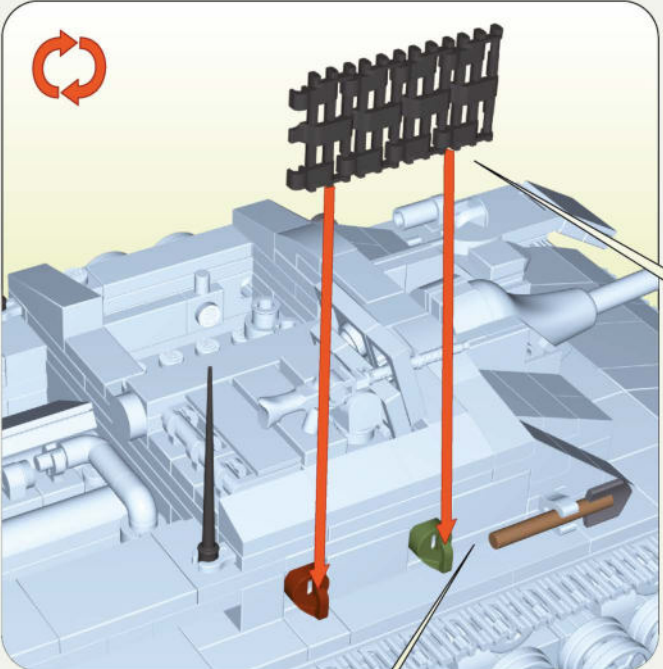

- | | | | | |
|---|---|---|---|---|
|  |  |  |  |  |
| x1 | x2 | x1 | x1 | x1 |
|  |  |  |  |  |
| x1 | x1 | x5 | x2 | x4 |

127



1:1



128

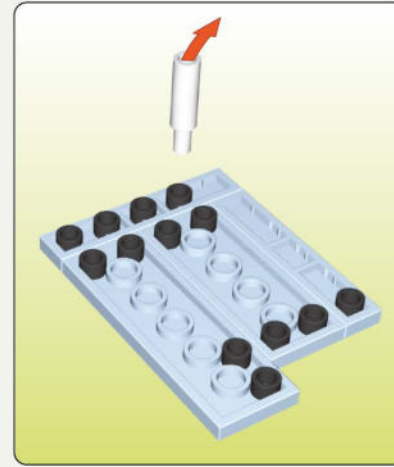
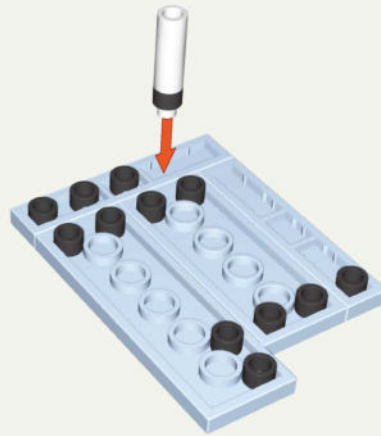

129

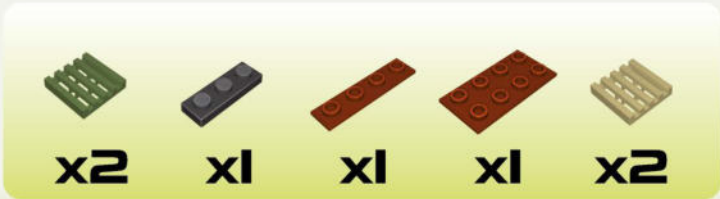
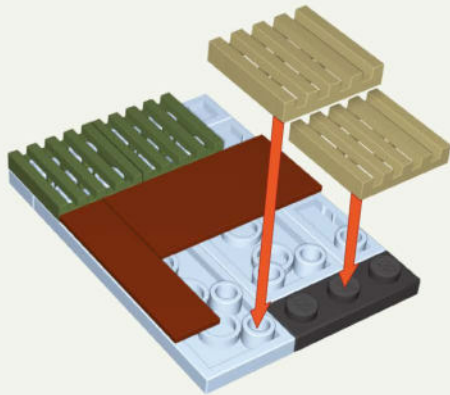

130

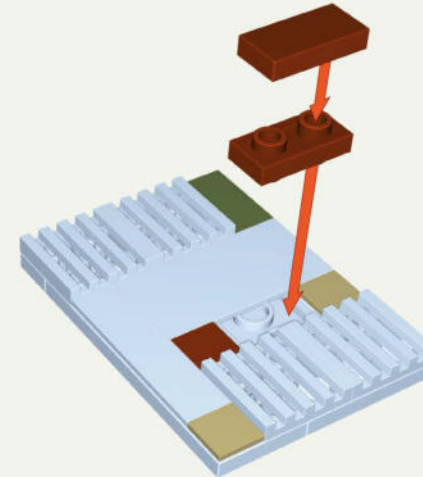

1:1



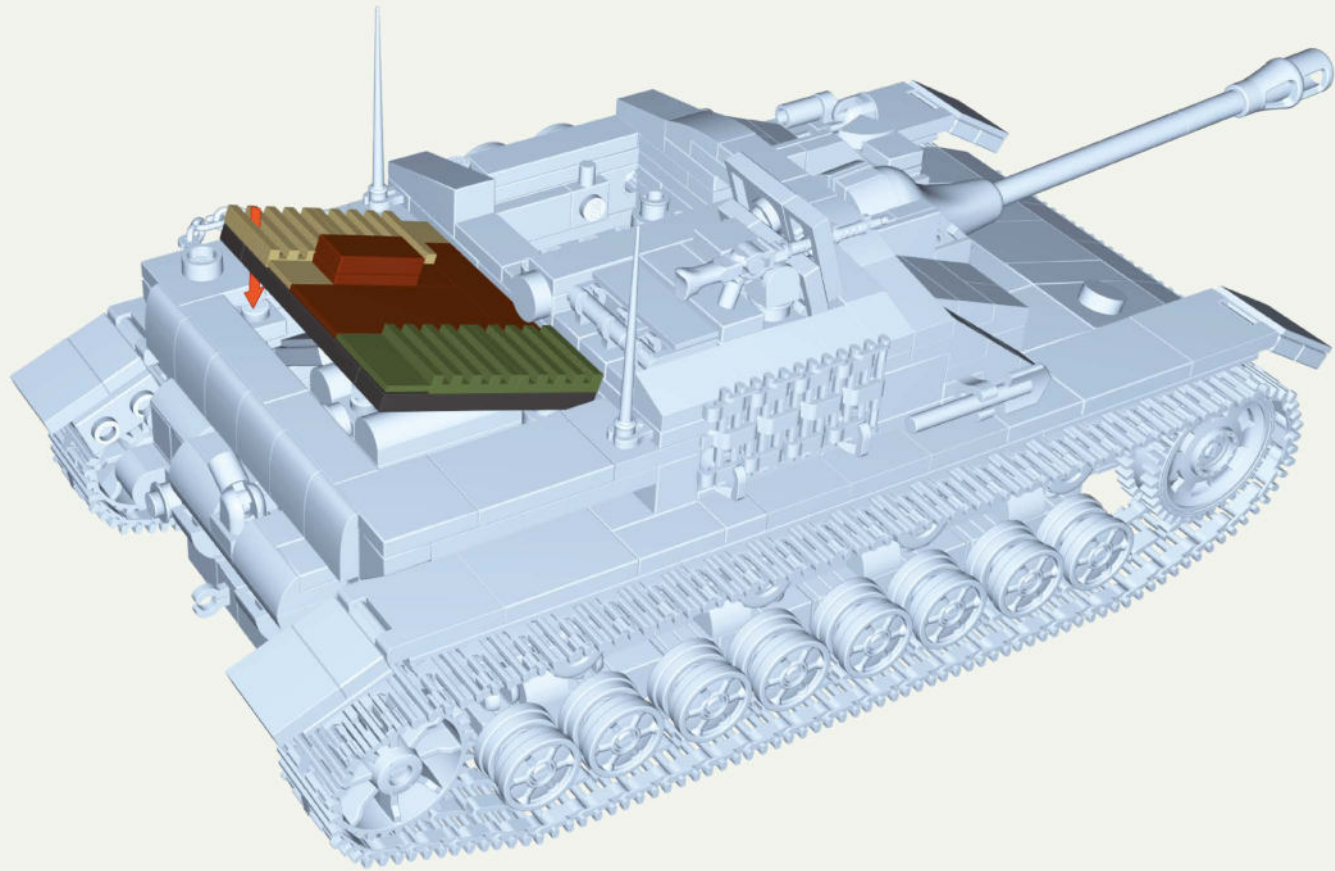

132

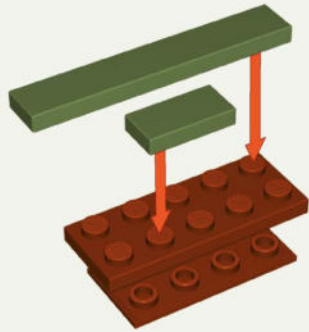

1:1 1:1

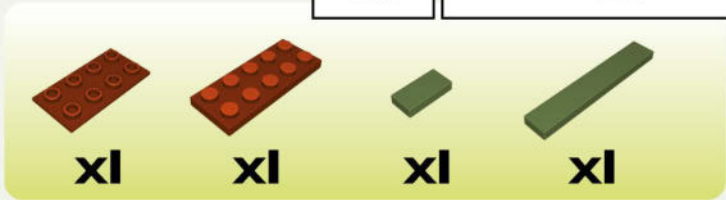

133

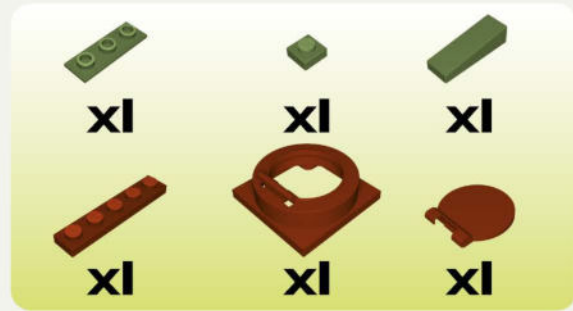
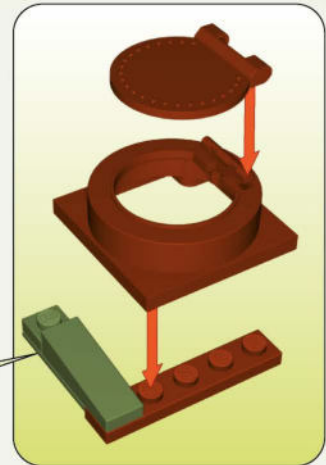
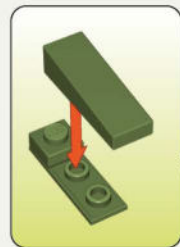
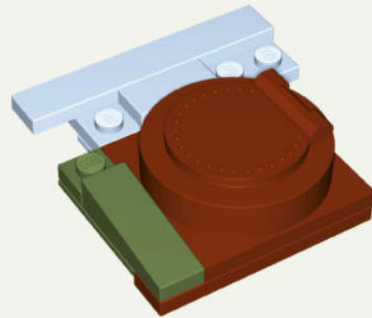

134

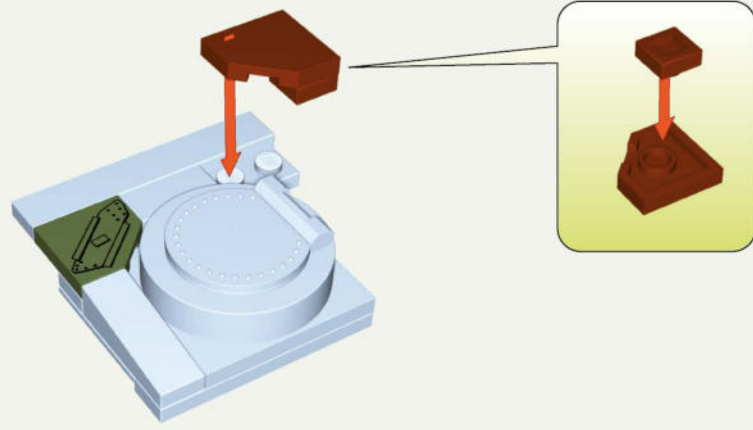

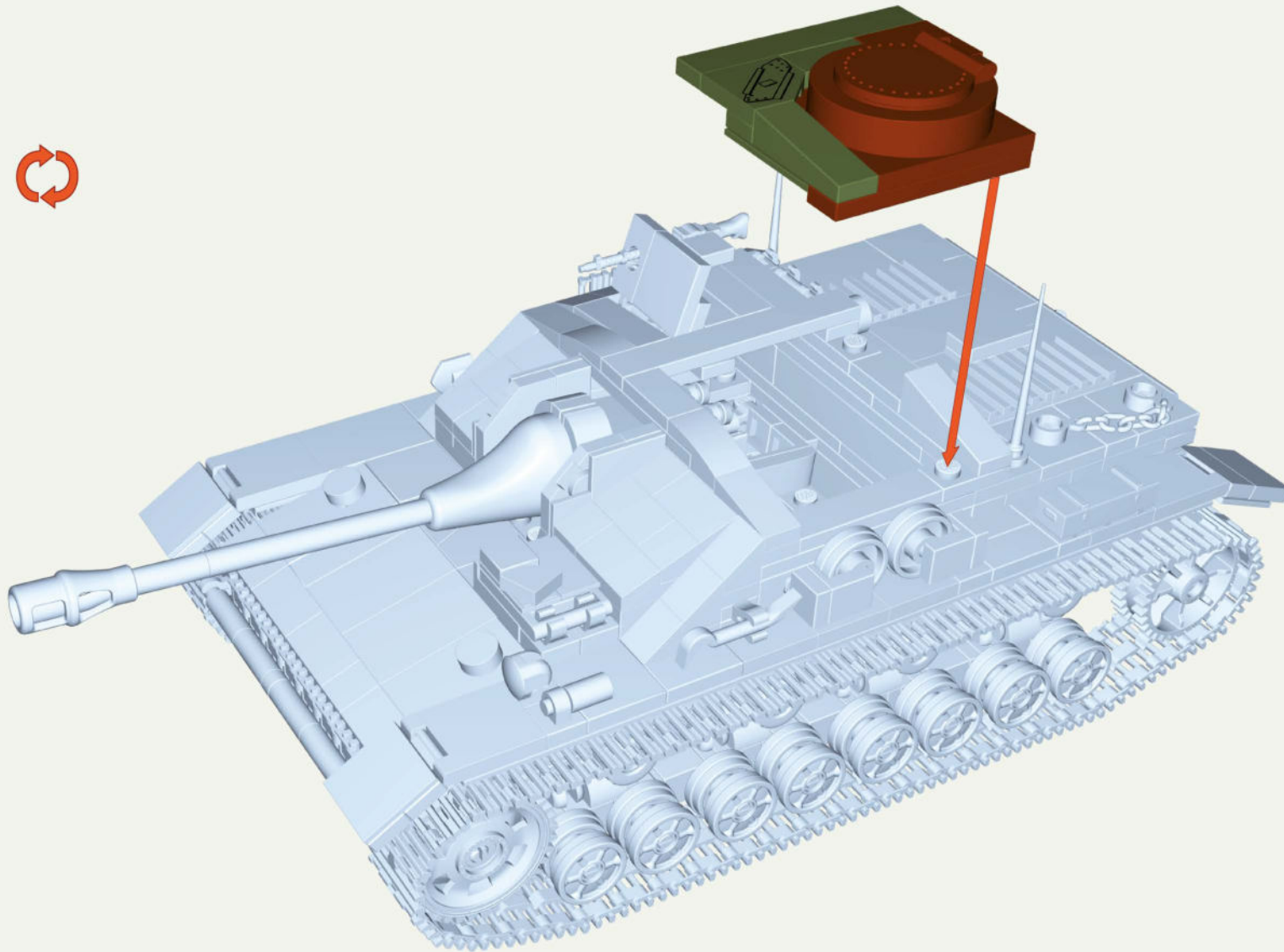

 x2 148879	 x2 157995	 x2 155985	 x2 155433	 x1 128622	 x2 136415	 x1 155036	 x1 155040	 x3 157996	 x1 157997	 x3 97446	 x12 44014	 x1 54631	 x1 155119
 x1 157847	 x1 148876	 x2 86093	 x1 109854	 x1 104128	 x1 119497	 x3 104433	 x1 80459	 x3 77422	 x1 152444	 x2 105092	 x1 152442	 x1 154987	 x1 110007
 x1 128409	 x1 157999	 x2 125256	 x1 127156	 x1 124064	 x3 155012	 x2 96797	 x1 157848	 x5 53169	 x1 52994	 x1 43668	 x2 128408	 x2 98923	 x1 96758
 x1 100990	 x2 119720	 x1 158000	 x1 154949	 x4 150425	 x2 147699	 x1 145256	 x3 155106	 x1 148832	 x2 157988	 x1 152387	 x4 146137	 x1 155141	 x1 130627
 x1 155120	 x2 97505	 x1 44969	 x2 44879	 x4 155122	 x1 105894	 x12 93052	 x1 155111	 x1 104432	 x3 42863	 x3 157998	 x1 128470	 x1 155434	 x1 112793
 x4 97493	 x1 157989	 x2 92239	 x2 156864	 x1 142267	 x1 125894	 x2 57213	 x3 105895	 x2 155100	 x2 44169	 x1 155105	 x2 104427	 x3 99232	 x1 157851
 x1 157849	 x1 157850	 x2 108584	 x2 157990	 x1 132984	 x3 155009	 x1 157991	 x1 128527	 x2 120783	 x1 111084	 x1 155152	 x1 157992	 x10 155978	 x2 153389
 x1 155140	 x3 97495	 x21 42931	 x3 51554	 x3 43671	 x7 154999	 x1 157937	 x1 42913	 x2 157936	 x2 79560	 x2 97936	 x1 42922	 x1 155159	 x1 113533
 x1 113934	 x1 157938	 x2 128416	 x1 106765	 x3 155436	 x2 106764	 x1 124067	 x1 157853	 x5 97447	 x6 45540	 x1 45448	 x2 155109	 x1 97499	 x3 94039
 x3 155610	 x1 125376	 x13 150432	 x1 148827	 x7 132329	 x1 155153	 x2 91750	 x1 60322	 x5 42952	 x1 117804	 x2 148878	 x3 106342	 x2 155114	 x2 104434

x2 83632	x1 157939	x1 128968	x2 157935	x3 42895	x2 157994	x15 42905	x1 112869	x1 155045	x2 111484	x2 157940	x2 81905	x1 155150	x1 154970
x4 111481	x1 155110	x1 157972	x3 132618	x1 157973	x1 113942	x1 107729	x1 157974	x4 97496	x1 42957	x5 42959	x1 57130	x2 155000	x1 97458
x1 93457	x1 157854	x2 155107	x3 148820	x4 115502	x2 155156	x1 154943	x1 44877	x1 157975	x1 147990	x1 157976	x3 109733	x1 155101	x4 97457
x1 45208	x5 42976	x1 105051	x1 42985	x3 42991	x3 157977	x1 157979	x2 157978	x1 97459	x1 155050	x7 157980	x7 91991	x6 156897	x1 128274
x1 117836	x1 42967	x2 157855	x1 125344	x1 157861	x1 157981	x1 85406	x1 157982	x2 128844	x6 148707	x2 148706	x2 97475	x5 67985	x2 155089
x2 90219	x1 135762	x1 117805	x3 43017	x1 83478	x1 43006	x1 157983	x2 128843	x4 155443	x1 97506	x3 74222	x1 156904	x2 97468	x1 97472
x1 155076	x10 43048	x1 157993	x3 43041	x1 128121	x1 98207	x1 43084	x1 51597	x1 43685	x1 157986	x1 99305	x2 105867	x5 43100	x1 53201
x1 112618	x1 108154	x2 97502	x1 43114	x2 156874	x2 54893	x2 156831	x2 128413	x4 111485	x4 155077	x1 45467	x1 155147	x1 157856	x2 157987
x1 118379	x1 77561	x1 156885	x2 79715	x2 148825	x7 124559	x6 156862	x1 43687	x2 157941	x1 151230	x1 155167	x1 157985	x1 43057	x1 104131
x1 97481	x1 62886	x1 158001	x1 117451	x1 155103	x1 67979	x1 45452	x1 138843	x4 97487	x4 43154	x2 155088	x1 97489	x1 86989	x2 155054





FIELD KITCHEN (HF.14)

+ 2290



H.M.C M8 SCOTT

★ 2279



MARDER III Ausf. M

+ 2282



Sd.Kfz. 251/9 "STUMMEL"

+ 2283



10,5cm leFH 18

+ 2292



Sd.Kfz.7 HALF-TRACK

+ 2275

HISTORICAL COLLECTION