

HISTORICAL COLLECTION

WORLD WAR II



**LIMITED
EDITION**



IS - 2
 IN SERVICE - 1943 - 1945
 PLACE OF ORIGIN - SOVIET UNION
 TYPE - HEAVY TANK
 WEIGHT - 46t (101400Lb)
 ARMOUR - 30-120mm (1.2" - 4.7")
 ARMAMENT - 1x 122 mm D-25T,
 3x 7,62MM (.3") DT MG
 ENGINE - V-2-10 (V-215), 382kW (520HP)
 MAX SPEED - 37KM/H (23MPH)
 RANGE - 240KM (150MI)
 CREW - 4

2577

Printed in EU

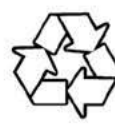

WARNING: CHOKING HAZARD-
 Toy contains small parts.
 Not for children under 3 years.

1176 2

IS-2 BERLIN 1945

SCALE **1:28**



BE CAREFUL: NOTICE THE DIFFERENCE



1

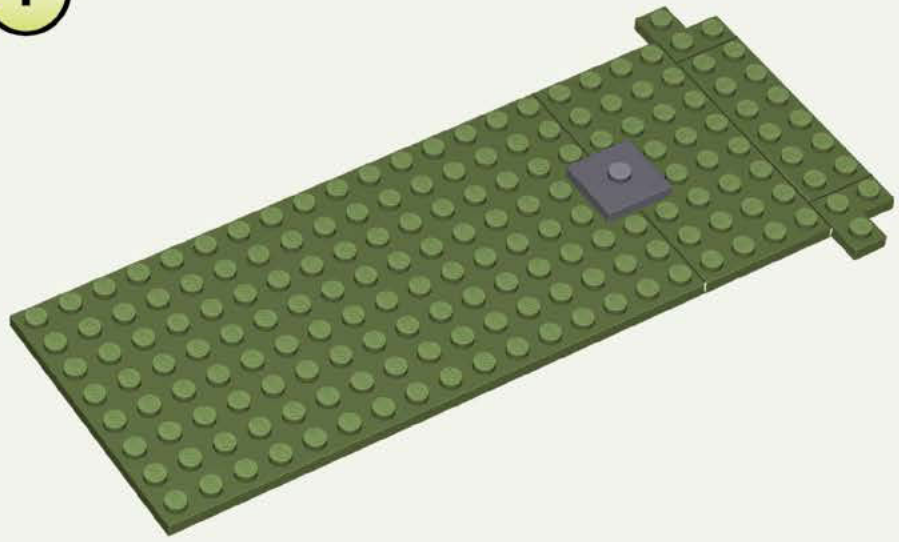

2

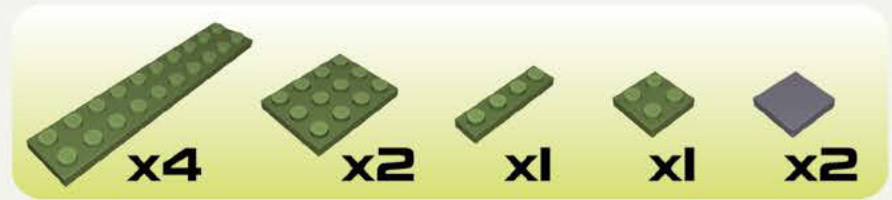
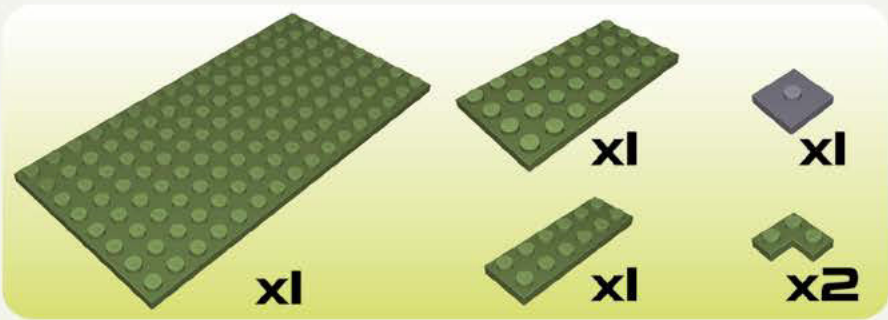
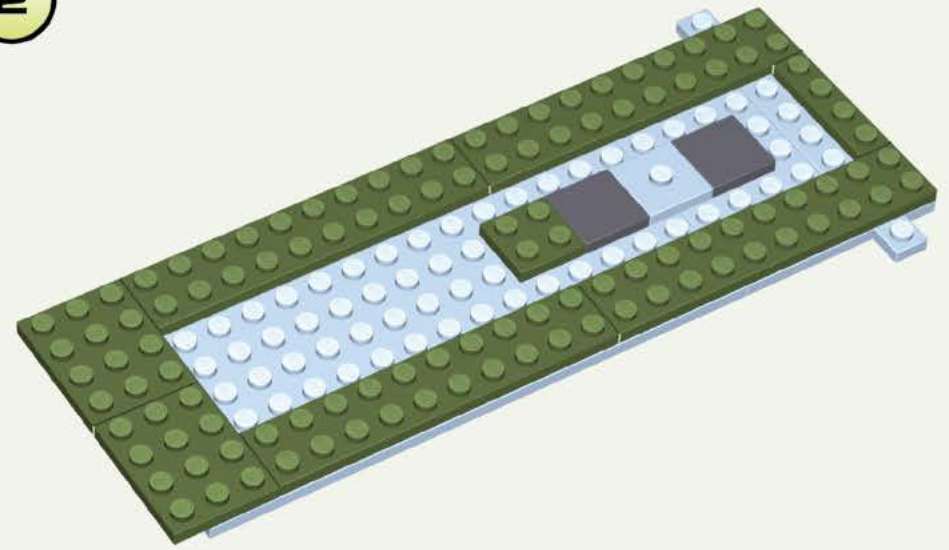

3

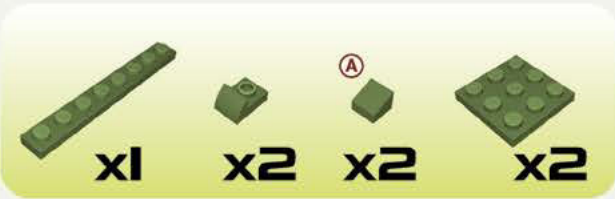
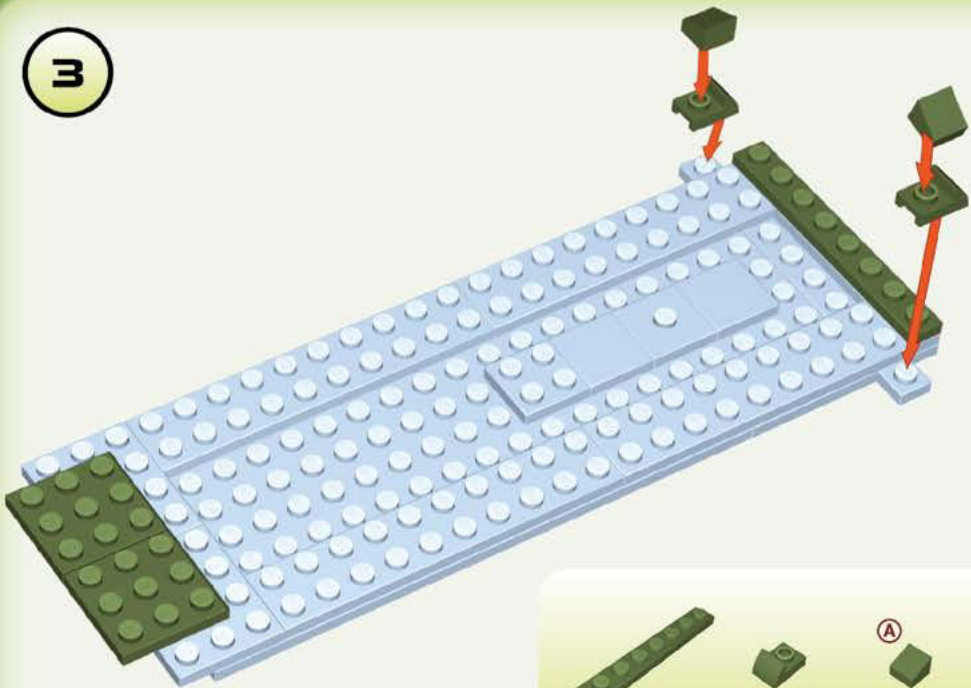

5



4

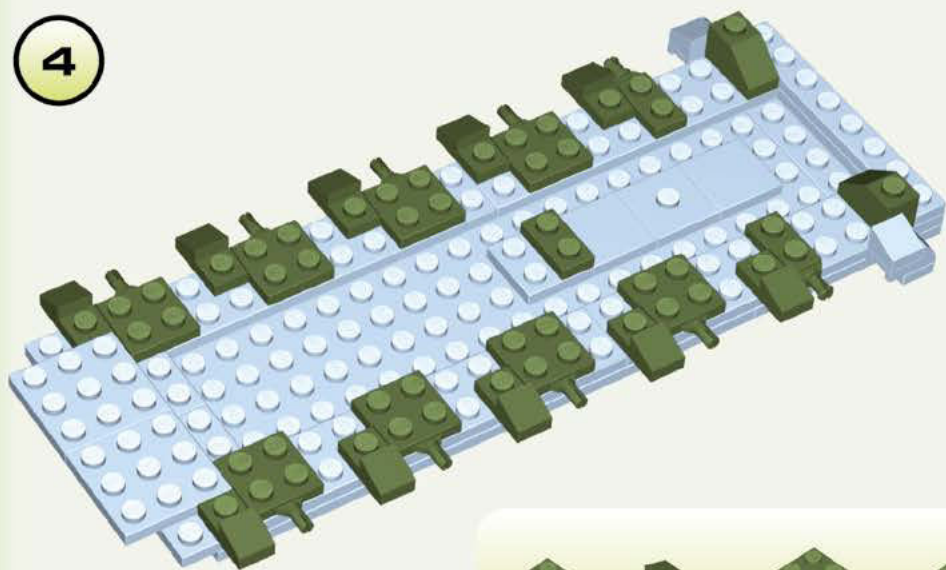

6

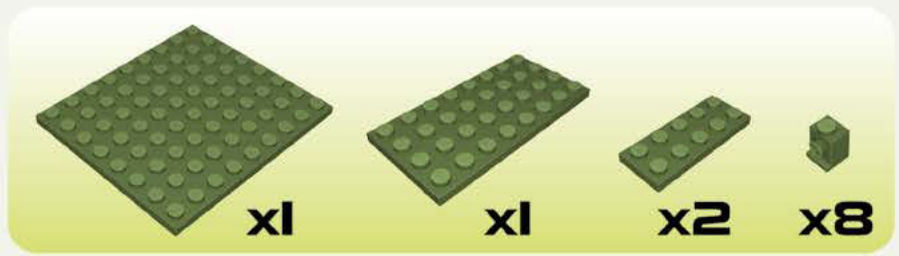
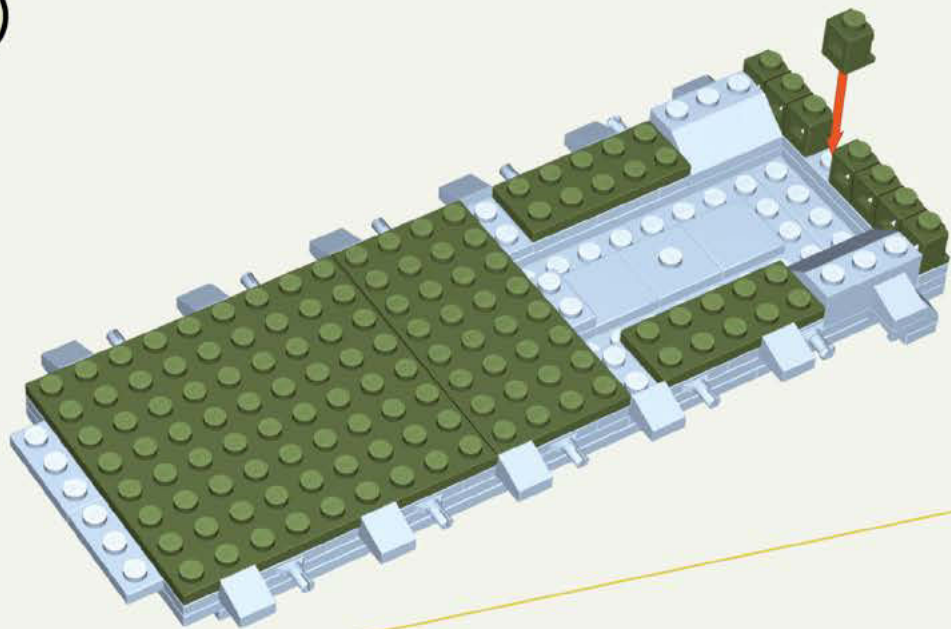

7

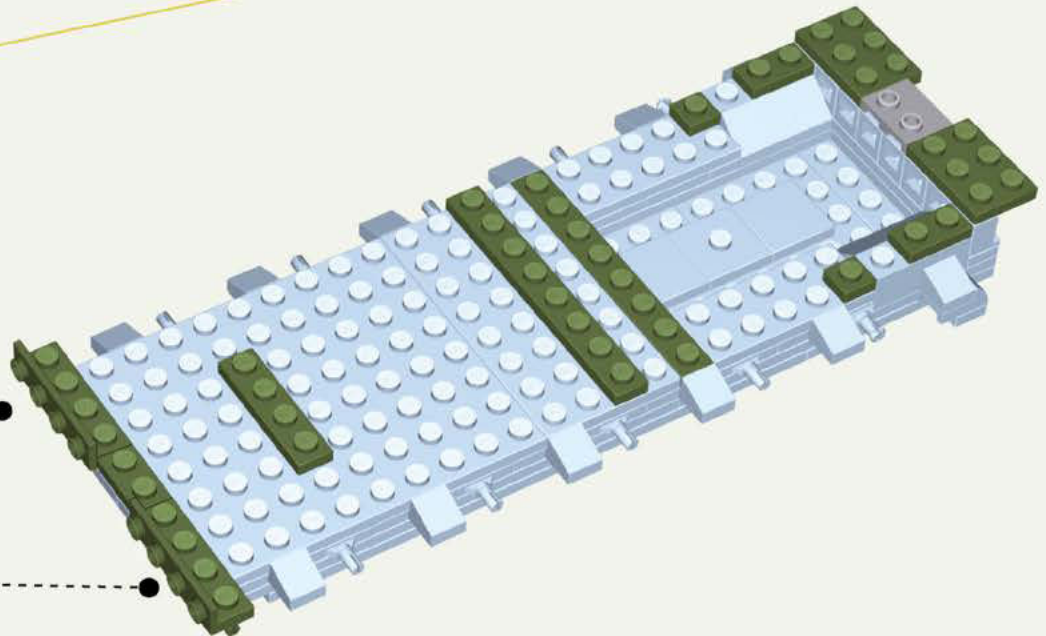
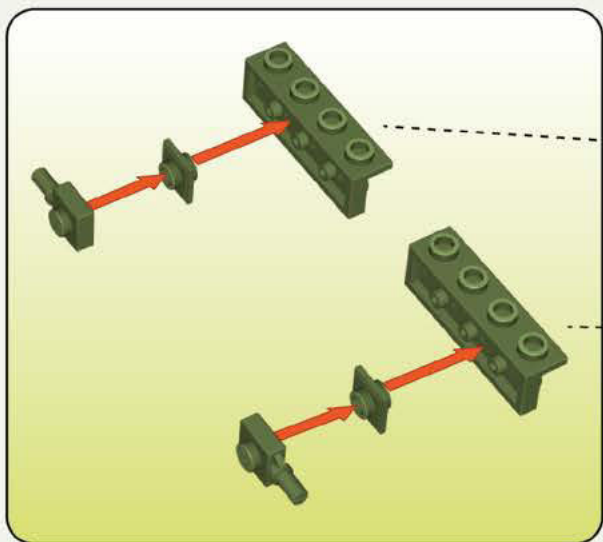

8

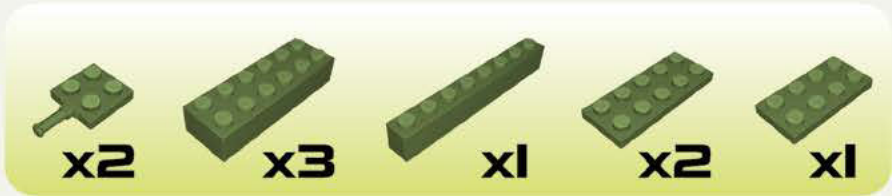
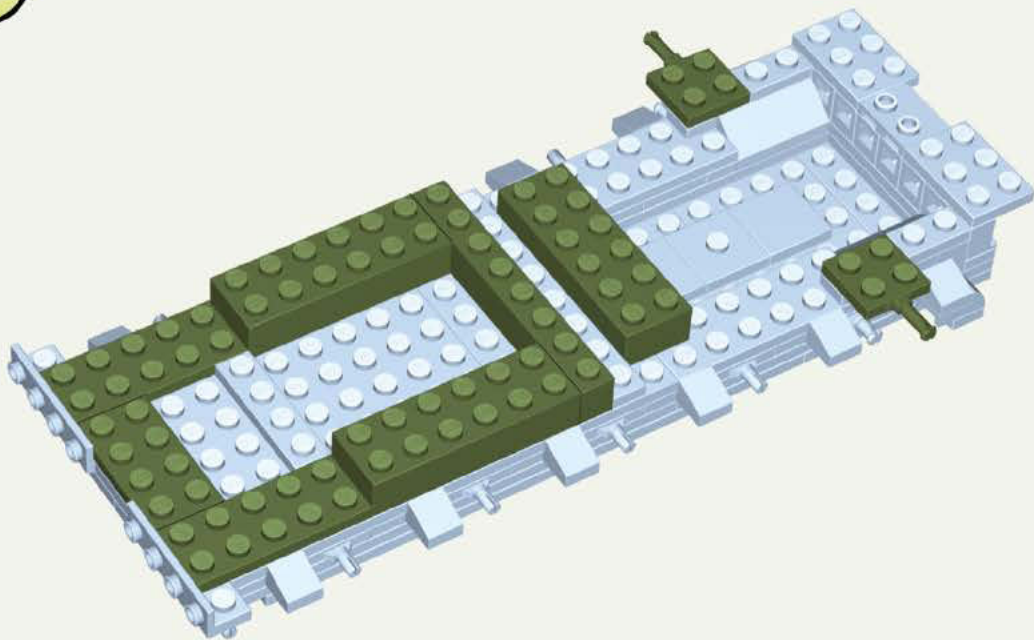

9

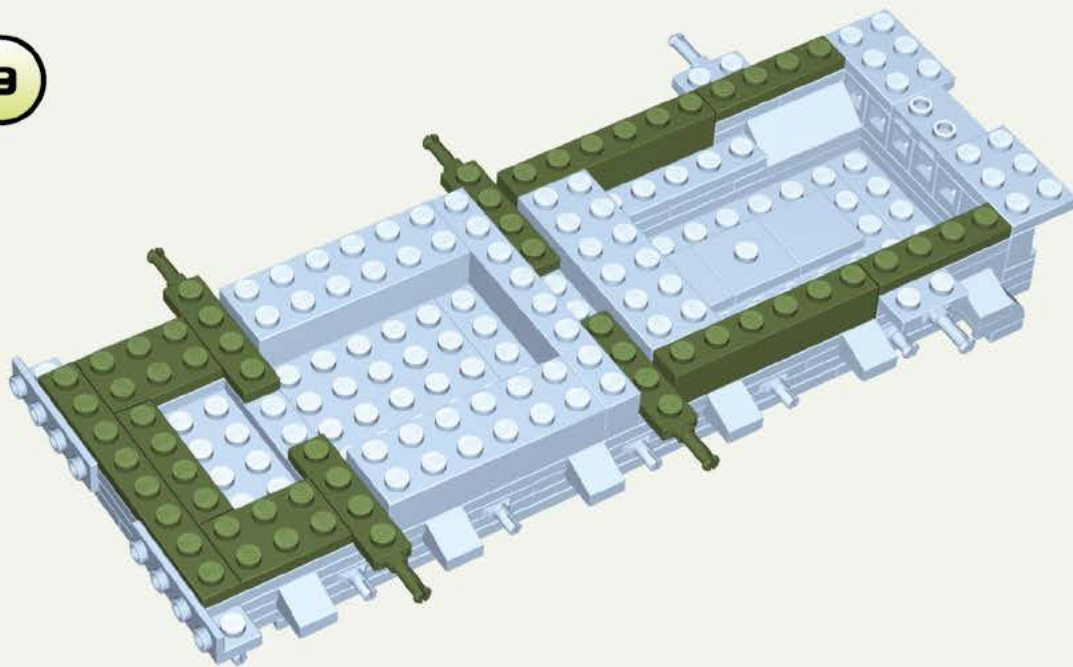

10

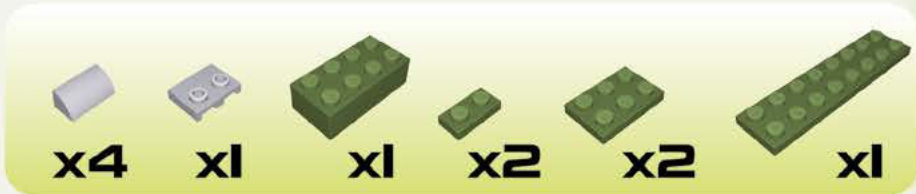

11

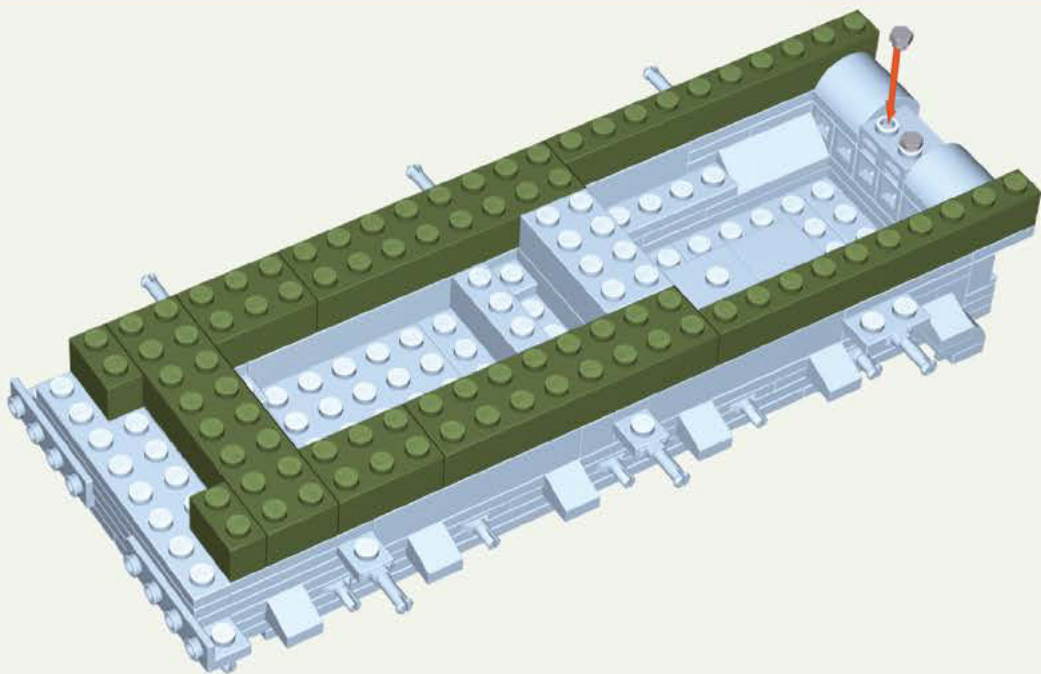

12

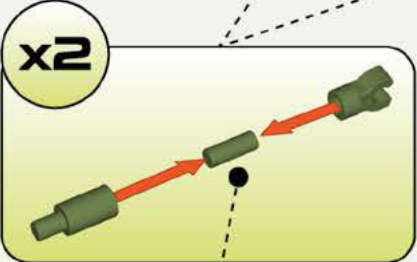
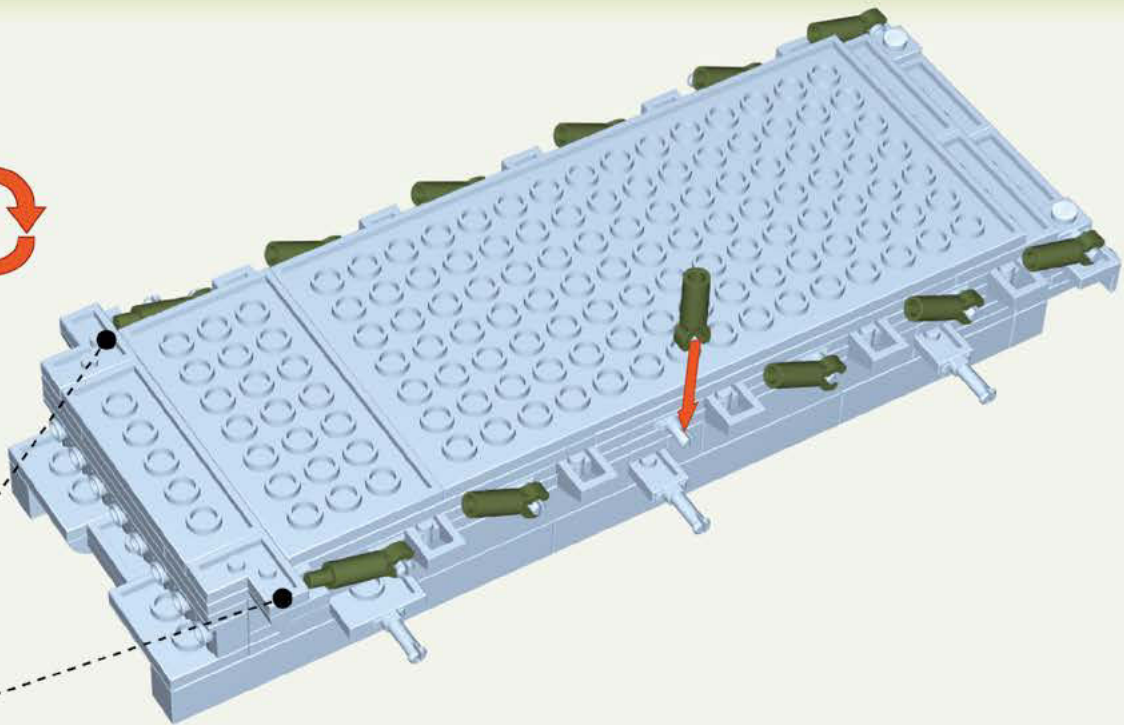

x2

1:1

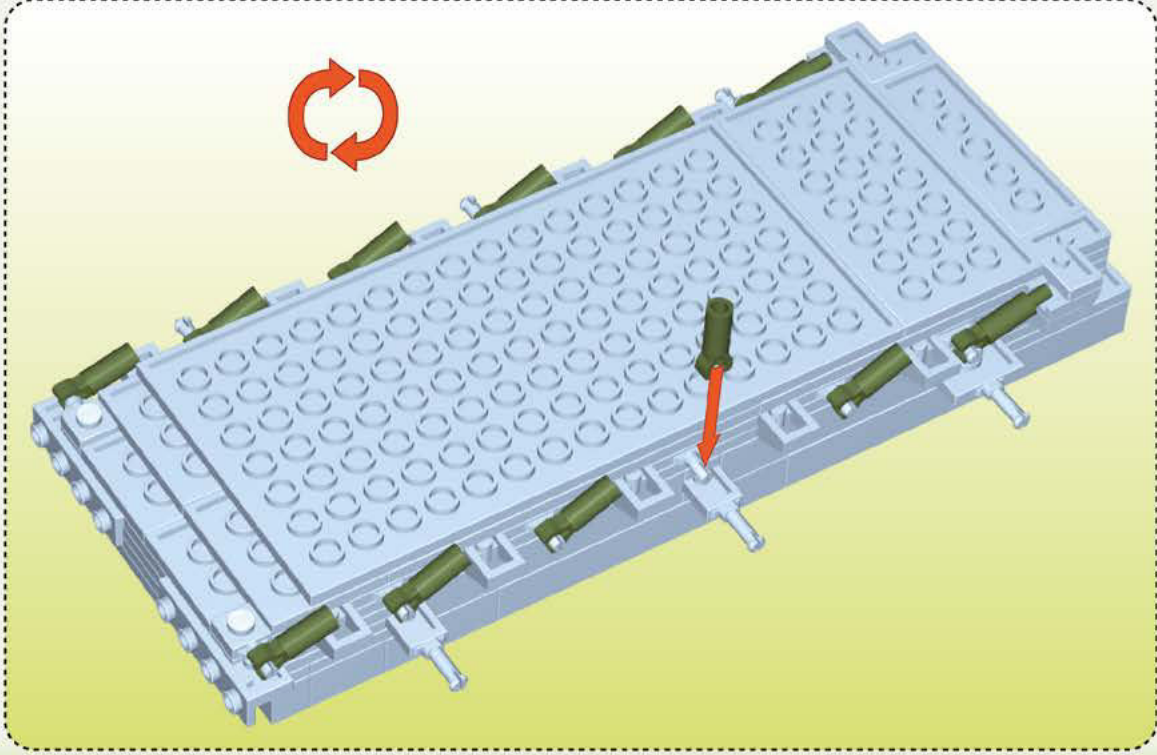

 x10

 x2

 x2

 x2

13

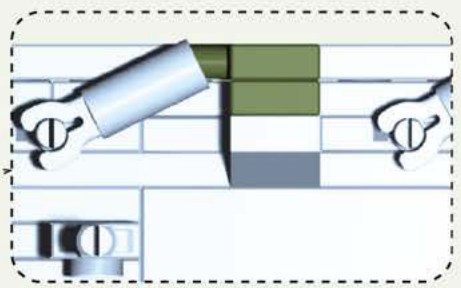
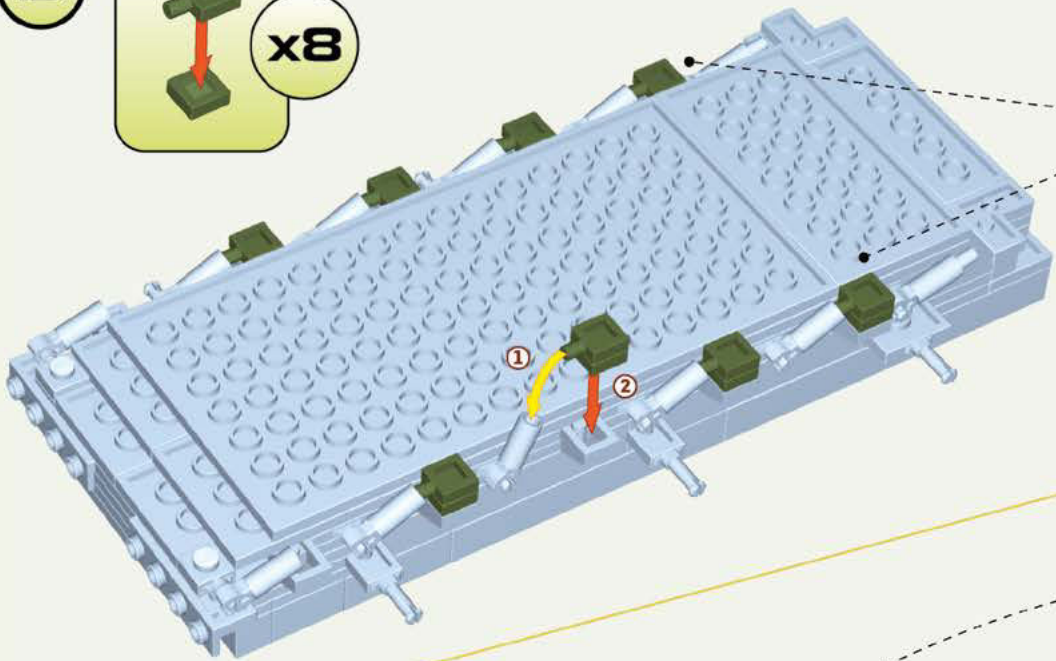
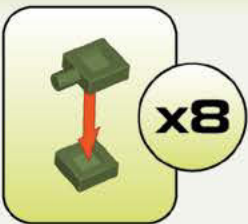

14

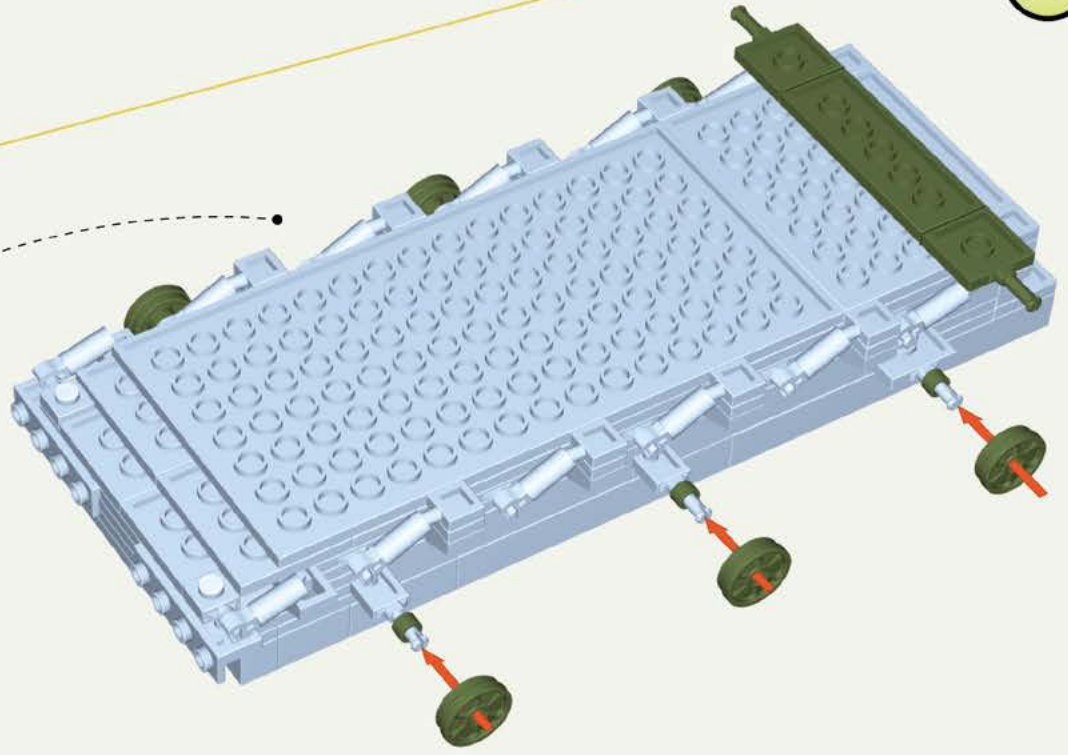
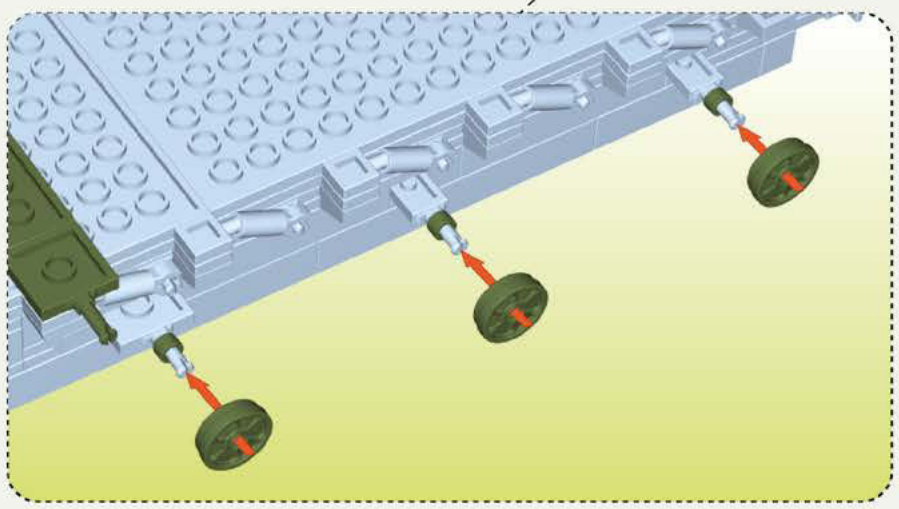

15

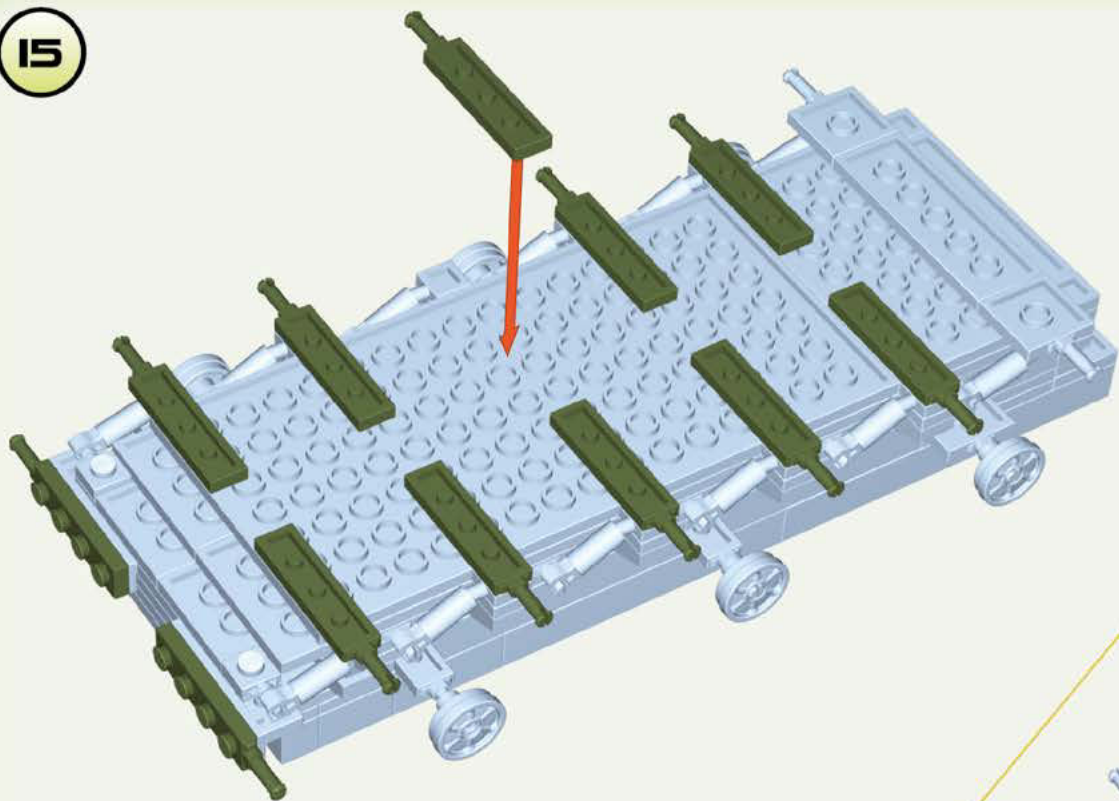

16

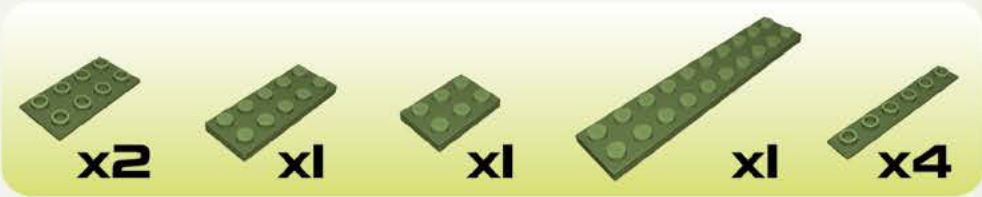
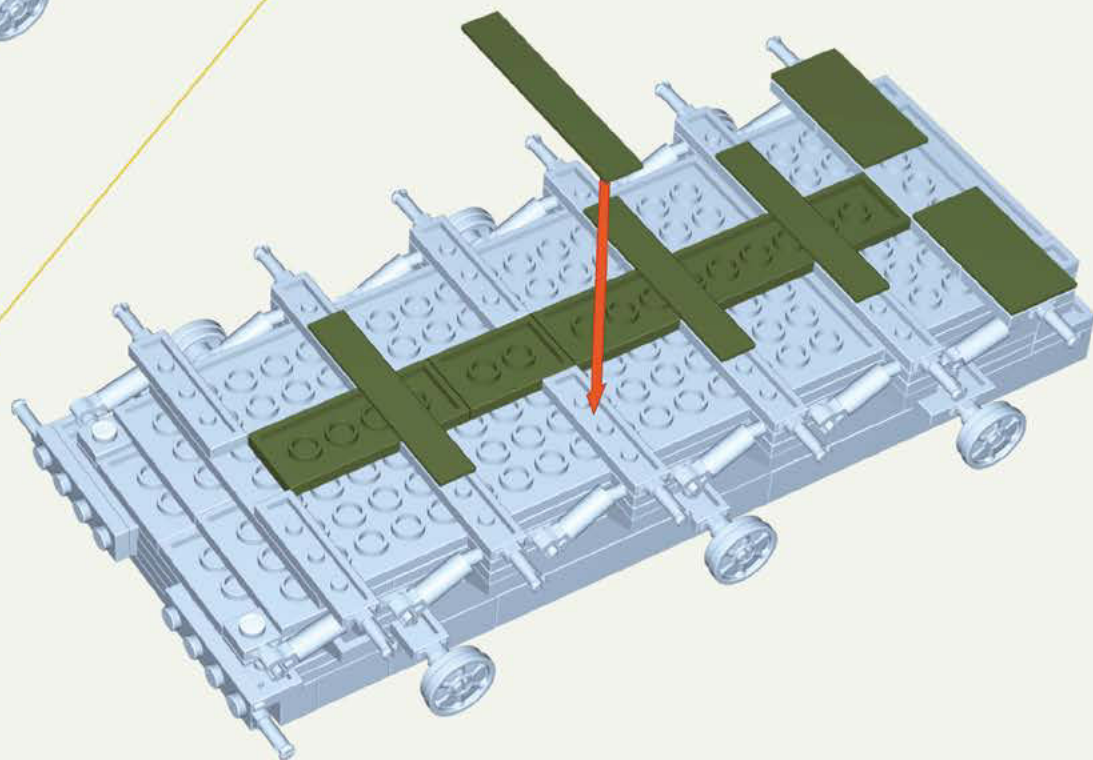

17



18

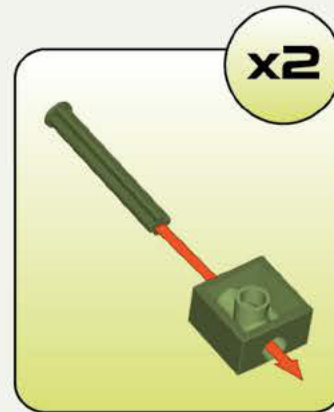
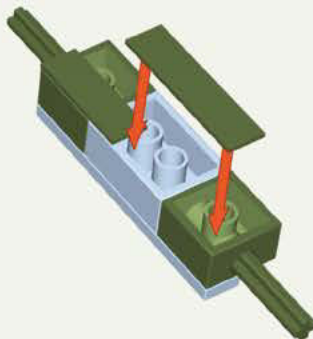

19

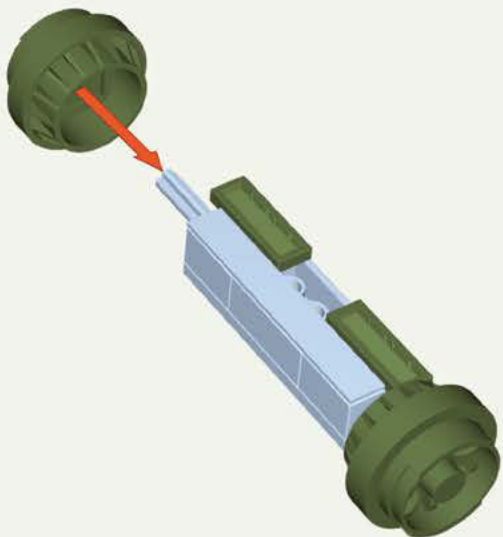

20

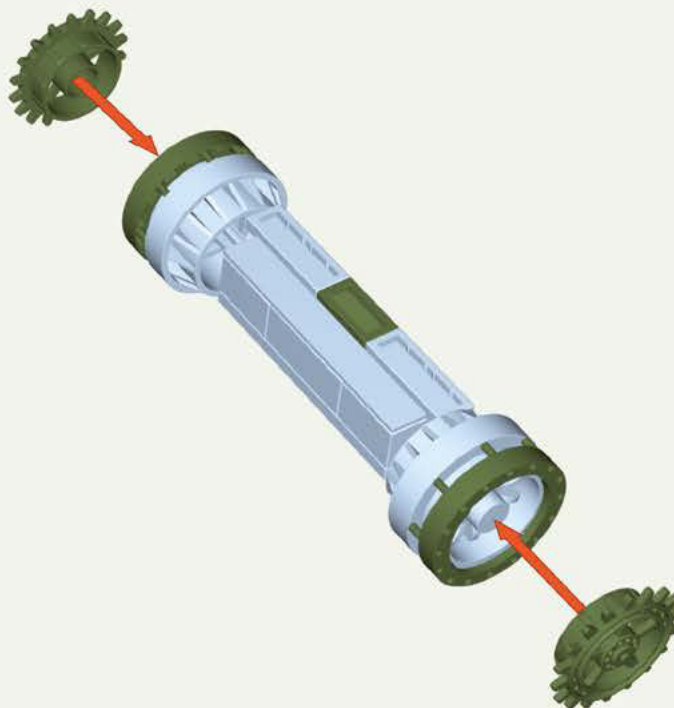

21

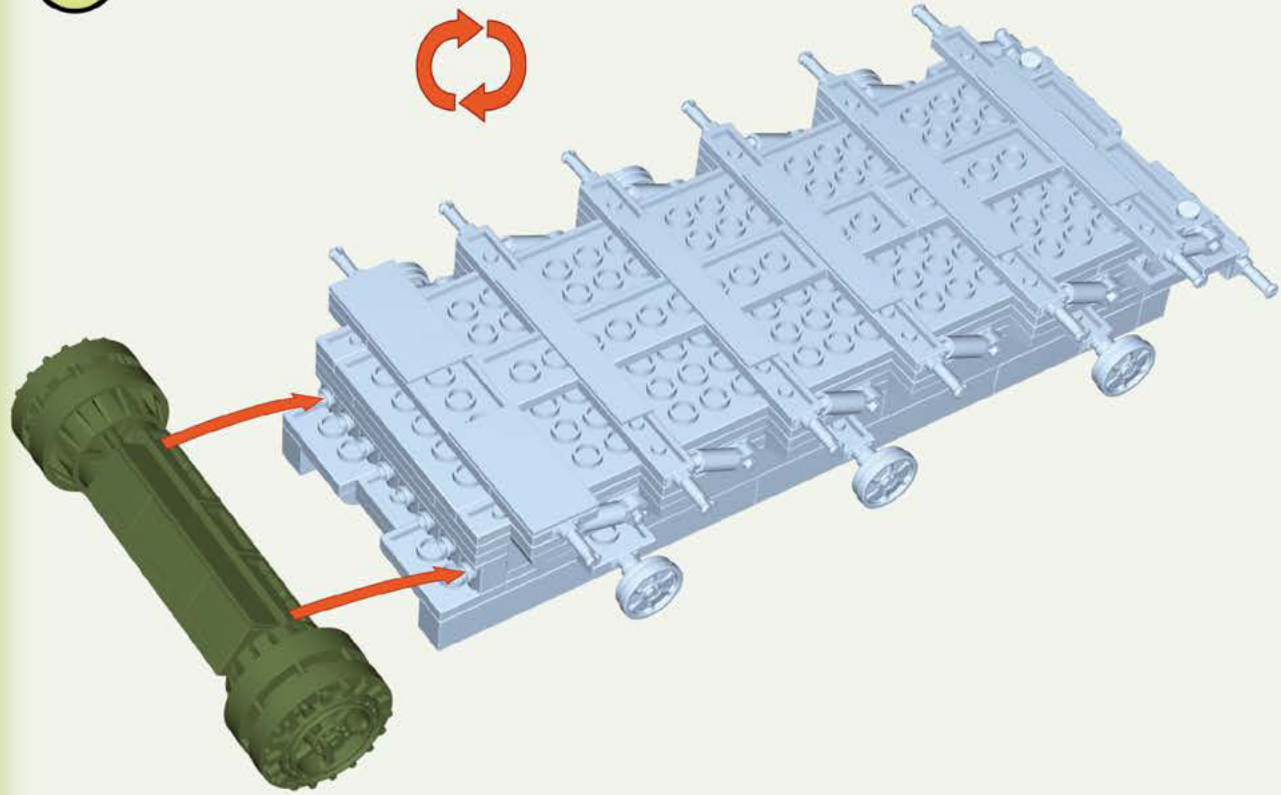

22

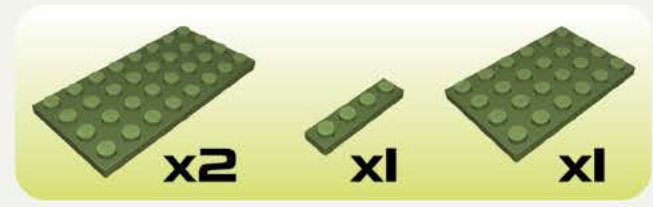
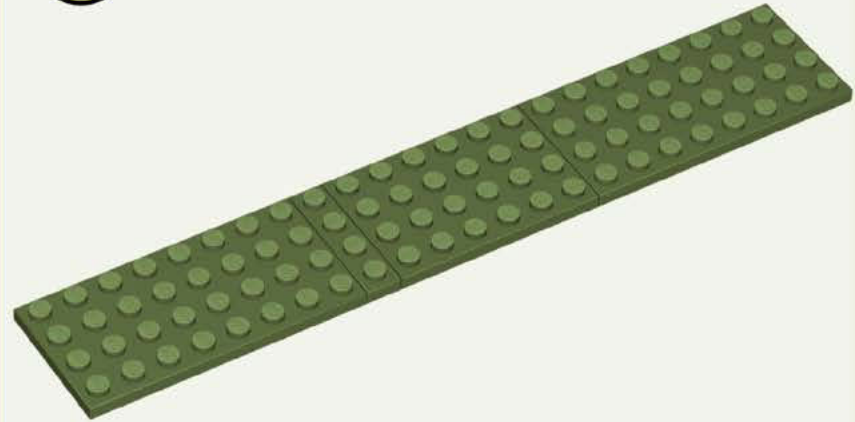



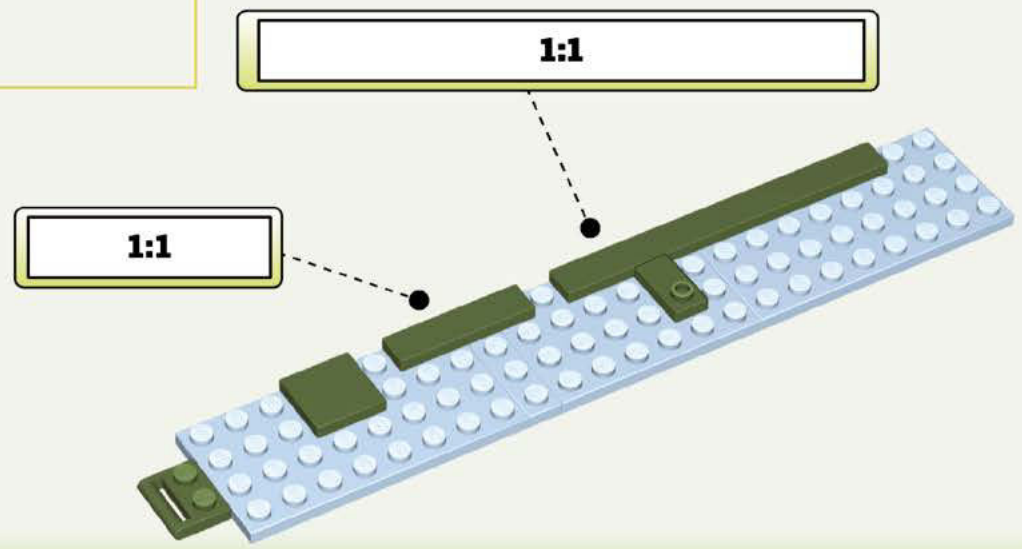
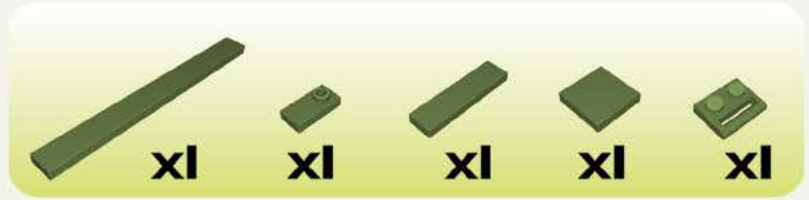

23

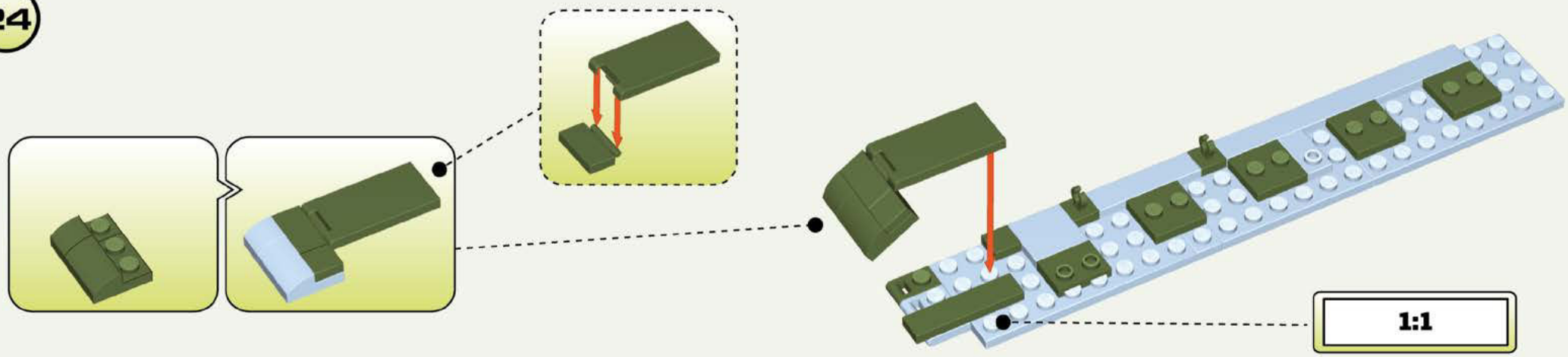









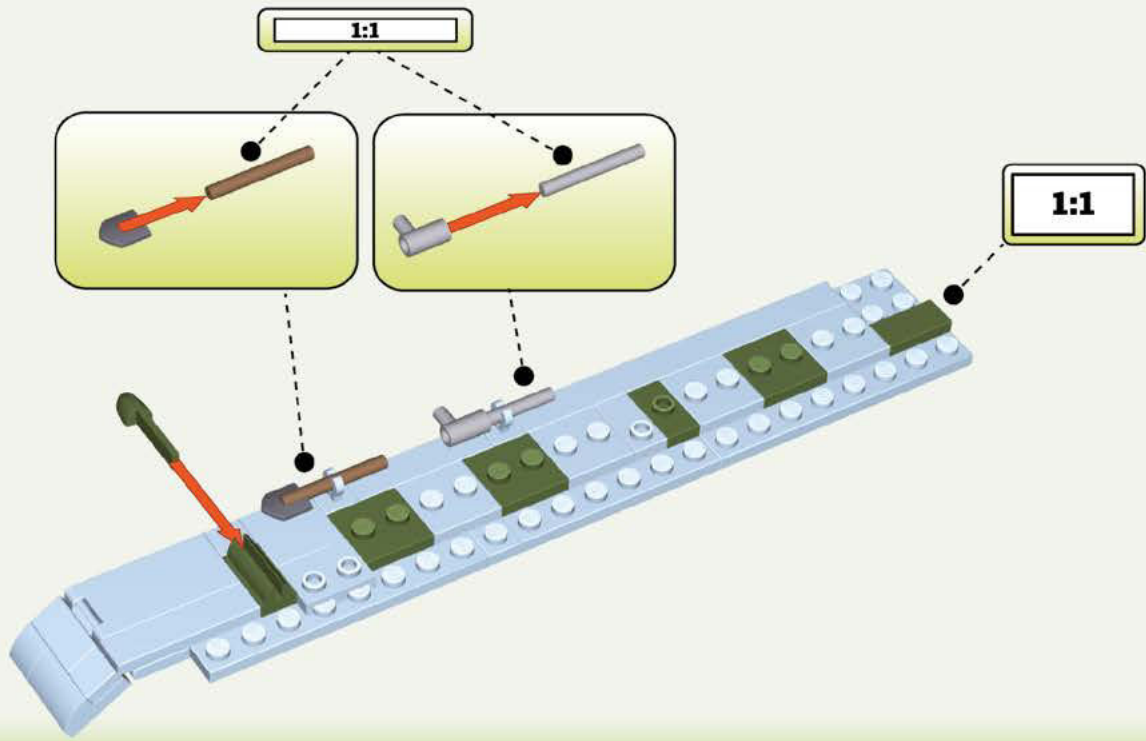

24



-  x1
-  x1
-  x2
-  x1
-  x1
-  x4
-  x1
-  x1
-  x2
-  x1

25



-  x1
-  x1
-  x3
-  x1
-  x1
-  x1
-  x1
-  x1
-  x1

26

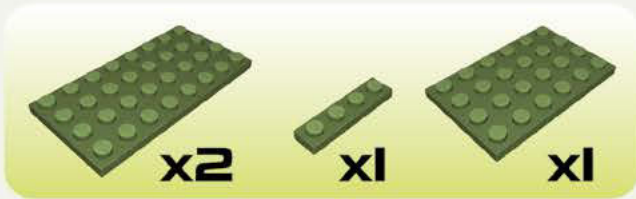
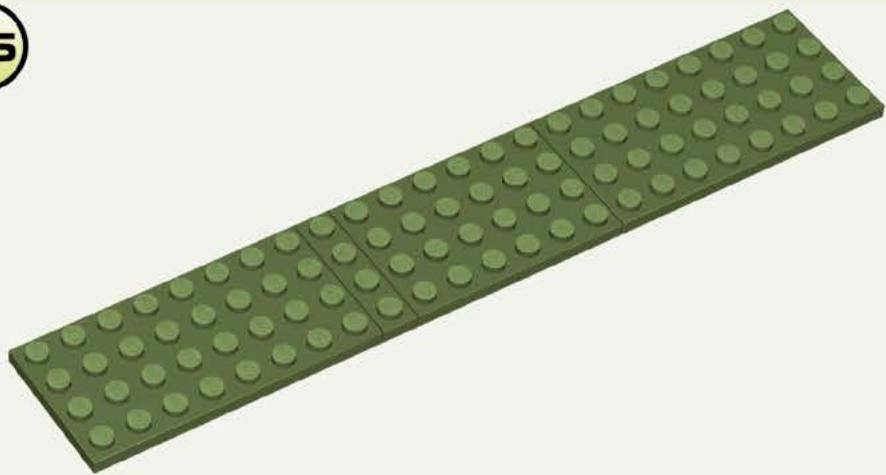

27

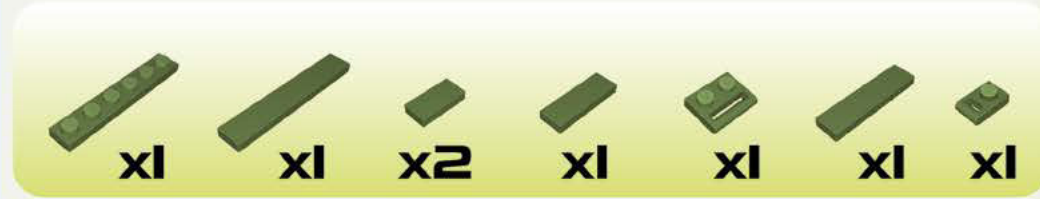
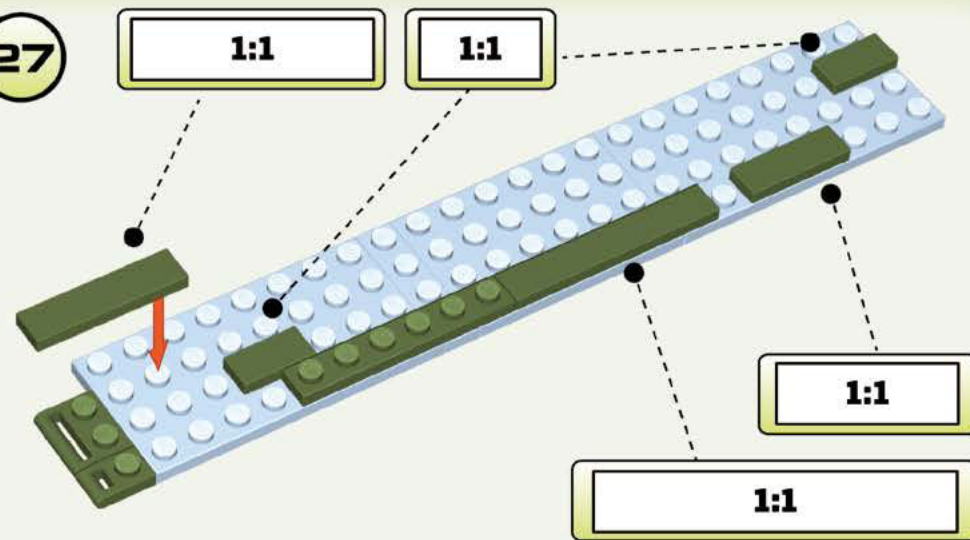



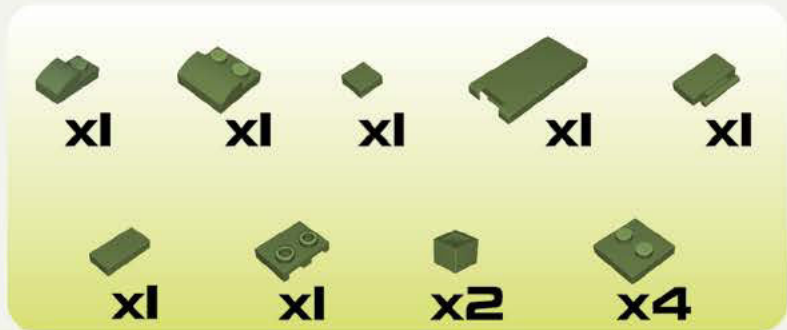
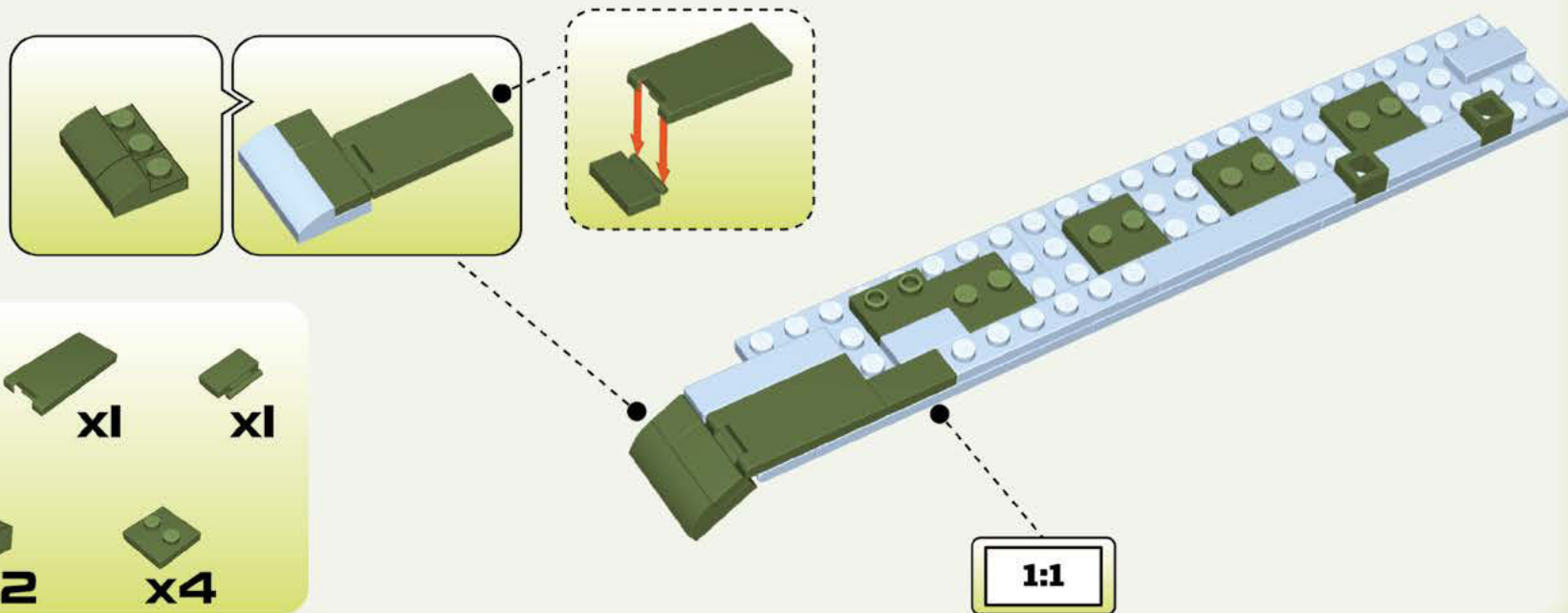

28

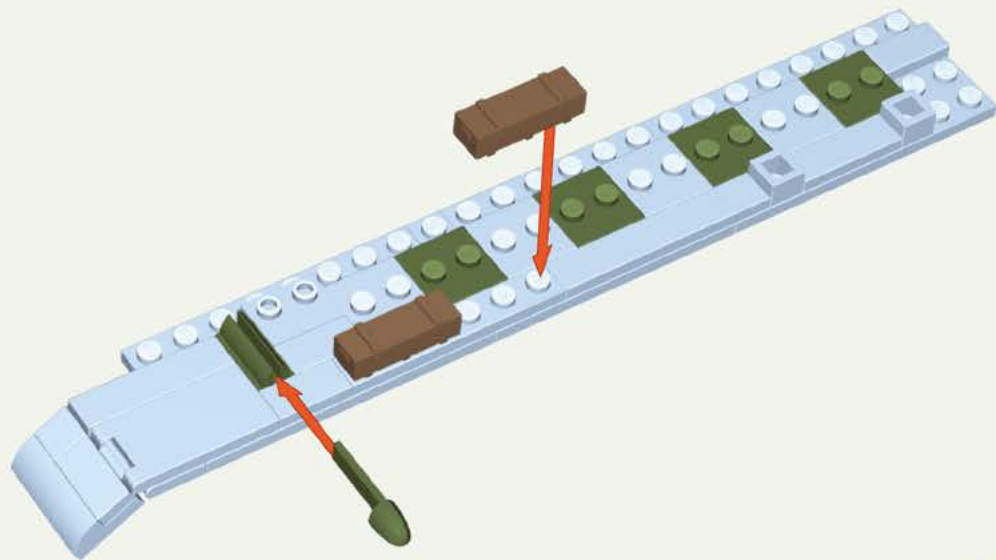

29



			
x1	x1	x4	x2

30

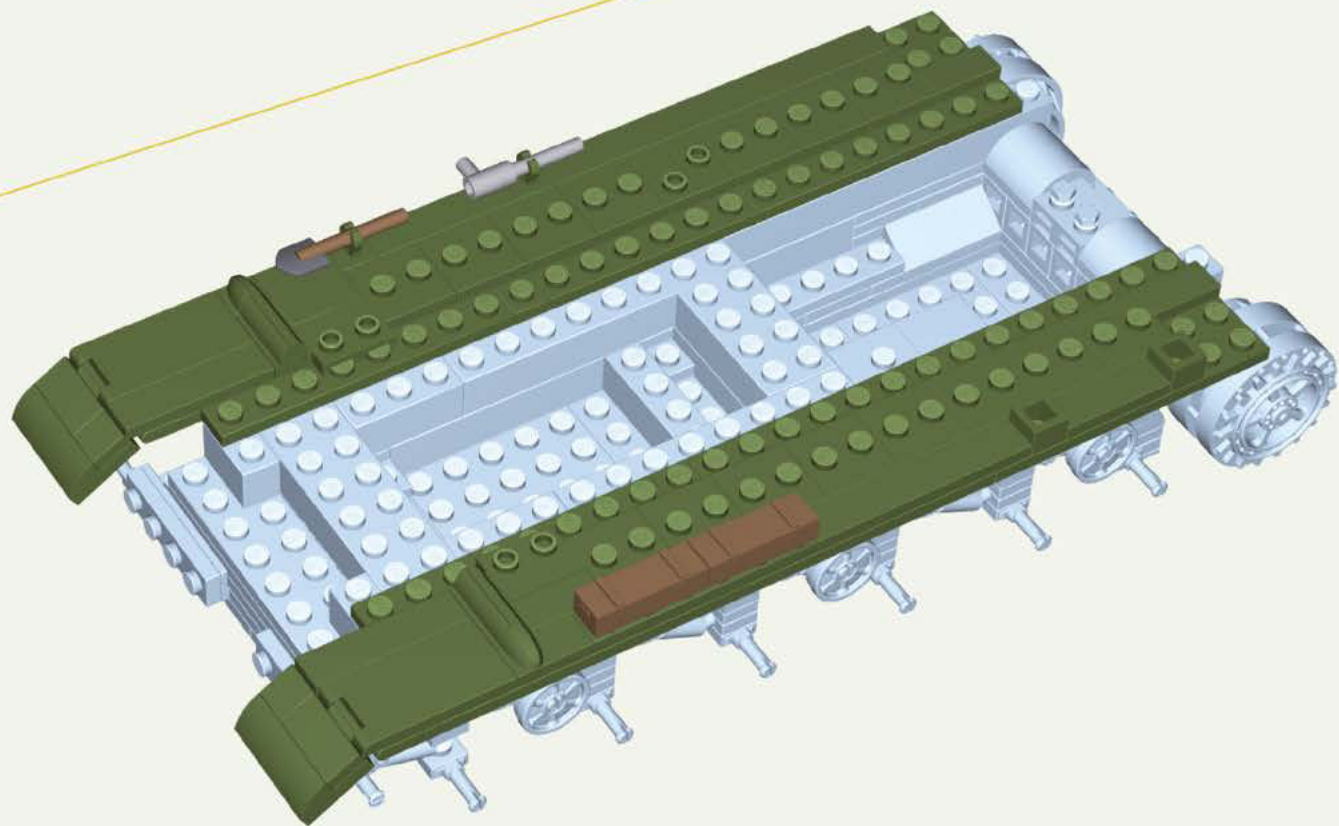

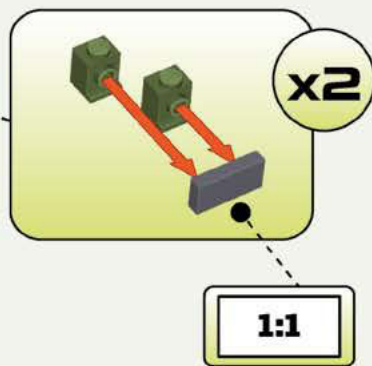
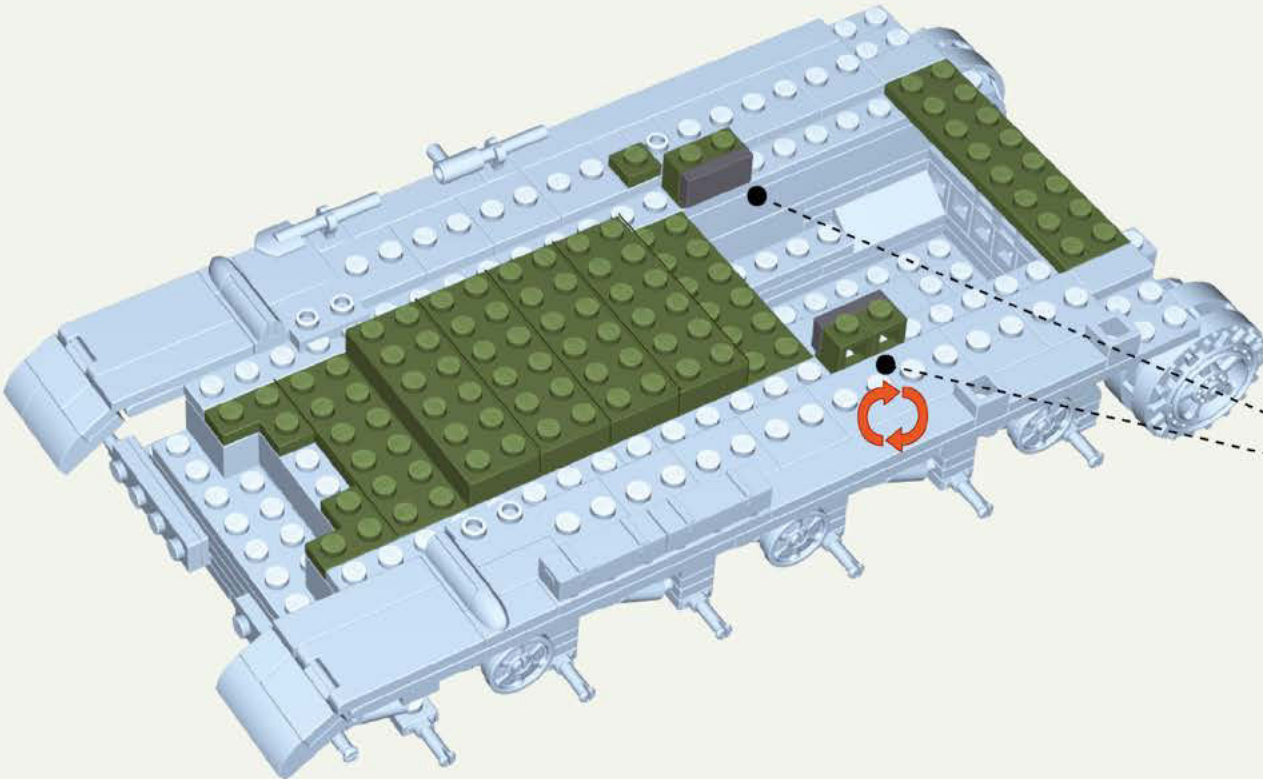

-  x4
-  x2
-  x1
-  x2
-  x4
-  x2
-  x1

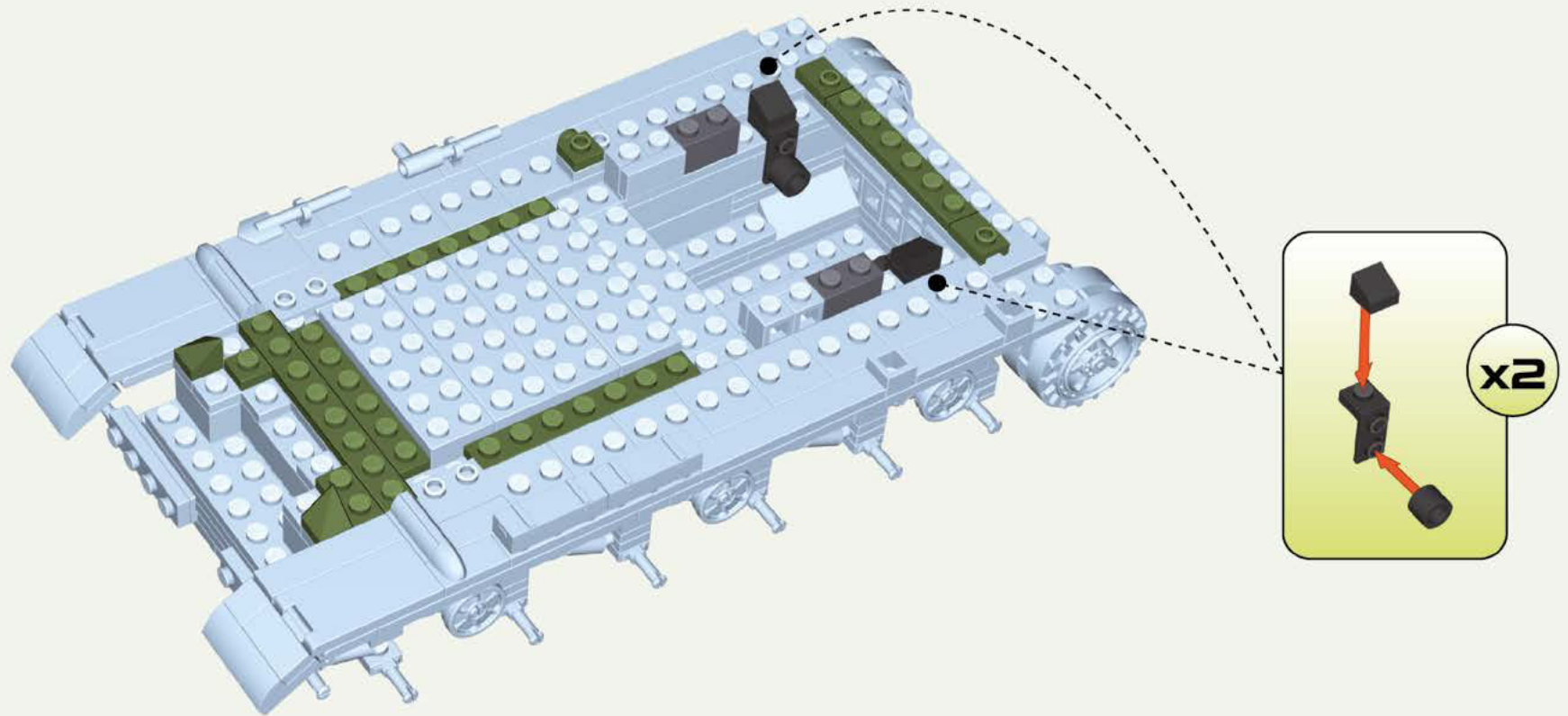

-  x2
-  x2
-  x2
-  x2
-  x2
-  x2
-  x1
-  x2
-  x1
-  x1
-  x1
-  x2

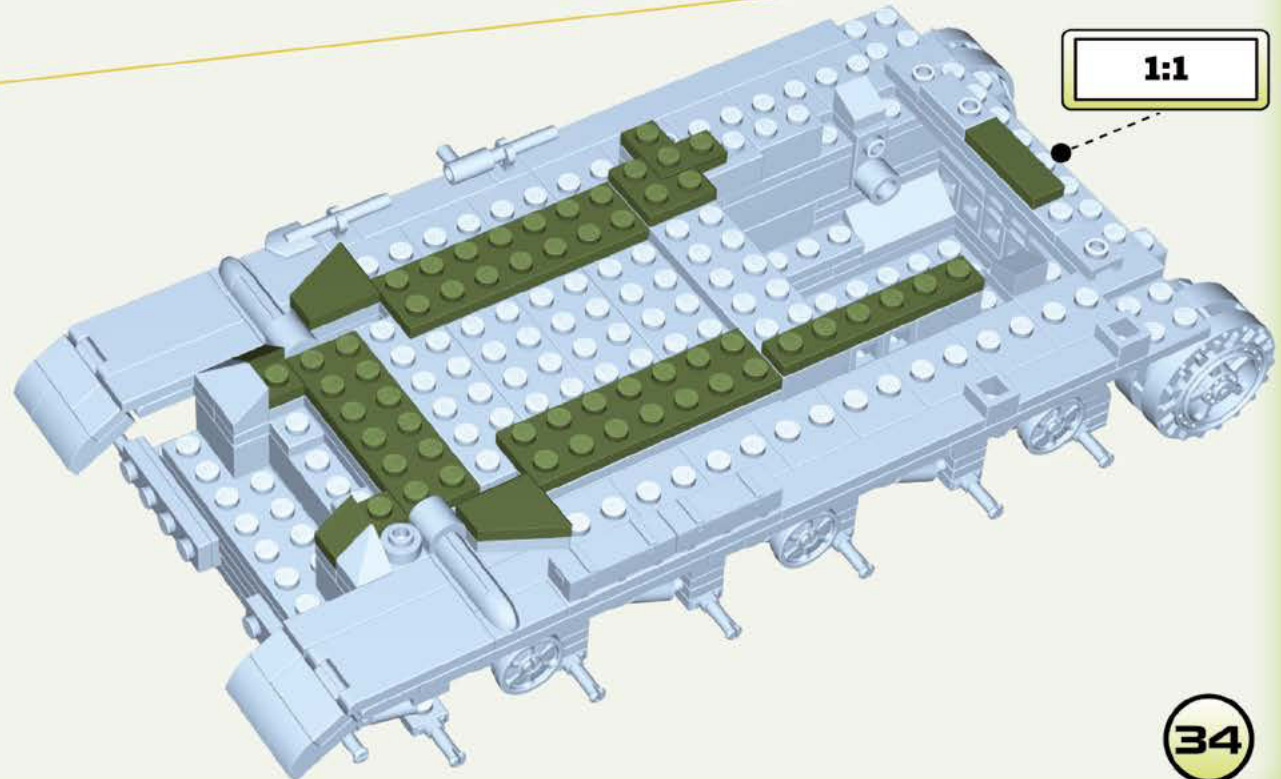
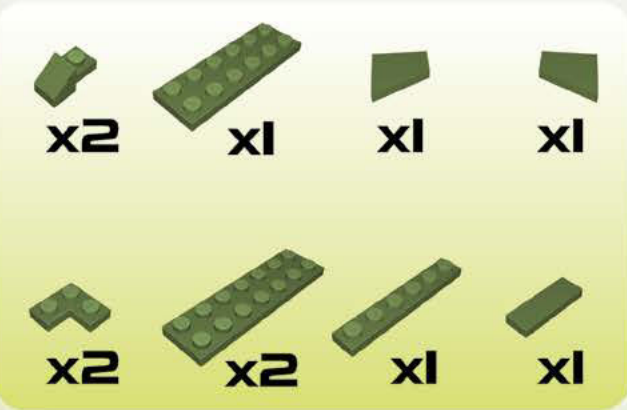
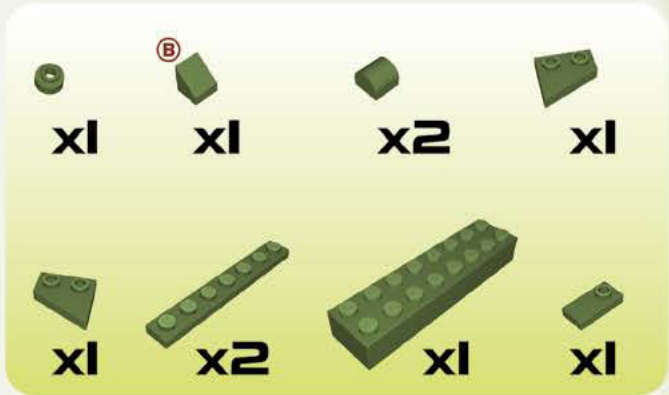
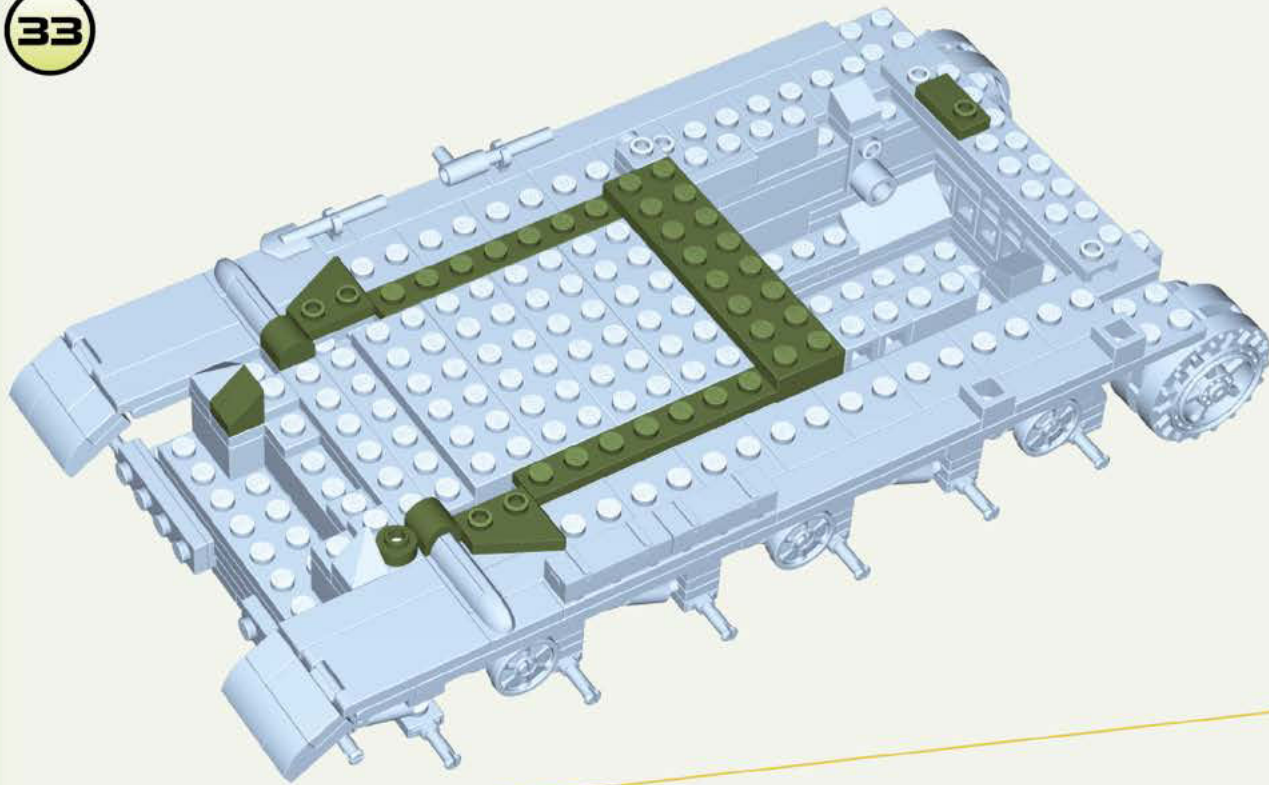

1:1

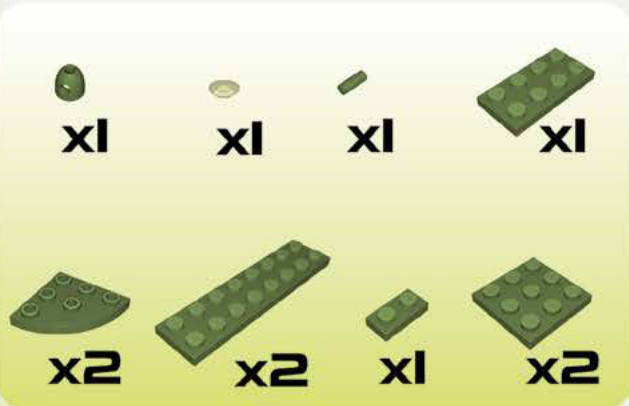
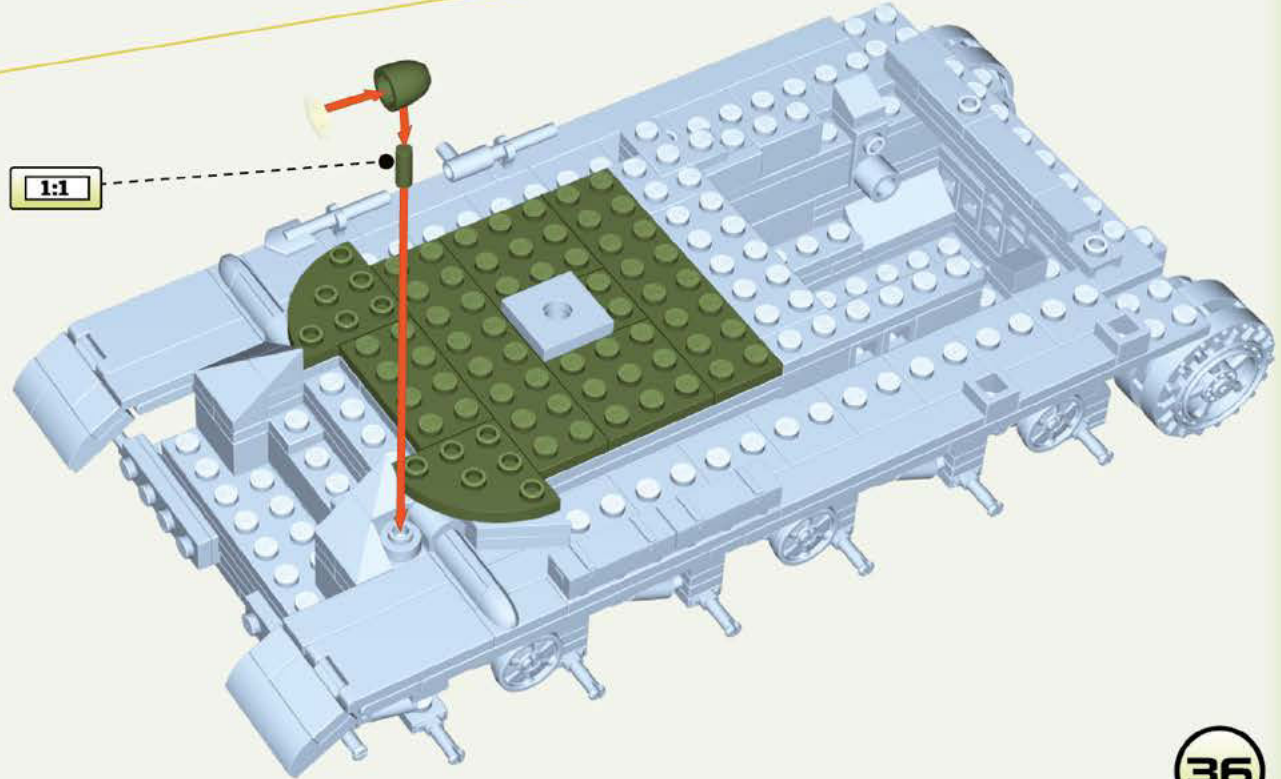
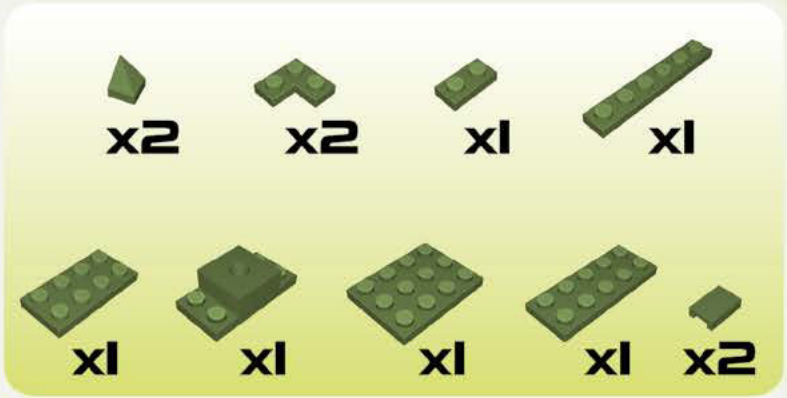
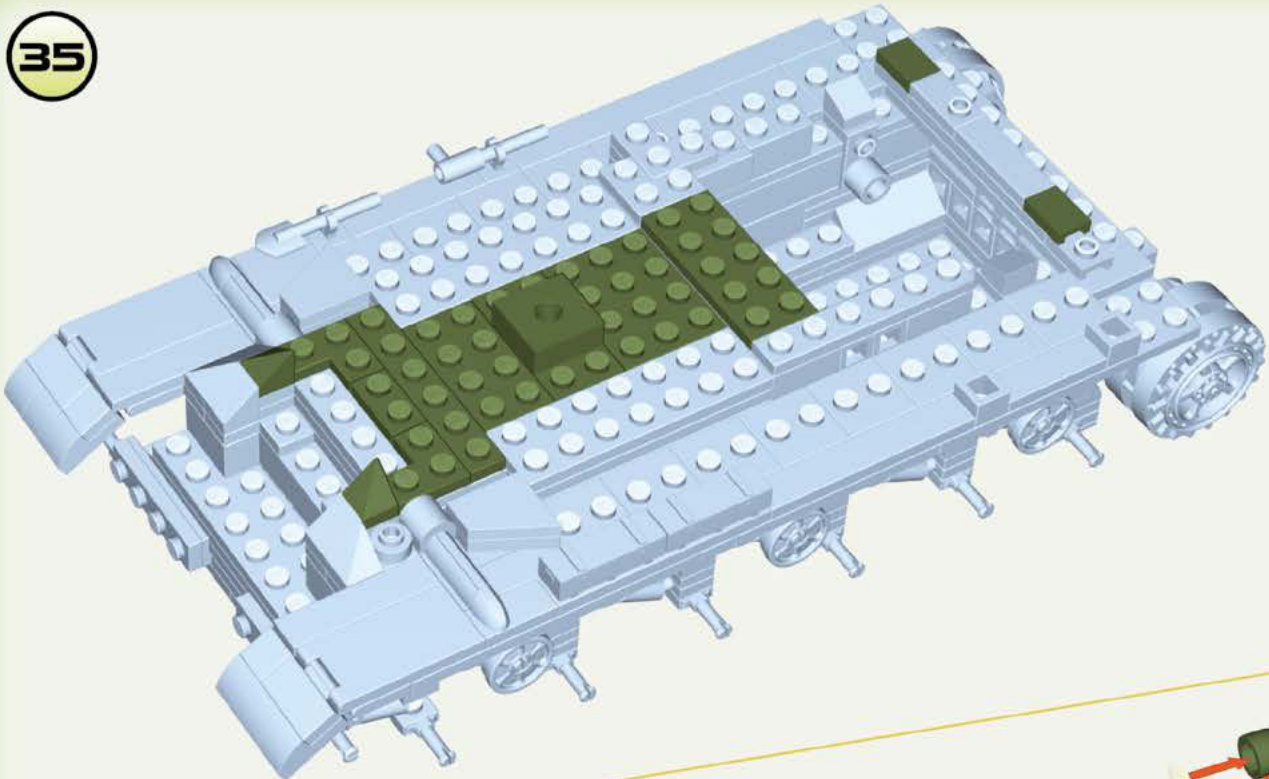

37

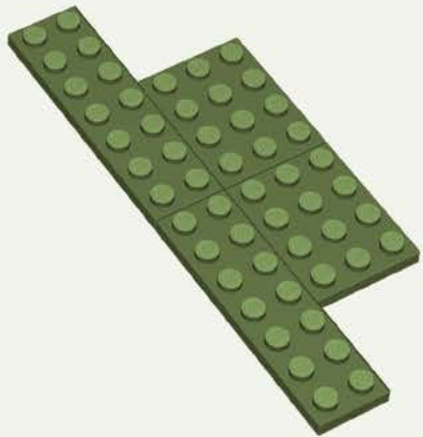

38

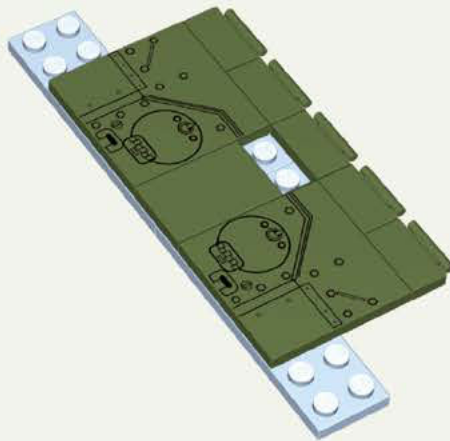

39

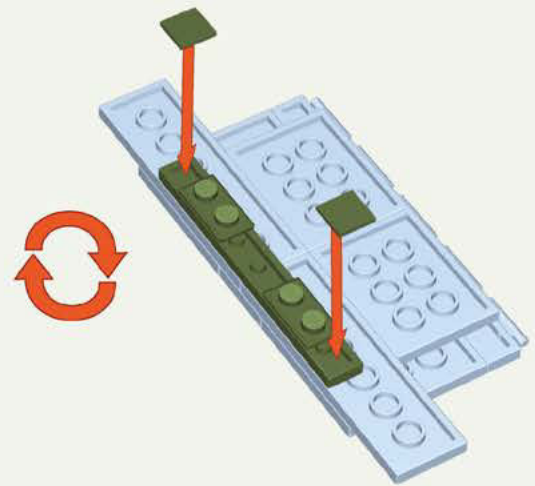

40

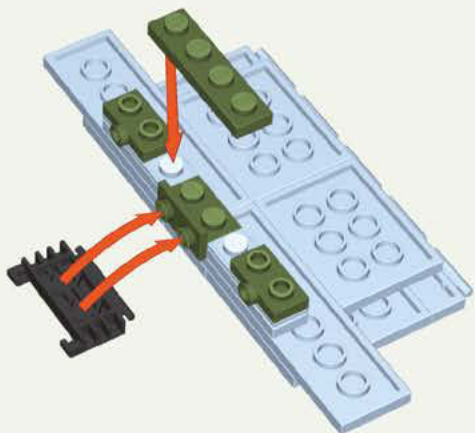



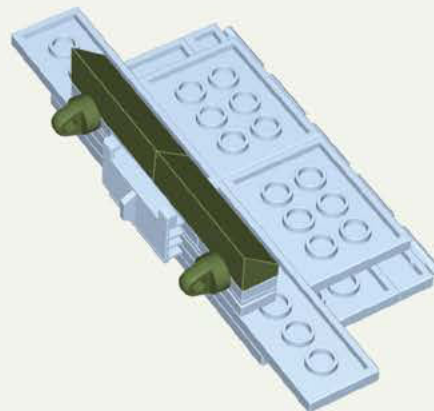

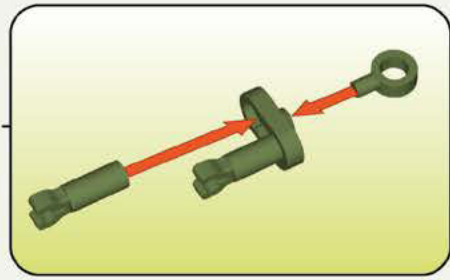
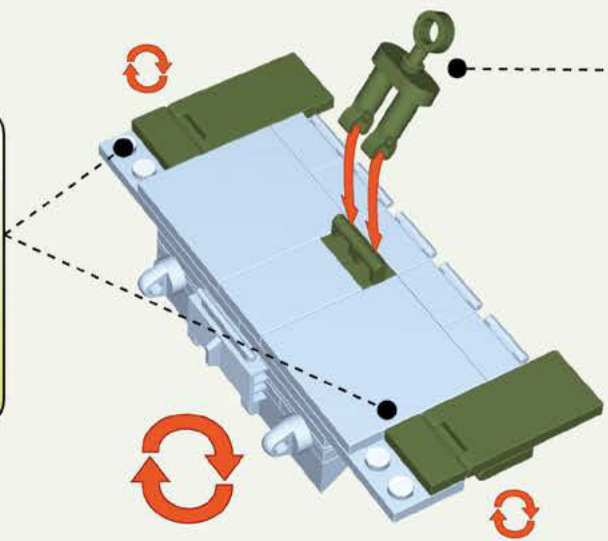
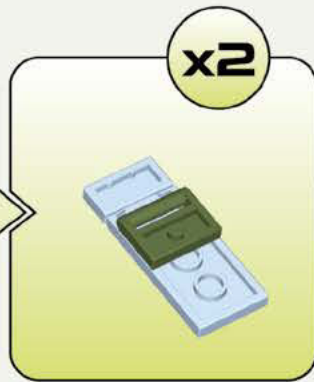
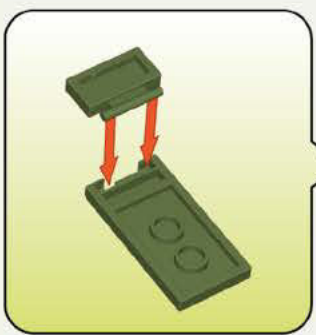

41

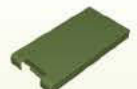

42



-  x2
-  x2
-  x2
-  x2
-  x2
-  x1
-  x1

43

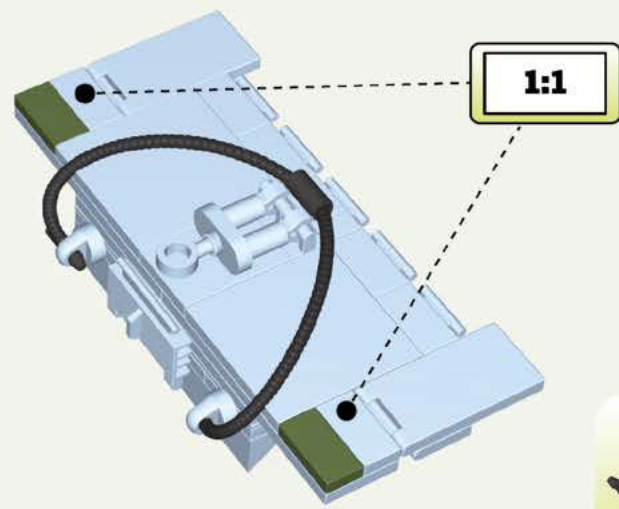
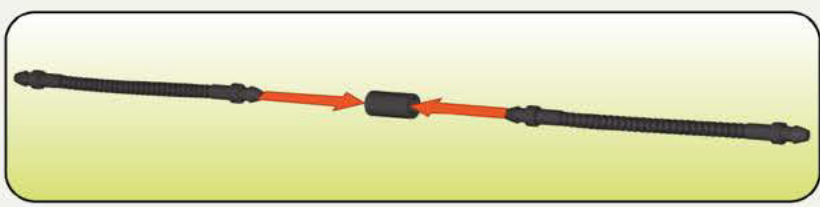

-  x2
-  x1
-  x2

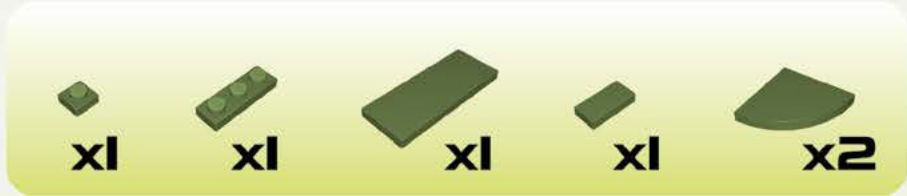
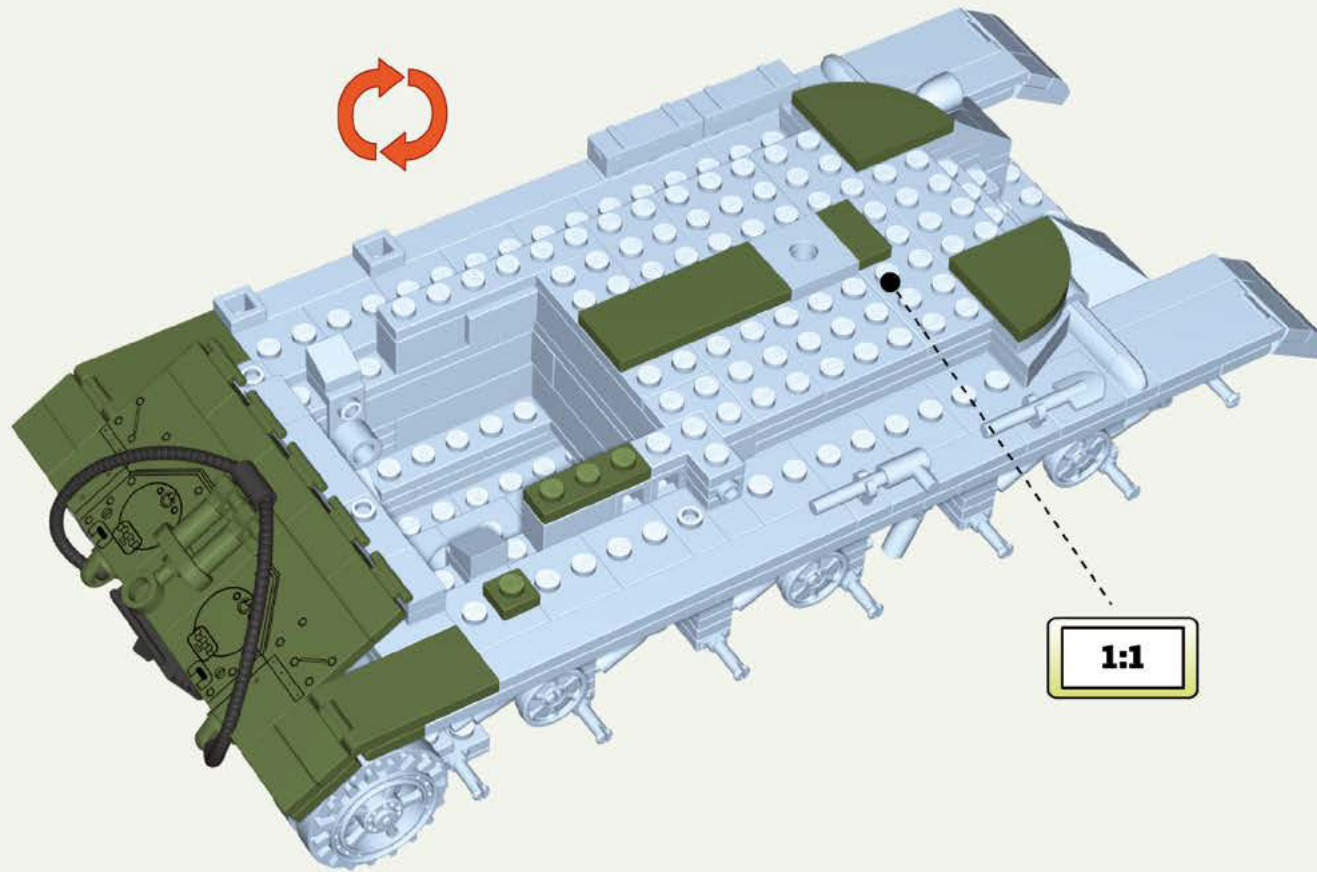

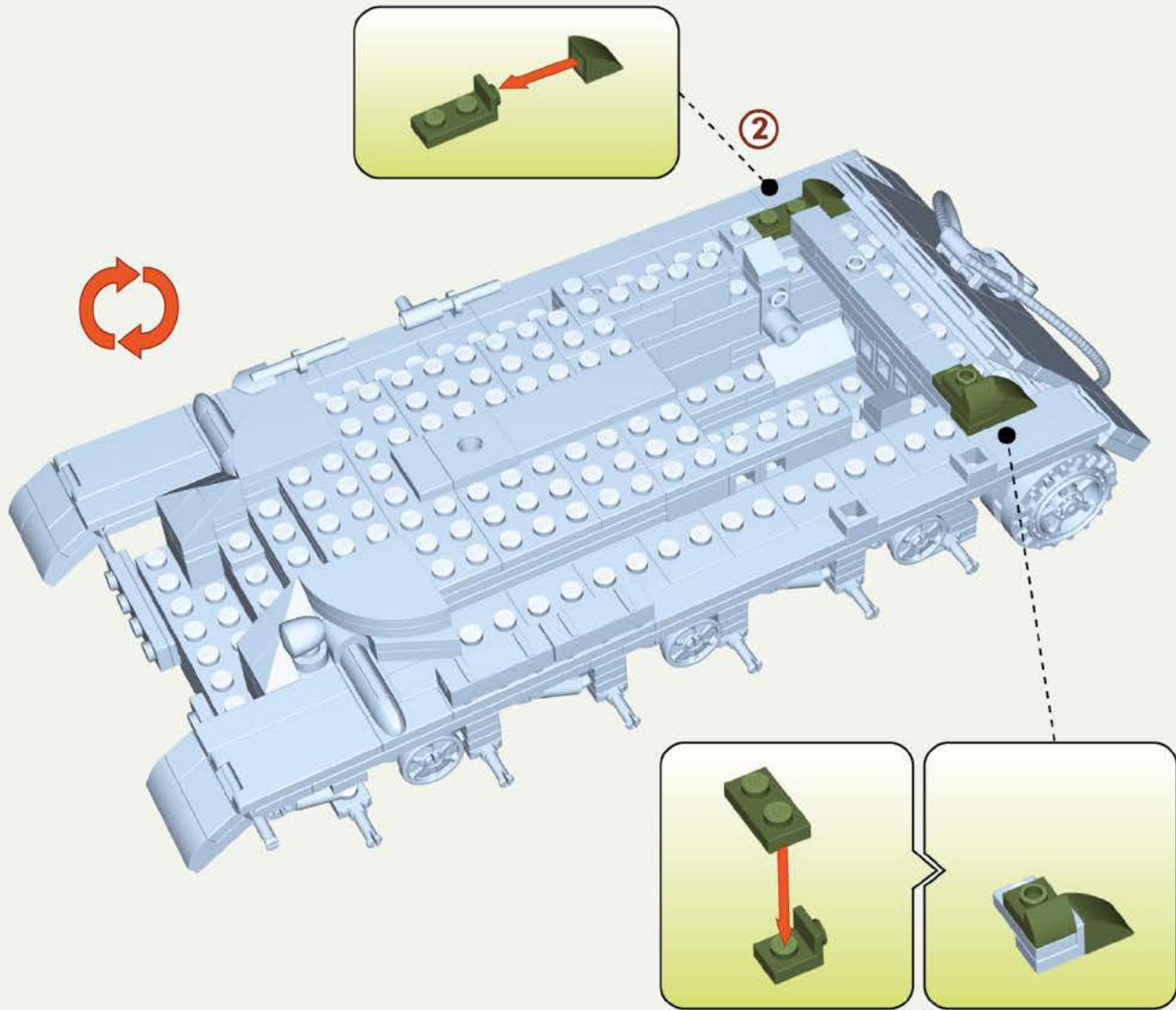
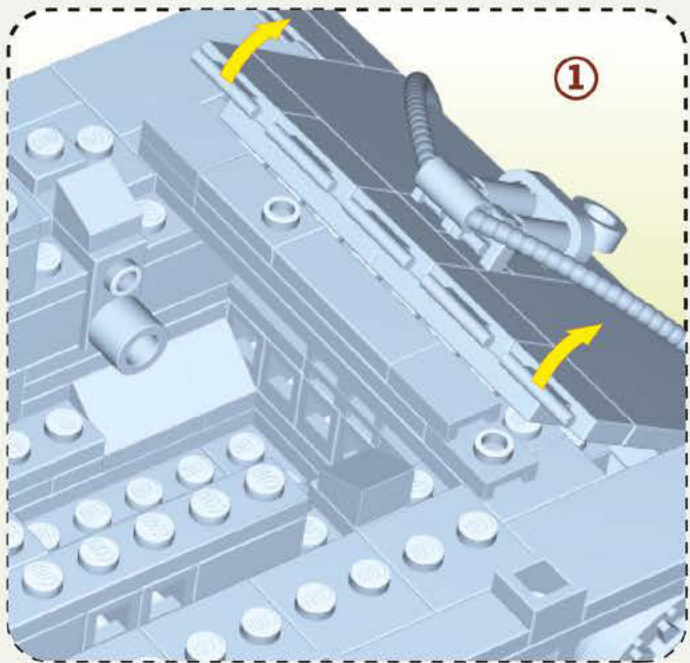

-  x1
-  x2
-  x1
-  x1
-  x1



46

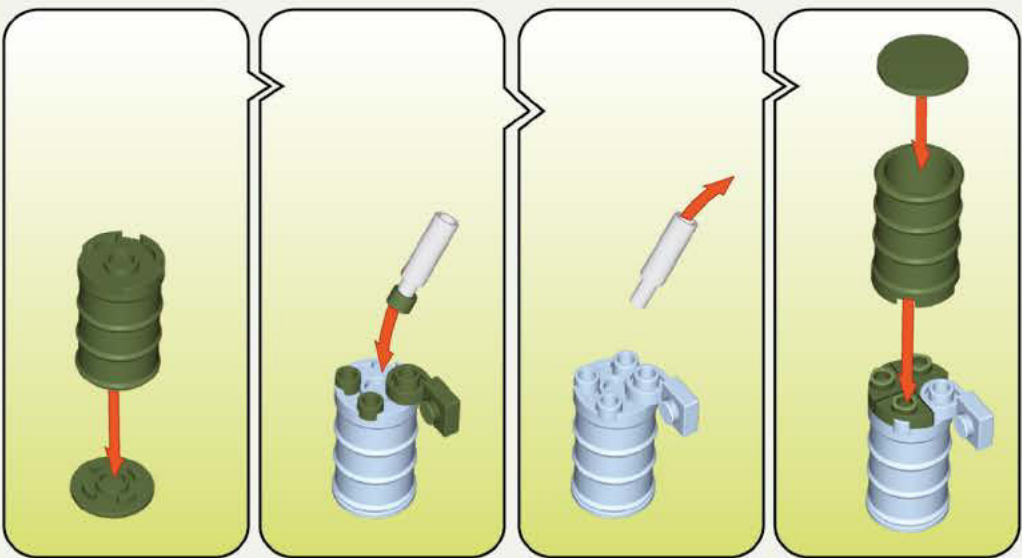

47

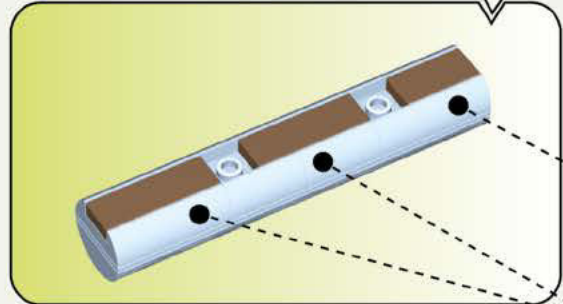
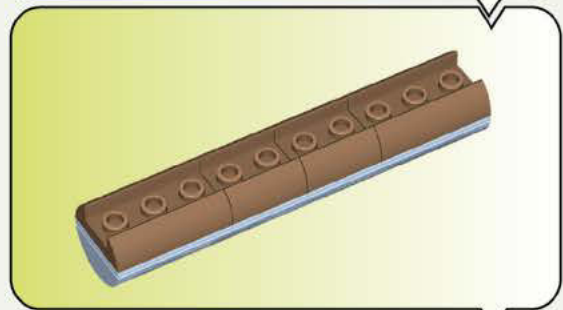
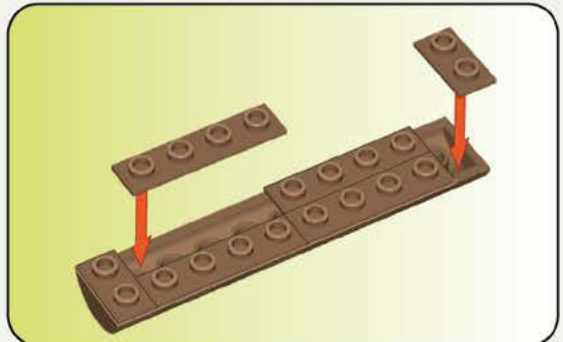

1:1
1:1

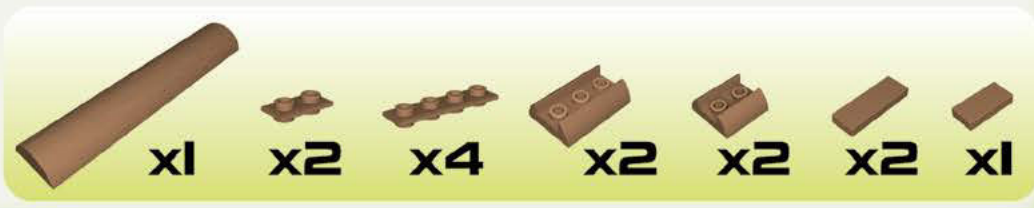

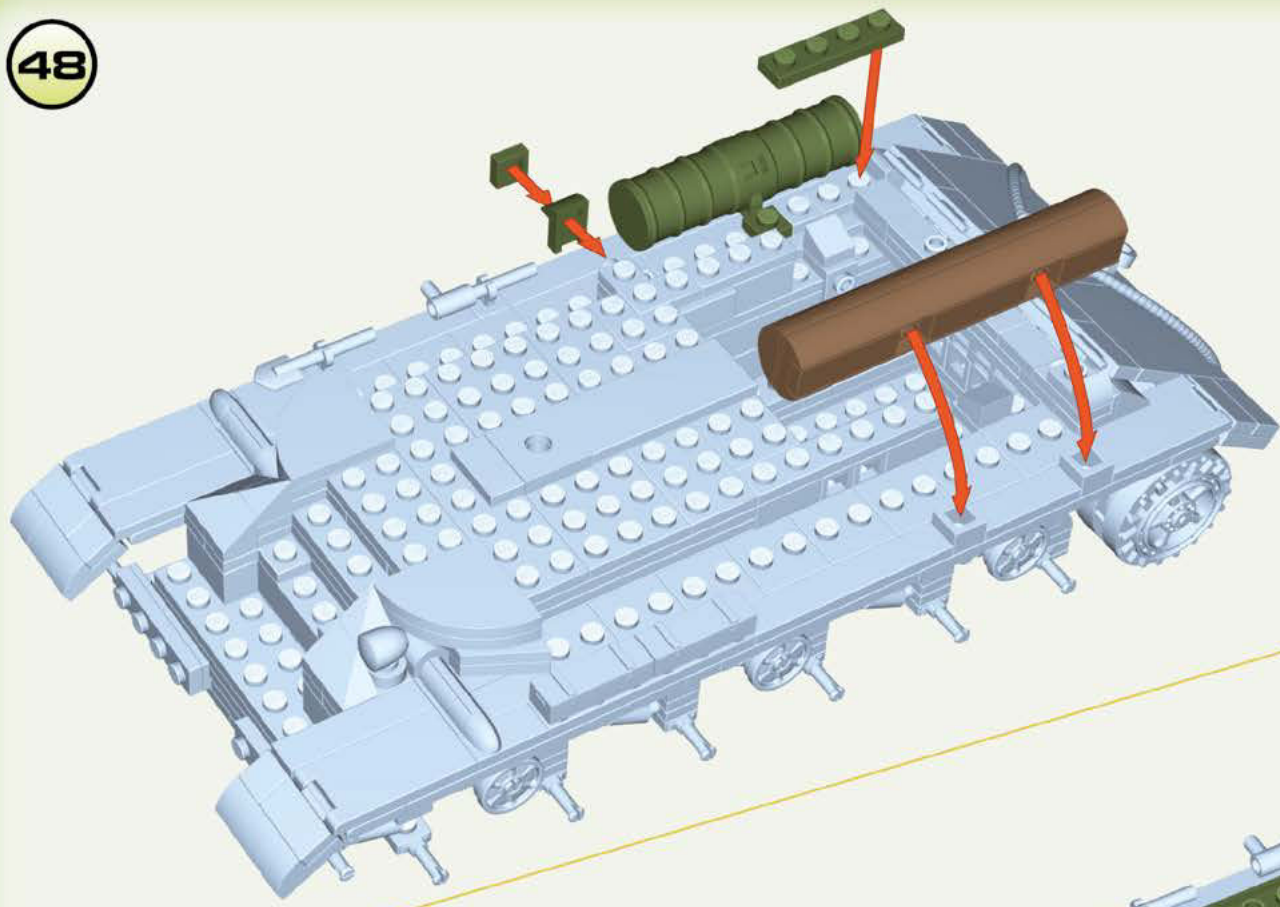

1x3 Technic brick x1
1x2 Technic brick x1
1x2 Technic brick x1

1x3 Technic brick x6
1x2 Technic brick x1

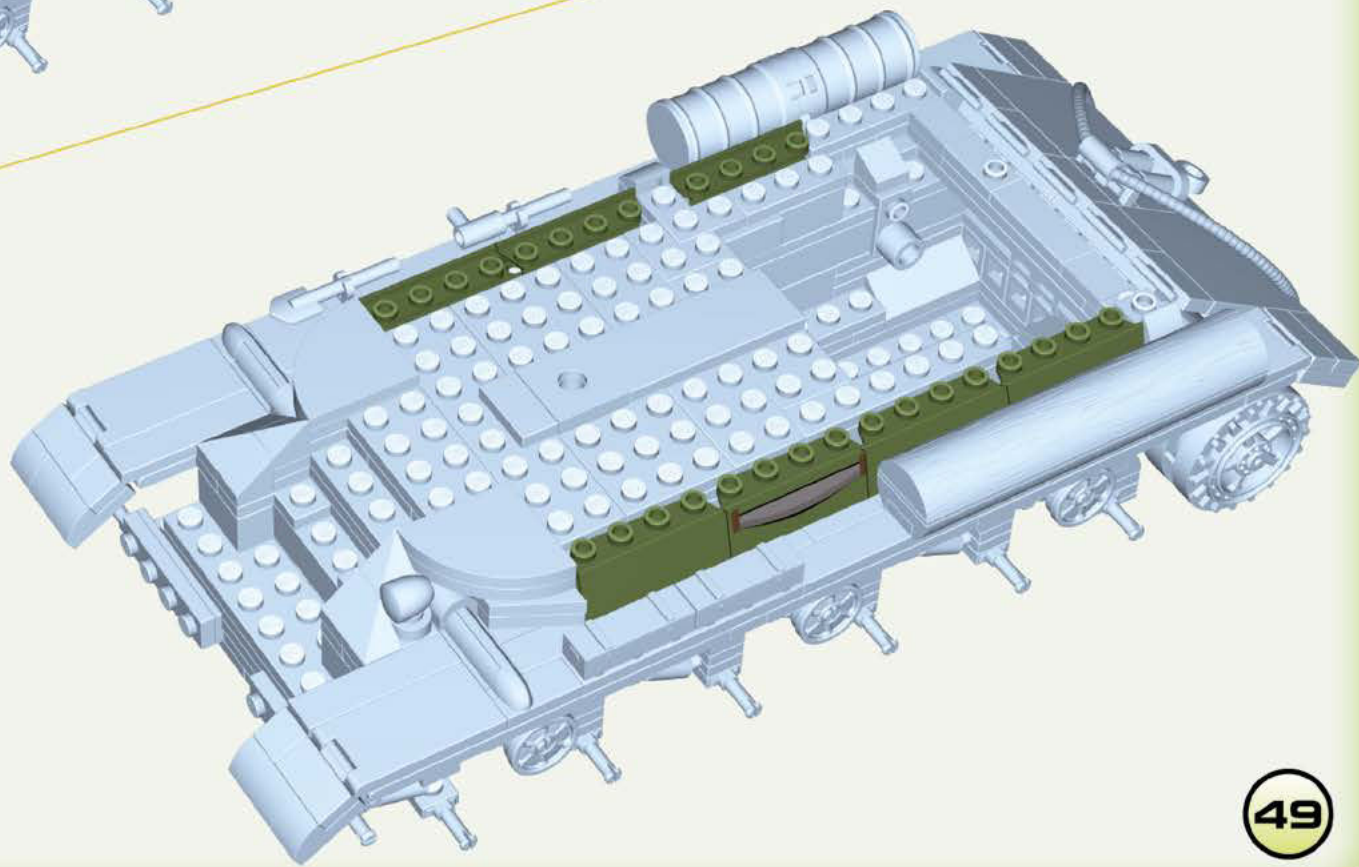

50

1:1

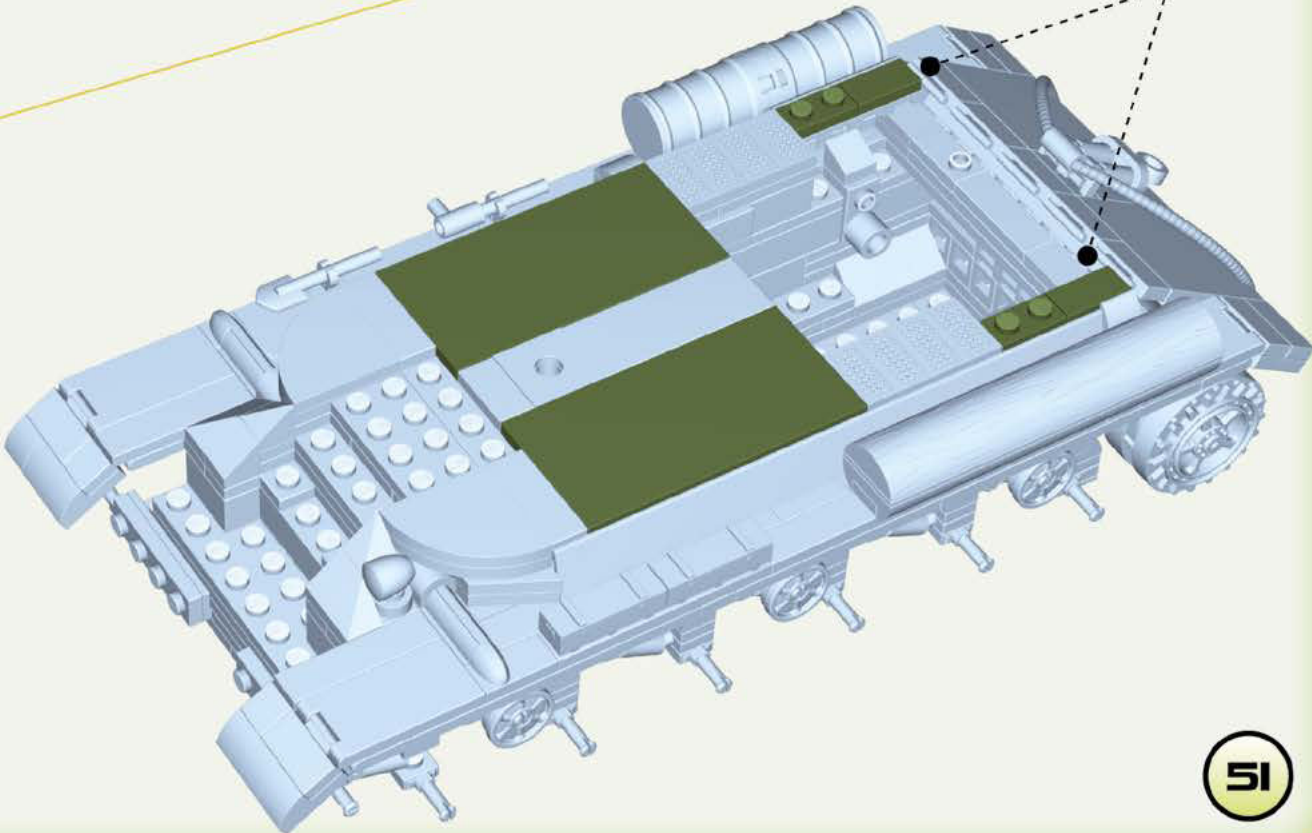
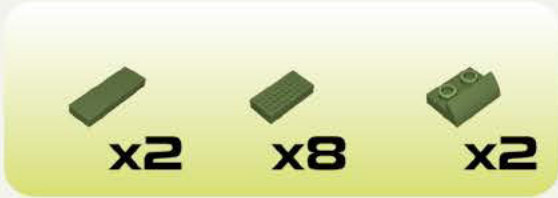
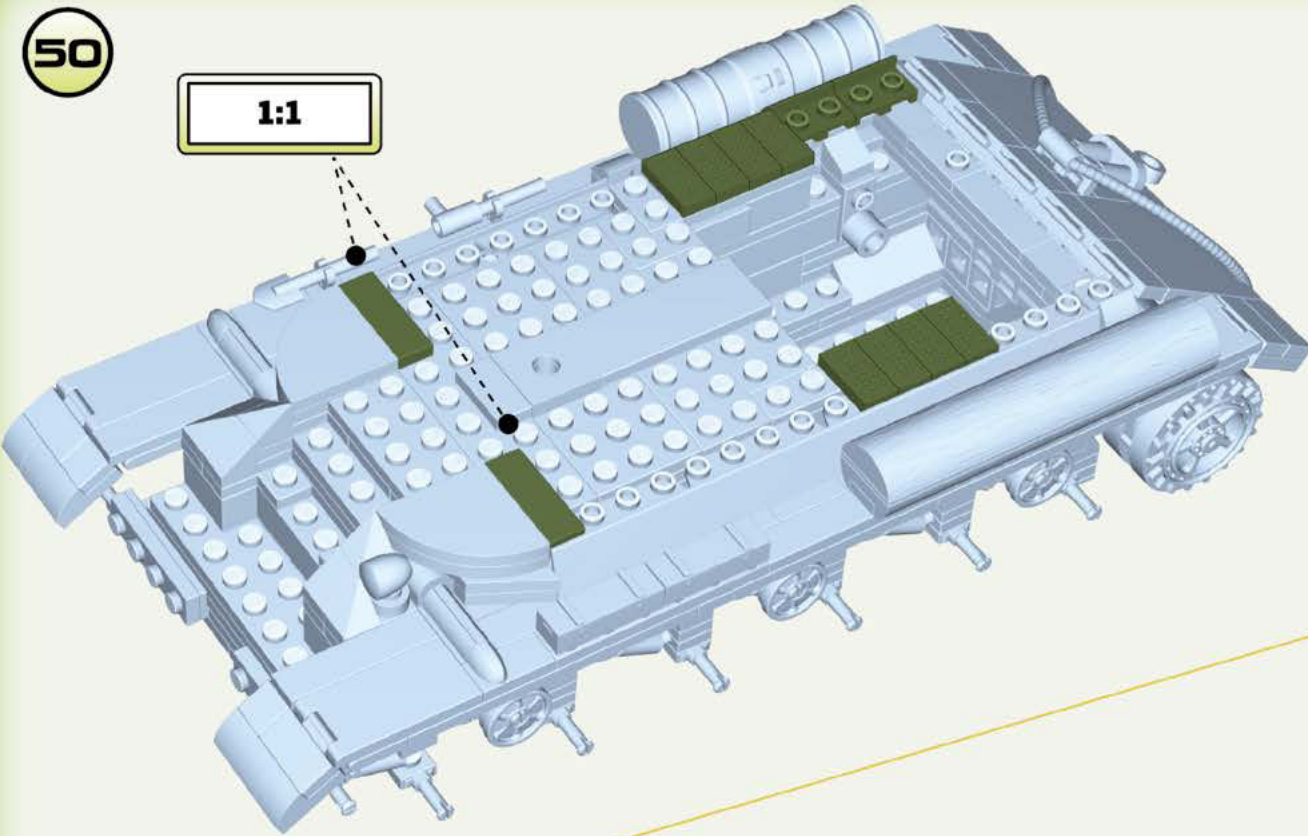

1:1

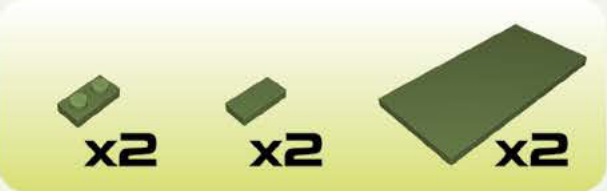

51

52

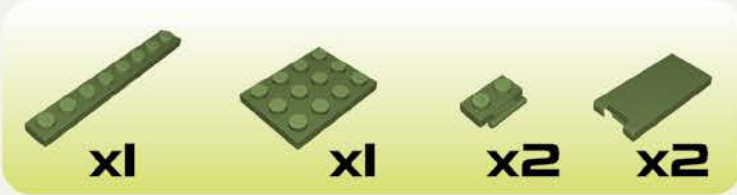
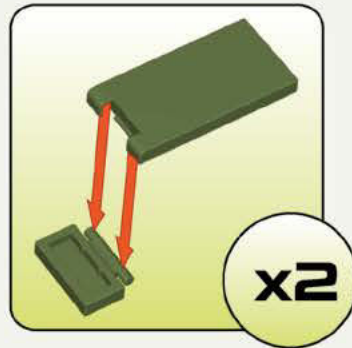
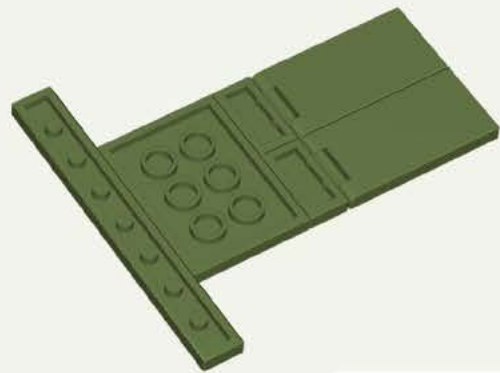

53

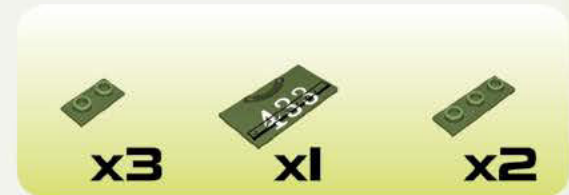
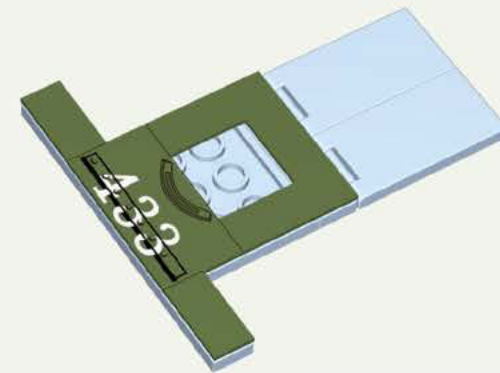

54

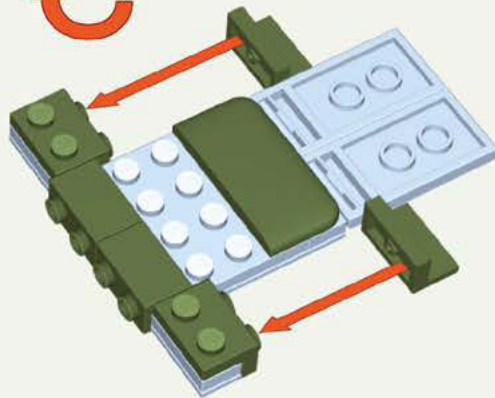

55

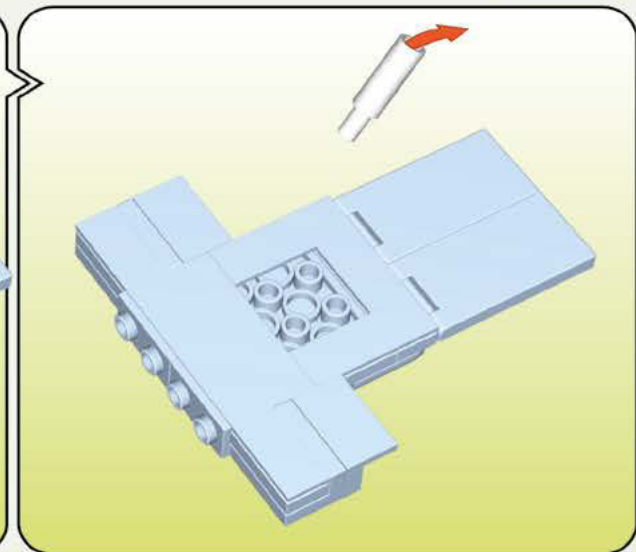
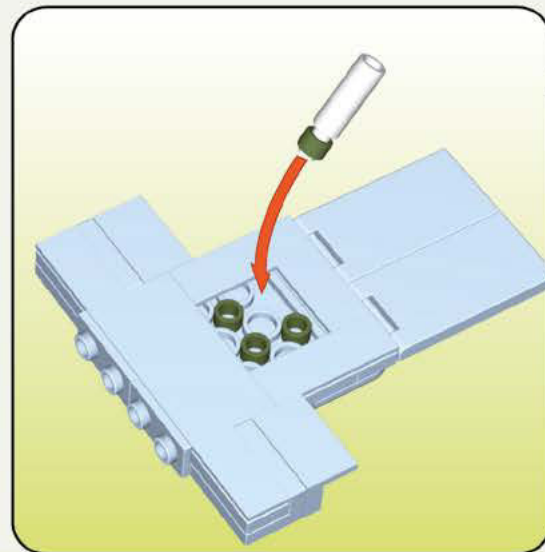

56

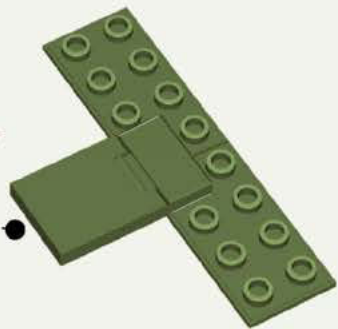

x1



x1



x2



x2

57

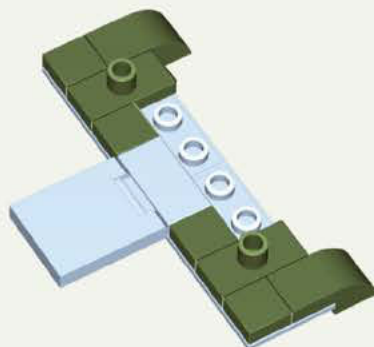

x4



x2



x2

58

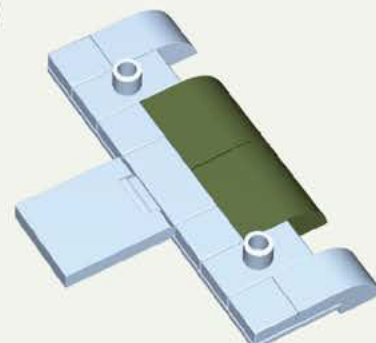

x2

59

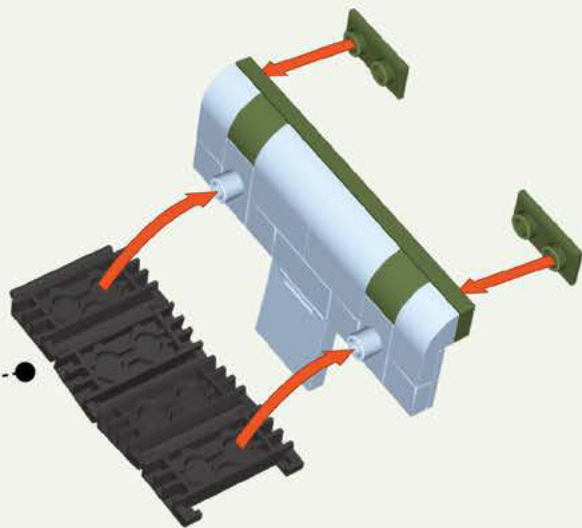
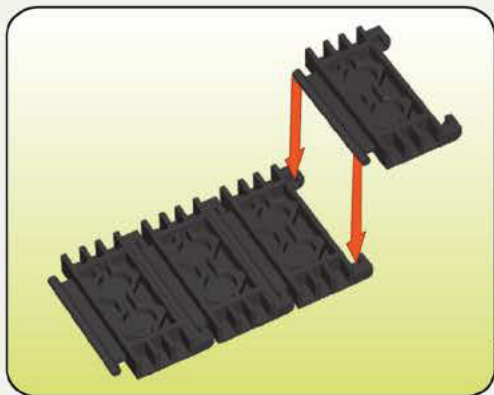

x4



x1



x2



x2

60

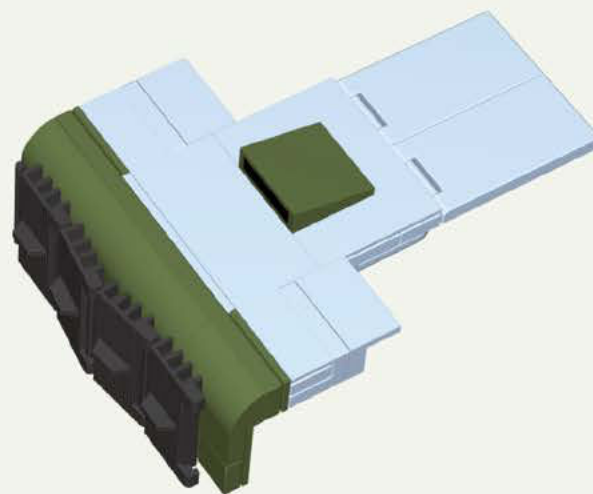

x1

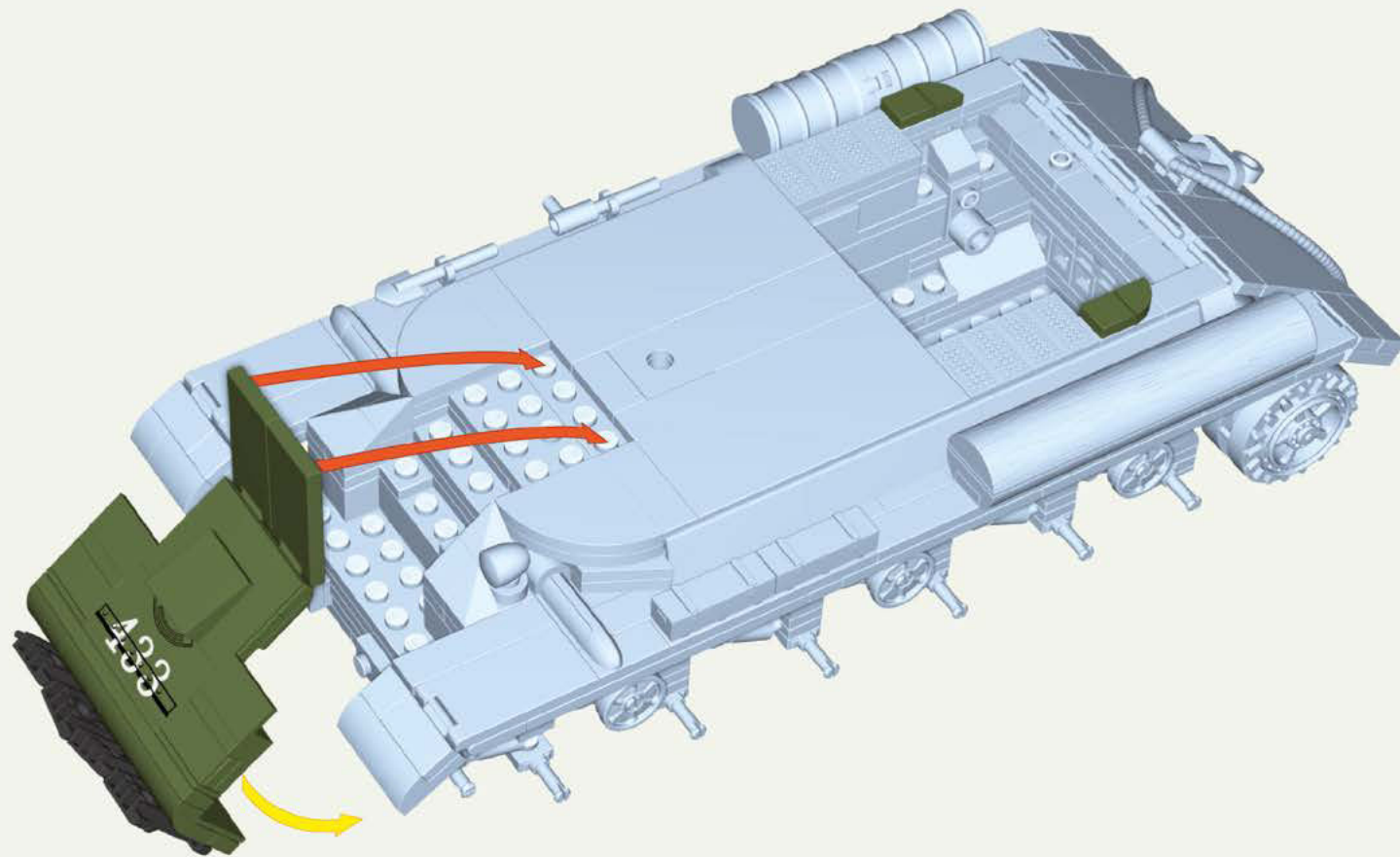

▲ x2 ◆ x2

62

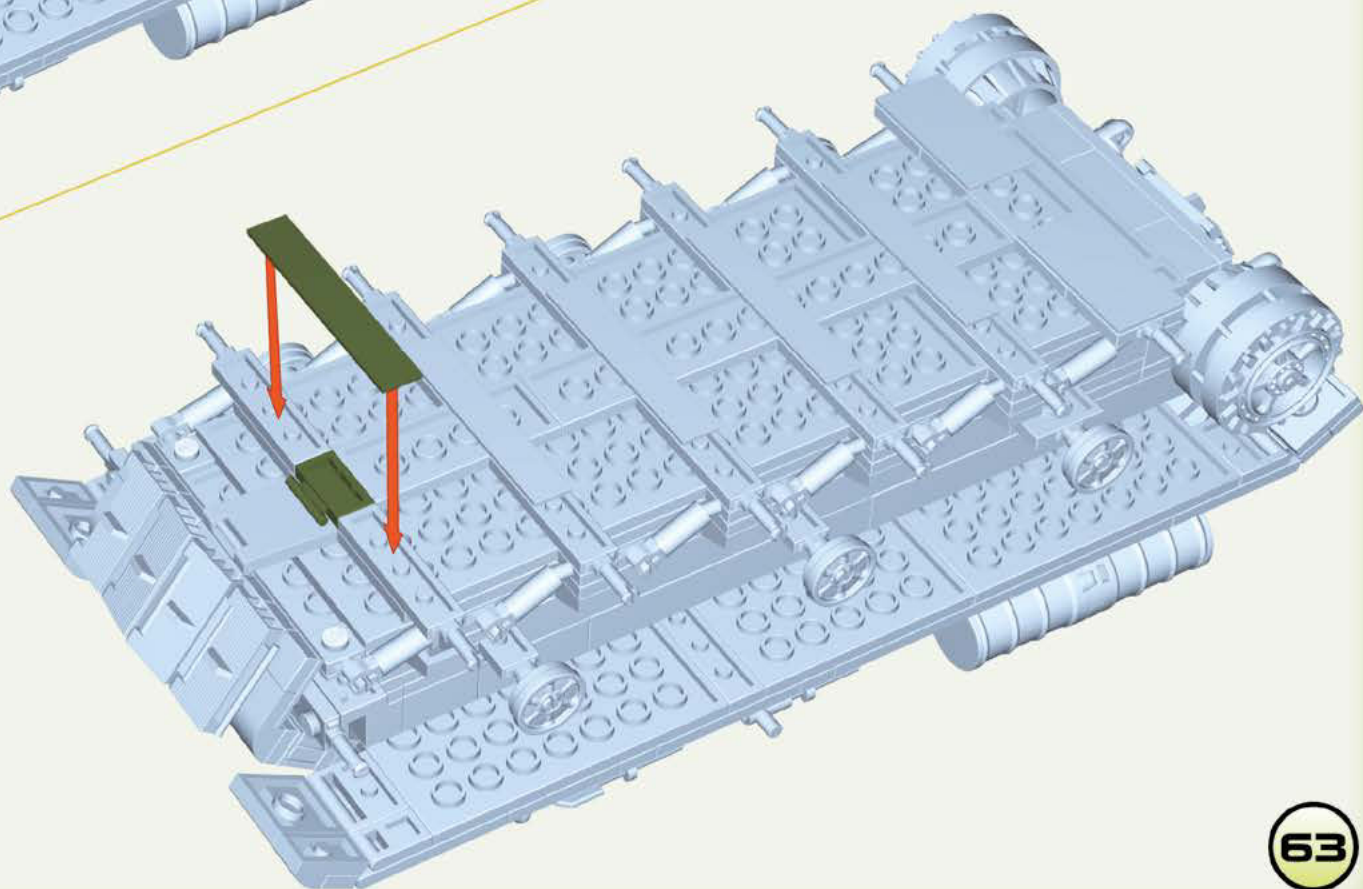

x1





x1

63

64

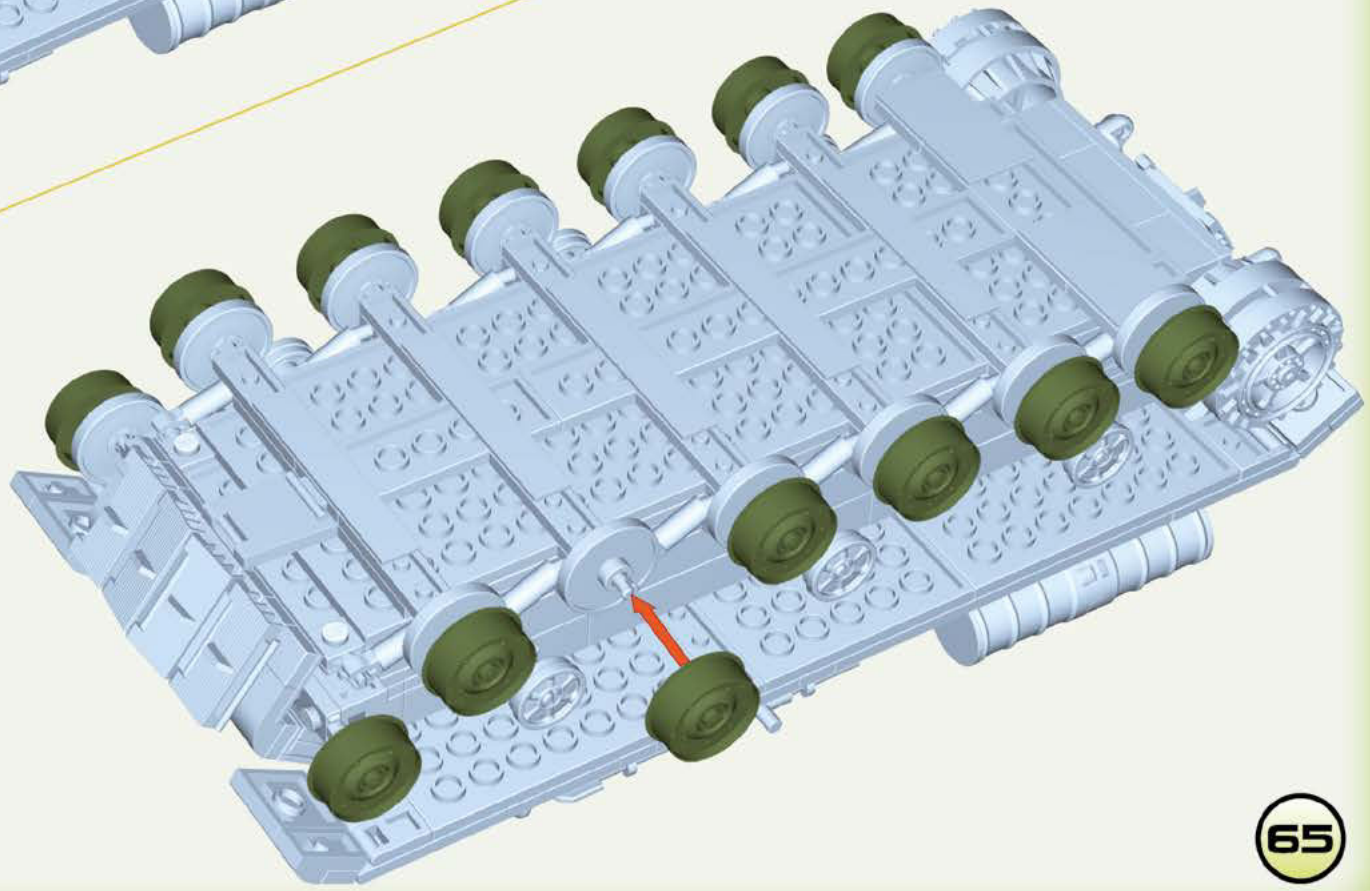
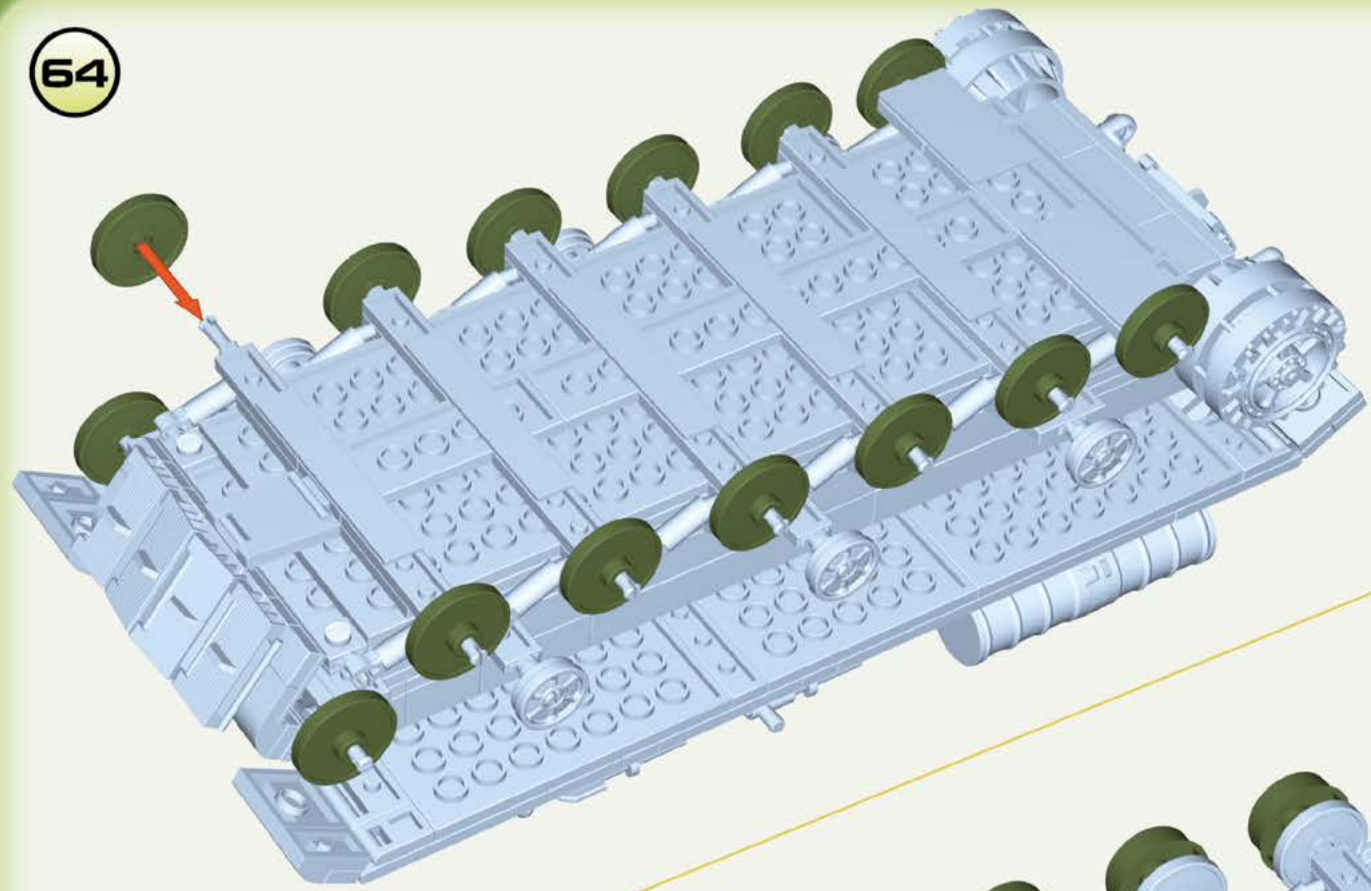
 x14



 x14

 x14  x14

65

66

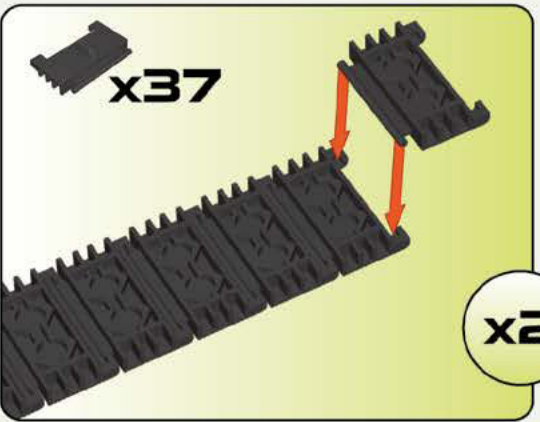
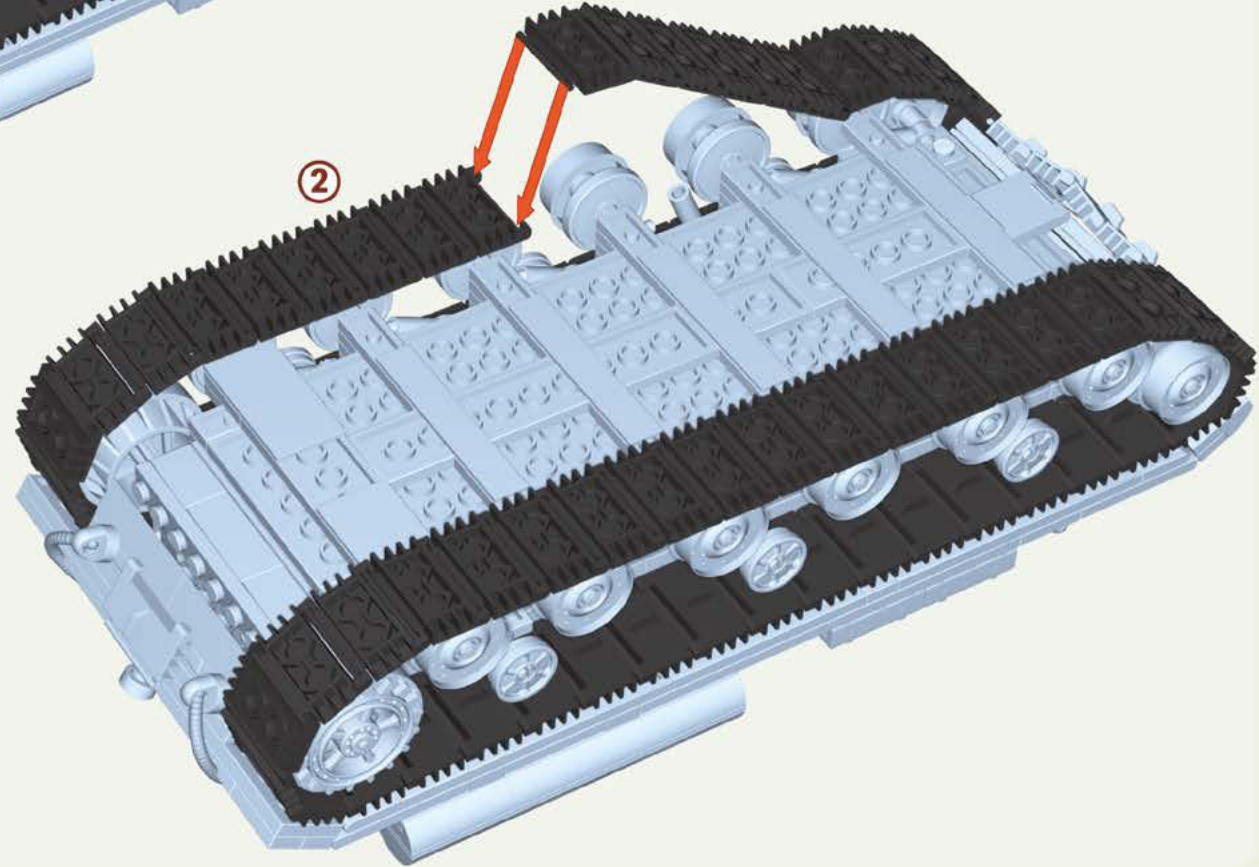
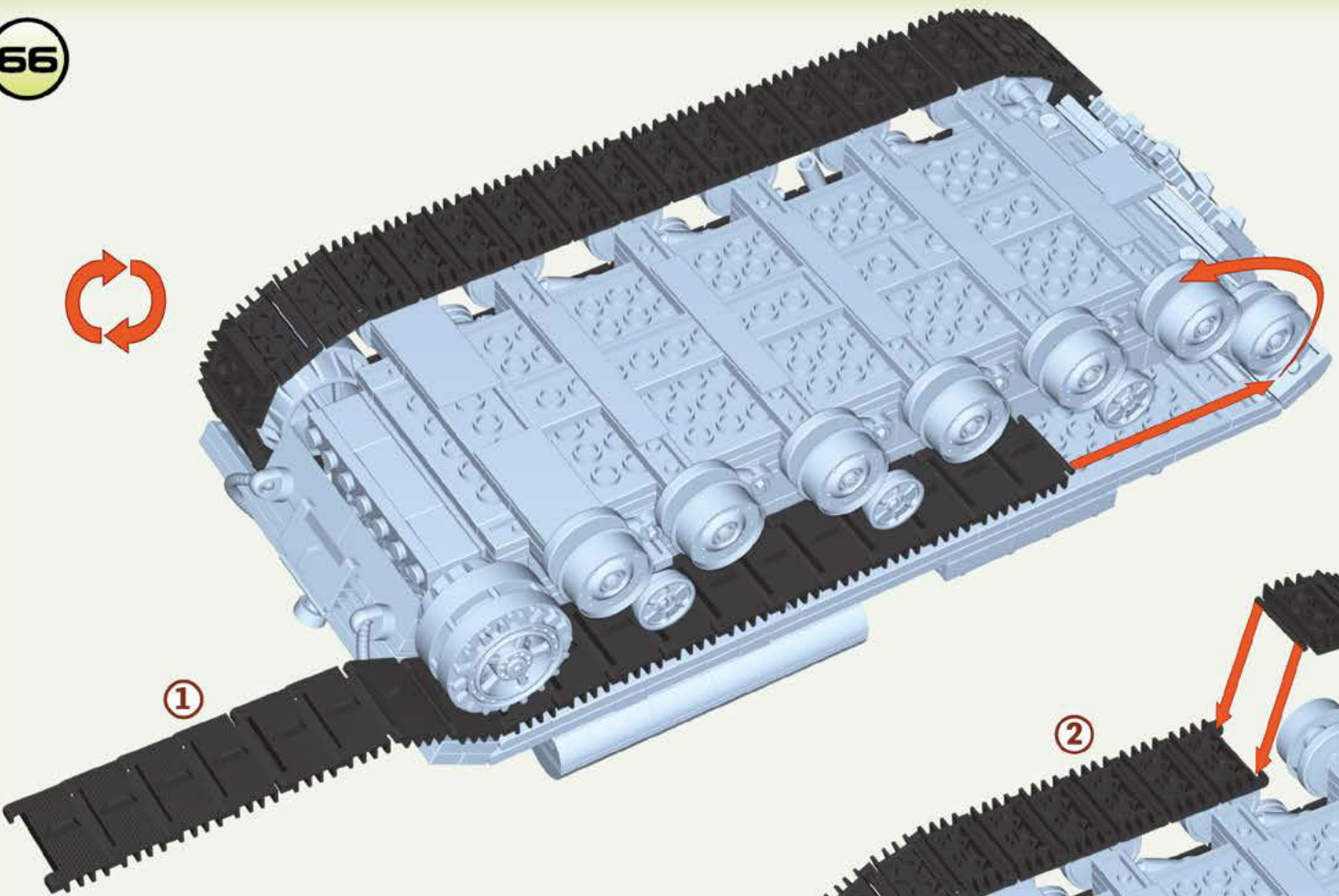

x74



67

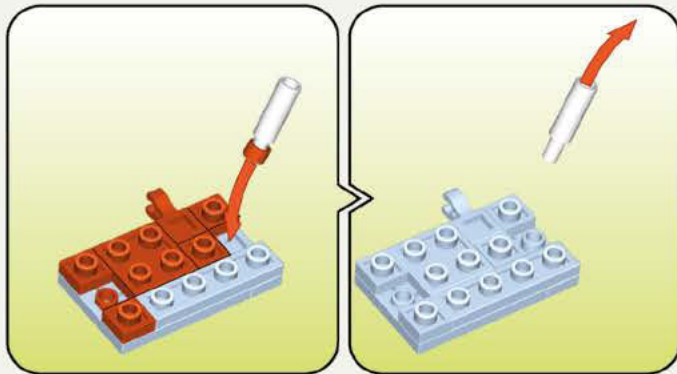

68



69

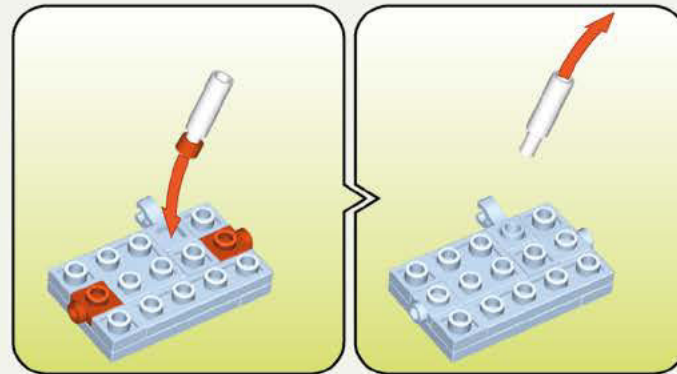

70



71



72



73

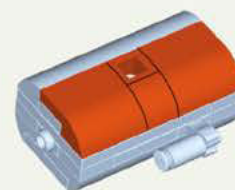

74

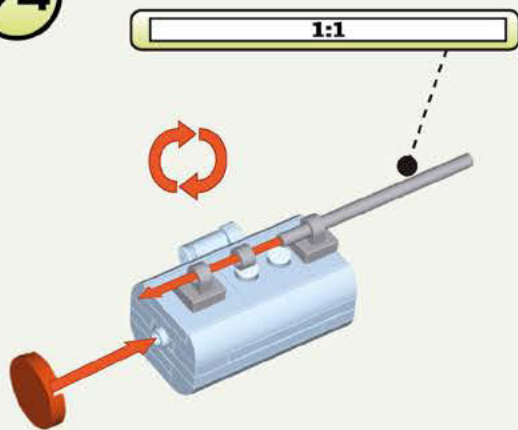

75

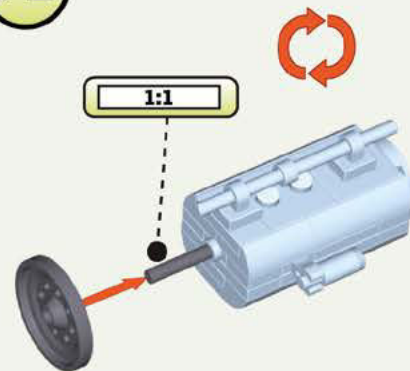

76

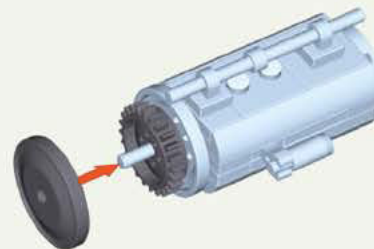

77

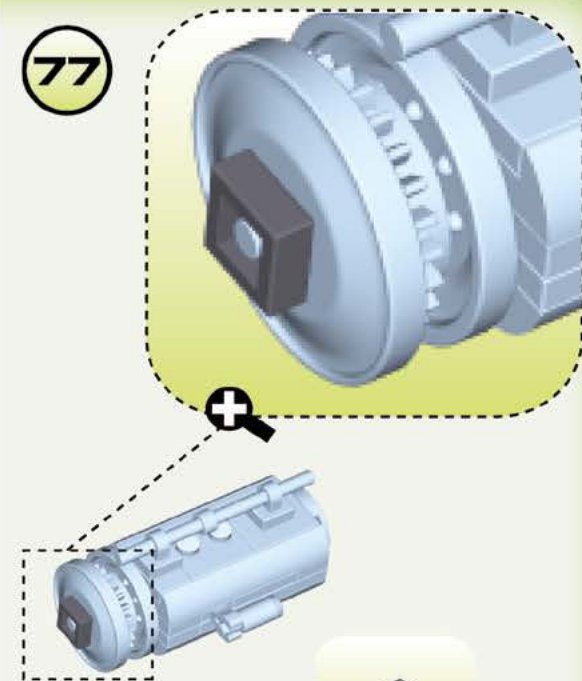

78



79



80



81

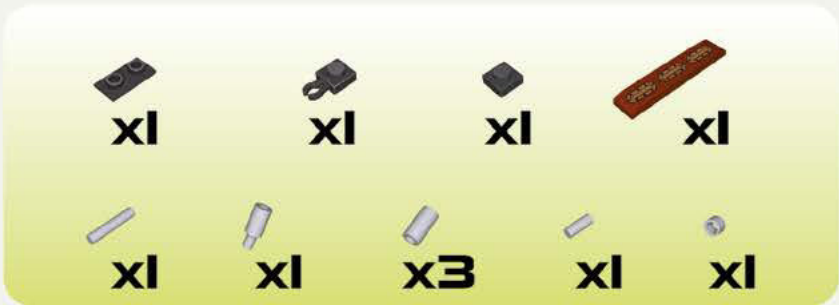
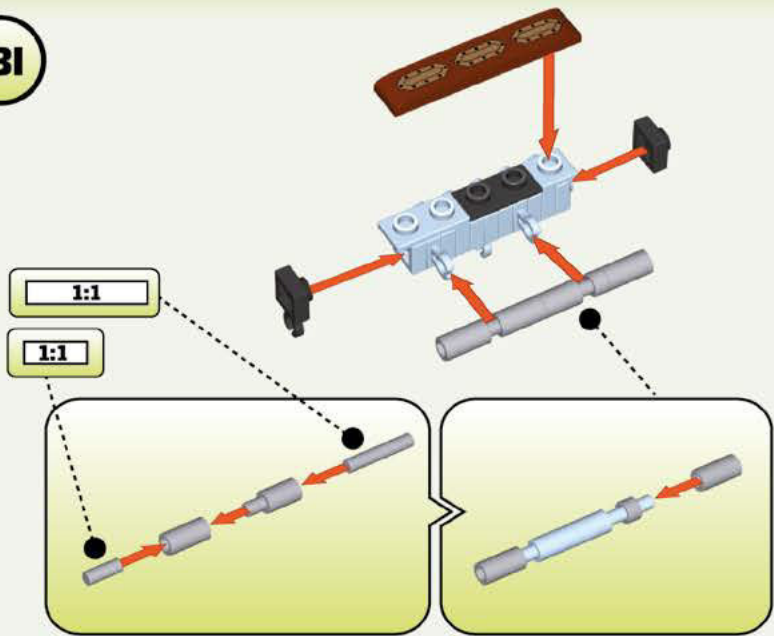

82

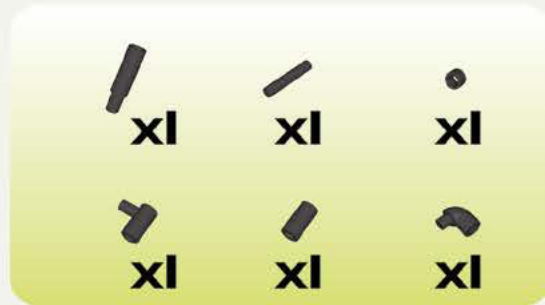
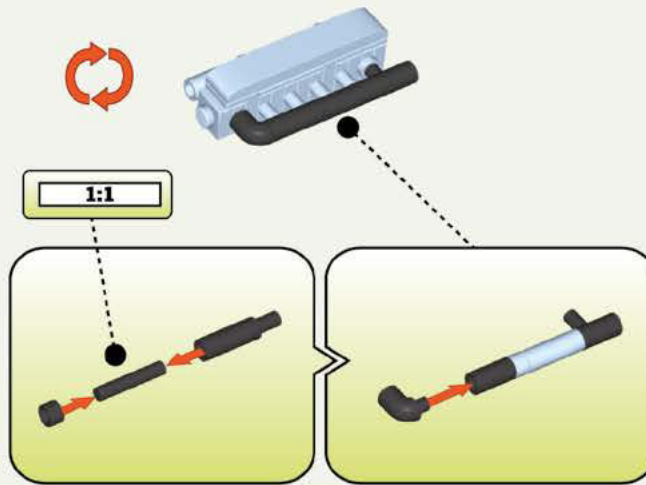

83



84



85



86



87

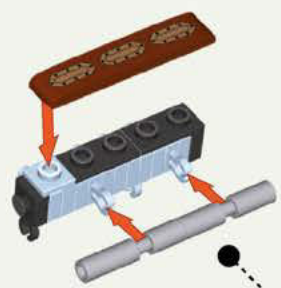

1:1

1:1

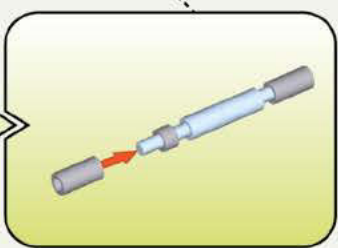
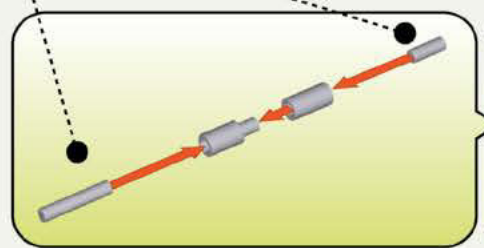

- 1x1
- 1x1
- 1x1
- 1x1
- 1x1
- 1x1
- 3x1
- 1x1
- 1x1

88



1:1

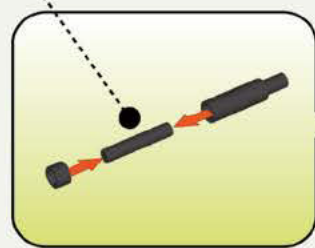

- 1x1
- 1x1
- 1x1
- 1x1
- 1x1
- 1x1

89

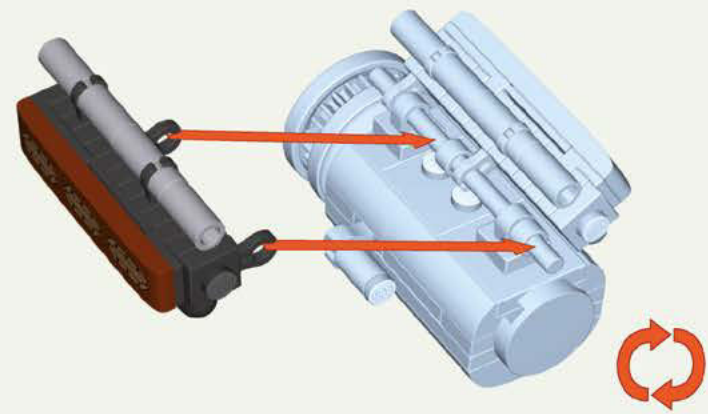

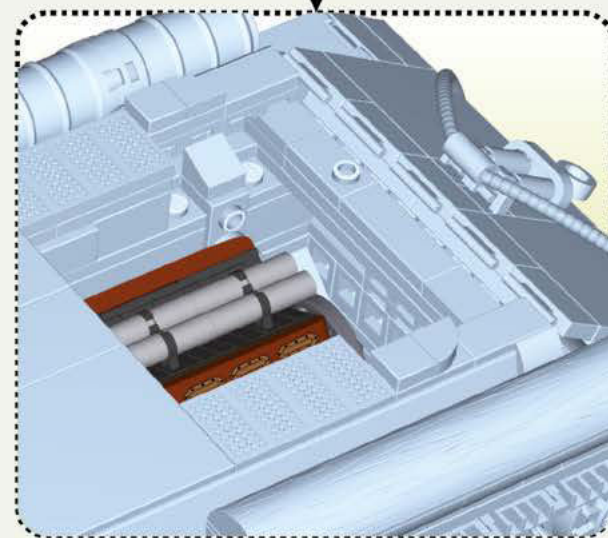
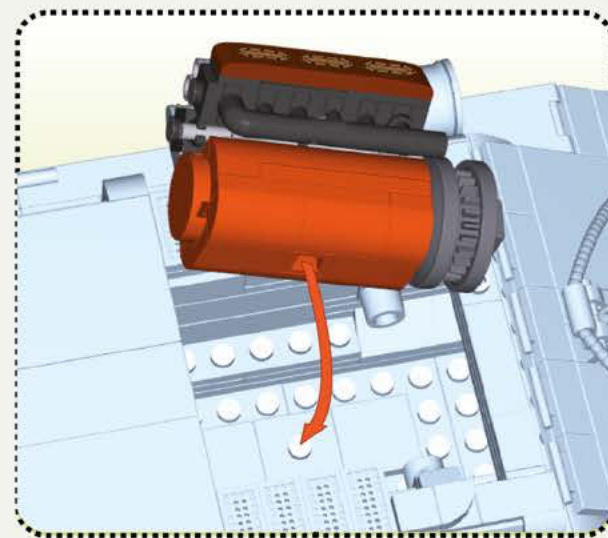
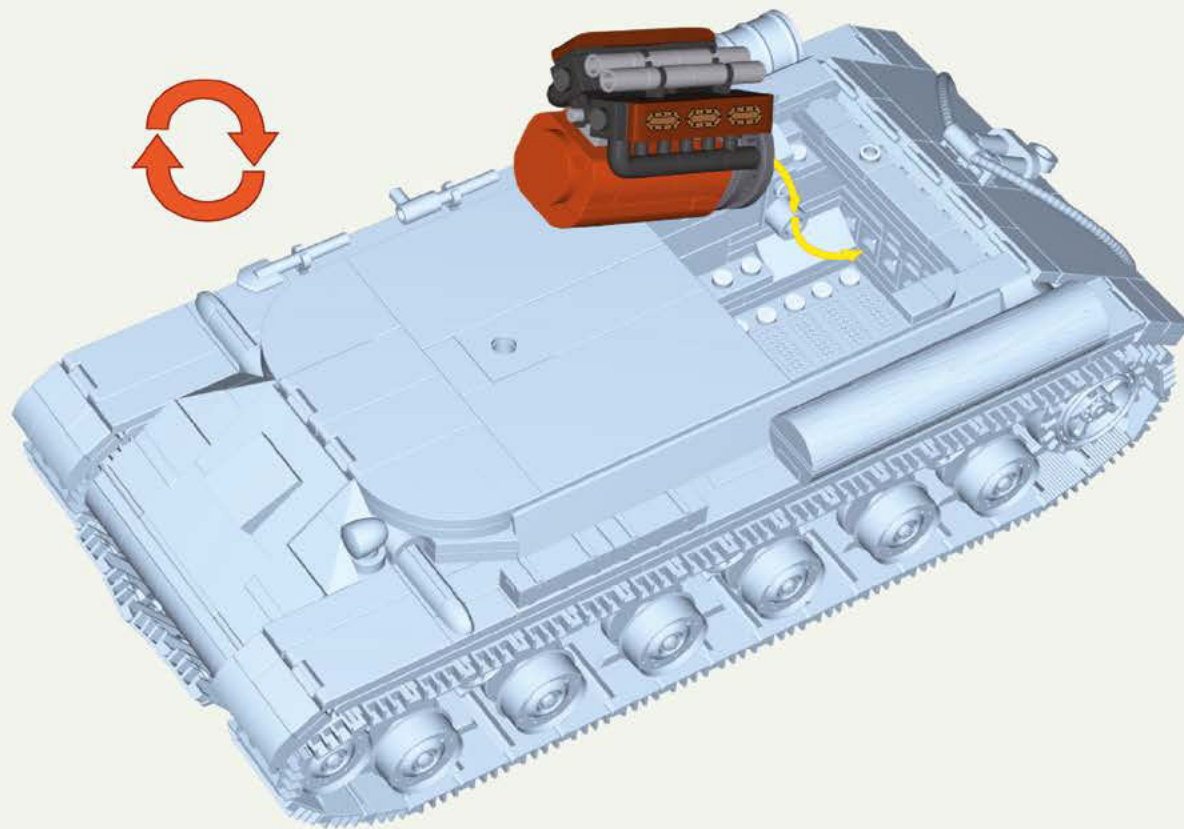



91

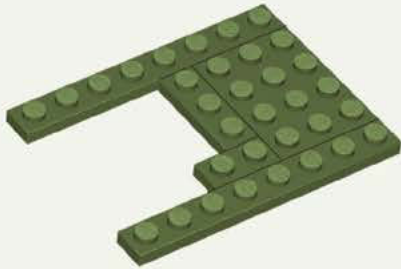

92

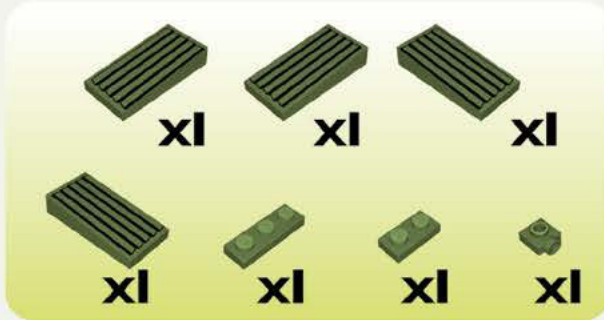

93

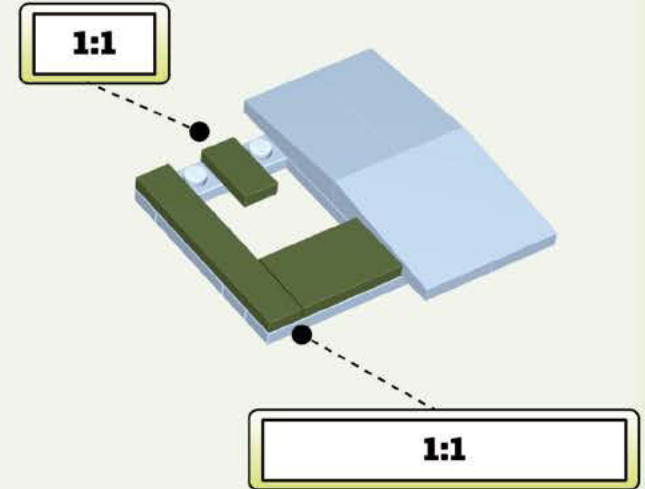

94

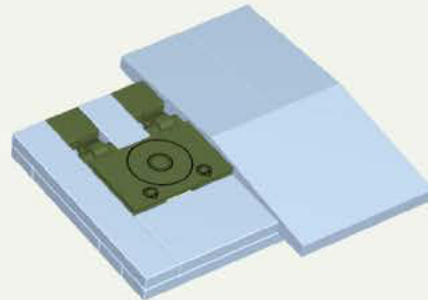
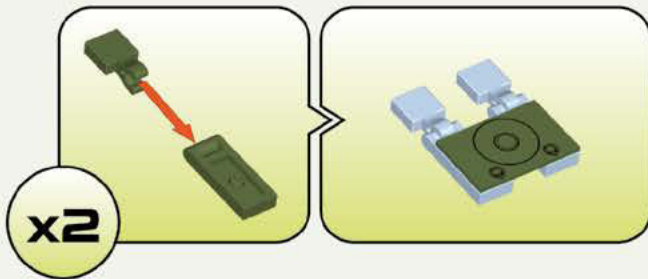

95

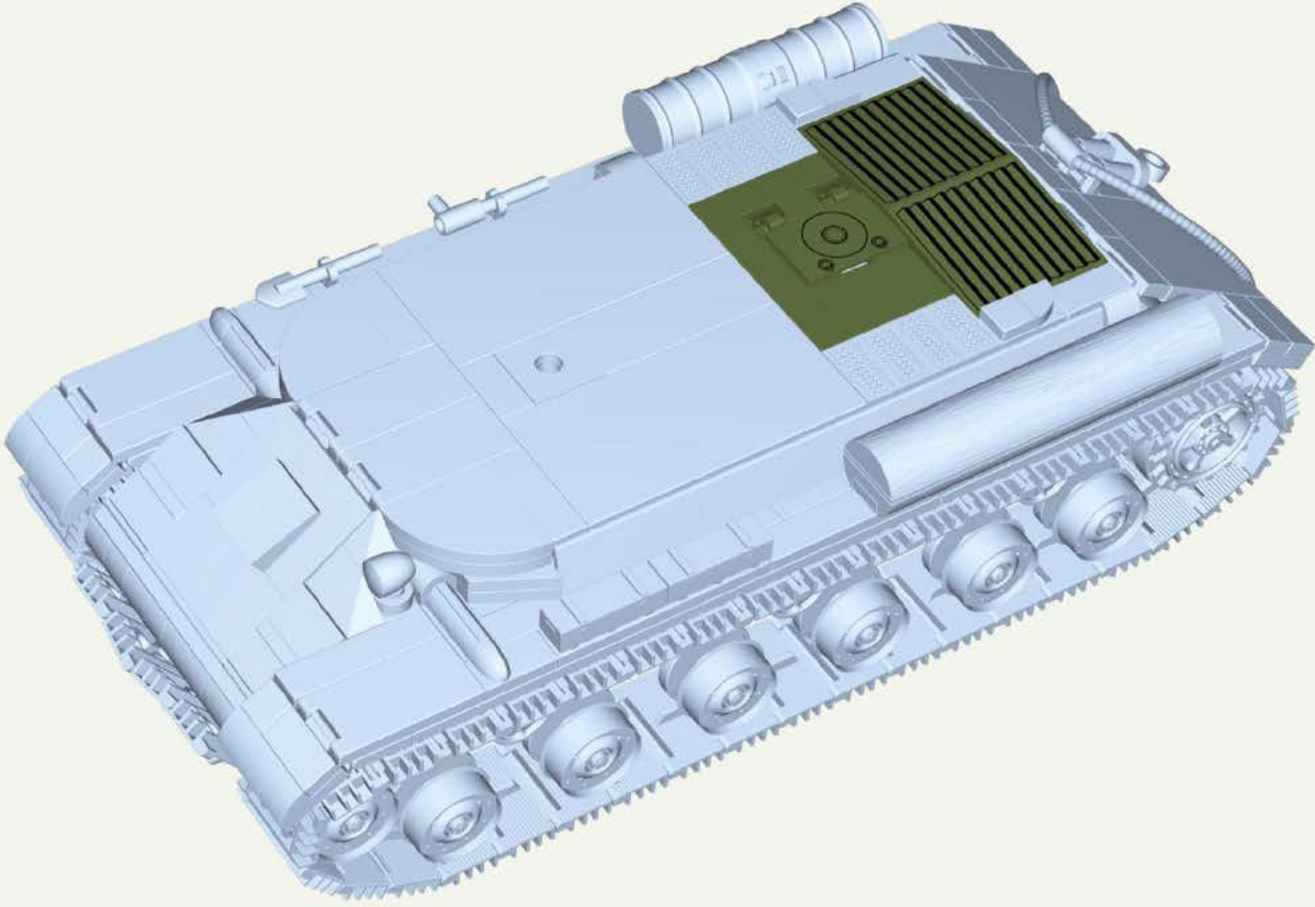

96

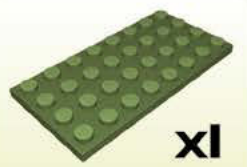

x1



x1



x2

97



1:1



x4



x2

98



- x1
- x5

99

1:1

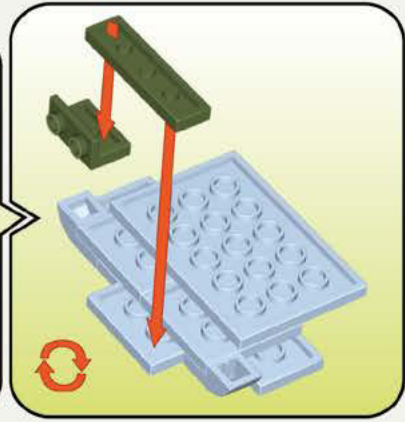
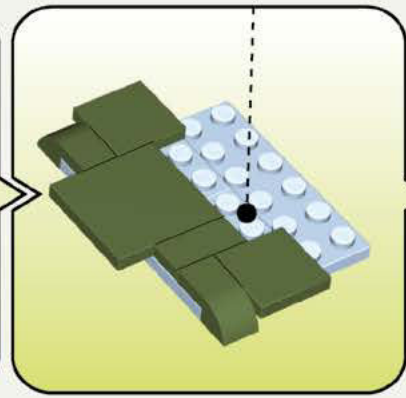
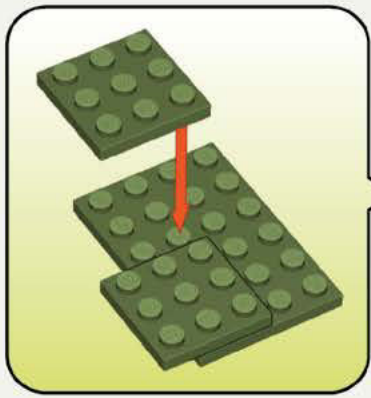

- x1
- x2
- x1
- x2
- x1
- x2
- x1
- x1

100

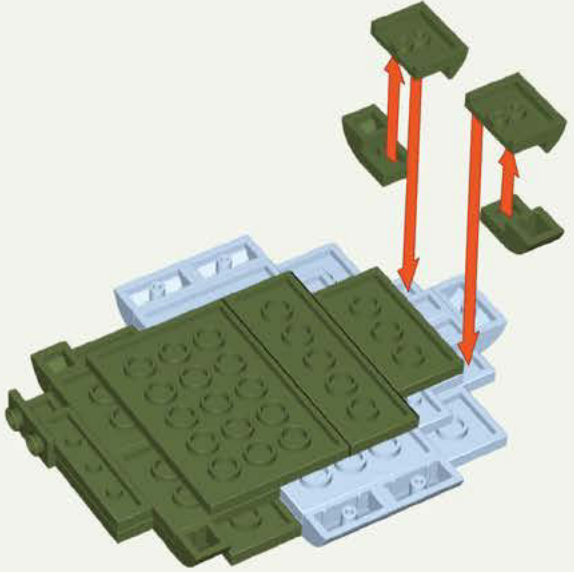

- x1
- x1
- x2
- x2

101

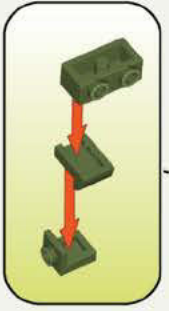

- x4
- x2
- x2
- x2
- x2
- x1
- x2

102

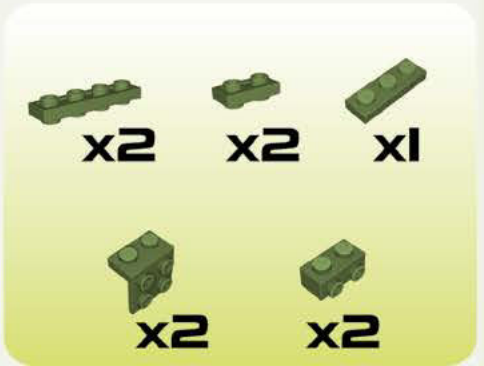
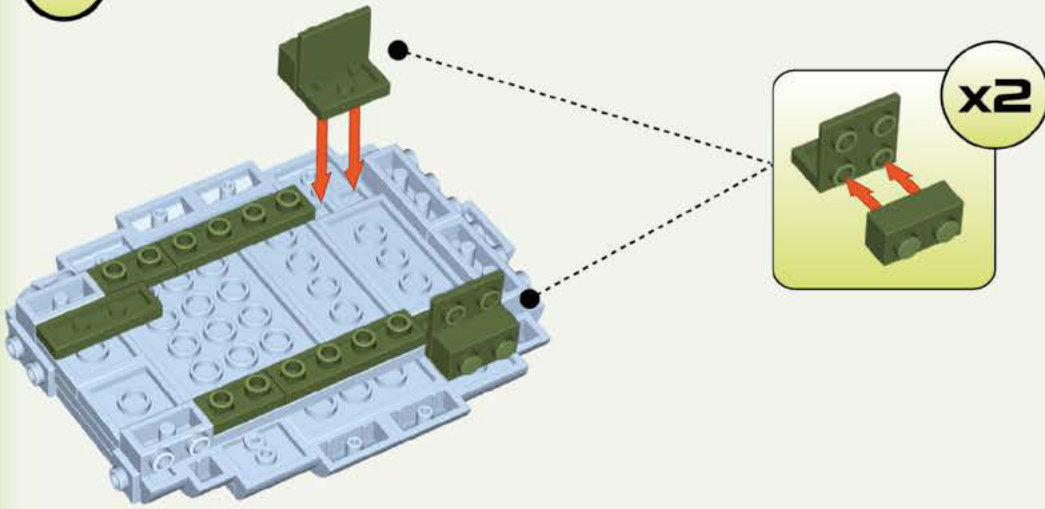

103

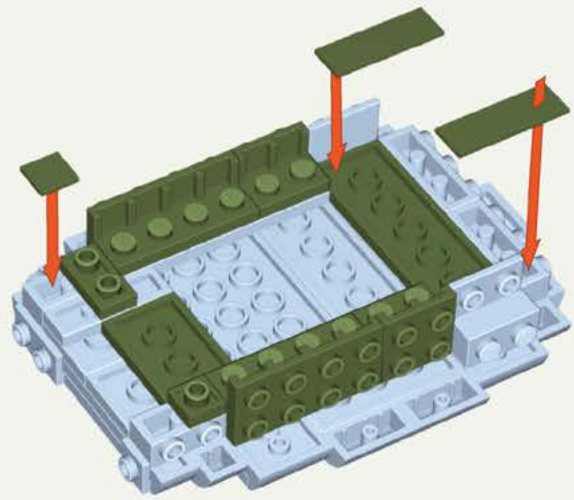

104

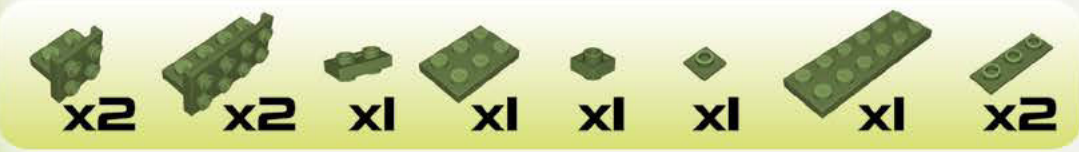
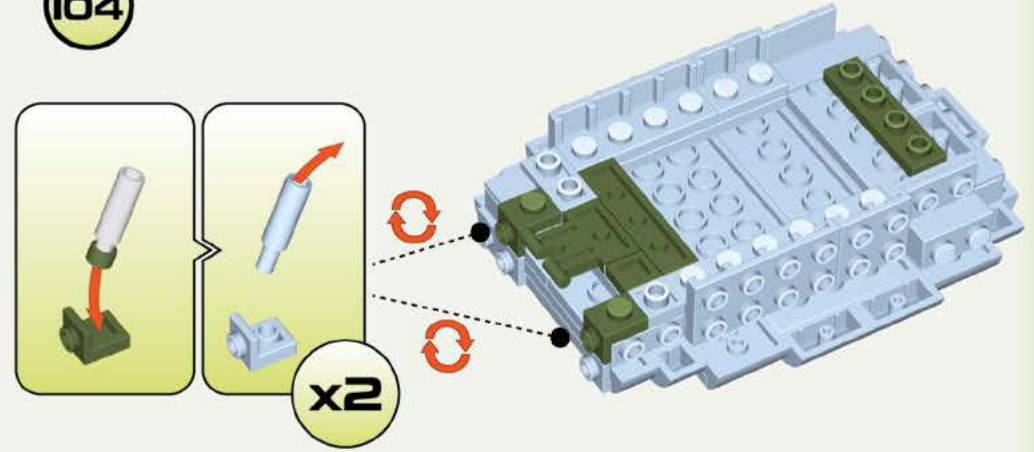

105

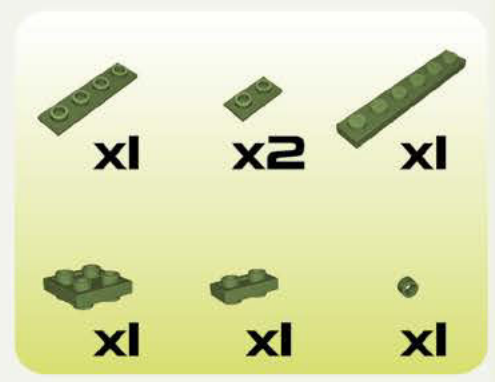
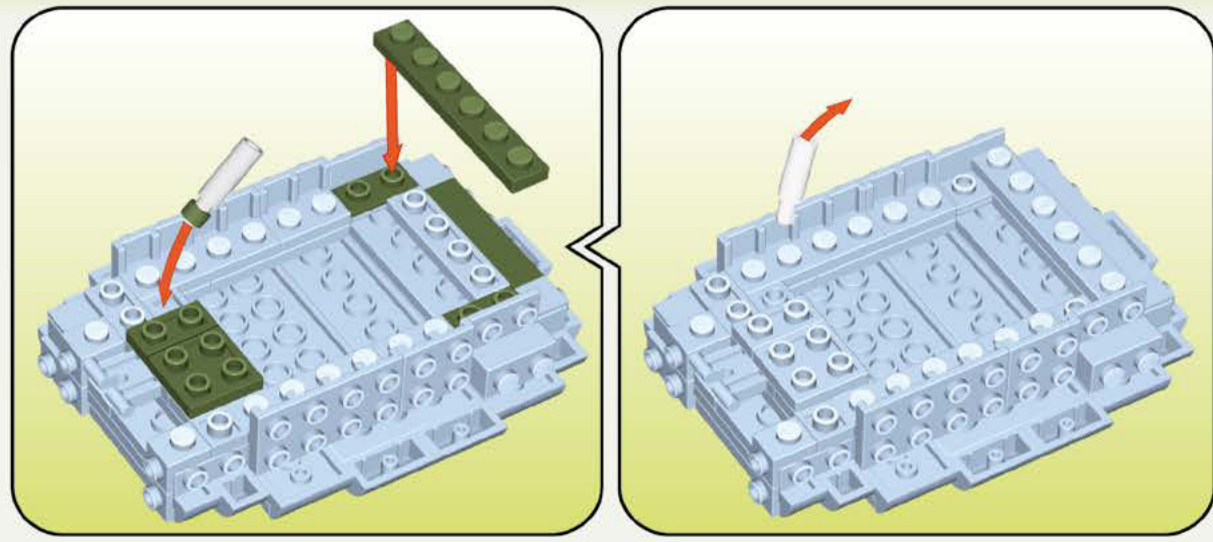

106

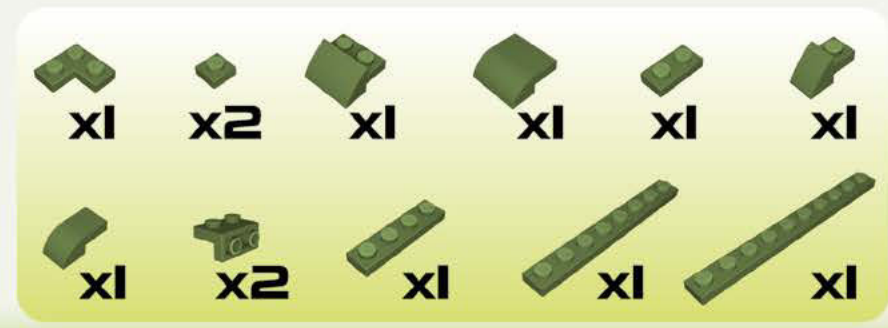
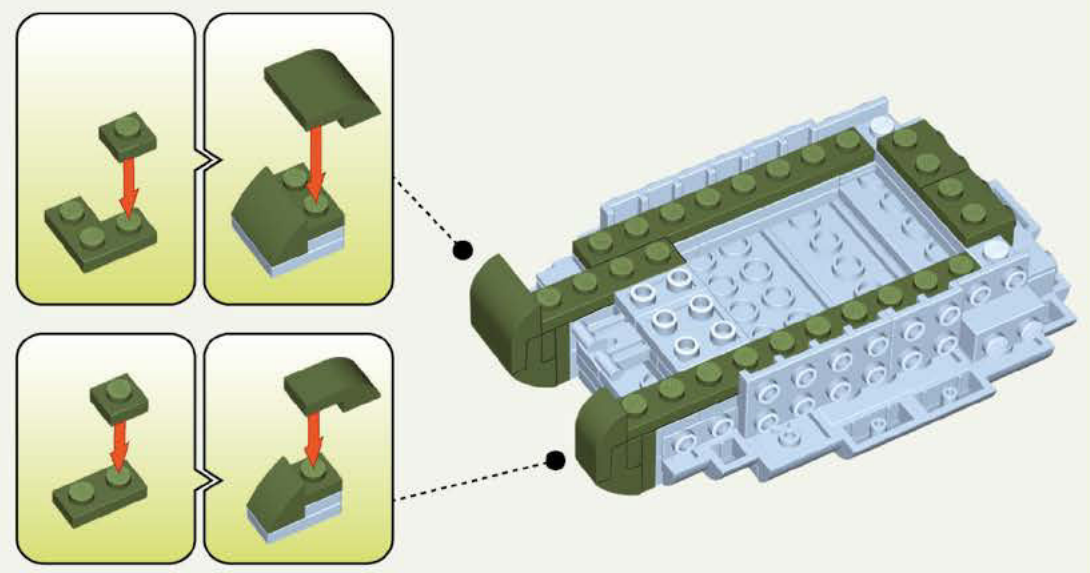

107

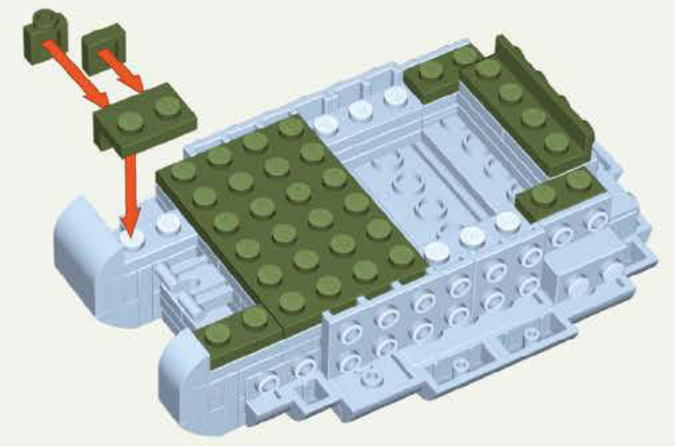

108

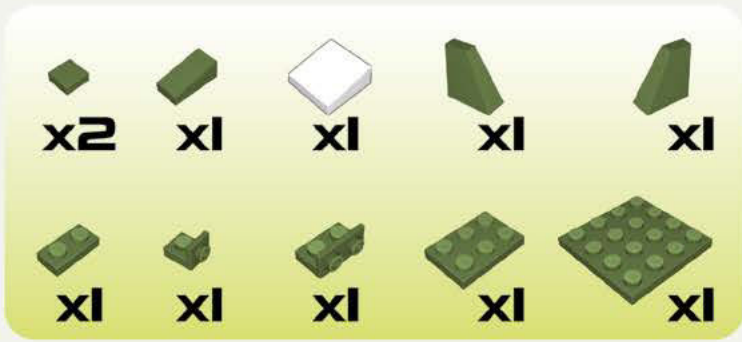
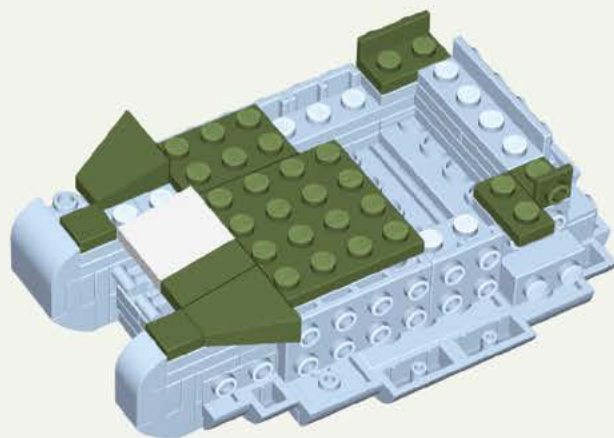

109

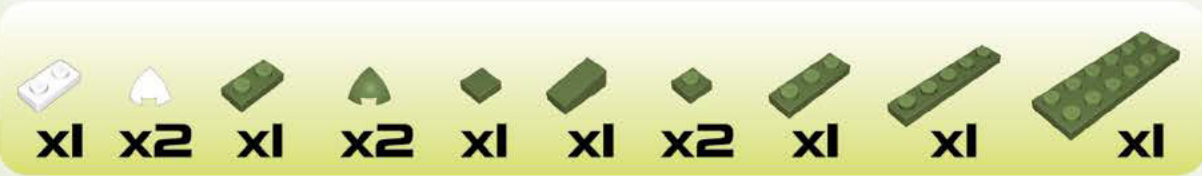
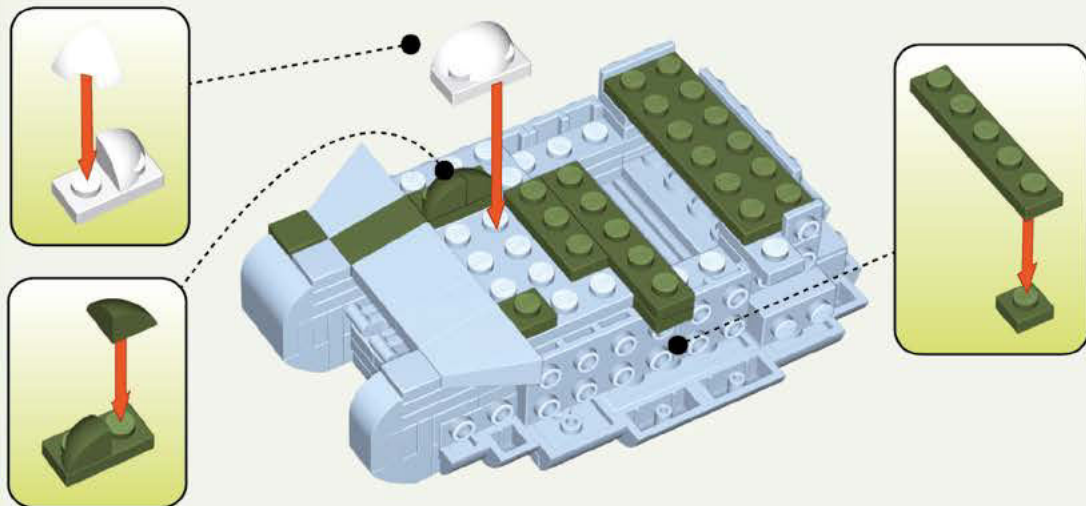

110

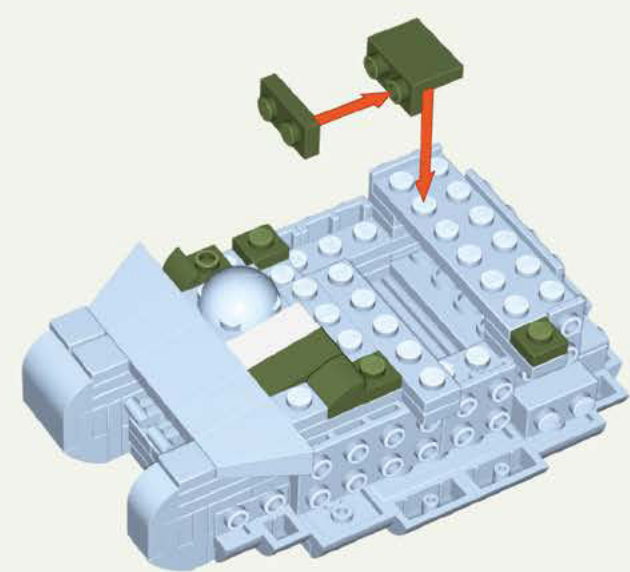

III

1:1

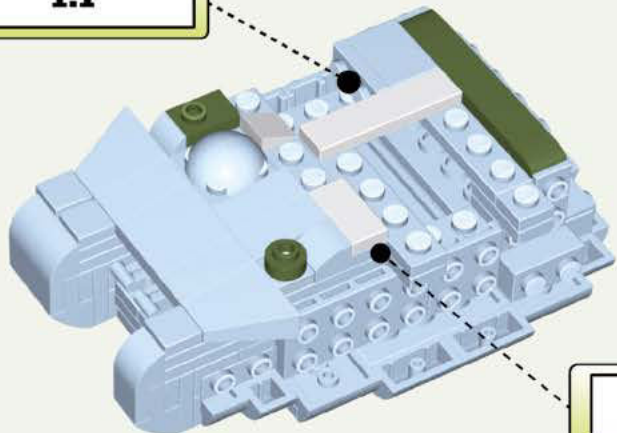

1:1



II2

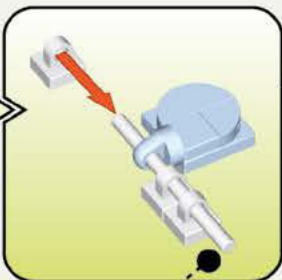
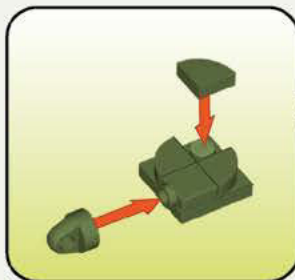

1:1

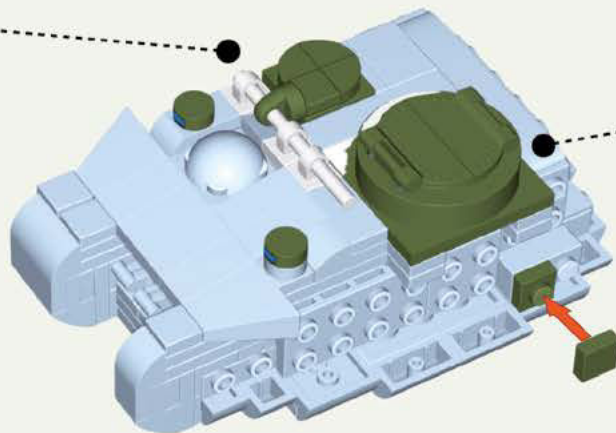

113

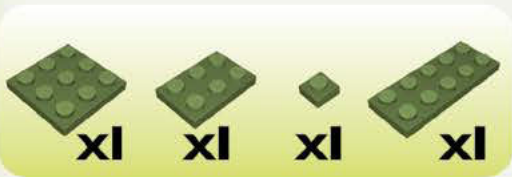
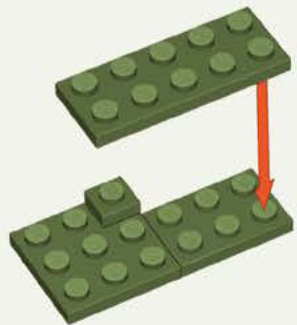

114

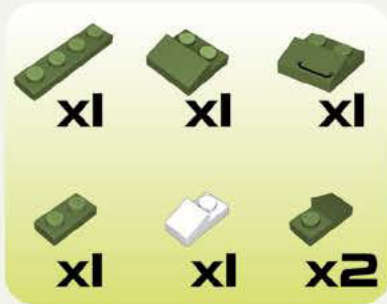
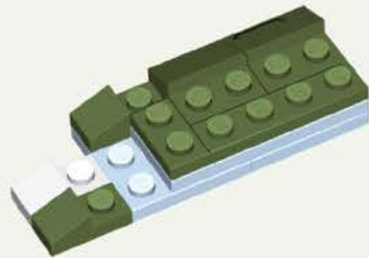

115

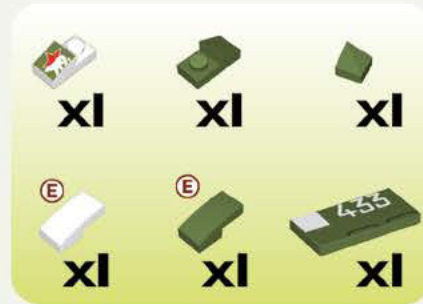
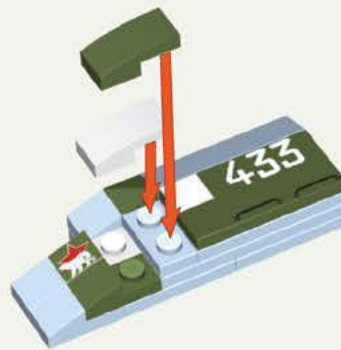

116

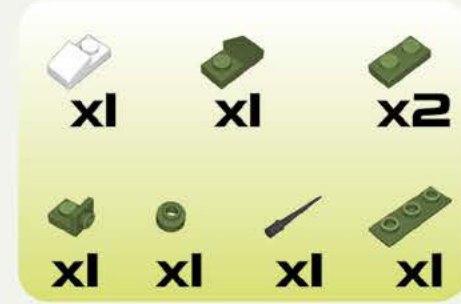
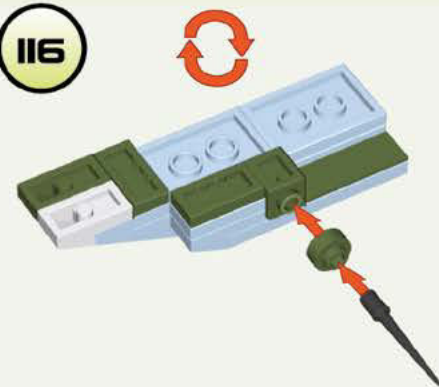

117



118

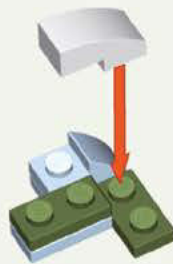

119

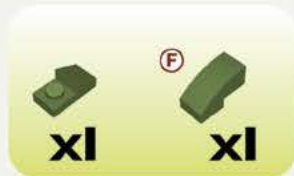
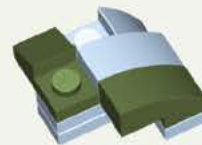

120

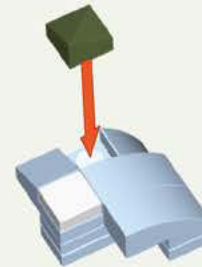

121

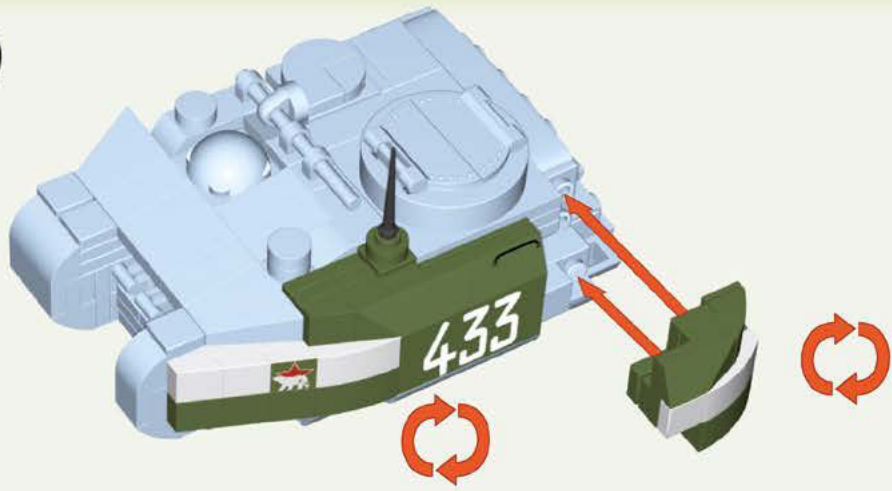

122



123

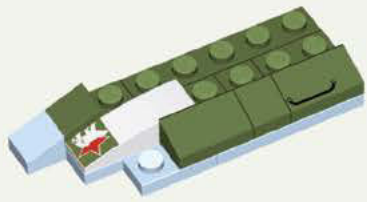

124

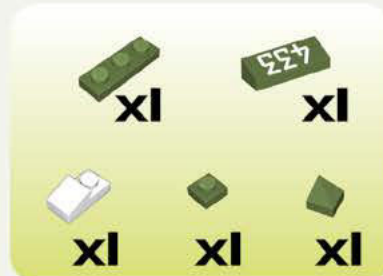
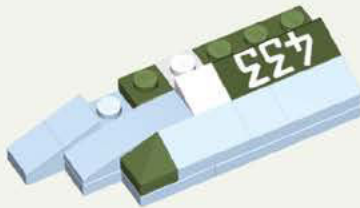

125

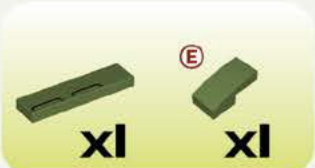
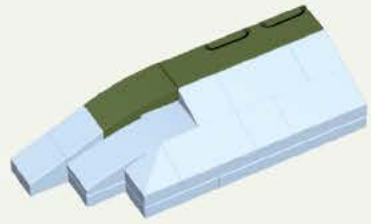

126

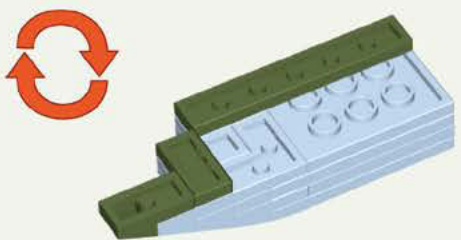

127

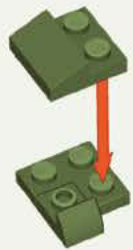

128



129

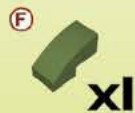
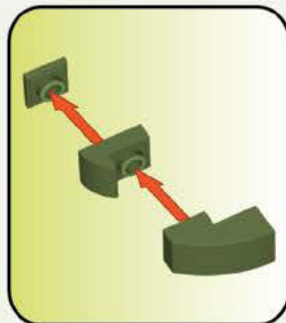
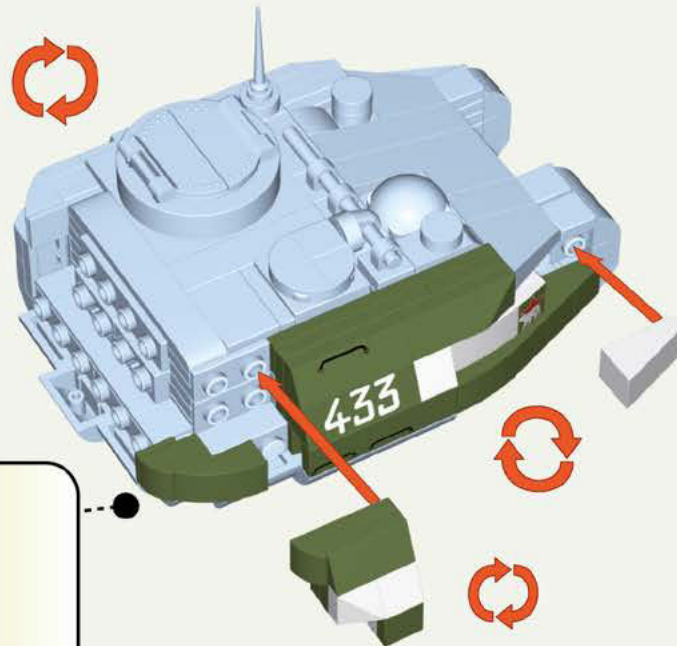

130

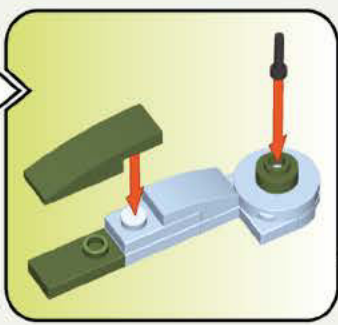
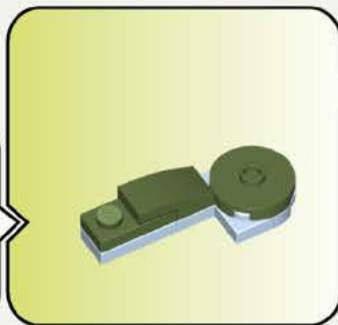
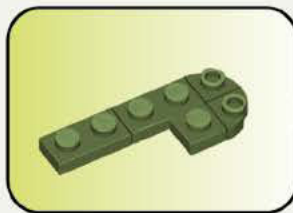

131

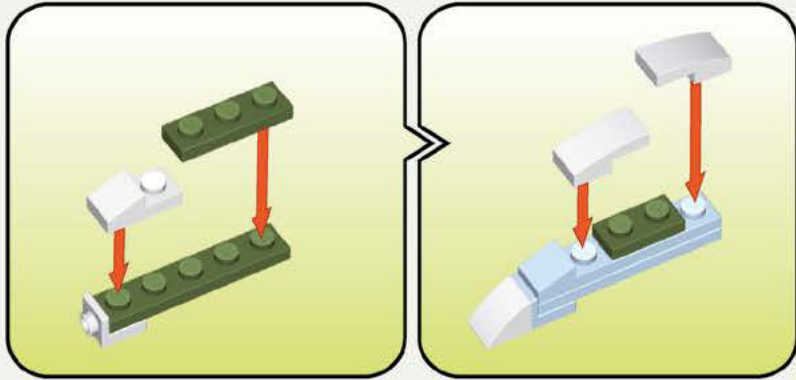

132

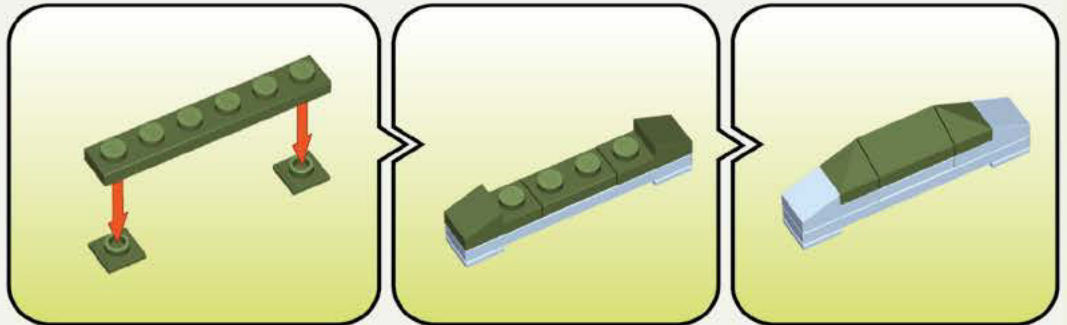

133

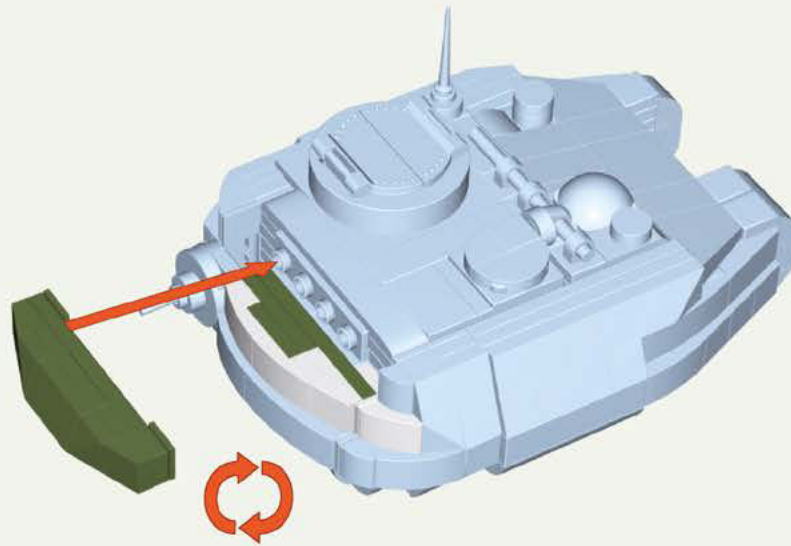

134

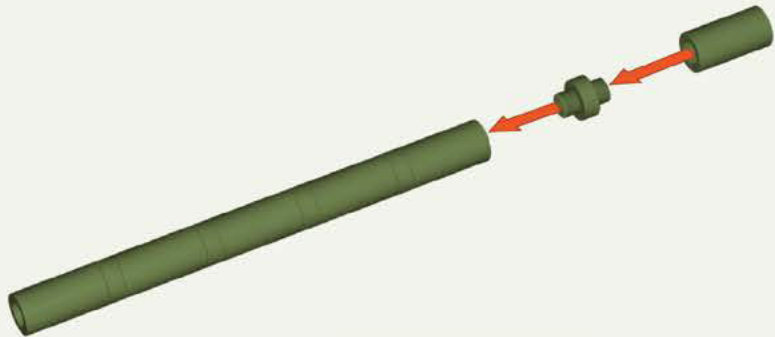

135

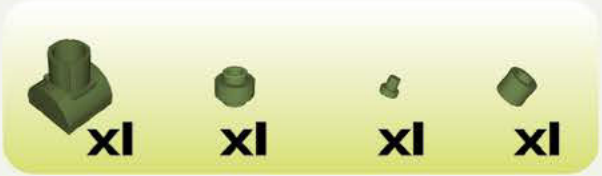
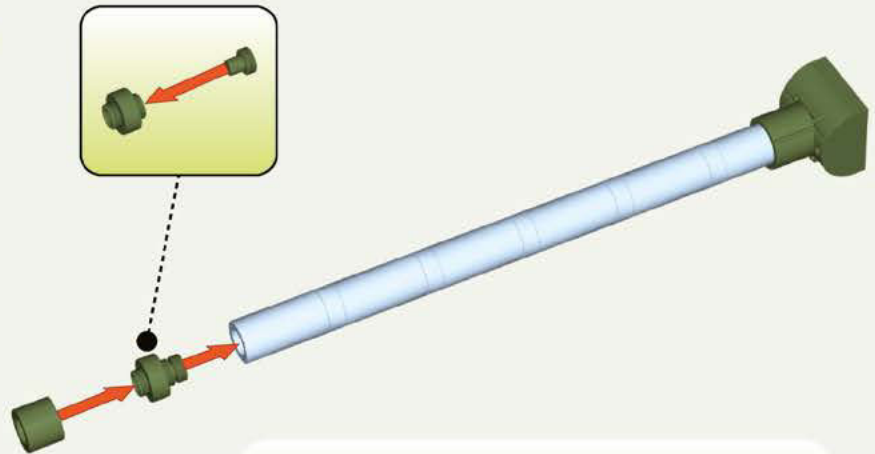

136

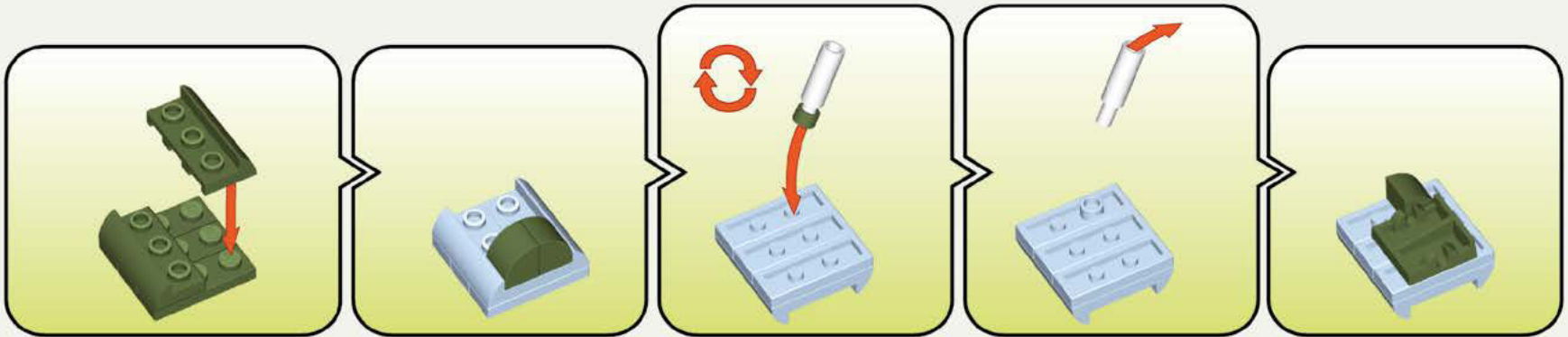

137

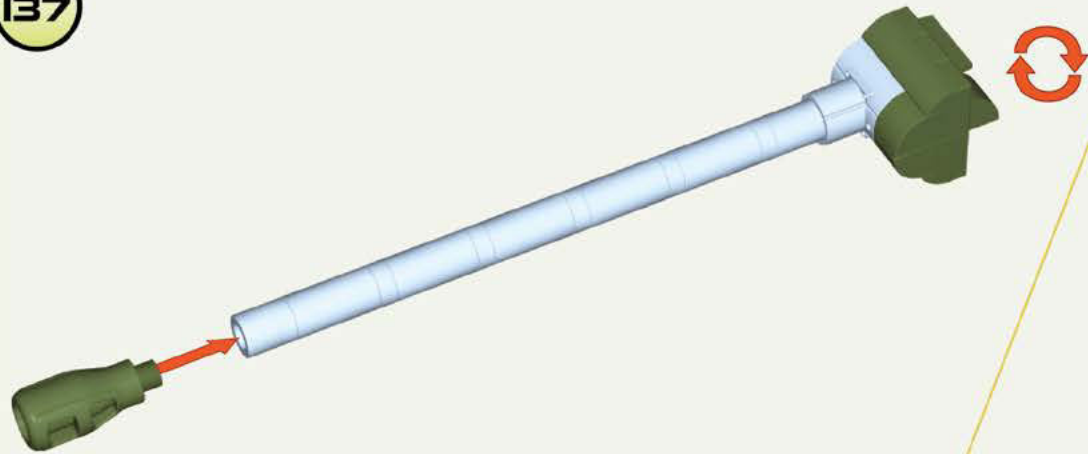

138

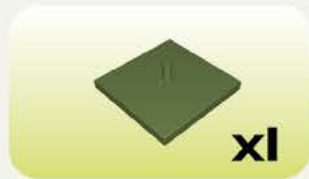
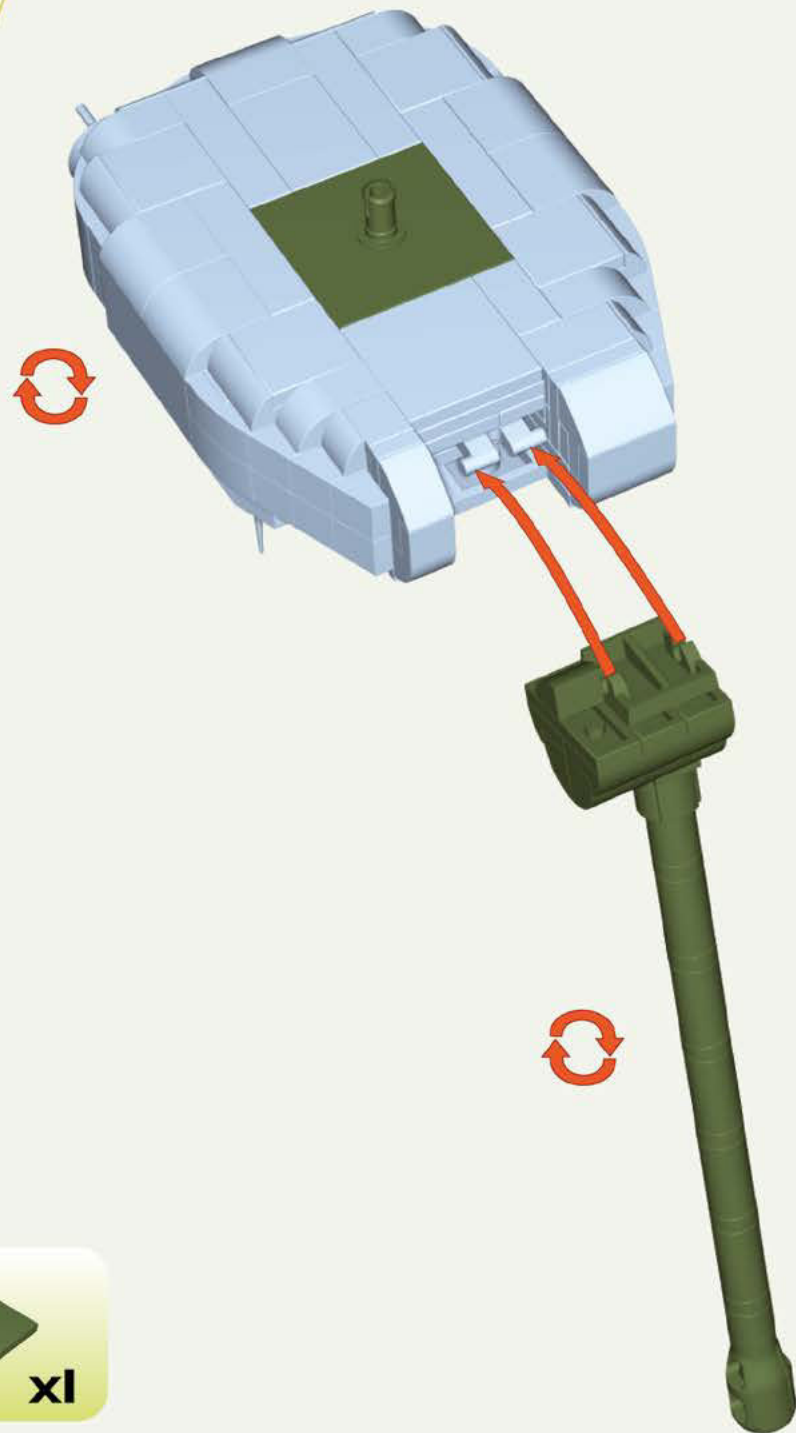

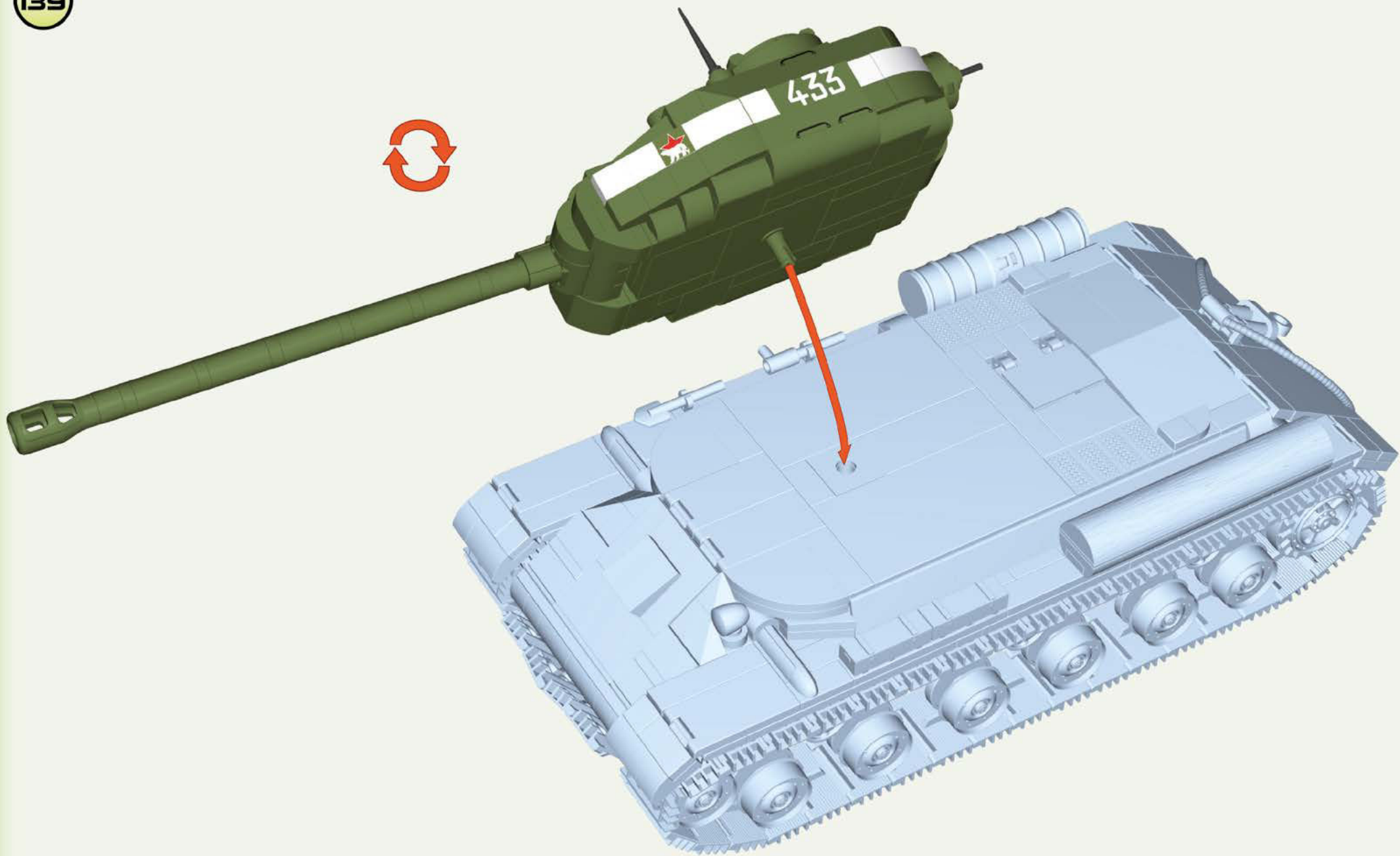

143

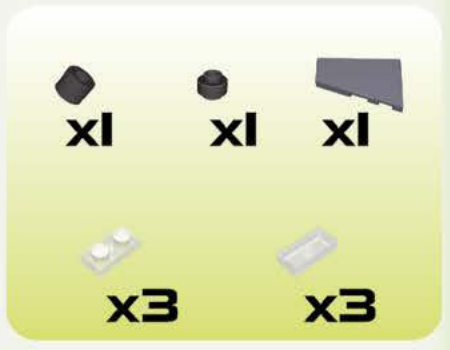
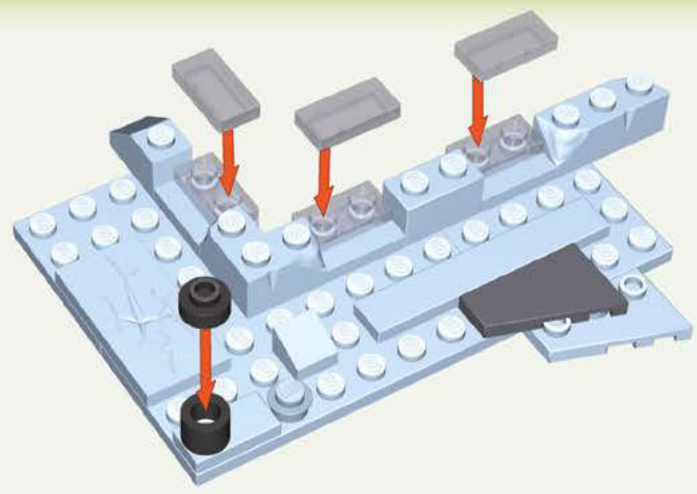

144

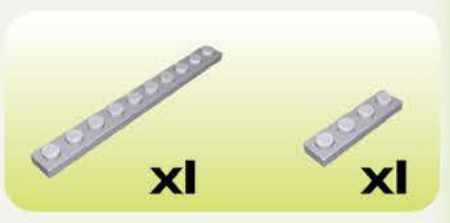
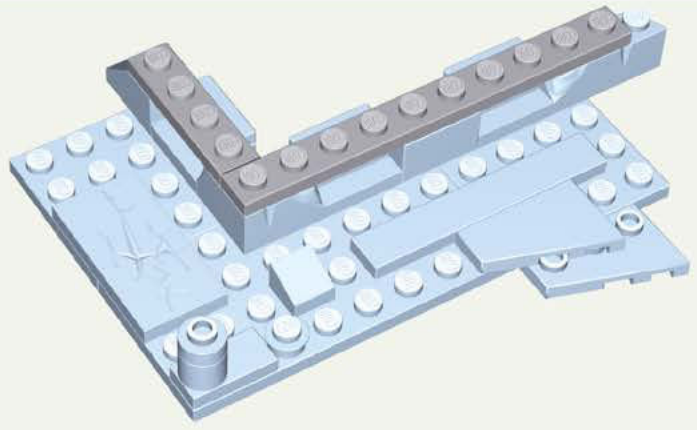

145

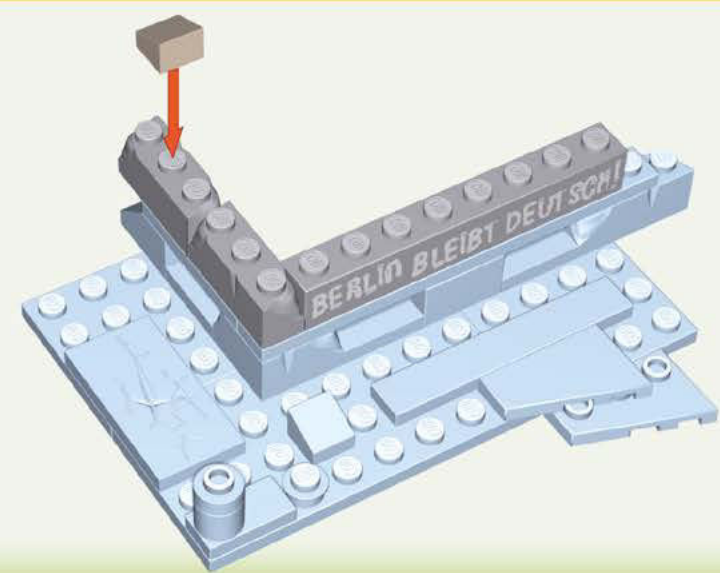

146

1:1

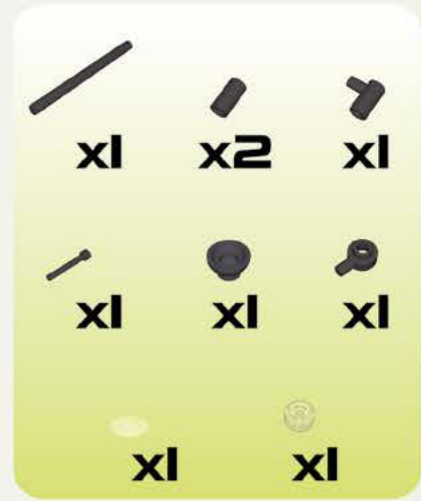
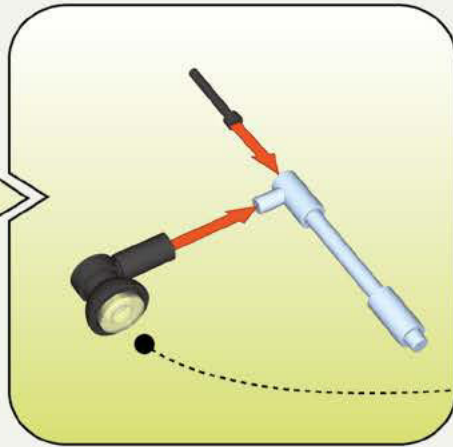

147

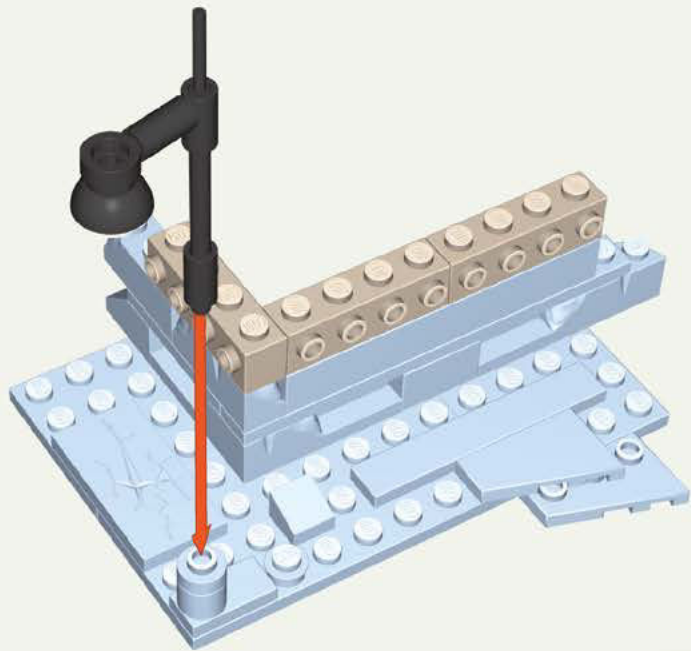

148

1:1

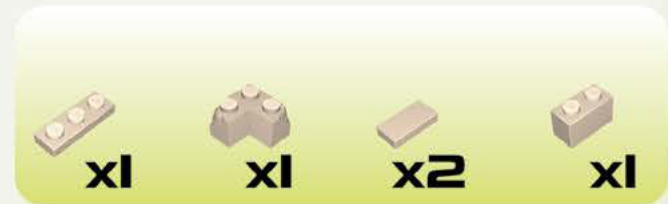
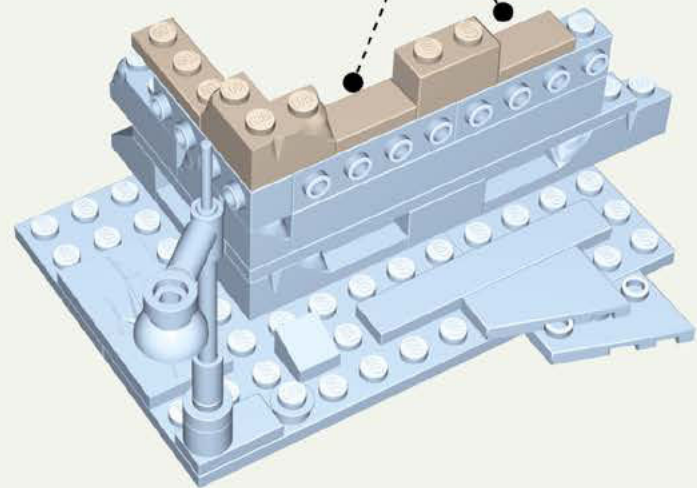

149

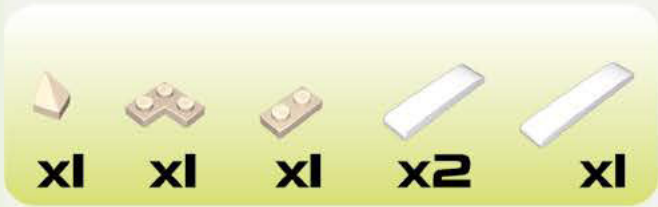
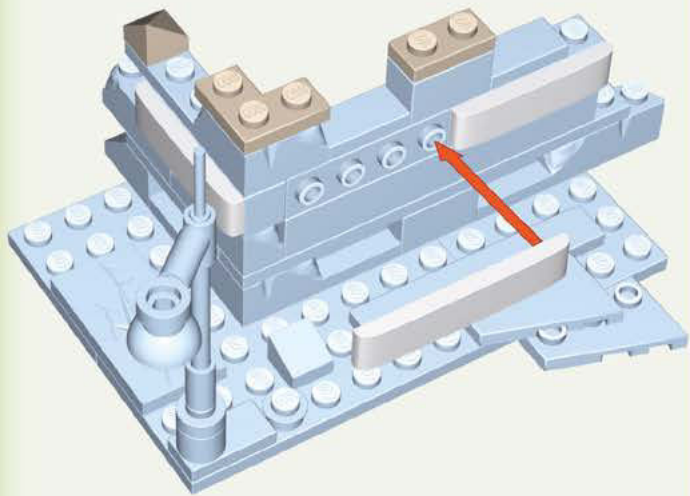

150

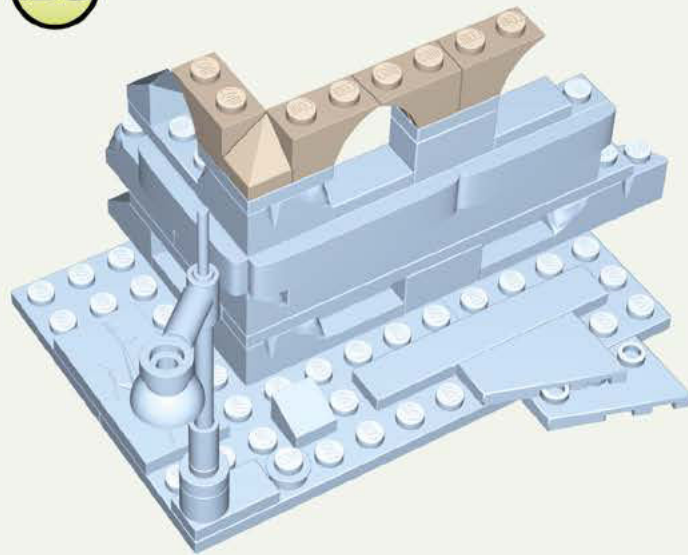

151

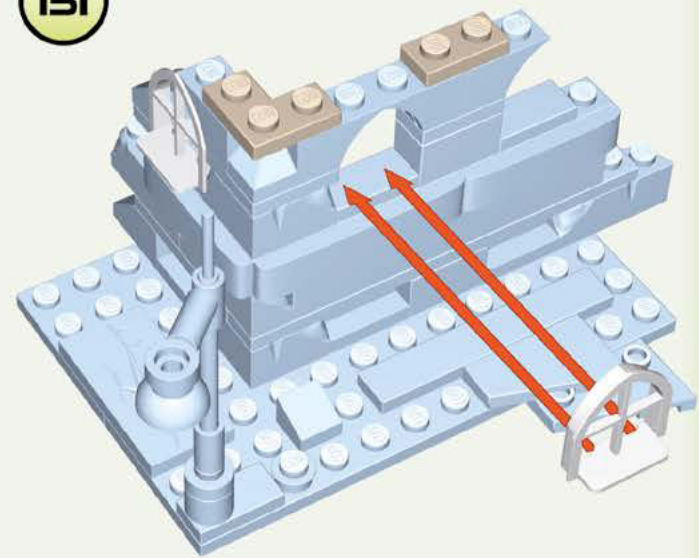

152

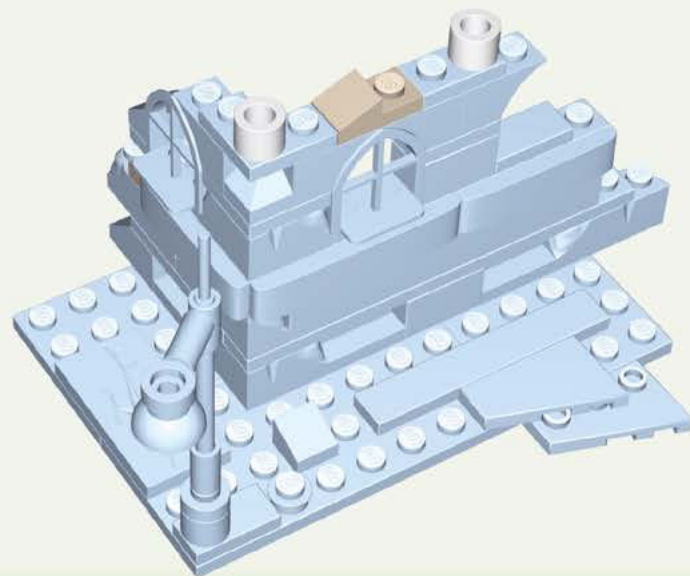

153

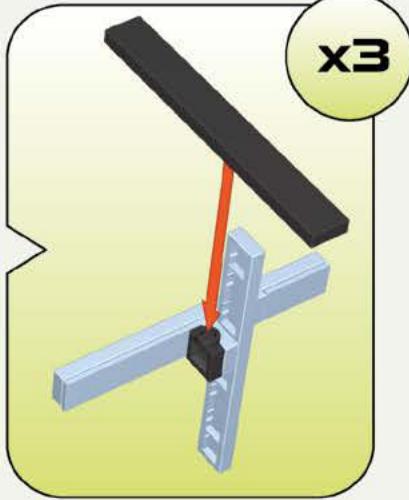
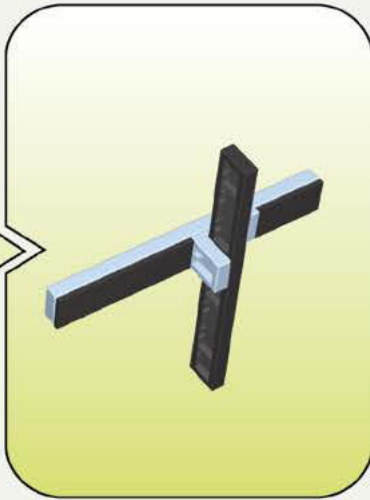

1:1



154

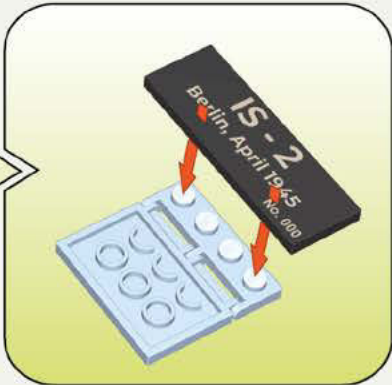

155

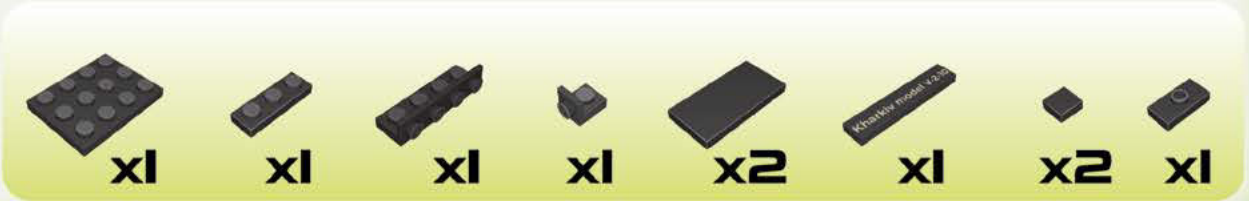
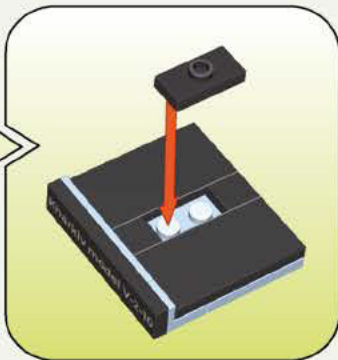

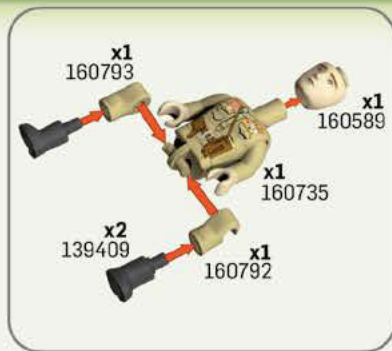
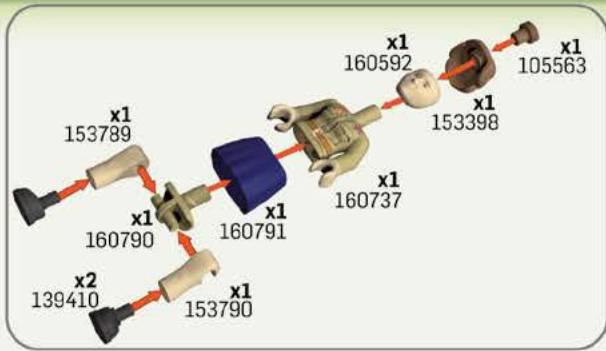

x1 44604	x5 73287	x4 148876	x1 86093	x10 109854	x8 106754	x8 42873	x1 160798	x2 132985	x2 105092	x1 147889	x3 107907	x4 155387	x2 157997
x1 119995	x3 118452	x3 118376	x4 125256	x1 160799	x1 155391	x2 160859	x1 42878	x2 42880	x15 42882	x2 125333	x1 160739	x5 150125	
x1 151431	x3 150425	x2 160800	x1 113421	x3 135621	x2 118380	x2 55859	x1 147701	x2 44879	x2 158324	x4 152826	x1 160801	x2 93052	
x1 153760	x5 153306	x2 115046	x3 148971	x2 157712	x1 153763	x7 125894	x2 44390	x2 113933	x3 92239	x2 157989	x2 108318	x1 84908	
x2 86037	x2 95106	x2 86091	x1 44169	x2 99232	x7 132984	x2 128527	x3 155978	x2 153389	x3 75778	x1 42927	x2 42926	x2 45004	
x32 42931	x4 42913	x2 98135	x1 106765	x3 134976	x5 104956	x1 142143	x1 125205	x3 45482	x1 45187	x1 45159	x2 45525	x11 45540	
x2 51590	x3 104428	x2 117265	x8 100808	x5 103172	x1 95191	x21 94039	x1 160860	x2 125376	x2 150432	x2 92369	x2 87333	x1 42950	
x1 60322	x2 42952	x1 113489	x3 106342	x1 111106	x3 45647	x1 80005	x10 83632	x2 160802	x8 143521	x3 137674	x3 128968	x1 42890	
x2 42895	x2 51589	x1 43834	x4 54713	x4 113534	x2 160803	x4 98155	x1 152390	x1 140745	x2 136052	x1 92341	x1 83310	x3 81905	

													
x1 57164	x2 94702	x1 98137	x5 109024	x7 111481	x2 140606	x2 132618	x1 160804	x1 42954	x1 42957	x1 45231	x10 42959	x2 95647	
													
x4 93457	x2 115502	x2 99234	x1 160861	x1 160863	x2 142942	x6 109733	x3 64201	x13 42976	x1 43676	x2 105502	x1 64246	x3 42985	
													
x1 108038	x3 106762	x1 62598	x7 64202	x1 160864	x16 91991	x1 44061	x3 73986	x2 85406	x1 160865	x6 128234	x3 134106	x2 128844	
													
x4 146865	x3 67985	x1 106099	x2 160866	x1 160867	x1 128121	x4 43084	x1 160807	x1 43092	x2 44686	x2 43095	x23 43100	x1 160806	
													
x1 123441	x5 43114	x2 51567	x8 82039	x2 80920	x3 111485	x1 160883	x1 160884	x1 99157	x1 122046	x1 160783	x1 99158	x1 123424	
													
x1 150046	x1 150047	x1 84729	x1 85410	x1 76002	x15 77515	x4 97401	x1 80006	x1 151230	x1 82207	x1 64205	x1 60808	x1 160885	
													
x2 94673	x2 67979	x2 155359	x10 43154	x3 86989	x6 74224	x3 43137	x1 160886	x2 146867	x4 43168	x1 106743	x2 54210	x2 43172	
													
x1 160887	x1 64668	x1 111470	x1 107612	x1 48199	x1 160889	x1 160888	x4 124981	x1 160890	x7 107858	x1 113535	x7 109913	x2 160810	
													
x2 159988	x1 108326	x1 87252	x1 125574	x8 89462	x1 44623	x2 51634	x1 160906	x1 160907	x1 160909	x1 135570	x1 54442	x2 94707	
													
x2 105505	x1 160910	x5 154599	x6 148814	x2 93960	x3 148810	x17 104414	x4 104295	x1 105563	x3 95128	x3 123425	x1 117789	x2 152366	



Customer Service
 Kundenservice
 Obsługa Klienta
www.cobi.eu/service



HISTORICAL COLLECTION



Sd.Kfz. 173 JAGDPANTHER
+ 2574



FIELD KITCHEN (HF.14)
+ 2290



STURMEGESCHÜTZ IV
+ 2576



Sd.Kfz. 251/9 "STUMMEL"
+ 2283



10,5cm leFH 18
+ 2292

2577

IS-2

TABLE POINT



1.		16 cm	11.		9
2.		10 cm	12.		9
3.		-5 cm	13.		4
4.		-5 cm	14.		5
5.		+5 cm	15.		4
6.		3-6	16.		2-3
7.		5-6	17.		1
8.		16	18.		4
9.		2+	19.		200
10.		22	20.		Available 1943



2577



HISTORICAL COLLECTION



ZiS-3 SOVIET GUN
★ 2293



WWW.COBIGAMES.COM

IS-2



15CM NEBELWERFER 41
+ 2291



BATTLE OF ARRAS (1940)
MATILDA II vs PANZER 38(t)
+ 2284



BM-13 KATYUSHA (ZiS-6)
★ 2280



WWW.COBIBRICKS.COM

01-02577-1144

For news and special deals

Find us on:

