

# HISTORICAL COLLECTION GREAT WAR

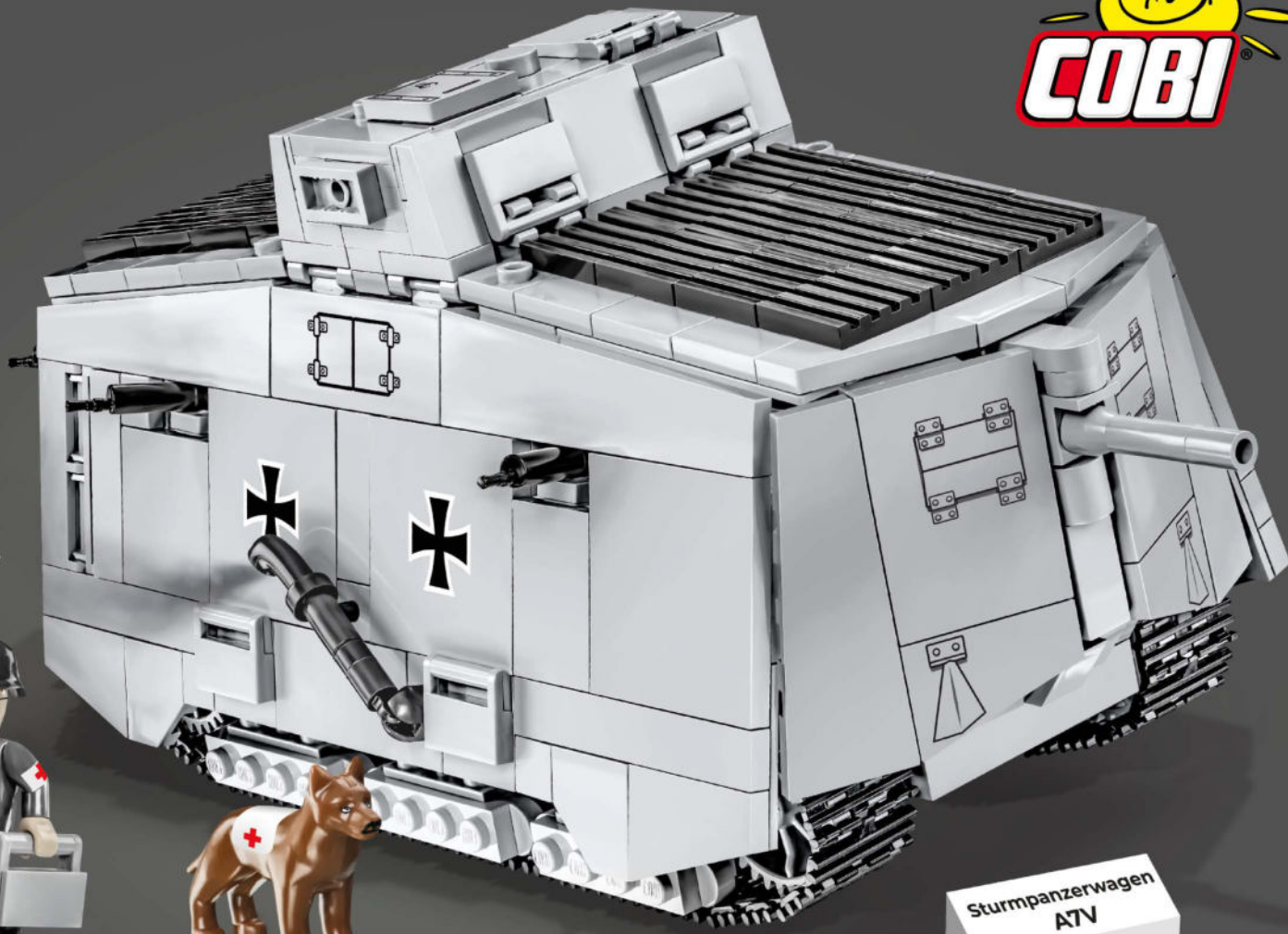

## STURMPANZERWAGEN A7V

IN SERVICE - 1917 - 1918  
 PLACE OF ORIGIN - GERMANY  
 TYPE - TANK  
 WEIGHT - 30t (66138LB)  
 ARMOUR - 15-30mm (.59-1.18")  
 ARMAMENT - 1x MAXIM-NORDENFELT  
 KASEMATT-SCHNELLFEUERKANONE  
 5,7cm (2.24") GUN, 6x 7,92mm (.312")  
 MG 08 GUNS  
 ENGINE - 2x 6 INLINE DAIMLER, 200HP  
 SPEED - 15km/h (9MPH)  
 RANGE - 80km (49,7mi)  
 CREW - 18



Sturmpanzerwagen  
A7V

**PAD PRINTED**  
NO STICKERS

2989

Printed in EU

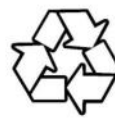

**WARNING: CHOKING HAZARD-**  
Toy contains small parts.  
Not for children under 3 years.

840 1 1

# STURMPANZERWAGEN A7V

SCALE 1:35



1

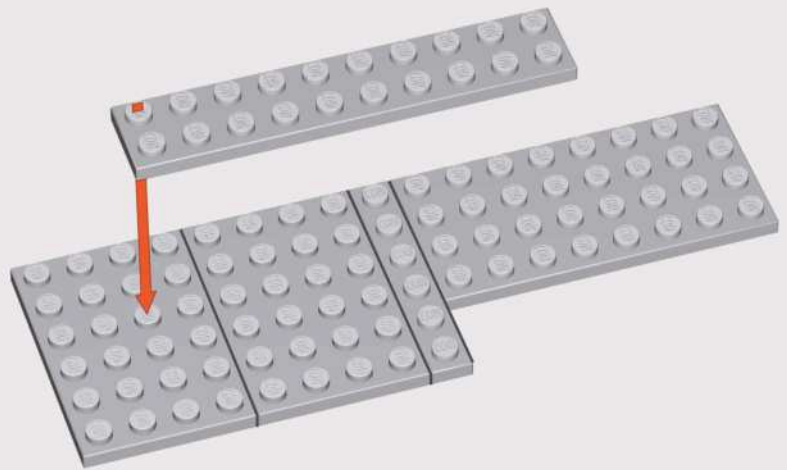

2

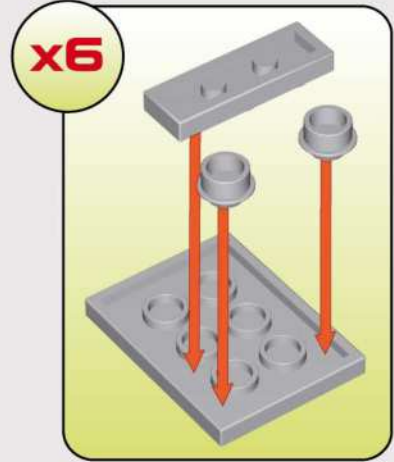

x6

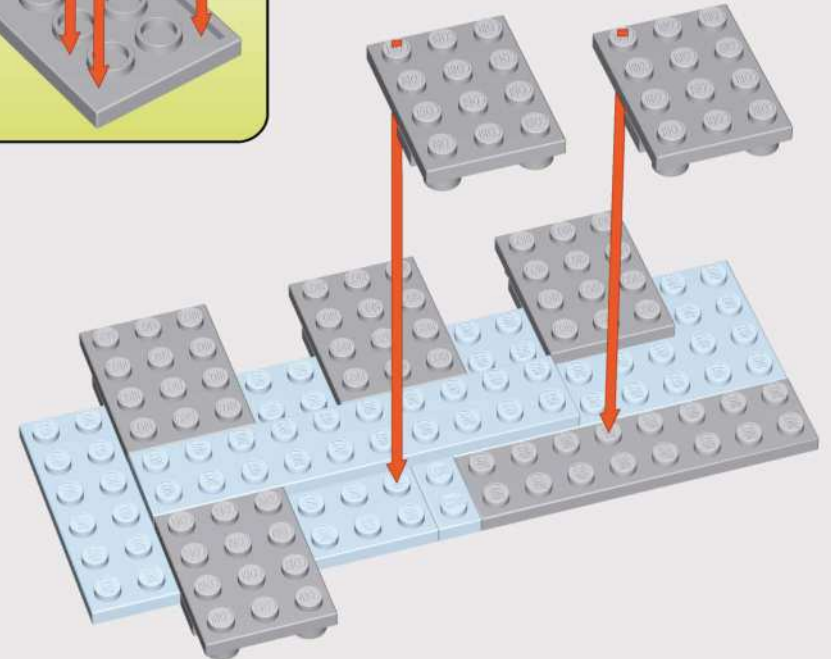

3

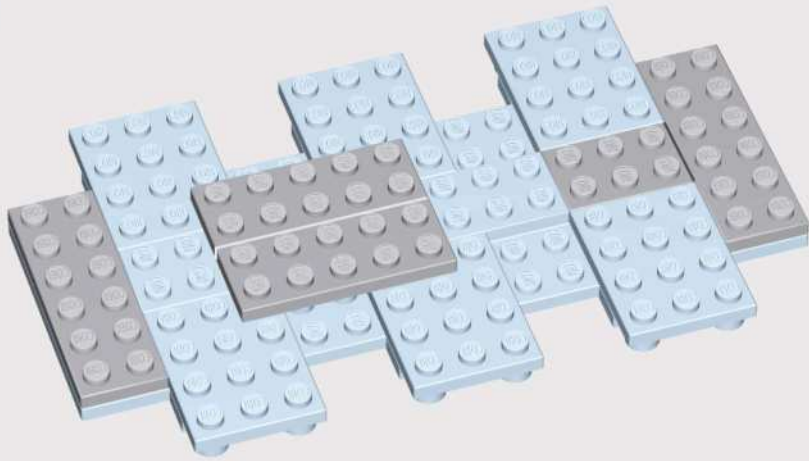

x2



x2



x1

4

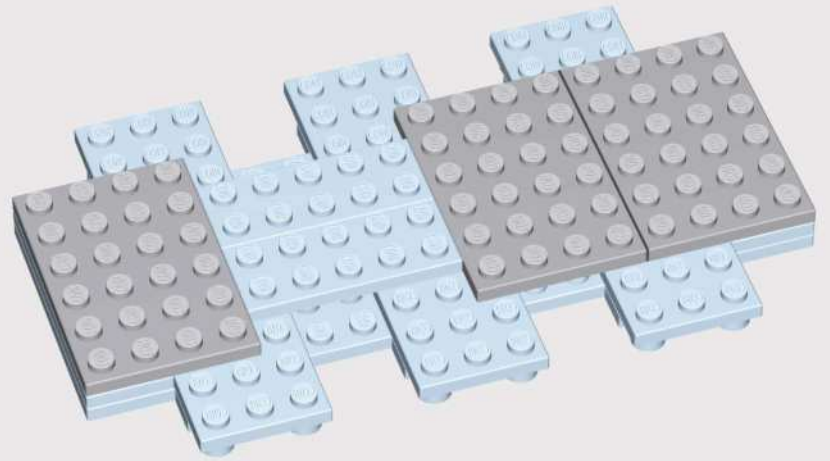

x3

5

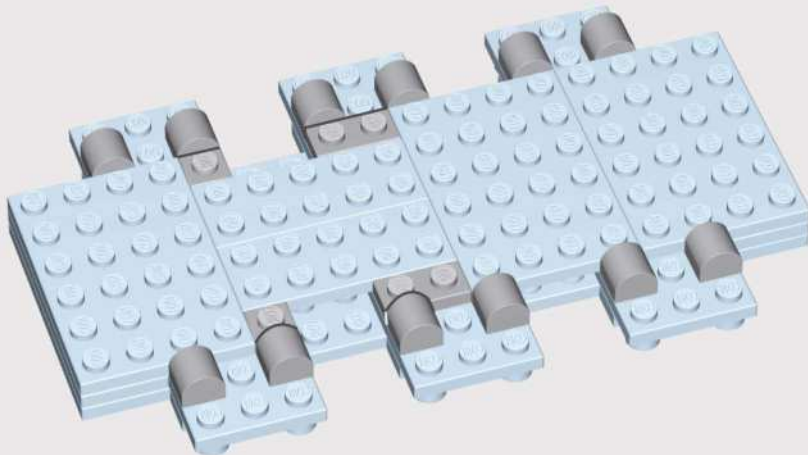

x12



x2



x2

6

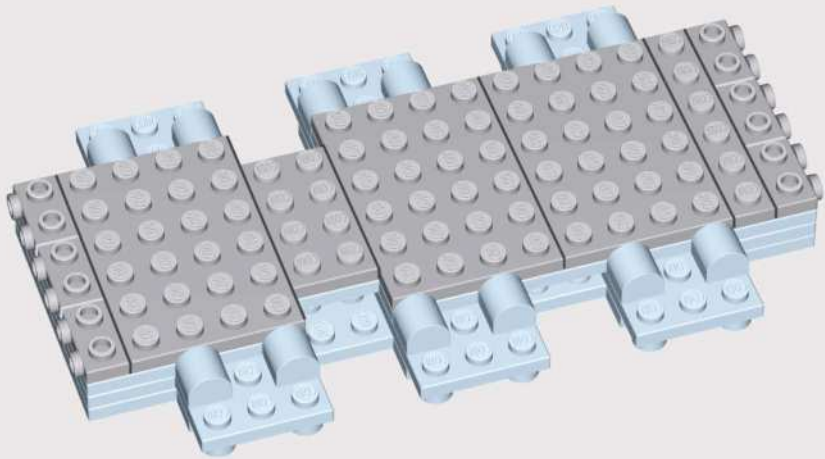

x6



x3



x1



x1

7

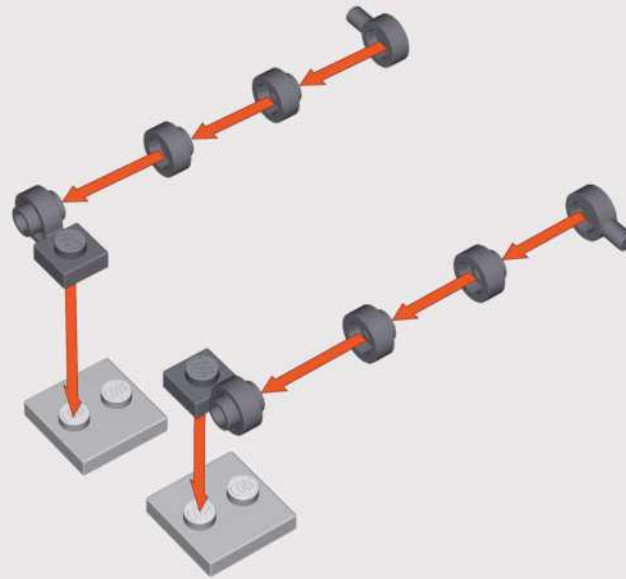

x2



x2



x4



x2

8

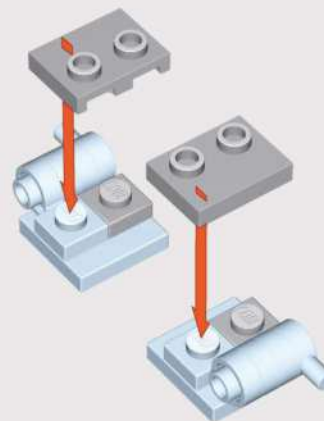

x2



x2

9

1:1

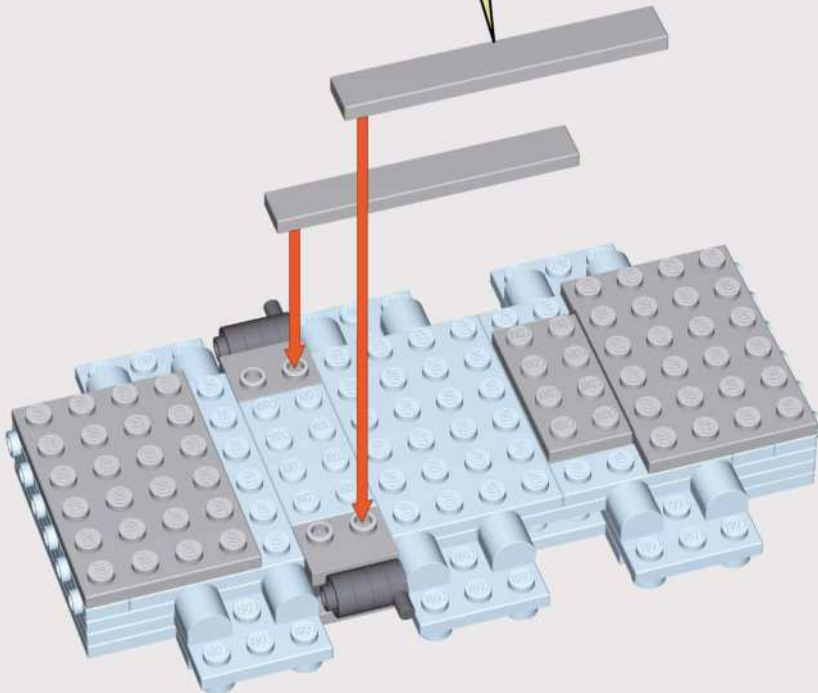

-  x2
-  x1
-  x2

10

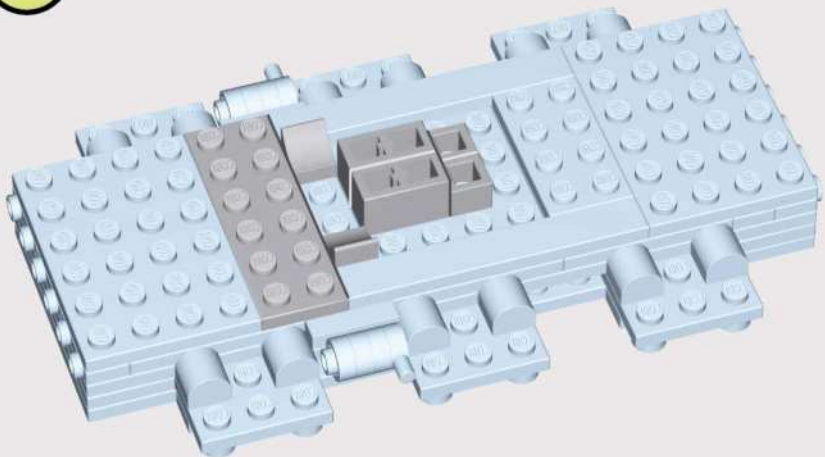

-  x1
-  x2
-  x2
-  x2

11

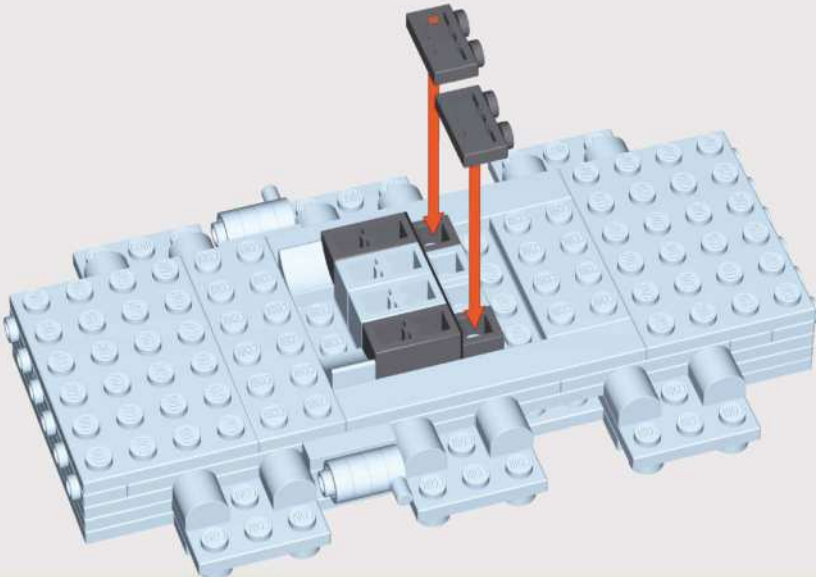

-  x2
-  x2
-  x2

12

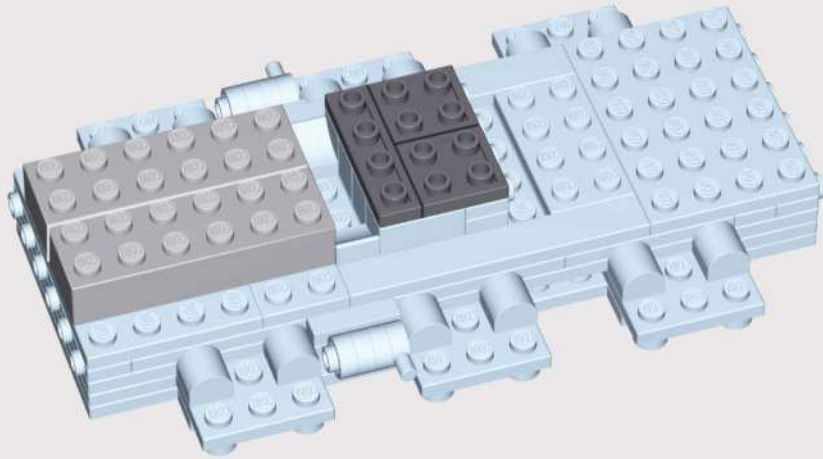

x2



x1



x2

13

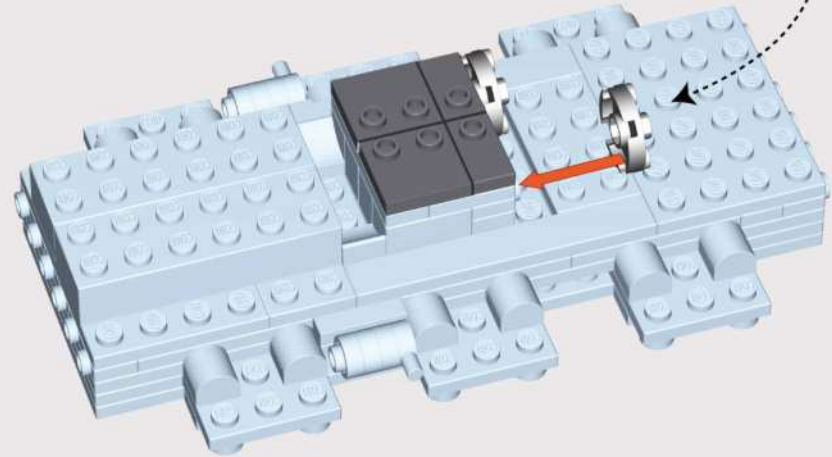

x2



x2



x2

14

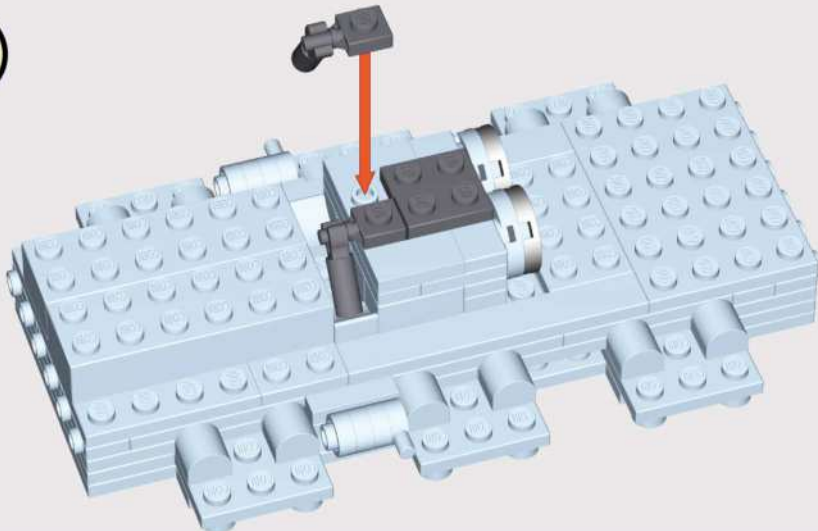

x2



x2



x2



x1



x2

15

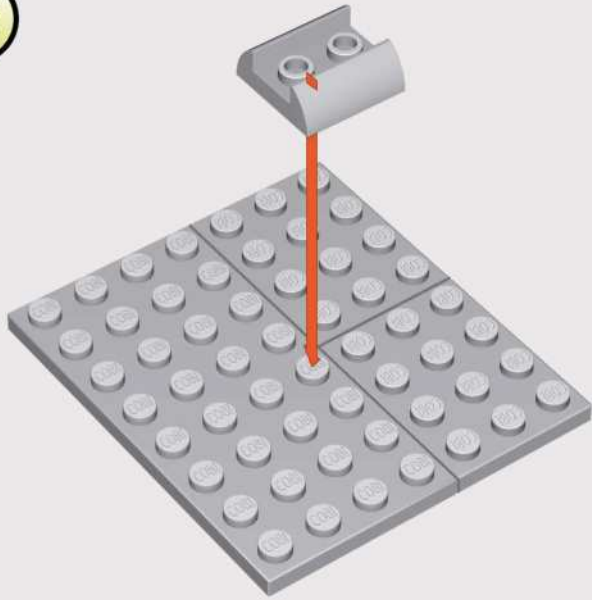

x1



x2



x1

16

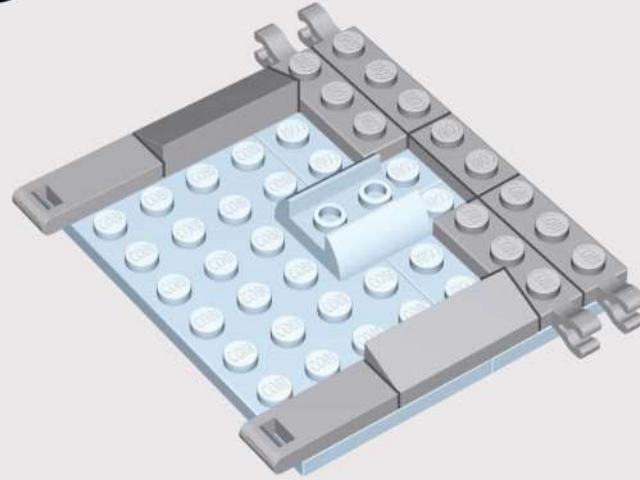

x2



x2



x4



x1

17

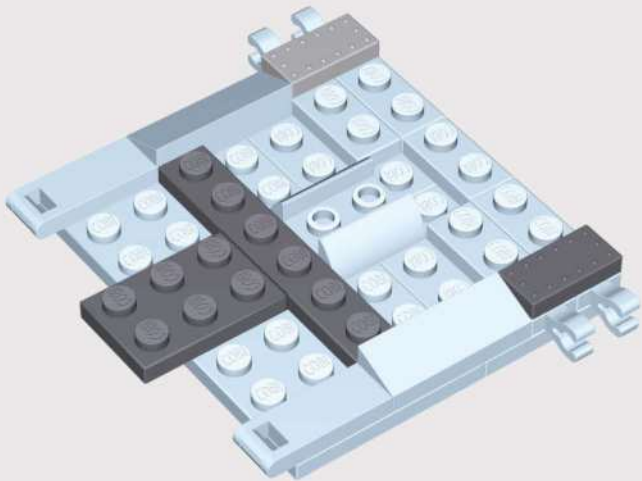

x1



x1



x1



x1

18

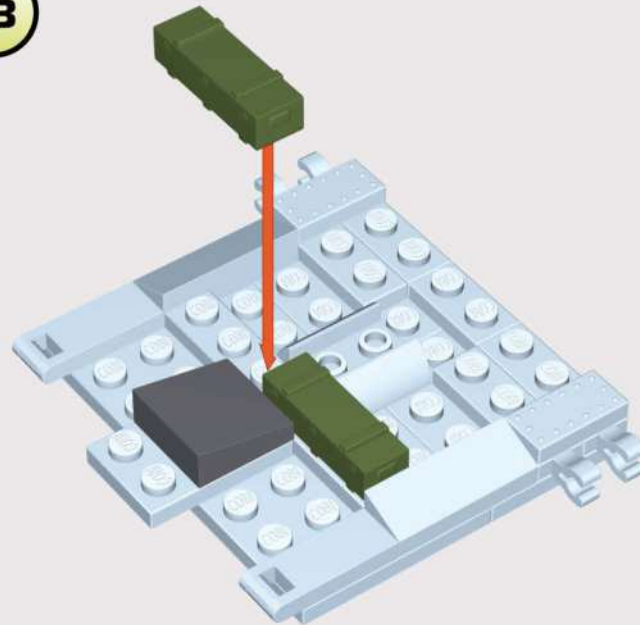

x1



x2

19

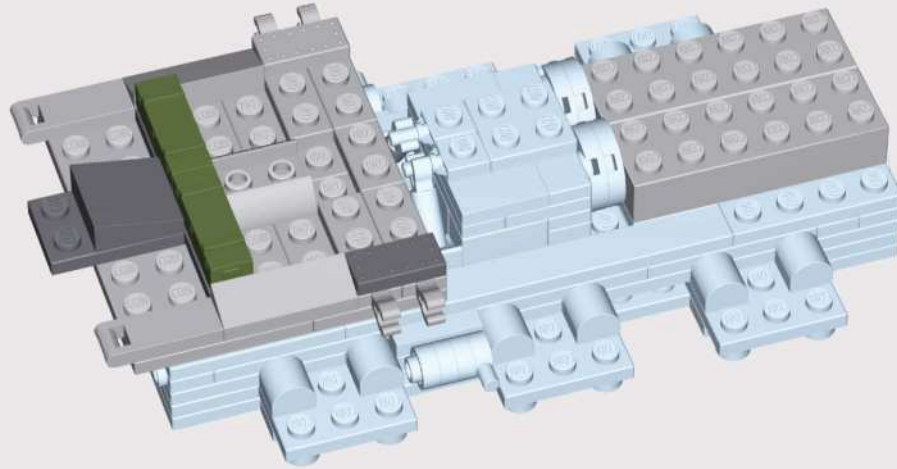
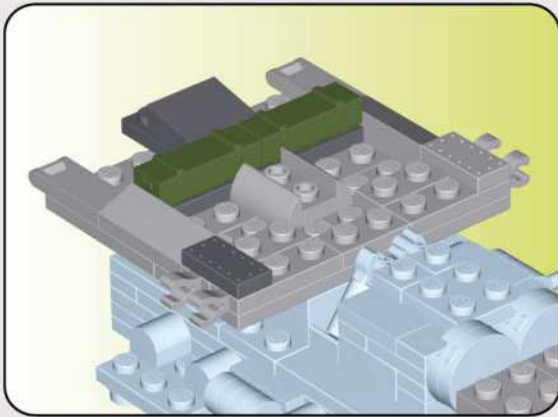

20

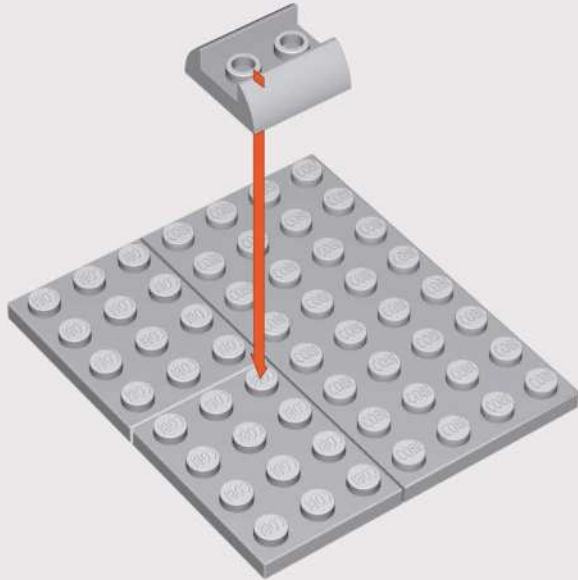

21

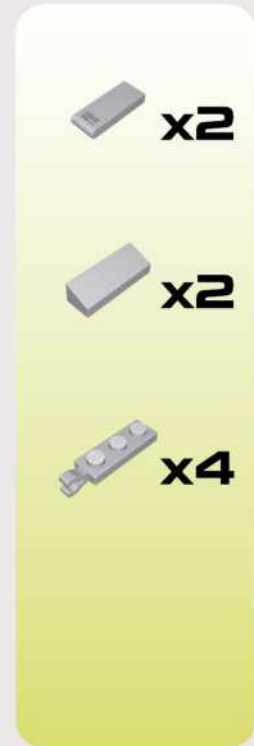
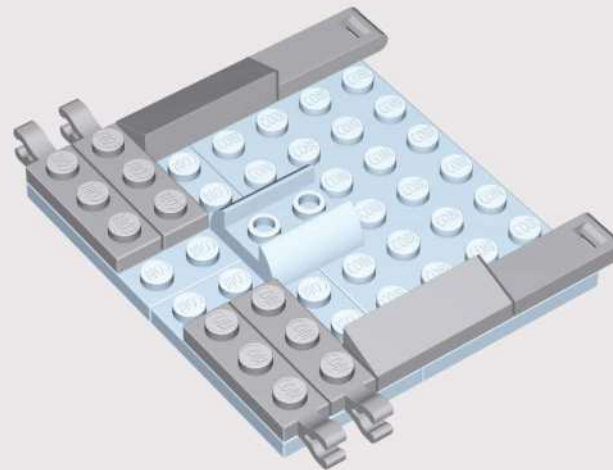



22

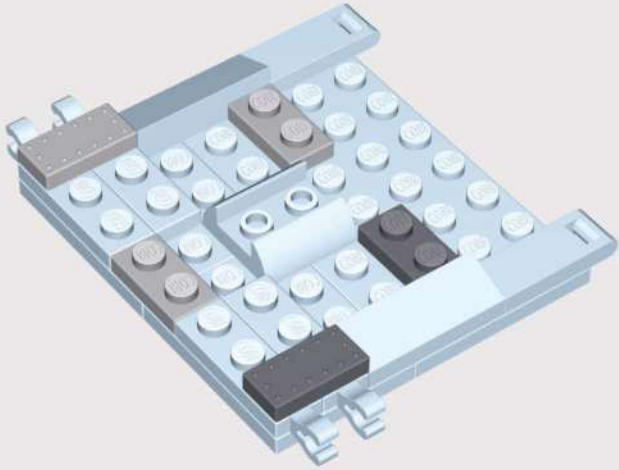

 x1

 x1

 x2

 x1

23

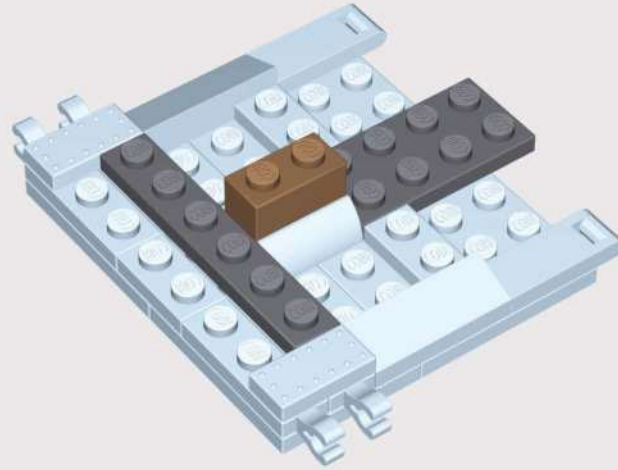

 x1

 x1

 x1

24

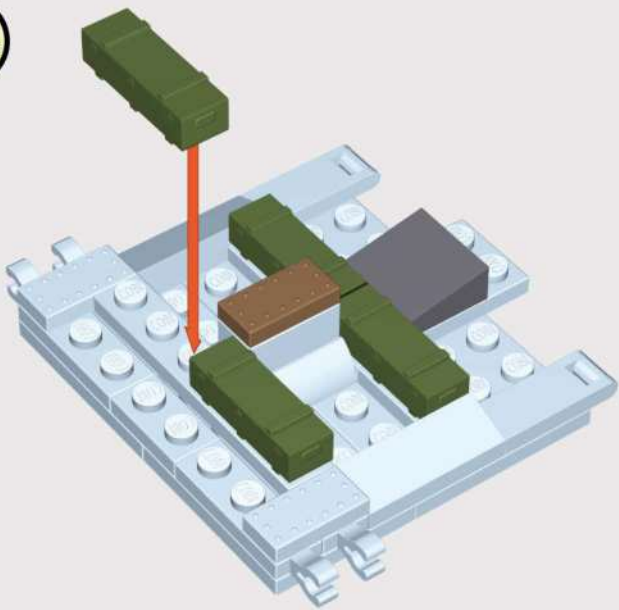

 x4

 x1

 x1

25



 x1

26

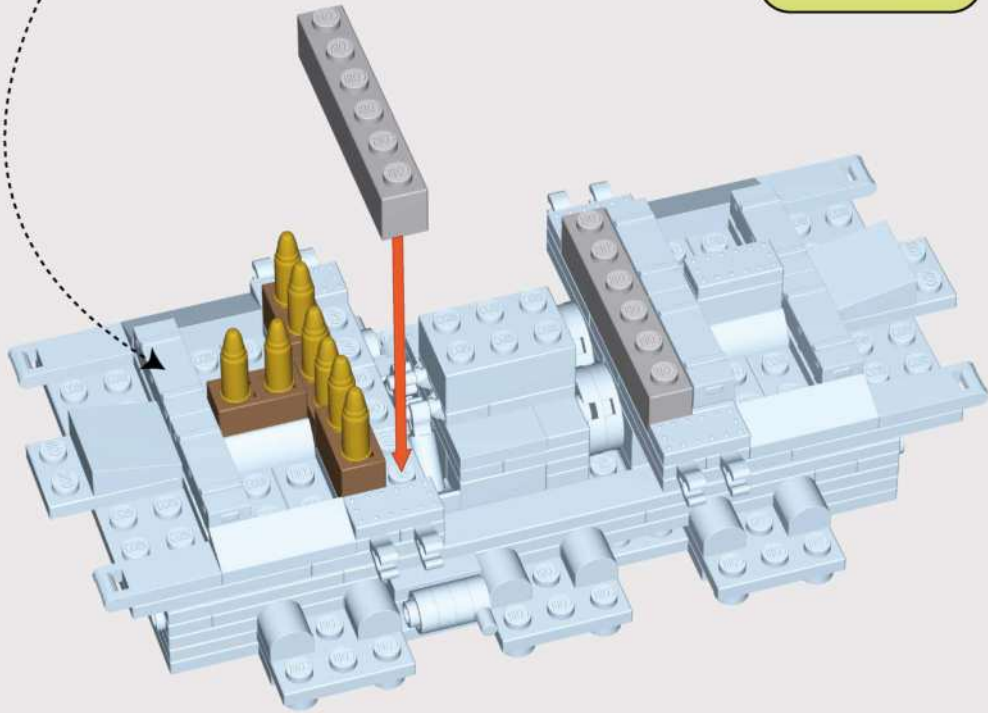
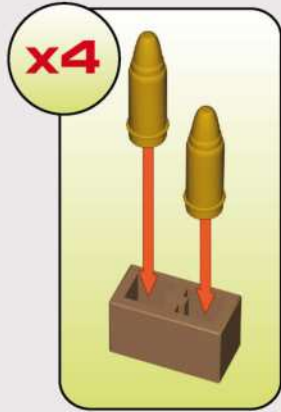
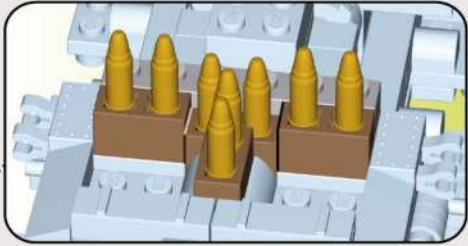

27

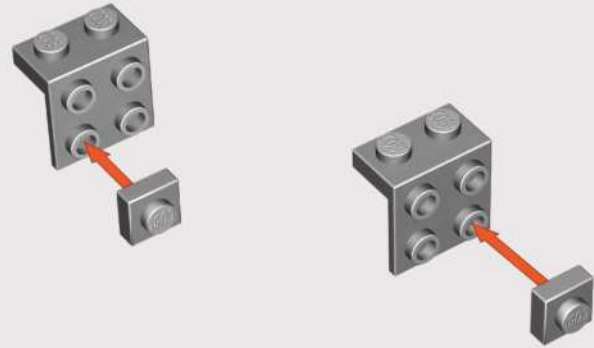

28

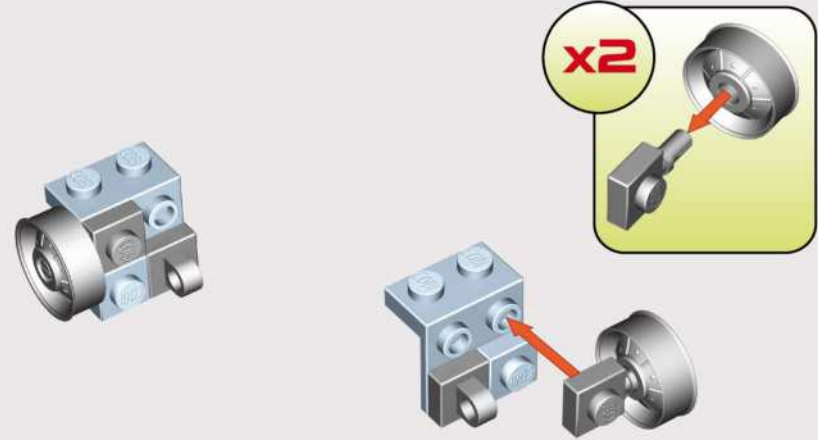

29

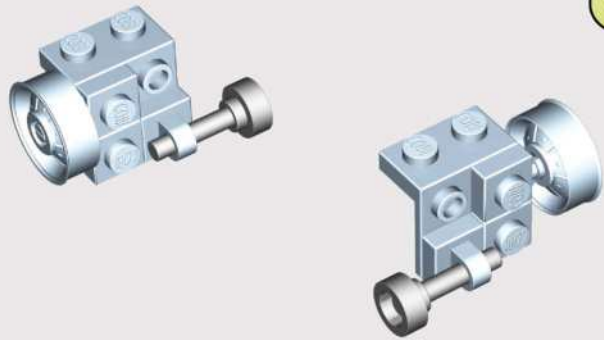

1:1



x2



x2

30

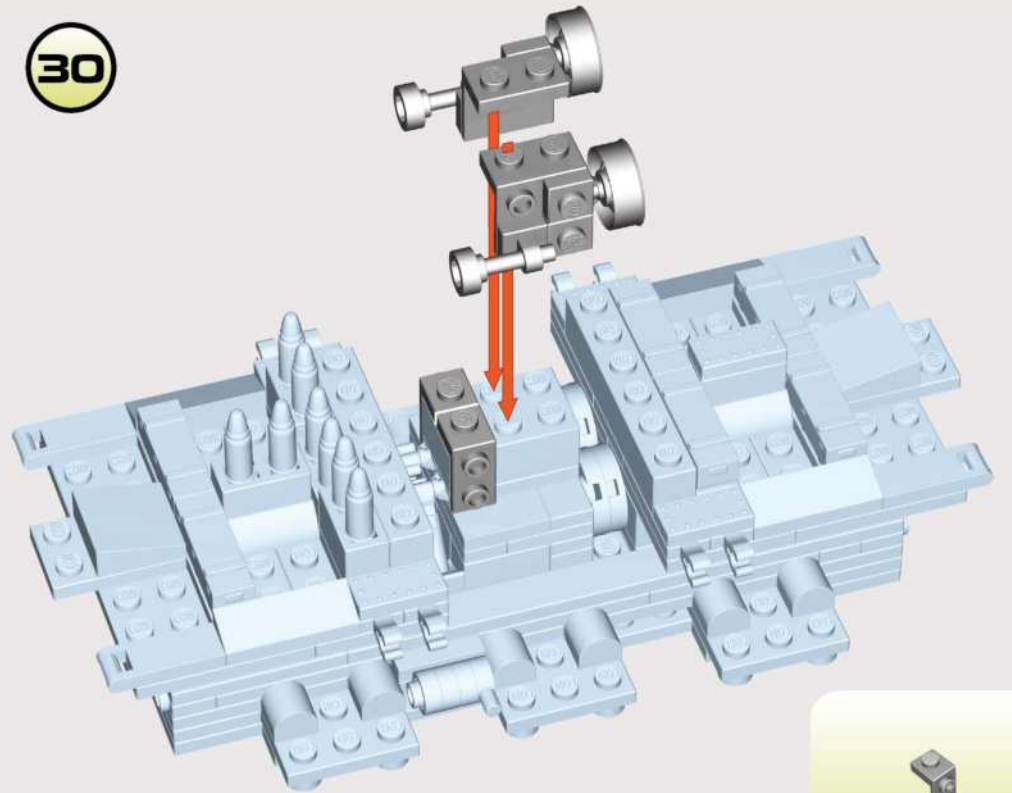

x2

31

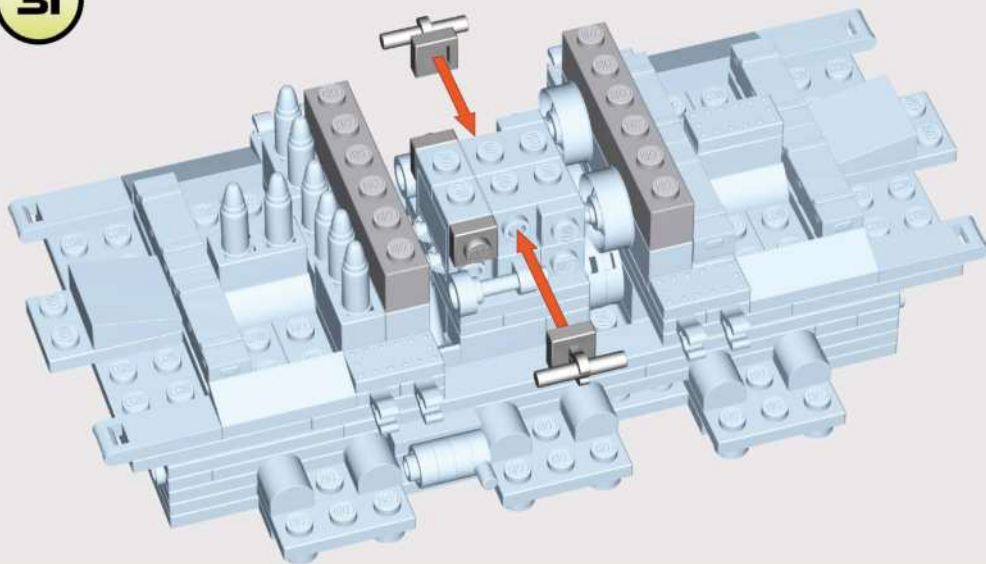

1:1



x2



x2



x2



x2

32

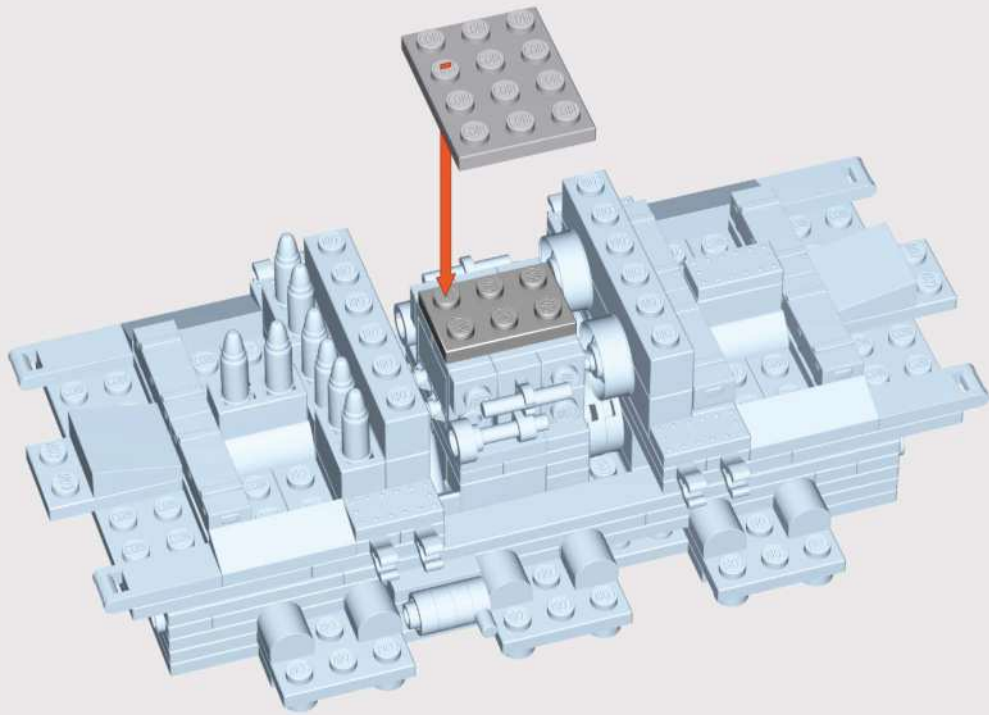

x1



x1

33

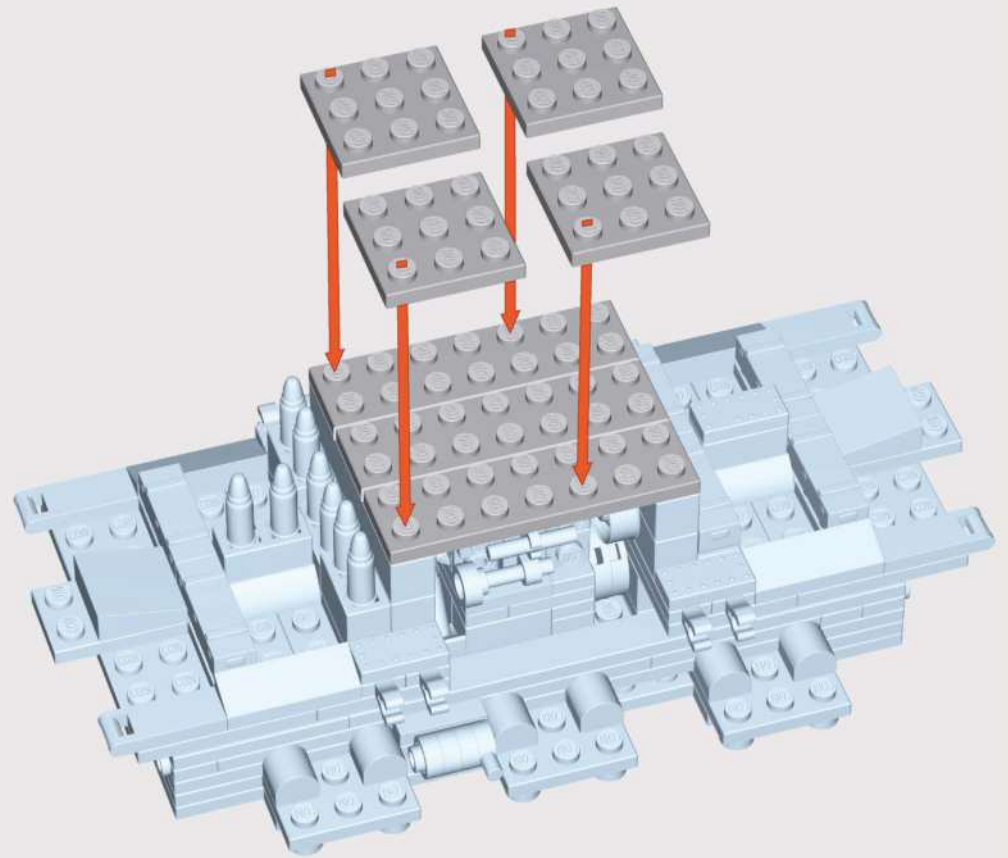

x3



x4

34

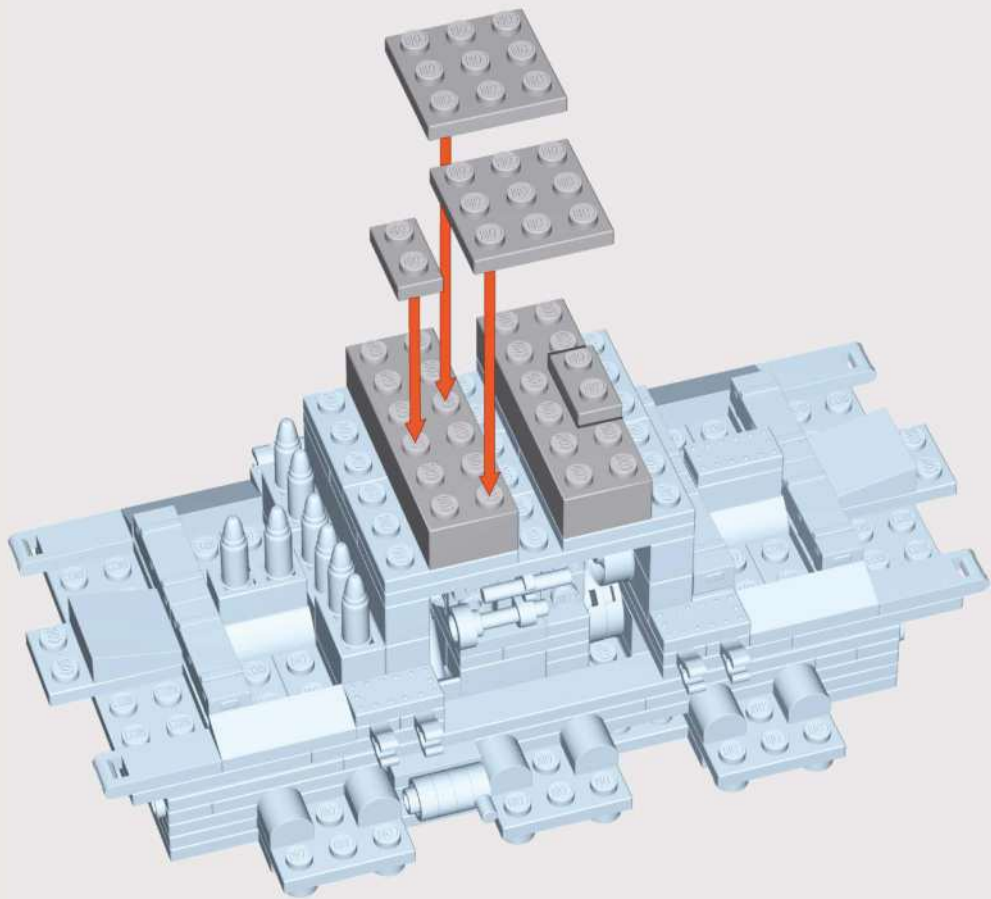

35 x3

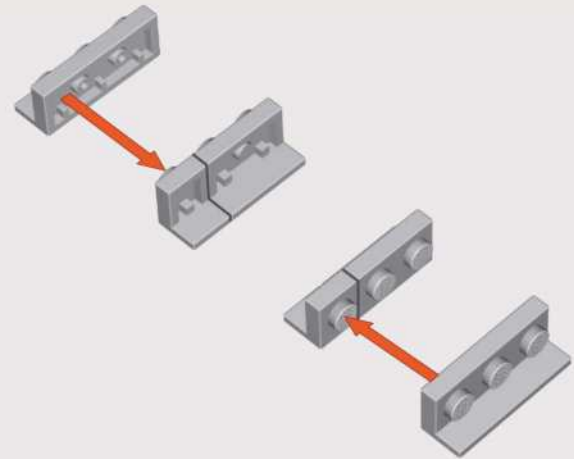

36 x3

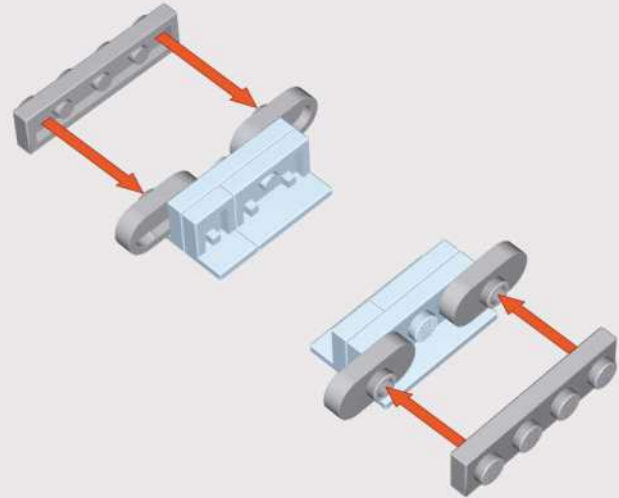

37

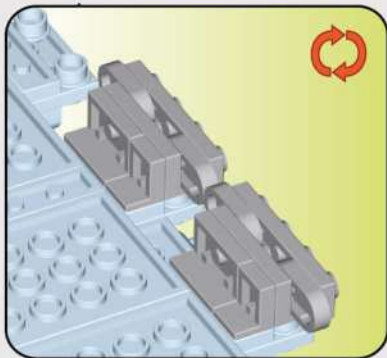
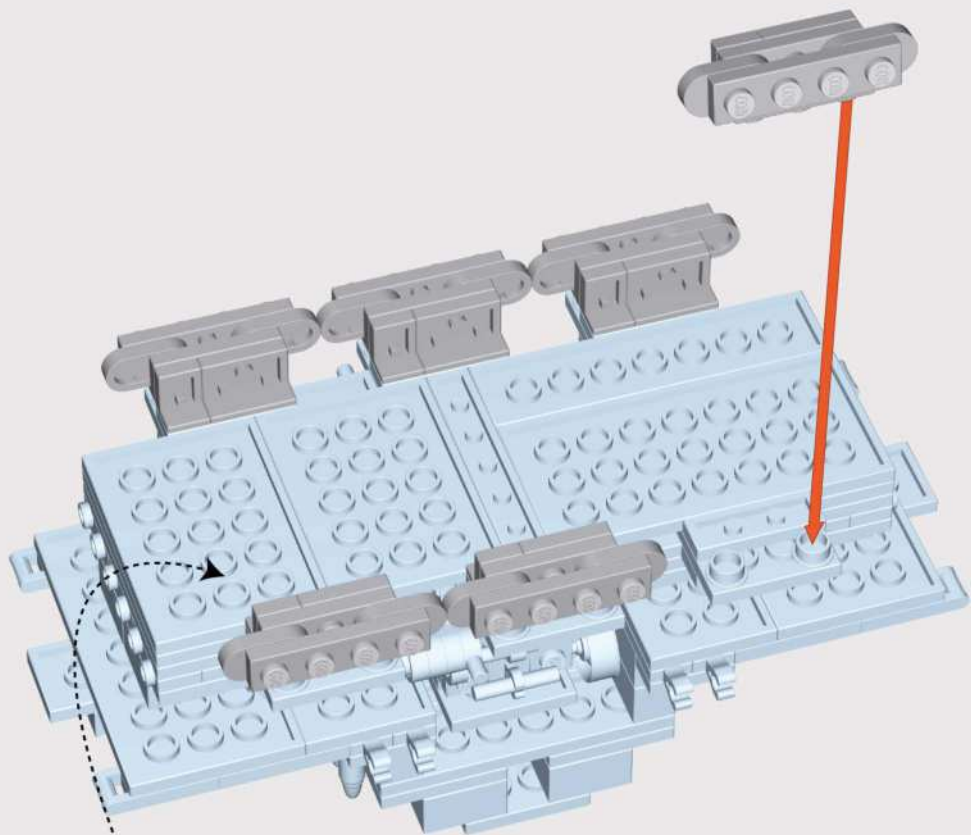

38

38 — 41 x2

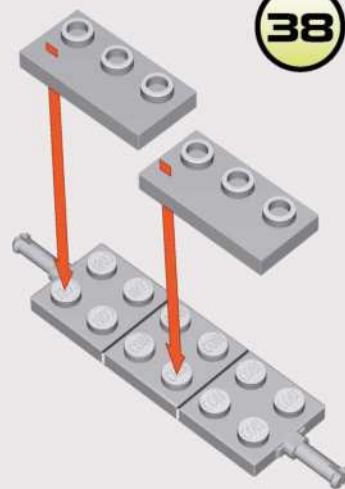

39

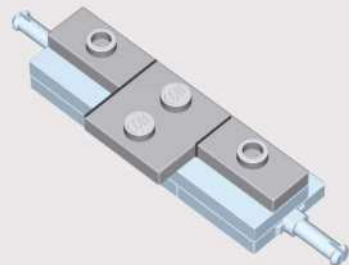

40

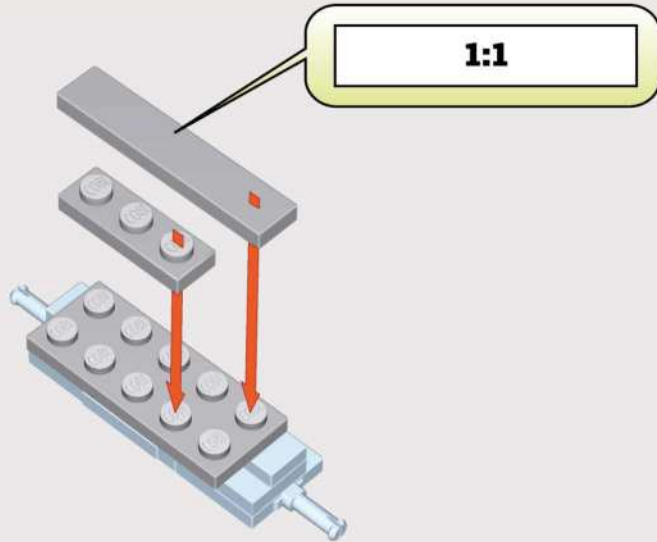

1:1



x1



x1



x1

41

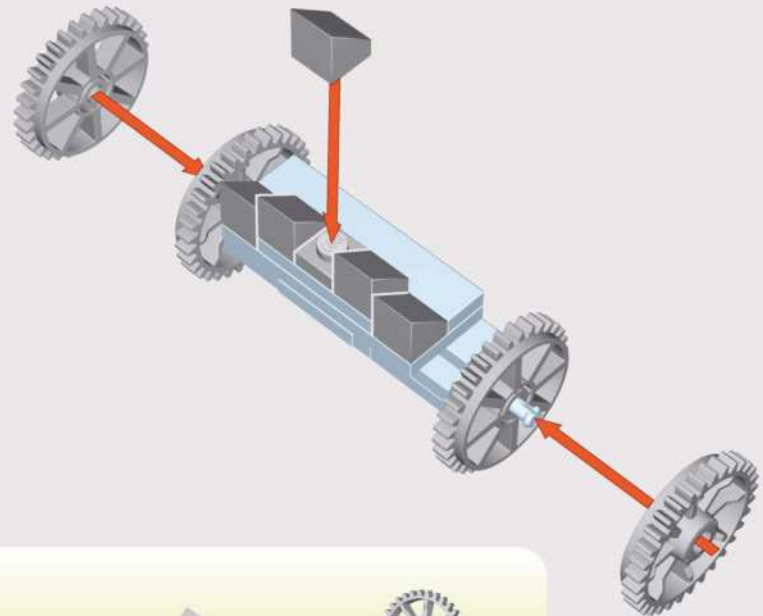

x1



x5



x4

42

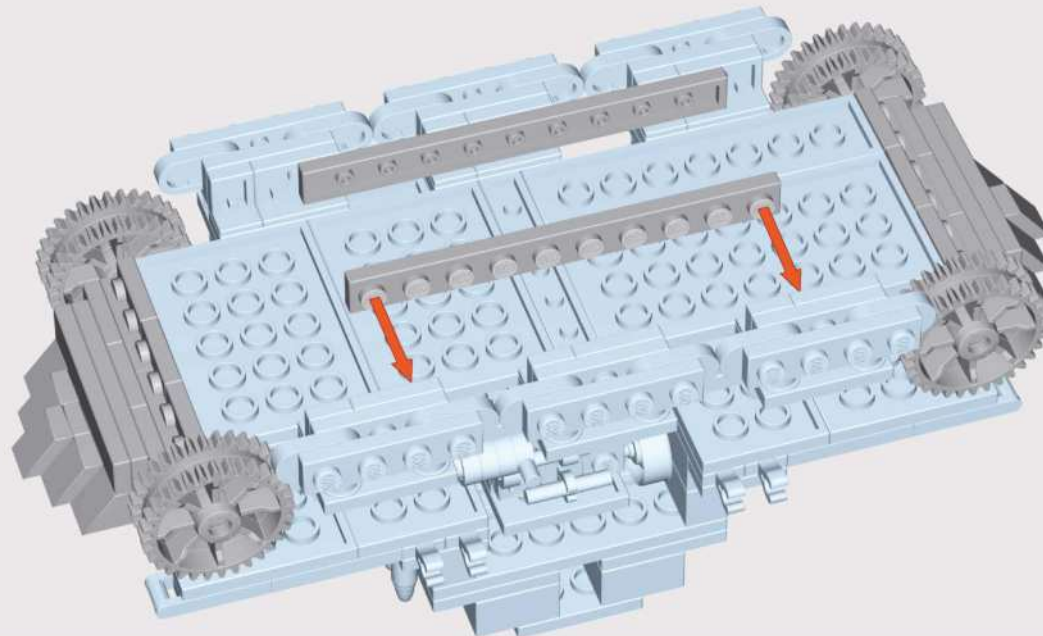

x2

43

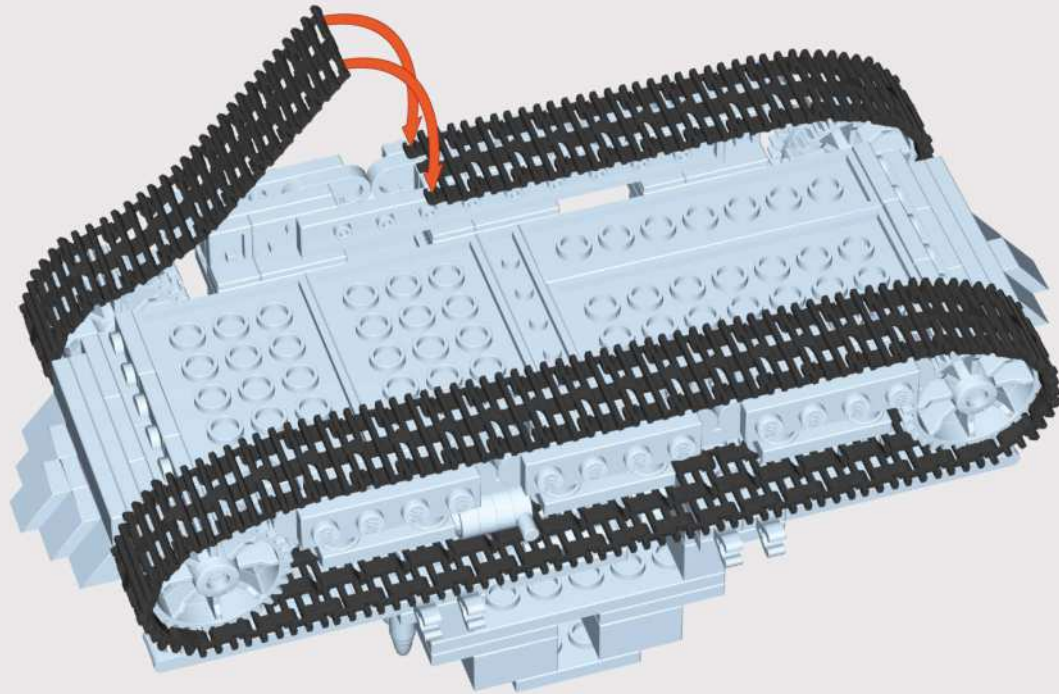
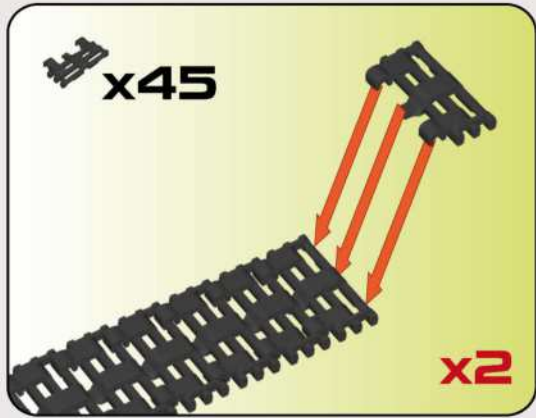

x90



44

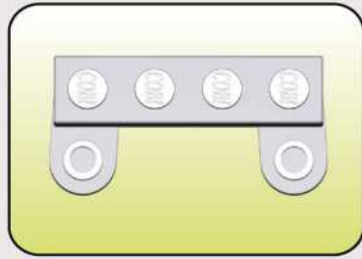
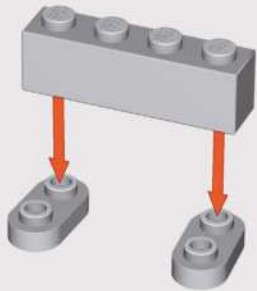

x2



x1

45

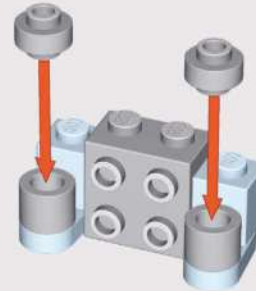

x2



x2



x1

46

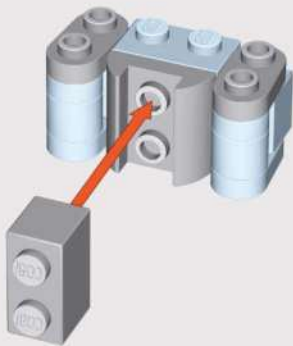

x2



x1



x1

47

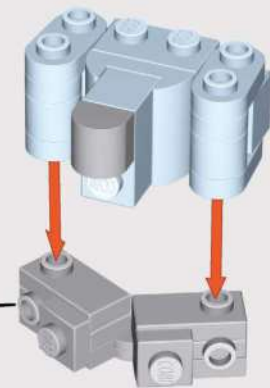
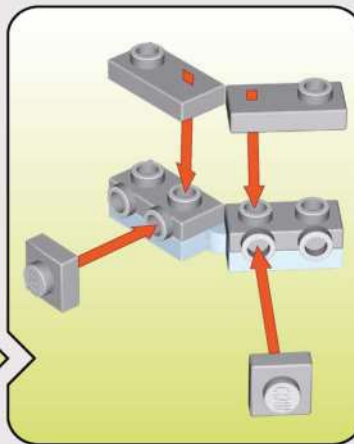
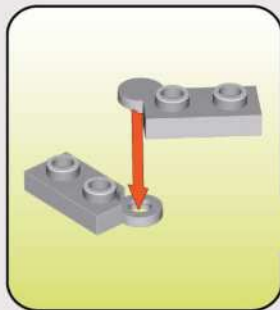

x1



x1



x2



x2



x2







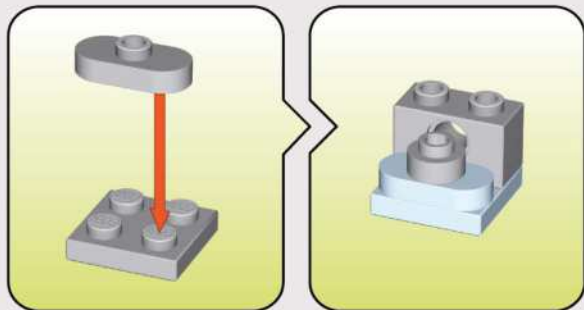

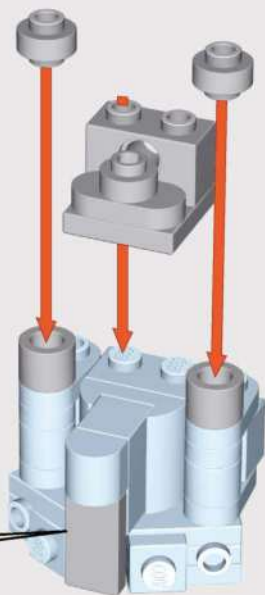

x1

48











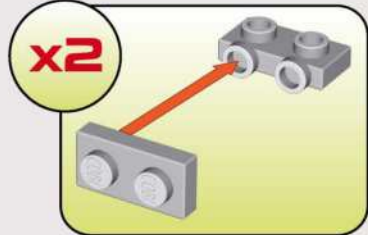
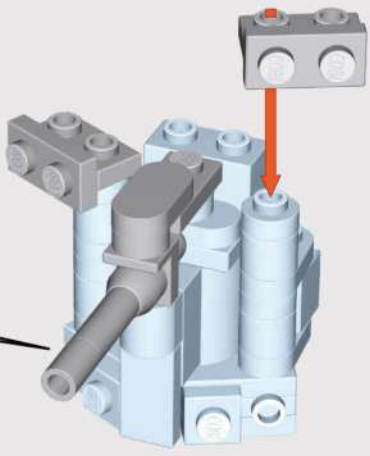
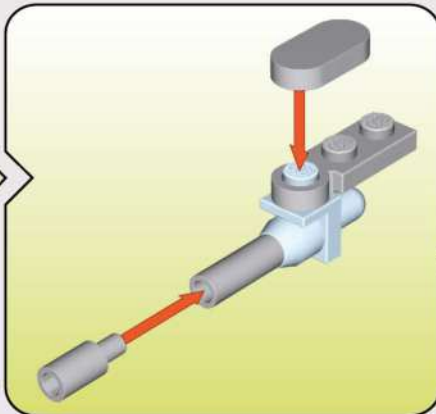
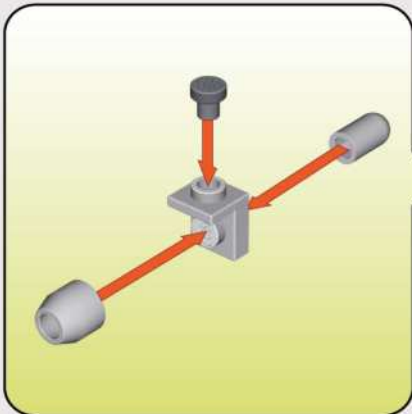

1:1



-   
**x1**
-   
**x1**
-   
**x1**
-   
**x1**
-   
**x1**
-   
**x2**
-   
**x2**

49



-   
**x1**
-   
**x1**
-   
**x1**
-   
**x1**
-   
**x1**
-   
**x1**
-   
**x1**
-   
**x1**
-   
**x2**
-   
**x2**

50

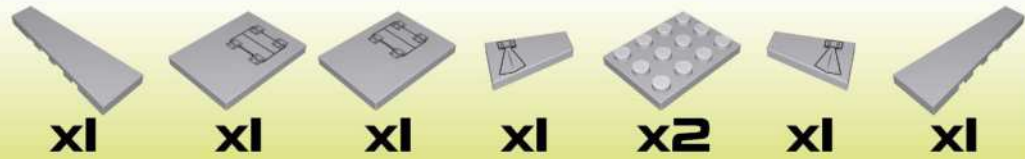
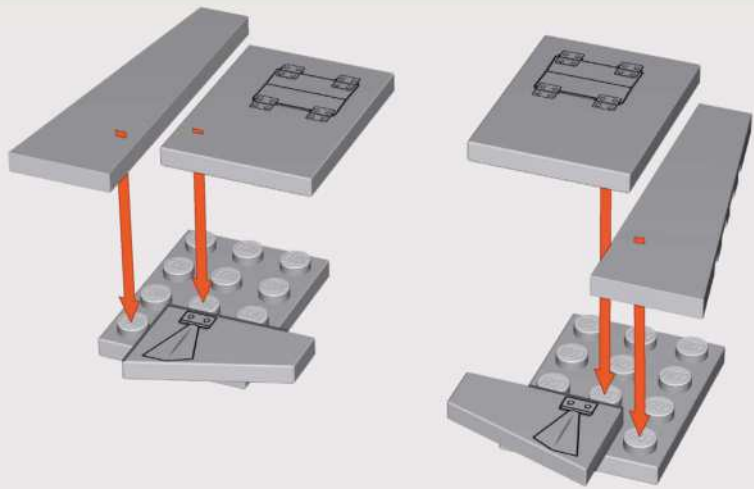

52

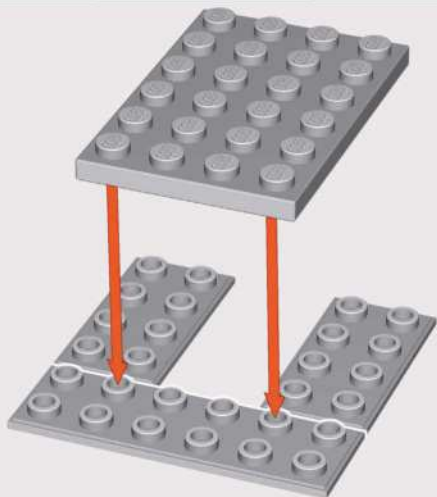

51

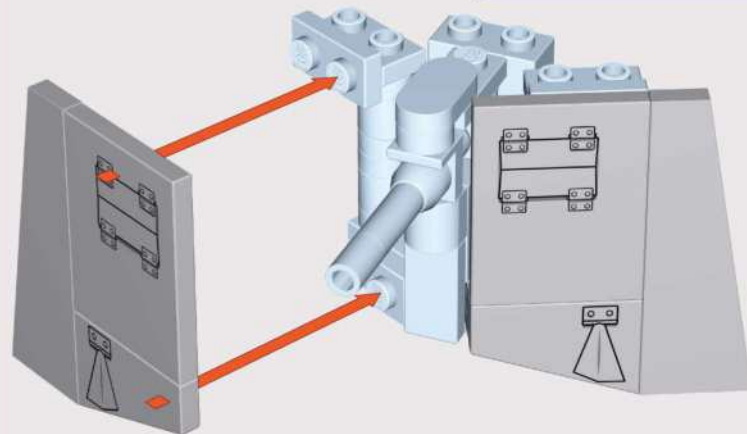
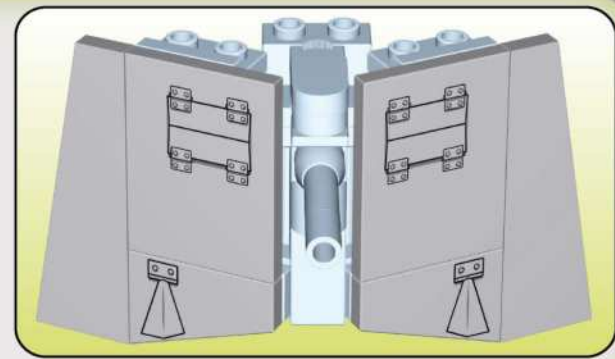

53

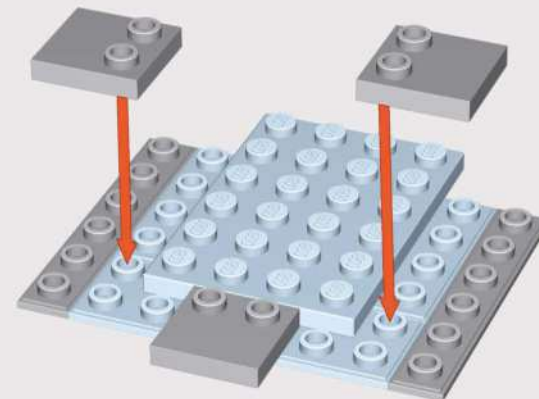

54

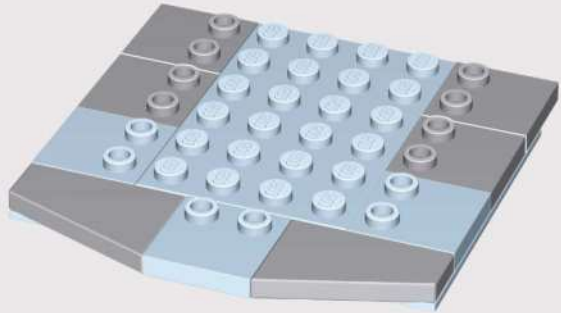

x1



x1



x4

55

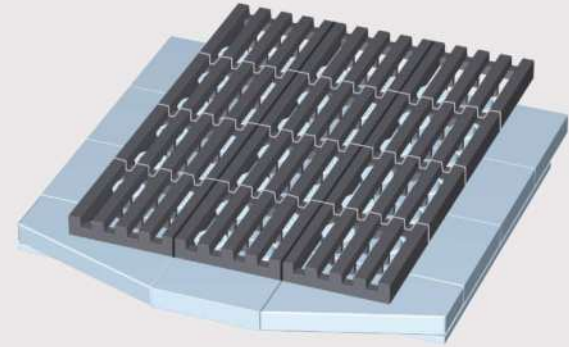

x12

56



x2

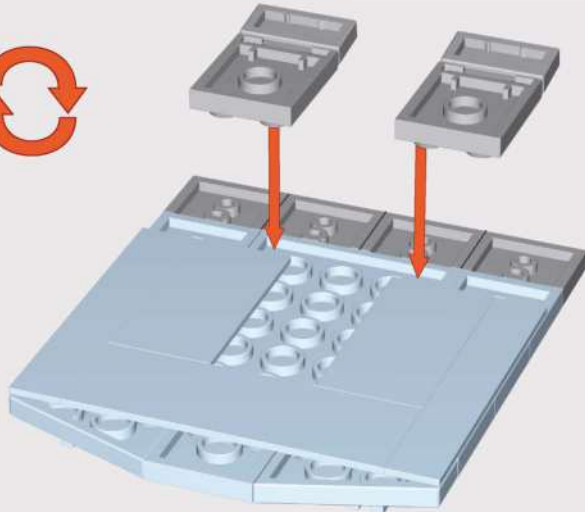

x4



x2



x2

57

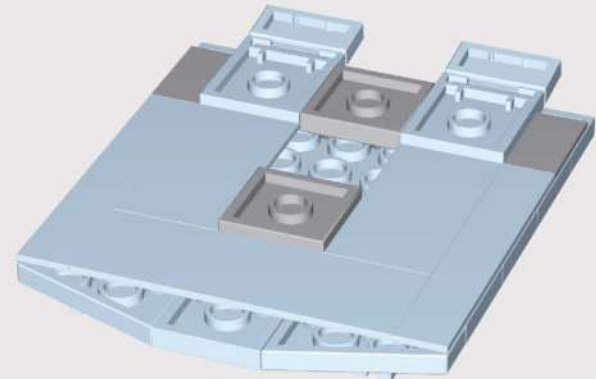

x2



x2

58

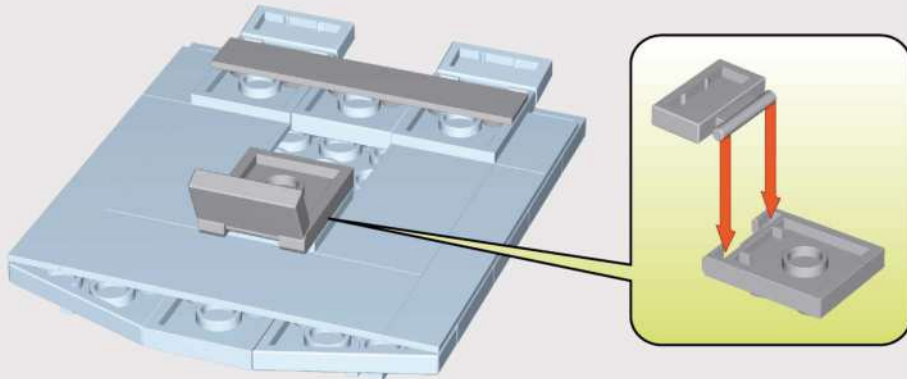

59

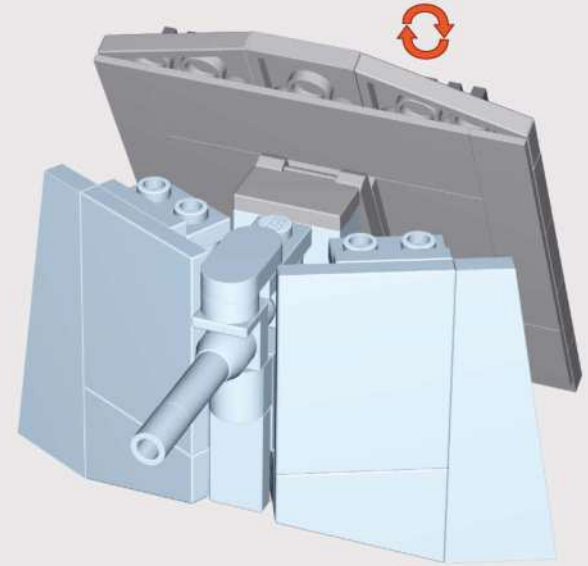

60

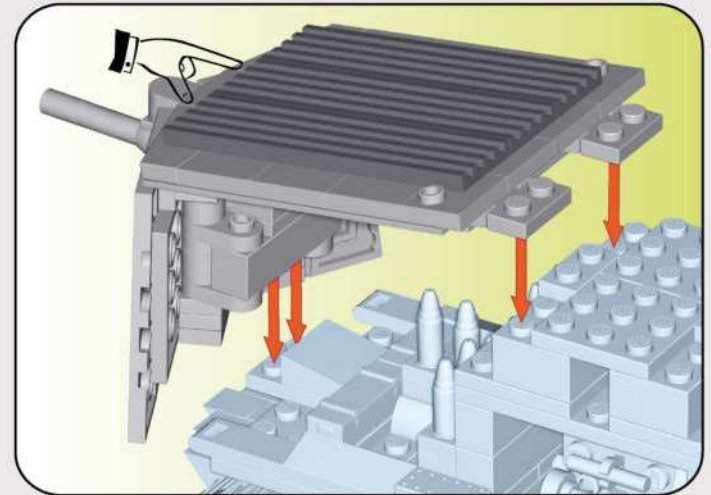
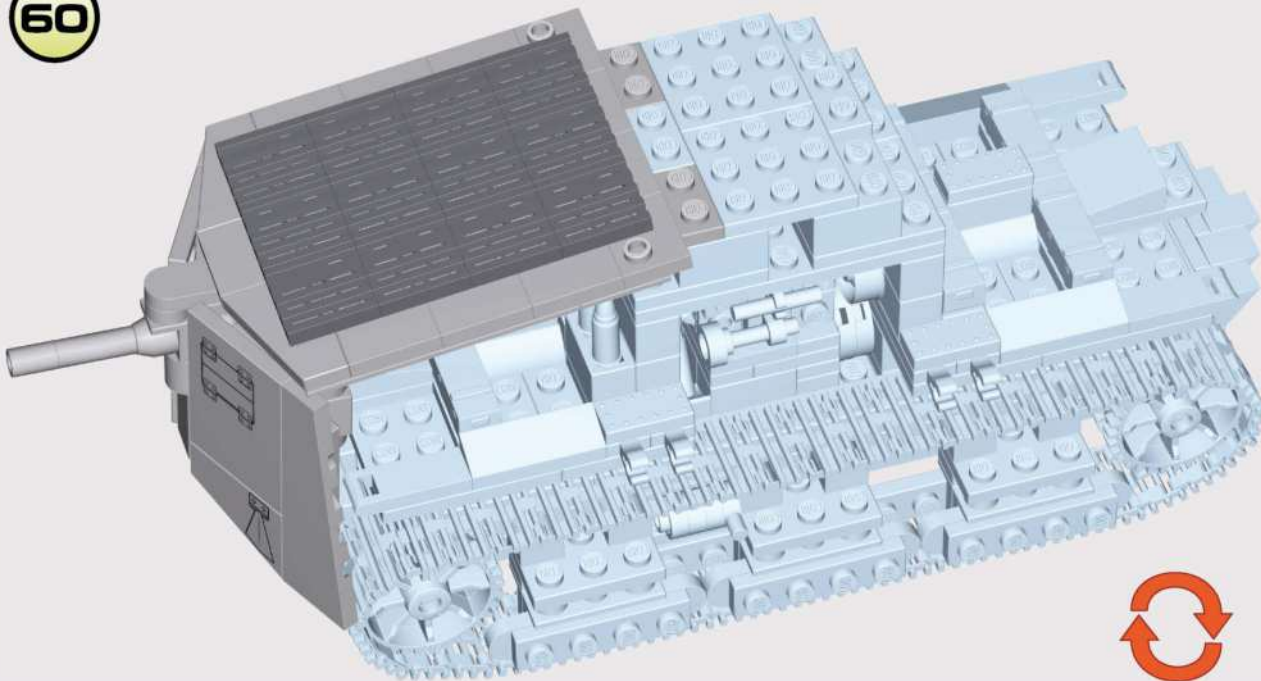

61

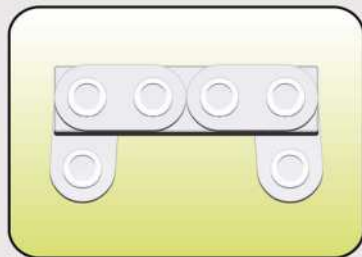
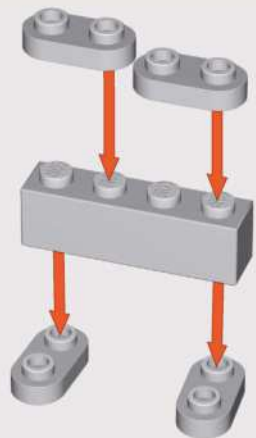

x4



x1

62

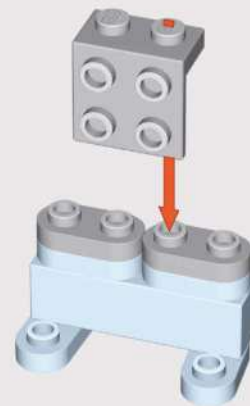

x2



x1

63



x2



x1



x1

64

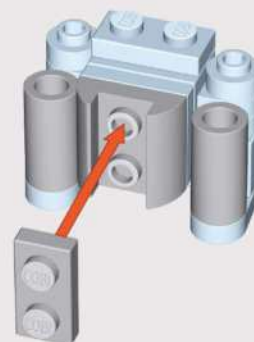

x2



x1



x1

65



x2



x2

66

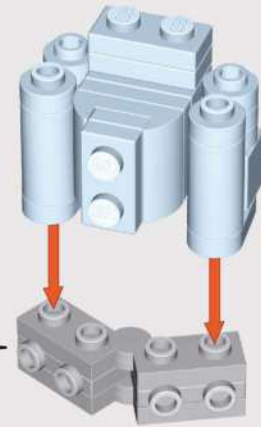
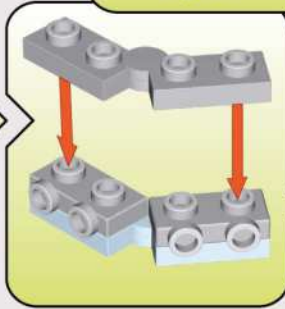
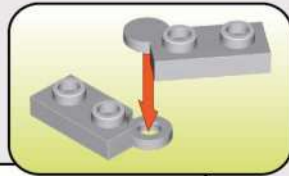
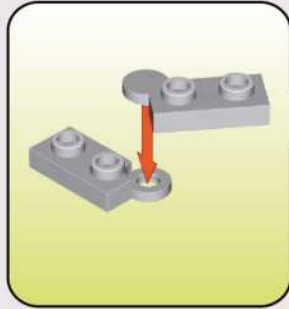

x2



x2



x2

67

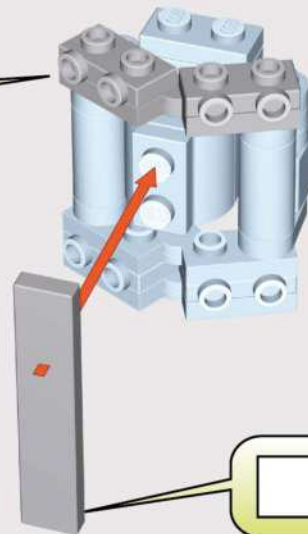
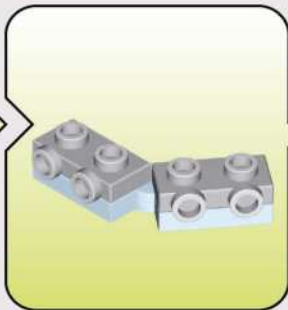
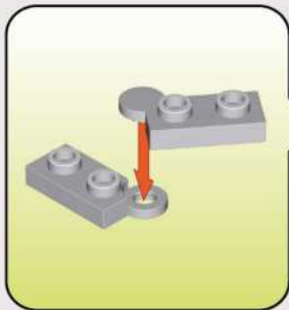

x1



x1



x2



x1

1:1

68

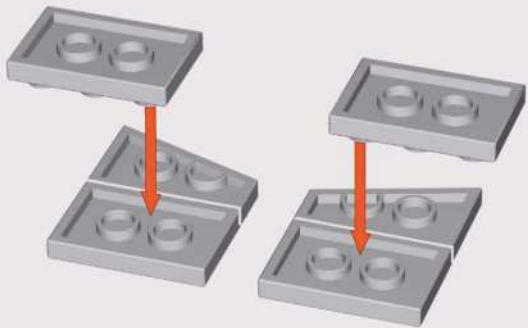

x2



x1



x1



x2

69

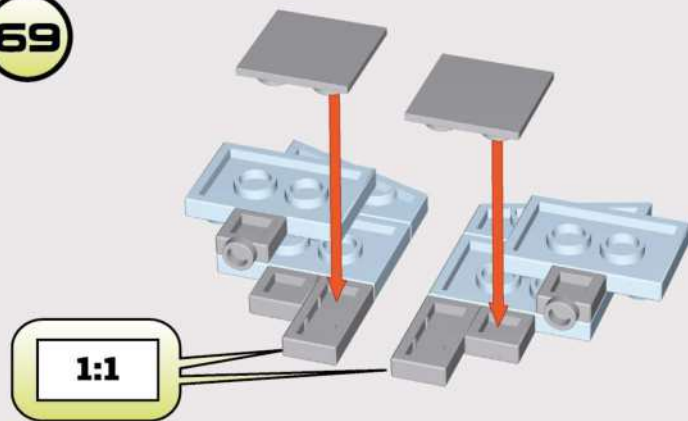

1:1



x2



x2



x2



x2

70

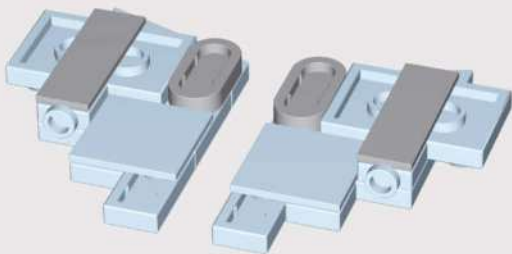

x2



x2

71

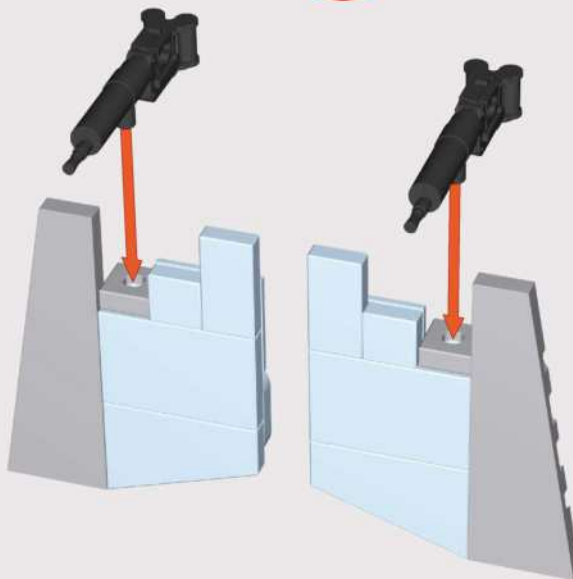

x2



x1



x1



x2



x2



x2



72

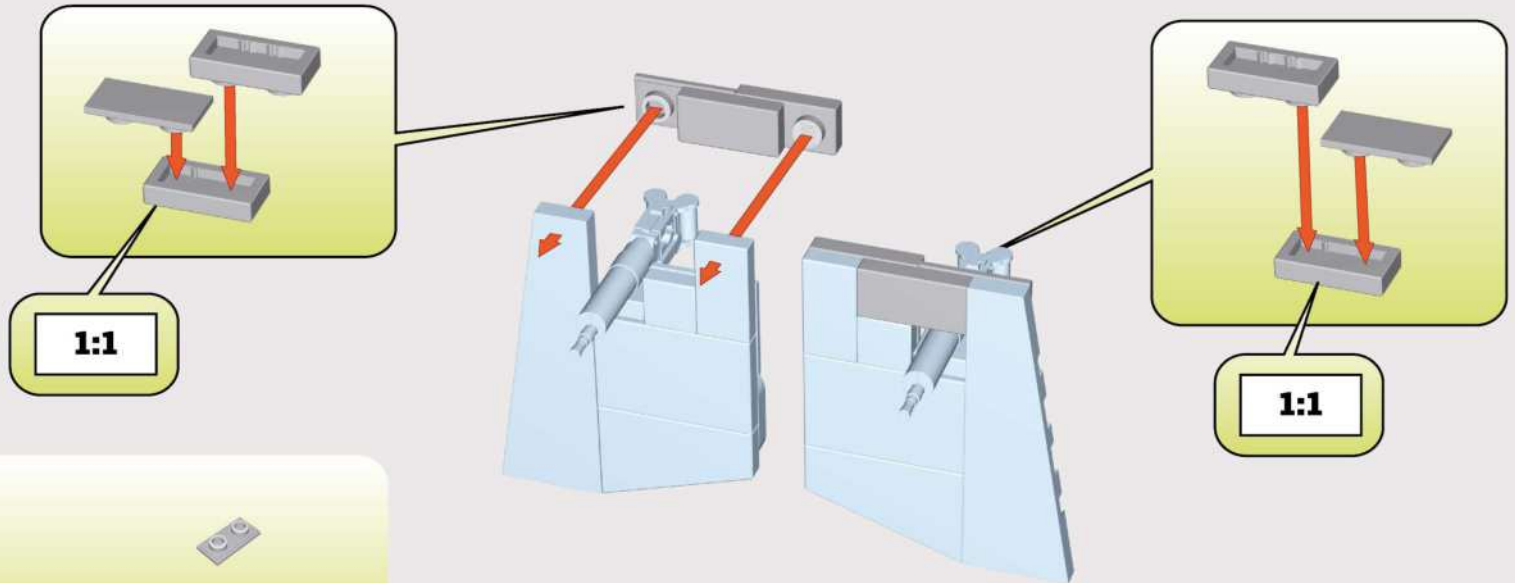

1:1

1:1



73

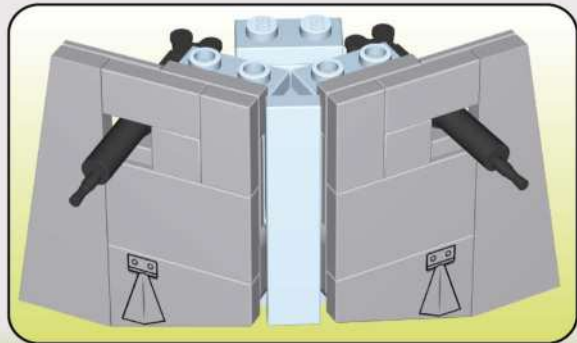
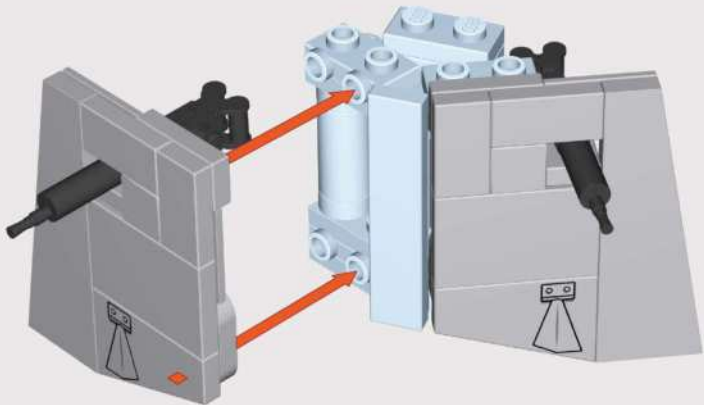

74

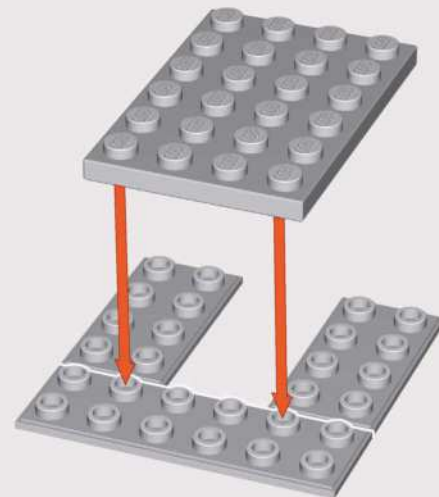

75

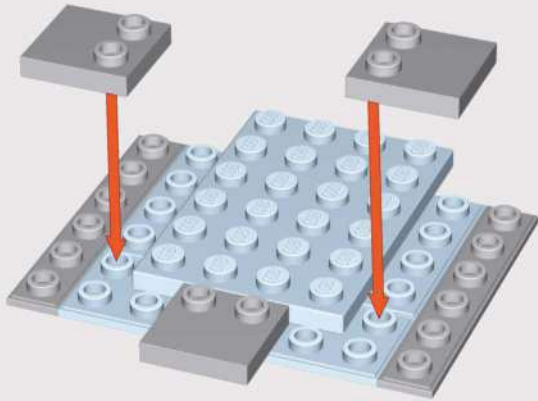

76

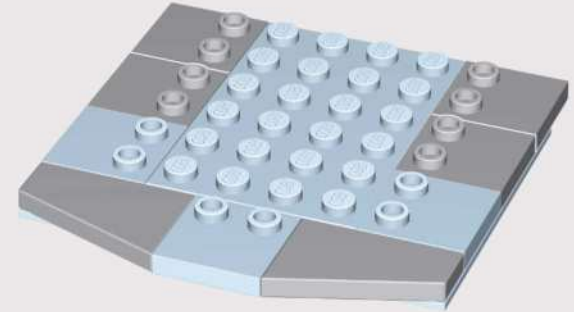

77



78

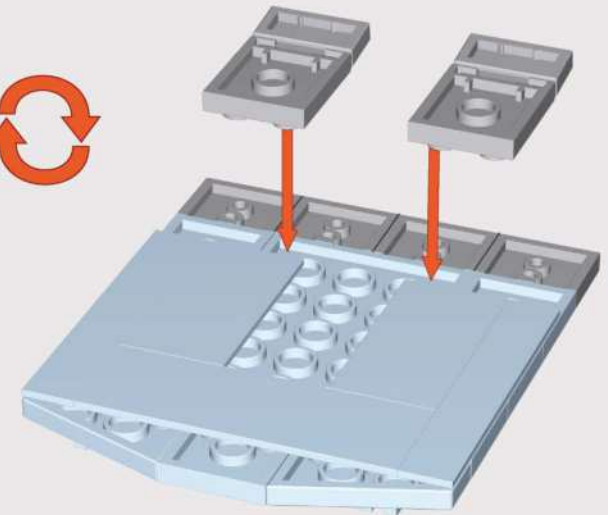

79

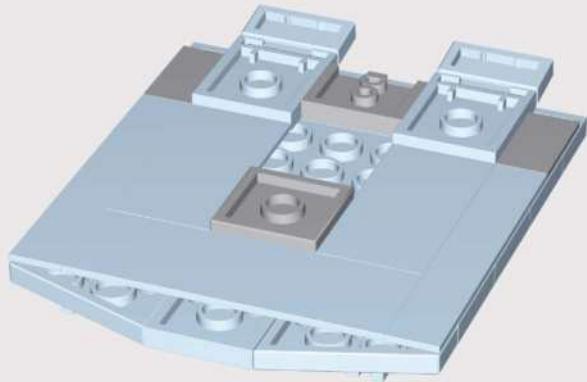

x1



x1



x2

80

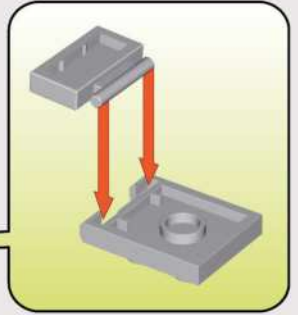
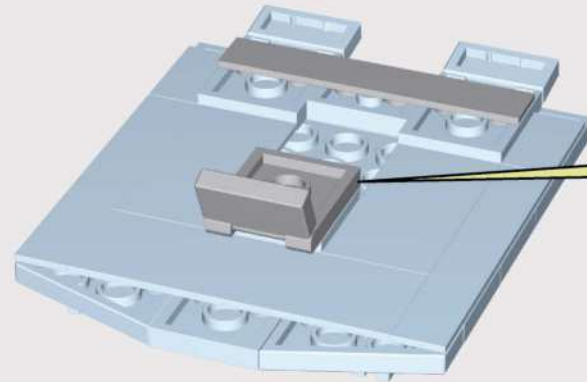

x1



x1



x1

81

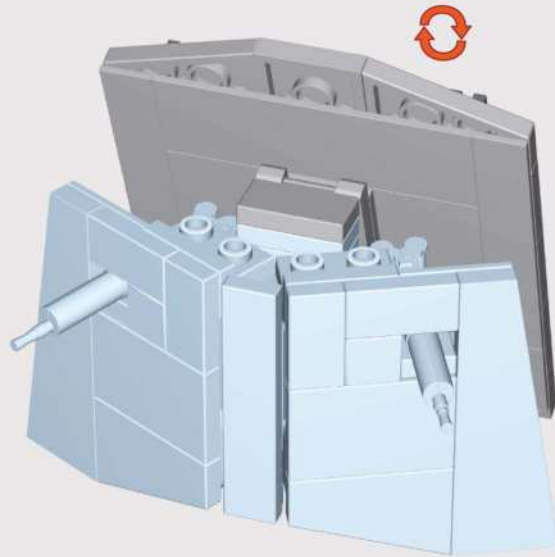

82

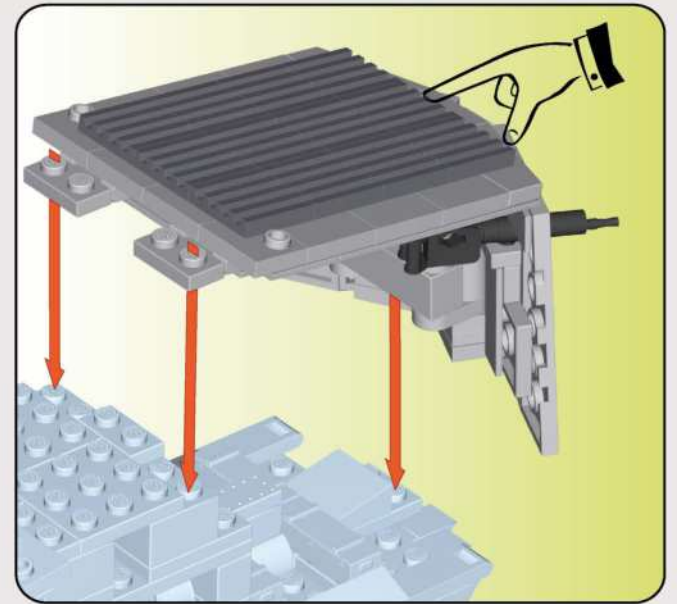
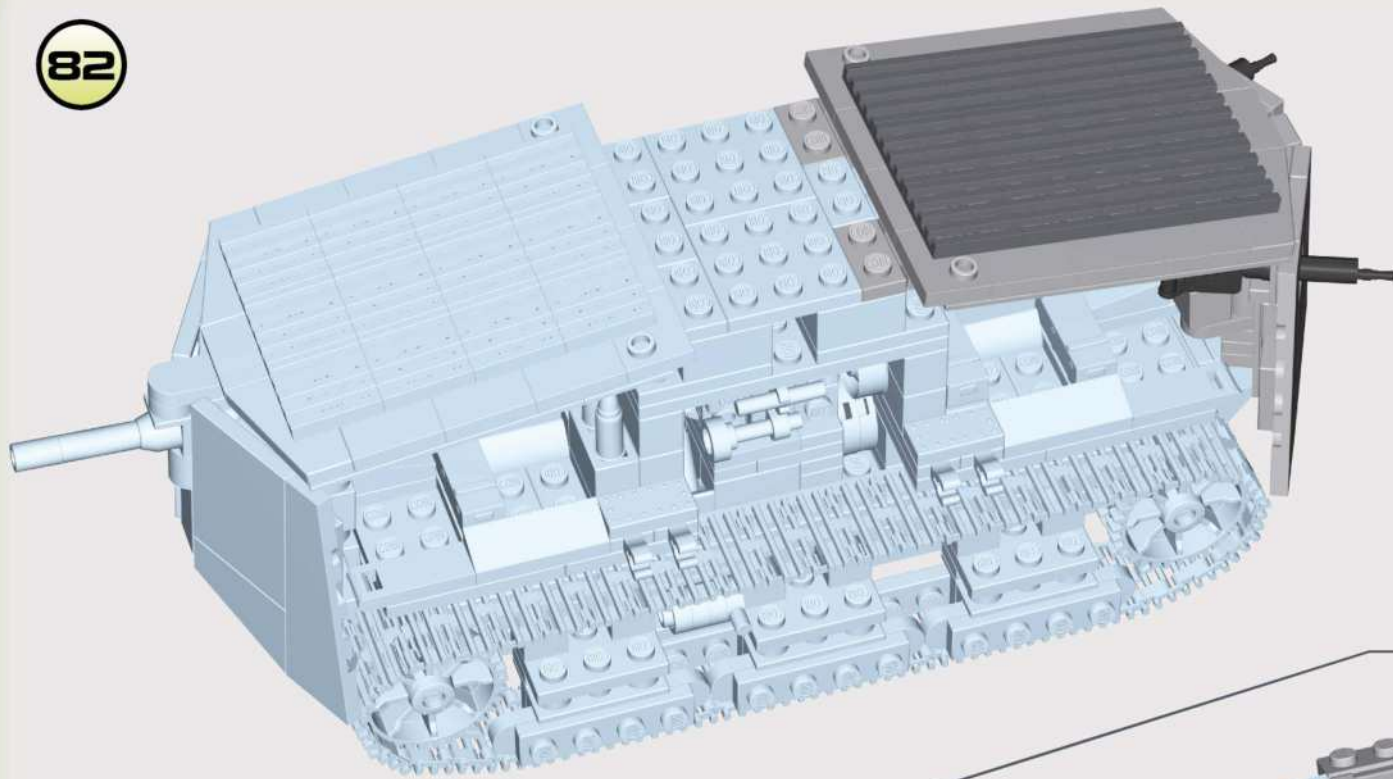

3

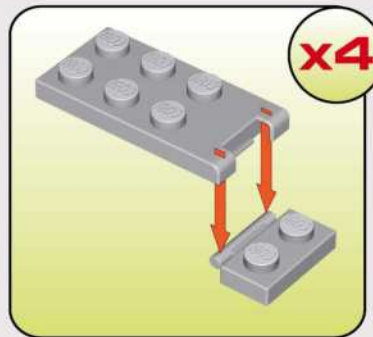

x4

83

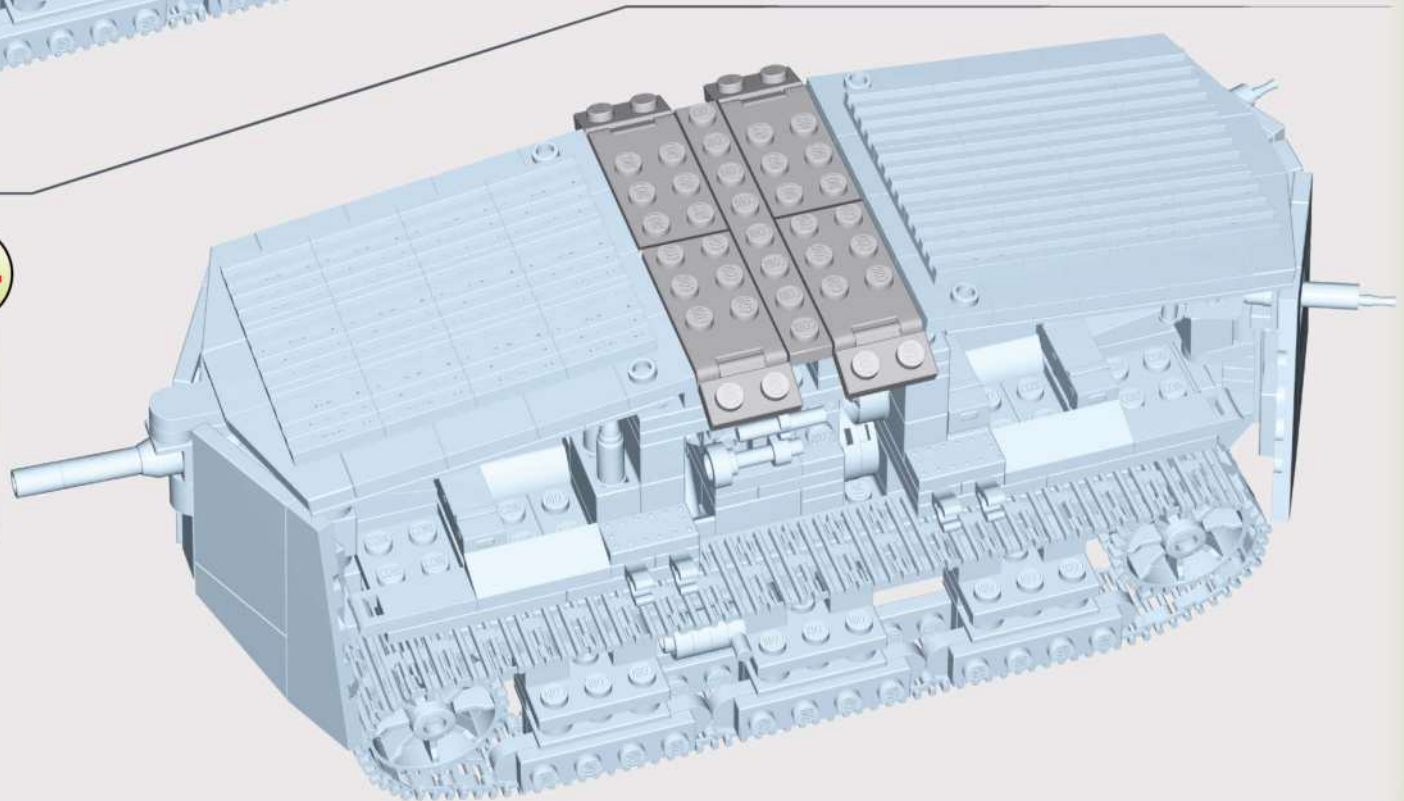

x4



x4



x1

84

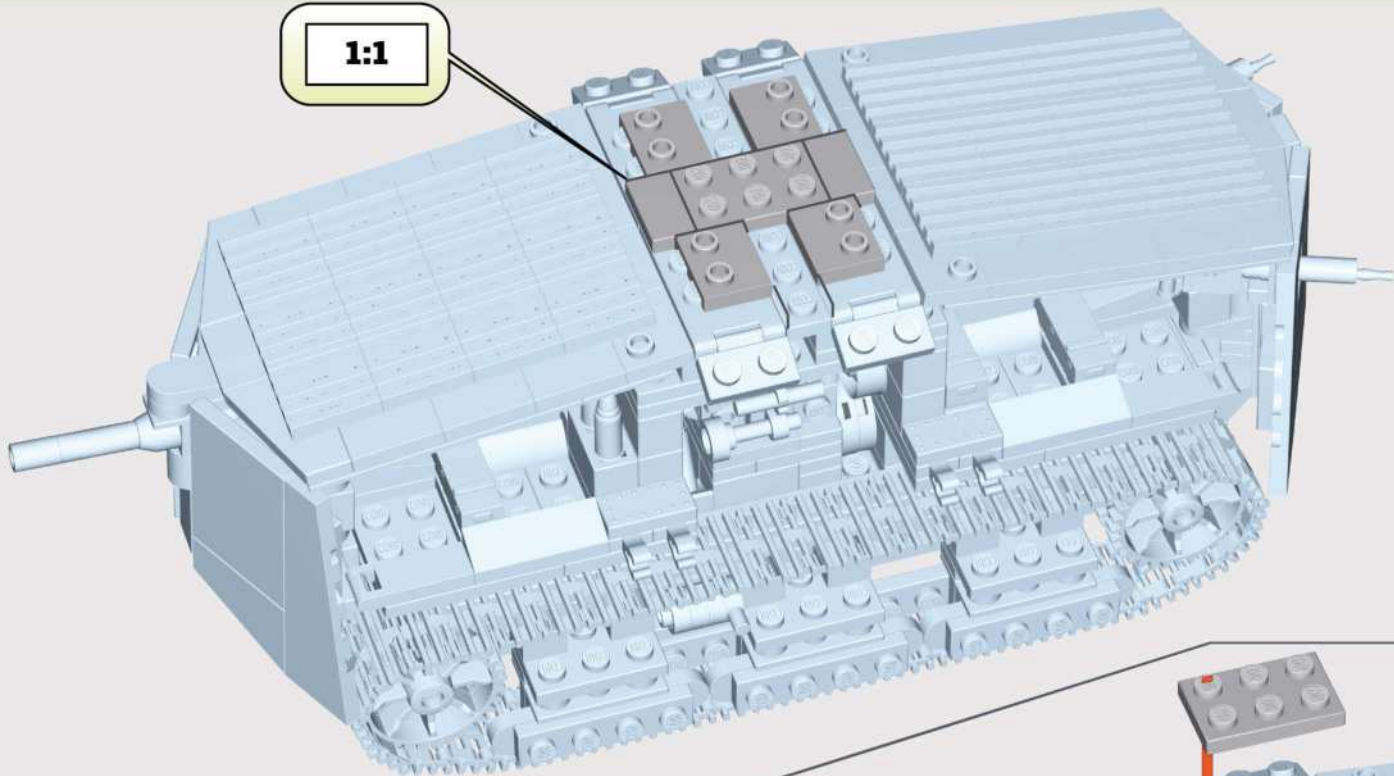

1:1

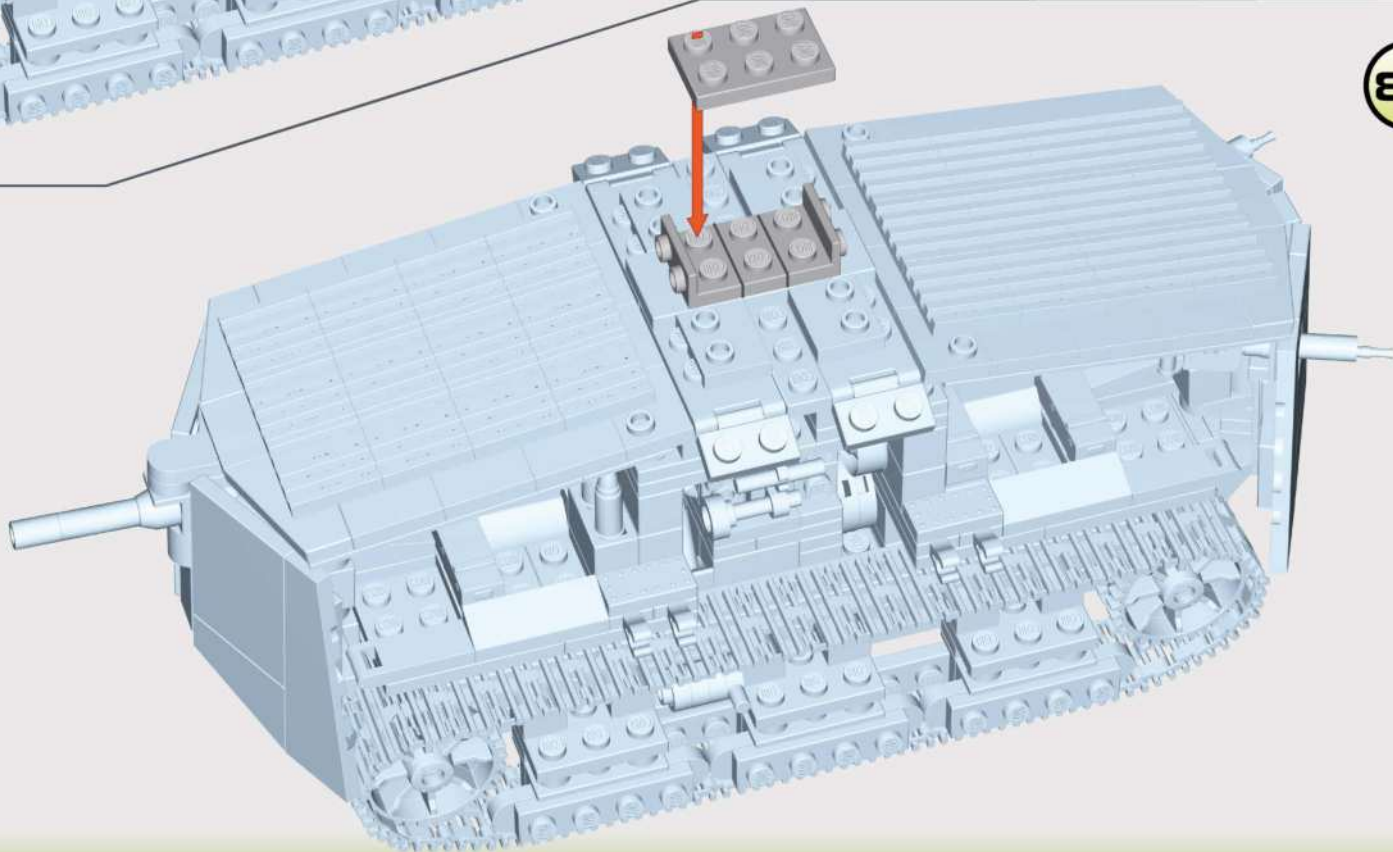

-  x4
-  x2
-  x1

85



-  x2
-  x1
-  x1

86

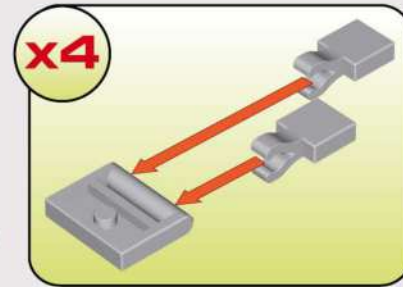
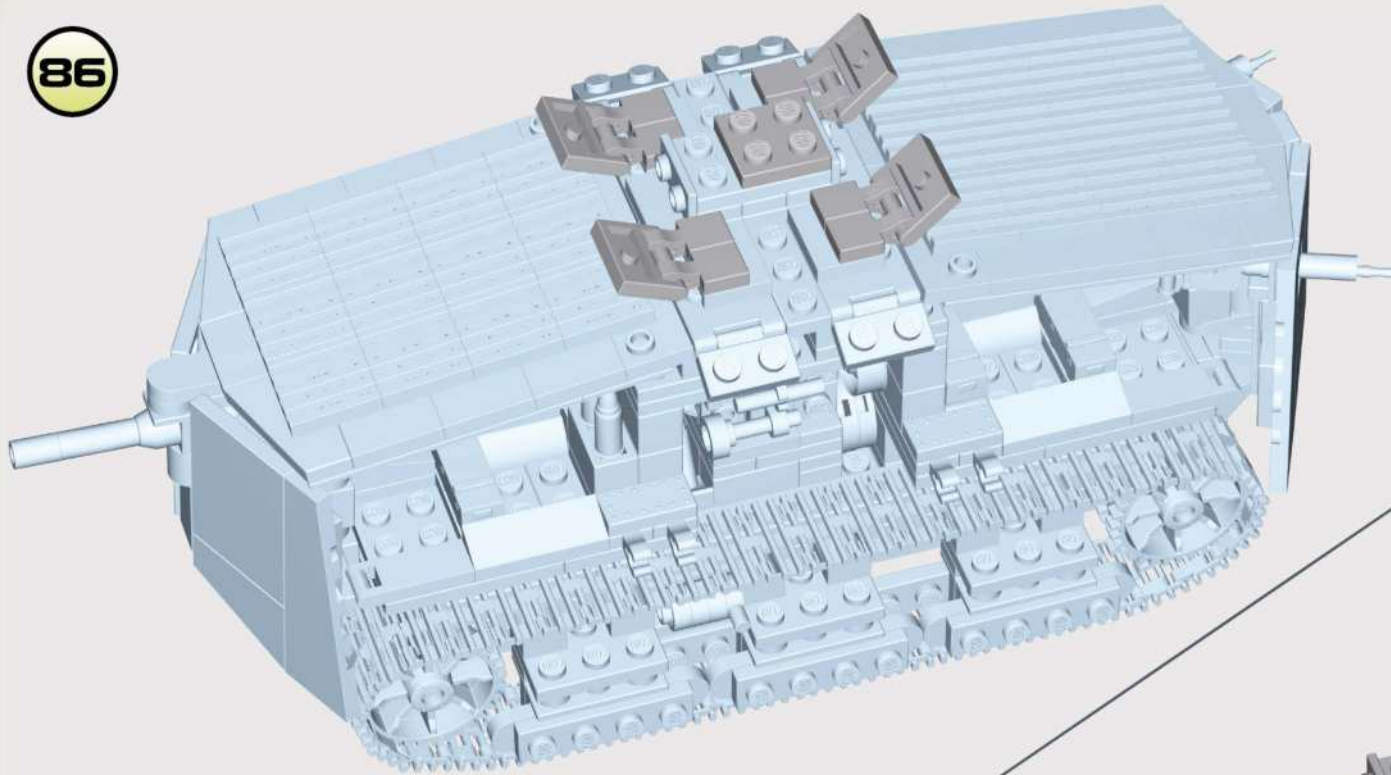

-  x8
-  x4
-  x1

87

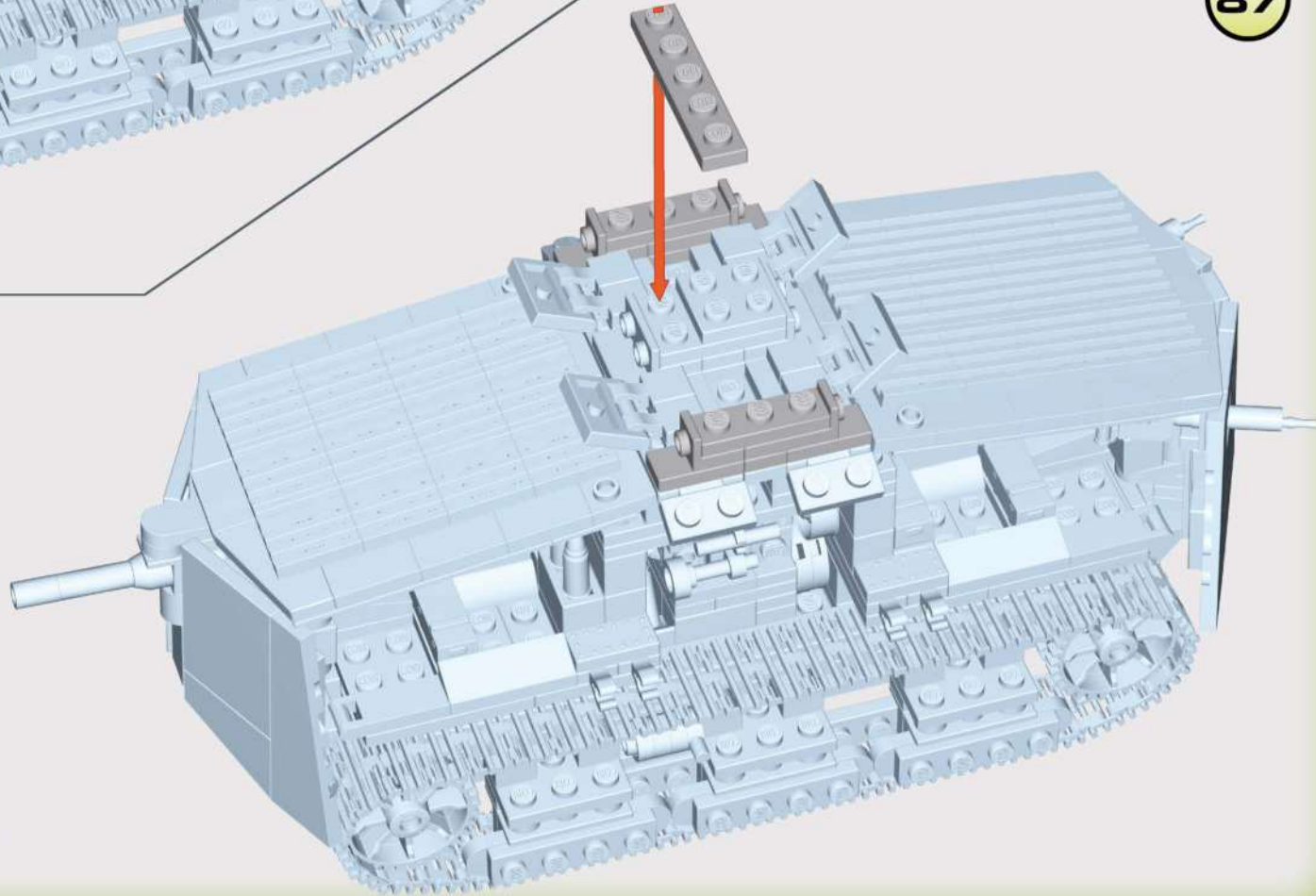



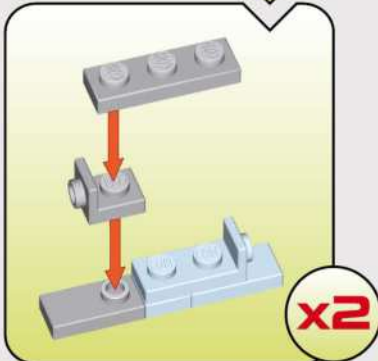
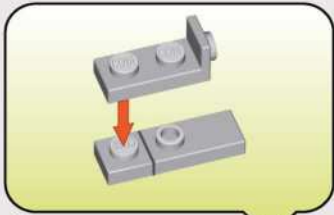

-  x2
-  x4
-  x2
-  x2
-  x2
-  x1

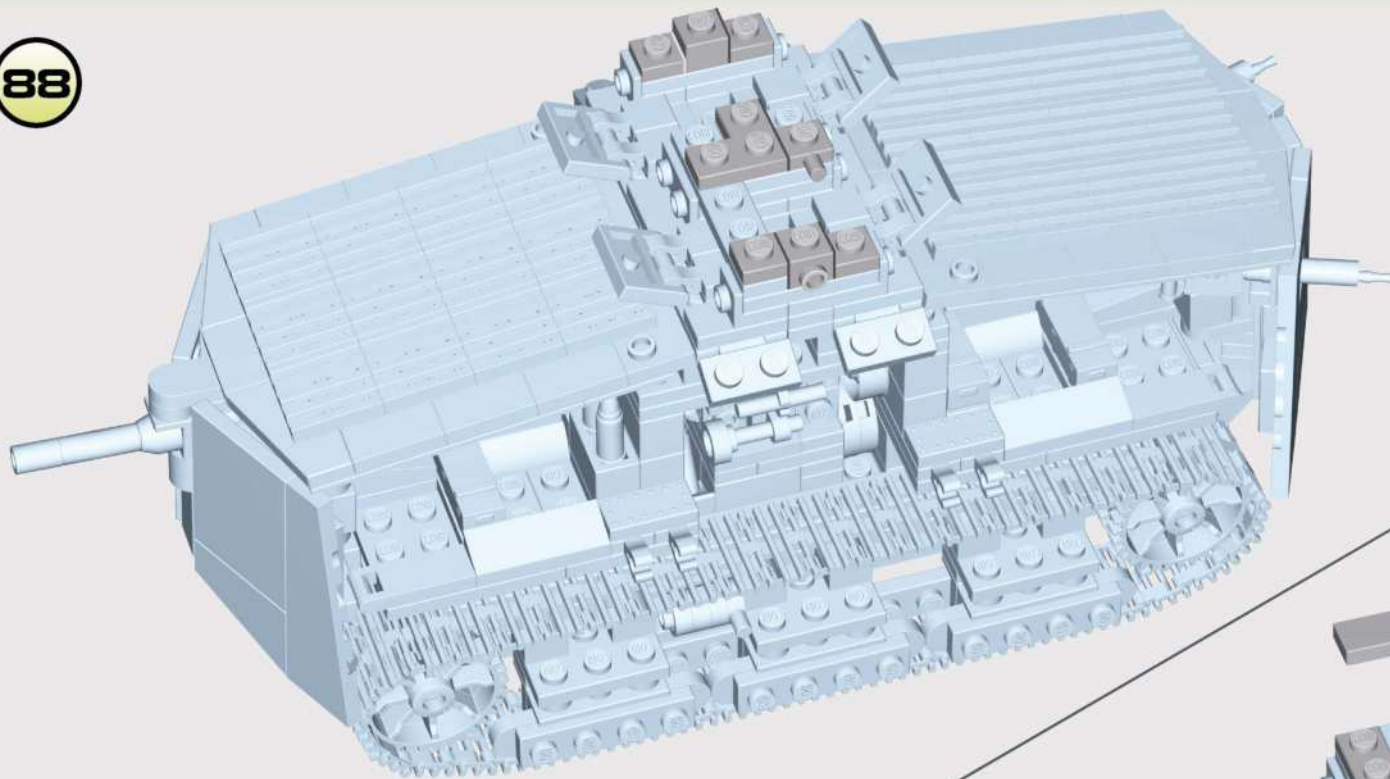

88





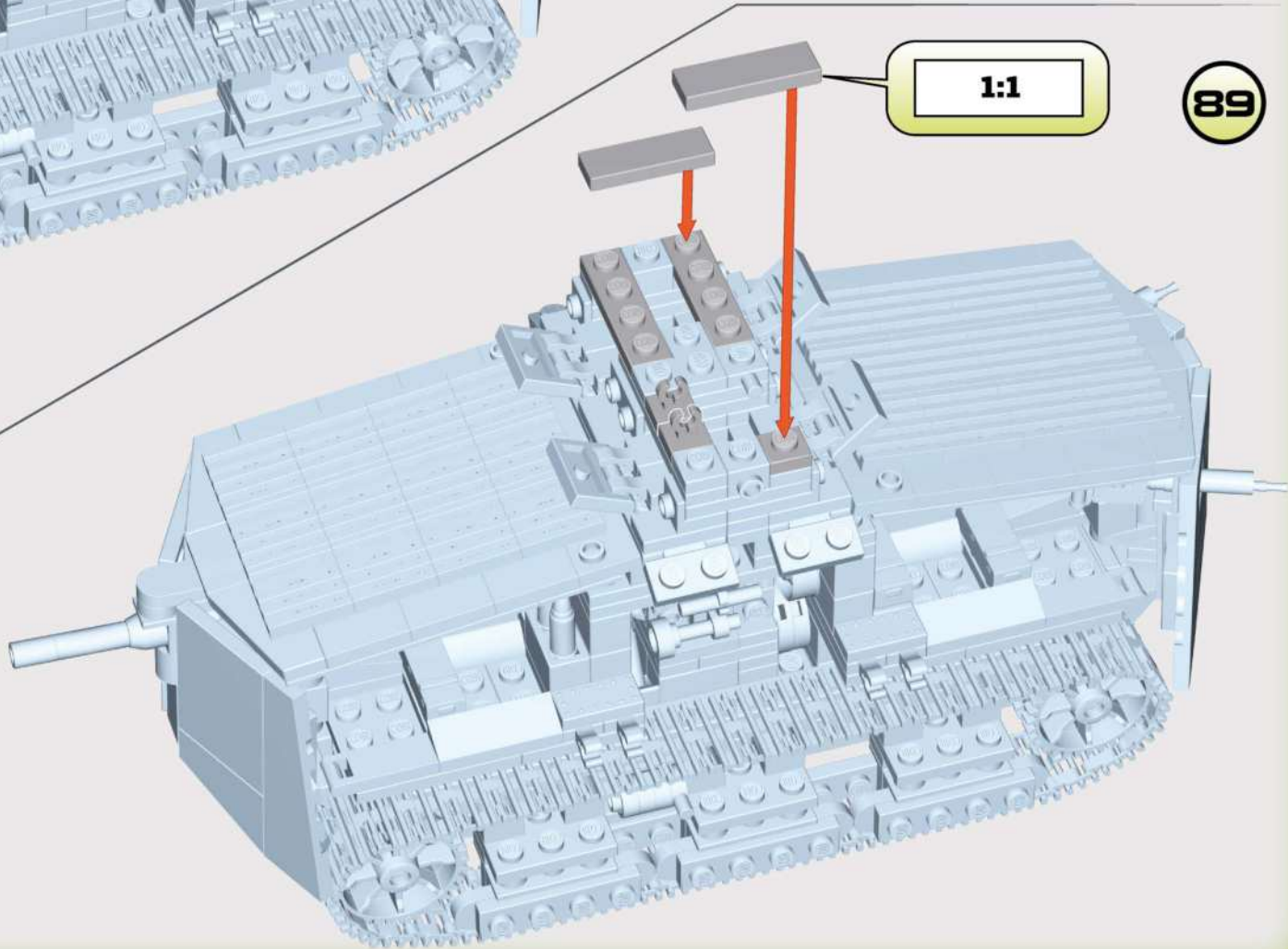

 x4	 x2
 x1	 x1

1:1

89





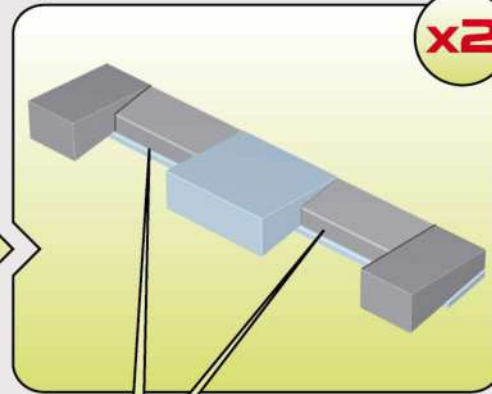
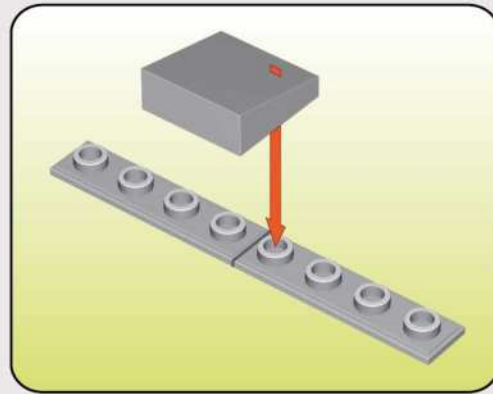

 x2	 x1
 x2	 x2

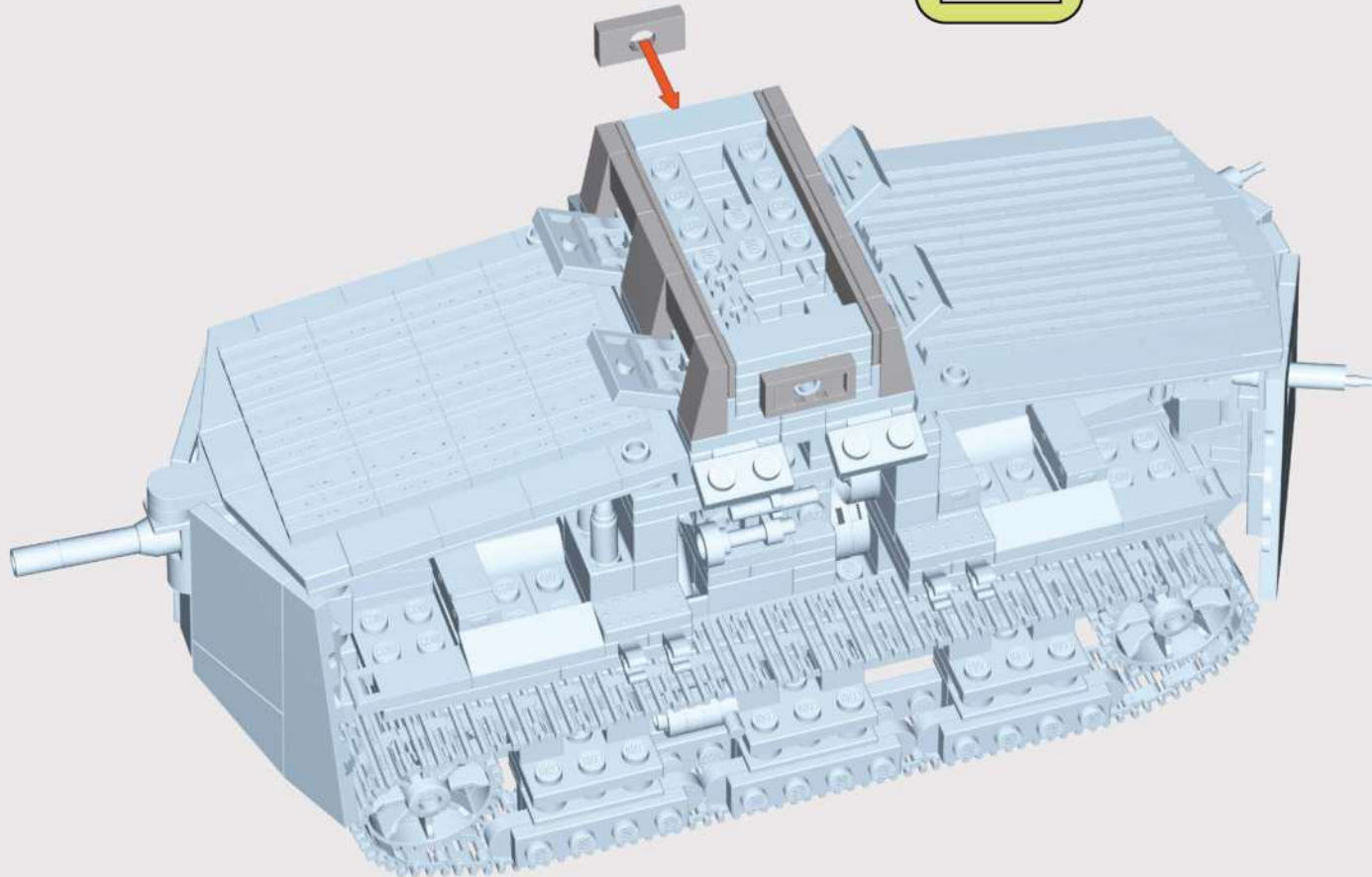

1:1



-  x4
-  x2
-  x4
-  x4
-  x2



91

1:1

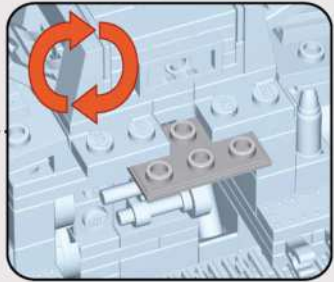
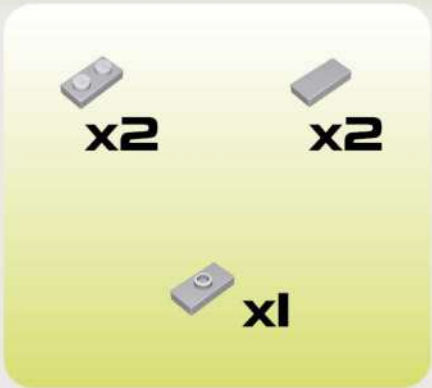
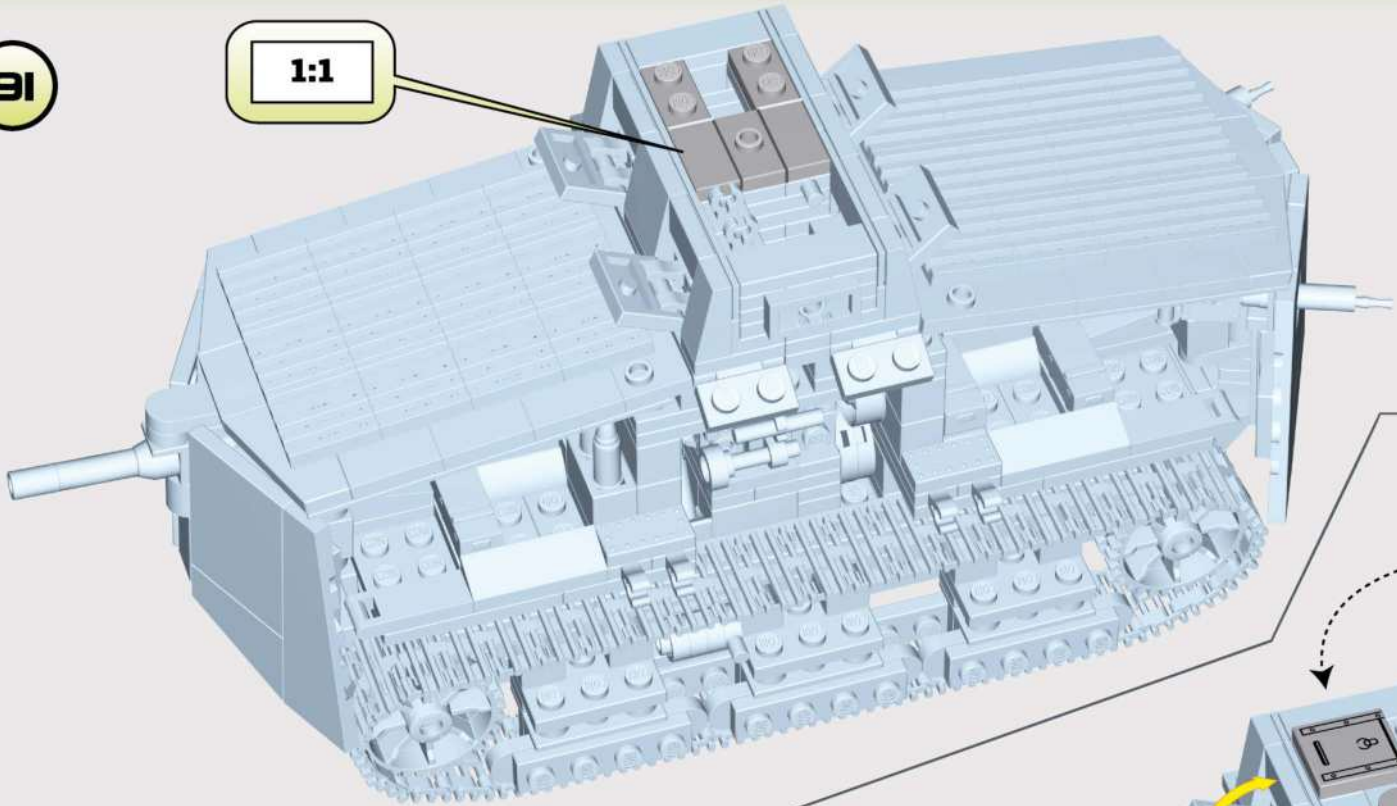

92

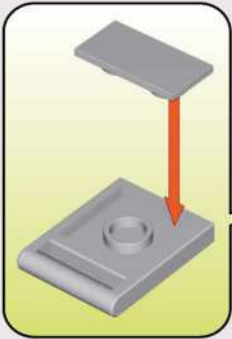
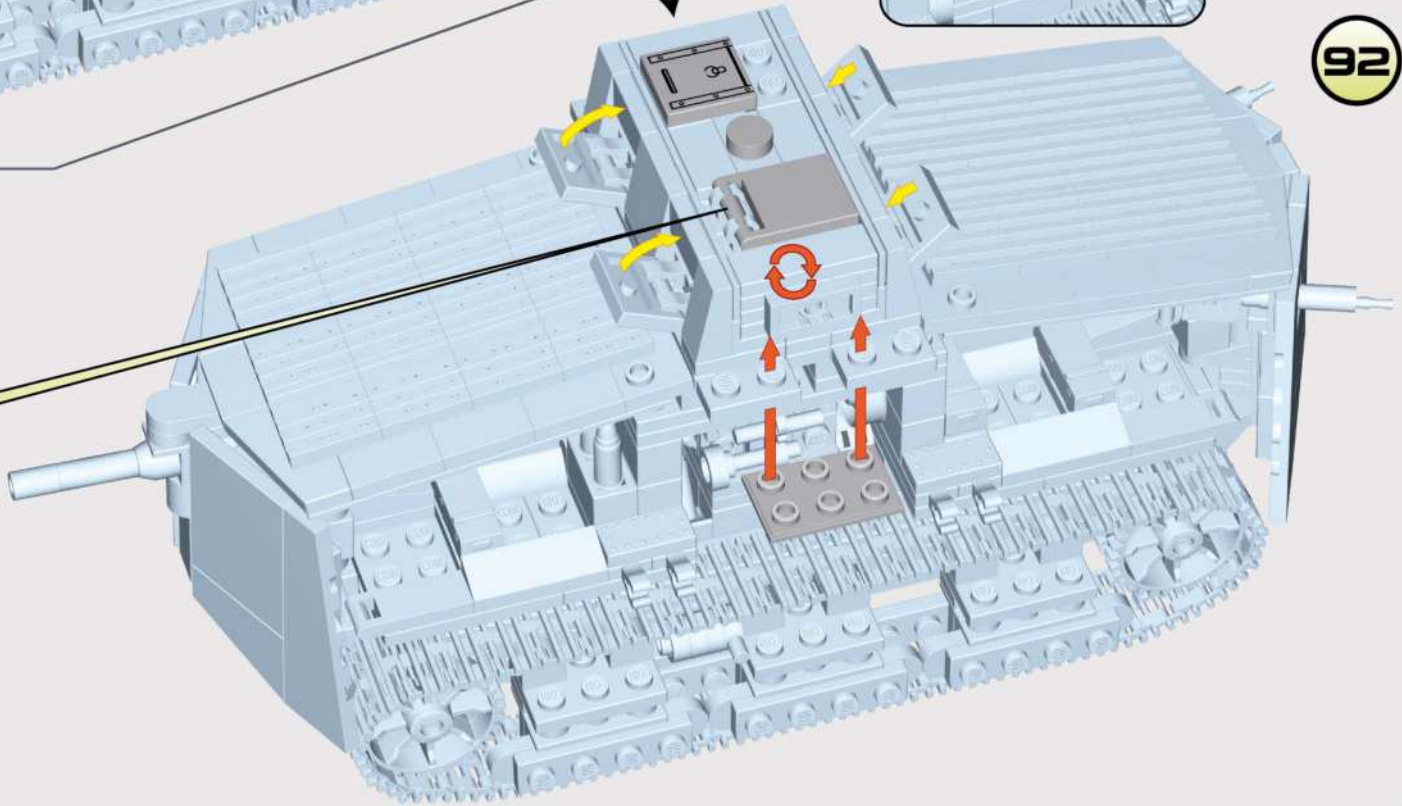

93

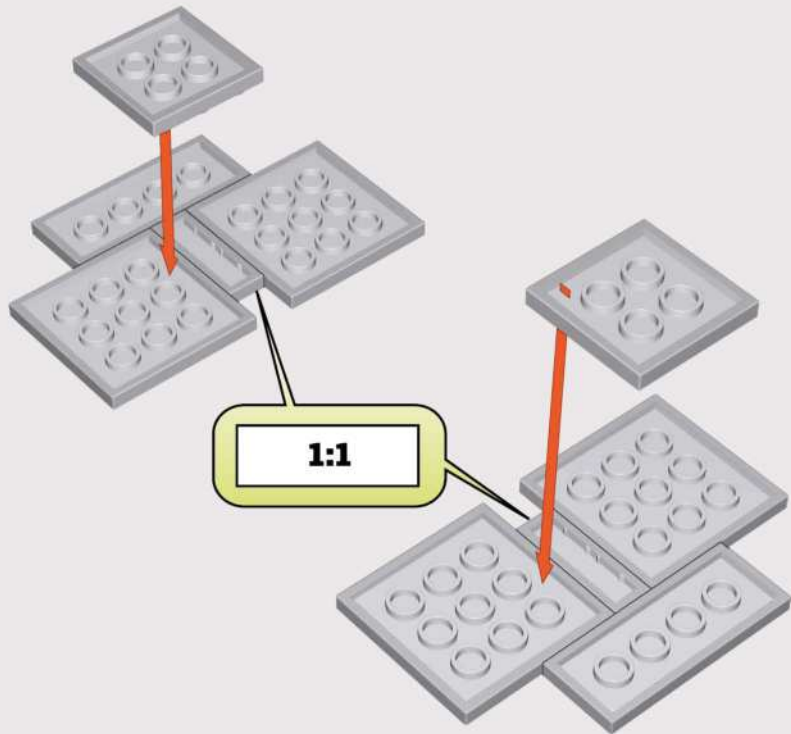

x4



x2



x2



x2

94

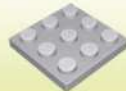
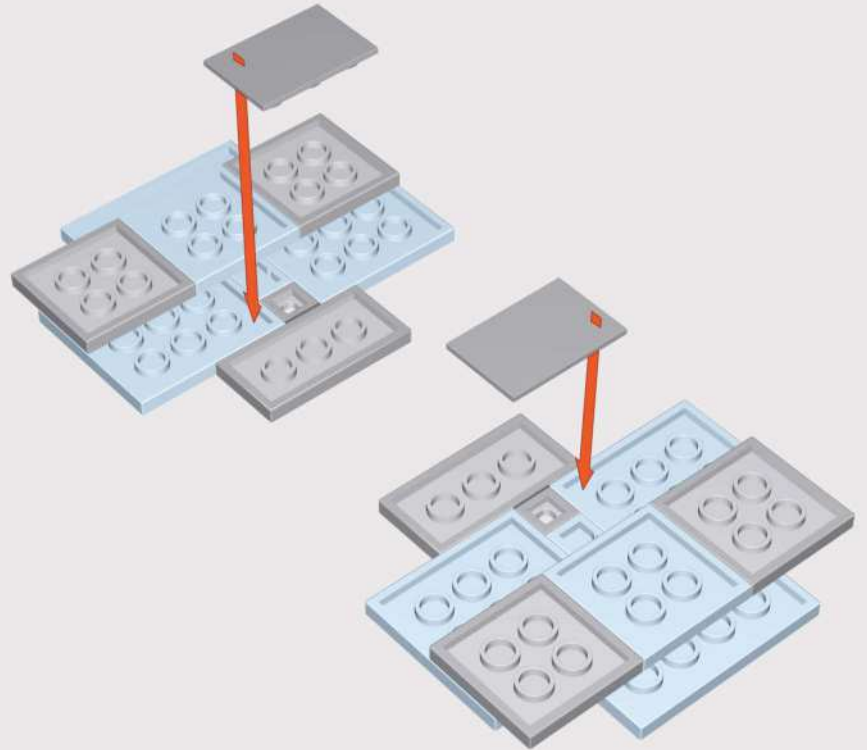

x4



x2



x2



x2

95

1:1

1:1

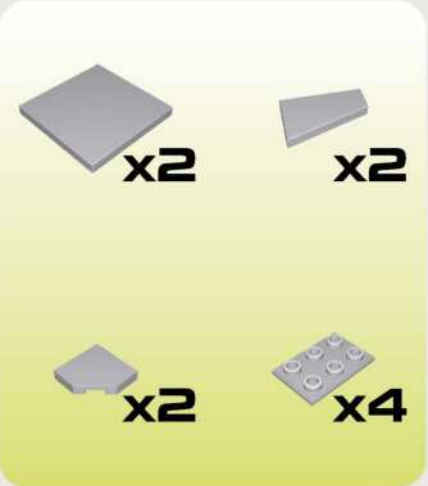
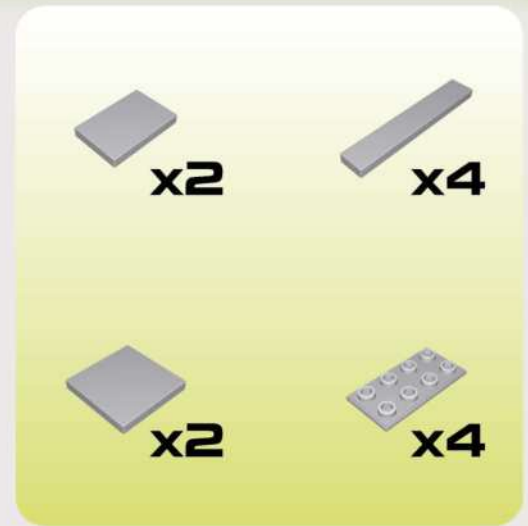
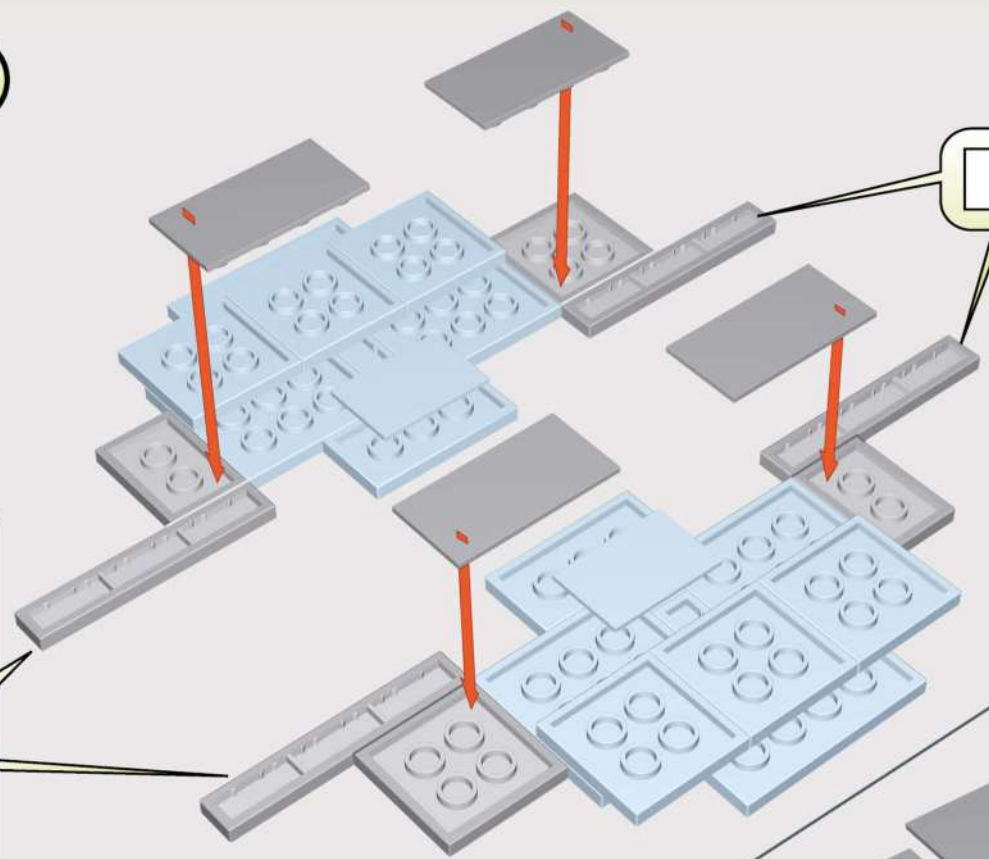

96

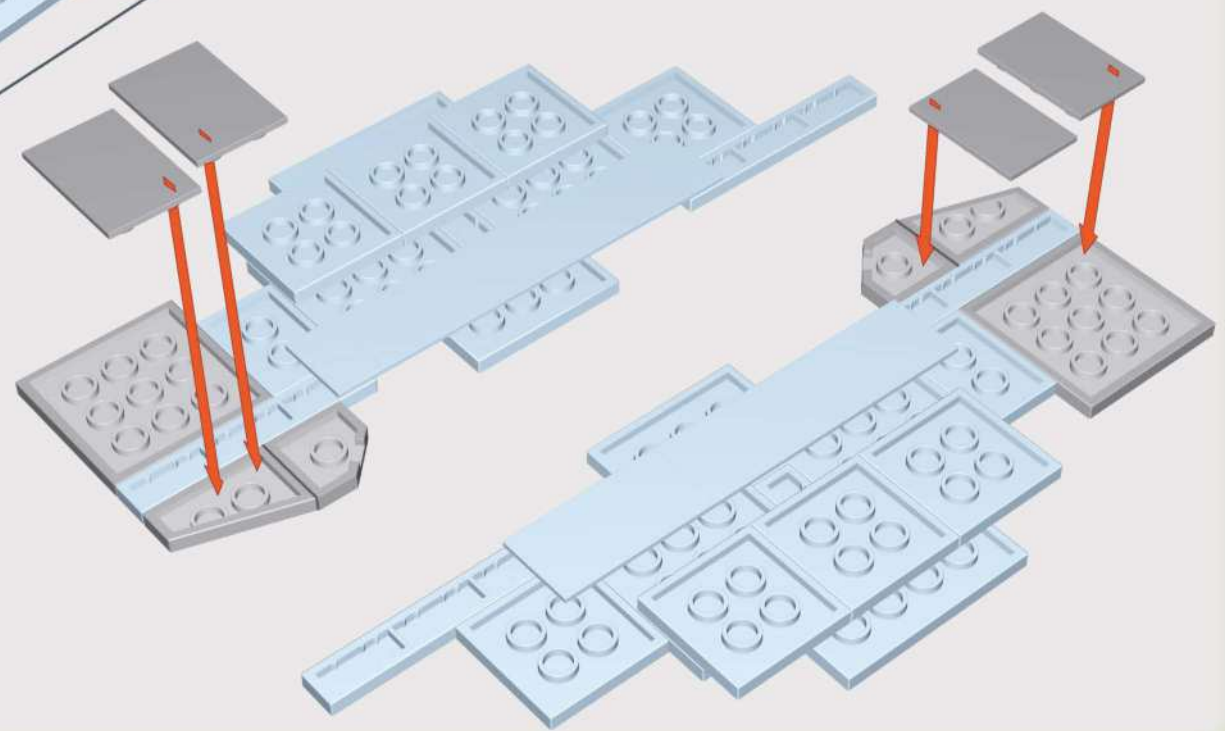

97

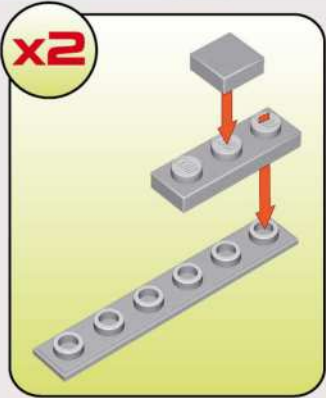
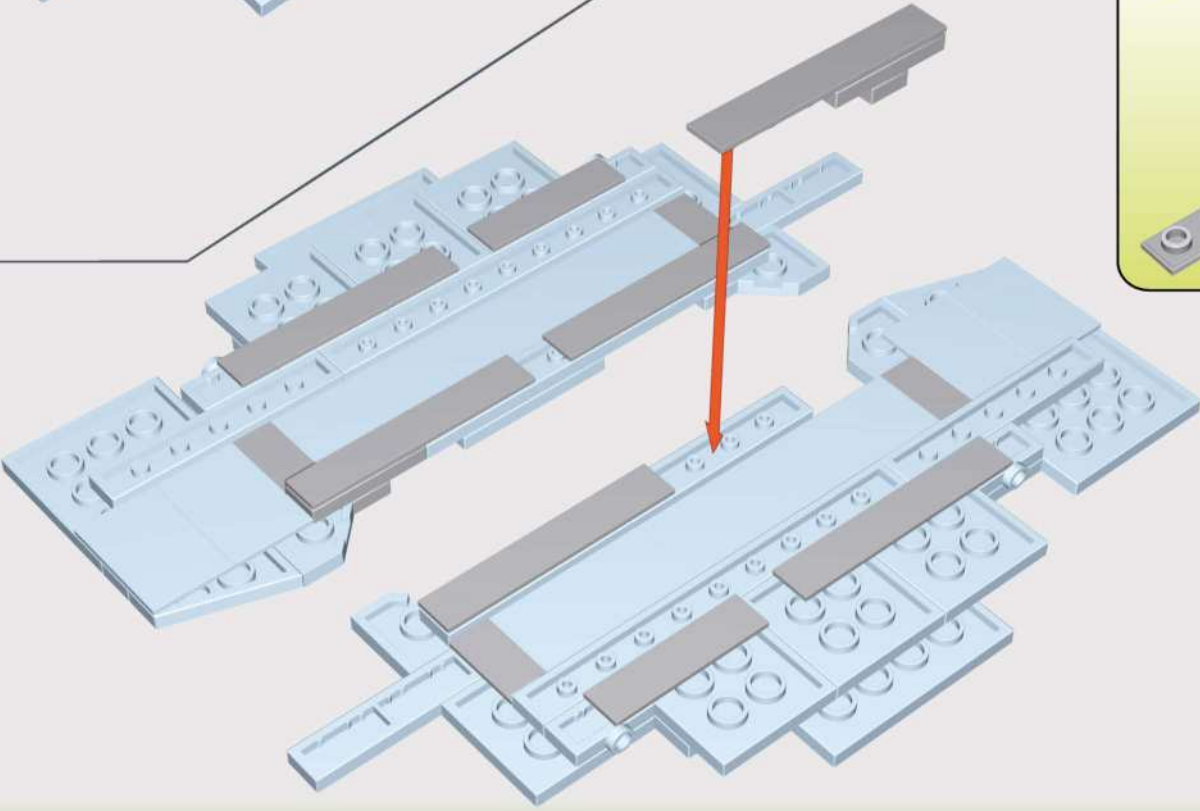
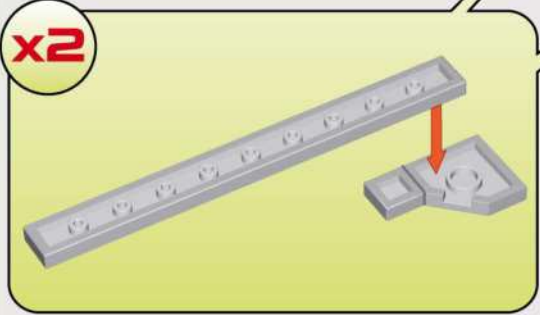
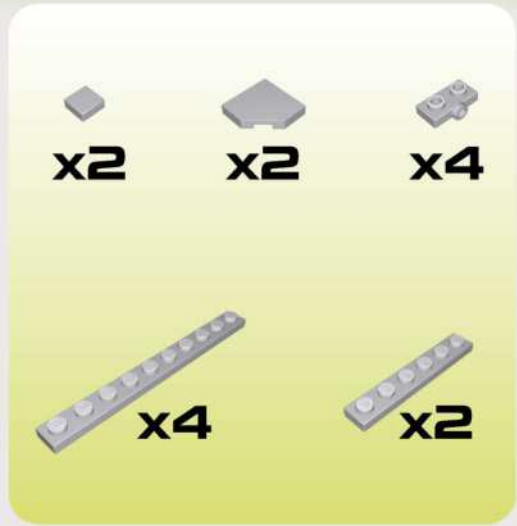
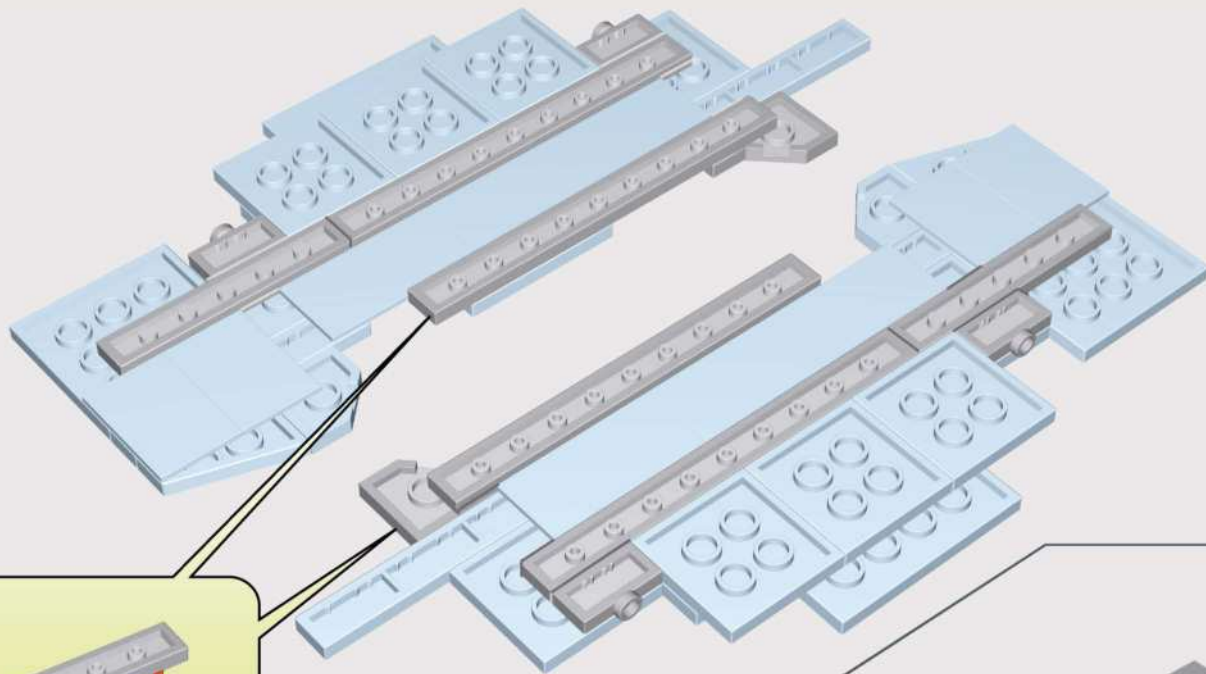

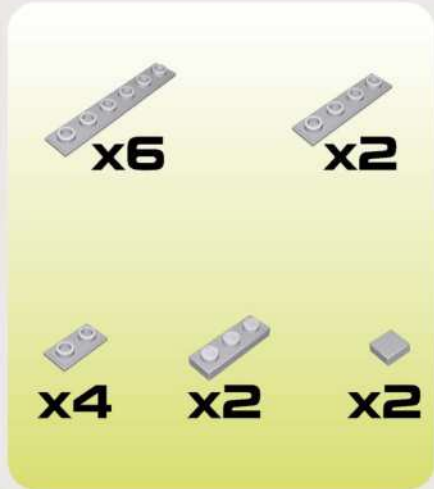

98



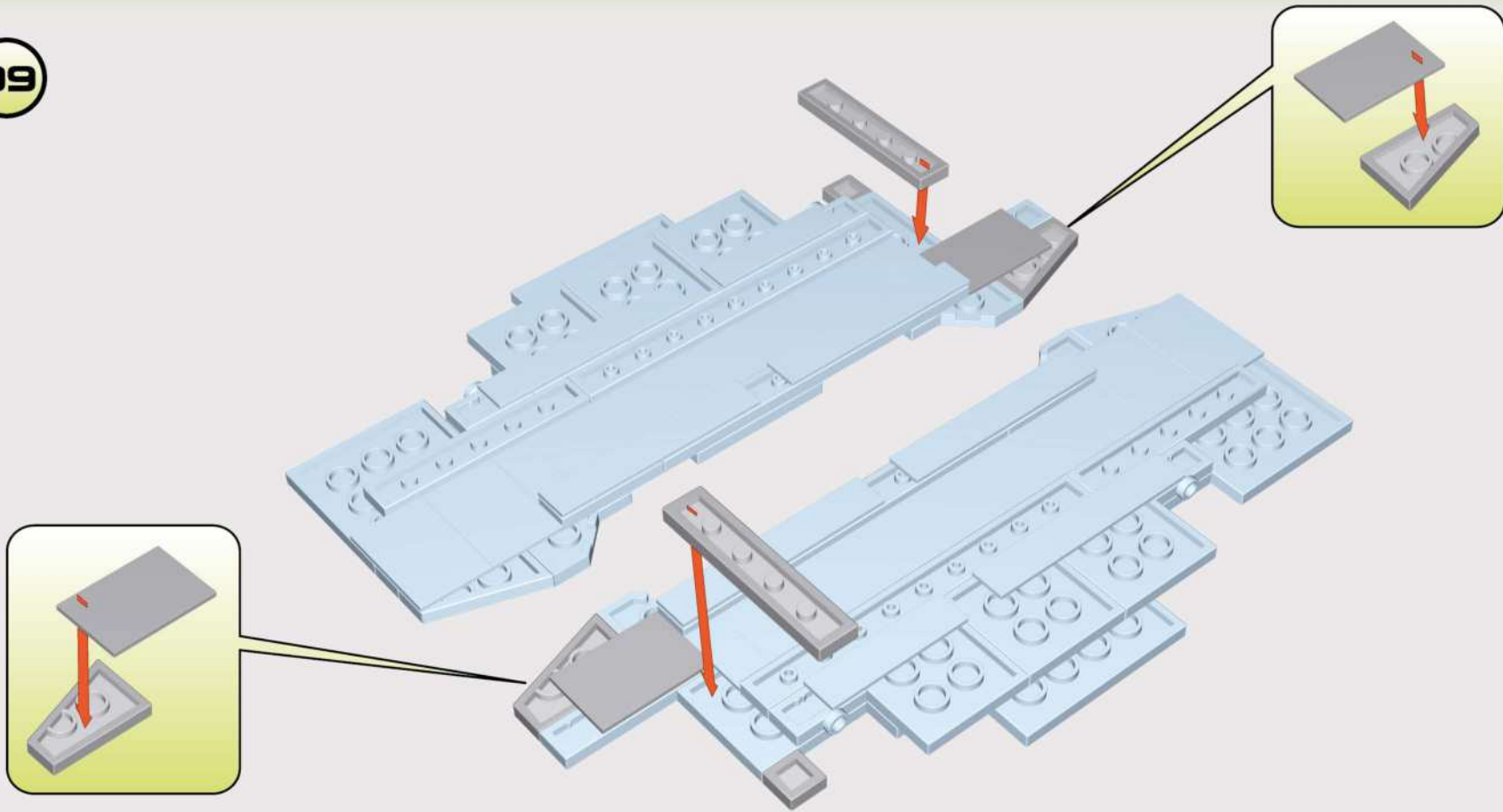

99

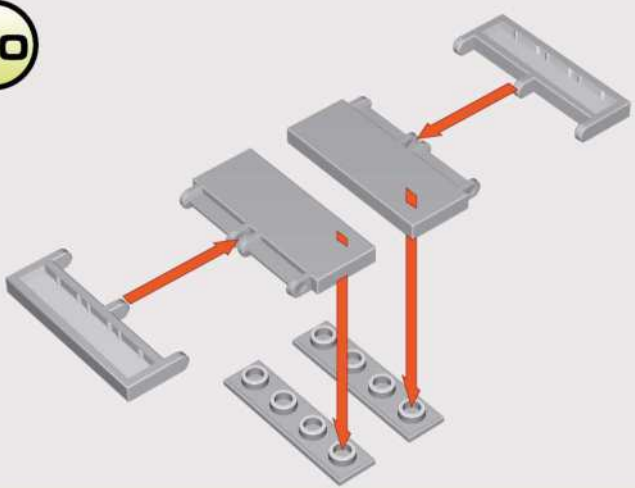

-  x2
-  x2
-  x2
-  x2

100



-  x2
-  x2
-  x2

101

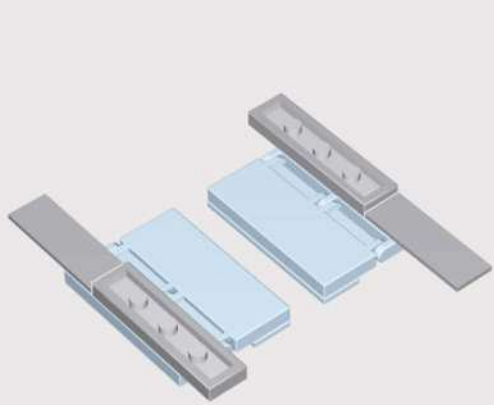

-  x2
-  x2

102

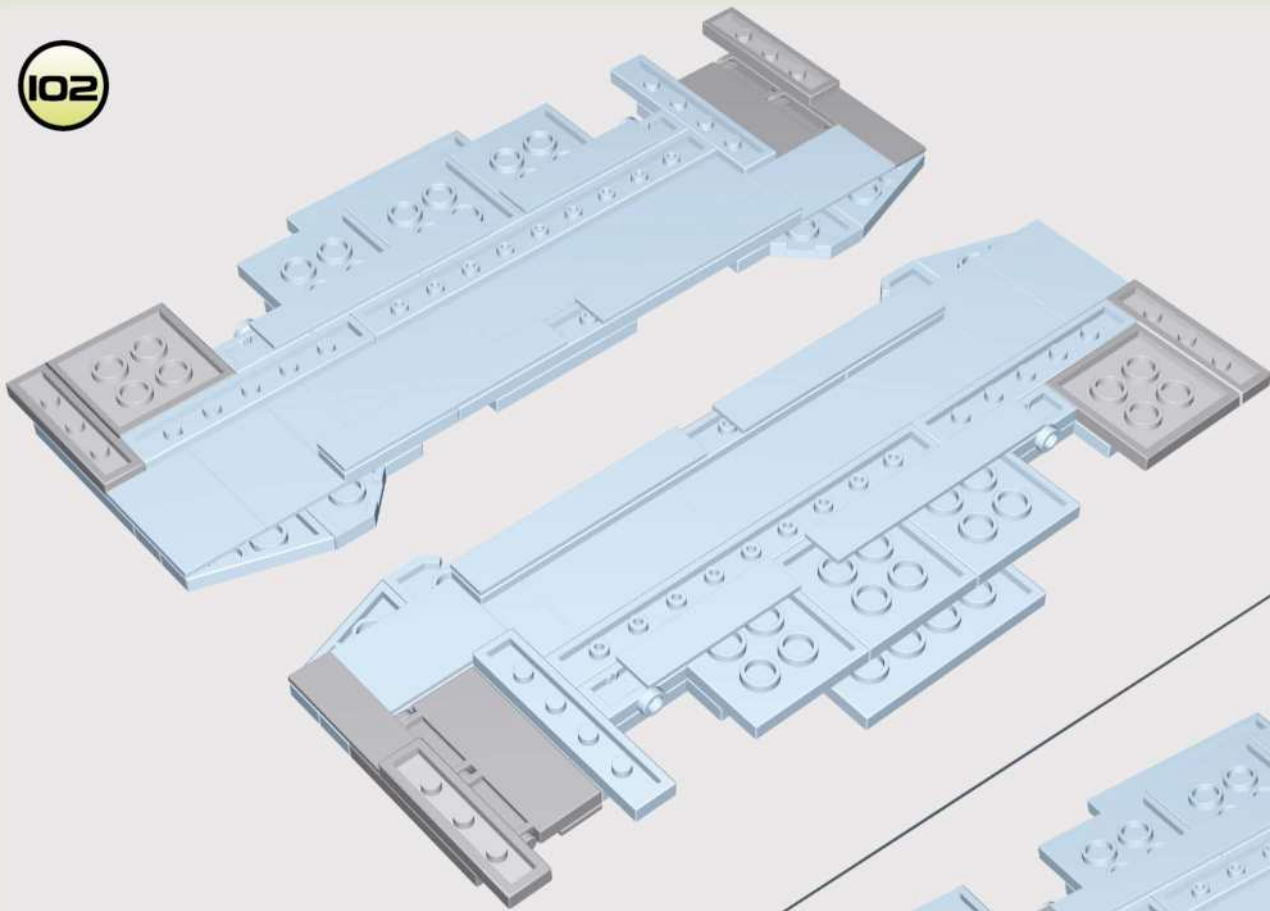

103

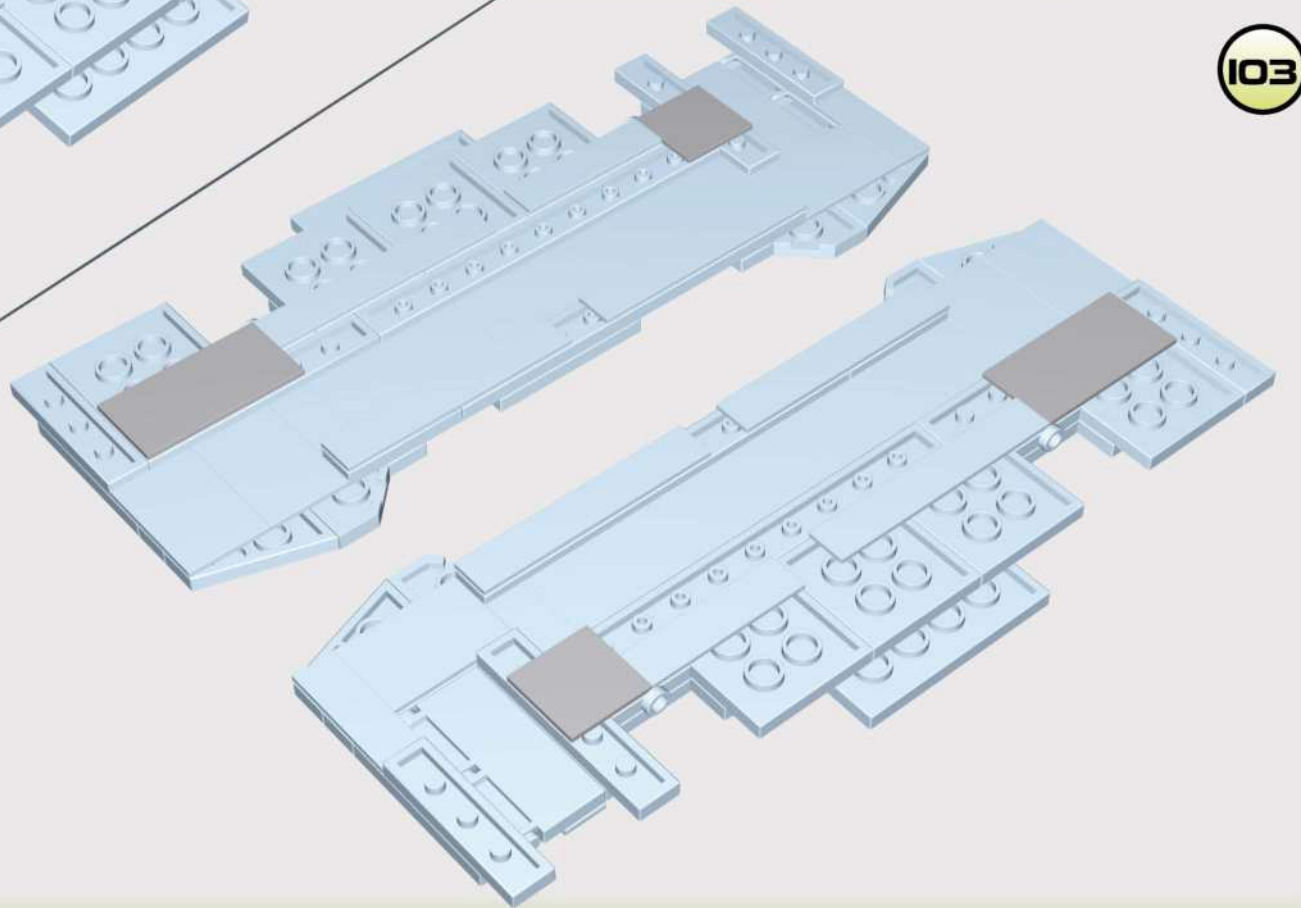

104

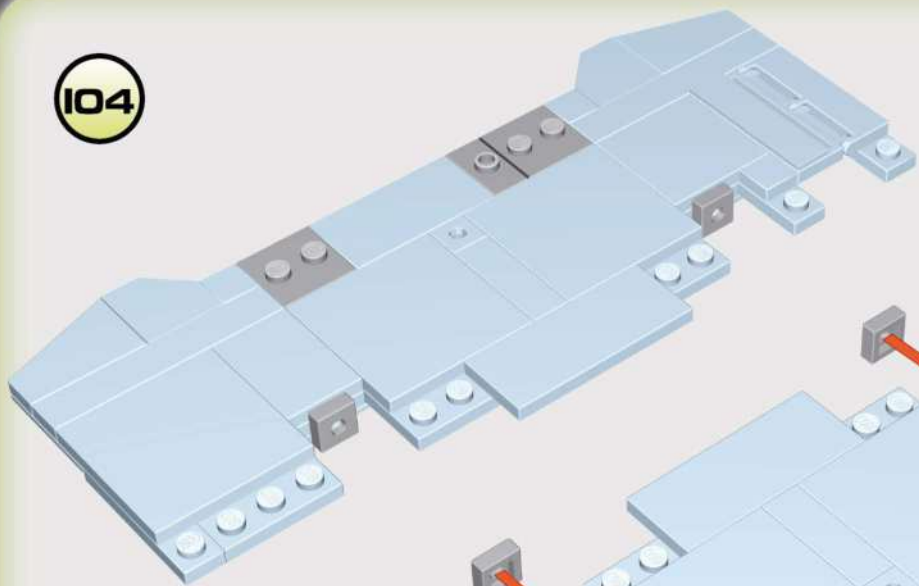

 x4

 x2

 x4

105

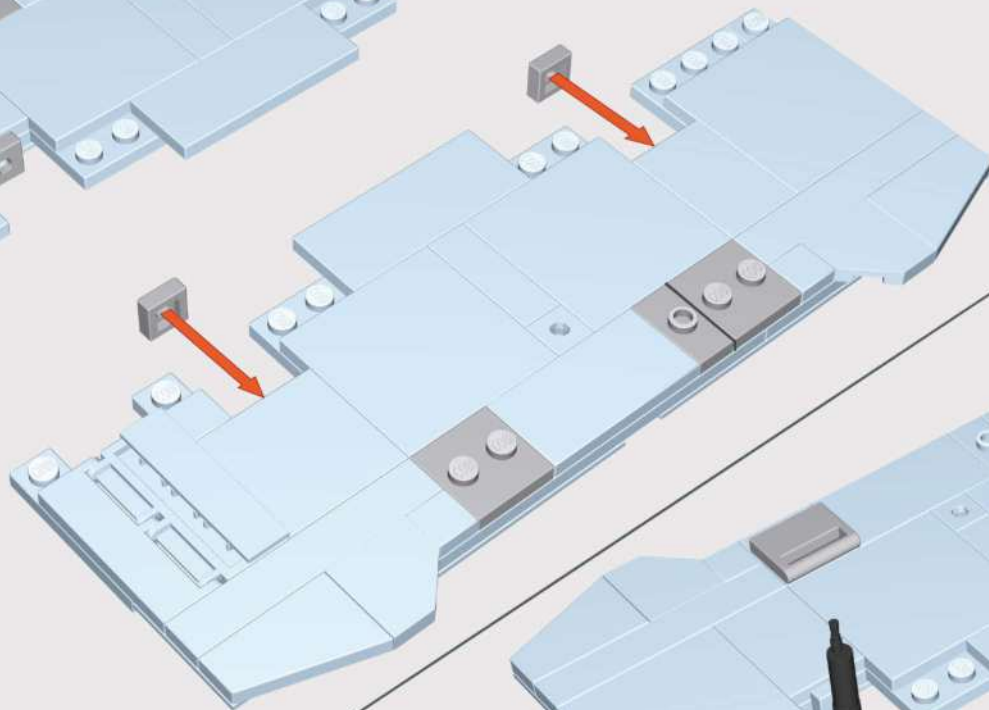

 x4

 x4

 x4

x4

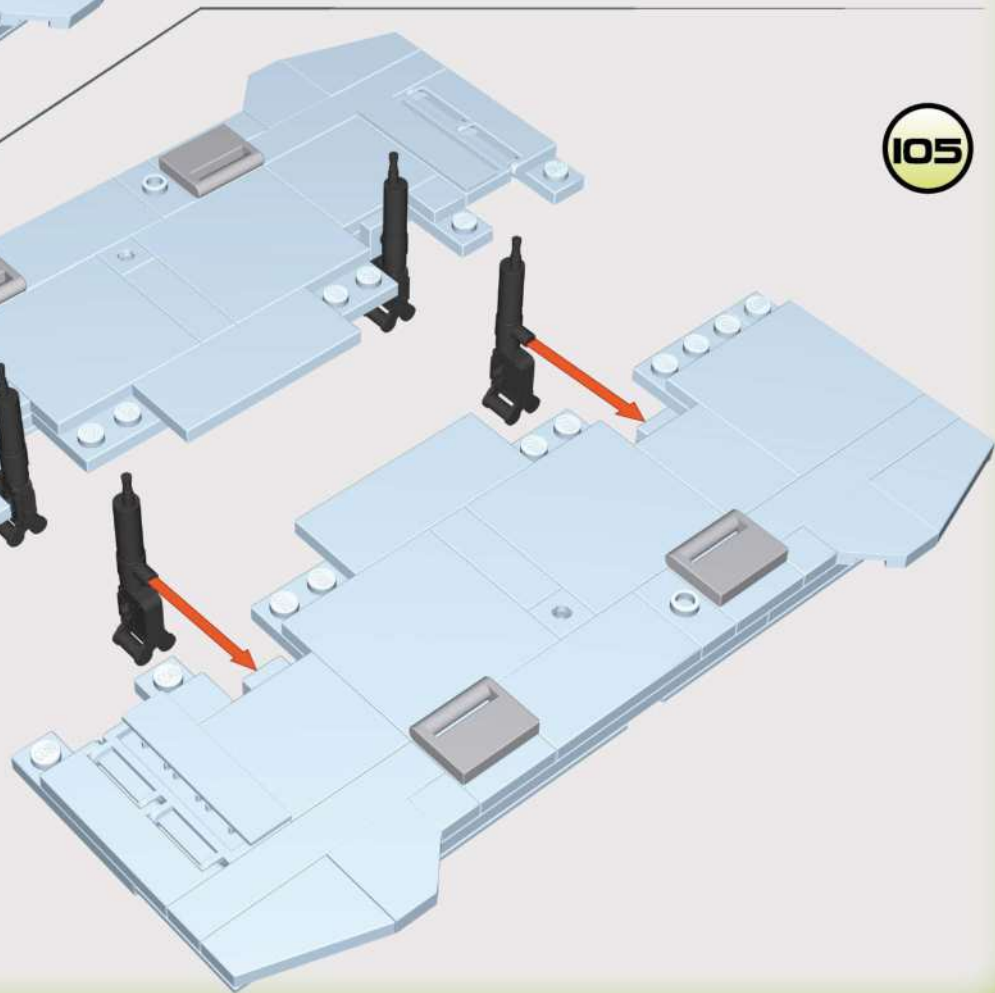

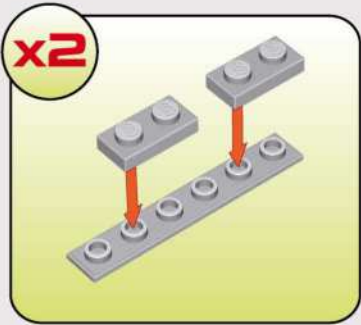
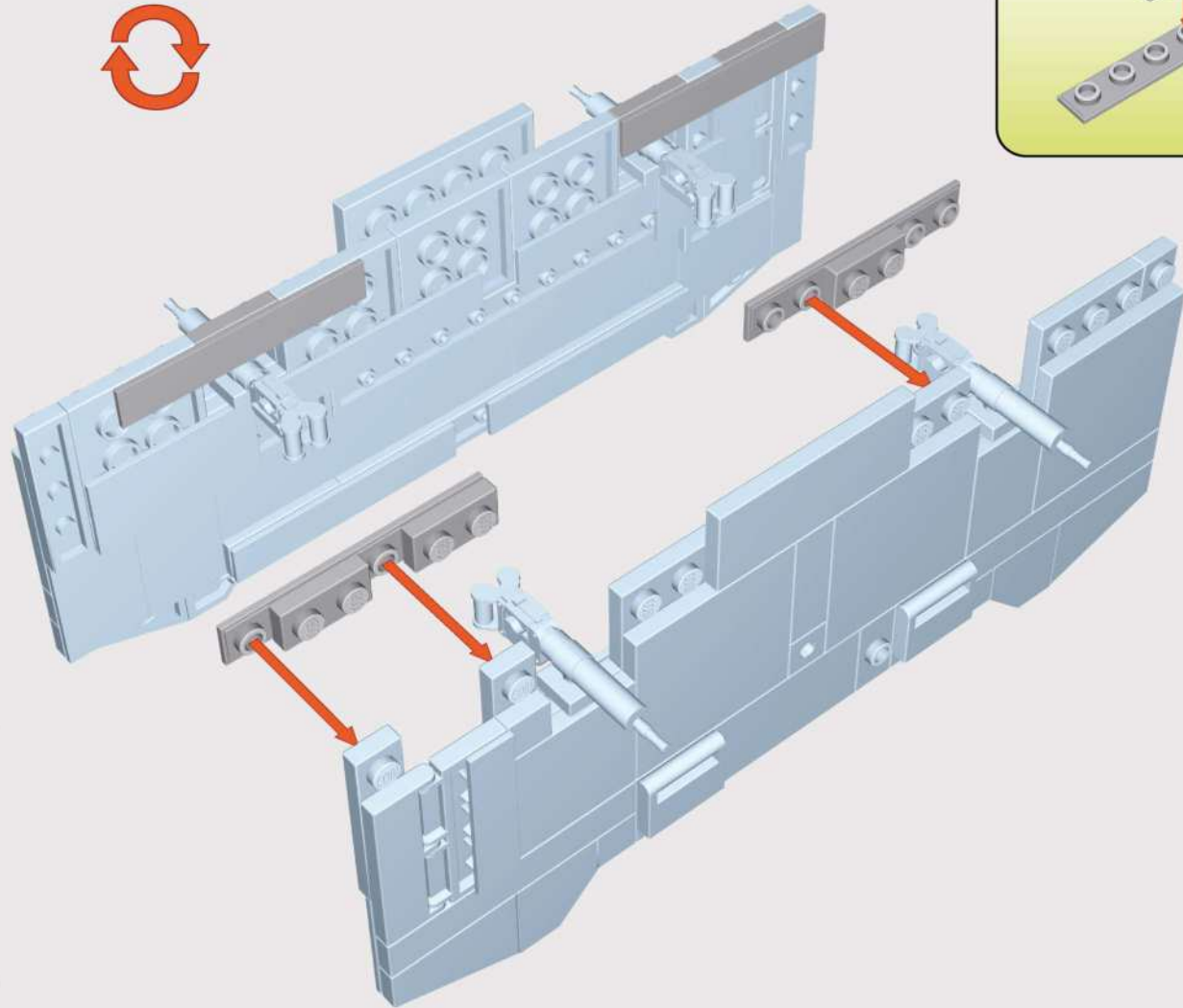
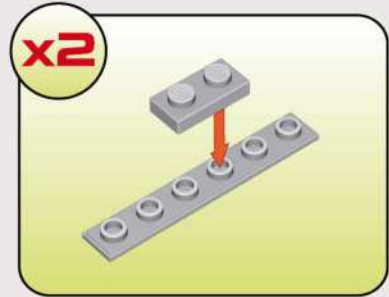



107

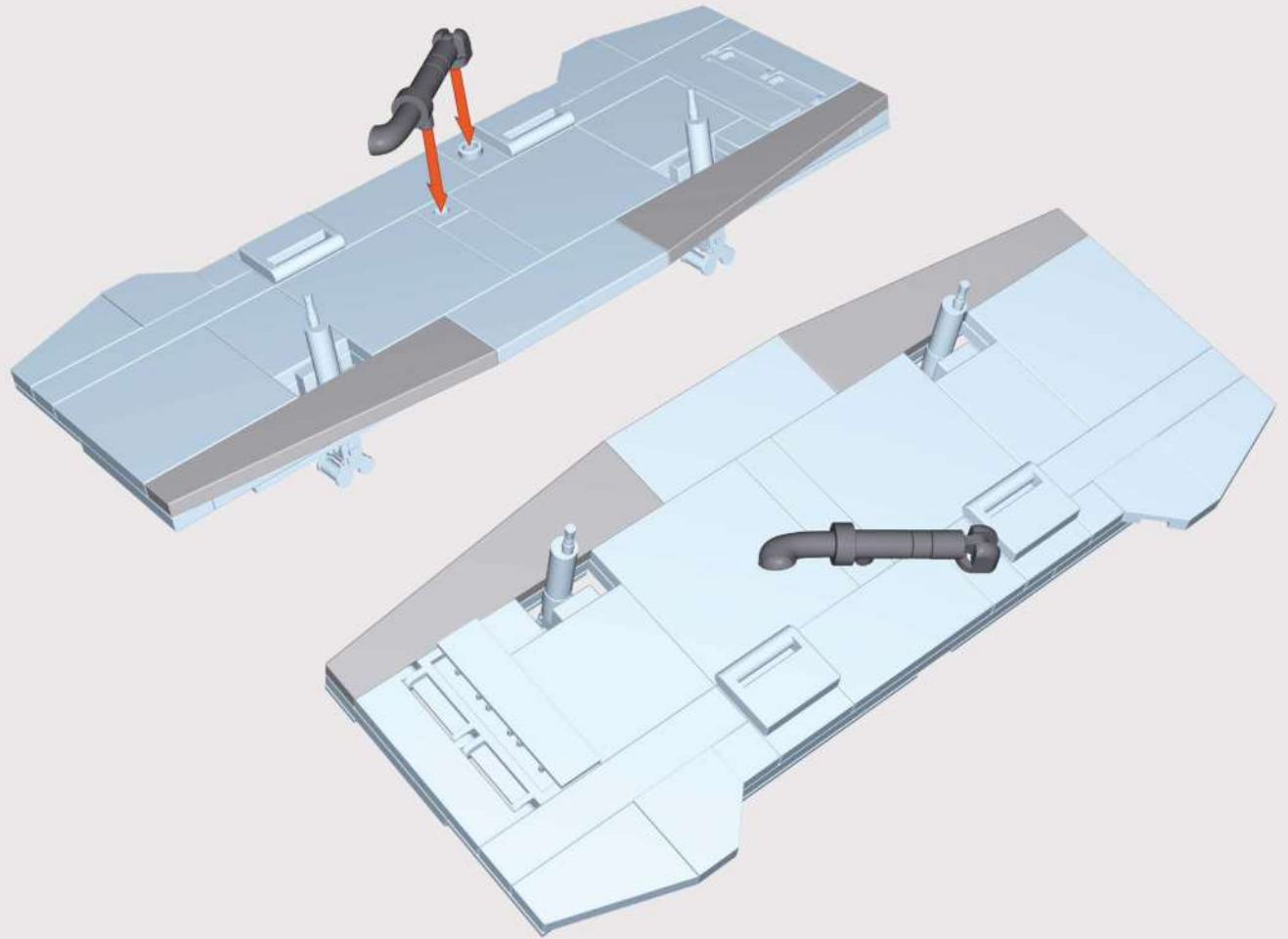
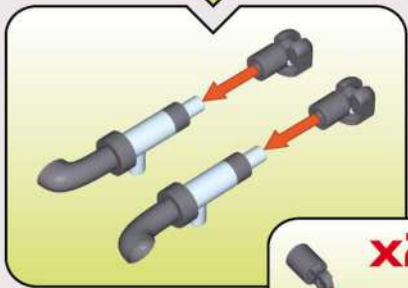
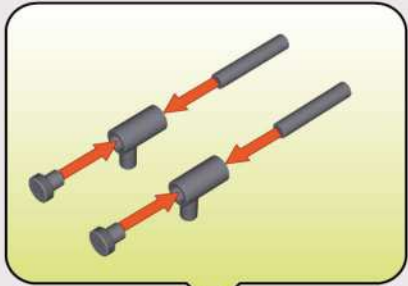

1:1

x2

x2

x2

x2

x2

x2

x2

x2

x2

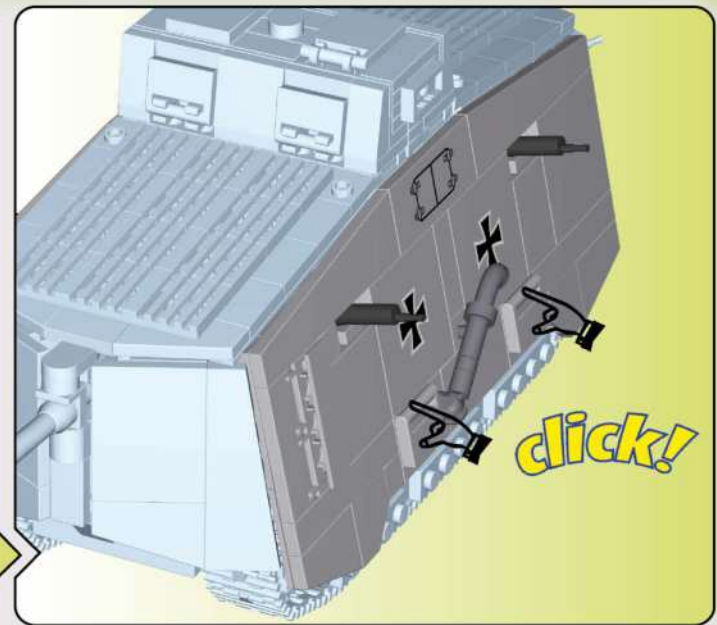
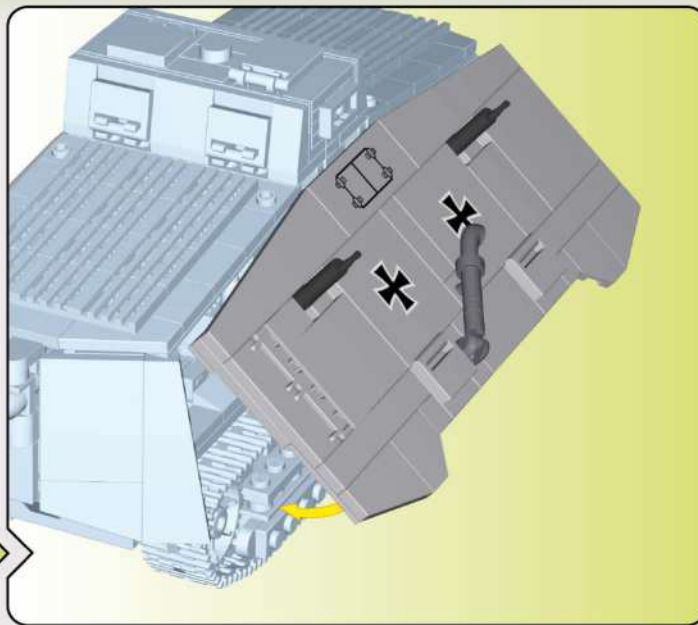
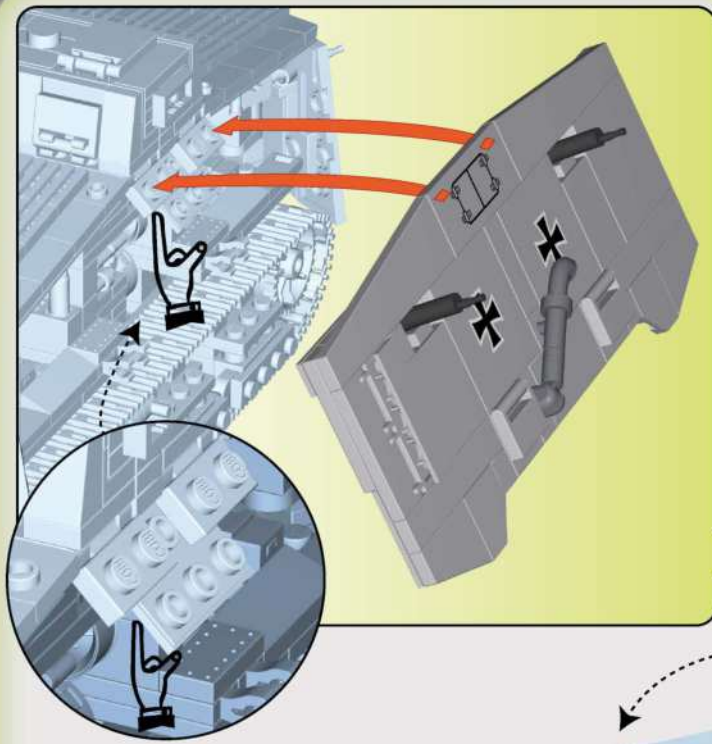

108

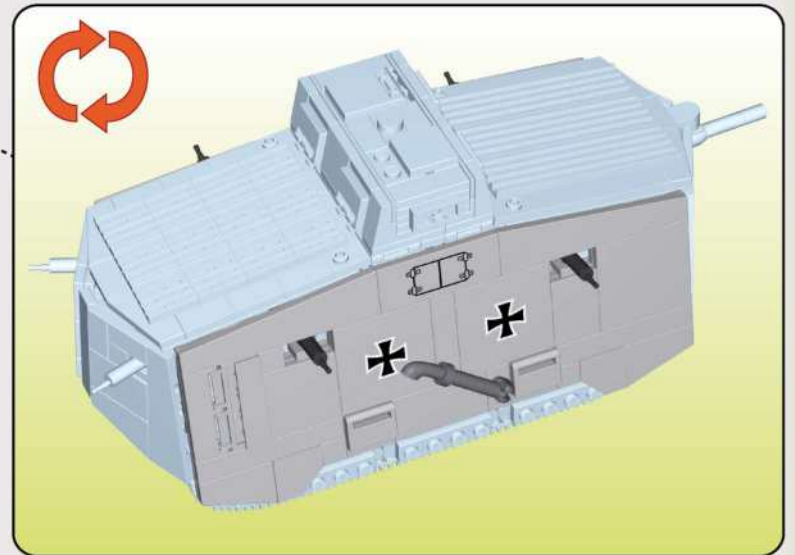
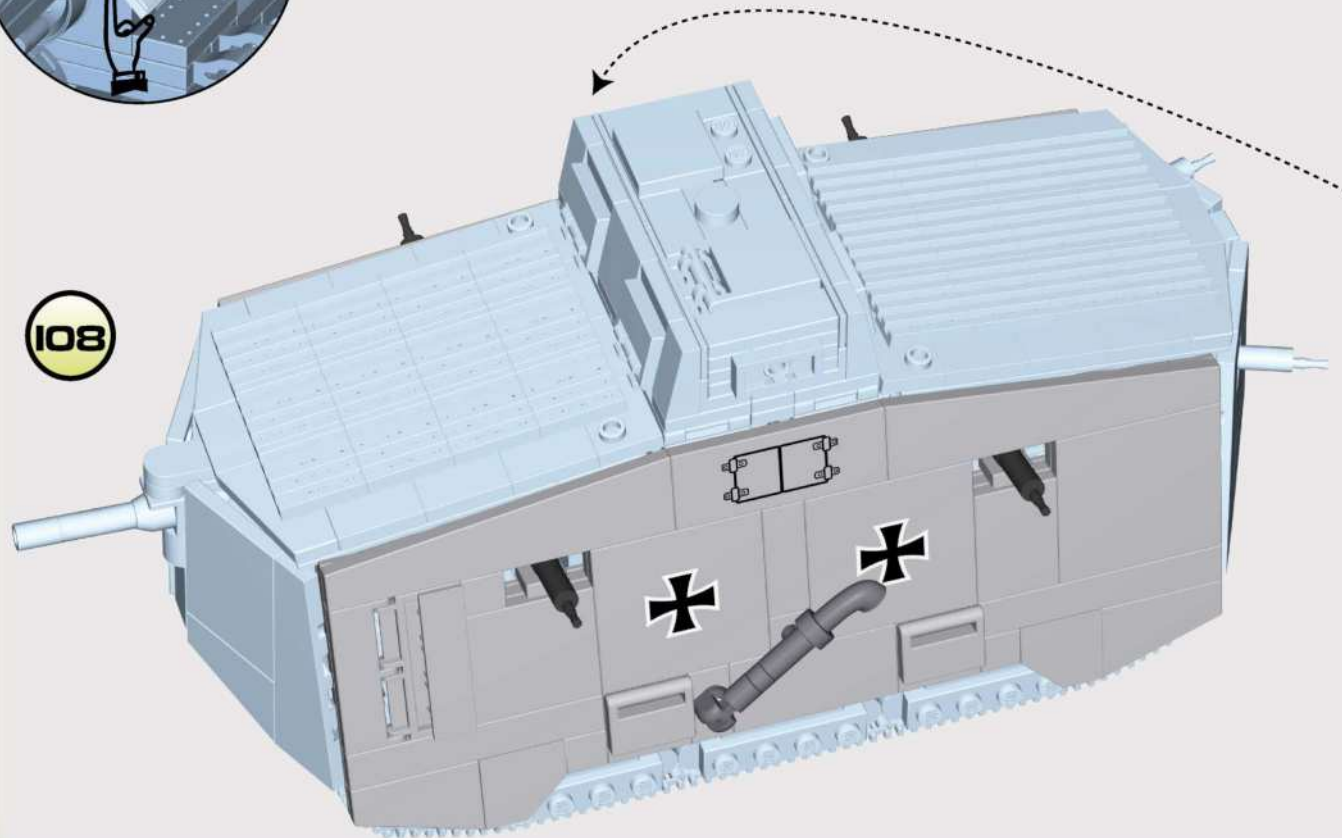

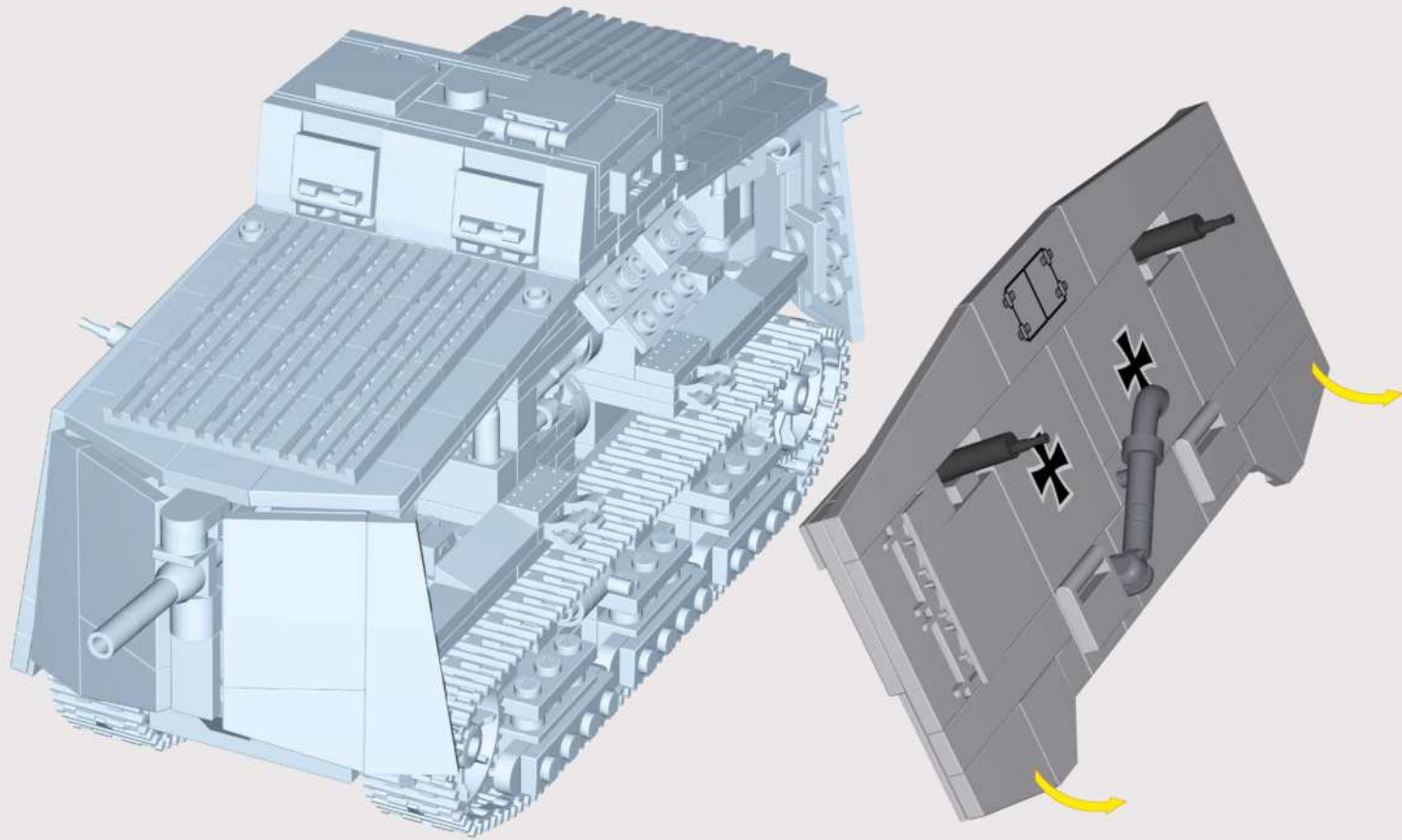

110

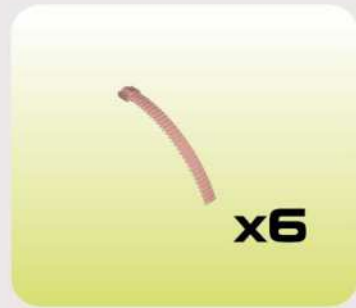
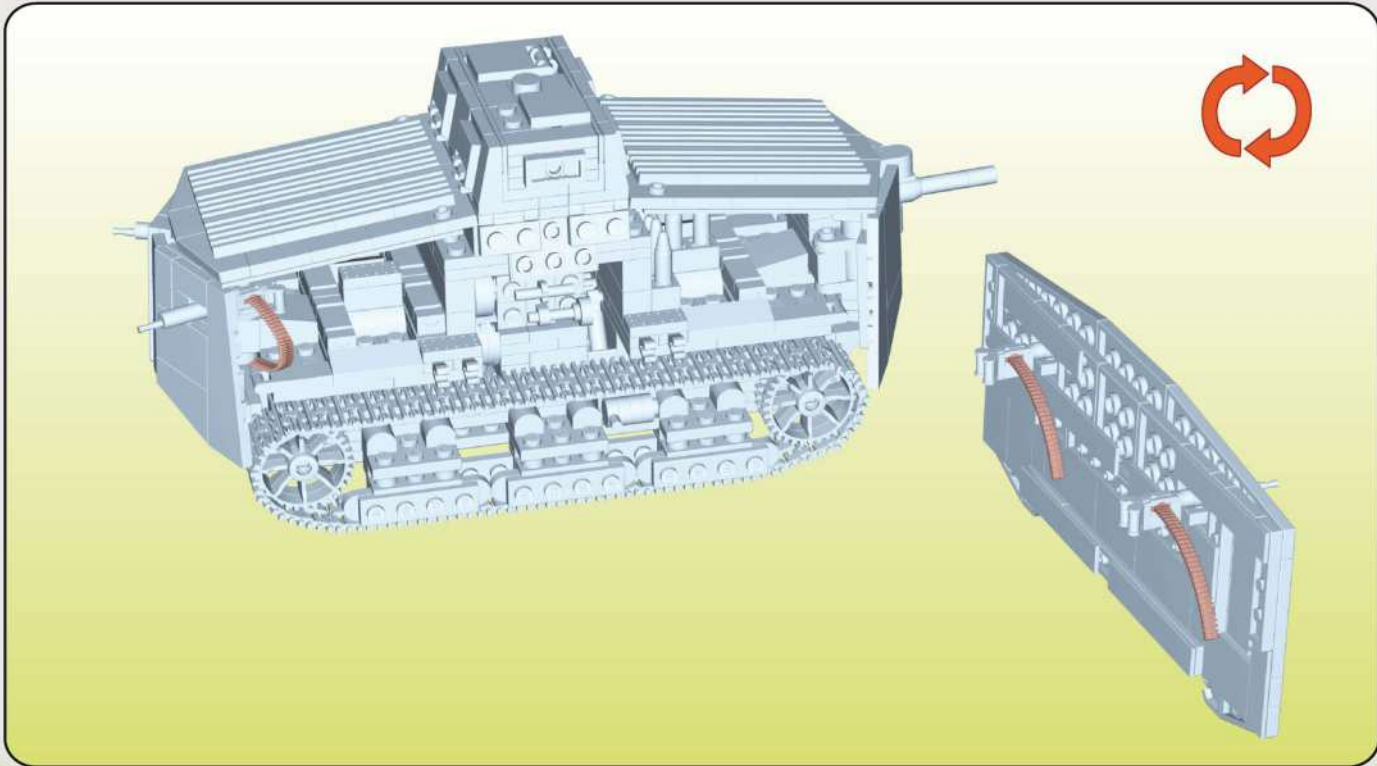
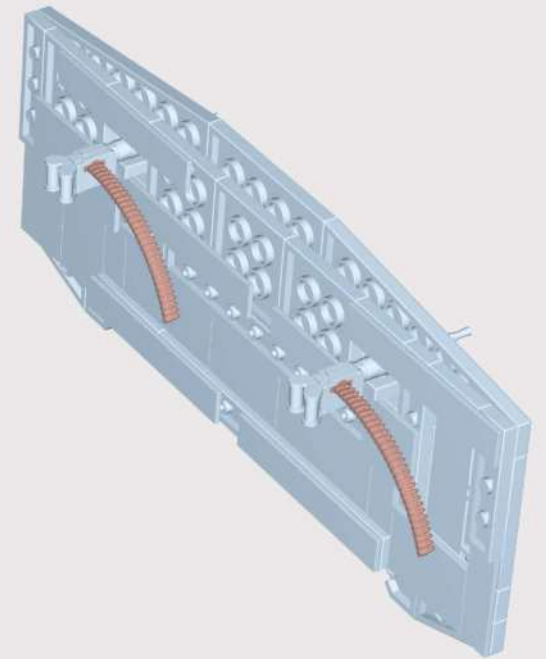
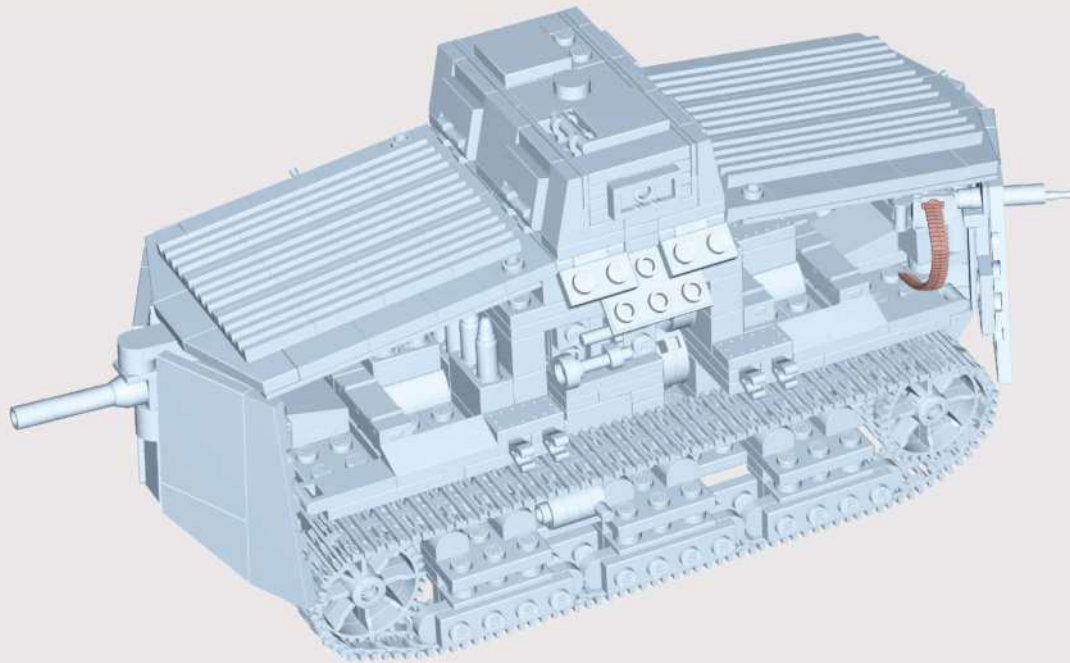

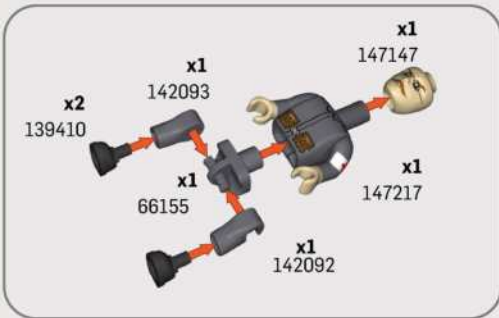
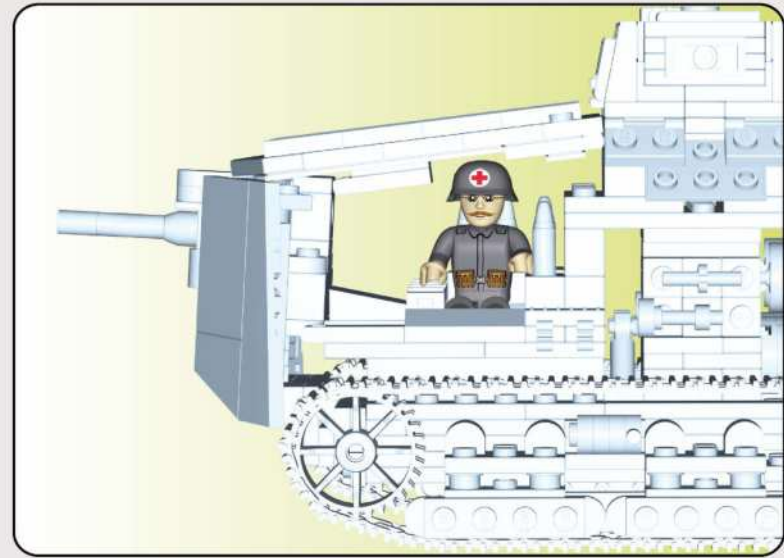
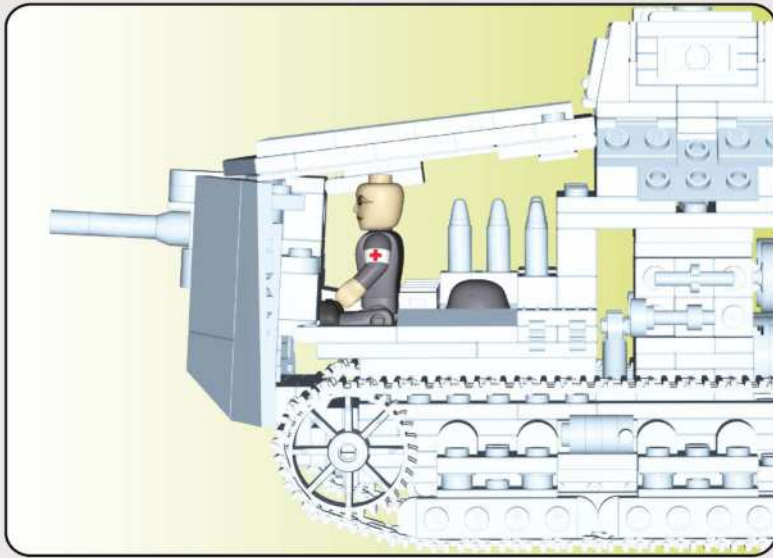

- |            |            |           |           |           |           |            |           |            |           |           |            |
|------------|------------|-----------|-----------|-----------|-----------|------------|-----------|------------|-----------|-----------|------------|
| x15 132141 | x4 132142  | x2 123925 | x15 43971 | x4 97241  | x6 43785  | x1 104128  | x8 135713 | x6 107100  |           |           |            |
| x2 147556  | x3 115864  | x2 147555 | x4 127156 | x3 124064 | x2 144521 | x8 43668   | x1 97309  | x2 145256  |           |           |            |
| x2 128240  | x2 128871  | x2 64571  | x2 97244  | x8 145257 | x2 45501  | x2 116501  | x2 110977 | x2 97658   |           |           |            |
| x13 112847 | x2 112793  | x10 44366 | x2 108584 | x1 51554  | x24 43671 | x2 97311   | x2 104897 | x6 43670   | x2 104562 | x1 113468 | x12 118461 |
| x1 115865  | x13 124066 | x13 45448 | x2 142898 | x4 145255 | x2 131780 | x14 131751 | x1 93074  | x2 98800   | x2 91750  | x7 43673  | x2 111106  |
| x6 105814  | x8 45502   | x2 83925  | x4 145306 | x4 145308 | x1 42892  | x1 43834   | x4 42902  | x2 53530   | x2 43669  | x4 82096  | x12 108368 |
| x1 67721   | x12 43674  | x8 74334  | x6 107314 | x4 93456  | x4 93965  | x6 147557  | x4 107862 | x12 43676  | x1 63852  | x2 131189 | x2 43675   |
| x1 147404  | x8 132147  | x3 64204  | x3 85379  | x2 51561  | x4 43679  | x4 83573   | x4 43678  | x16 132148 | x2 110412 | x1 43680  | x2 124036  |

Stumpfenwagen  
KVW

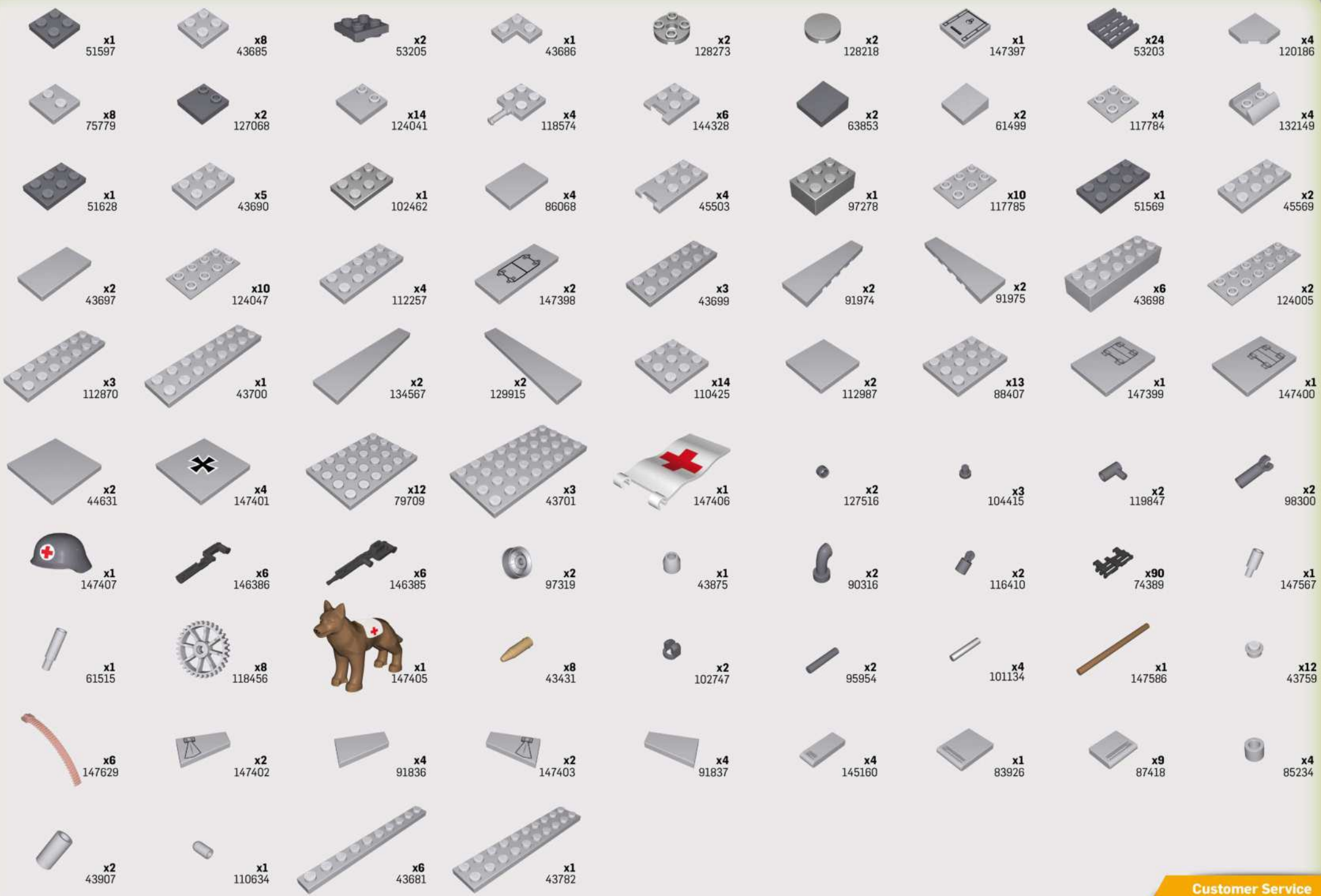



PzKpfw VI TIGER „131”  
SCALE 1:48  
+ 2710



SHERMAN M4A1  
SCALE 1:48  
★ 2715

# HISTORICAL COLLECTION



CHURCHILL MK. IV  
SCALE 1:48  
🇬🇧 2717



Sd.Kfz.10 DEMAG D7  
+ 2273



Sd.Kfz.7 HALF-TRACK  
+ 2275



M4A3E8 SHERMAN  
SCALE 1:48  
★ 2711



PzKpfw V PANTHER Ausf. G  
+ 2566



PzKpfw V PANTHER „PUDEL”  
🇵🇱 2568



# HISTORICAL COLLECTION



MARK V (Male)  
🇬🇧 2984



SOLDIERS OF THE GREAT WAR  
🇬🇧 🇫🇷 🇩🇪 2051



SOPWITH CAMEL F.1  
🇬🇧 2987



FOKKER DR.1 "RED BARON"  
✠ 2986



ROLLS ROYCE ARMOURD CAR  
🇬🇧 2988

For news and special deals

WWW.COBI.EU

03-02989-826

Find us on:  
f cobr.bricks  
cobi.klocki  
COBI SA