

HISTORICAL COLLECTION

GREAT WAR

Musée des
BLINDÉS
Saumur



RENAULT FT

IN FRENCH SERVICE - 1918-1940
PLACE OF ORIGIN - FRANCE
TYPE - LIGHT TANK
WEIGHT - 6,7t (14770Lb)
ARMOUR - 8-22mm (0.31"-0.87")
ARMAMENT - PUTEAUX SA 18 37mm (1.45")
ENGINE - RENAULT 4.5L, 39HP
SPEED - 7,8km/h (4.84MPH)
RANGE - 35km (22mi)



2991

PAD PRINTED
NO STICKERS

Printed in EU



UK
CA



304  1 

RENAULT FT

SCALE 1:35

1

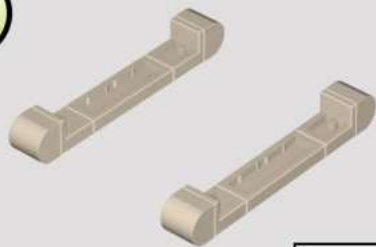

1:1



2

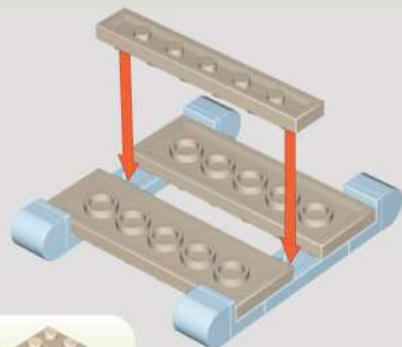

3

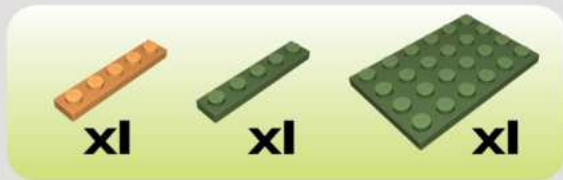
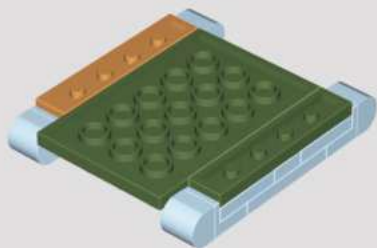

4

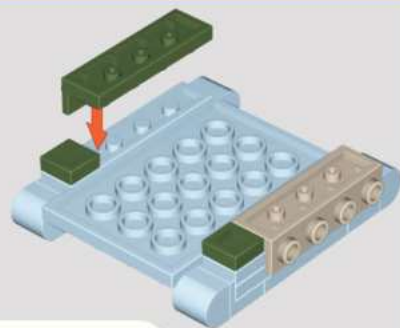

5

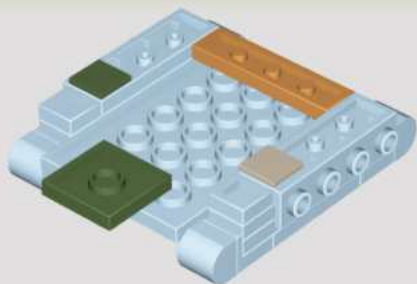

x1



x1



x1



x1

6

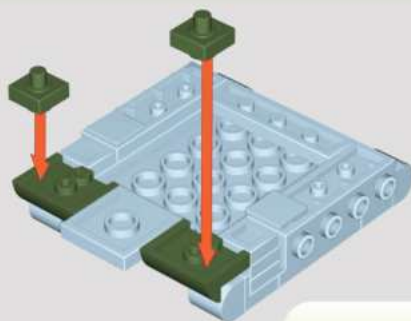

x2



x2



x2



x2

7



x1



x1



x1



x1

8

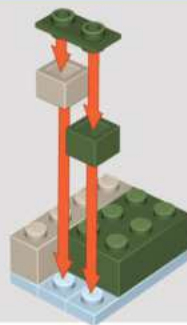

x1



x1



x1



x1



x1

9

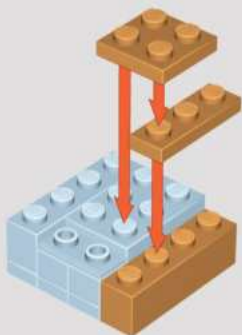

10

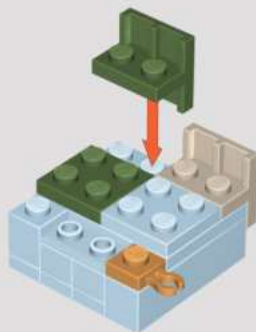

11

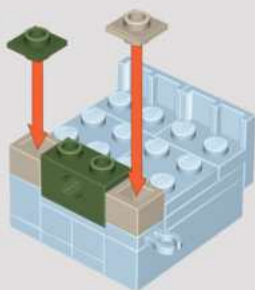

12

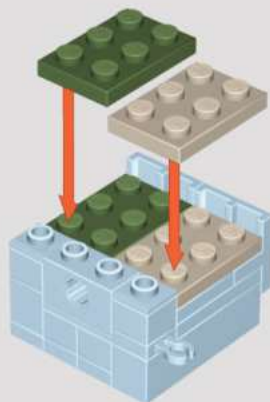

13

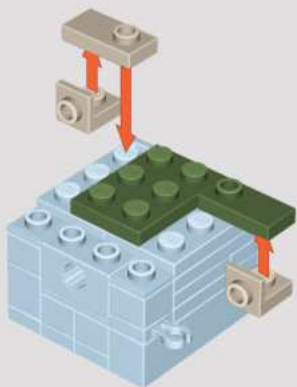

-  x1
-  x1
-  x1
-  x2



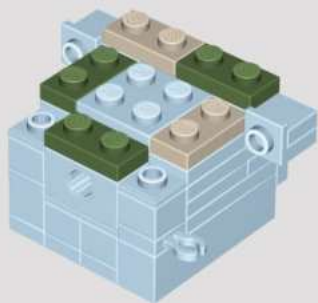

14

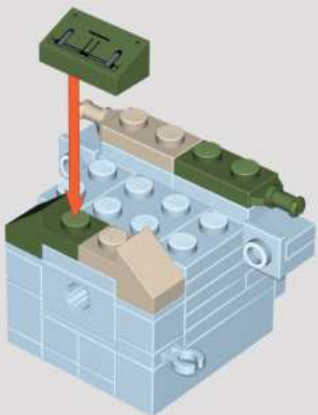

-  x3
-  x2

15



-  x1
-  x1
-  x1
-  x1
-  x1

16

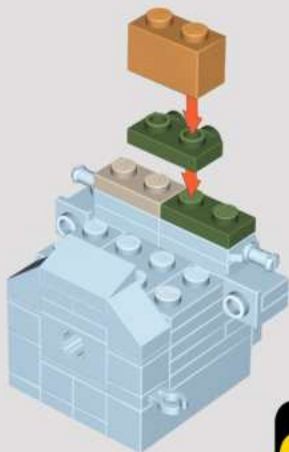

-  xl
-  xl
-  xl
-  xl

BE CAREFUL - NOTICE THE DIFFERENCE



17

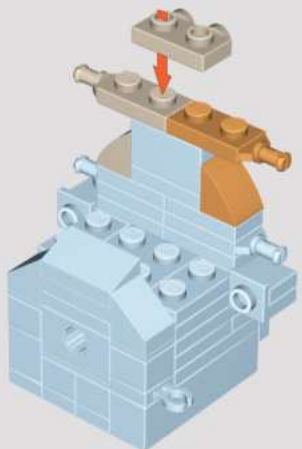

-  xl
-  xl
-  xl
-  xl
-  xl

18

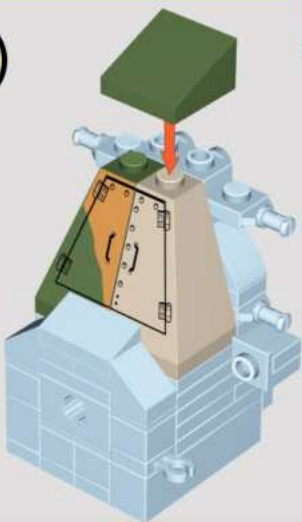

-  xl
-  xl
-  xl

19

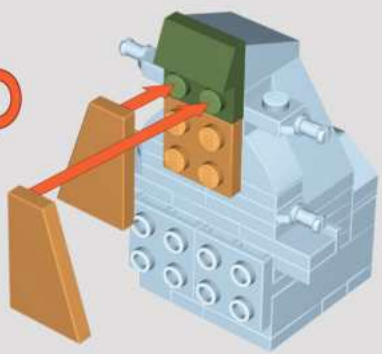

-  xl
-  xl
-  xl
-  xl

20

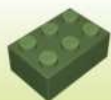
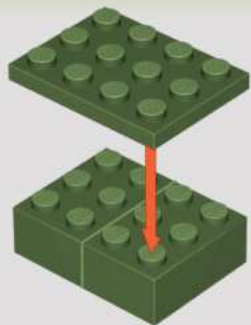

x2



x1

21

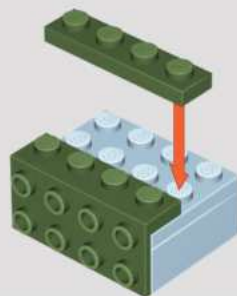

x1



x1

22

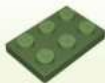
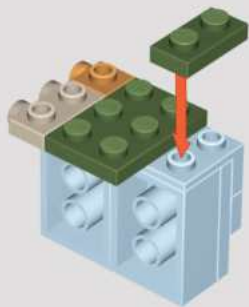

x1



x1



x1



x1

23

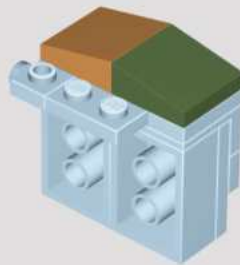

x1



x1

24

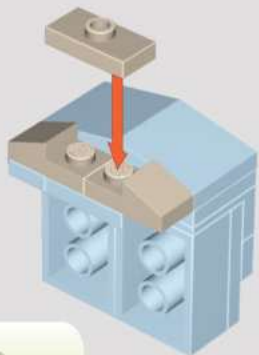

x2



x1

25

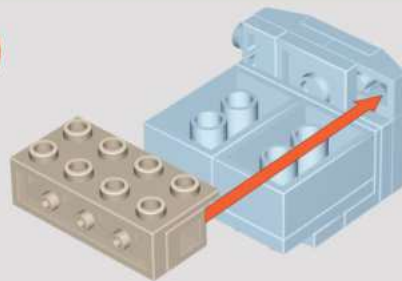
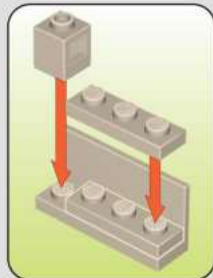

x1



x2



x1

26

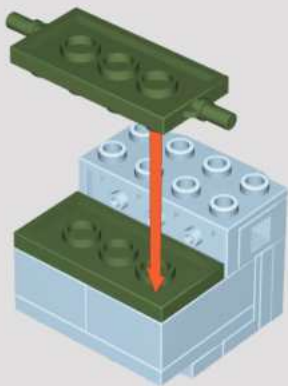

x1



x1

27

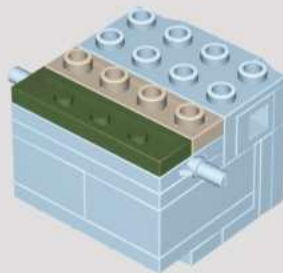

x1



x1

28



29

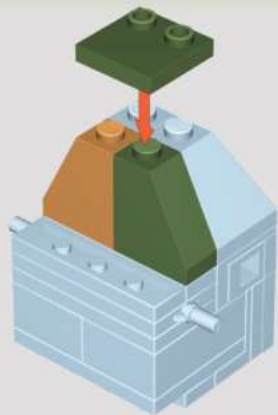



x1 **x1**







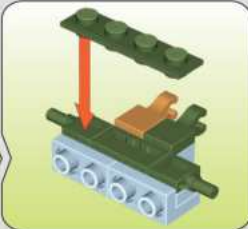
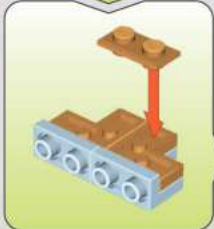
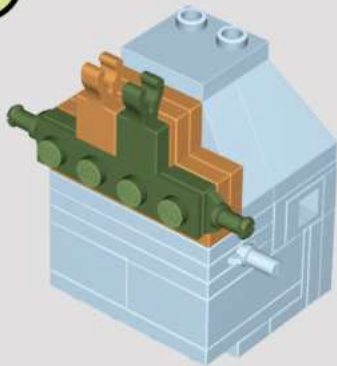





x1 **x1** **x1**

30



1:1

		
x2	x1	x2
		
x1	x2	x1
		
x1	x1	x1

31

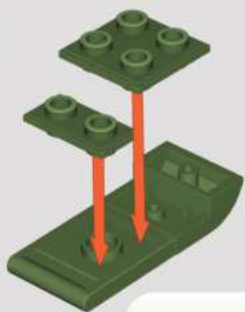

x1



x1



x1



x1

32

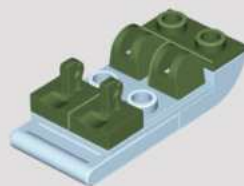

x2



x1



x2

33



x2



x2



x2



x2

34



x4



x26

x13

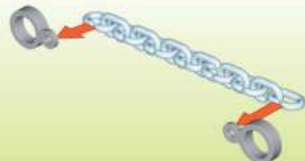

x2

35

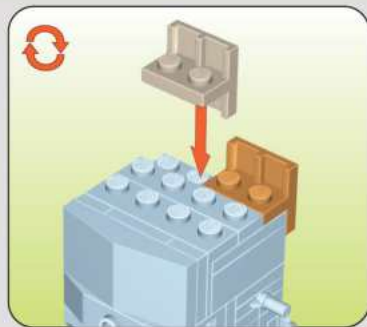
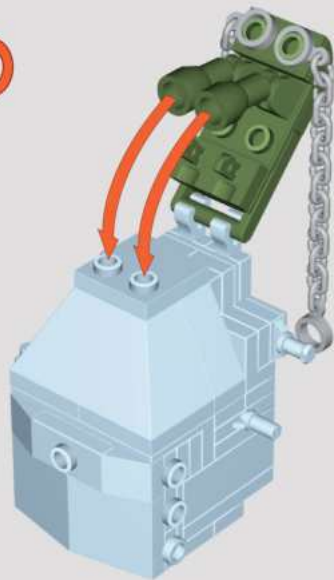

36

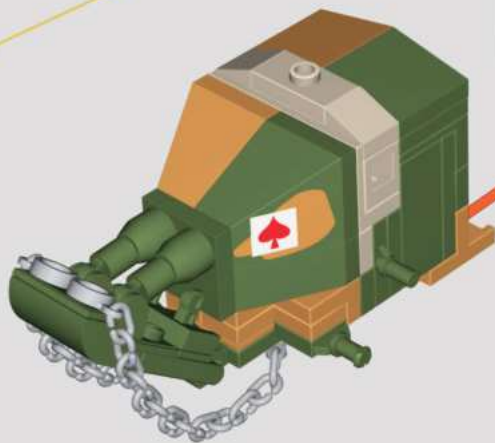

x1



x1

37

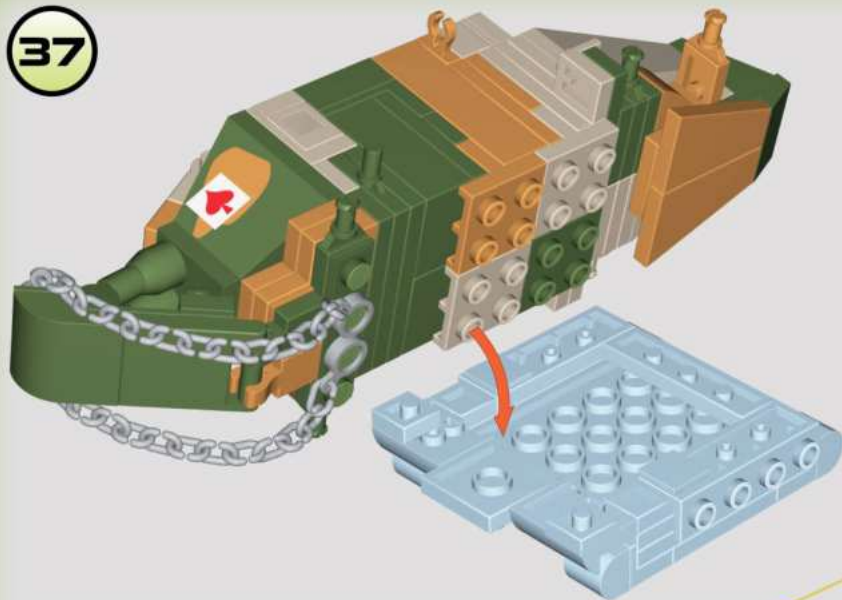

38

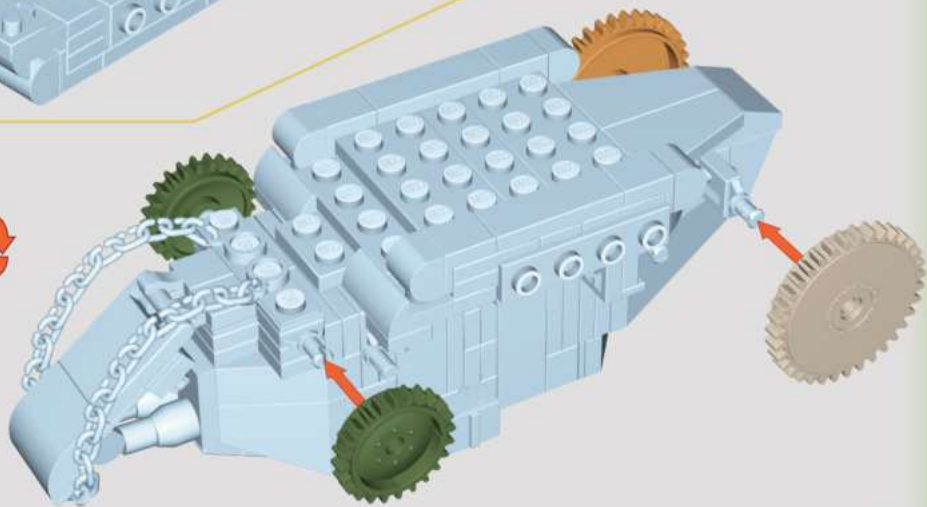

x1



x1



x2

39

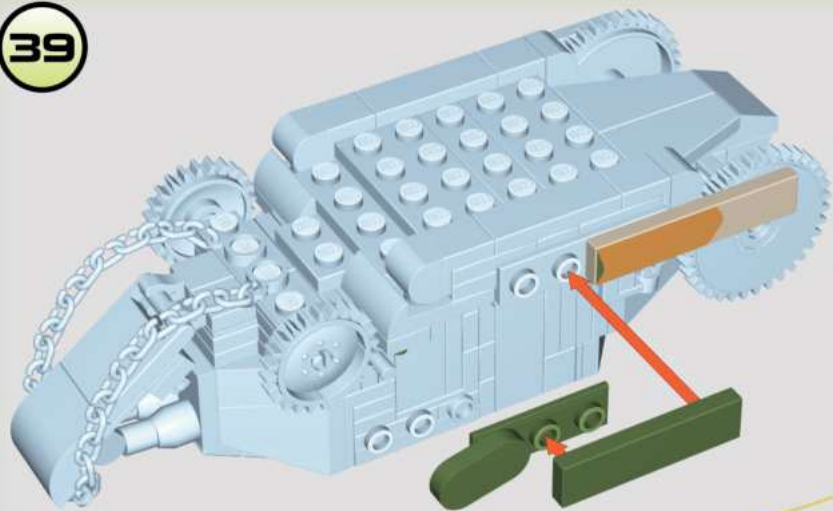

x1



x1



x1



x1

1:1

40



1:1

1:1



x1



x1



x1



x1

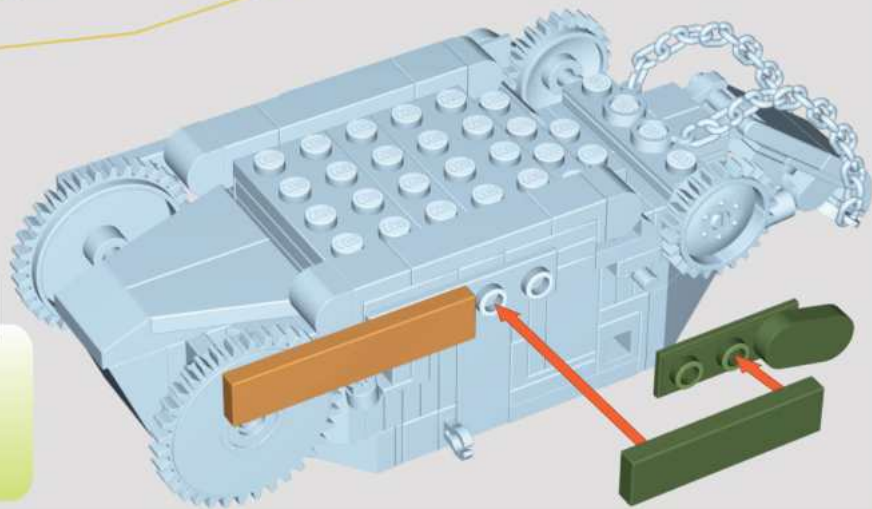

41

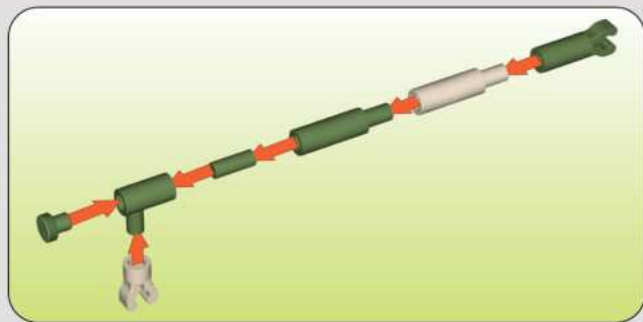
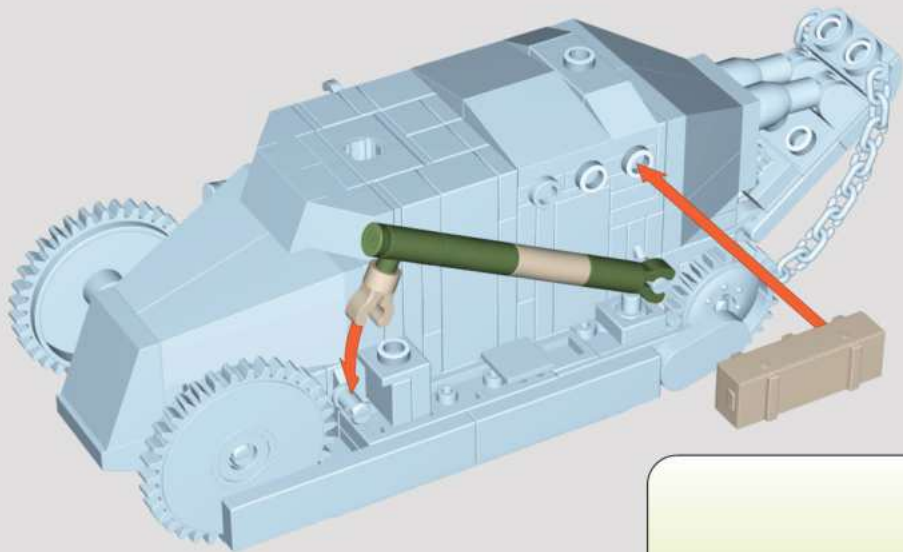

x1



x1



x1



x1



x1



x1



x1



x1

42

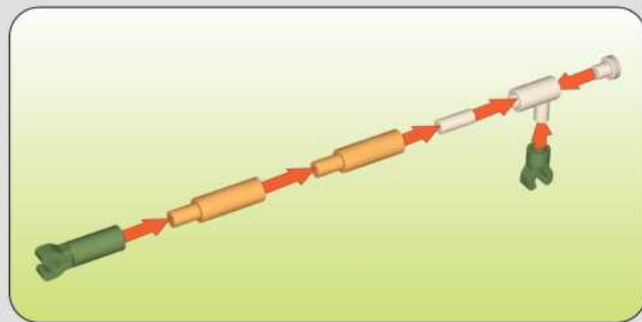
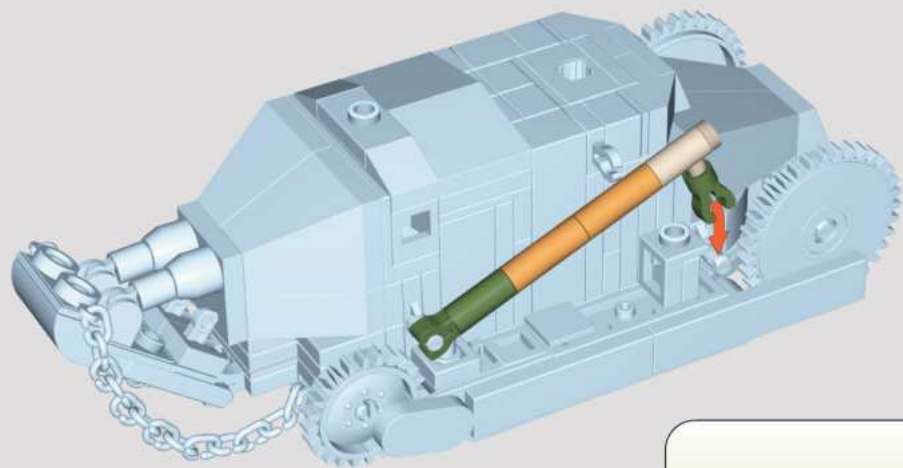

x1



x2



x1



x1



x1



x1

43

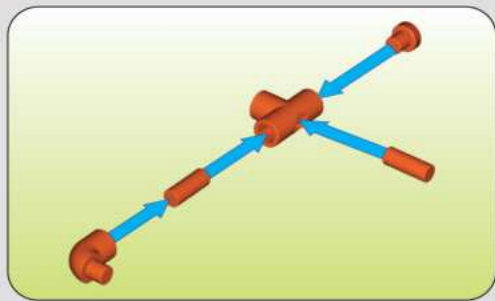
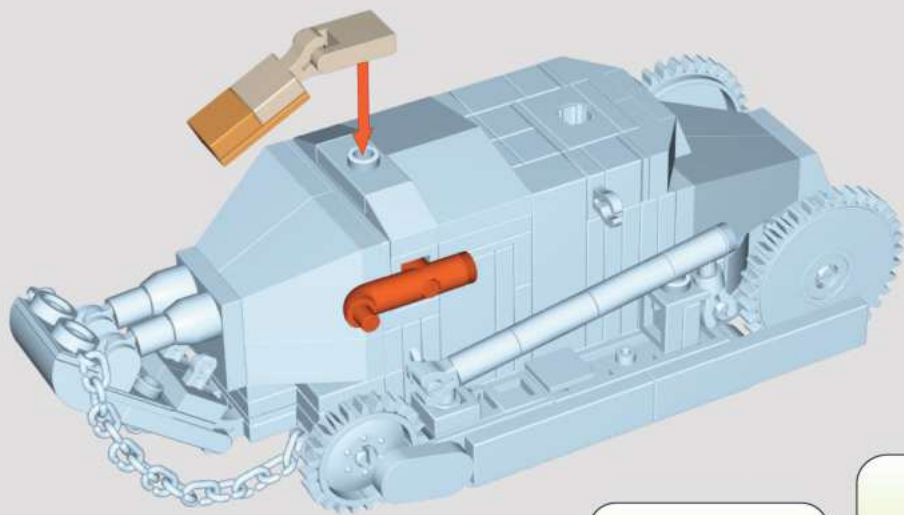

x1



x1



x1



x1



x1



x2



x1



x1

44

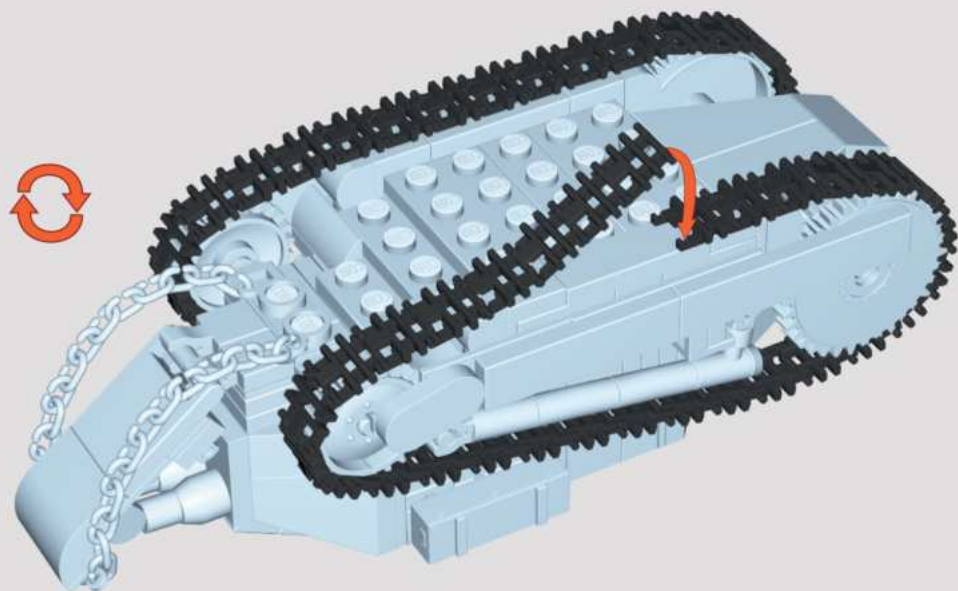

x30



x2



x60

45



x2



x1

46

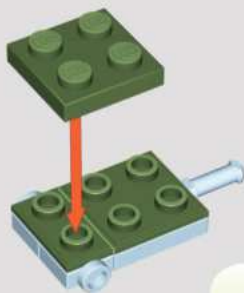

x1



x1



x1

47

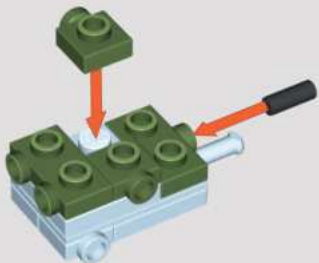

x1



x2



x1



x1

48

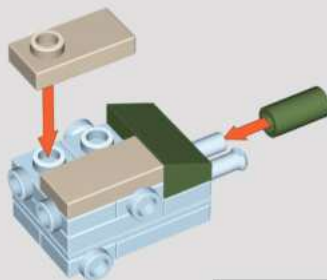

1:1



x1



x1



x1



x1

49

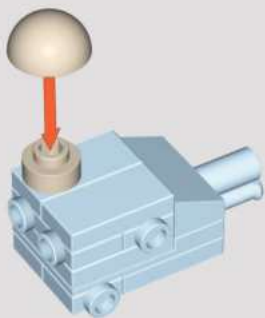

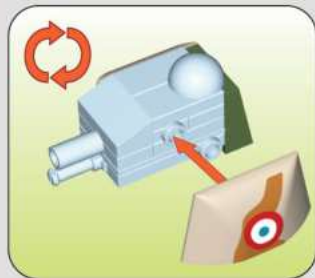
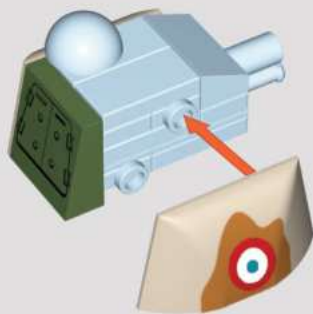

50

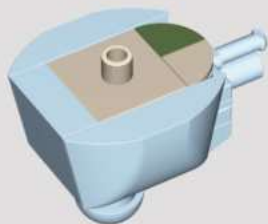

51

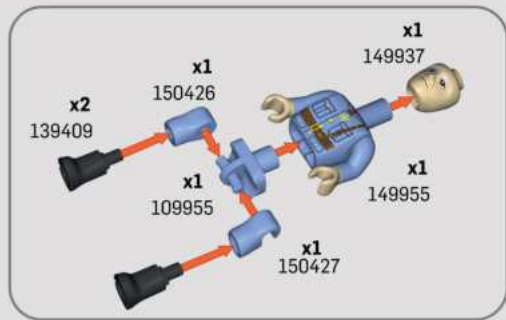
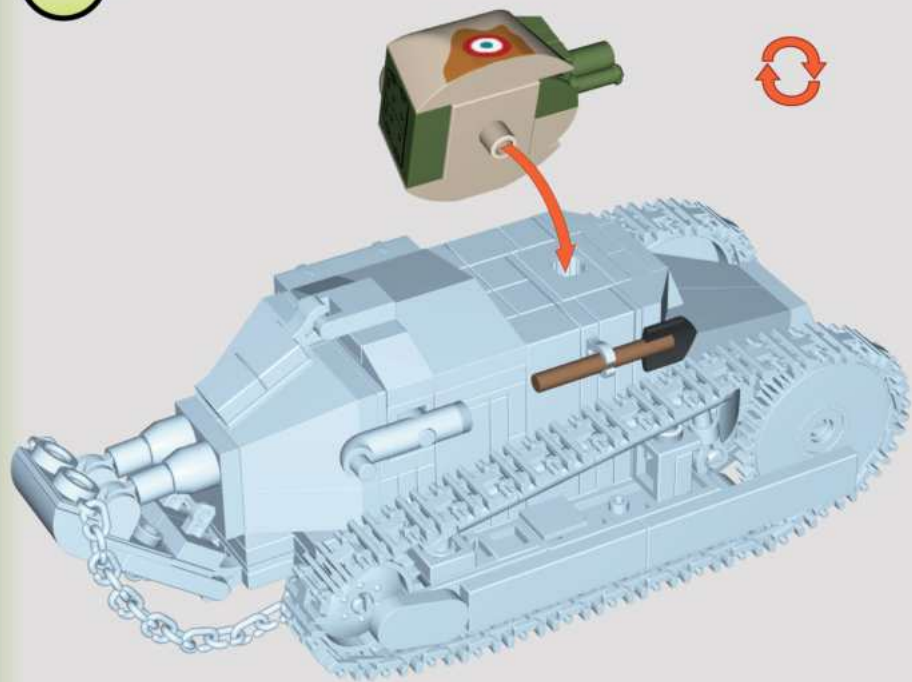



- | | | |
|---|---|---|
| 
x2
109389 | 
x1
82761 | 
x4
44014 |
| 
x1
143737 | 
x1
143520 | 
x2
84688 |
| 
x1
150475 | 
x1
135731 | 
x1
132985 |
| 
x4
143568 | 
x2
123484 | 
x1
127736 |







HISTORICAL COLLECTION



Sturmpanzerwagen
A7V

STURMPANZERWAGEN A7V



2989



MARK V (Male)



2984



FOKKER DR.1 "RED BARON"



2986



SOPWITH CAMEL F.1



2987





RENAULT FT "VICTORY TANK 1920"

🇵🇱 🇫🇷 2992

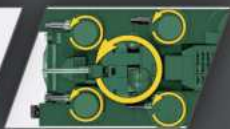

 **WARNING: CHOKING HAZARD-**
Toy contains small parts.
Not for children under 3 years.



ROLLS ROYCE ARMoured CAR

🇬🇧 2988



VICKERS A1E1 INDEPENDENT

🇬🇧 2990



HISTORICAL COLLECTION

WWW.COBI.EU

00-02991-293

For
news and
special deals

Find us on:
  [cobi.bricks](https://www.facebook.com/cobi.bricks)
[cobi.bricks](https://www.instagram.com/cobi.bricks)
 [COBI SA](https://www.youtube.com/cobi.bricks)