

# HISTORICAL COLLECTION GREAT WAR



MUZEM  
WOJSKA  
POLSKIEGO



## RENAULT FT

IN POLISH SERVICE - 1919-1939  
PLACE OF ORIGIN - FRANCE  
TYPE - LIGHT TANK  
WEIGHT - 6,7t (14770Lb)  
ARMOUR - 8-22mm (0.31"-0.87")  
ARMAMENT - PUTEAUX SA 18 37mm (1.45")  
ENGINE - RENAULT 4.5L, 39HP  
SPEED - 7,8KM/H (4.84MPH)  
RANGE - 35KM (22MI)  
CREW - 2



2992

PAD PRINTED  
NO STICKERS

Printed in EU



304  1 

RENAULT FT "VICTORY TANK 1920"

SCALE 1:35

1

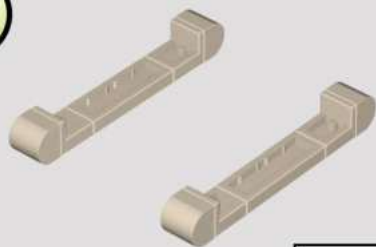

1:1



2

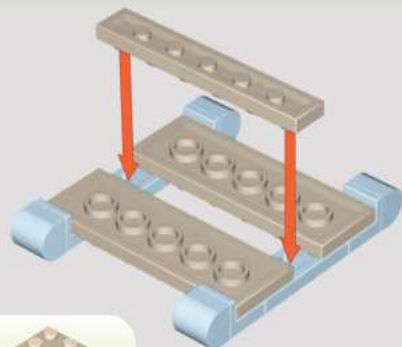

3

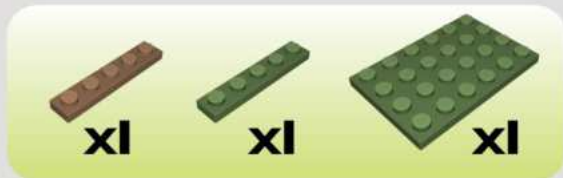
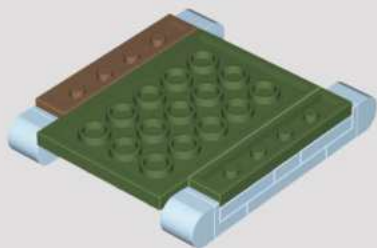

4

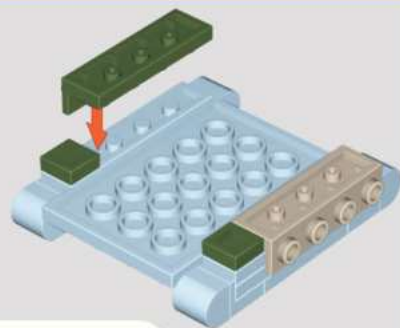

5

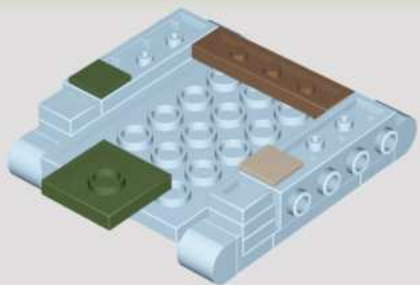

x1



x1



x1



x1

6

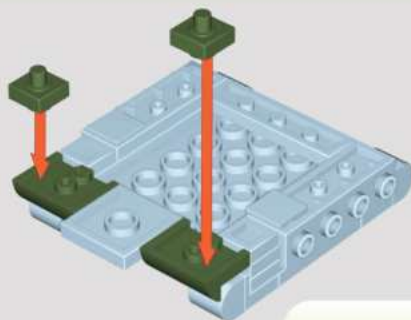

x2



x2



x2



x2

7



x1



x1



x1



x1

8

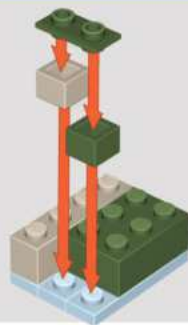

x1



x1



x1



x1



x1

9

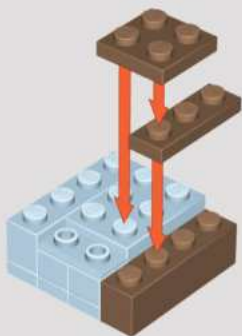

x1



x1



x1

10

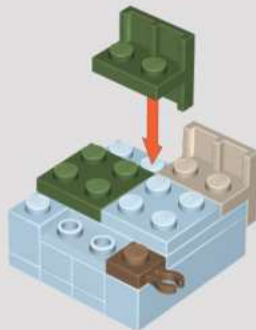

x1



x1



x1



x1

11

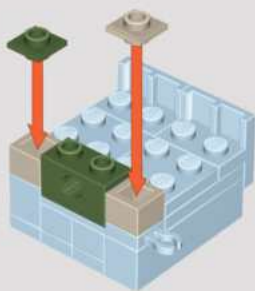

x2



x1



x1



x1

12

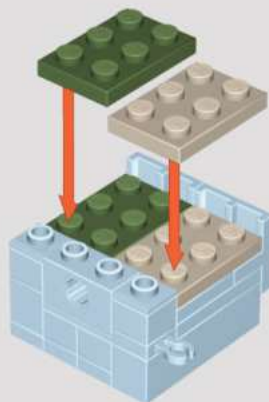

x2



x2

13

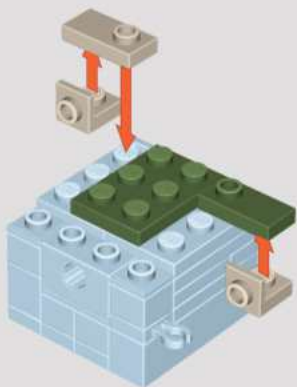

-  x1
-  x1
-  x1
-  x2



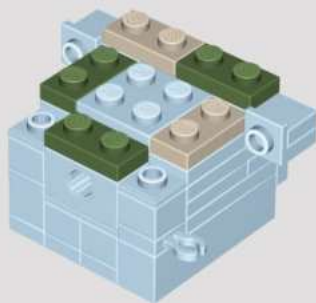

14

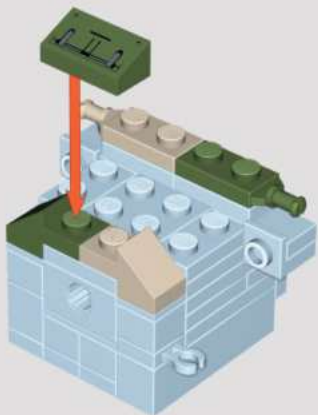

-  x3
-  x2

15



-  x1
-  x1
-  x1
-  x1
-  x1

16

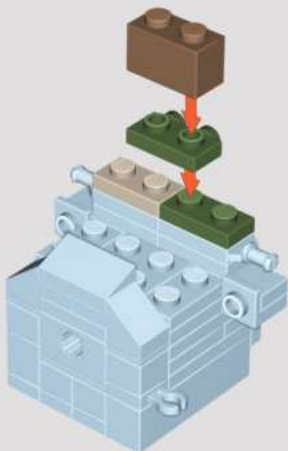

-  x1
-  x1
-  x1
-  x1

17

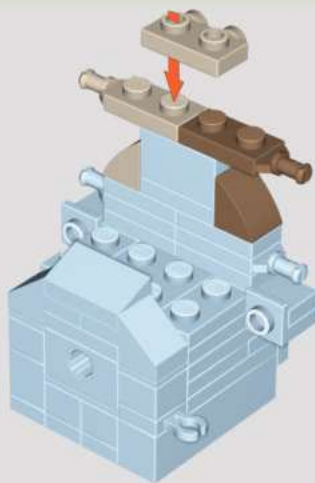

-  x1
-  x1
-  x1
-  x1
-  x1

18

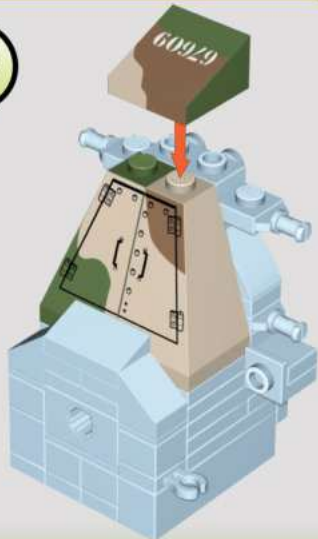

-  x1
-  x1
-  x1

19

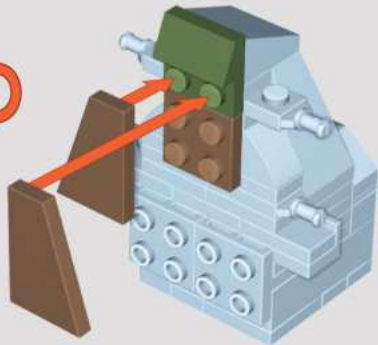

-  x1
-  x1
-  x1
-  x1

20

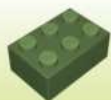
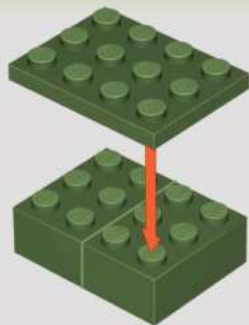

x2



x1

21

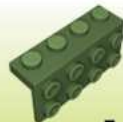
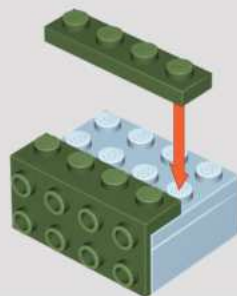

x1



x1

22

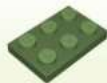
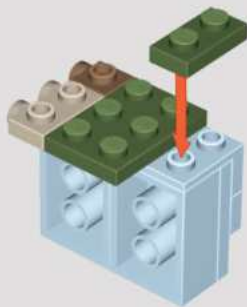

x1



x1



x1



x1

23

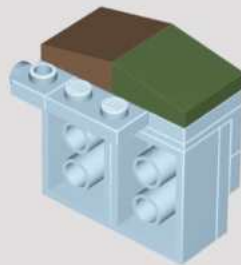

x1



x1

24

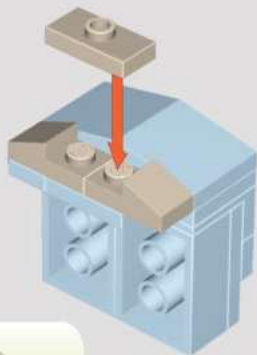

25

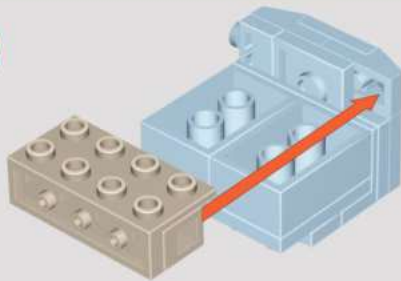
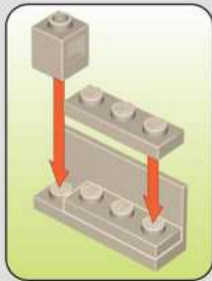

26

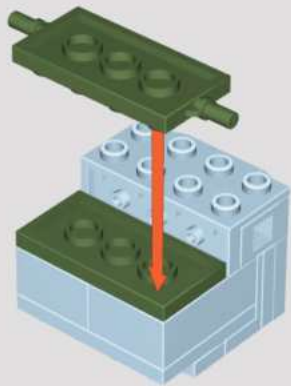

27

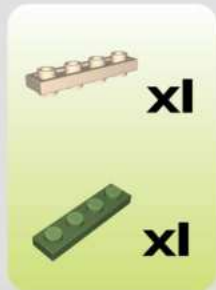
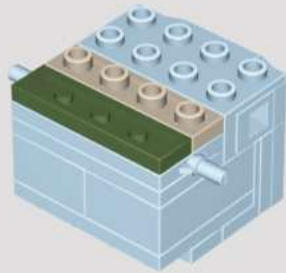



28



29

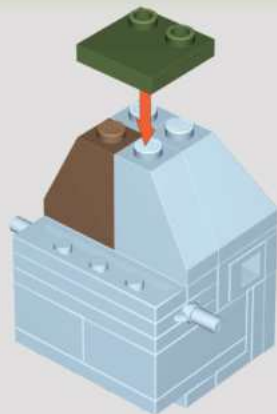

xi xi xi

xi xi

30

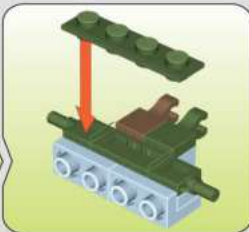
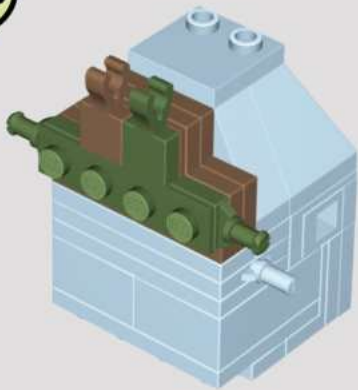

1:1

x2	xi	x2
xi	x2	xi
xi	xi	xi

31

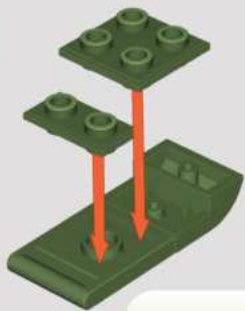

x1



x1



x1



x1

32

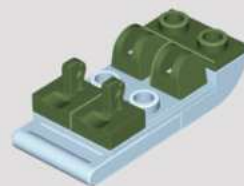

x2



x1



x2

33



x2



x2



x2



x2

34



x4



x26

x13



x2

35

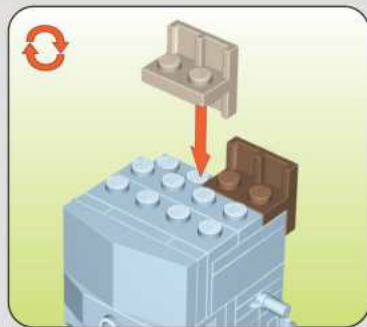
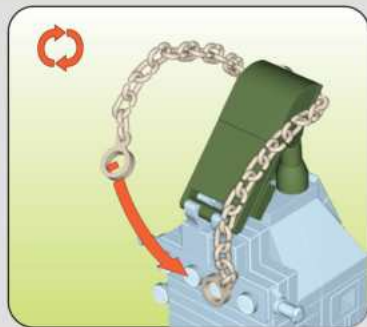
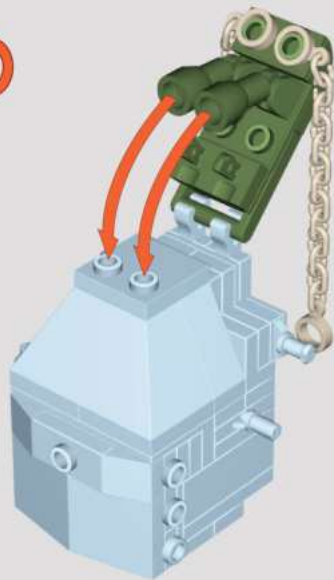

36

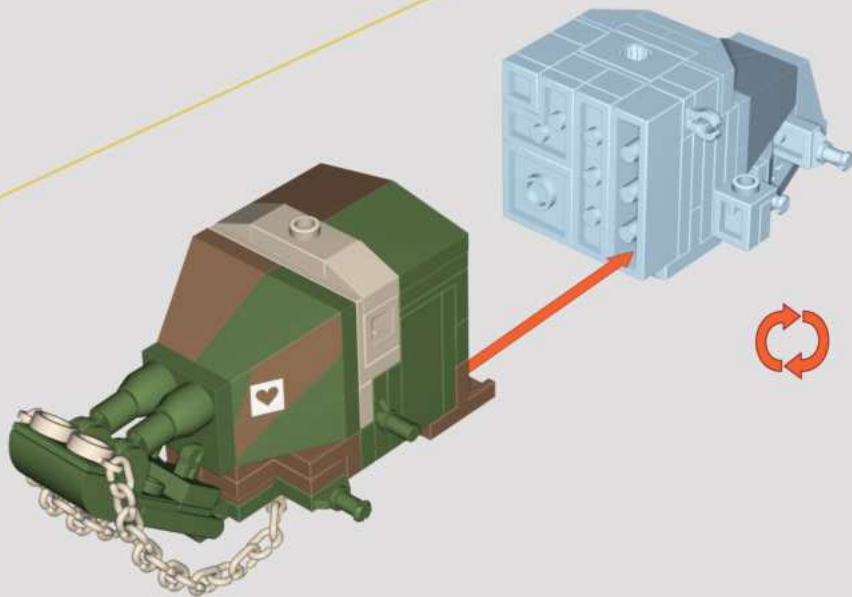

x1



x1

37

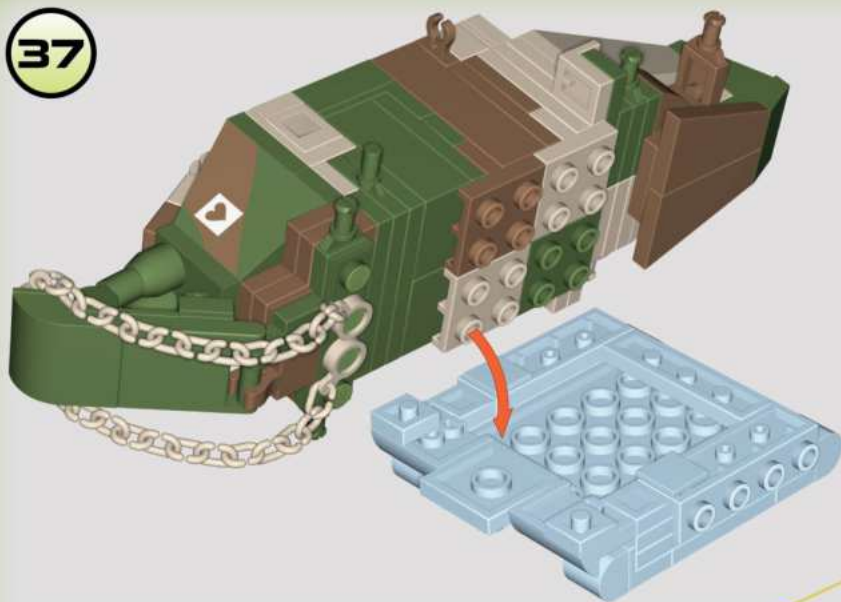

38

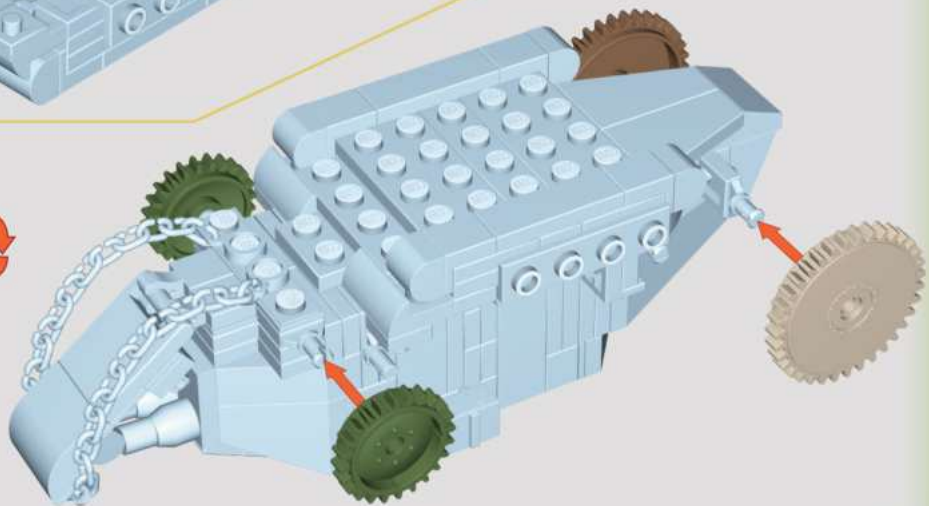
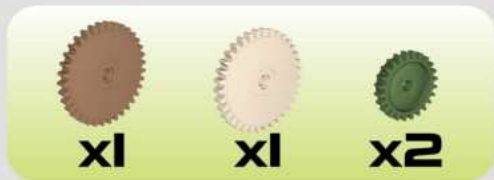

39

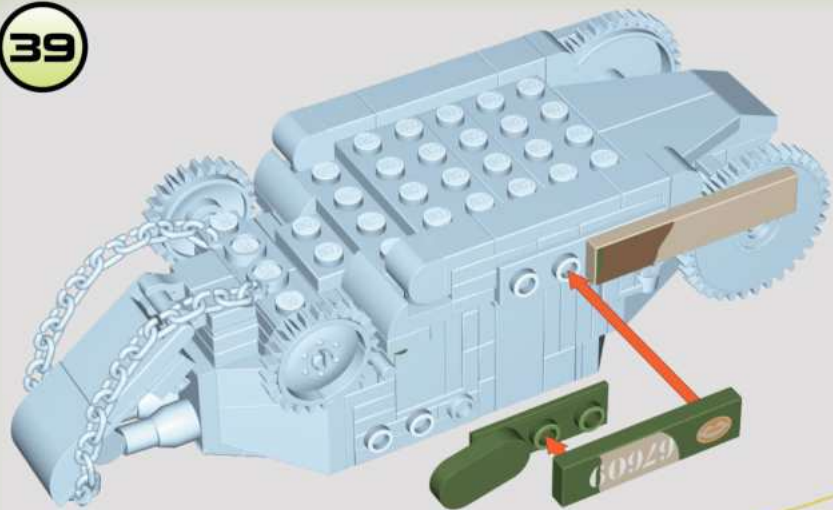

40

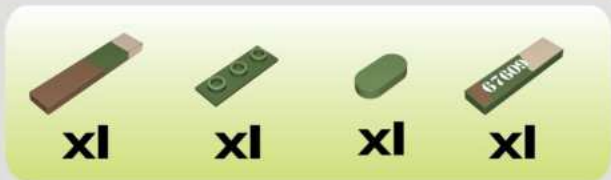
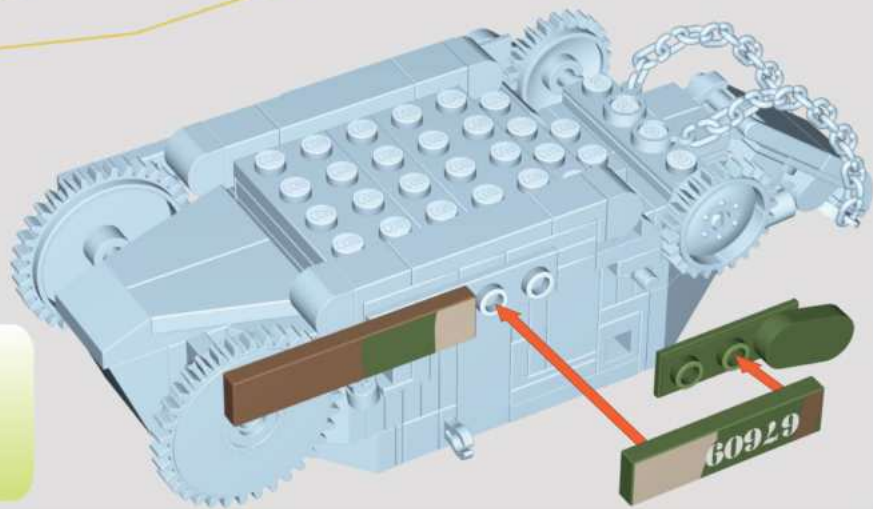

41

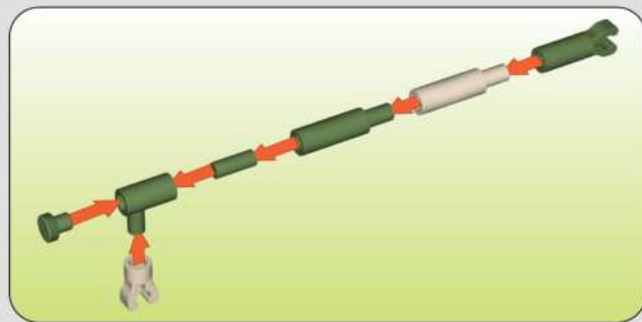
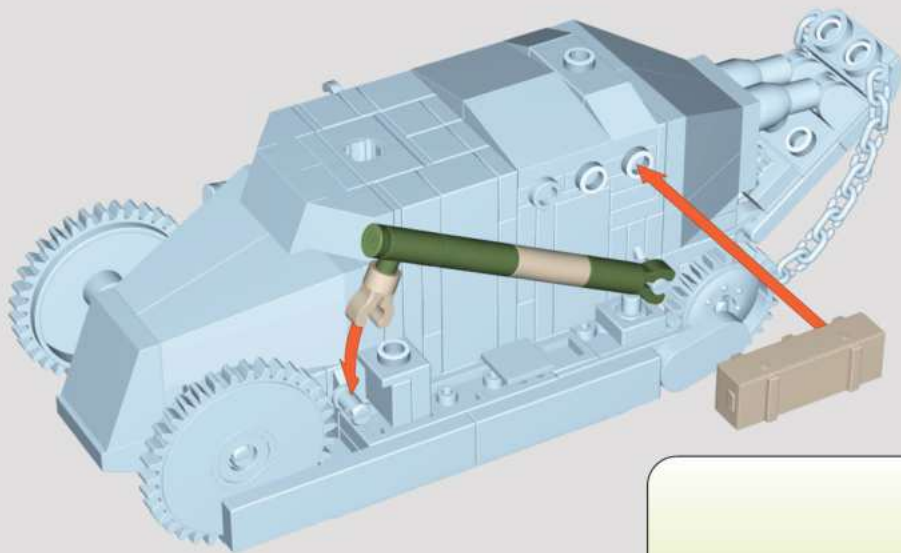

  
**x1**

  
**x1**

  
**x1**

  
**x1**

  
**x1**

  
**x1**

  
**x1**

  
**x1**

42

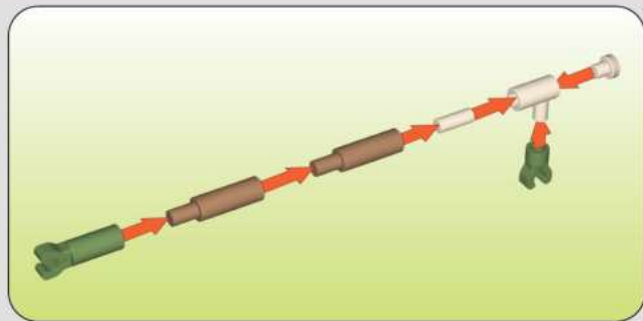
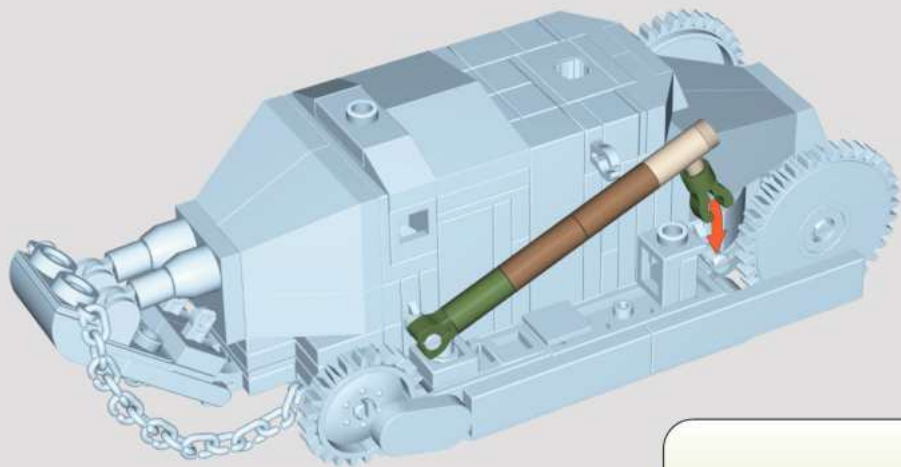

x1



x2



x1



x1



x1



x1

43

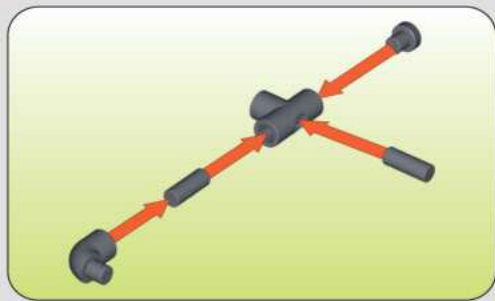
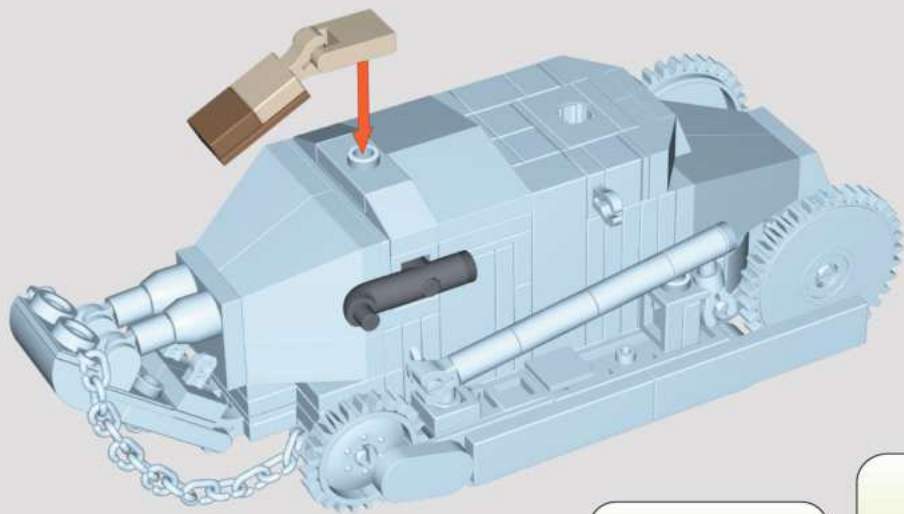

x1



x1



x1



x1



x1



x2



x1



x1



44

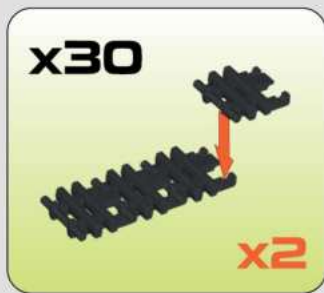
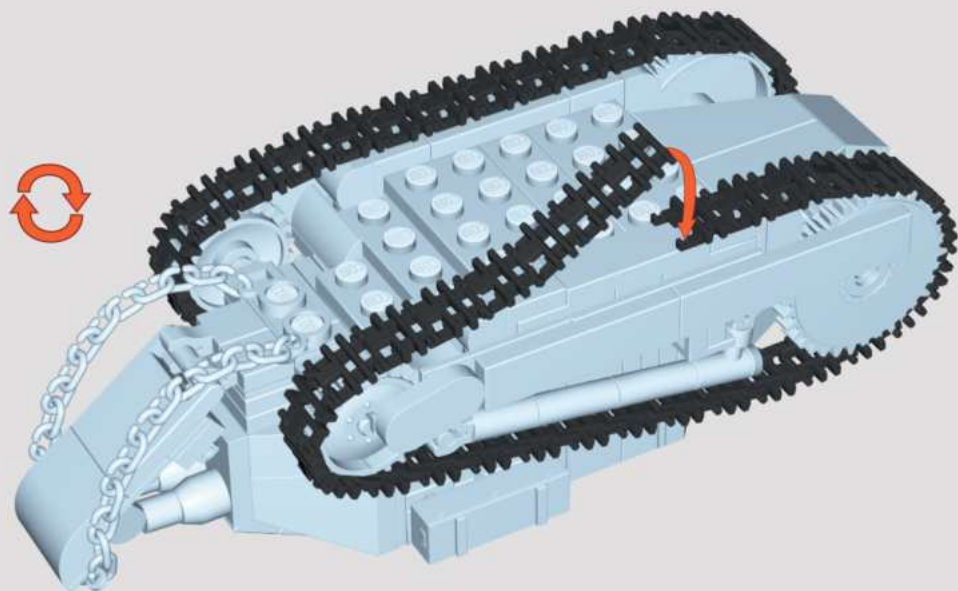

45



x2



x1

46

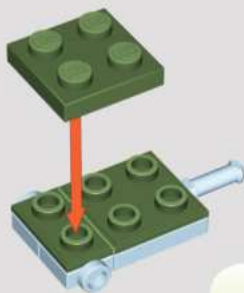

x1



x1



x1

47

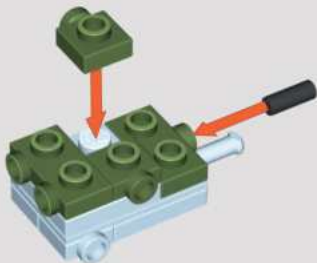

x1



x2



x1



x1

48

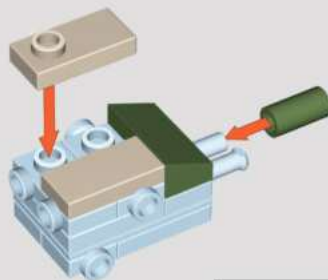

1:1



x1



x1



x1



x1

49

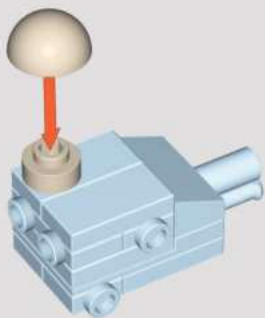

50

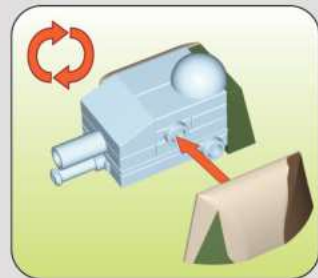
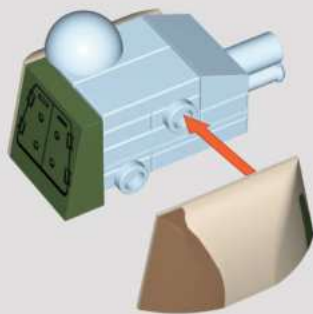

51

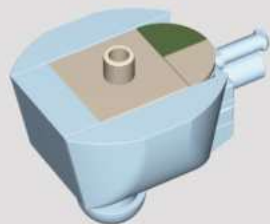

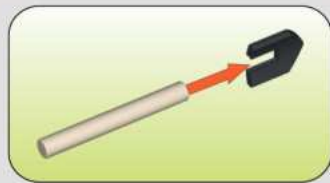
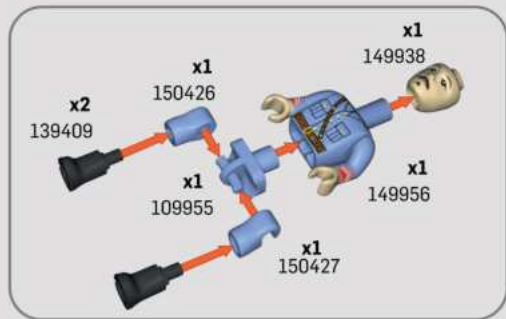
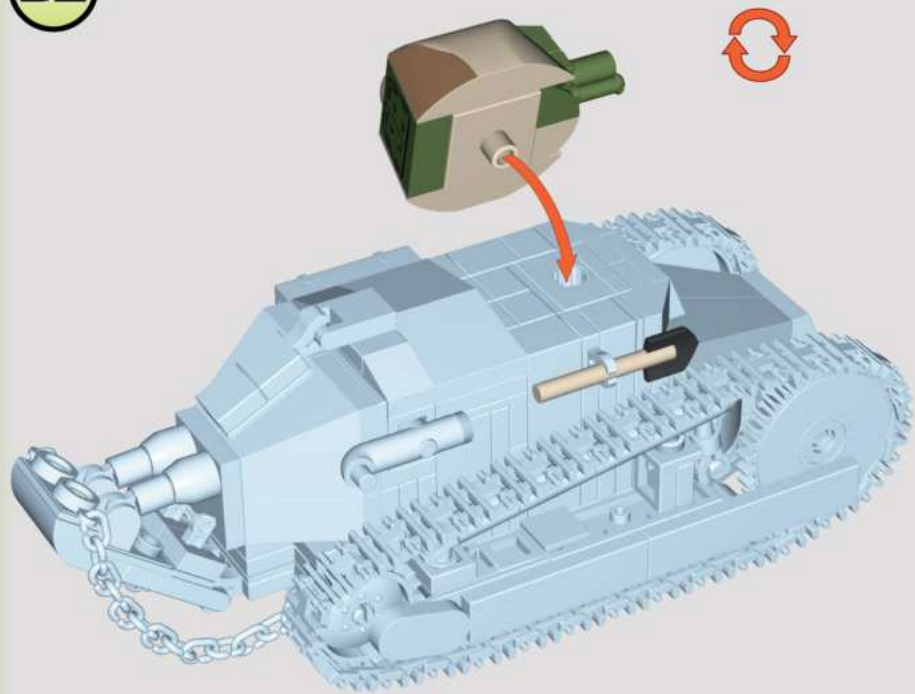

- |   |   |   |
|---|---|---|
| <br>x2<br>109389 | <br>x1<br>44013  | <br>x4<br>44014  |
| <br>x1<br>143737 | <br>x1<br>143520 | <br>x1<br>42872  |
| <br>x1<br>136861 | <br>x1<br>135731 | <br>x1<br>132985 |
| <br>x4<br>143568 | <br>x2<br>123484 | <br>x1<br>127736 |







# HISTORICAL COLLECTION



Sturmpanzerwagen A7V

STURMPANZERWAGEN A7V

2989



MARK V (Male)

2984



FOKKER DR.1 "RED BARON"

2986



SOPWITH CAMEL F.1

2987





RENAULT FT  
🇫🇷 2991



 **WARNING: CHOKING HAZARD.**  
Toy contains small parts.  
Not for children under 3 years.



ROLLS ROYCE ARMOURD CAR  
🇬🇧 2988



VICKERS A1E1 INDEPENDENT  
🇬🇧 2990



# HISTORICAL COLLECTION

**WWW.COBI.EU**

**00-02992-293**

For  
news and  
special deals

Find us on:  
  [cobi.bricks](https://www.facebook.com/cobi.bricks)  
[cobi.bricks](https://www.instagram.com/cobi.bricks)  
 [cobi.bricks](https://www.youtube.com/cobi.bricks)  
**COBI SA**