

COMPANY OF HEROES 3



CHURCHILL MK. III

IN SERVICE - 1942 - 1944
PLACE OF ORIGIN - UNITED KINGDOM
TYPE - HEAVY INFANTRY TANK
WEIGHT - 39t (85,980LB)
ARMOUR - 102MM (4") AT THE FRONT
ARMAMENT - 57MM (2.2") 6-PDR MK III GUN,
2x 7,92MM (0.3") BESA MG
ENGINE - BEDFORD TWIN-SIX, 350HP
SPEED - 25,7KM/H (15,5MPH)
CREW - 5



3046

PAD PRINTED
NO STICKERS

Printed in EU



WARNING: CHOKING HAZARD-
Toy contains small parts.
Not for children under 3 years.

654  1 

CHURCHILL MK. III

SCALE 1:35

1

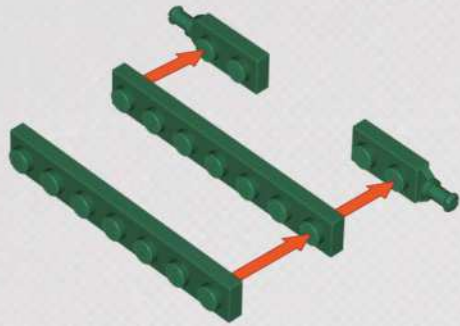

x2



x2

2

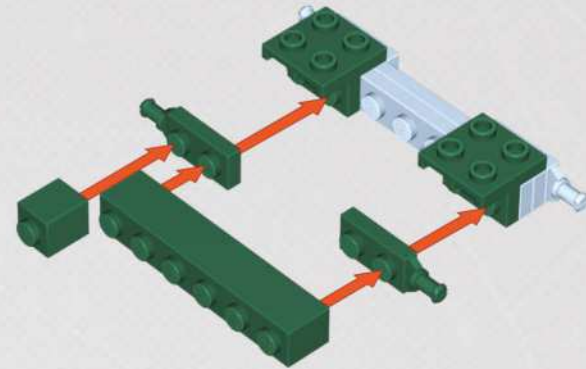

x2



x2

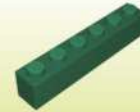

x1



x1

3

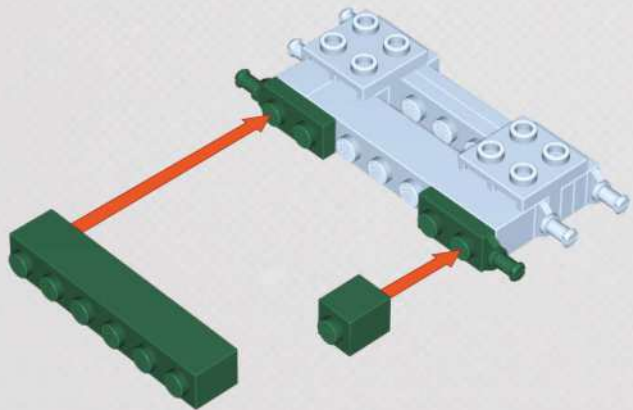

x2



x1



x1

4

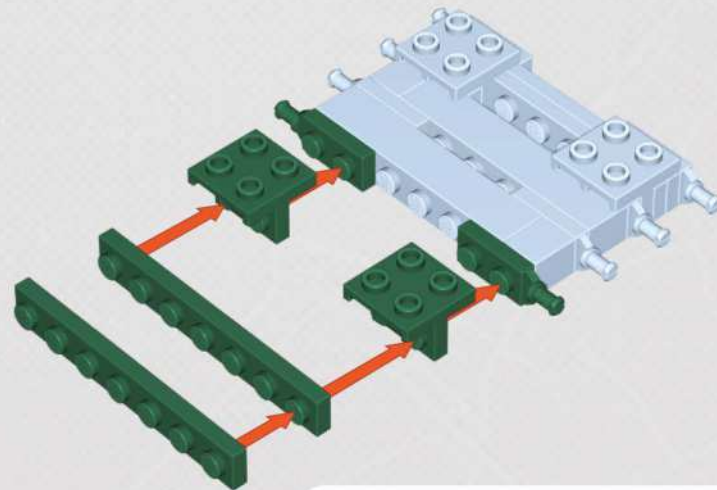

x2



x2



x2

5

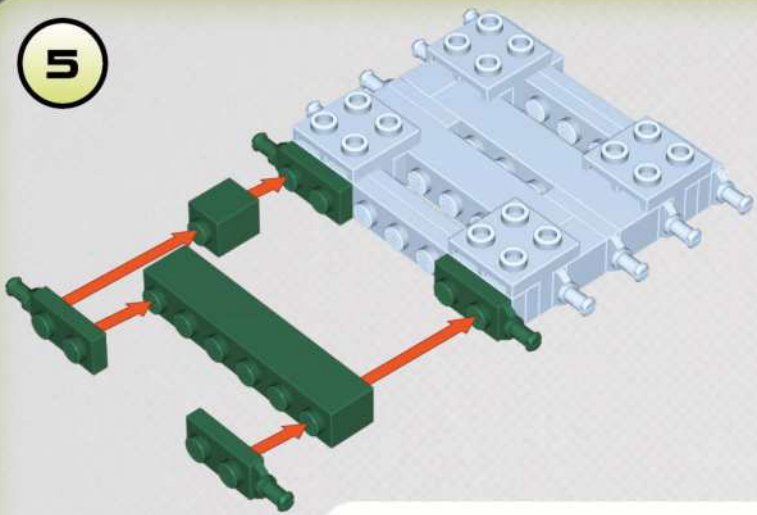

x4



x1

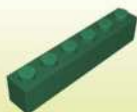

x1

6

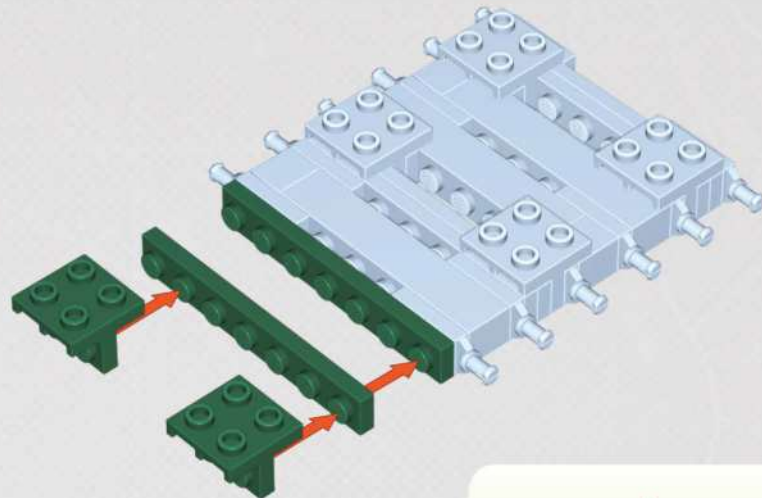

x2



x2

7

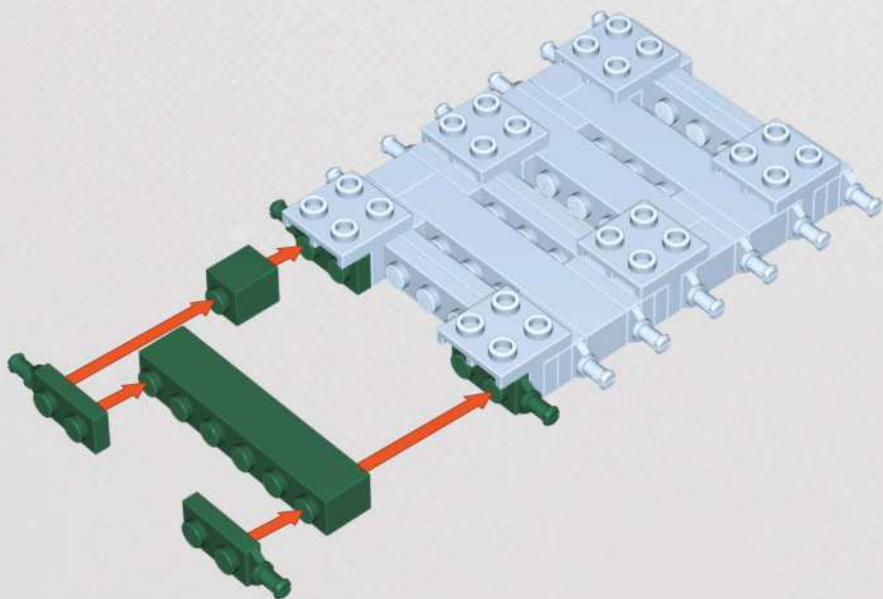

x4



x1



x1

8

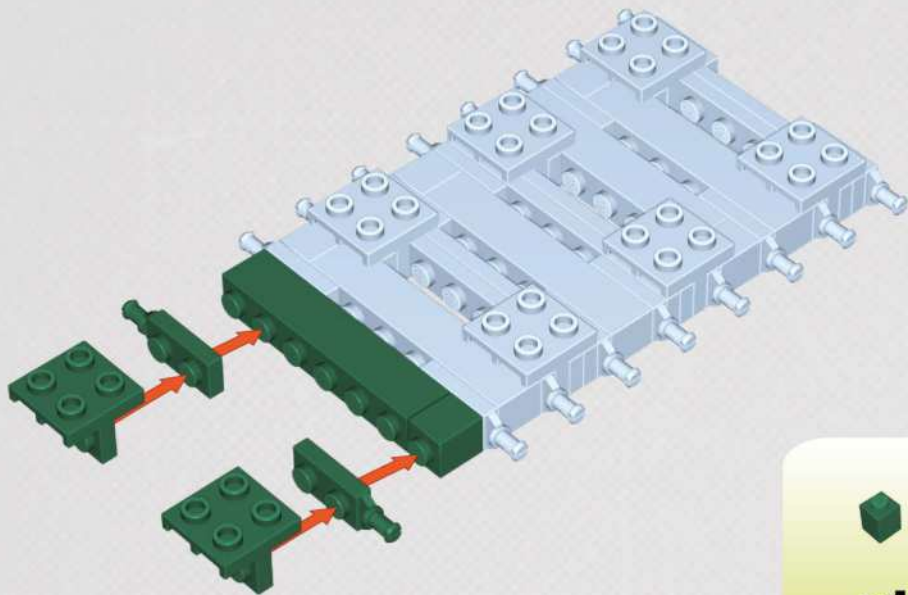

x1



x1



x2



x2

9

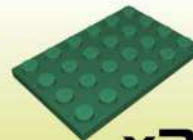
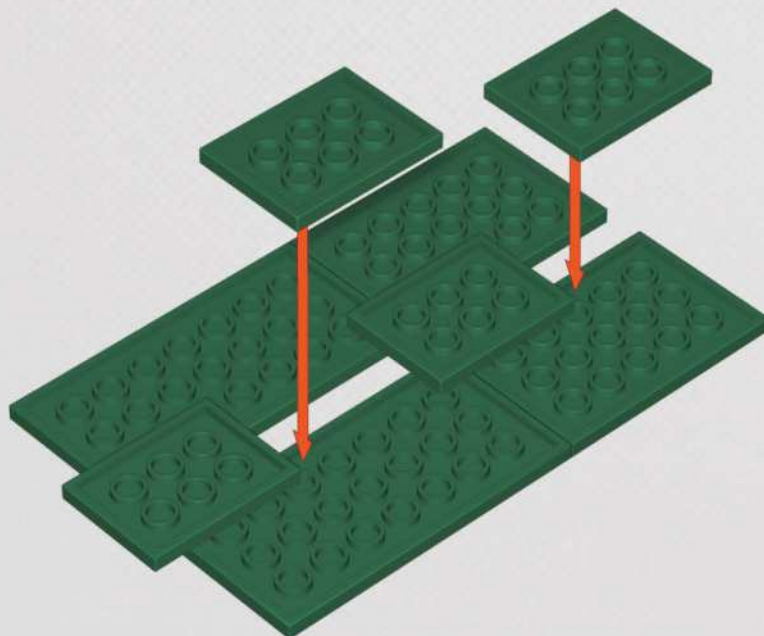

x2



x2



x4

10

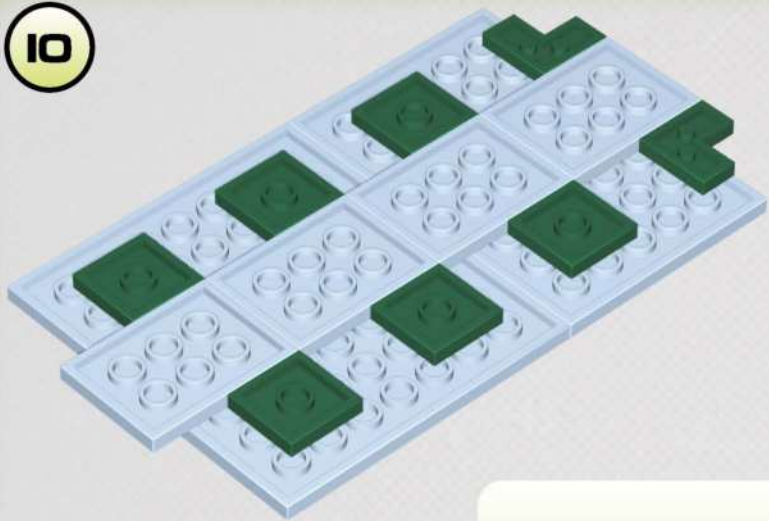



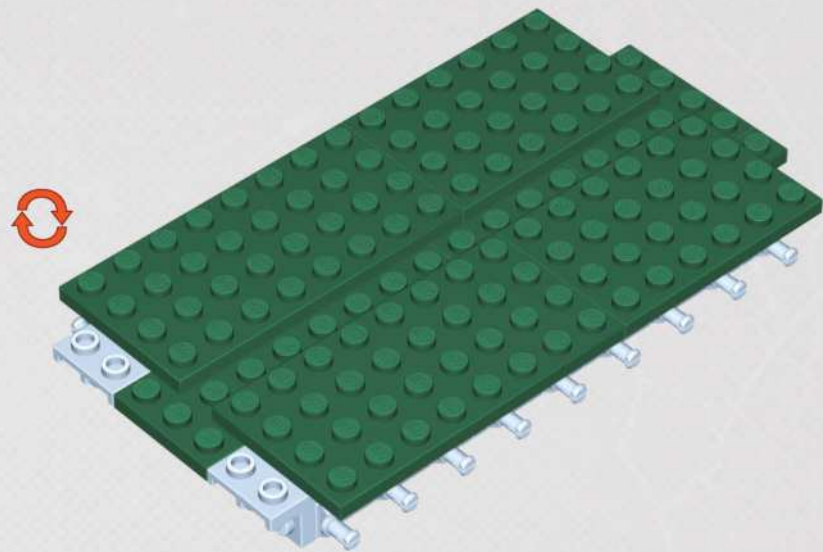

 
x2 **x6**

11

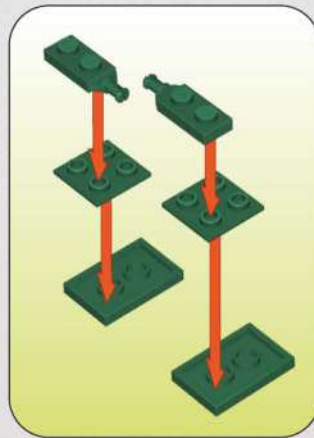
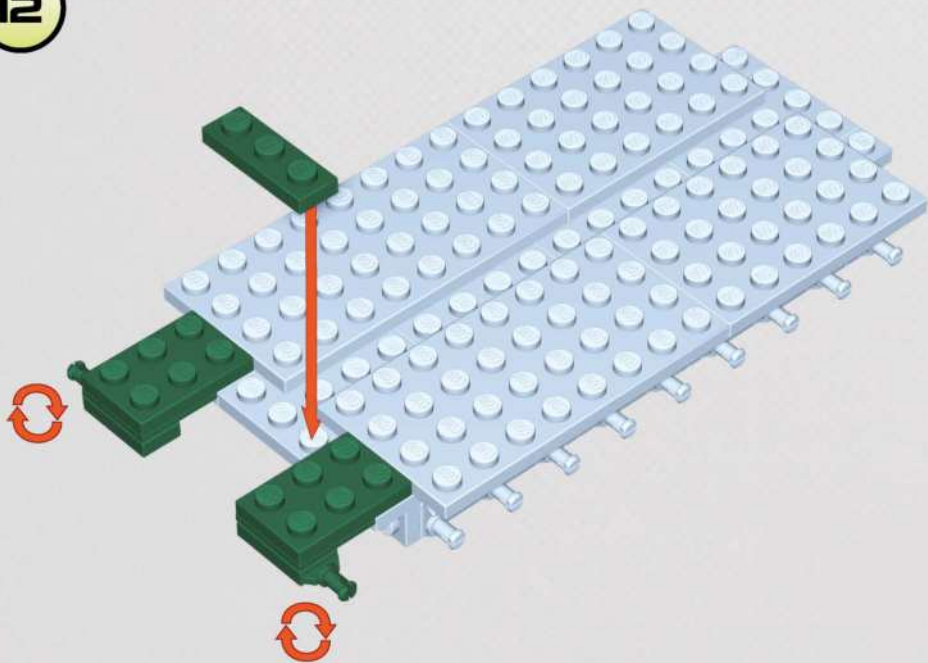

12



   
x2 **x2** **x2** **x1**

13

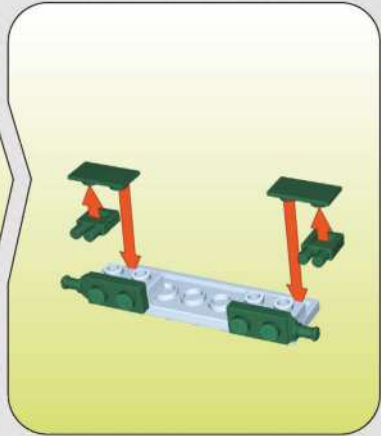
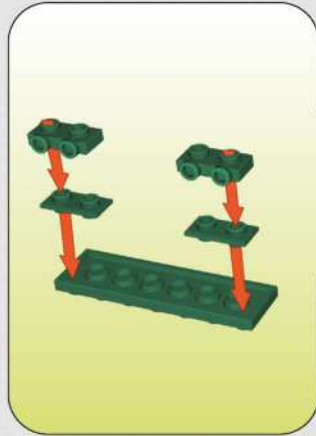
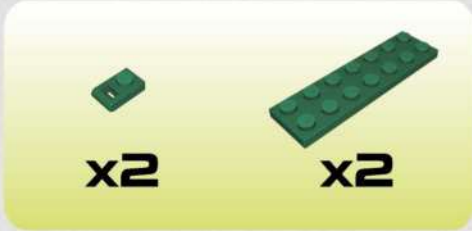
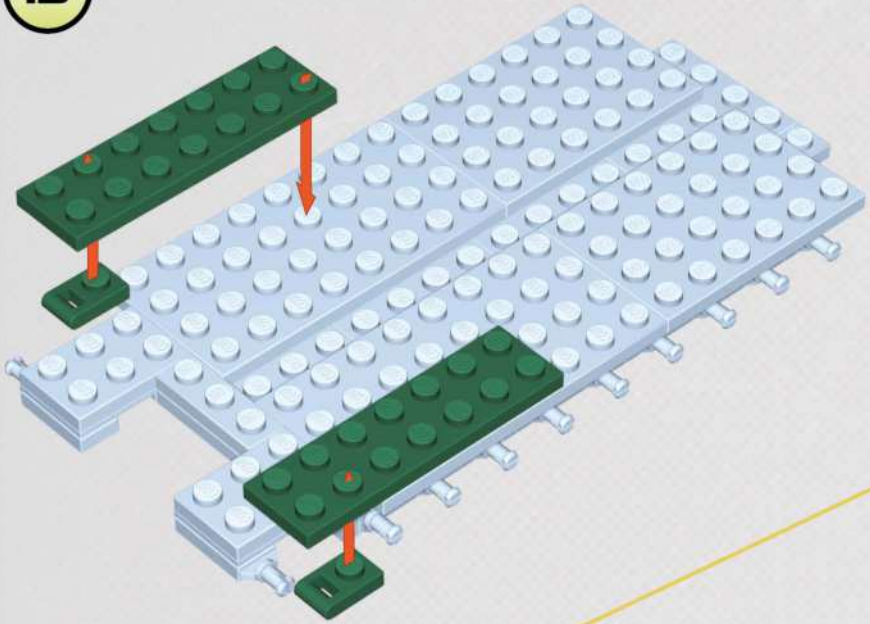

14

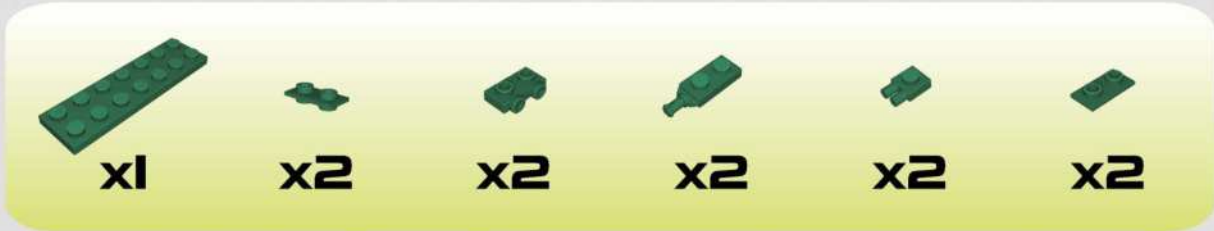
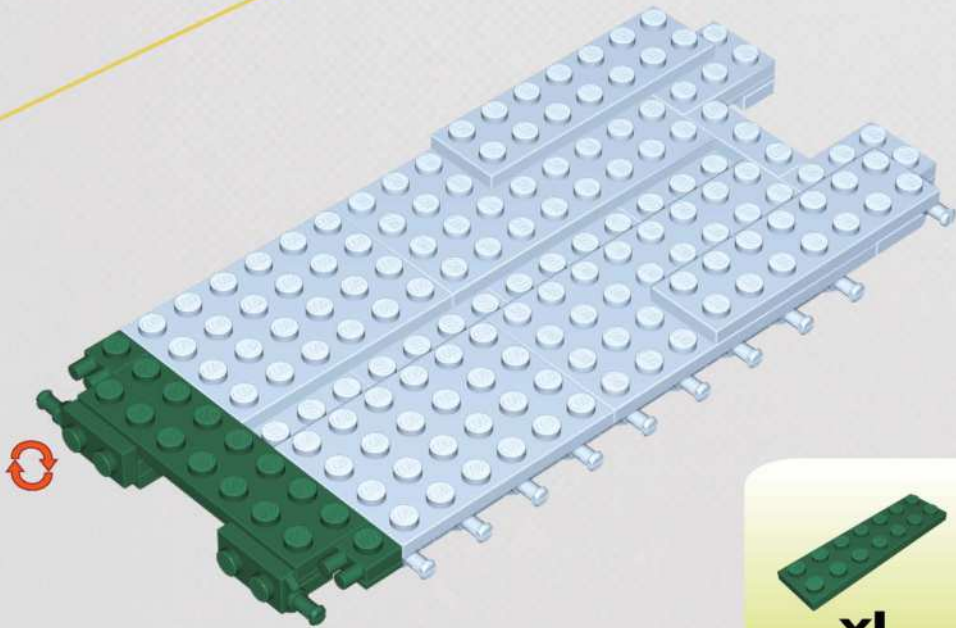

15

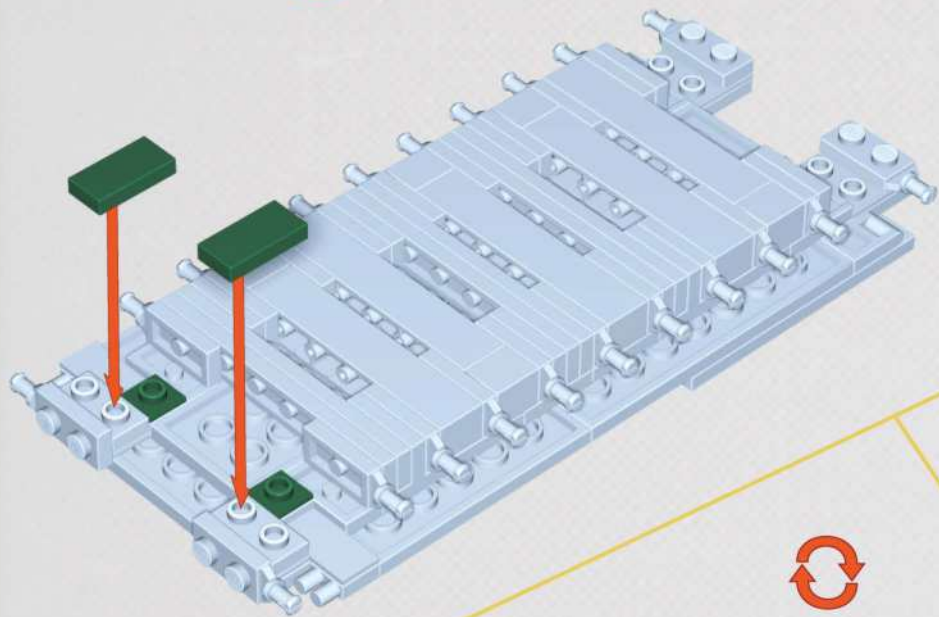

x2	x2

1:1

16

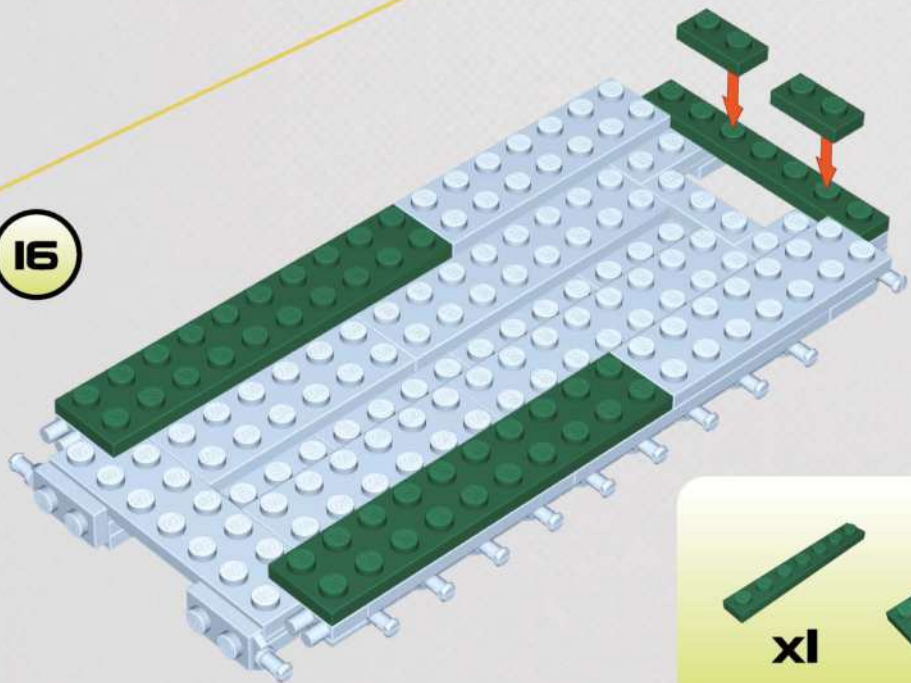

x1	x2	x2

17

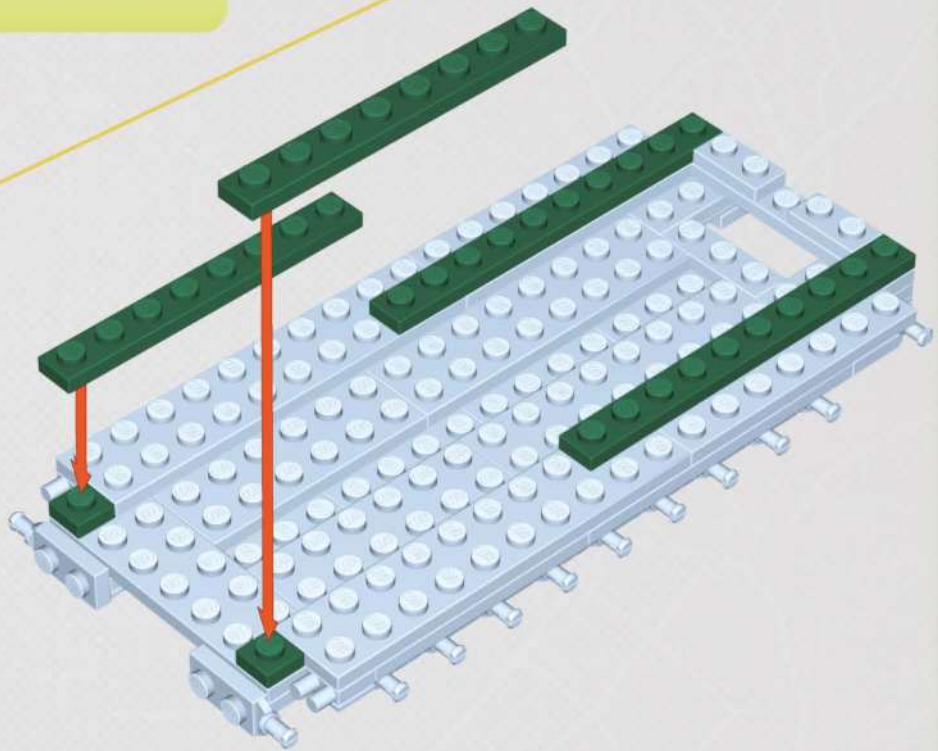

x2	x2	x2

18

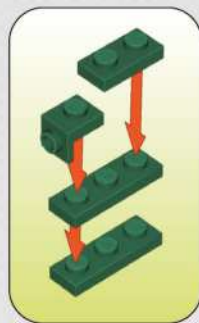
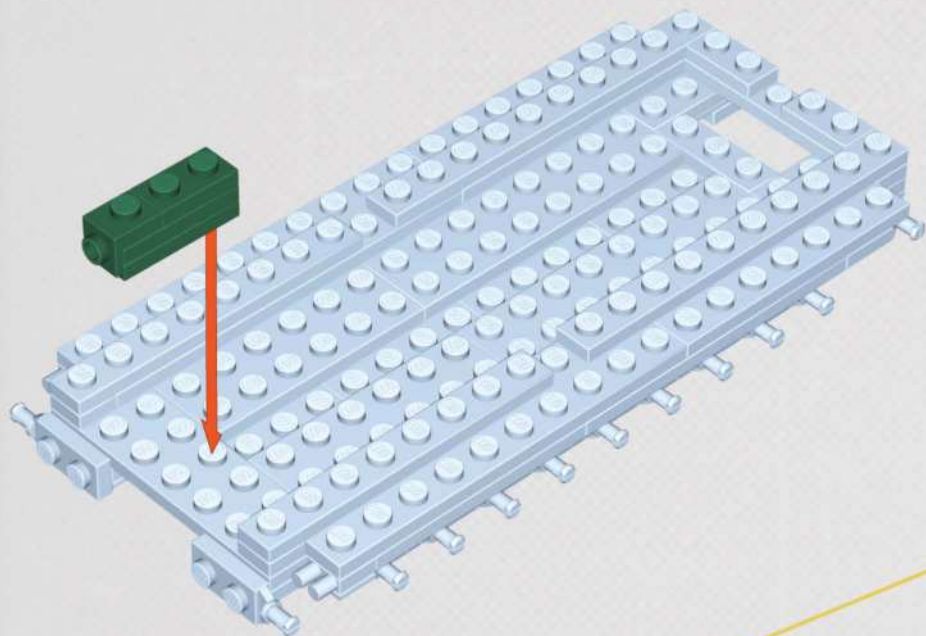

x2



x1



x1

19

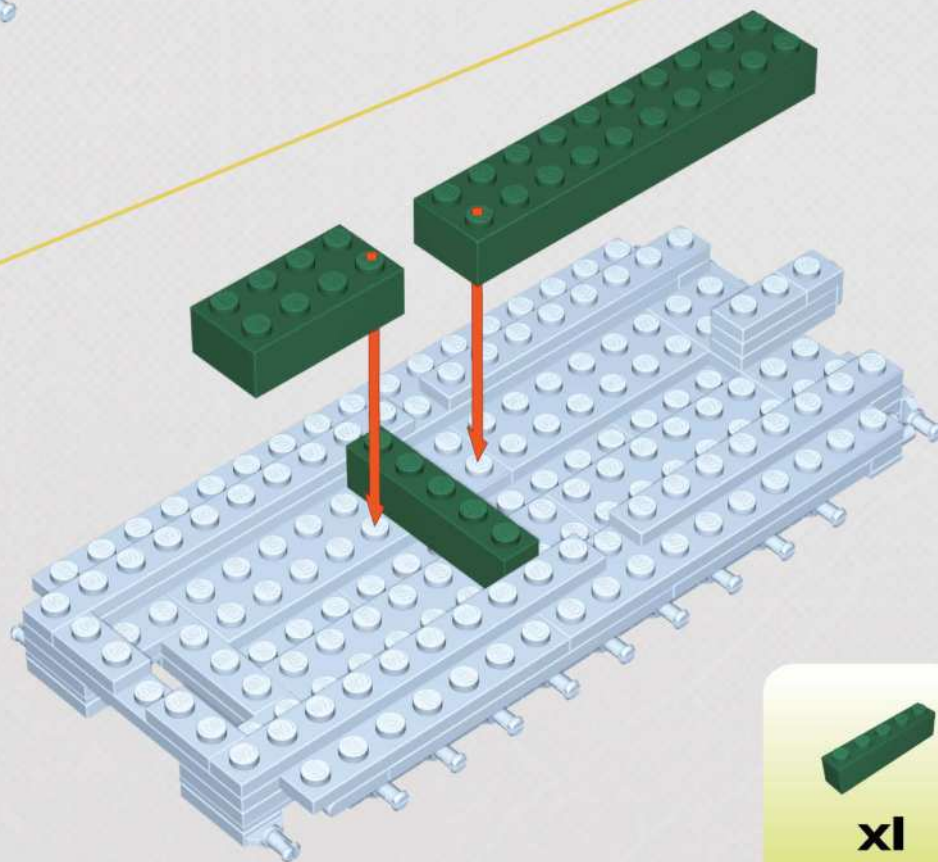

x1

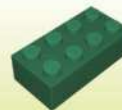

x1



x1

20

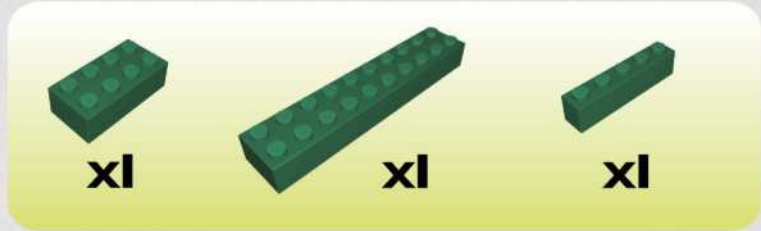
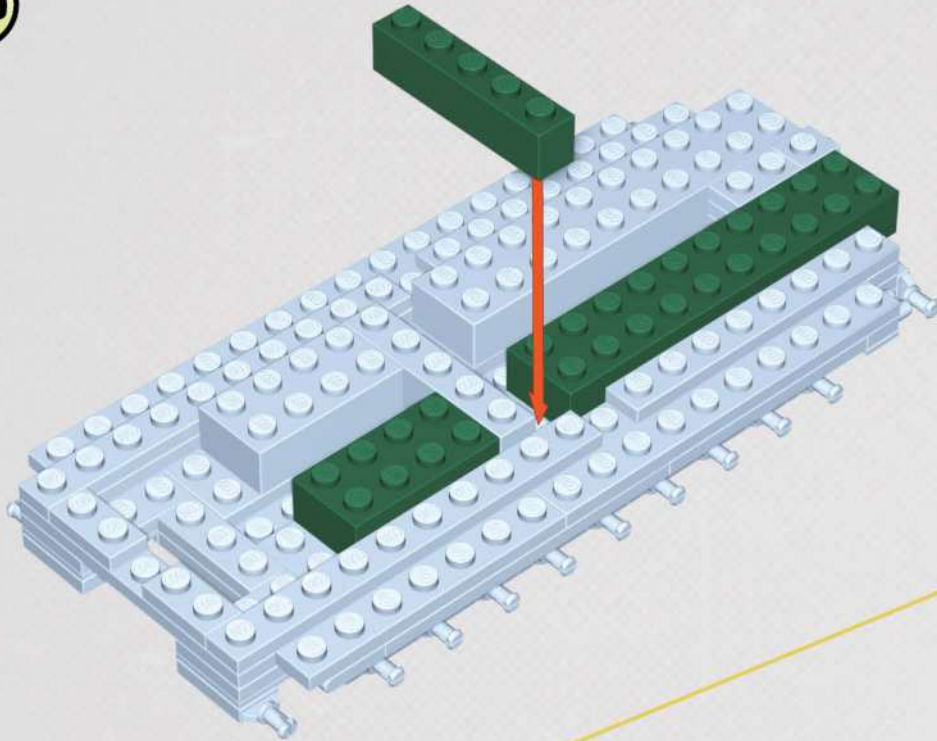

21

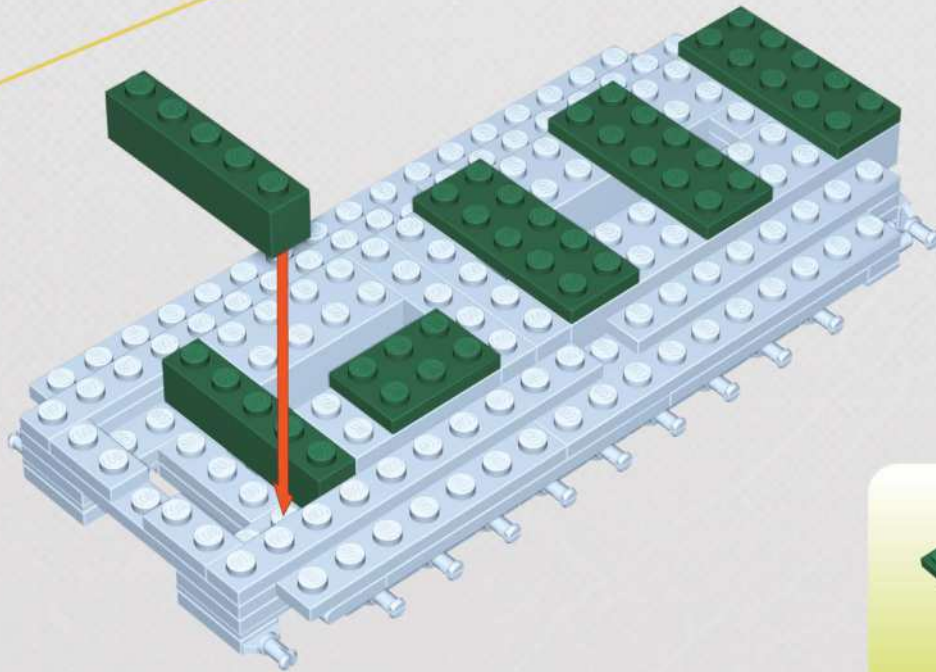

22

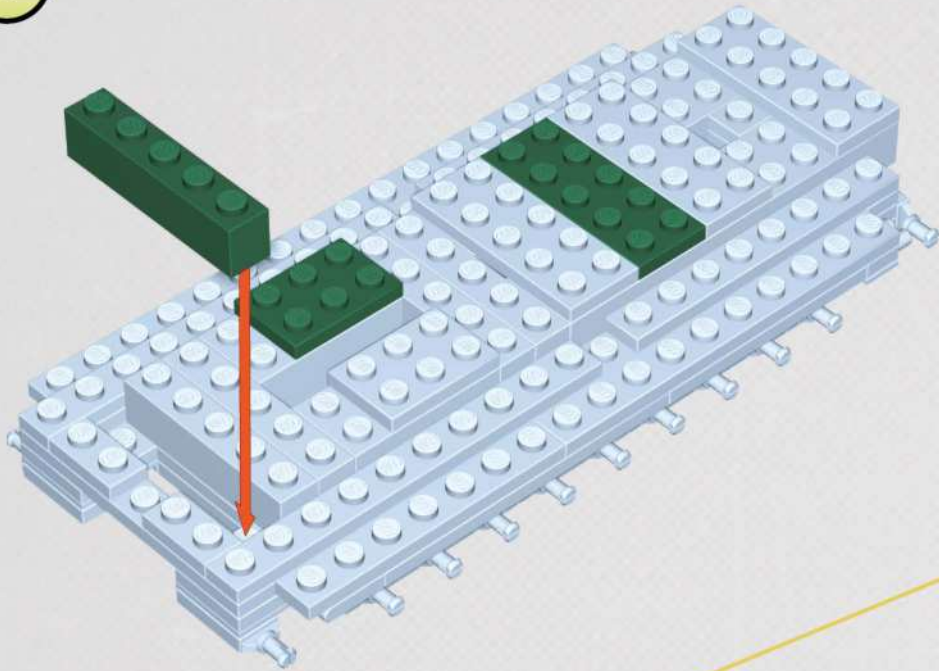

23

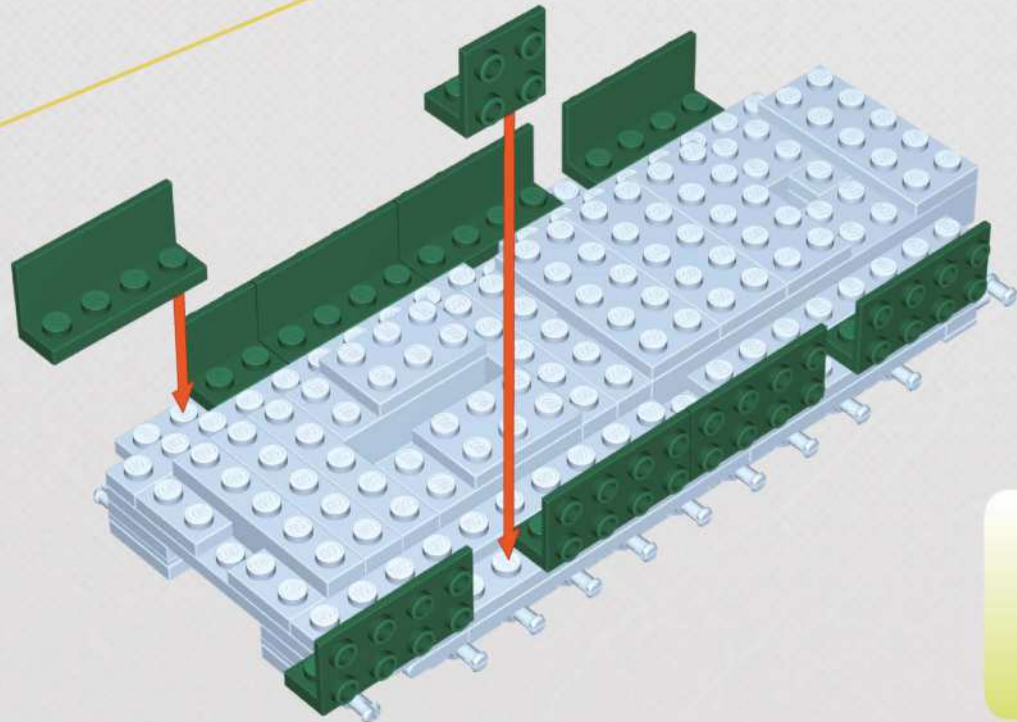

24

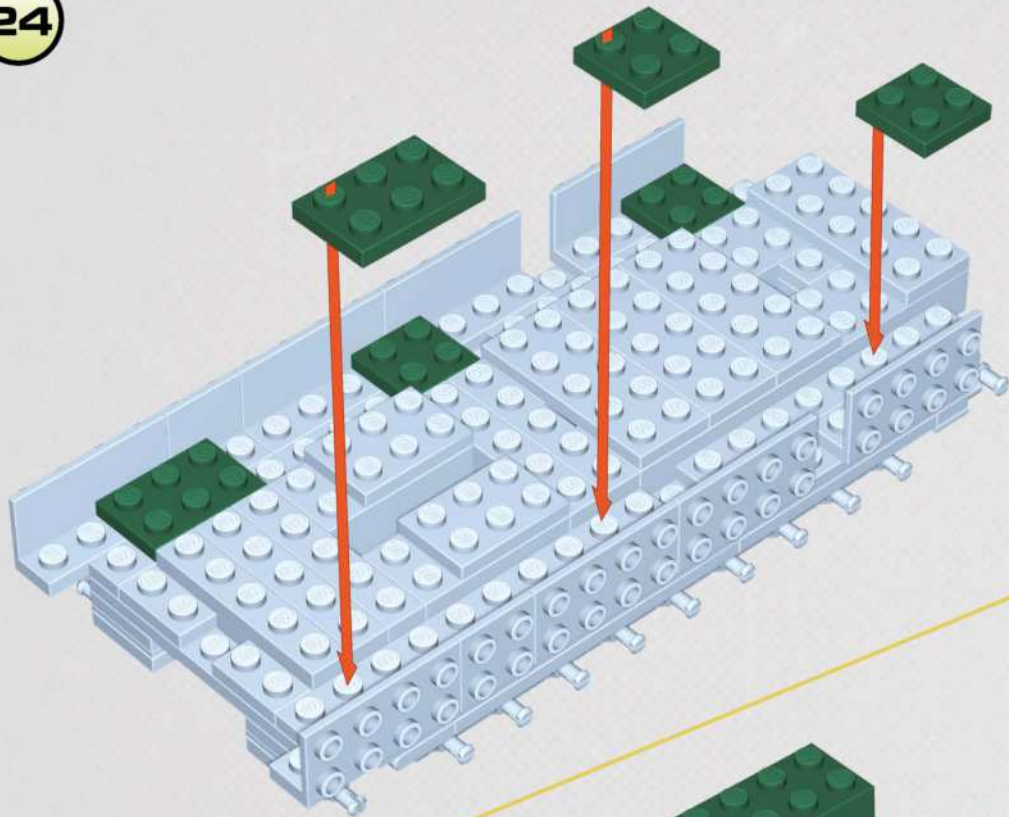

LEGO parts list for step 24:

- Green 1x2 Technic Plate: x2
- Green 1x2 Technic Plate (with hole): x4

25

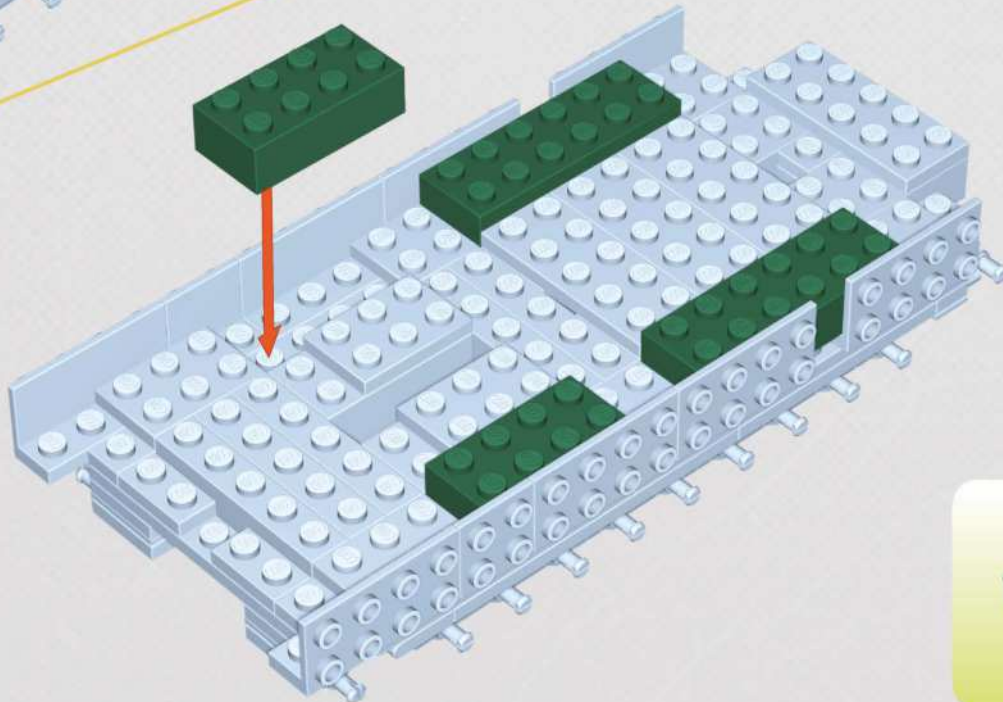

LEGO parts list for step 25:

- Green 1x4 Technic Technic Brick: x2
- Green 1x4 Technic Technic Brick (with hole): x2

26

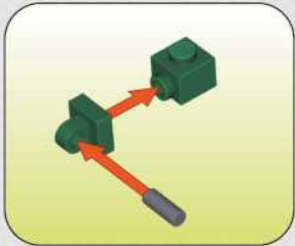
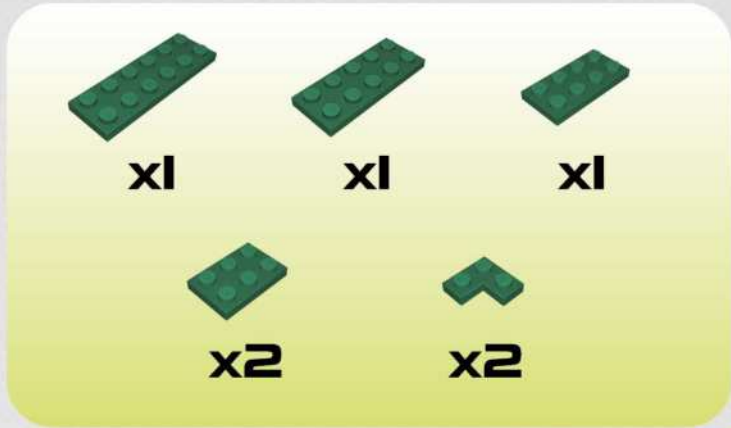
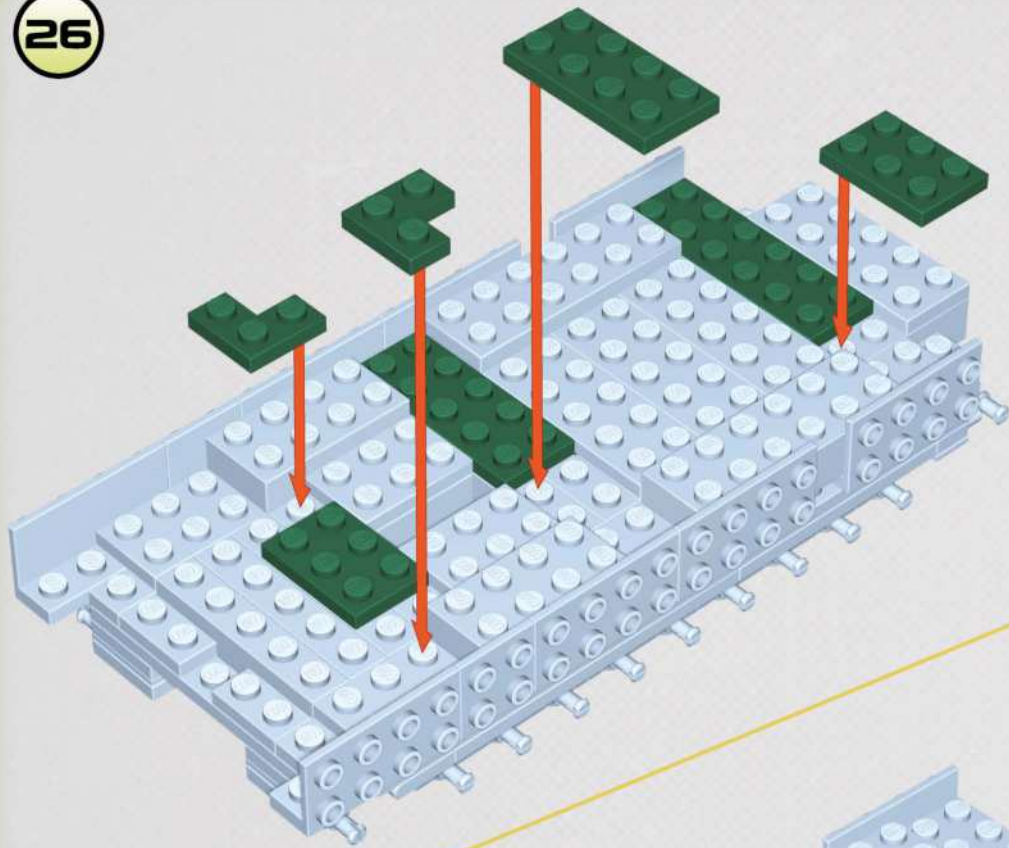



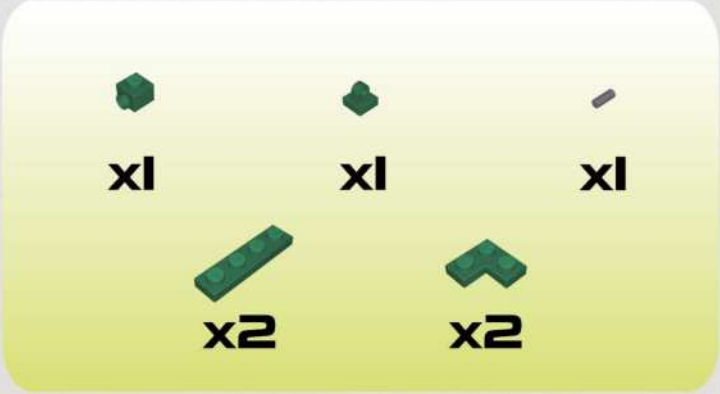
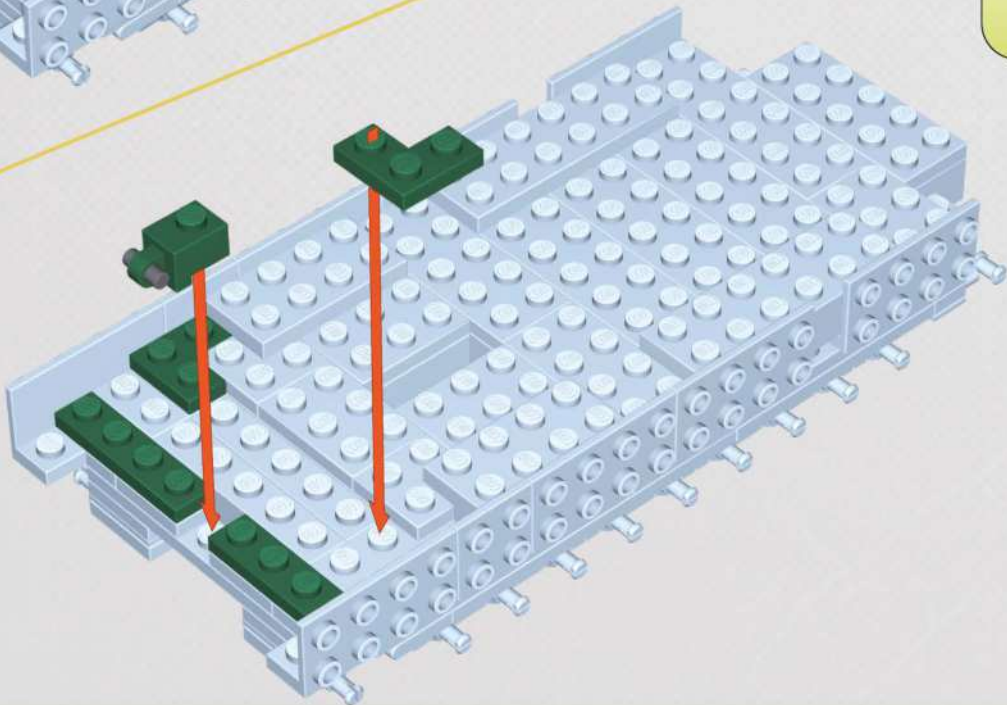

27

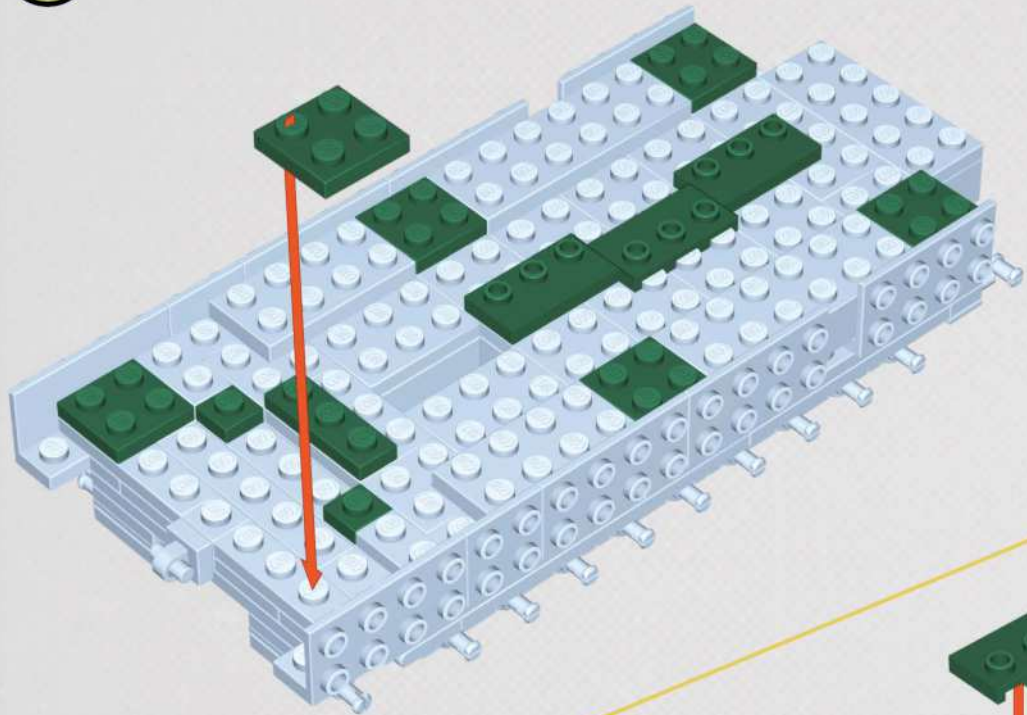

28



Parts list for step 28:

-  x2
-  x1
-  x3
-  x6

29

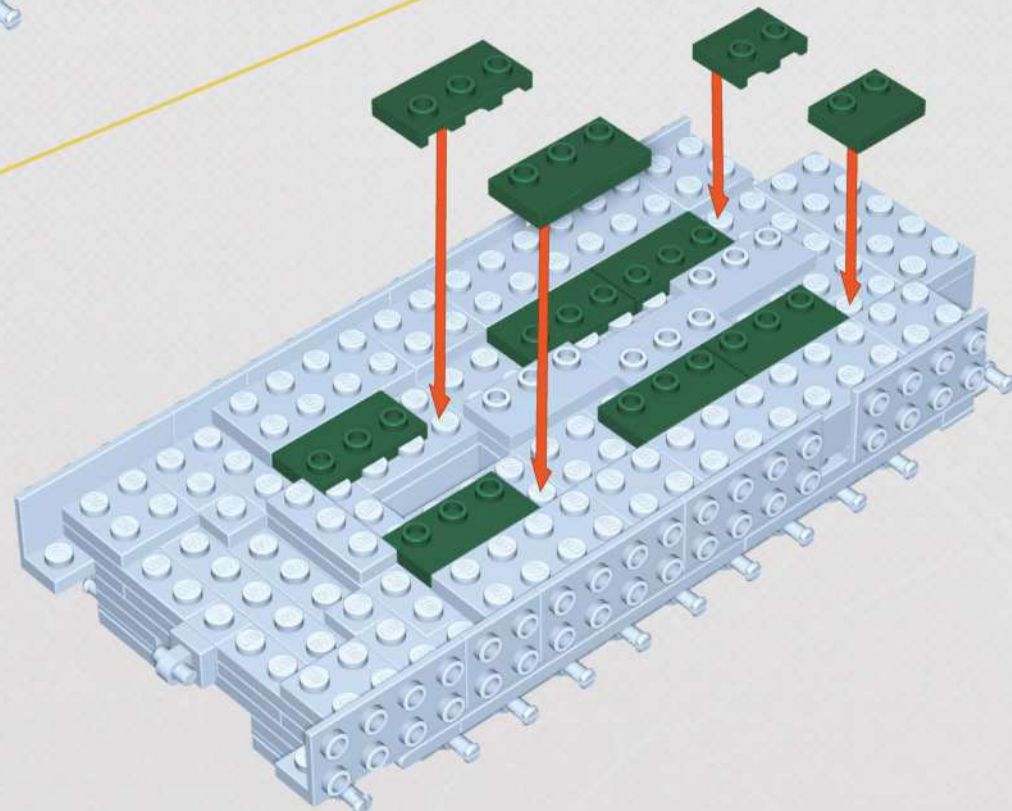



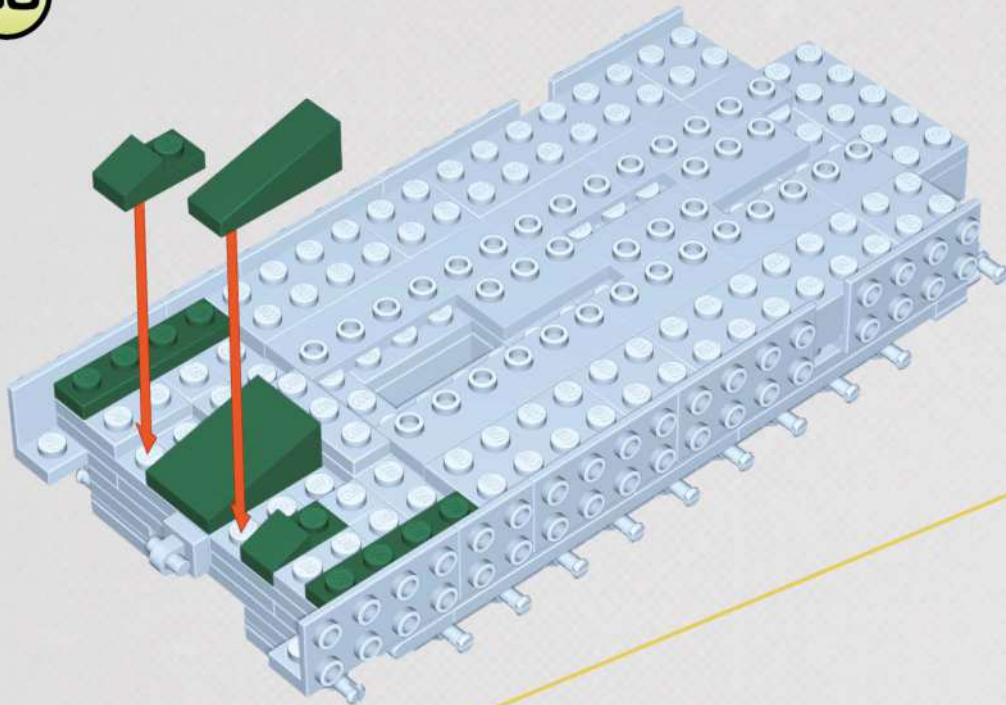

Parts list for step 29:

-  x2
-  x8

30



			
x2	x1	x2	x1

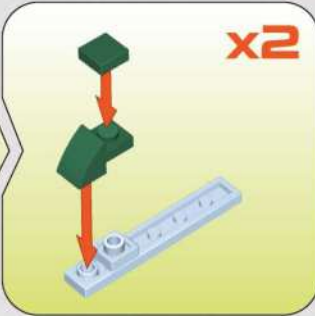

31

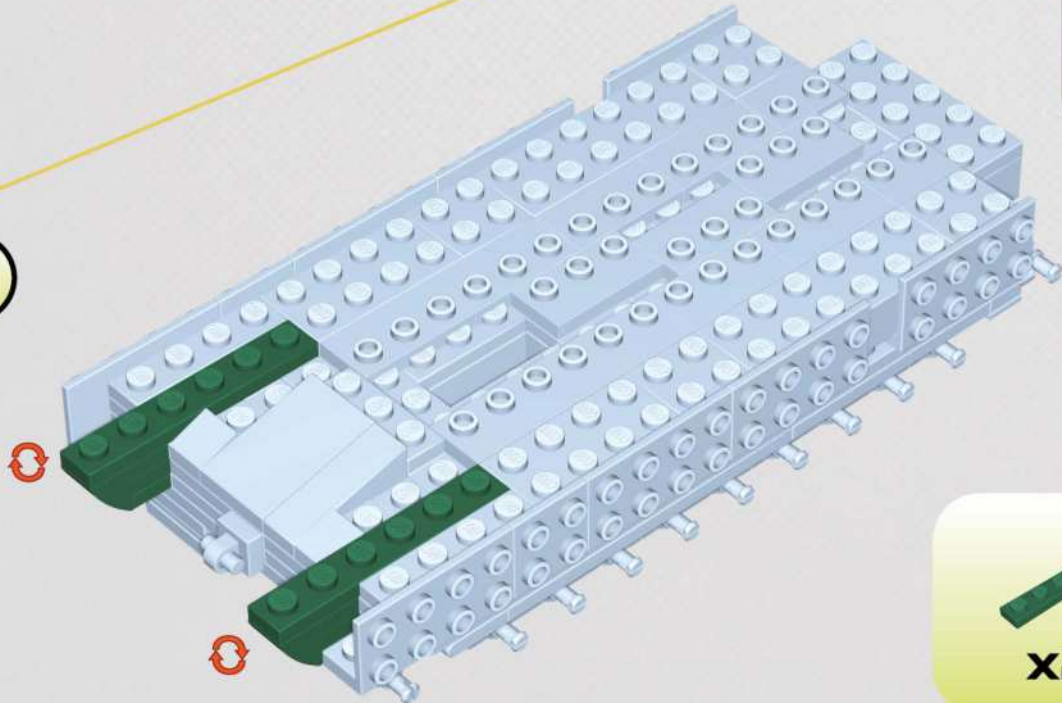

				
x2	x2	x2	x2	x2

32

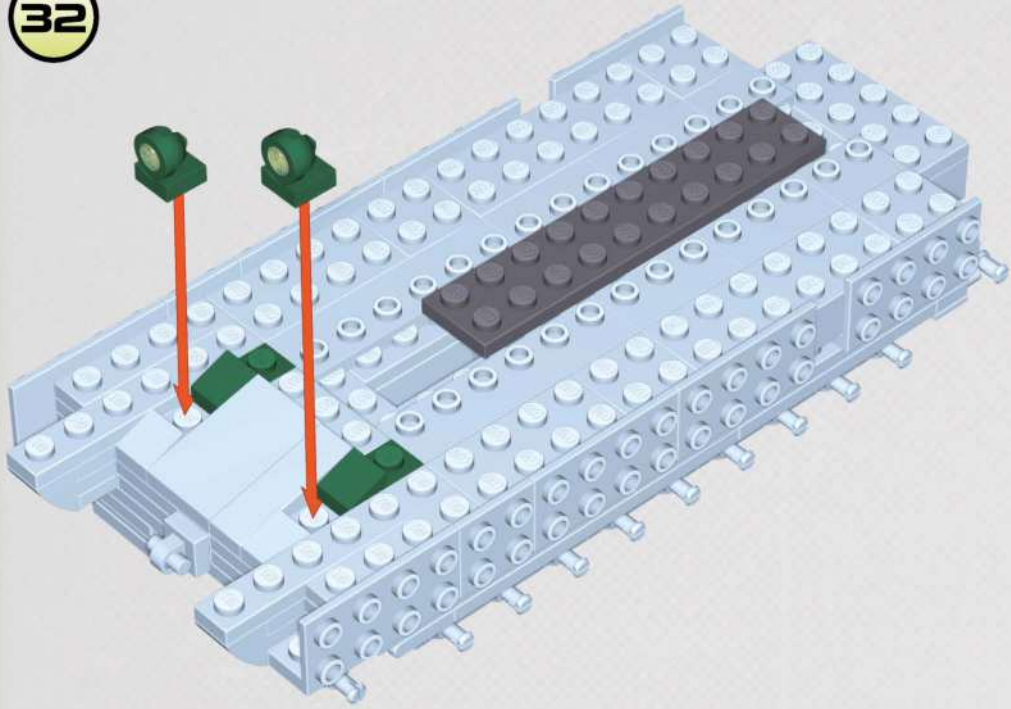





- 
x1
- 
x2
- 
x2
- 
x2
- 
x2

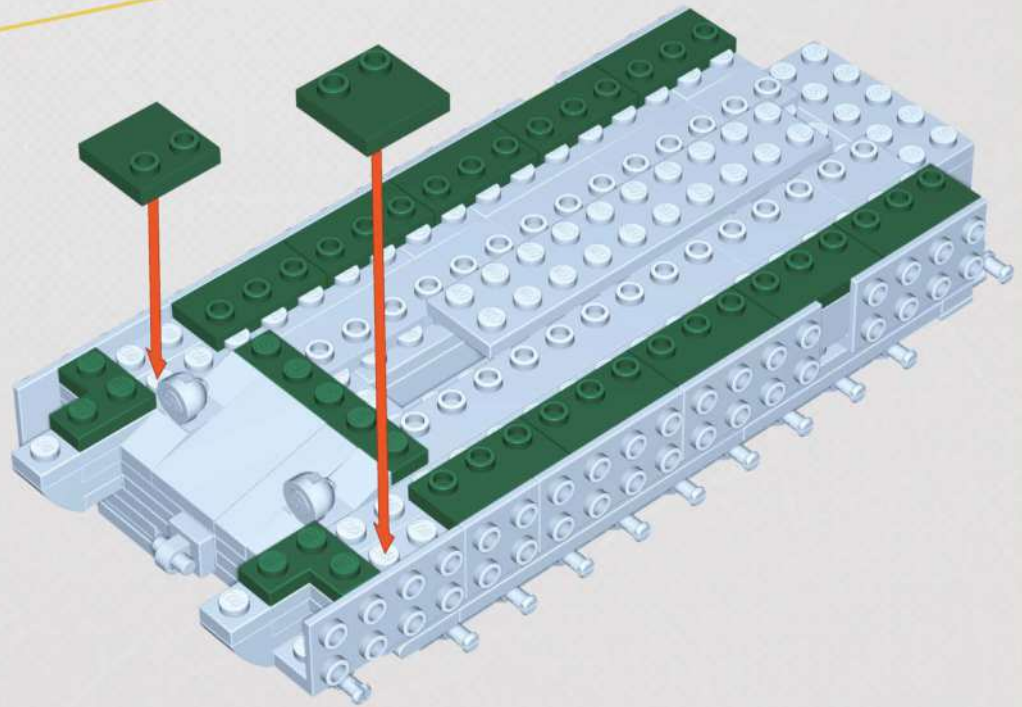

33



- 
x1
- 
x2
- 
x10
- 
x2

34

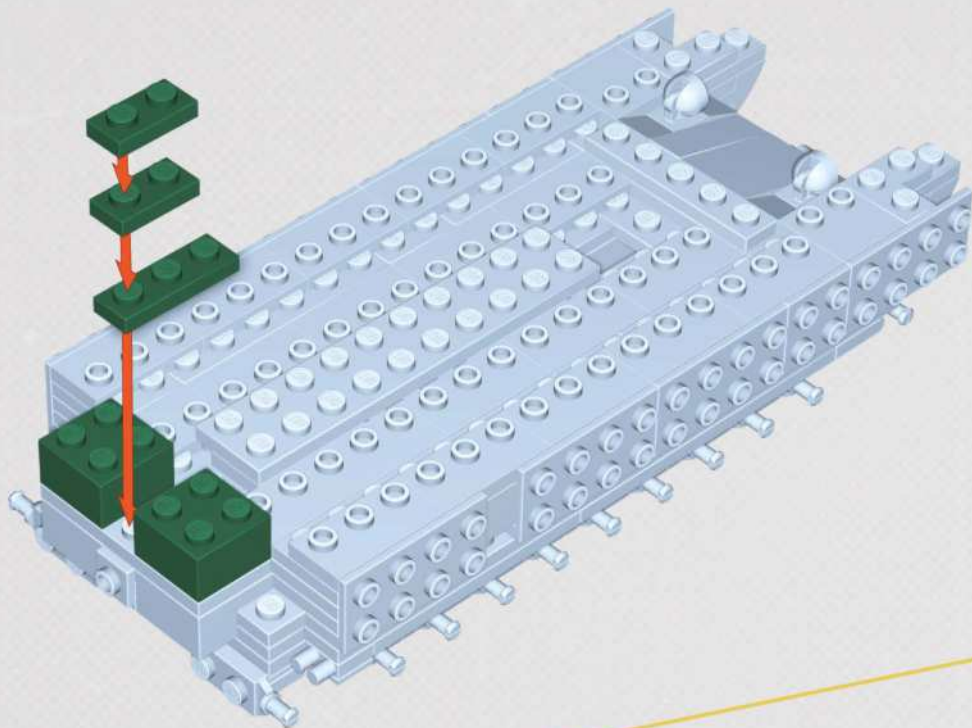

x2



x1



x2

35

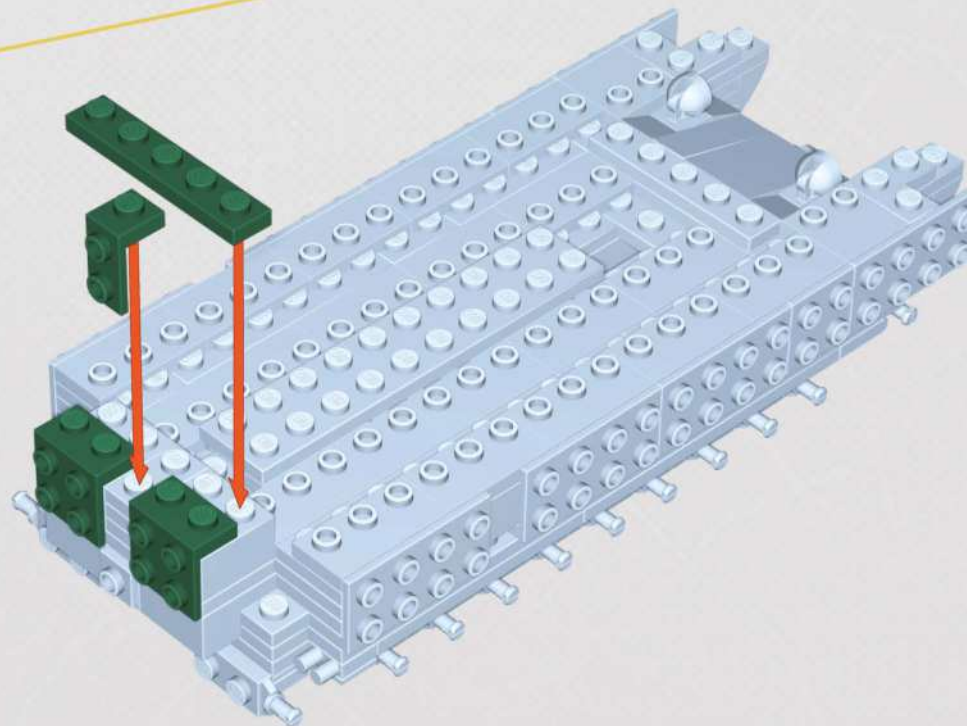

x2







x1

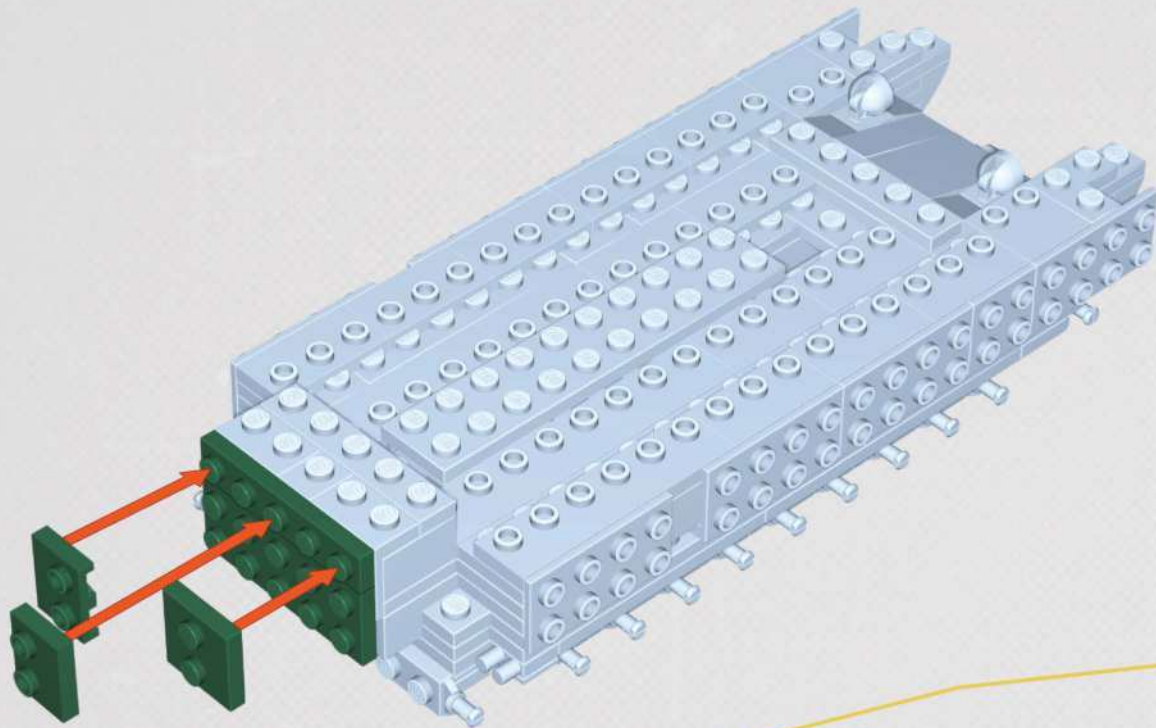

x1



36



	
x1	x1
	
x1	x2

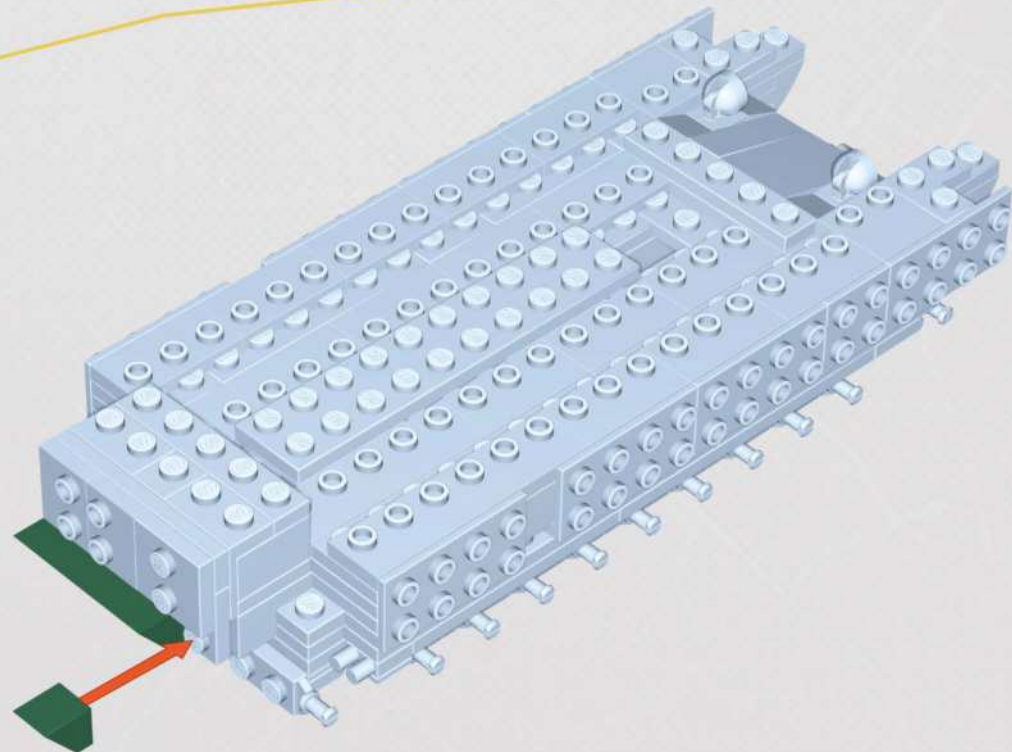



37

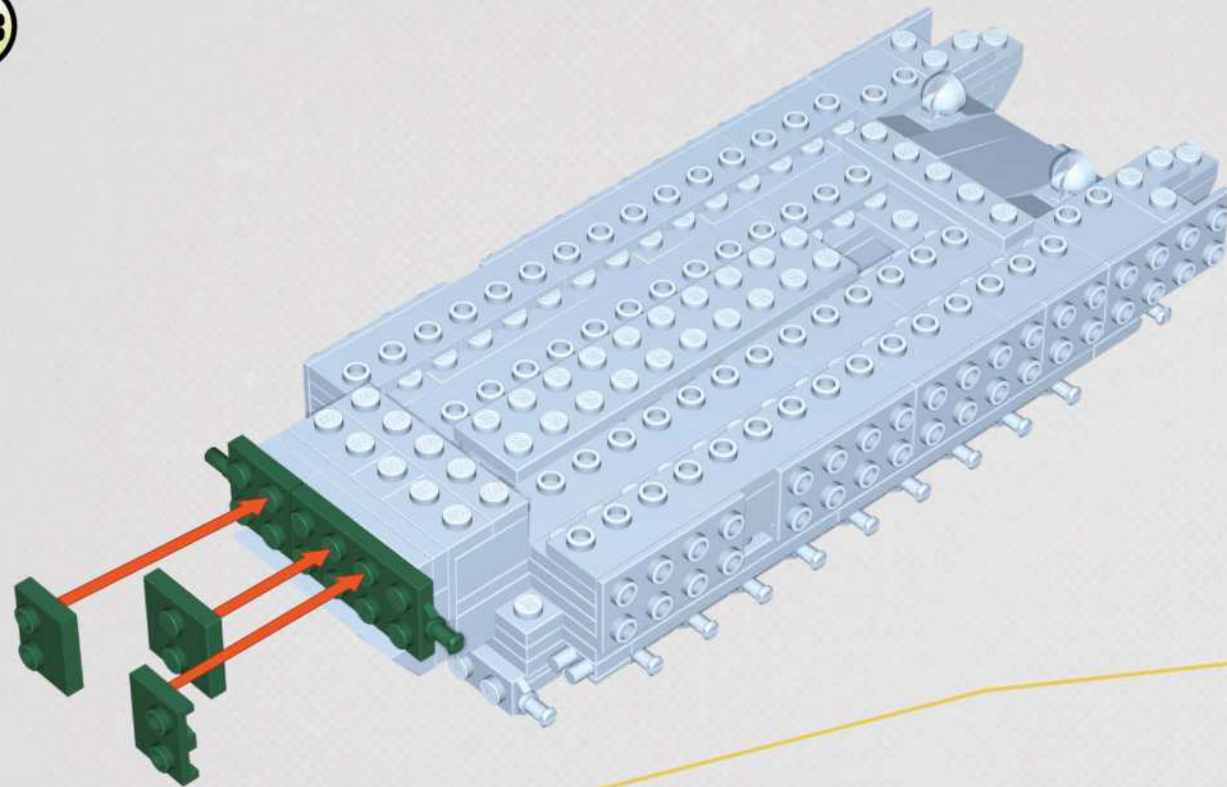

	
x1	x1

38



	
x1	x1
	
x1	x2



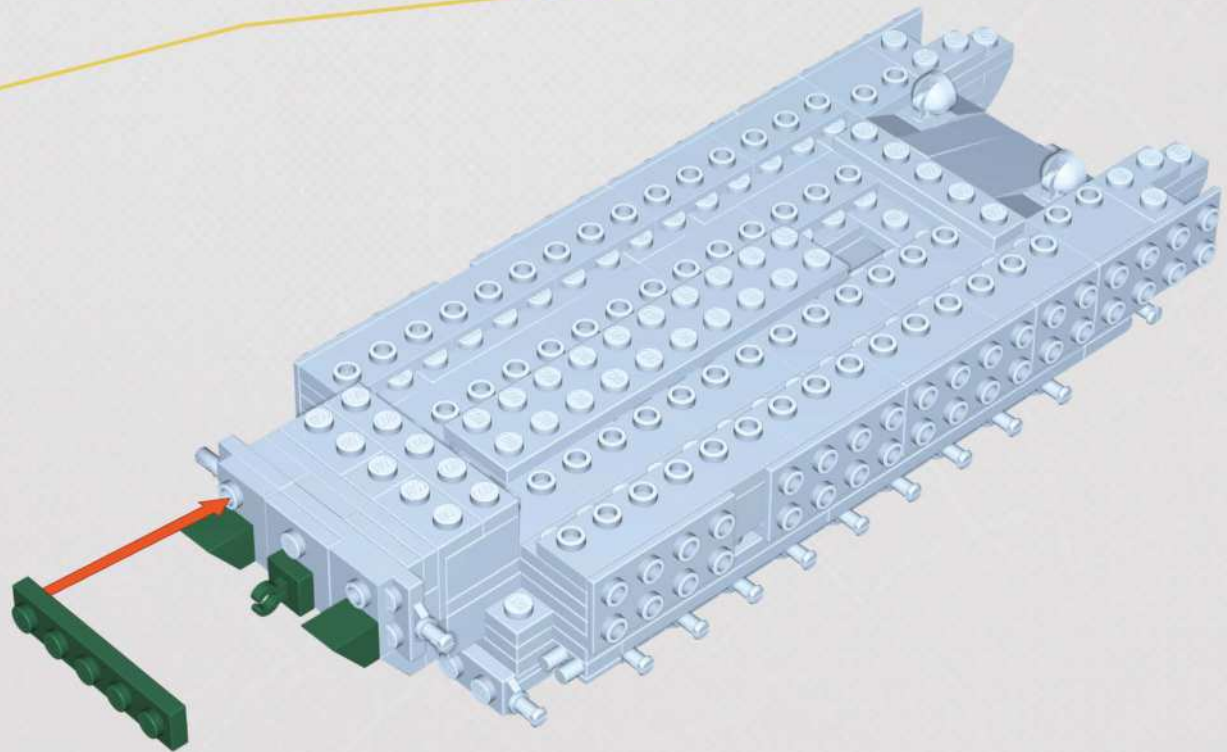

39



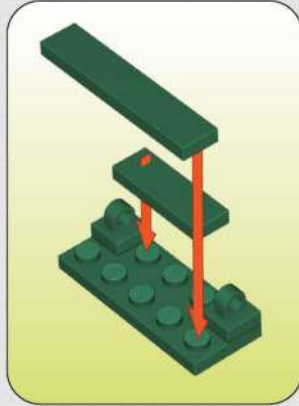
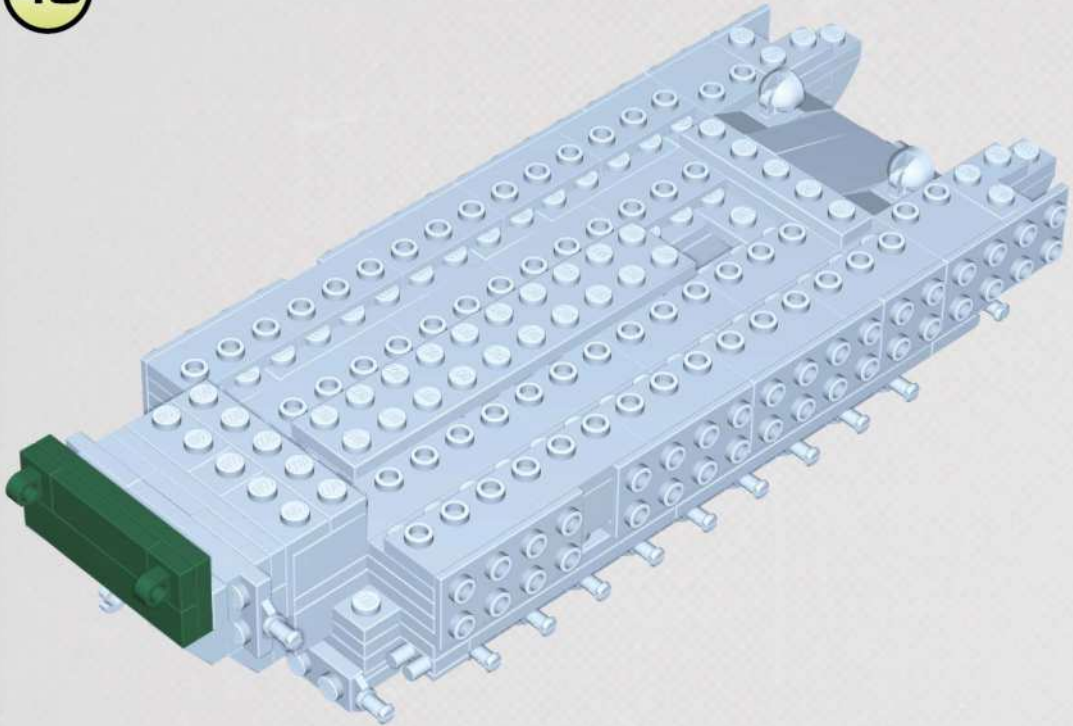



		
x1	x2	x1

40



	
x1	x2
	
x1	x1
1:1	1:1

41

			
x6	x2	x2	x2
1:1			

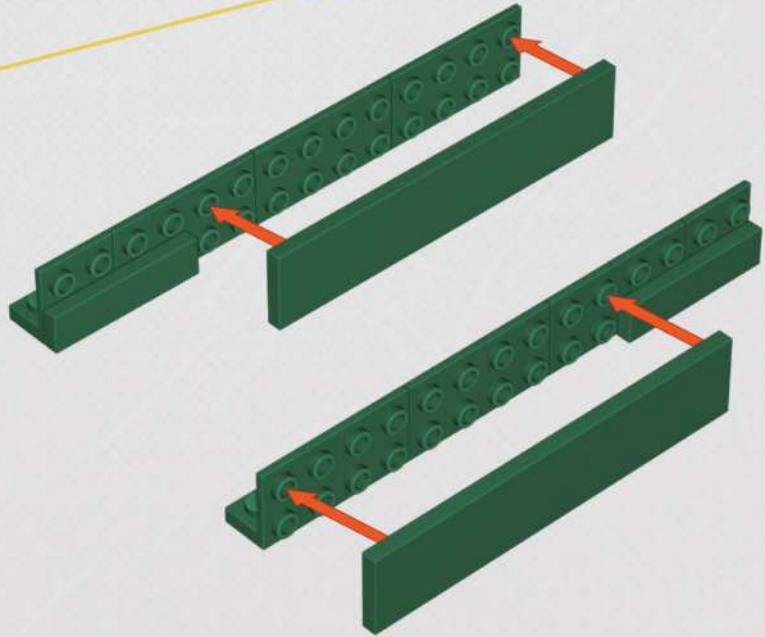

42

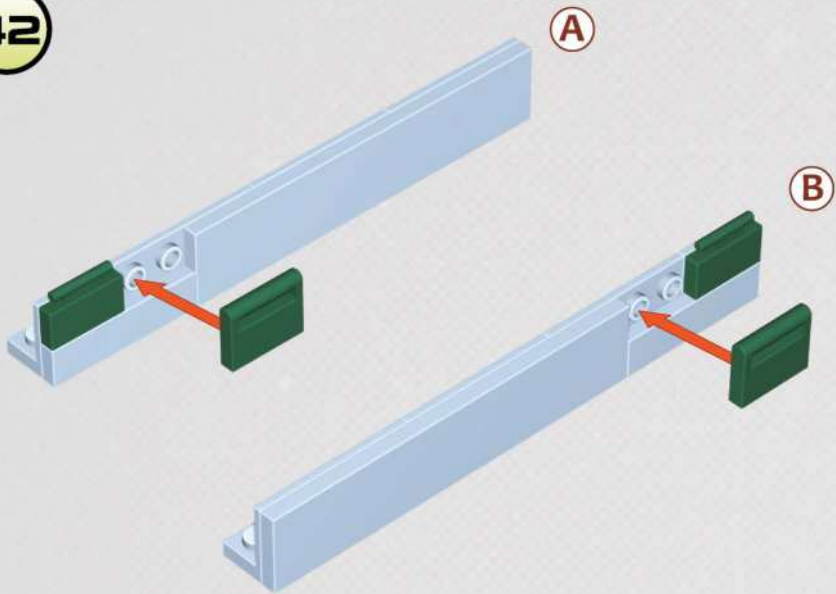

x2 x2

A yellow rounded rectangle containing two green Technic pins and the quantity 'x2' below each.

43

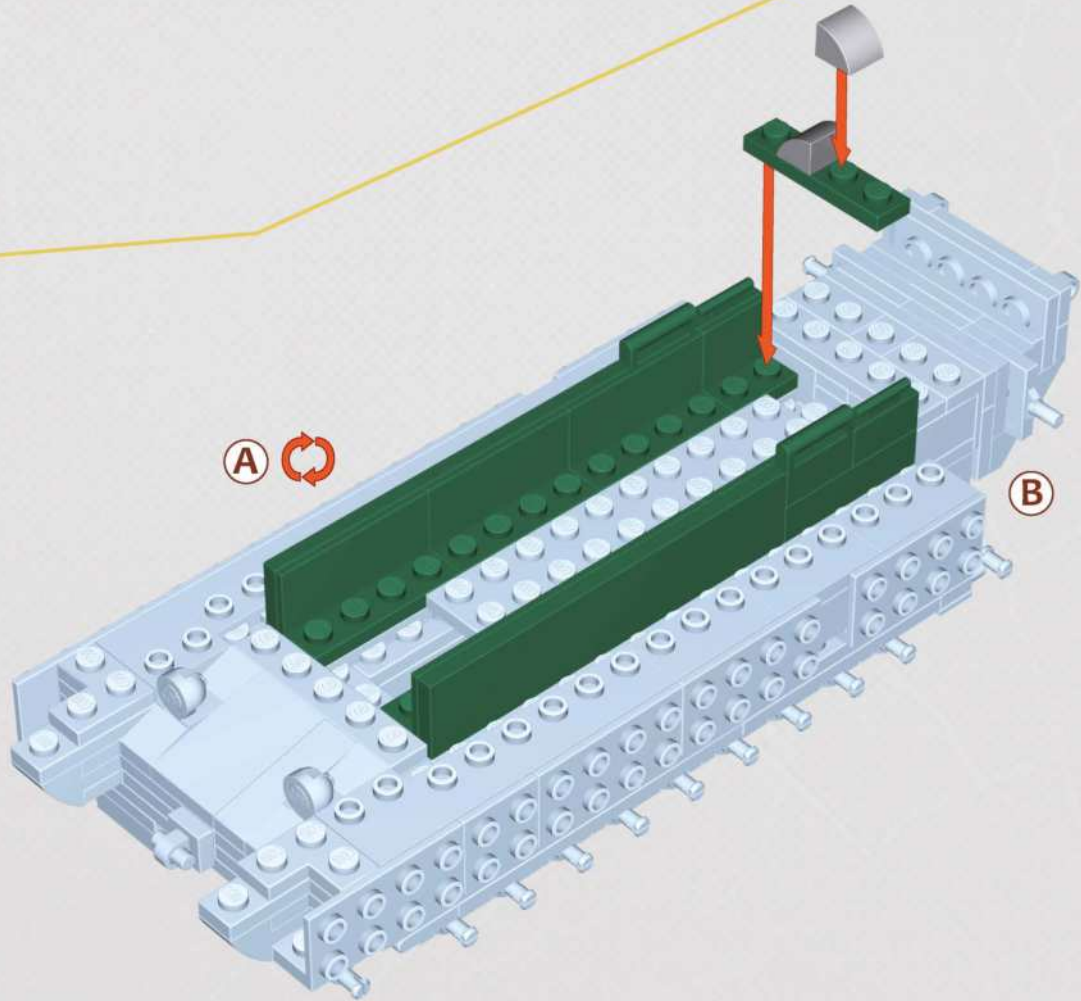

x1 x2

A yellow rounded rectangle containing one long green Technic Technic pin and one grey Technic pin, with the quantities 'x1' and 'x2' below them respectively.

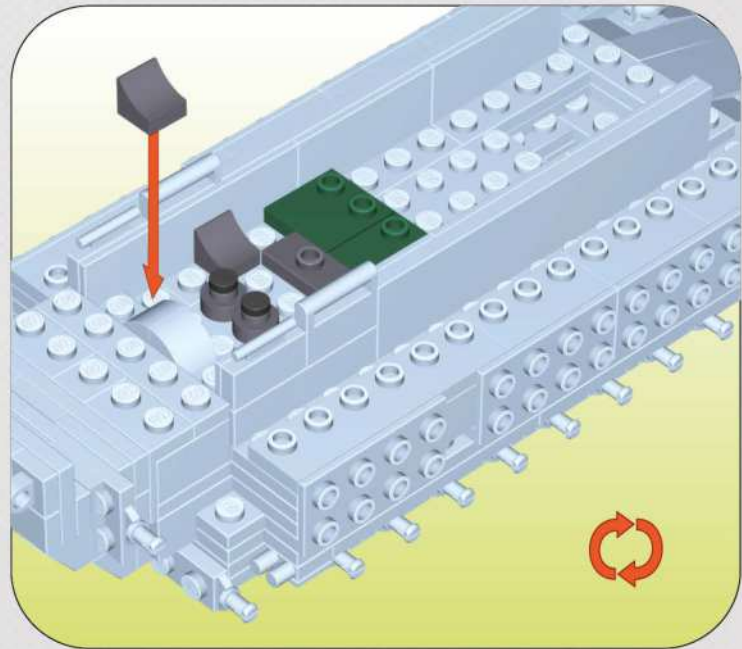
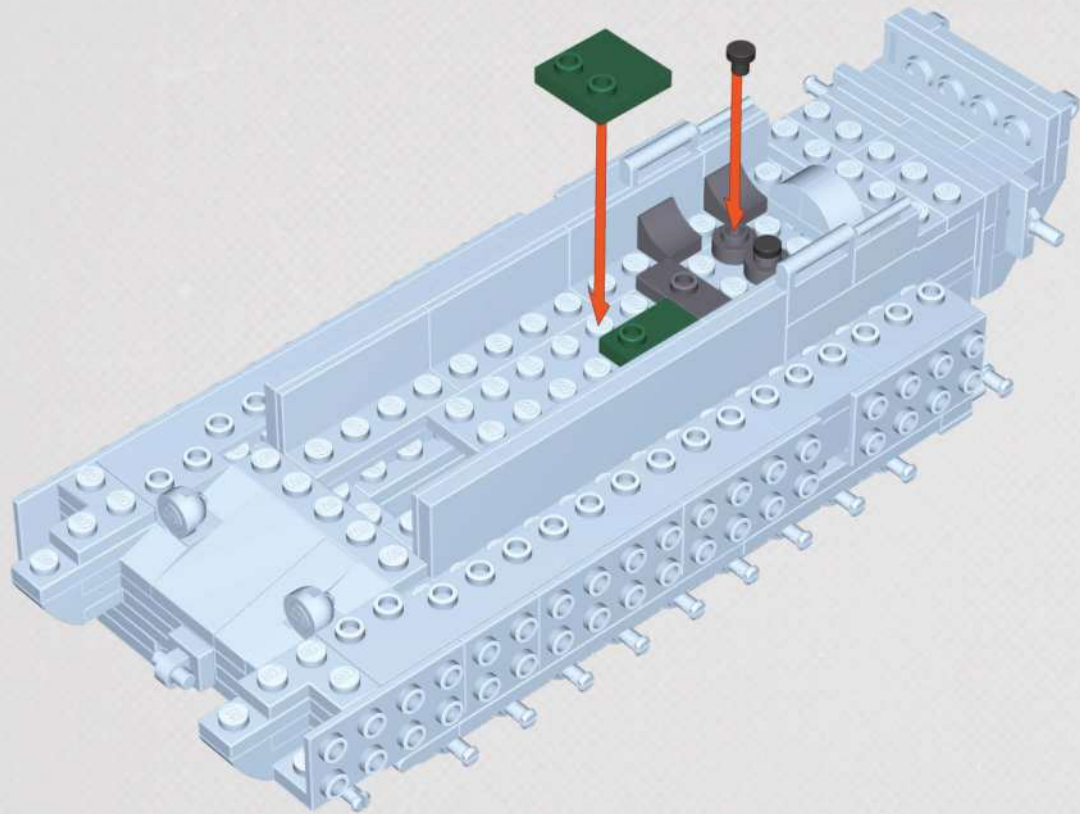

x1



x2



x2







x4

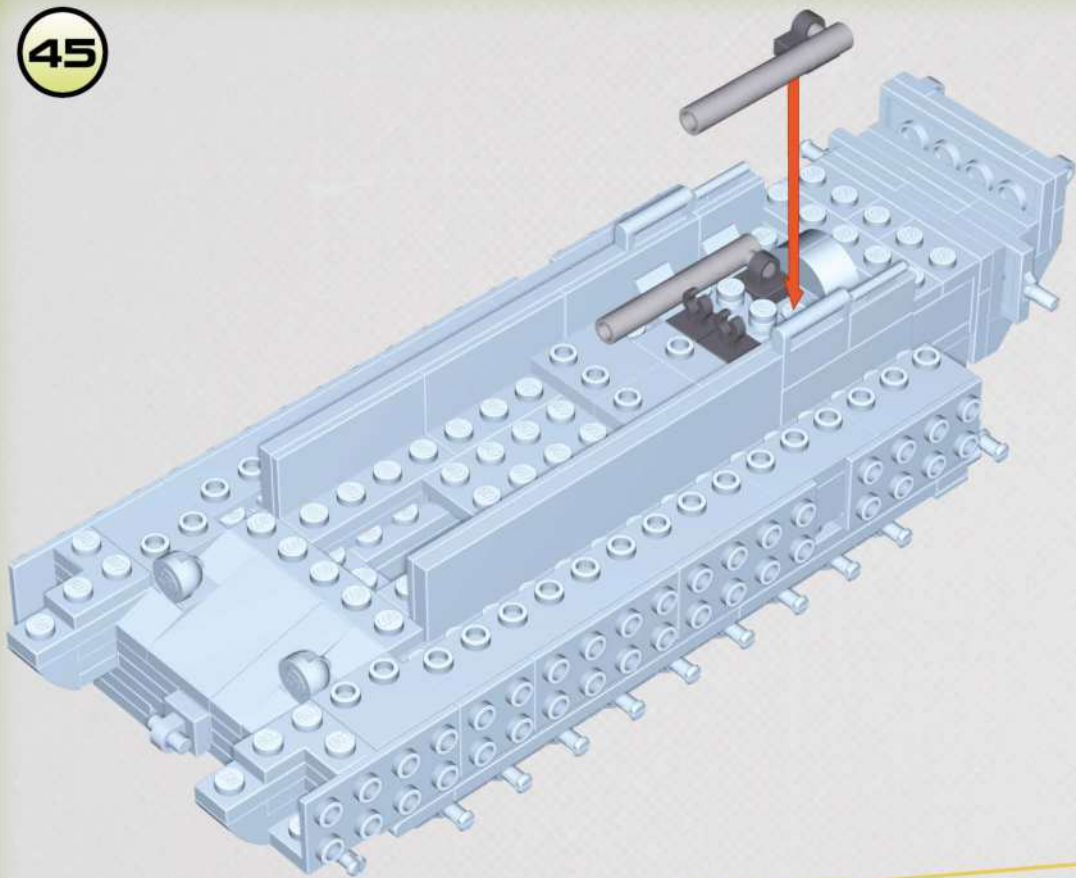

x2





45

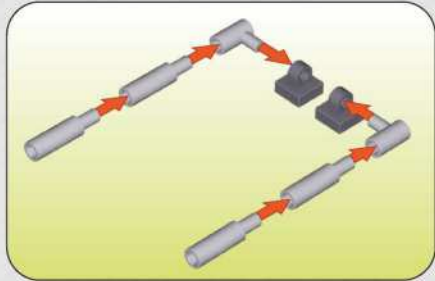

- 
x2

x2
- 
x2

x4

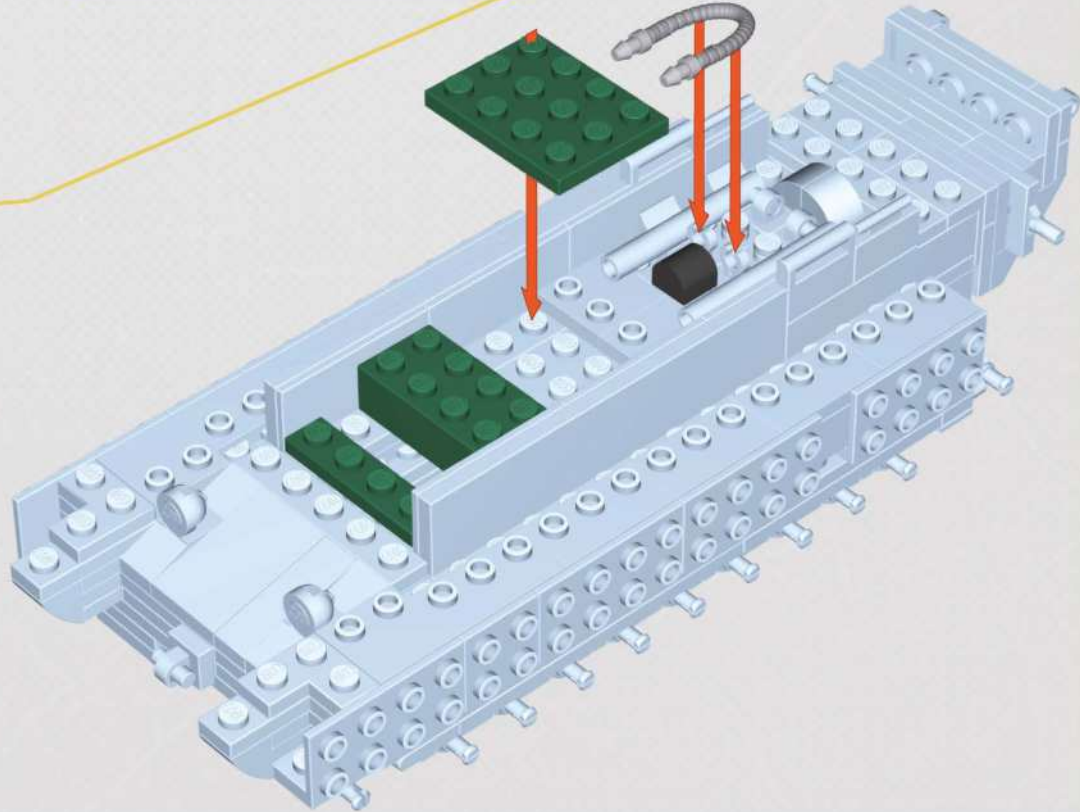

46

- 
x1

x1

x1
- 
x1

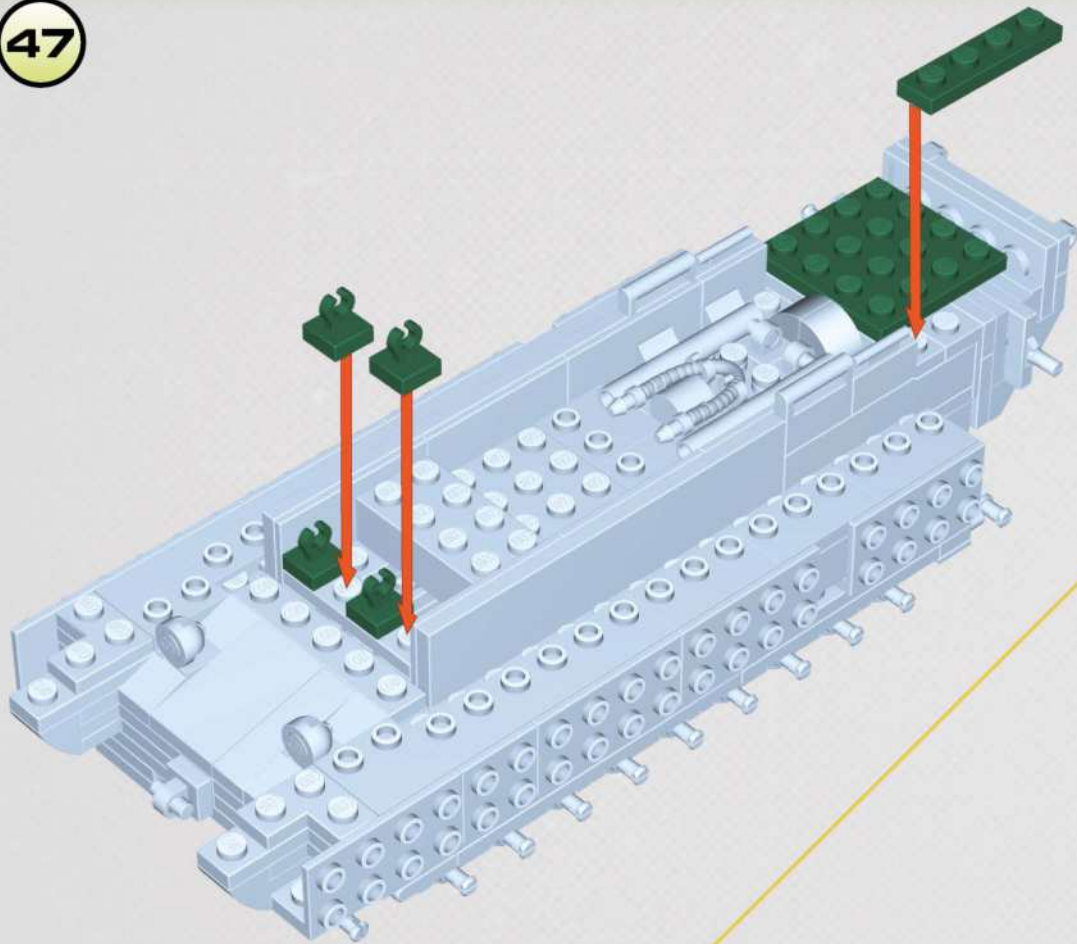
x1



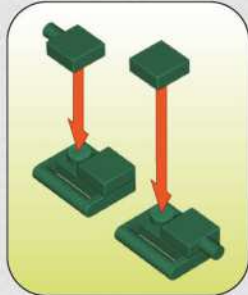





47



		
x1	x1	x4







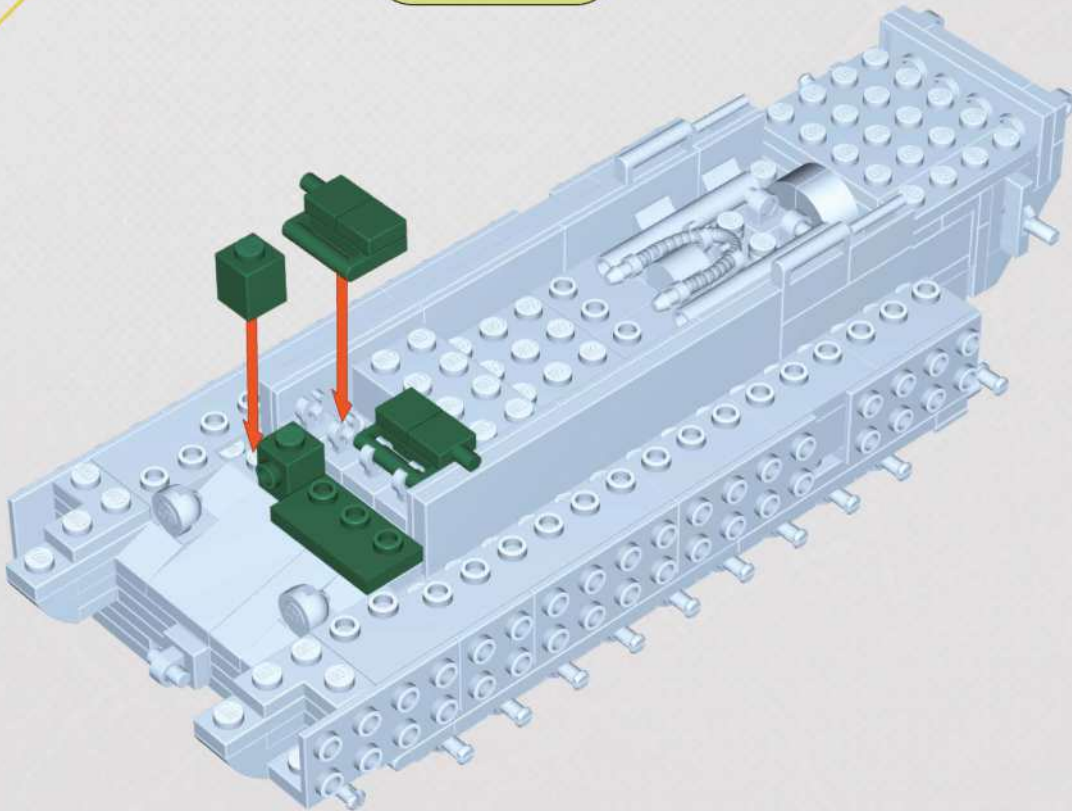

48

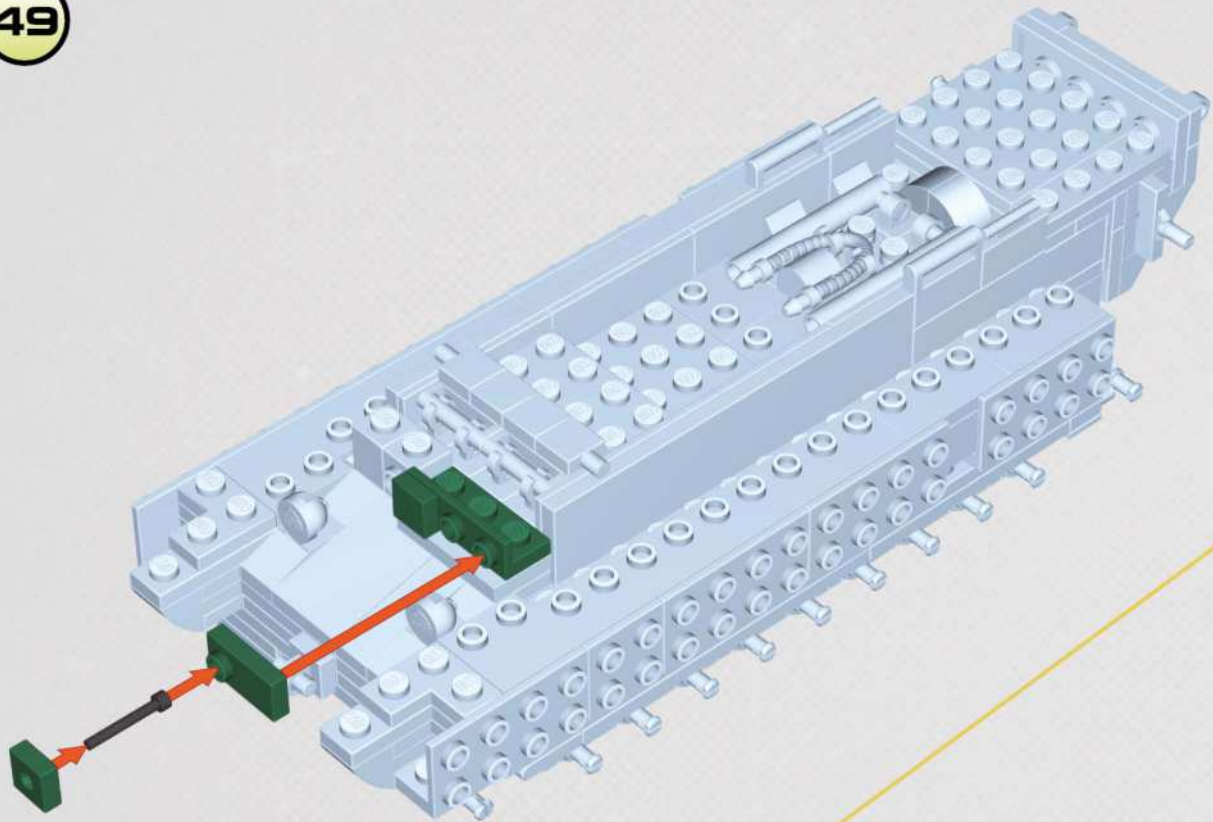
		
x1	x1	x1
		
x2	x2	x2







49



-  **x1**
 **x1**
 **x1**
-  **x1**
 **x1**

50

-  **x1**
 **x1**
-  **x1**
 **x1**

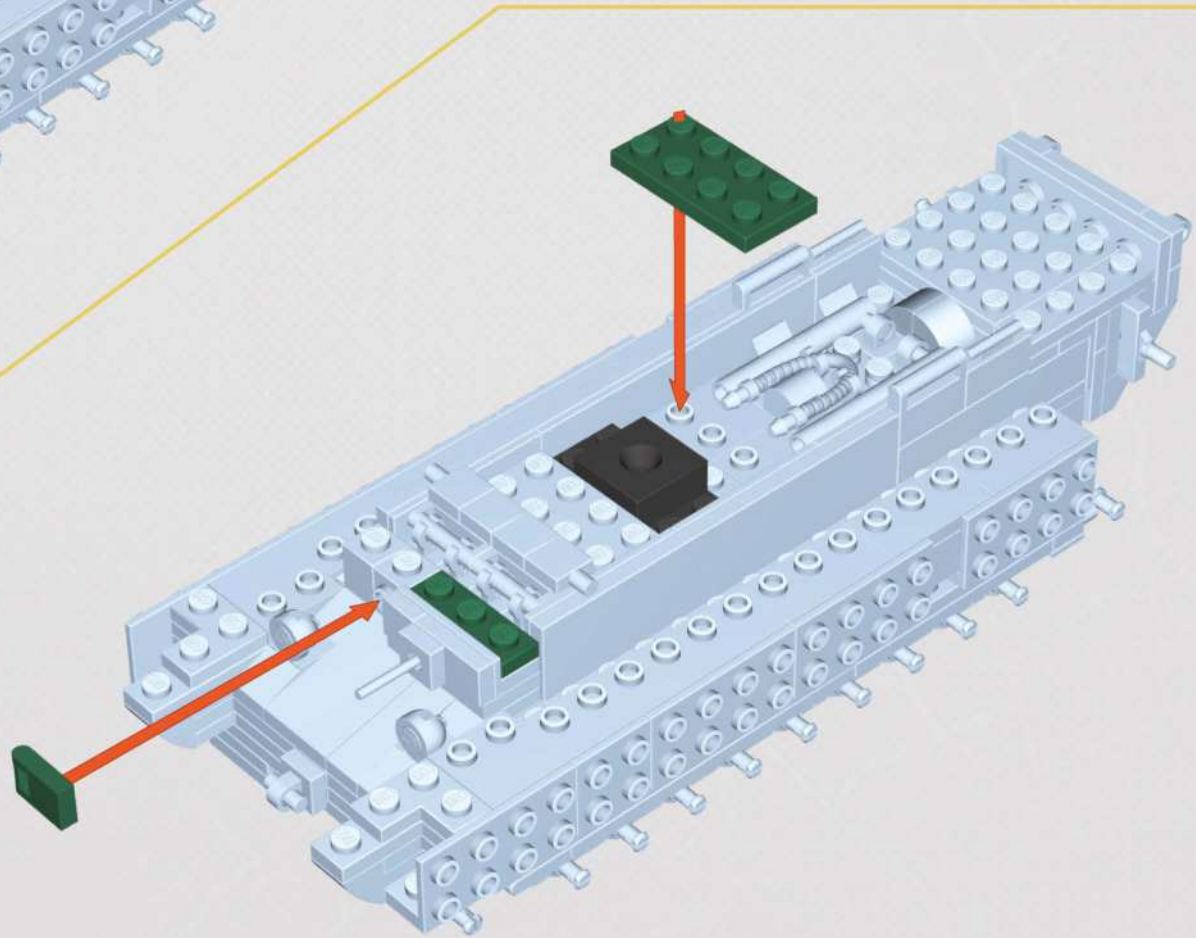



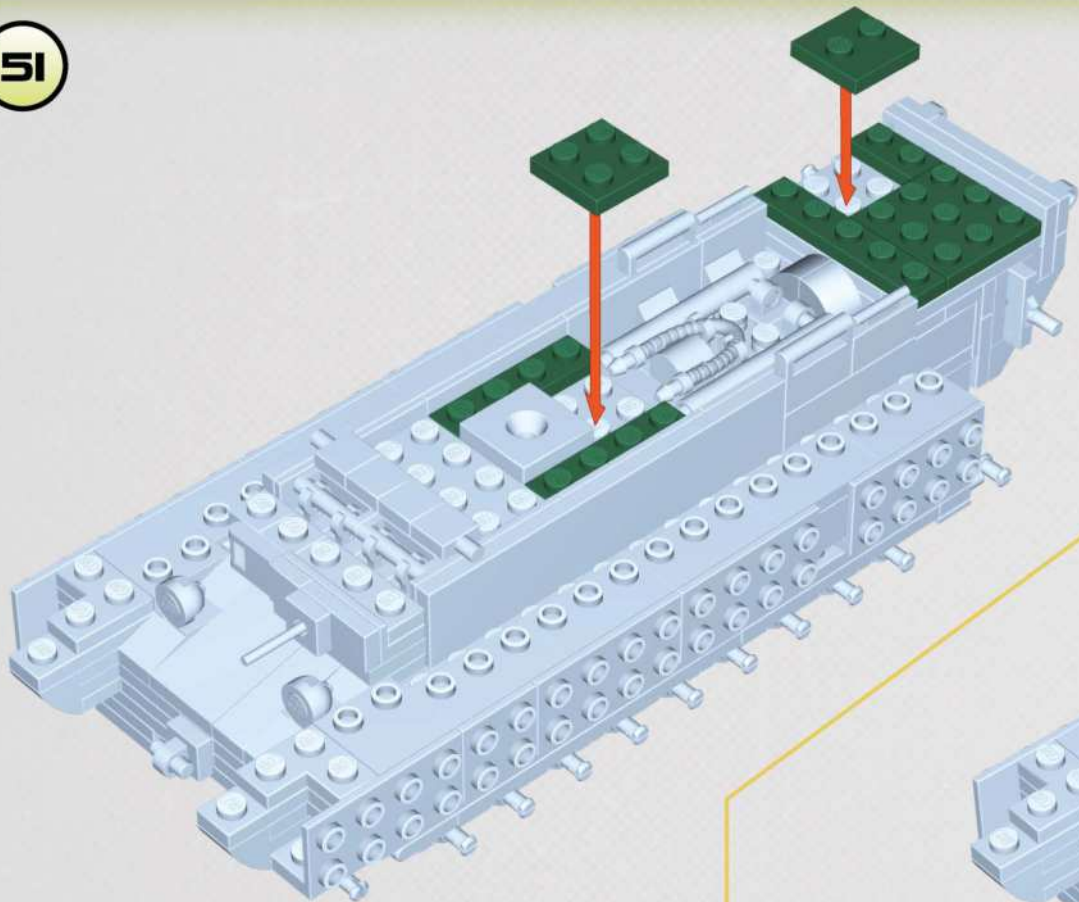

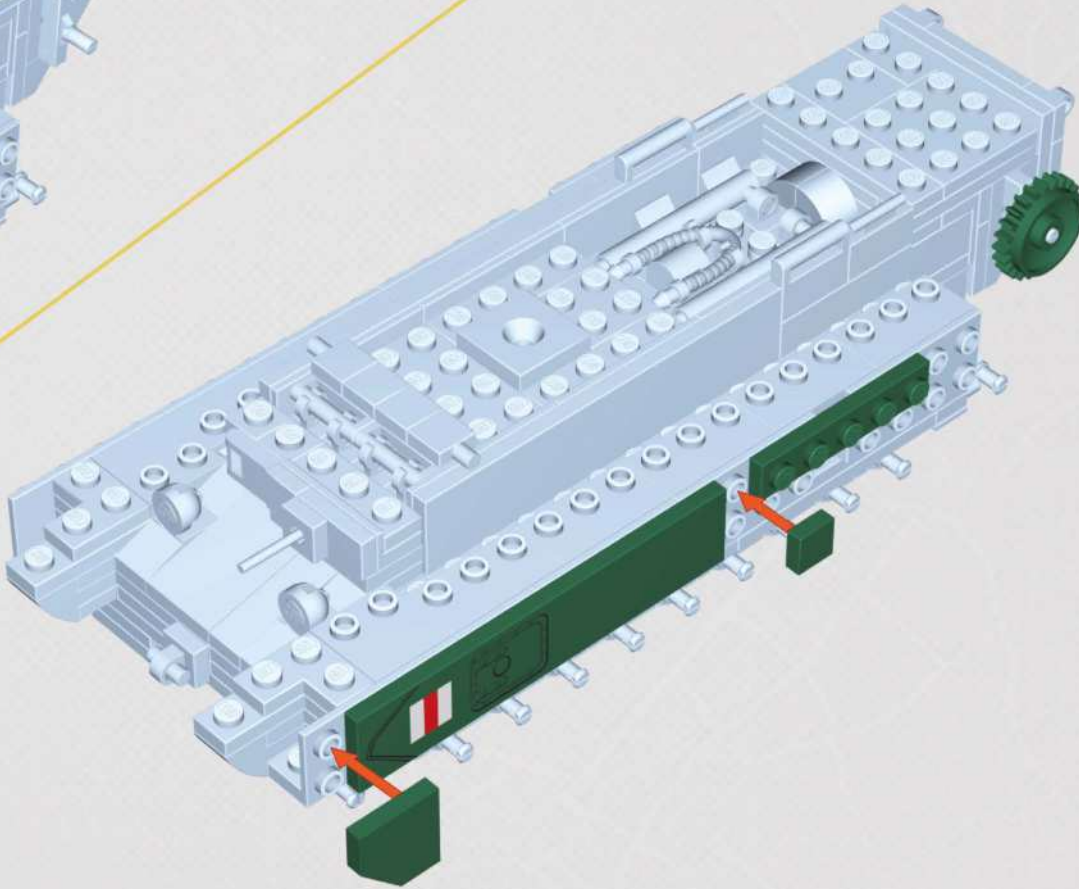

51



52



-  **x2**
-  **x1**
-  **x1**
-  **x1**
-  **x1**
-  **x1**

-  **x1**
-  **x1**
-  **x1**
-  **x1**
-  **x1**

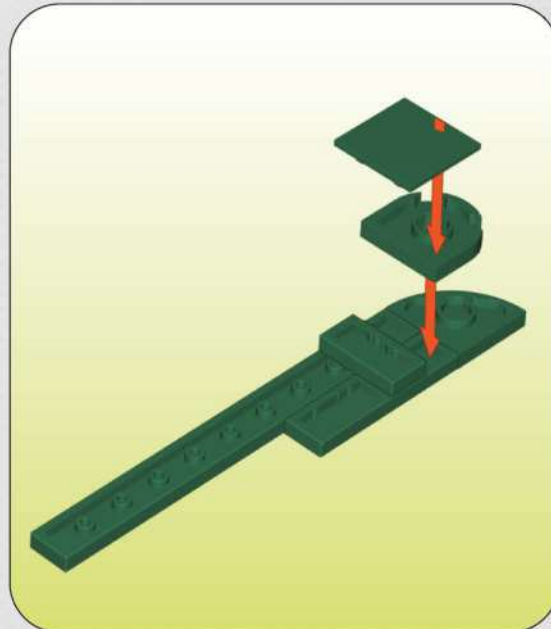
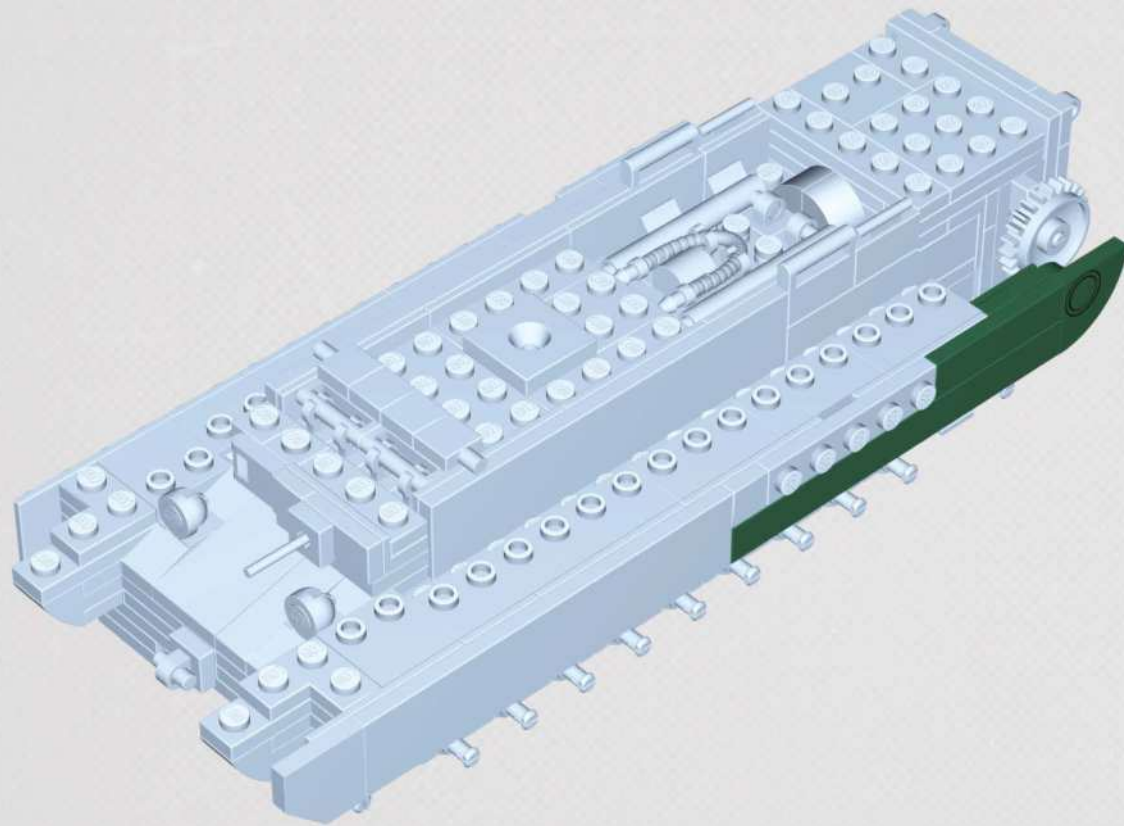

1:1

1:1



x1



x1



x1



x1



x1



x1

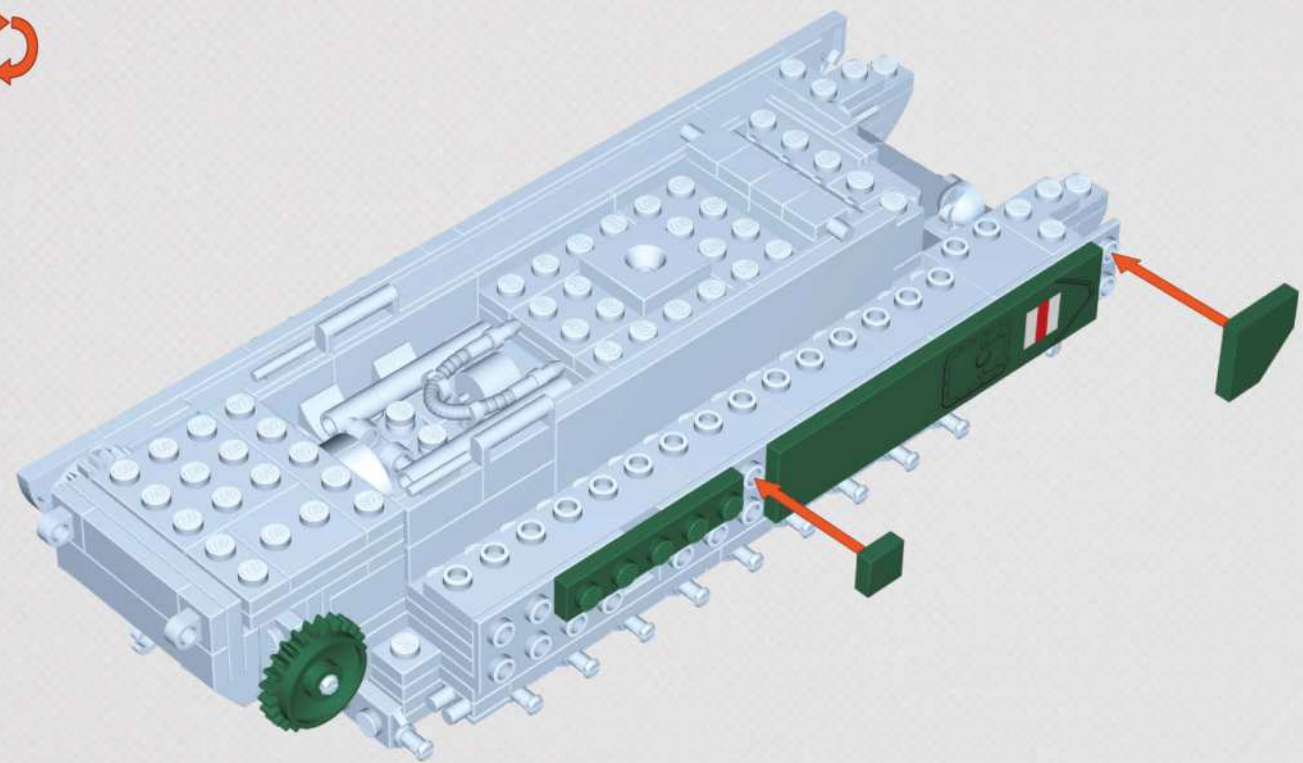

-  **x1**
-  **x1**
-  **x1**
-  **x1**
-  **x1**

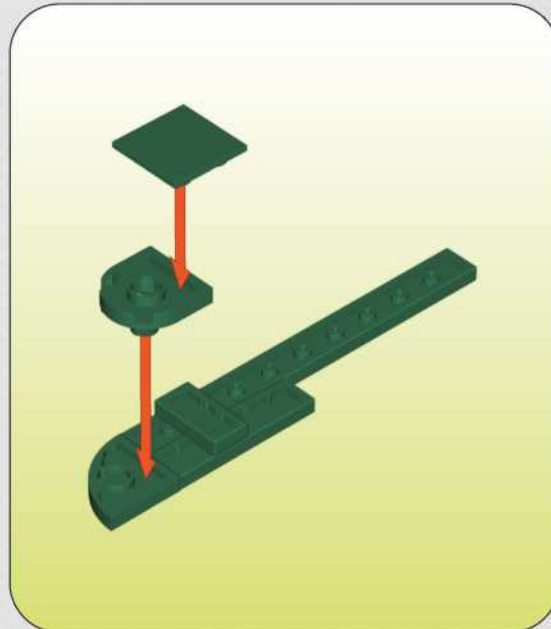
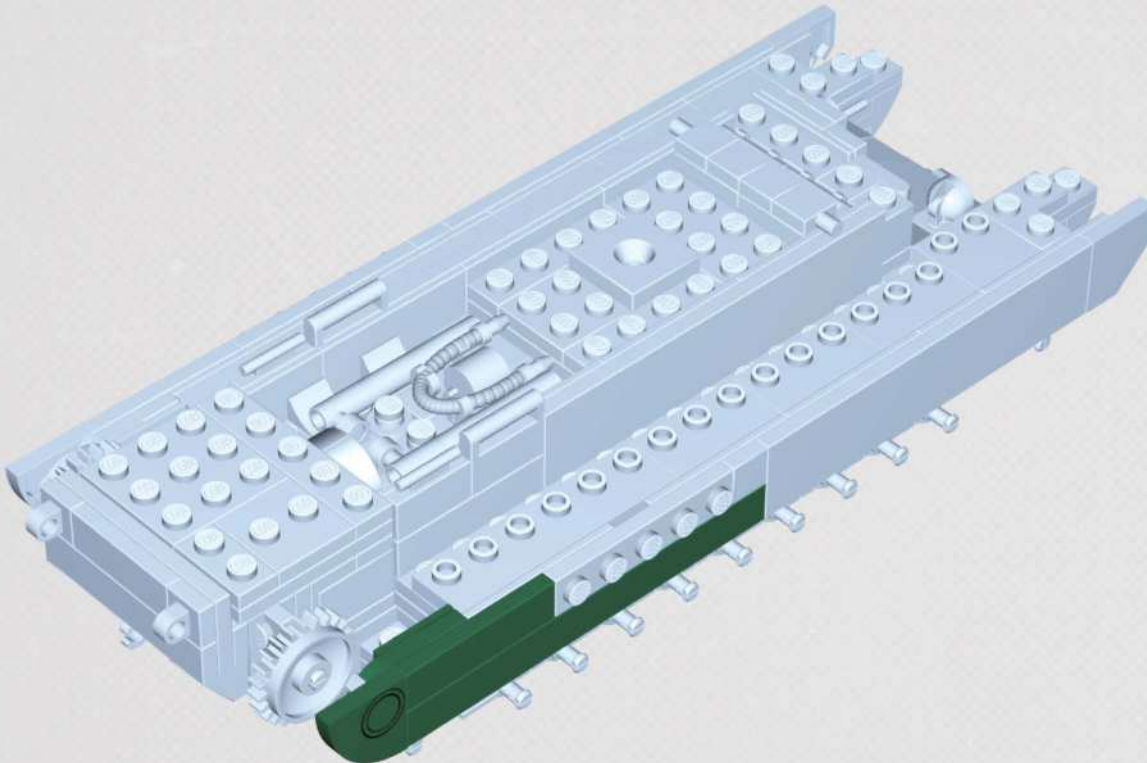

1:1

1:1



x1



x1



x1



x1



x1



x1

56



2

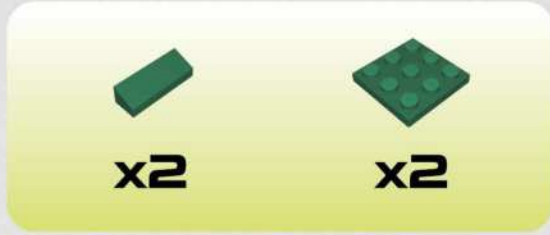
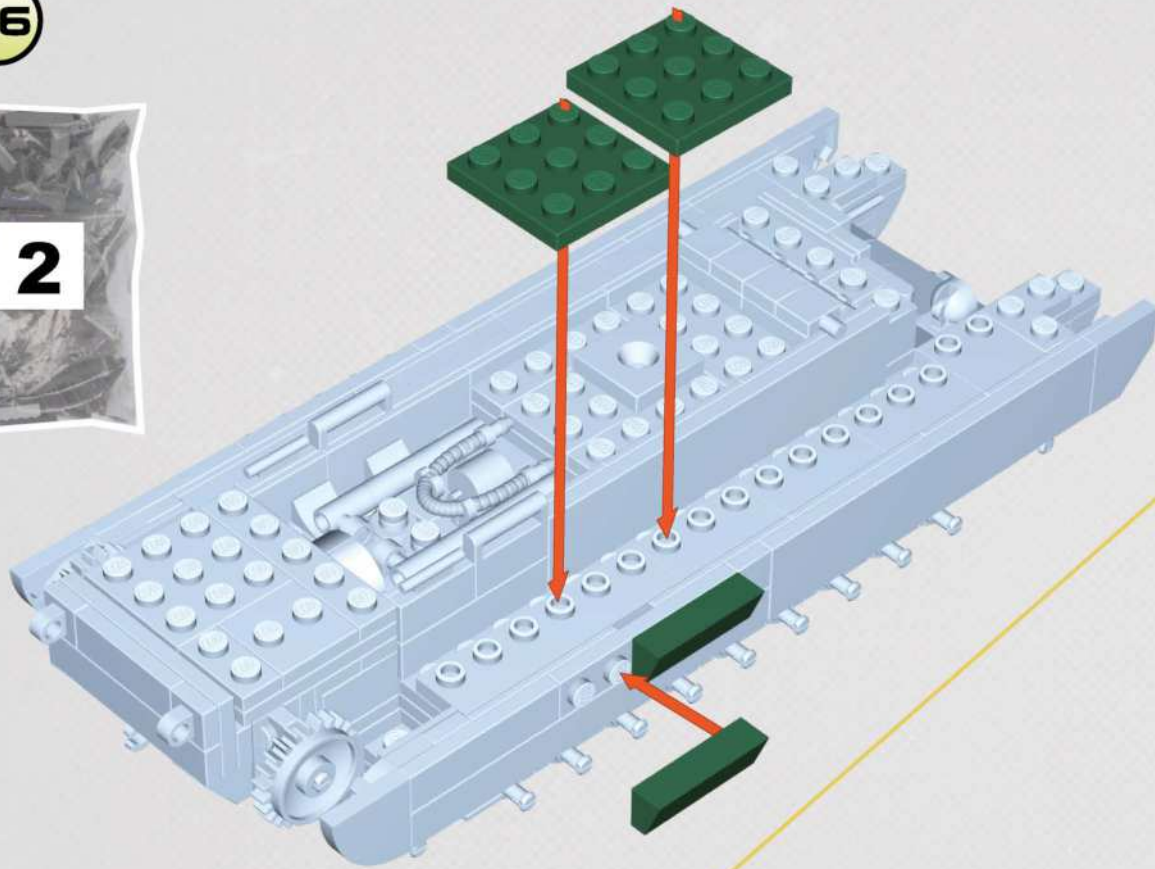

x2

x2

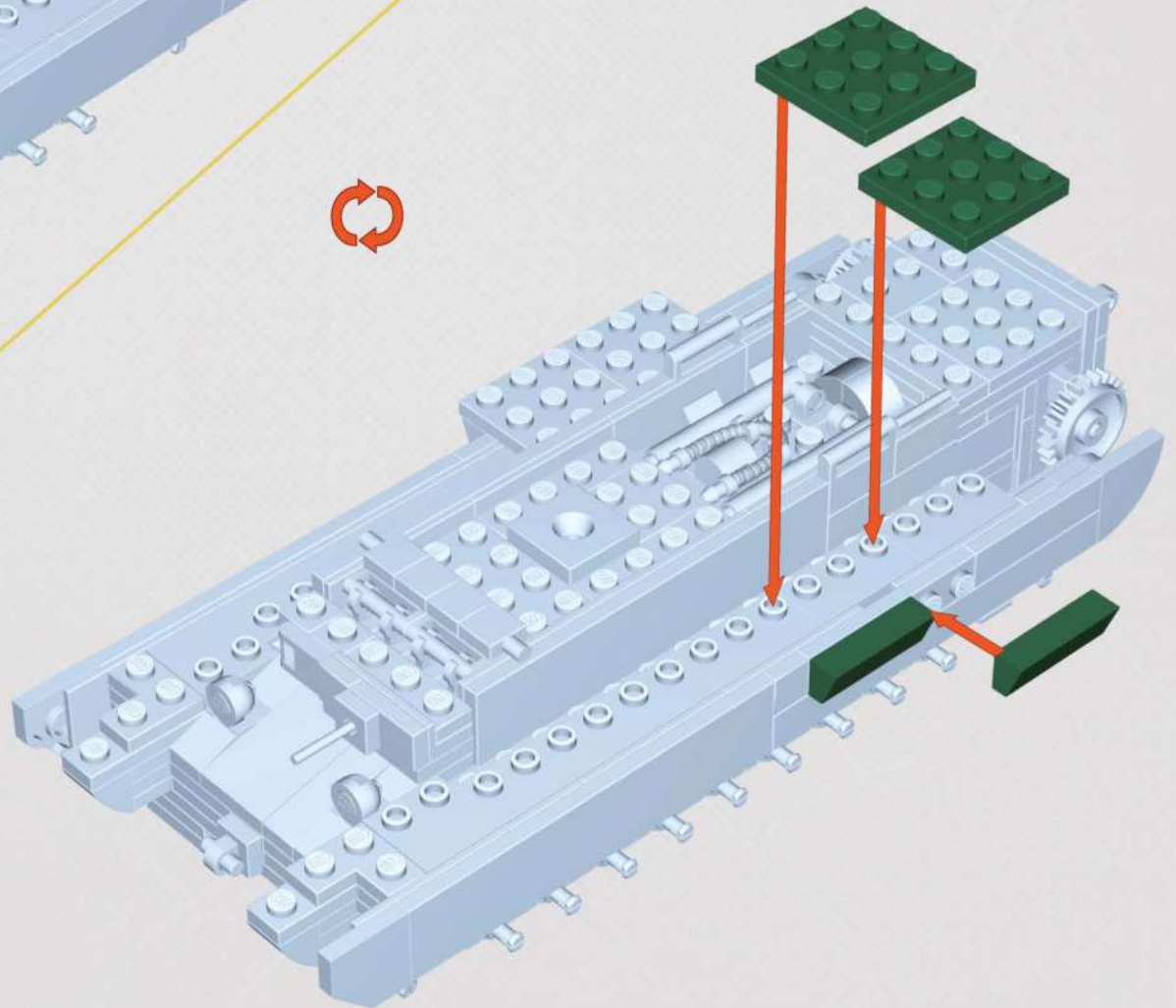

57

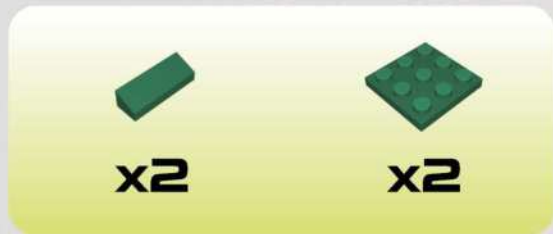

x2

x2

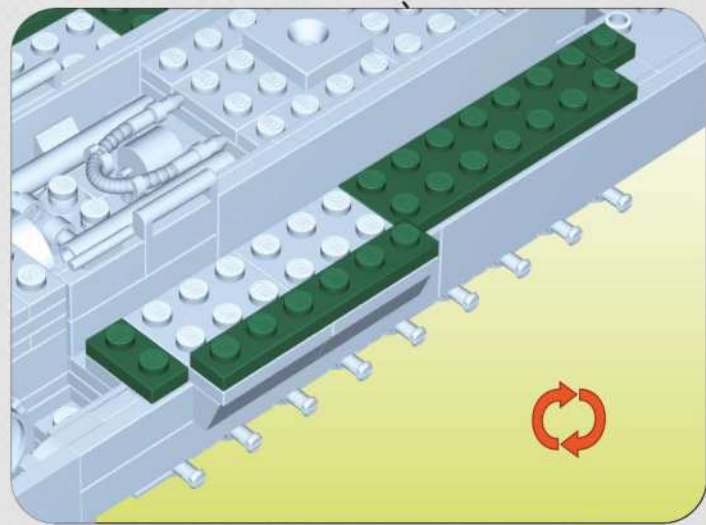
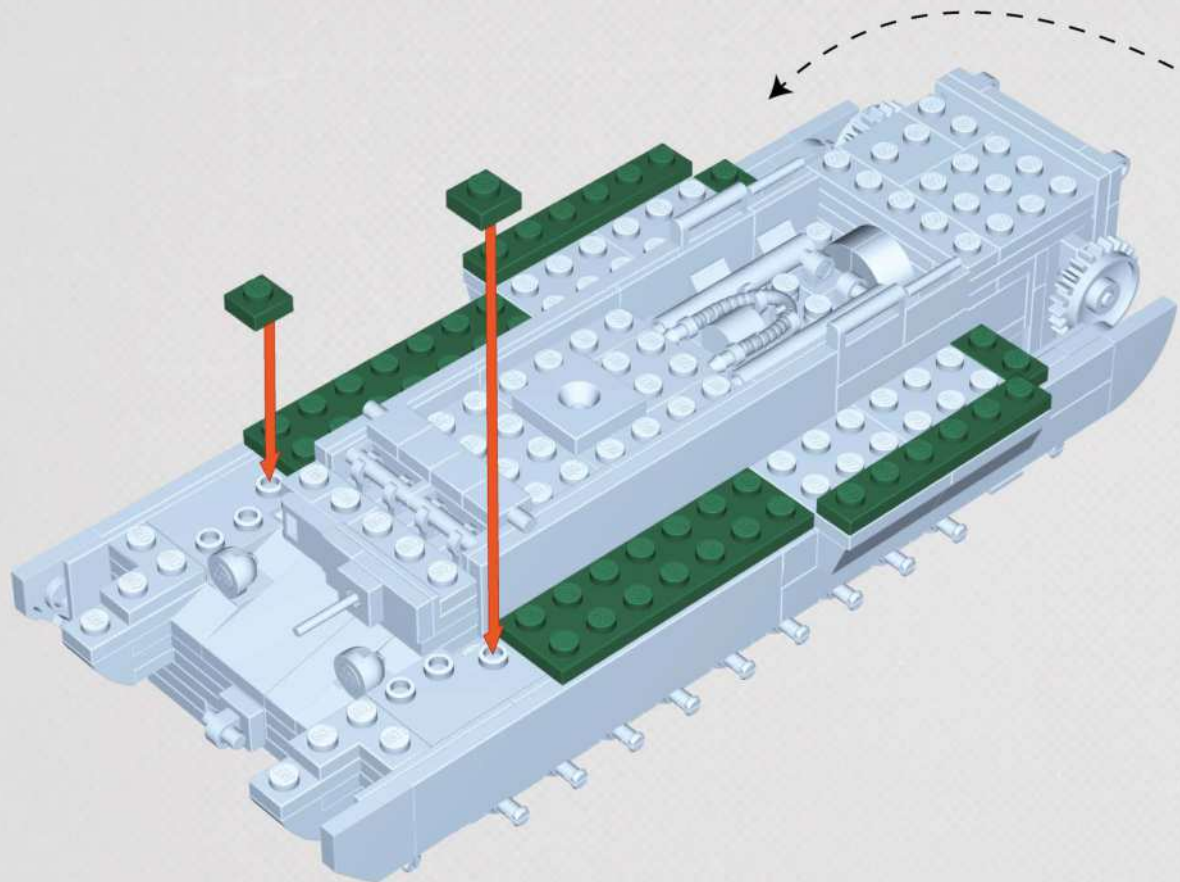

x2



x2



x2



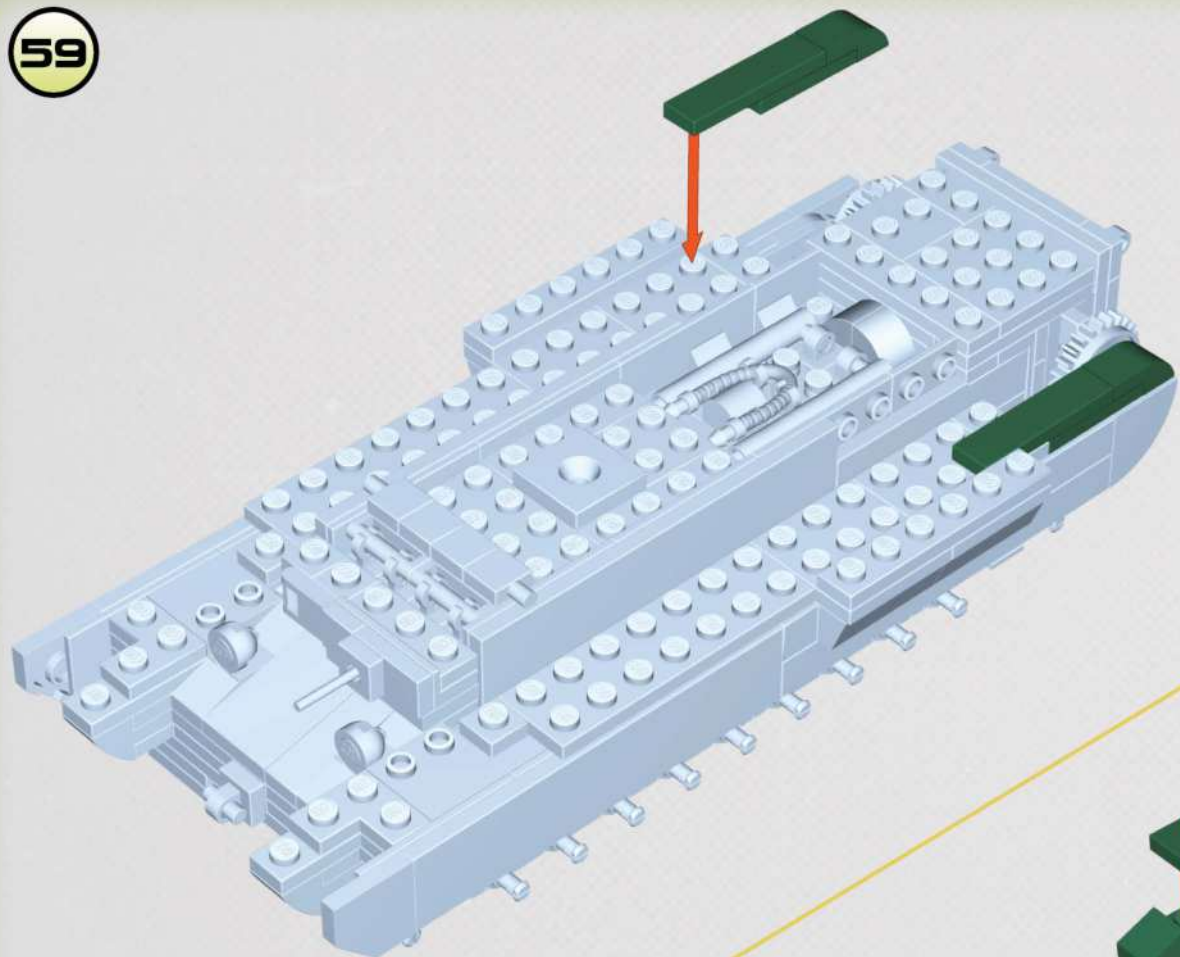

x2

59







1:1

		
x2	x2	x2



60

	
x2	x2
	
x2	x1

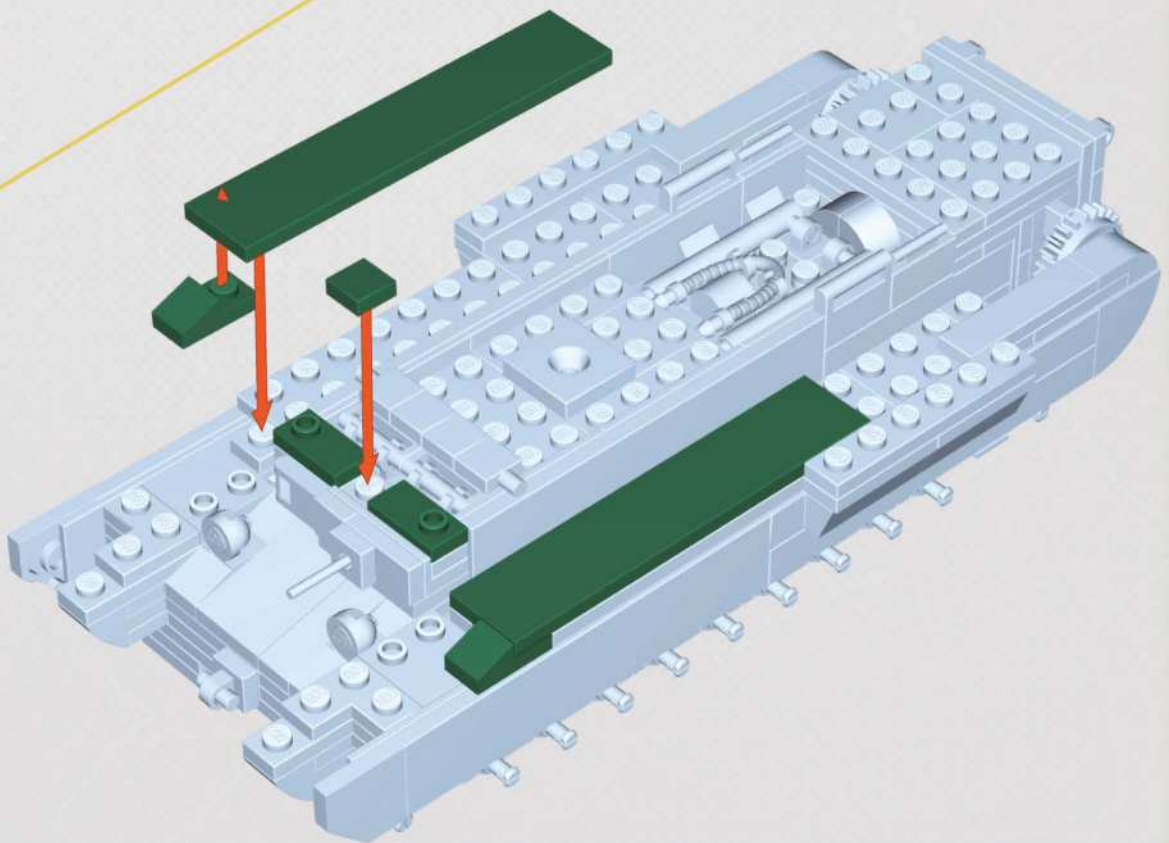

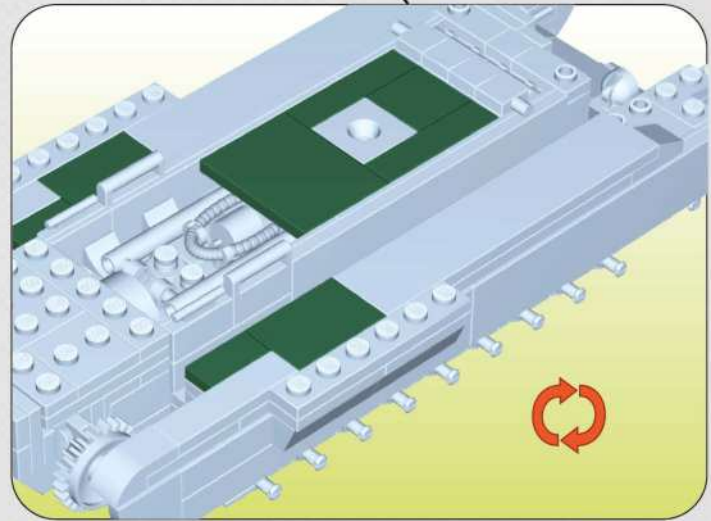
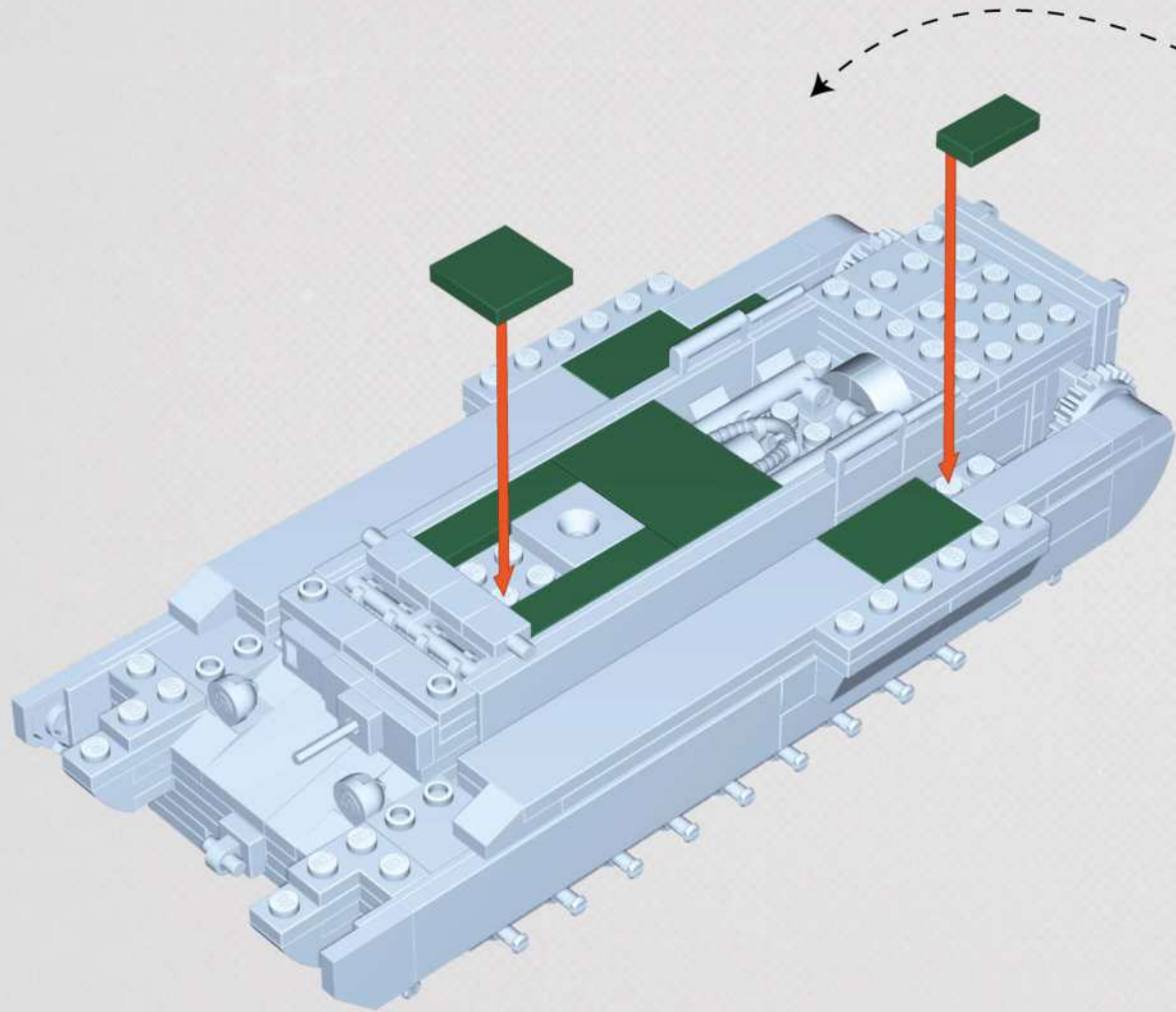

1:1

1:1



x1



x2



x2



x2



x1

62

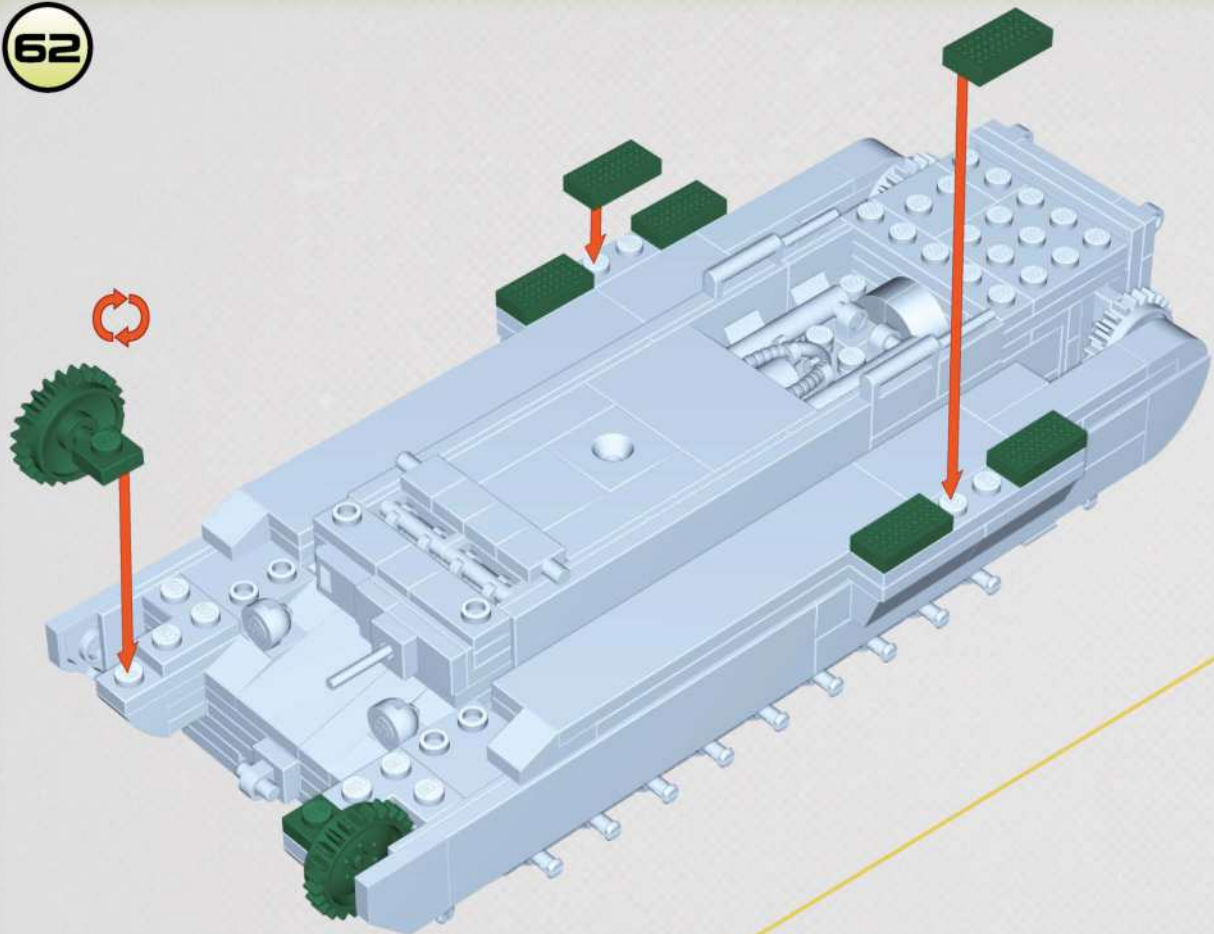

		
x2	x2	x6





x2

63

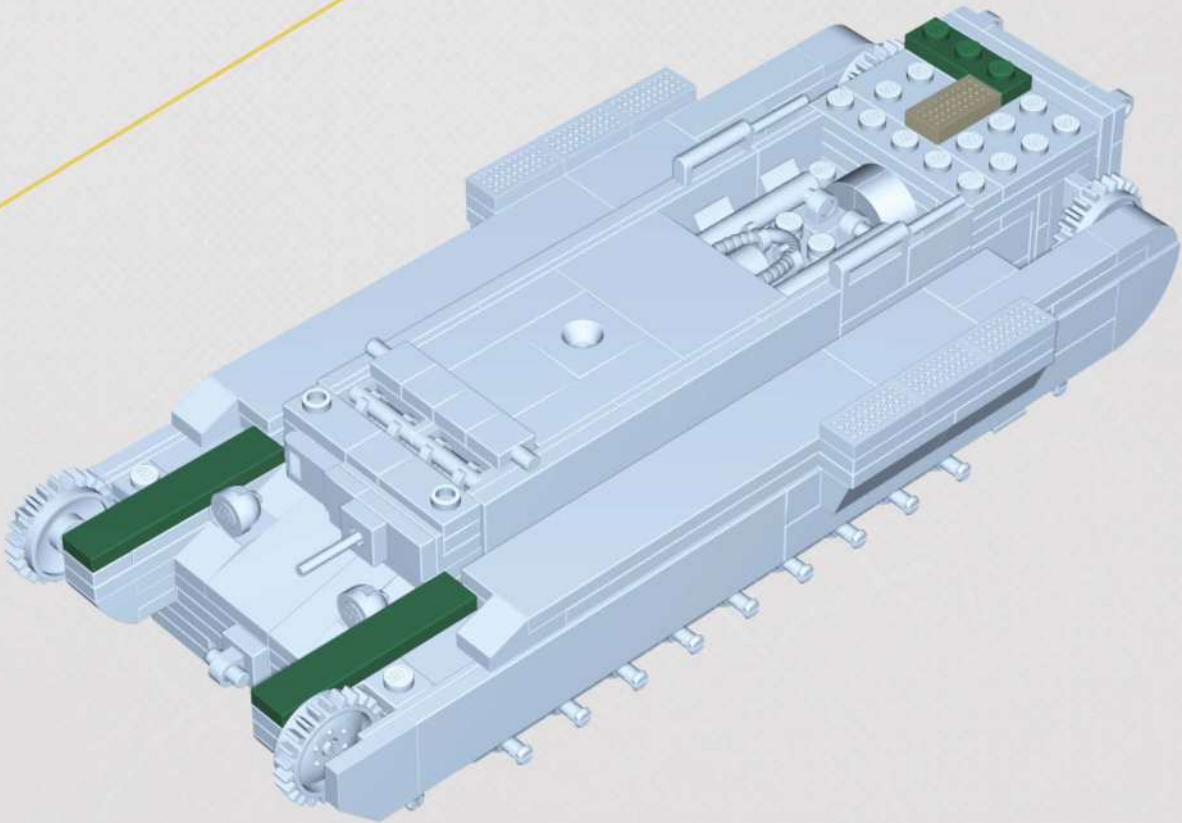
1:1



		
x2	x1	x1

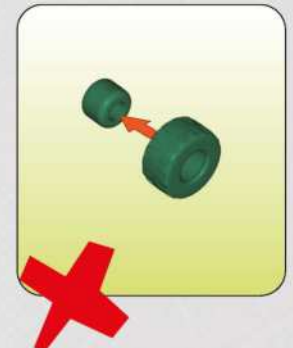
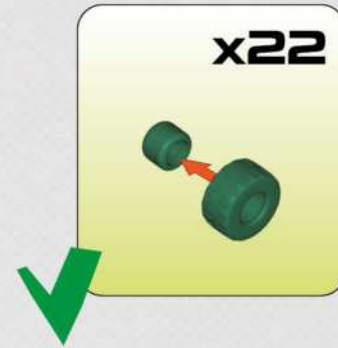
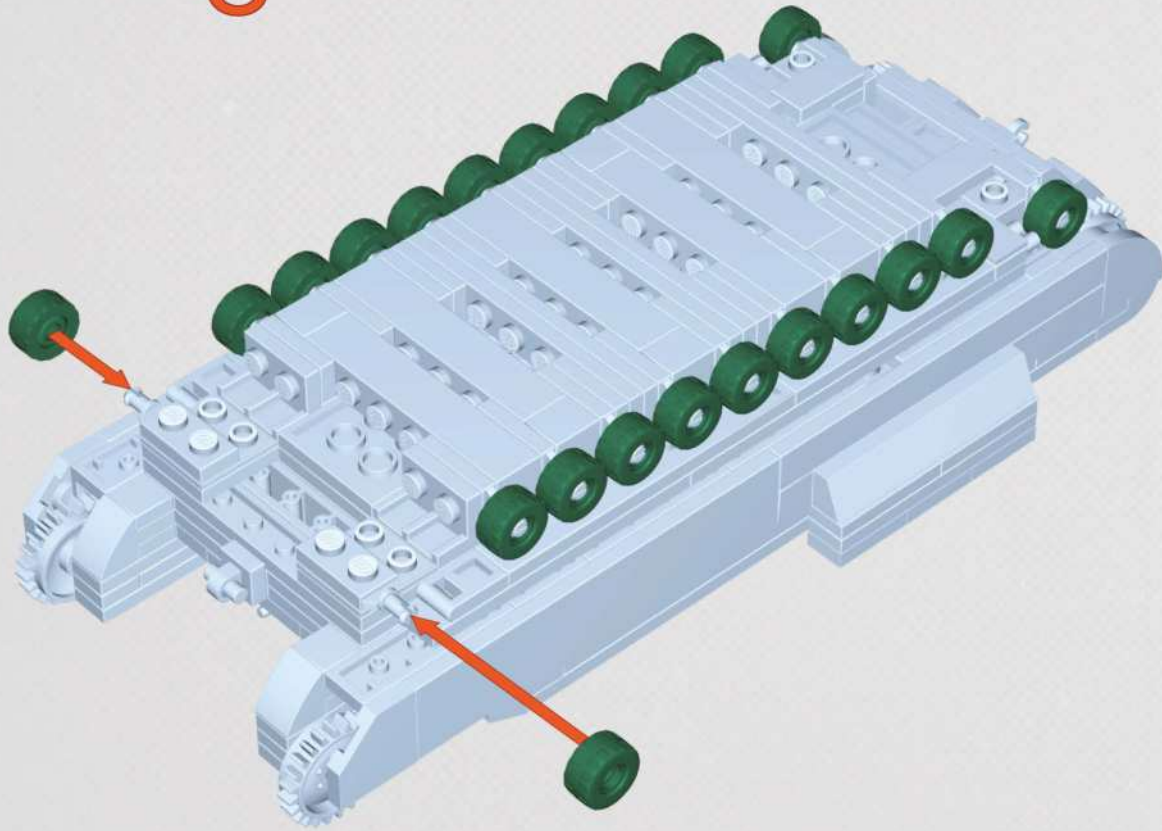

65

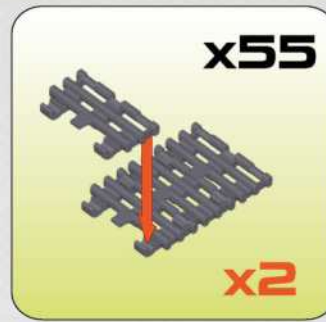
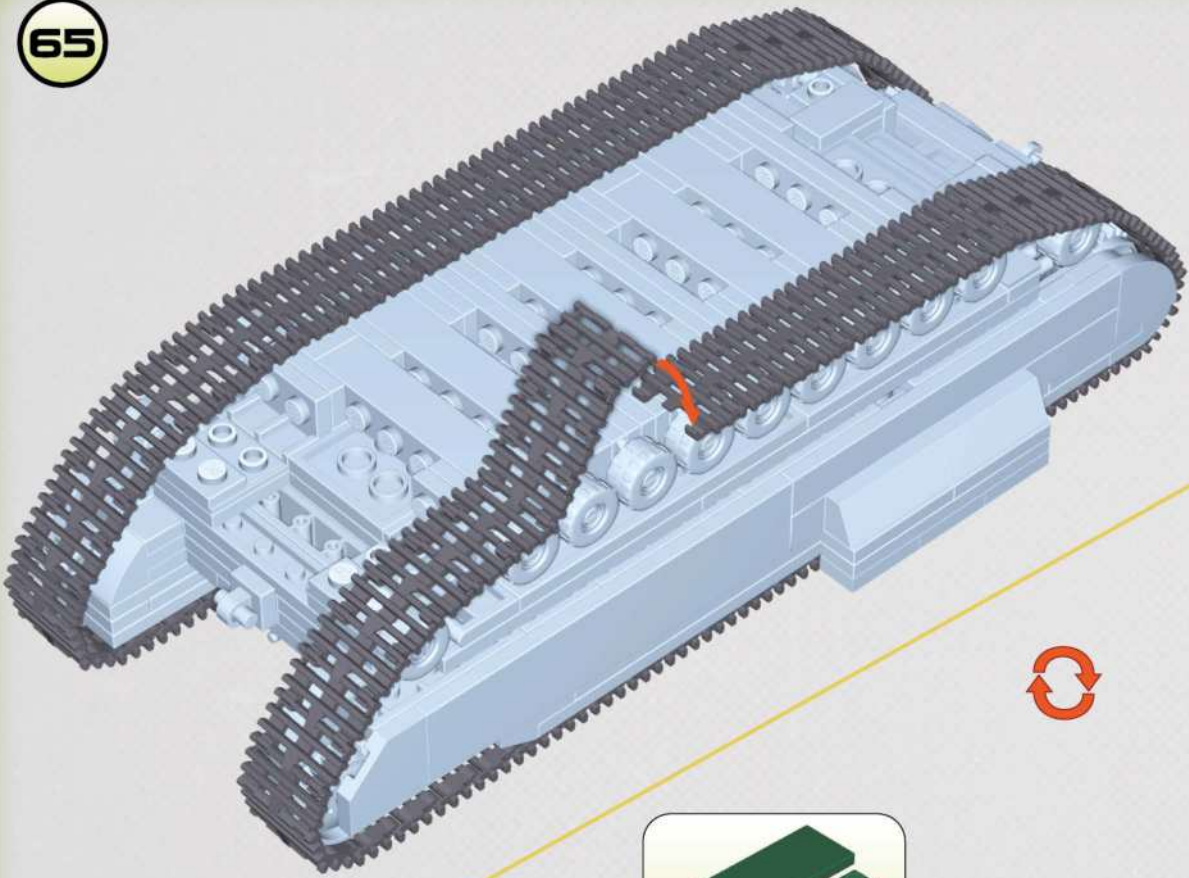

66

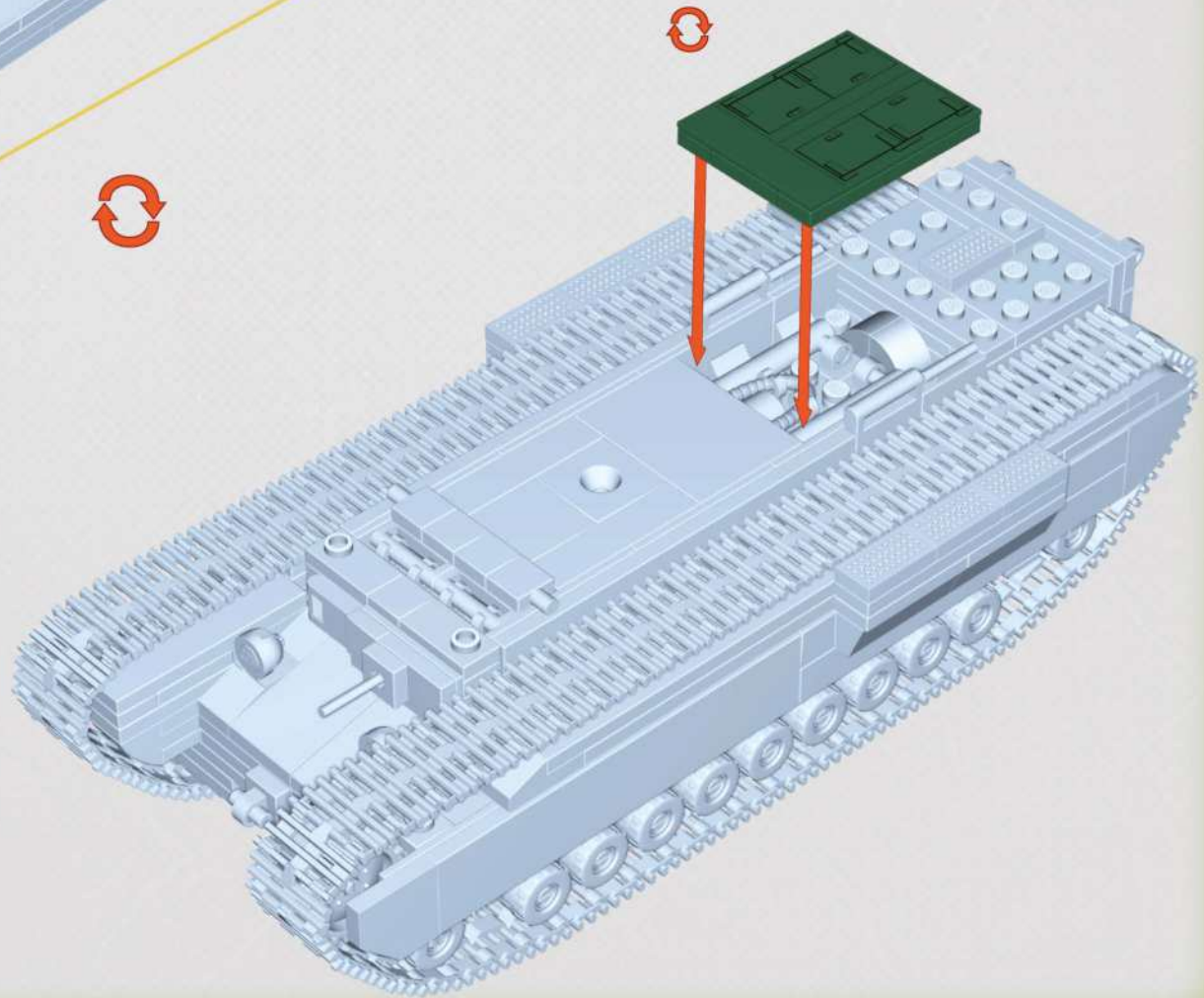
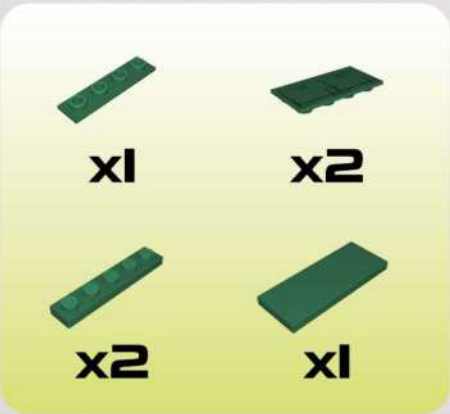

67

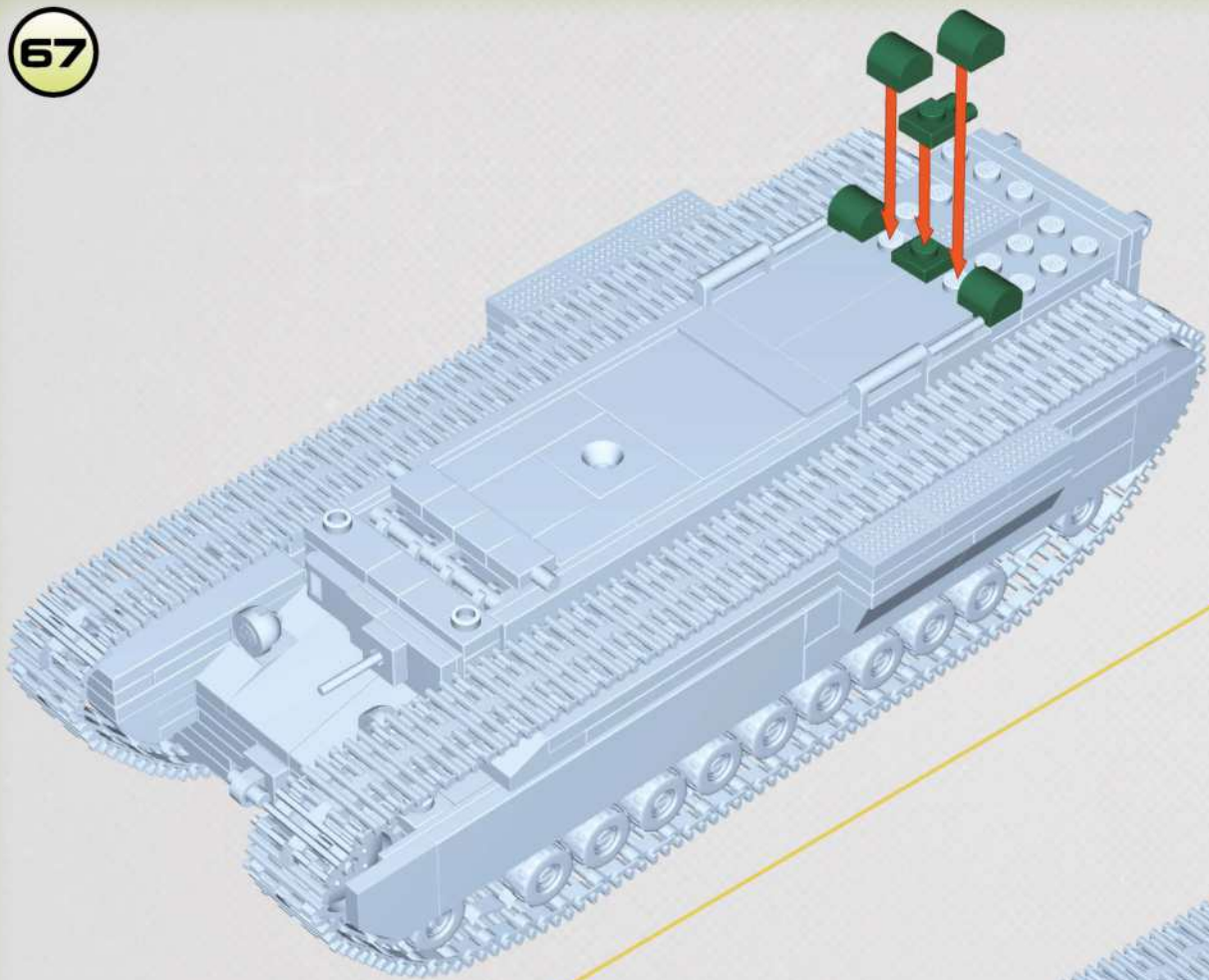

Legend for step 67:

- Green 1x2 pin: x1
- Green 1x1 pin: x4
- Green 1x2 pin with hole: x1

68

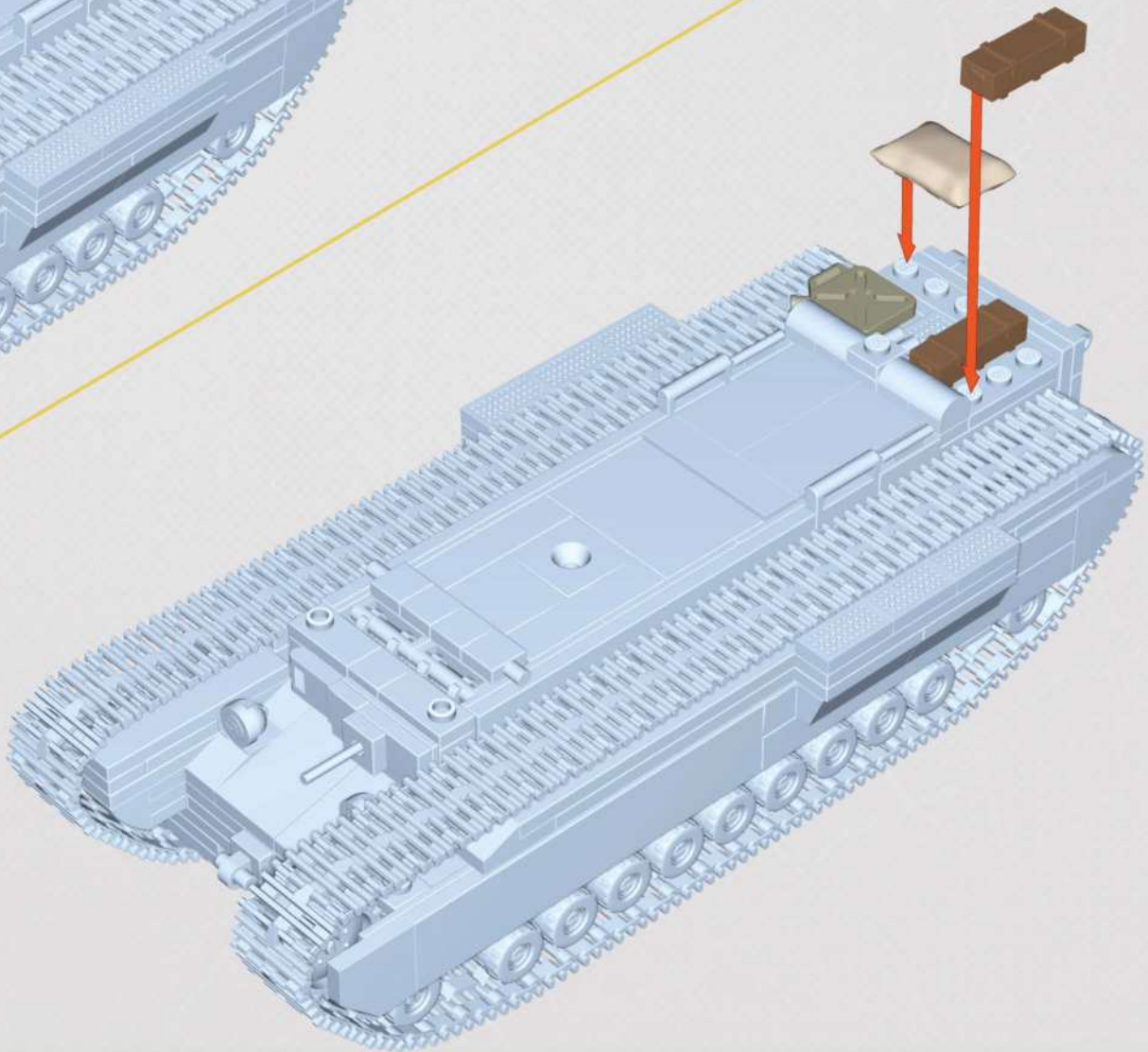

Legend for step 68:

- Tan 1x4 plate: x1
- Brown 1x2 brick: x2
- Brown 1x2 brick with hole: x1

69

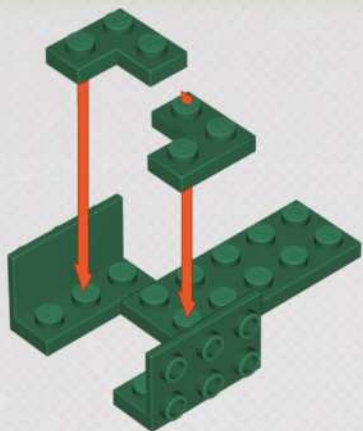

x1



x2



x2

70

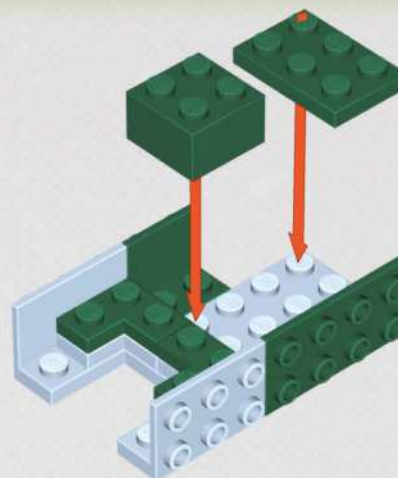

x2



x1



x1



x1



x1

71

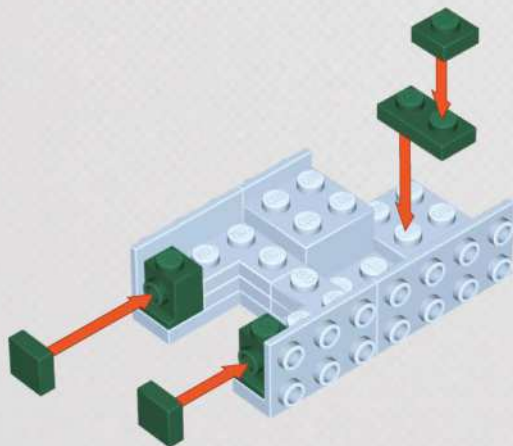

x2



x2



x1



x1

72

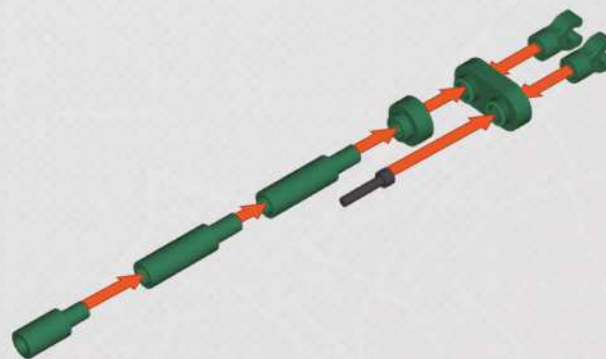

x2



x1



x1



x2



x1



x1

73

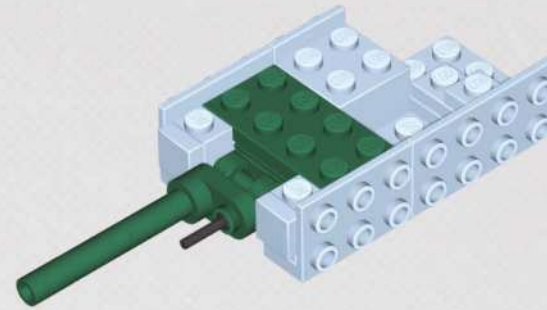
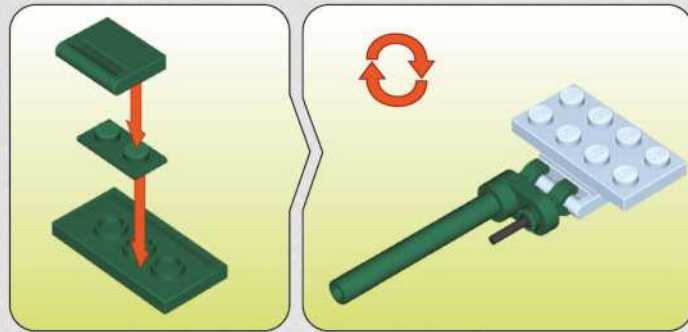

74

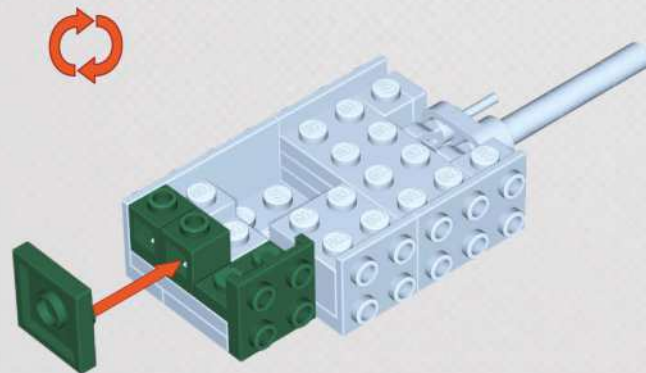

75

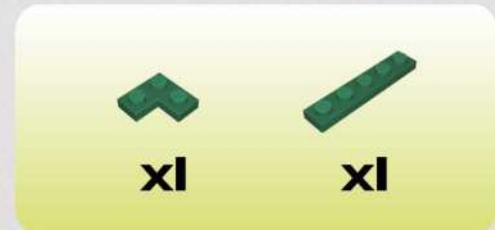
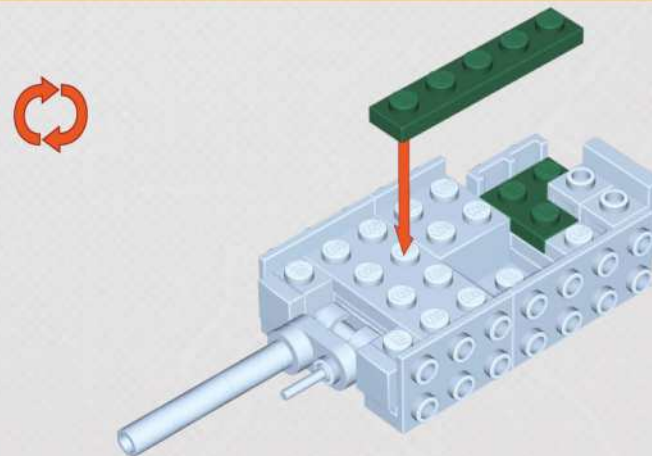

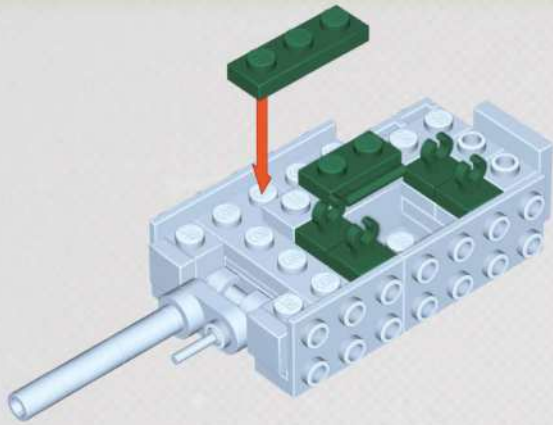

76

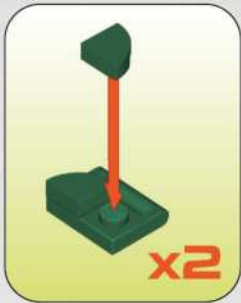

 **x4**
  **x1**
  **x1**

77





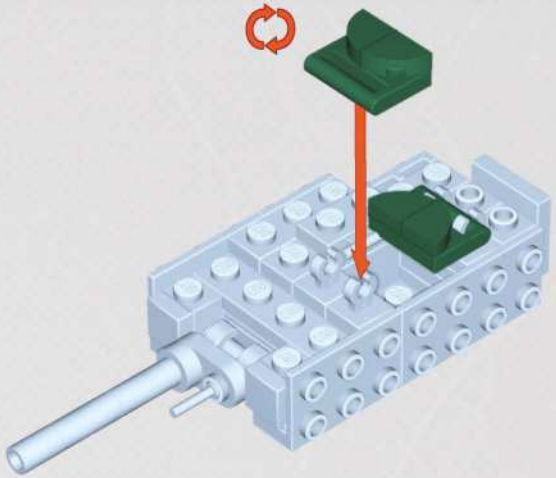

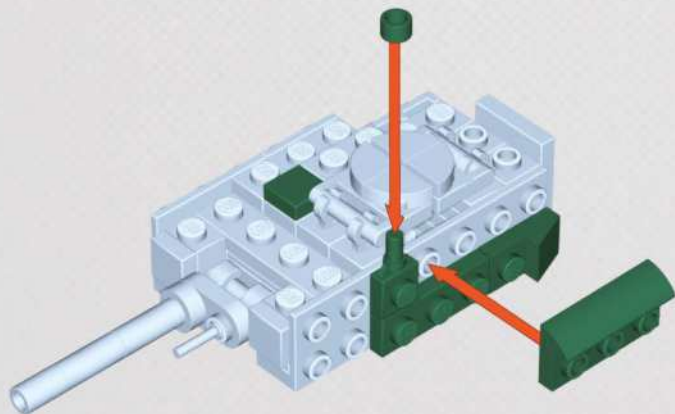

 **x2**
  **x4**







78

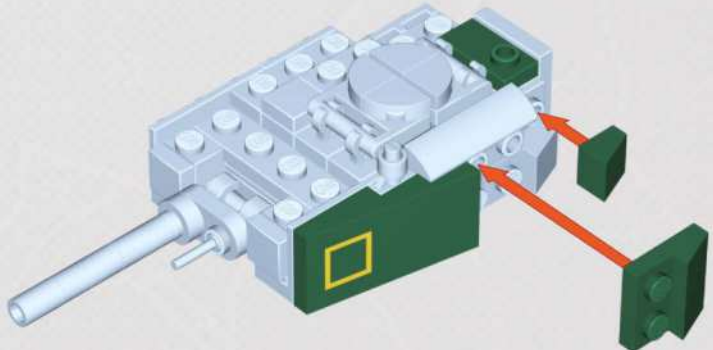

 **x1**
  **x1**
  **x1**
  **x1**
  **x1**
  **x1**

79



 **x1**
  **x1**
  **x1**
  **x1**

80

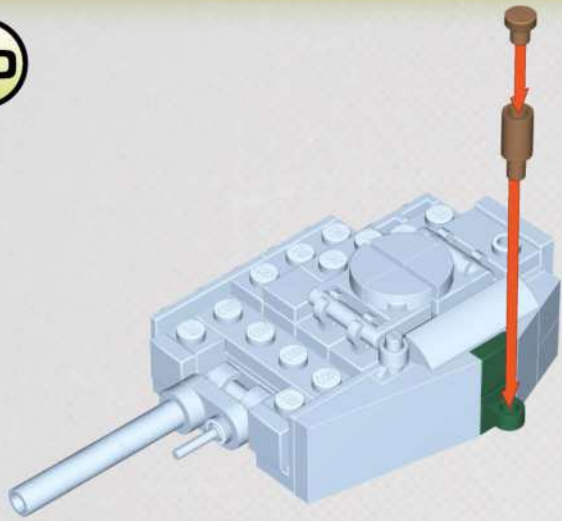

x1



x1



x1



x1

81

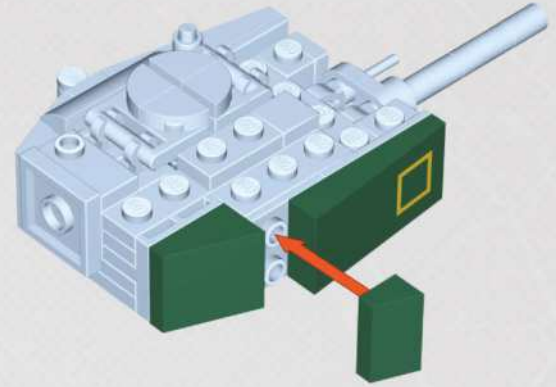

BE CAREFUL: NOTICE THE DIFFERENCE

A



B



x1



x1



x1

82

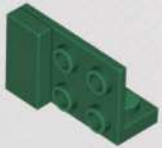

x1



x1

83

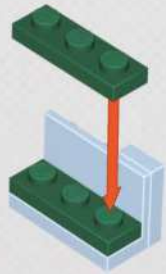

x2

84



x1



x1

85

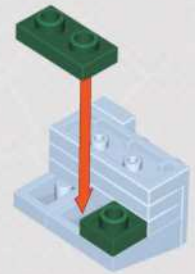

x1



x1

86

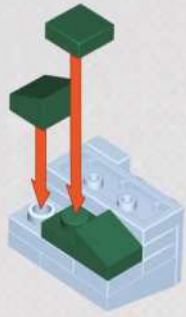

x1



x1



x1

87

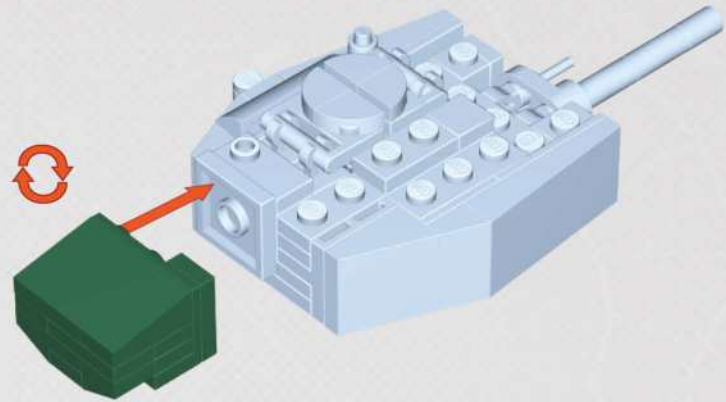

88

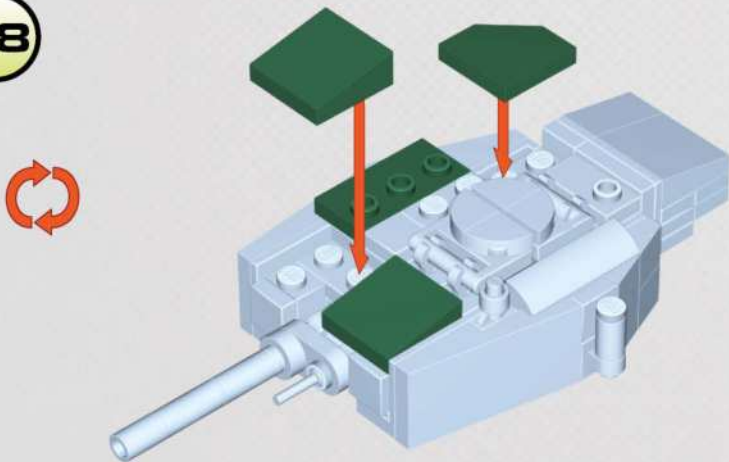

x1



x2



x1

89

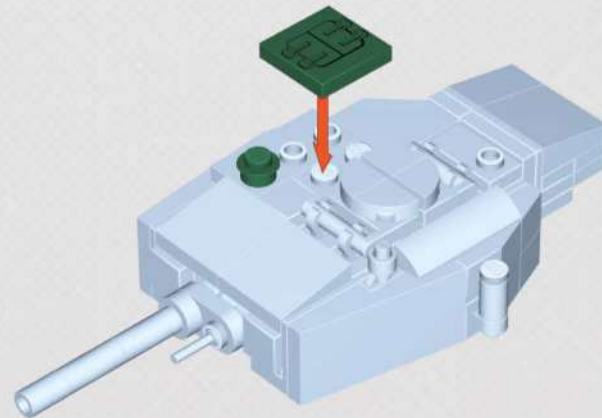

x1



x1



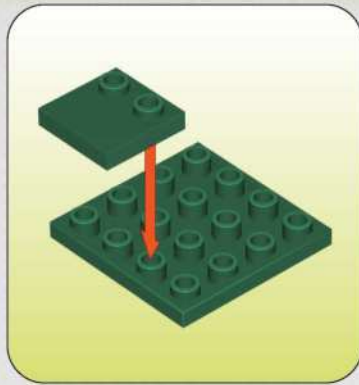
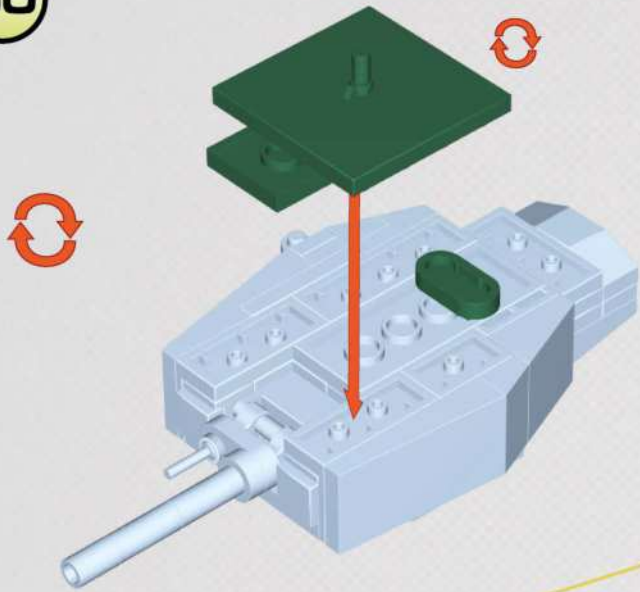



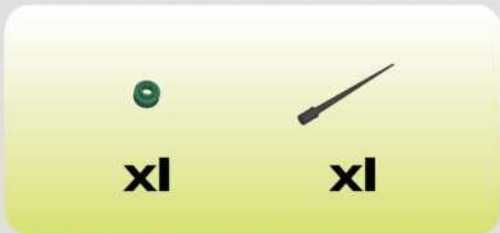
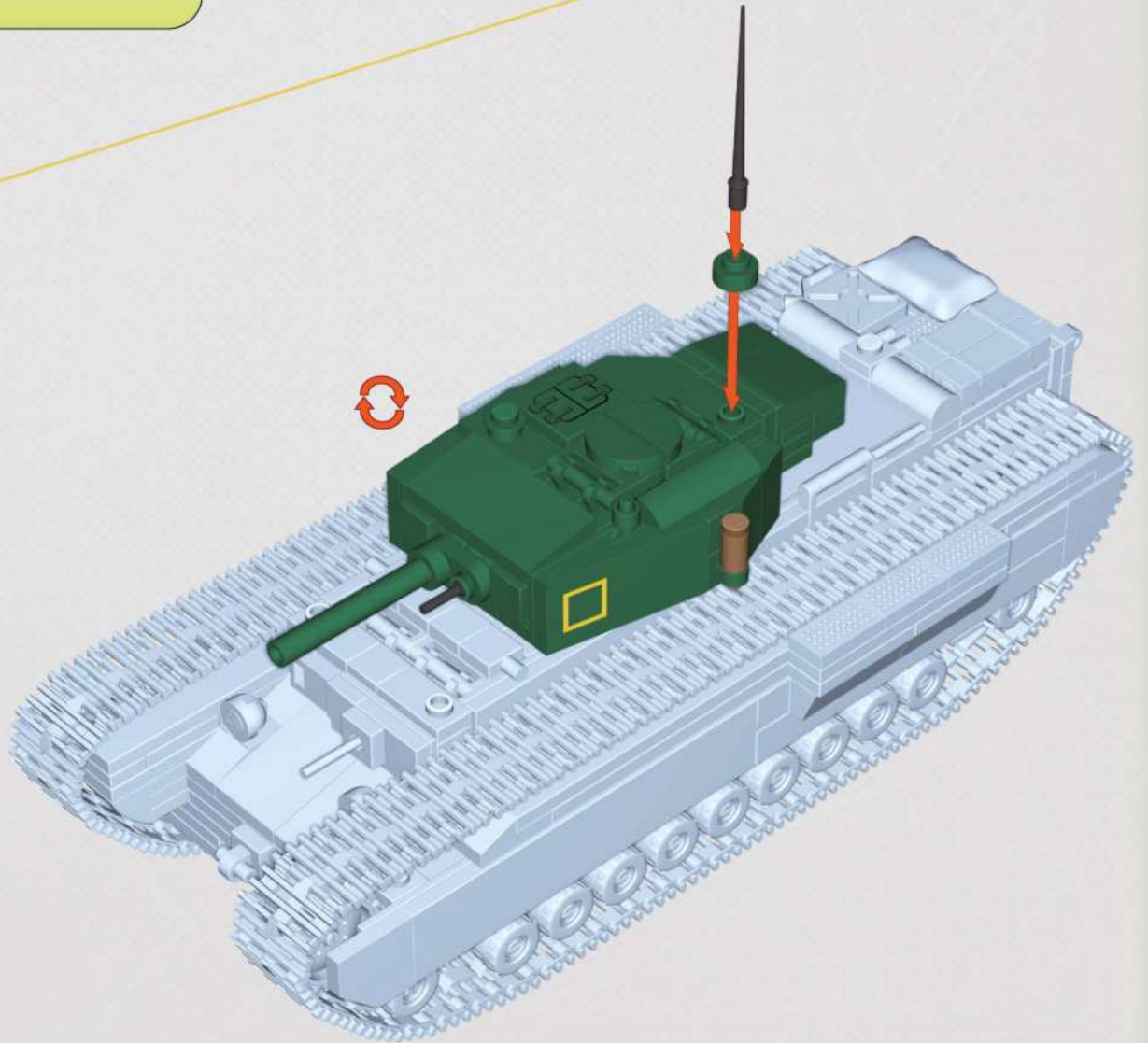

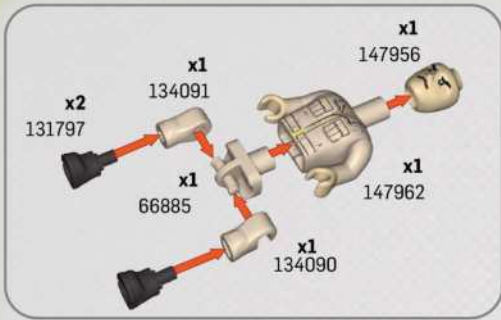



























































































90



91





- | | | | | | | | | | | | |
|--|---|---|---|---|--|---|---|---|---|---|---|
| 
x6
144694 | 
x23
144693 | 
x1
144575 | 
x8
94404 | 
x4
148284 | 
x3
144702 | 
x3
148250 | 
x2
144673 | 
x1
120903 | | | |
| 
x1
144700 | 
x2
127156 | 
x2
125644 | 
x13
94405 | 
x2
148249 | 
x2
123022 | 
x4
144703 | 
x3
127086 | 
x1
148247 | | | |
| 
x2
53330 | 
x9
66541 | 
x6
147895 | 
x1
128872 | 
x4
148280 | 
x1
148251 | 
x1
148252 | 
x2
102460 | 
x2
148278 | 
x2
144682 | 
x2
100762 | 
x3
66542 |
| 
x4
110515 | 
x2
144701 | 
x2
147663 | 
x11
67392 | 
x1
66543 | 
x2
148261 | 
x5
144711 | 
x2
147665 | 
x5
94406 | 
x1
141196 | 
x6
148275 | 
x8
148256 |
| 
x2
144678 | 
x22
148255 | 
x1
51591 | 
x4
120913 | 
x1
147865 | 
x2
94408 | 
x1
144680 | 
x1
148279 | 
x2
128184 | 
x3
144707 | 
x13
94409 | 
x3
148272 |
| 
x1
122321 | 
x1
100802 | 
x4
100765 | 
x2
142942 | 
x9
107227 | 
x15
148266 | 
x8
94412 | 
x1
148258 | 
x1
144713 | 
x10
110710 | 
x3
115055 | 
x5
148265 |
| 
x4
94414 | 
x5
147686 | 
x7
94416 | 
x2
102006 | 
x2
102008 | 
x2
147684 | 
x17
94419 | 
x2
148185 | 
x9
147688 | 
x13
94420 | 
x1
94422 | 
x1
148186 |
| 
x1
147680 | 
x1
144712 | 
x3
148253 | 
x4
122330 | 
x5
147682 | 
x2
148254 | 
x3
144689 | 
x3
102121 | 
x1
66549 | 
x2
144714 | 
x2
144698 | 
x9
94424 |
| 
x2
94491 | 
x1
148260 | 
x3
94428 | 
x1
148259 | 
x1
43179 | 
x5
122951 | 
x1
148188 | 
x1
148190 | 
x2
148192 | 
x8
122950 | 
x1
115057 | 
x1
94432 |

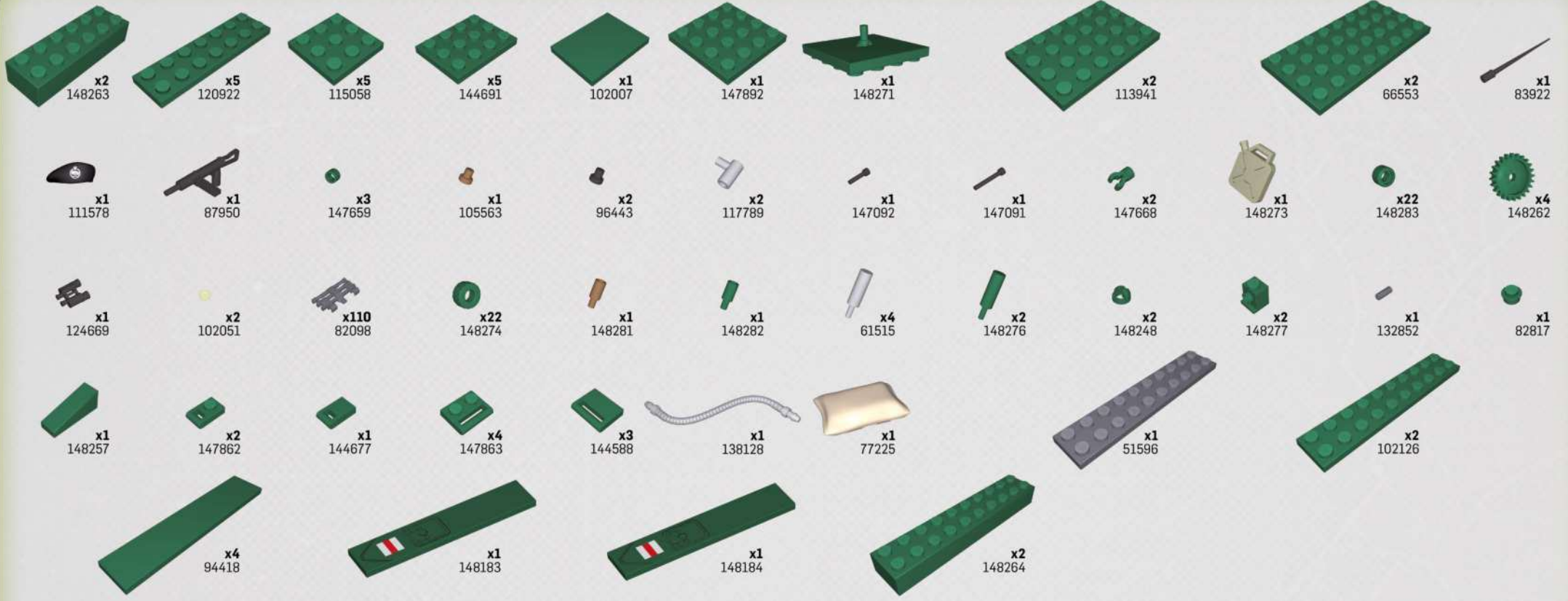



HISTORICAL COLLECTION



Sd.Kfz.10 DEMAG D7
+ 2273



SHERMAN M4A1
SCALE 1:48
★ 2715



CHURCHILL MK. IV
SCALE 1:48
★ 2717



PANZER II AUSF. A
SCALE 1:48
+ 2718



Sd.Kfz.7 HALF-TRACK
+ 2275



M4A3E8 SHERMAN
SCALE 1:48
★ 2711



PANZER III AUSF. J
+ 2562



PzKpfw V PANTHER „PUDEL”
★ 2568



HISTORICAL COLLECTION



MIG-17 NATO "FRESCO"
CODE
★ 5823



HAWKER HURRICANE MK. I
★ 5728



LIM-5 (MIG-17F) EAST GERMAN AIR FORCE
★ 5825



JUNKERS JU-88
+ 5733



COMPANY OF HEROES 3



US AIR SUPPORT CENTER

★ 3042



GERMAN FIGHTING POSITION

⊕ 3043



COMPANY OF HEROES

🇮🇹 🇺🇸 🇩🇪 🇬🇧 3041



PANZER IV Ausf. G

⚔️ 3045



8,8cm FLAK

⚔️ 3047

COMPANY OF HEROES 3

For news and special deals

Find us on:



WWW.COBI.EU

18-0346-644