

# COMPANY OF HEROES 3



## Sd.Kfz. 251 Ausf. D

IN SERVICE - 1943 - 1945  
PLACE OF ORIGIN - GERMANY  
TYPE - ARMoured PERSONNEL CARRIER  
COMBAT WEIGHT - 9t (19 800lb)  
ARMOUR - 6-14mm (.2-.5")  
ARMAMENT - 1x 7,92cm (.312") MG 34,  
ENGINE - HL 42 TURKM 73,6kw (99hp)  
SPEED - 52,5km/h (32,6MPH) ON THE ROAD  
RANGE - 320km (200mi) ON THE ROAD  
CREW - 2



© SEGA

3049

**PAD PRINTED**  
**NO STICKERS**

Printed in EU



463  1 

Sd.Kfz. 251 Ausf. D

SCALE 1:35



1

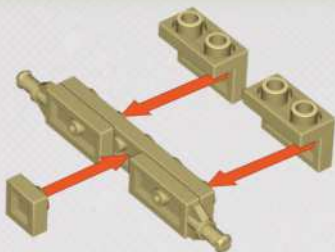

x1



x2



x2



x1

2

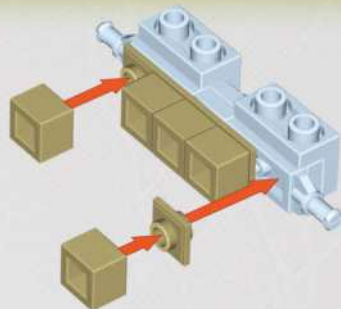

x1



x1



x5

BE CAREFUL: NOTICE THE DIFFERENCE



3

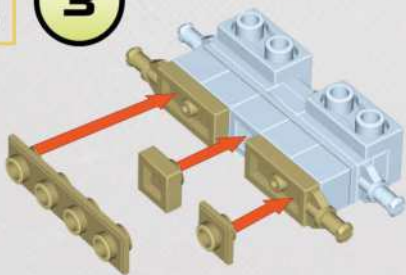

x2



x1



x1



x1

4

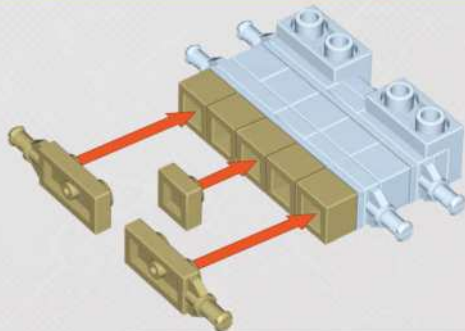

x5



x1



x2

5

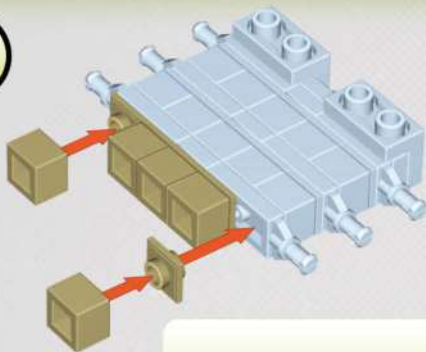





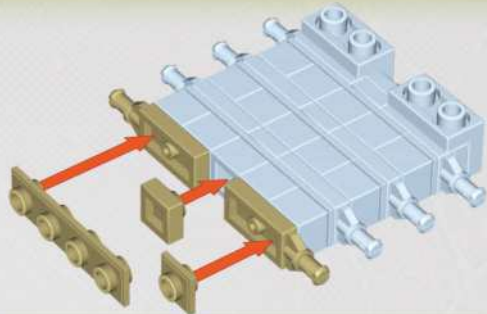

  
**x1**    **x1**    **x5**

6





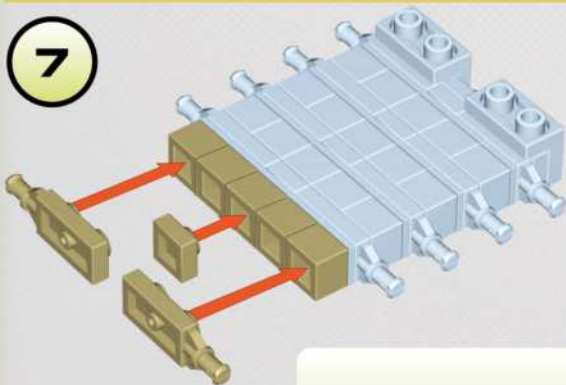

  
**x2**    **x1**    **x1**    **x1**

7



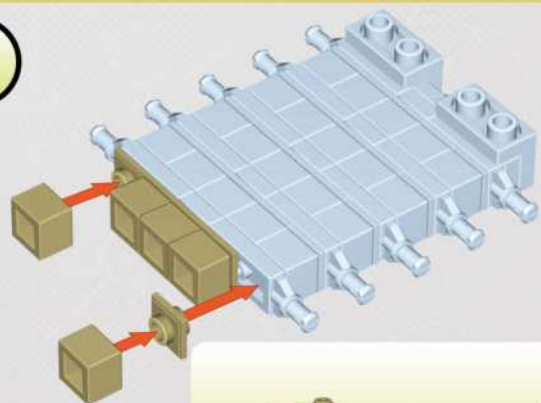

  
**x5**    **x1**    **x2**

8





  
**x1**    **x1**    **x5**



9

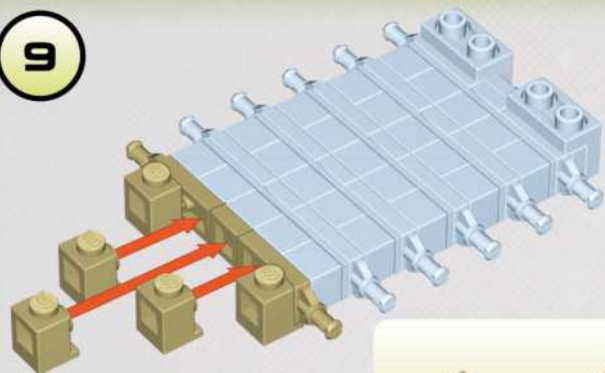

x1



x2



x5

10



x1



x1



x2

11

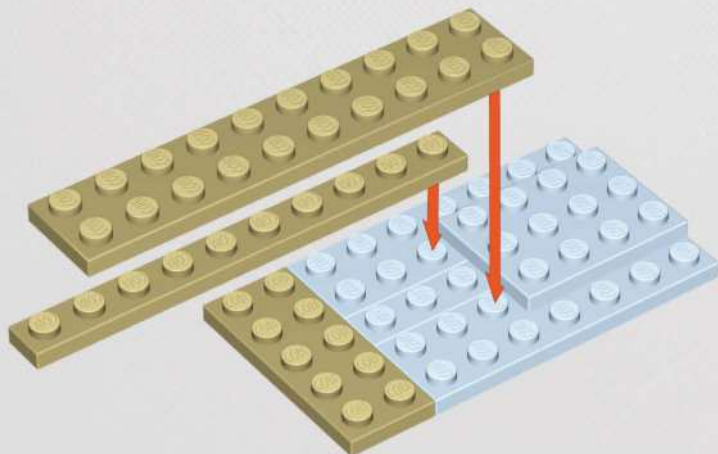

x1



x1



x1

12

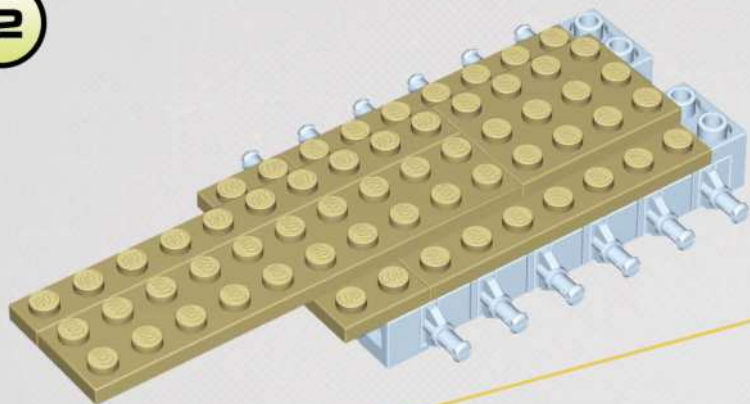

13



x1



x2



x2



x1



x1



x1

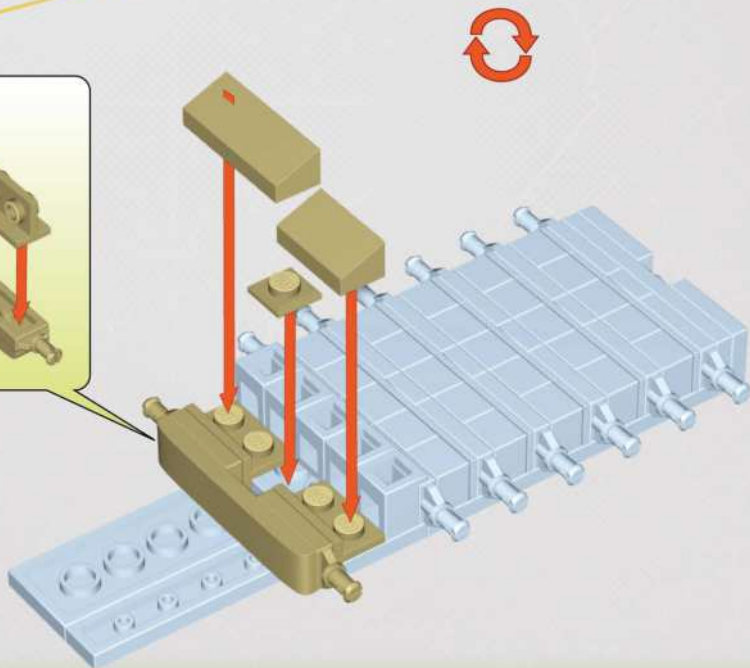
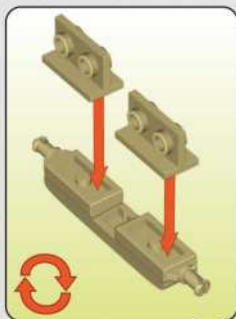

14

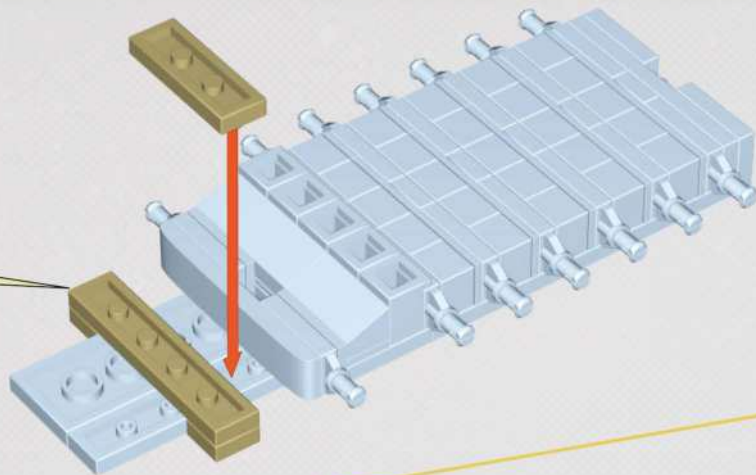
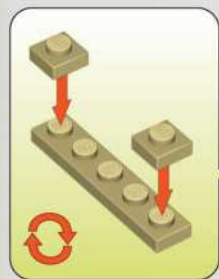

15

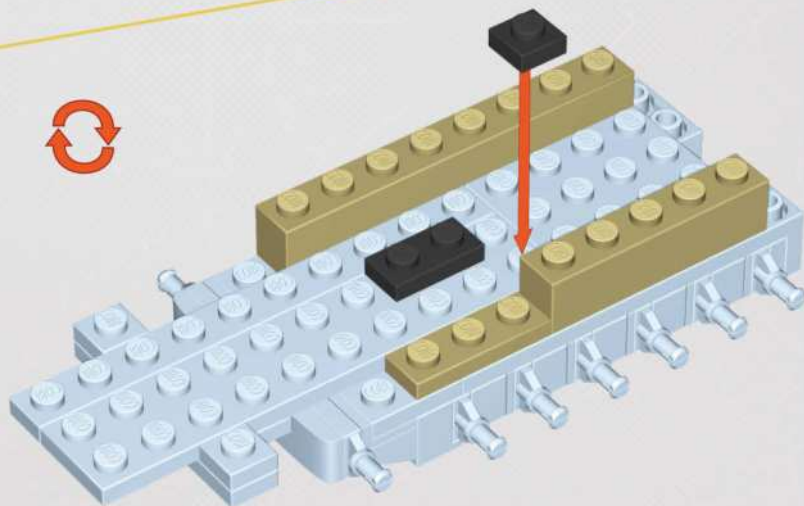
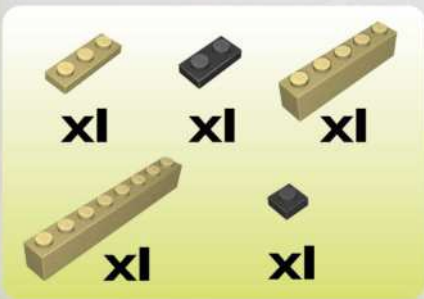

16

1:1



x1



x1



x1



x2

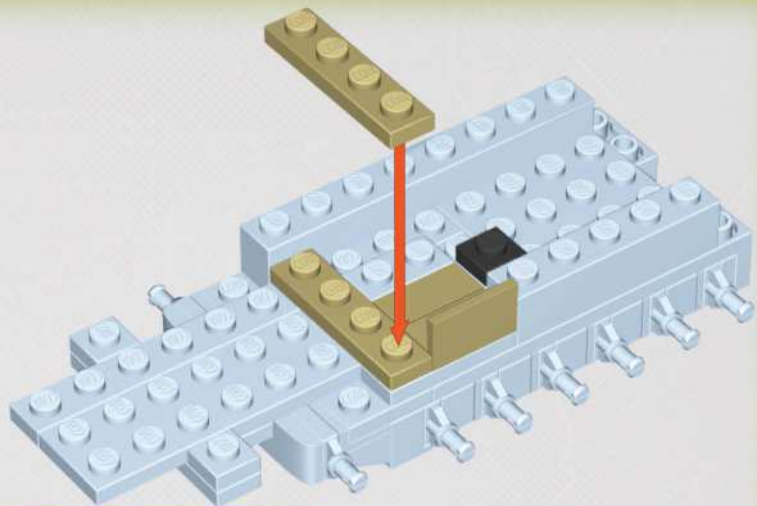

17

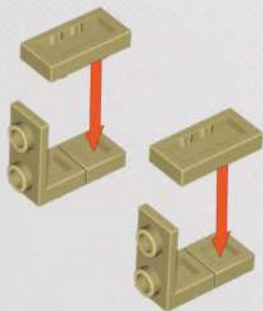

x2



x2



x2

18

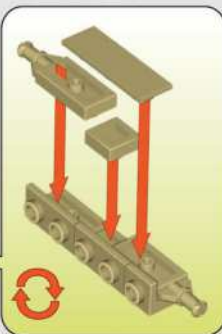
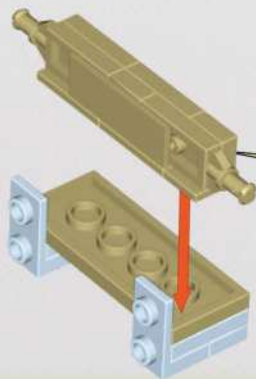

x1



x1



x2



x2



x1



x1



19

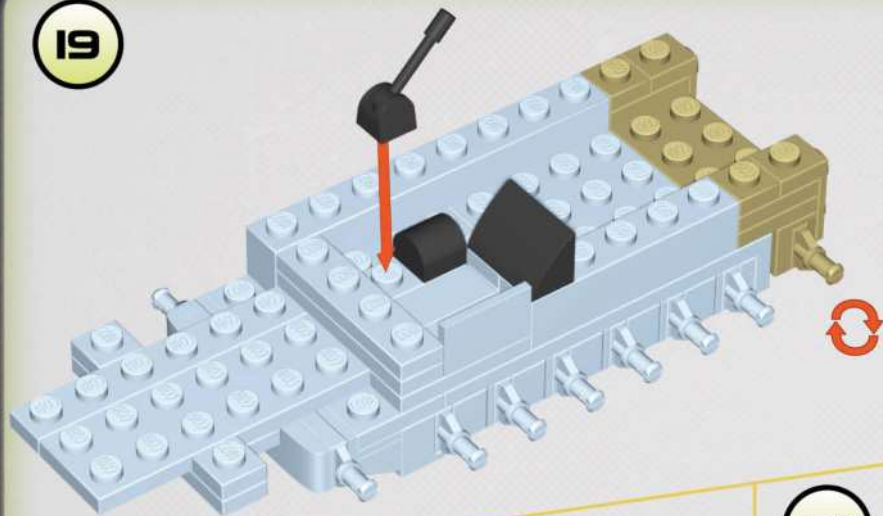

x1	x1
x1	x1

20

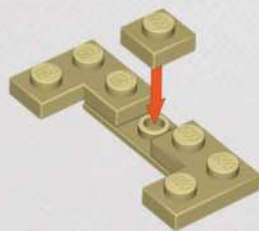

x1	x2	x1

21

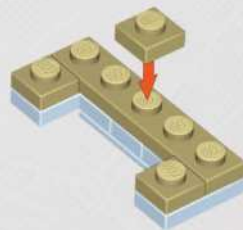

x1	x3



22

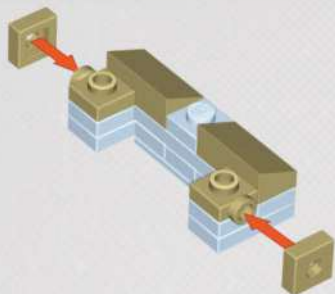

23

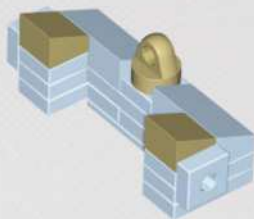

x2



x2



x2



x2



x1

24



x1



x2



x1

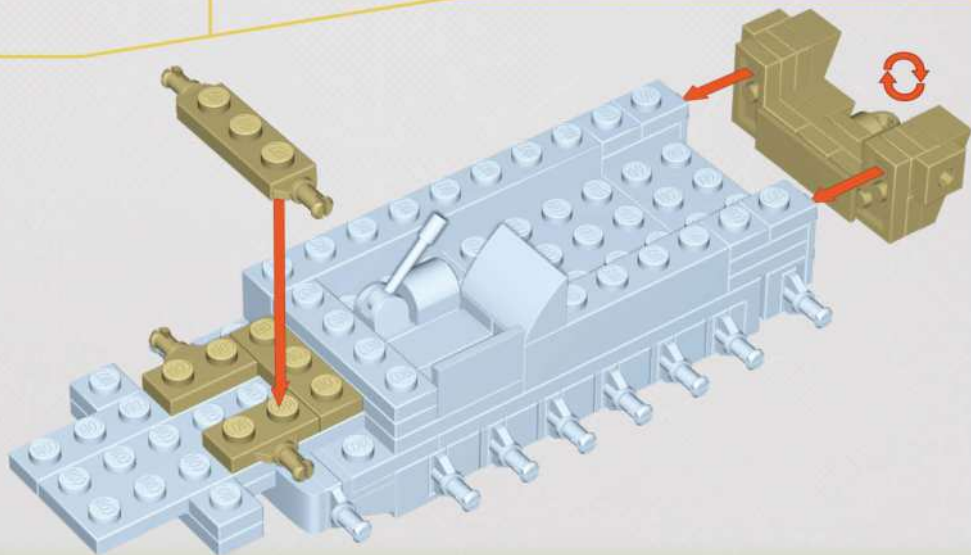

25

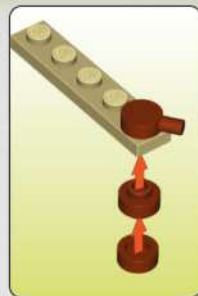
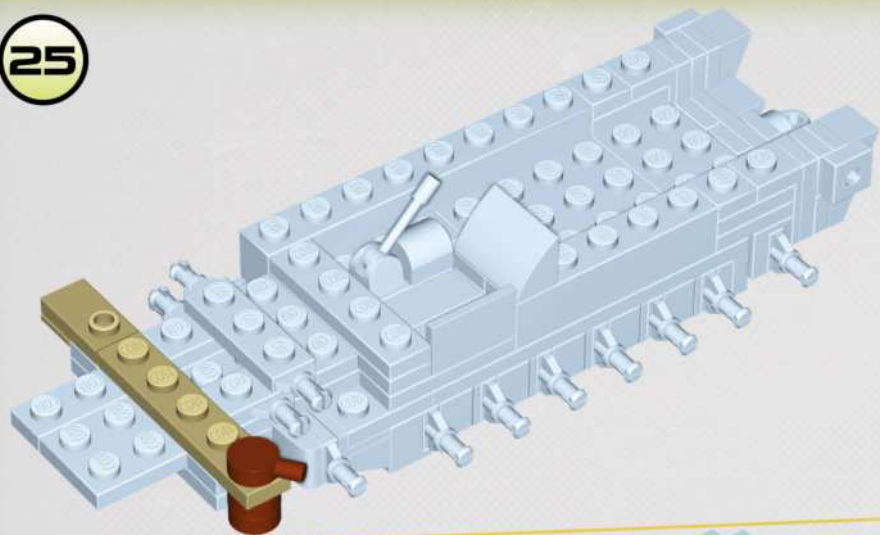

x1



x1



x1



x1



x1



x1

26

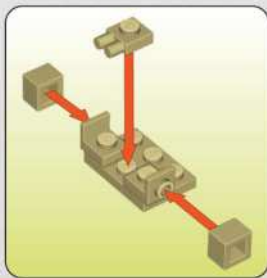
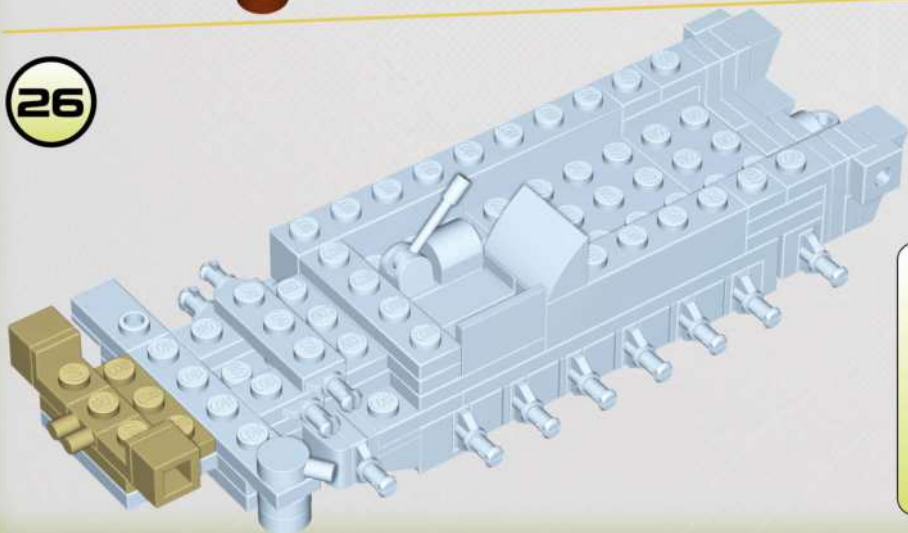

x1



x2



x2



x1

27

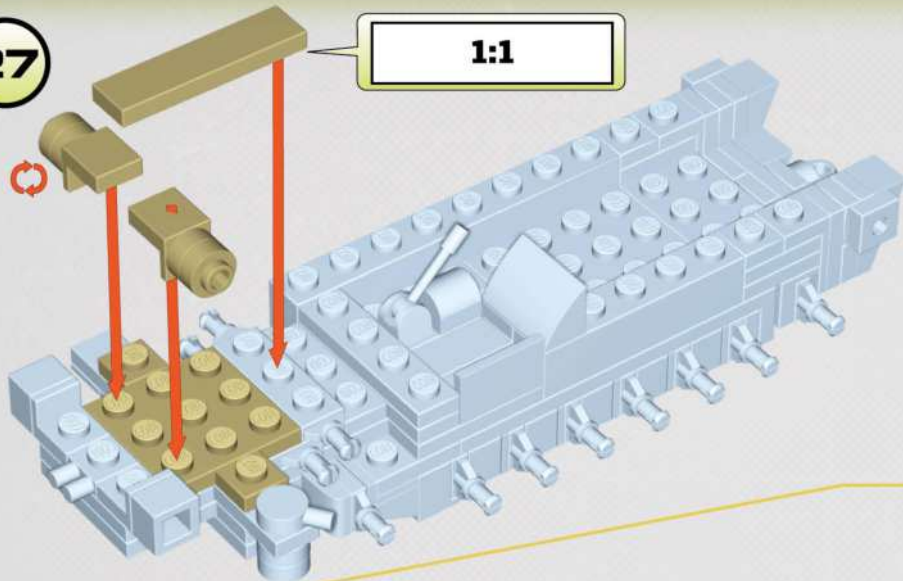

1:1

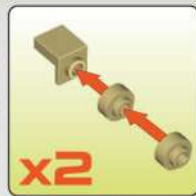



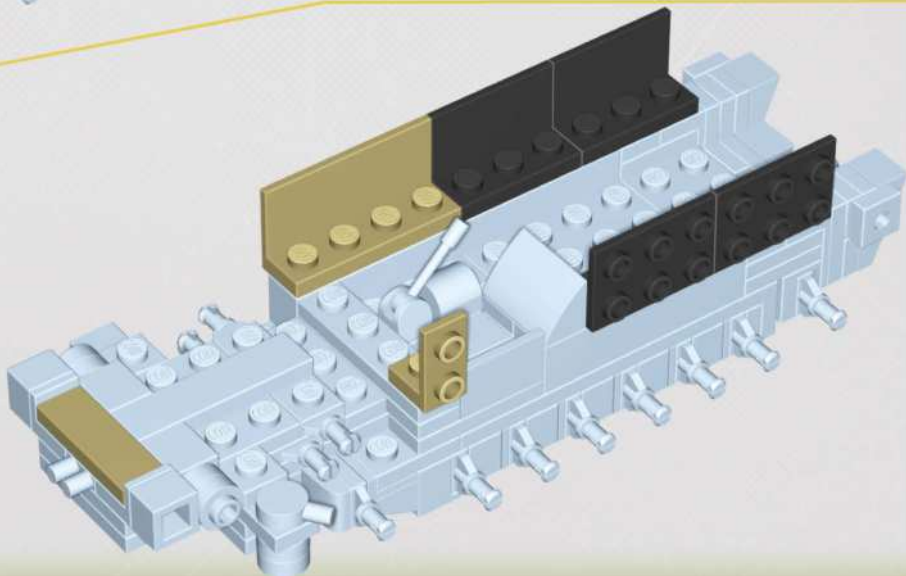

-  x1
-  x2
-  x2
-  x4

28



1:1

-  x4
-  x1
-  x1
-  x1





31

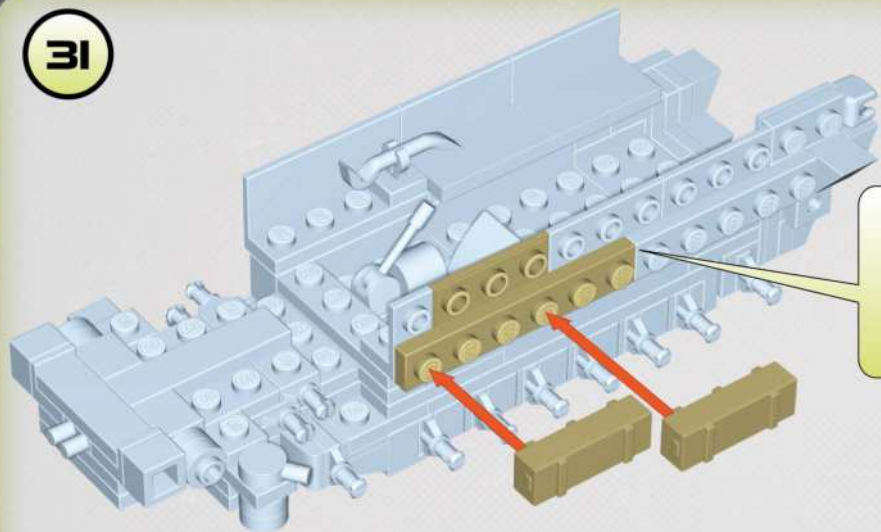

32

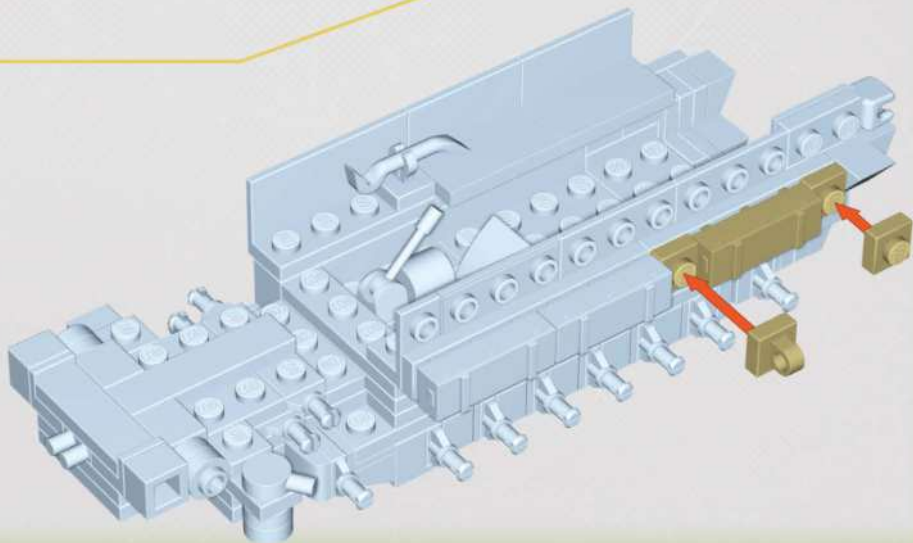

33

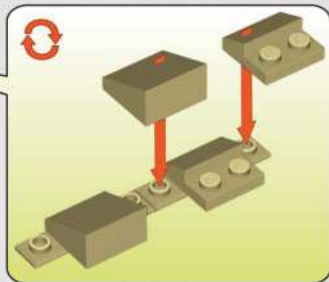
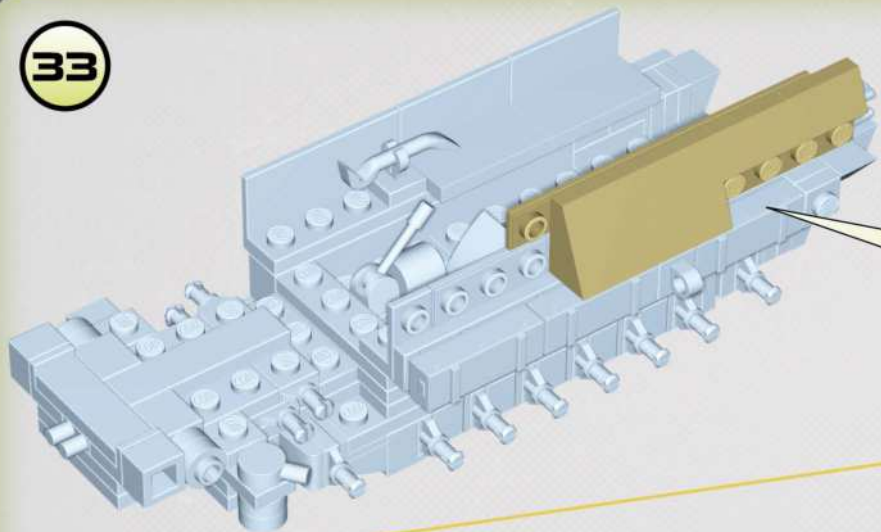

34

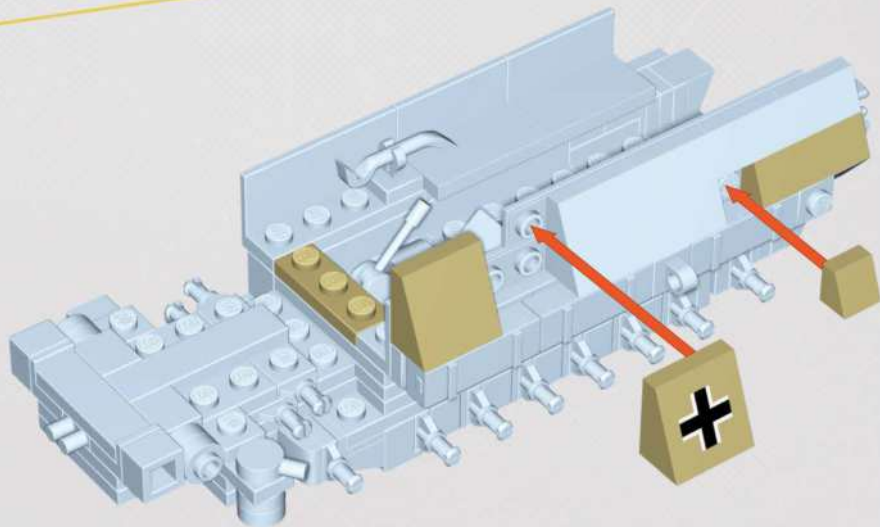

x1 x1 x1



x1 x1



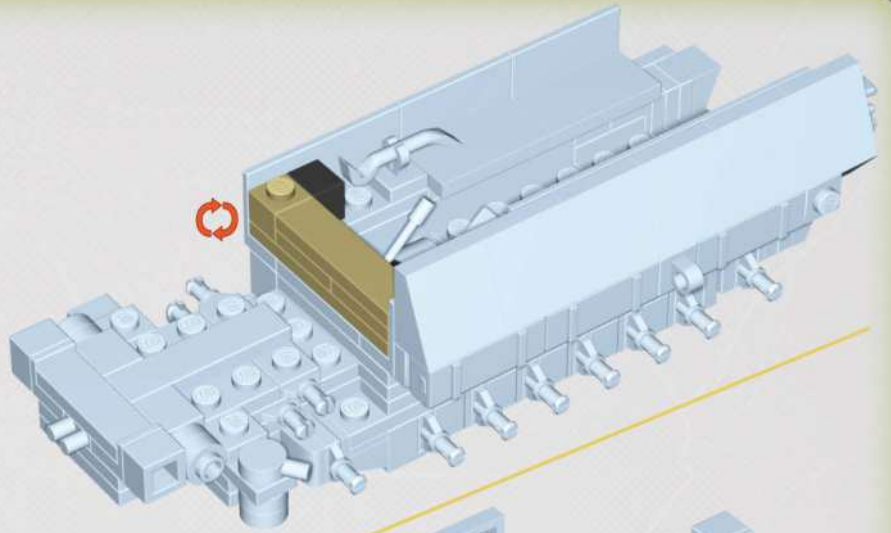
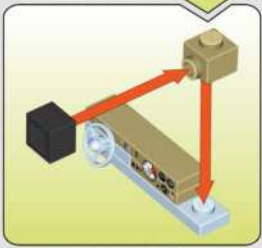
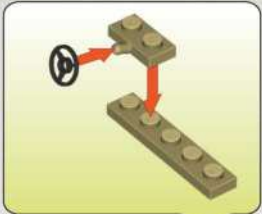

35

-  **x1**
-  **x1**
-  **x1**
-  **x1**
-  **x1**
-  **x1**



36

-  **x2**
-  **x1**
-  **x2**

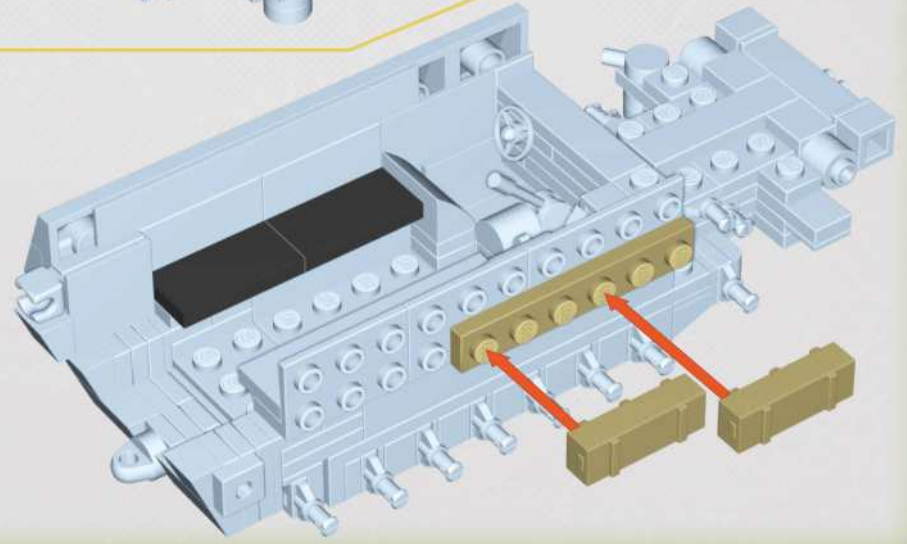

37

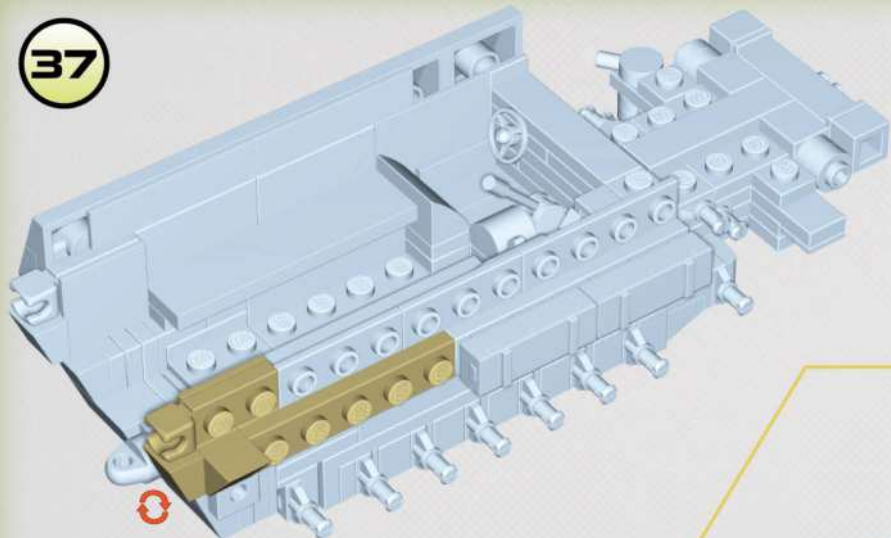

- |           |           |           |           |
|-----------|-----------|-----------|-----------|
|           |           |           |           |
| <b>x1</b> | <b>x1</b> | <b>x1</b> | <b>x1</b> |
|           |           |           |           |
| <b>x1</b> | <b>x1</b> | <b>x1</b> |           |

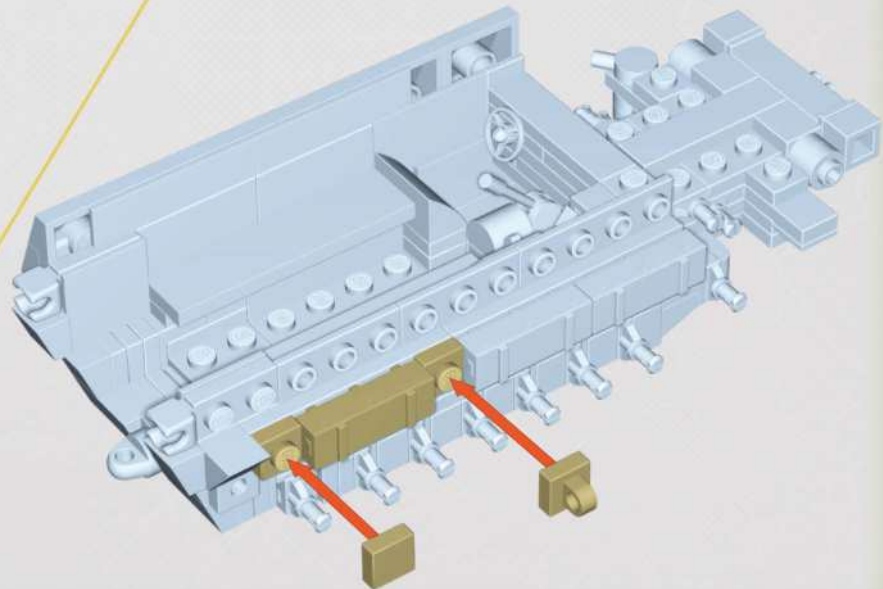
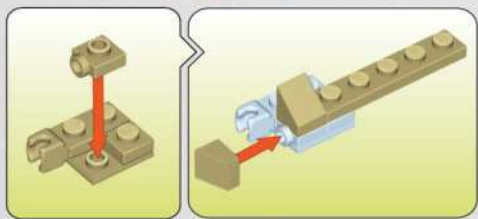

38

- |           |           |           |           |
|-----------|-----------|-----------|-----------|
|           |           |           |           |
| <b>x2</b> | <b>x1</b> | <b>x1</b> | <b>x1</b> |

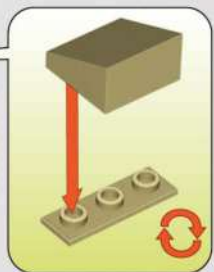
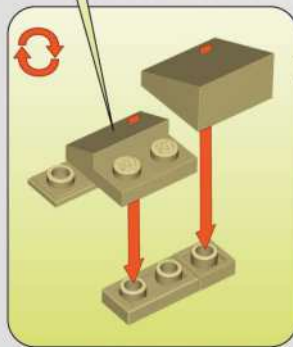
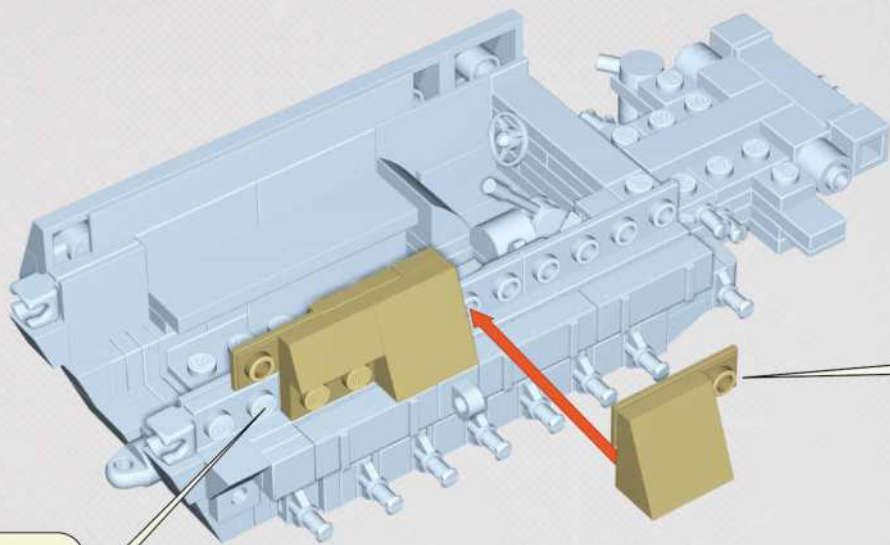

x1



x1



x2



x1



x1



x1





40

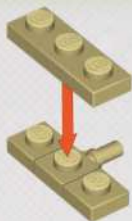

41

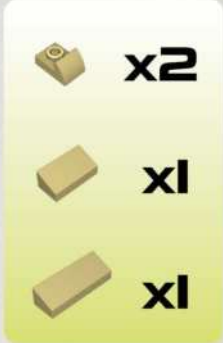
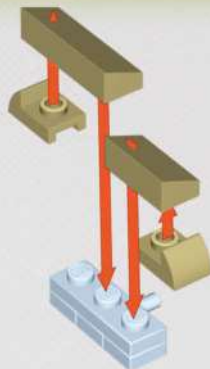

42

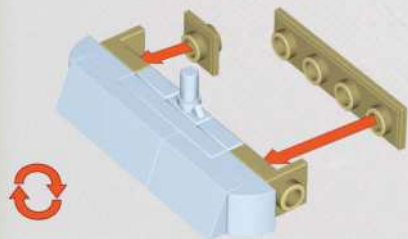

43

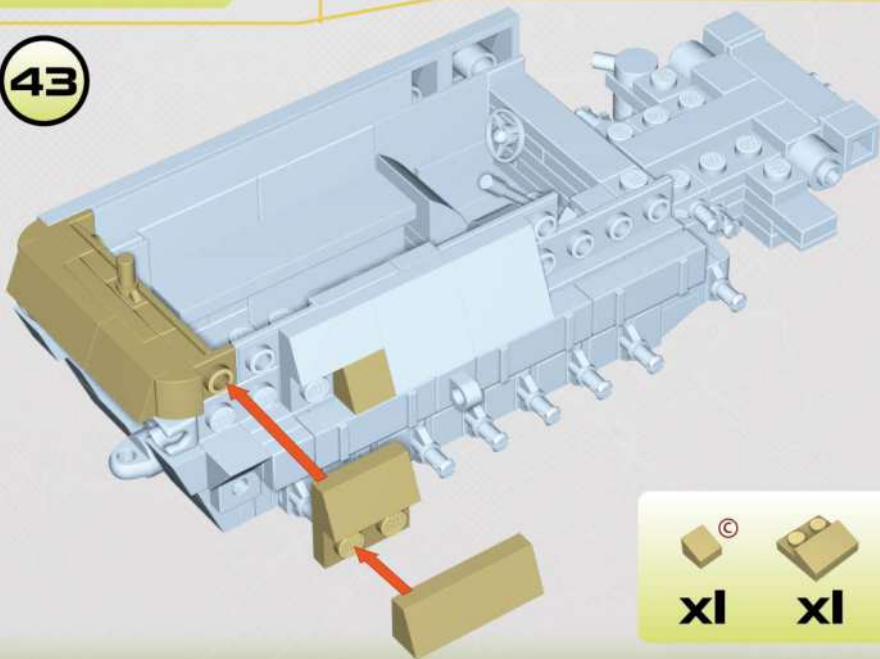

44

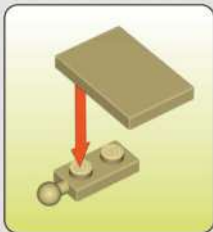
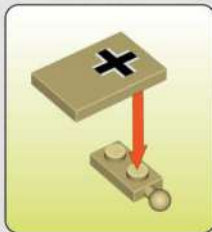
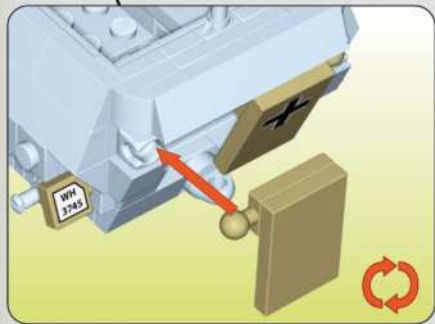
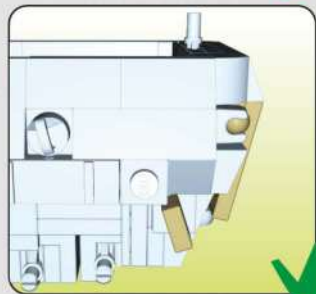
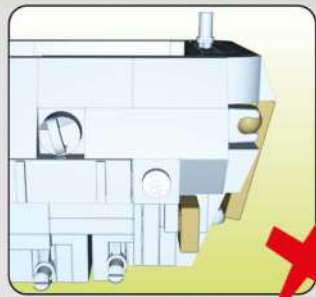
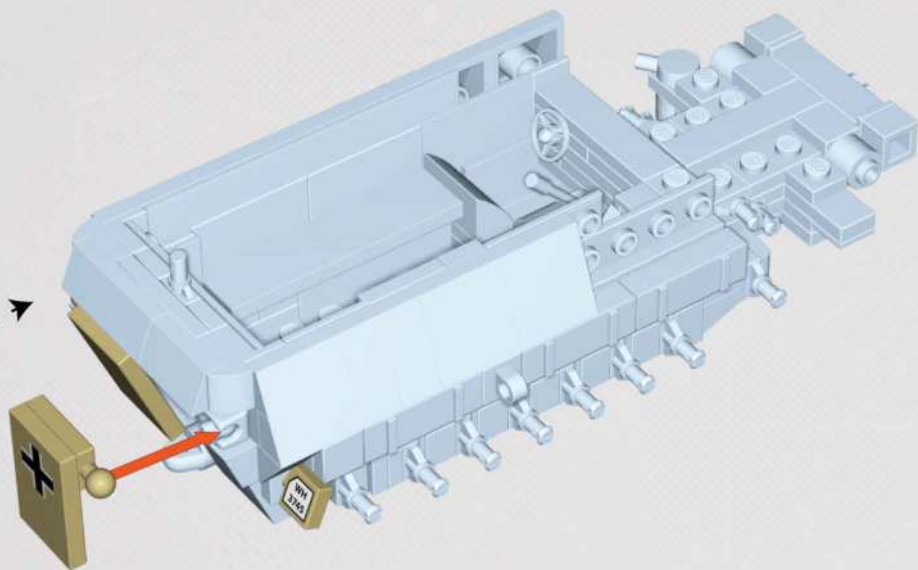

x1



x1



x2



x1



x1

45

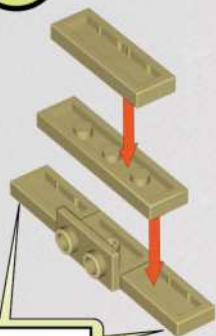

-  x2
-  <sup>F</sup> x1
-  x1
-  x1

48

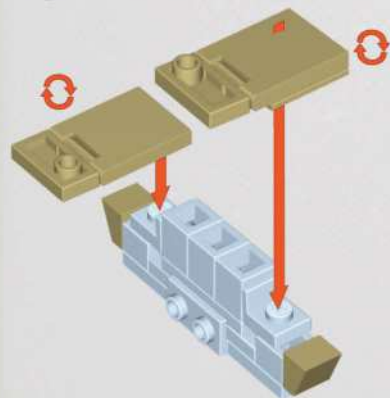

46

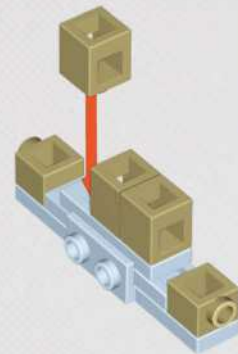

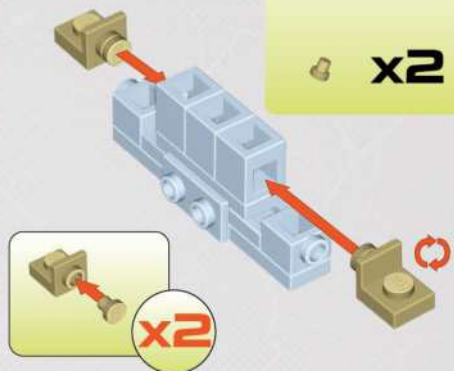

-  x3
-  x2

47

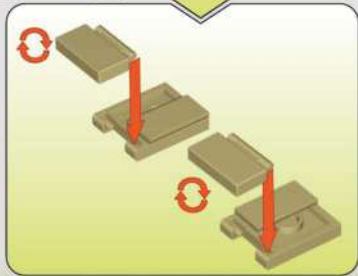
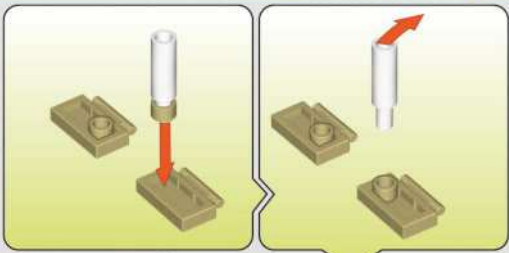

-  x2
-  x2



-  <sup>C</sup> x2
-  x2
-  x2
-  x2
-  x2



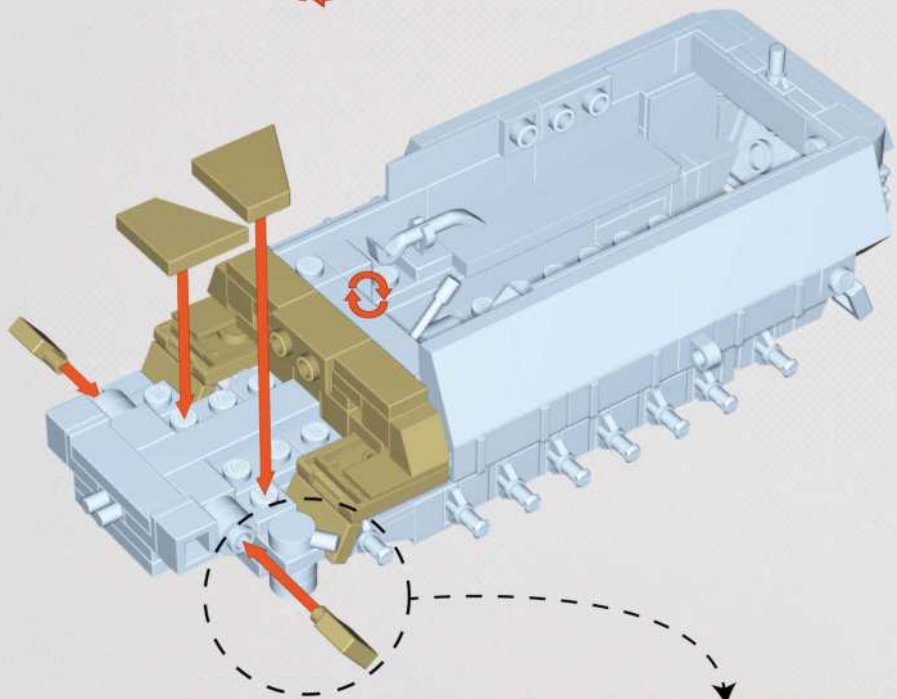

x1



x1



x2

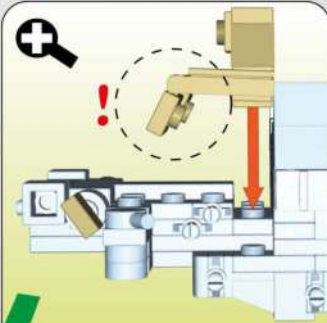
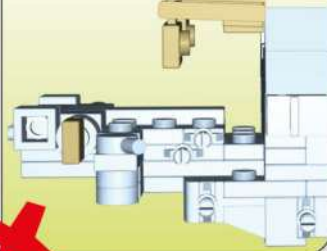
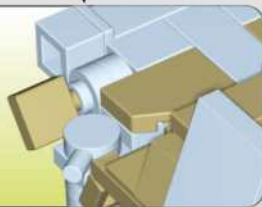

50

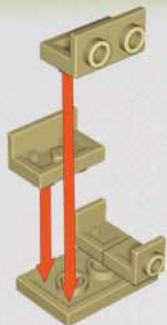

x1



x2



x2

51

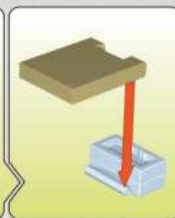
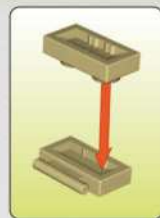
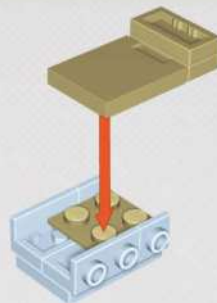

**BE CAREFUL: NOTICE THE DIFFERENCE**

**G** **H**

**x1** **x1** **x1** **x1**

52

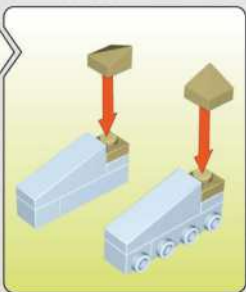
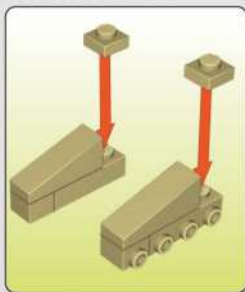
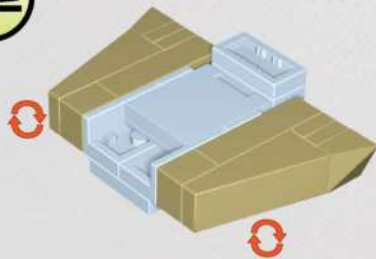

**x2** **x2** **x4** **x2** **x2**

53

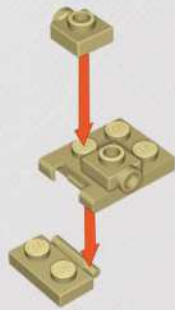

**x1** **x1** **x2**

54

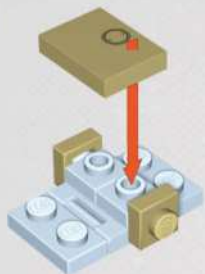

x2

x1

55

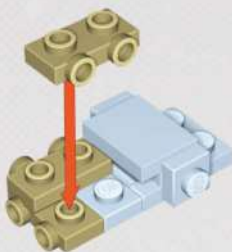

x3

56

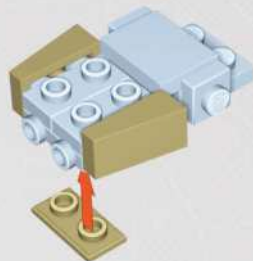

x2

x1

57

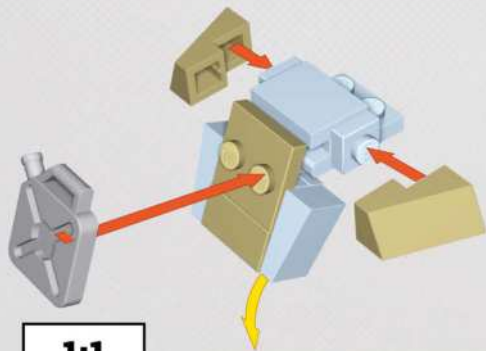

1:1



x1

x1

x1

x1

x1

58

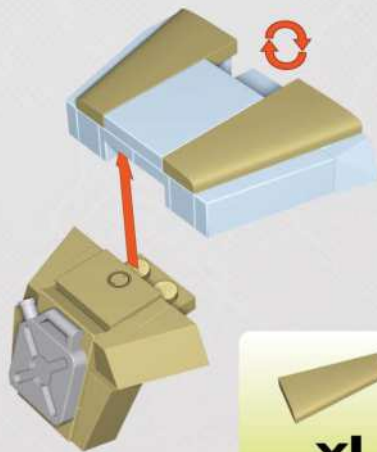

x1

x1



59

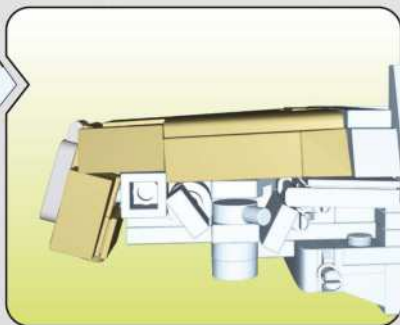
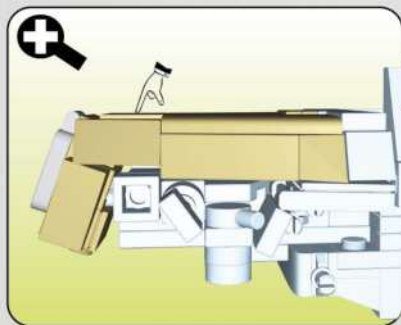
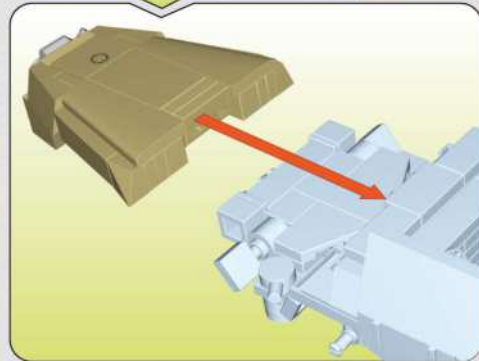
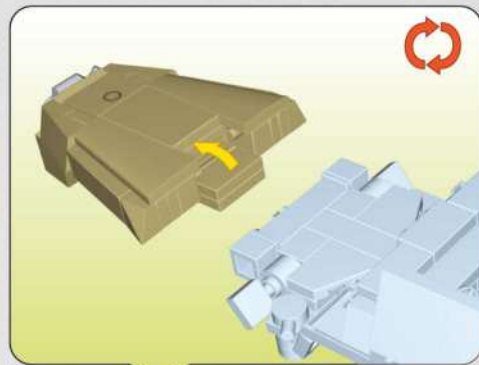
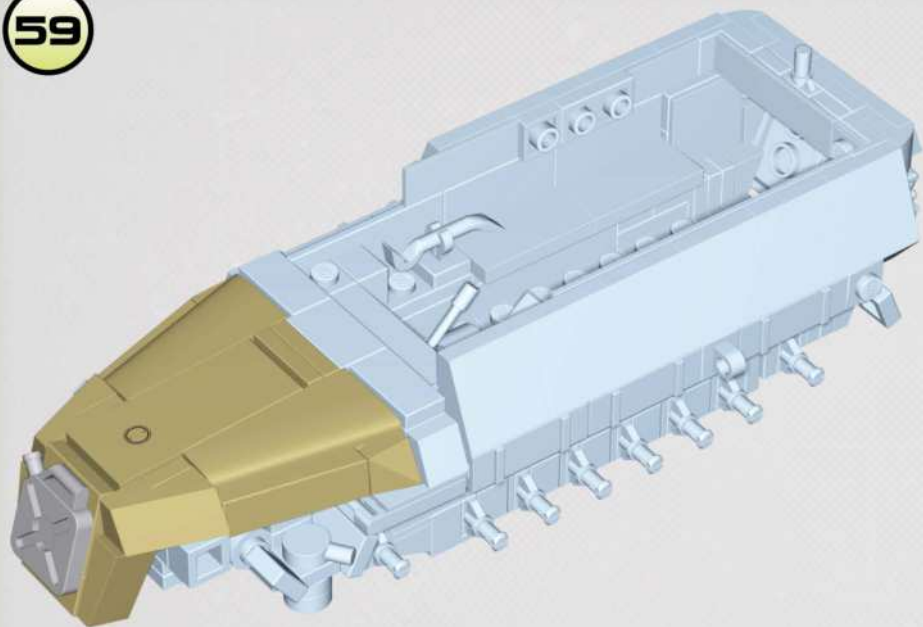

60

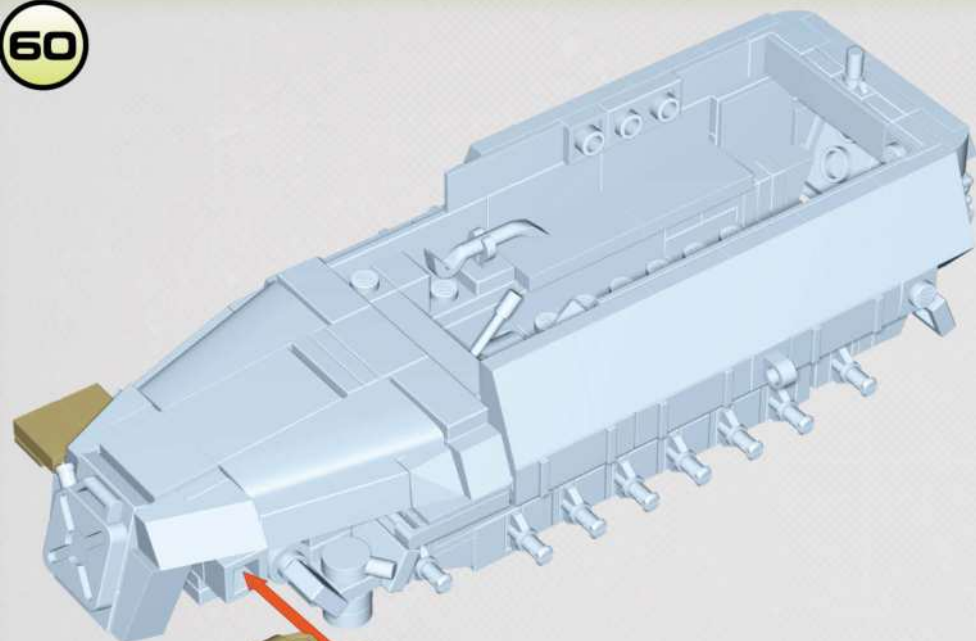

- |           |           |           |
|-----------|-----------|-----------|
|           |           |           |
| <b>x2</b> | <b>x1</b> | <b>x2</b> |
|           |           |           |
| <b>x1</b> | <b>x1</b> | <b>x1</b> |

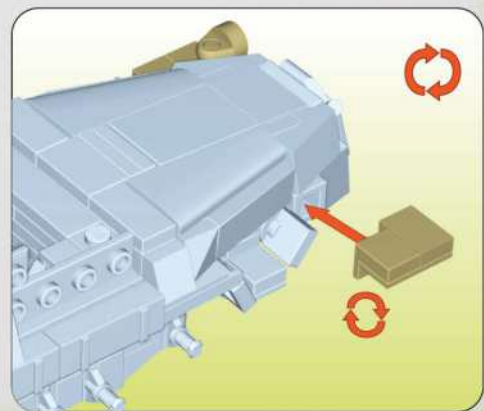
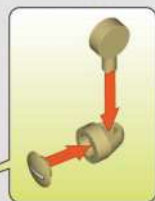
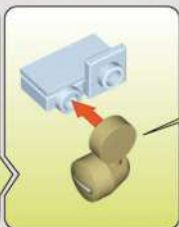
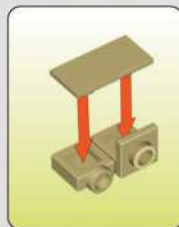
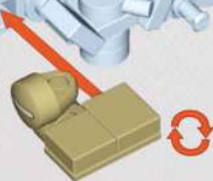

61

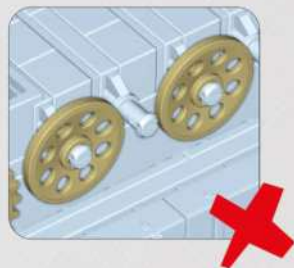
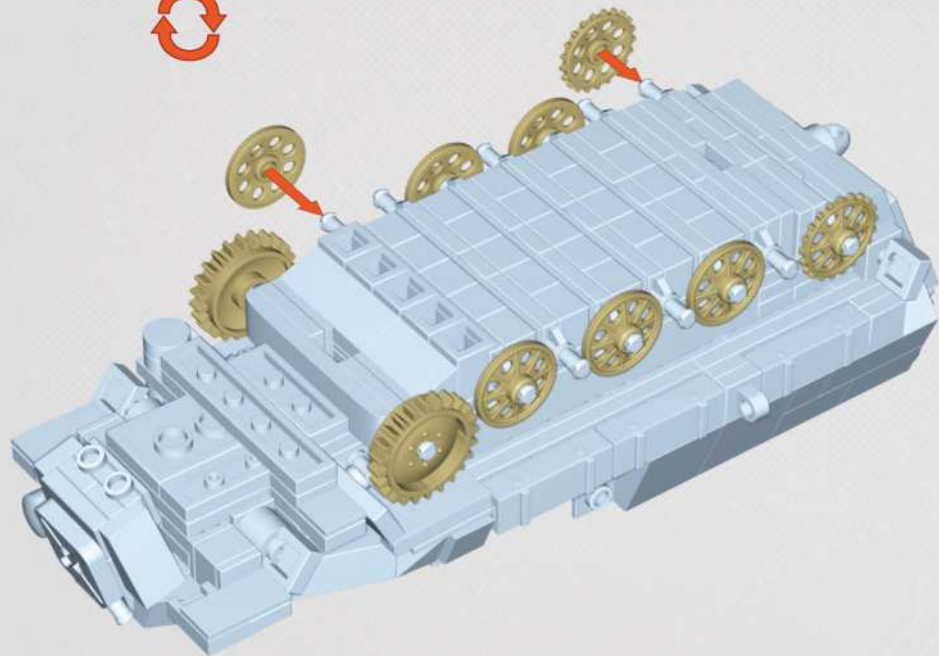

x2



x6



x2



62

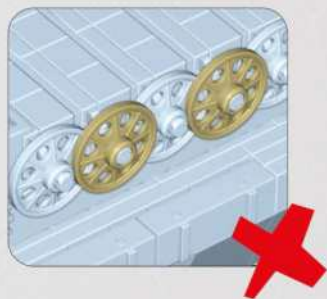
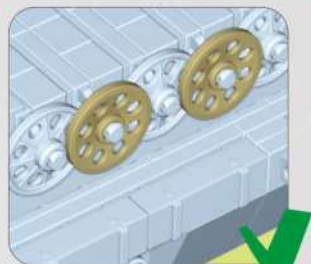
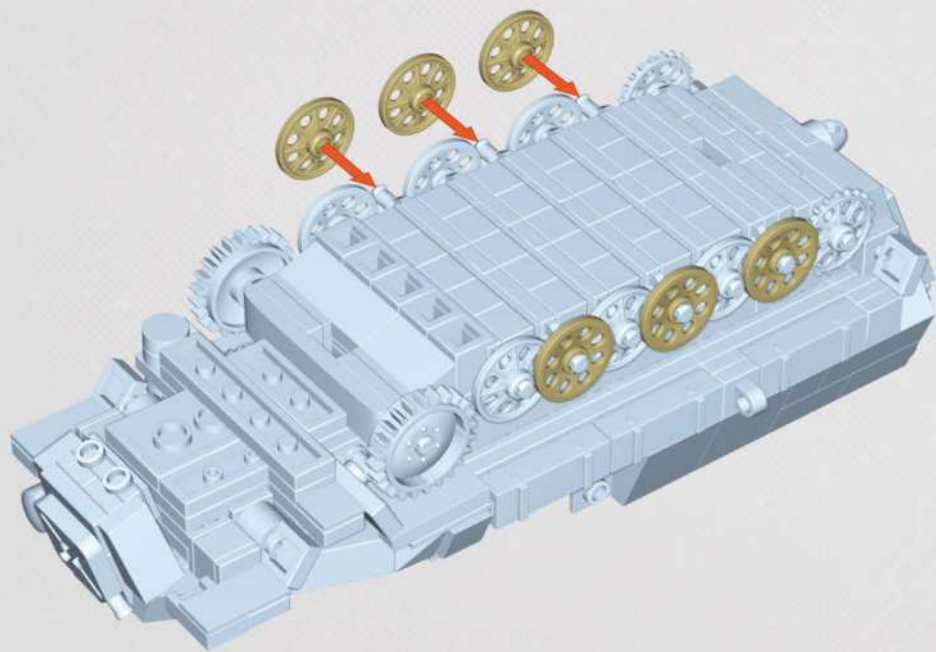

x6

63

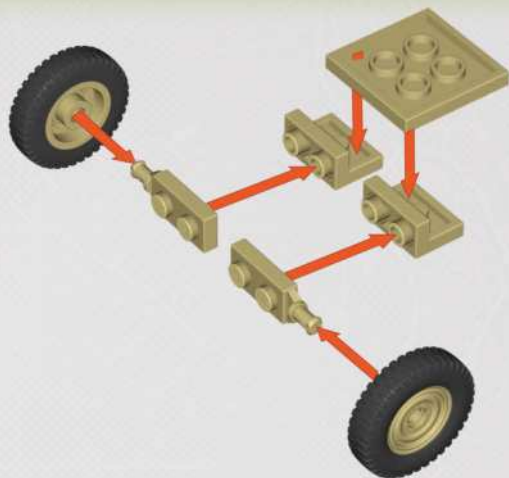

x2



x2



x2



x2



x1

64

1:1



x2



x2



x1

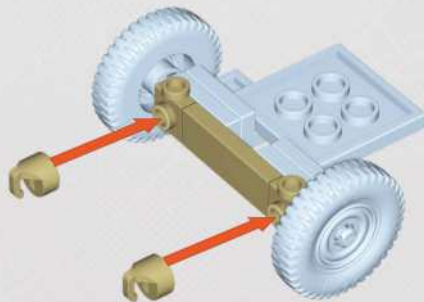

65

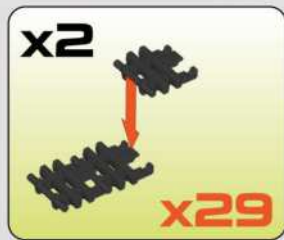
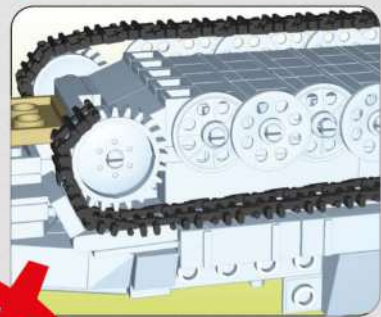
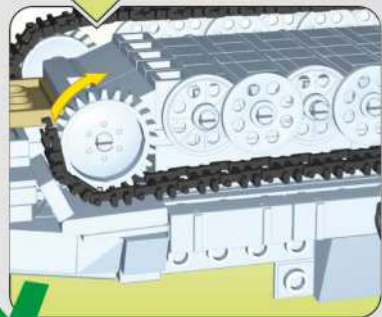
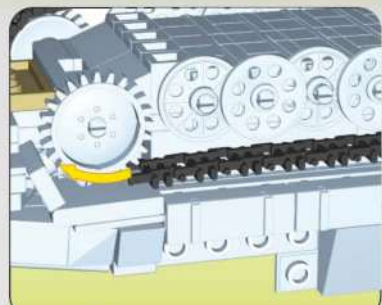
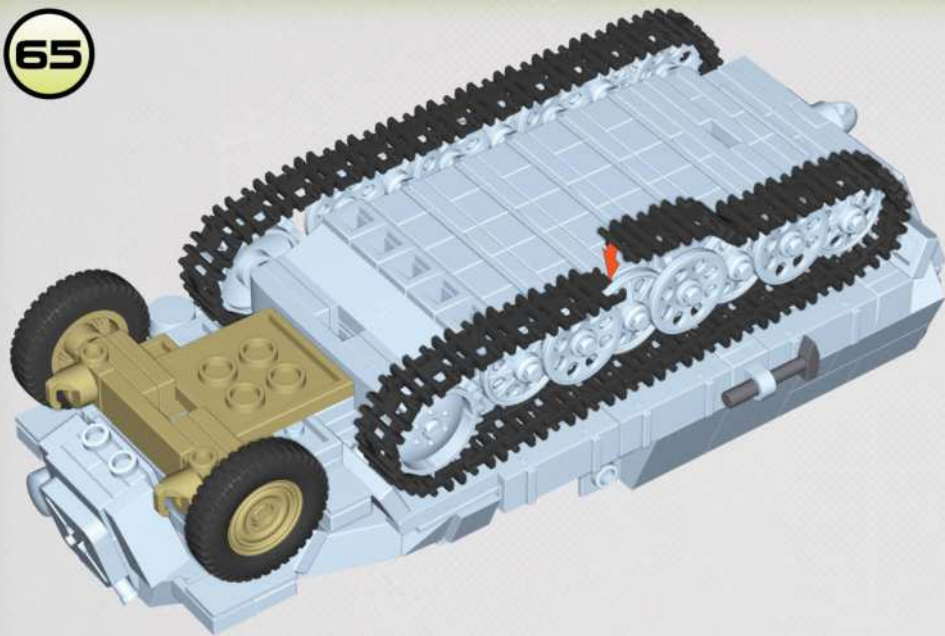



66

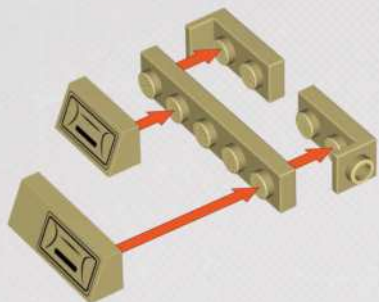

x2



x1



x1



x1

67

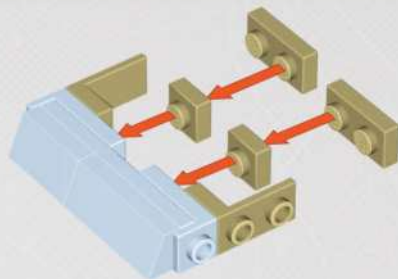

x2



x2



x2

68

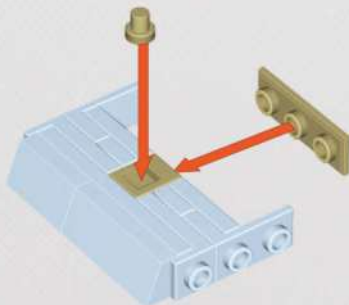

x1



x1



x1

69

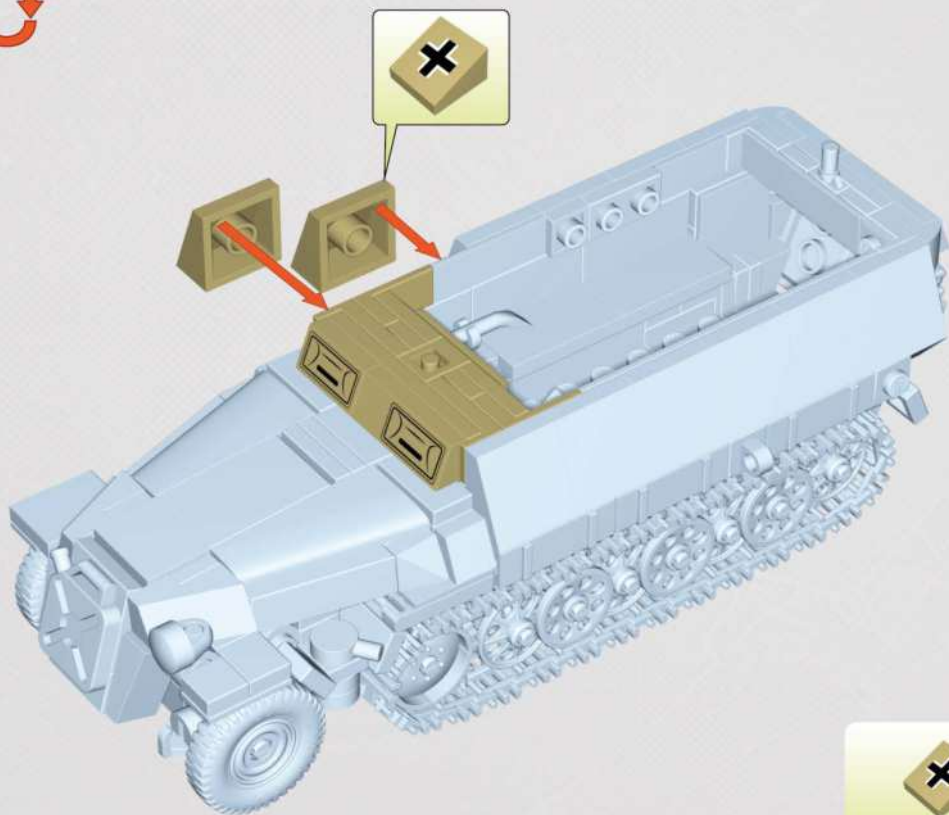

x1



x1

70

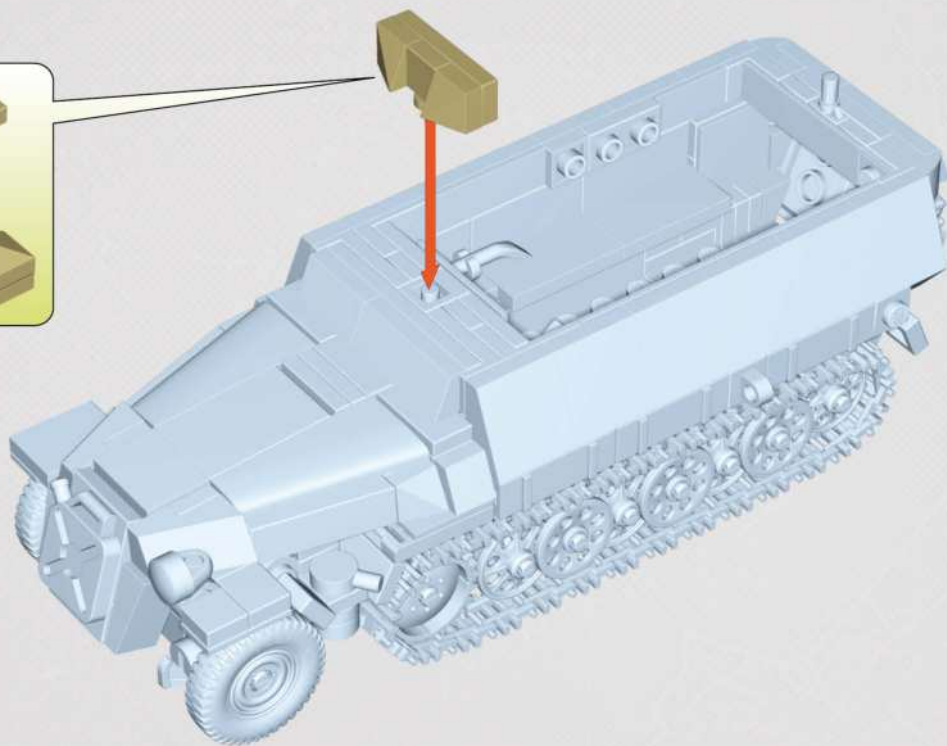
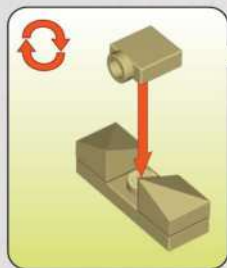

x1



x2



x1



71

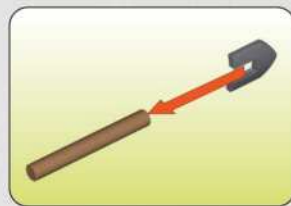
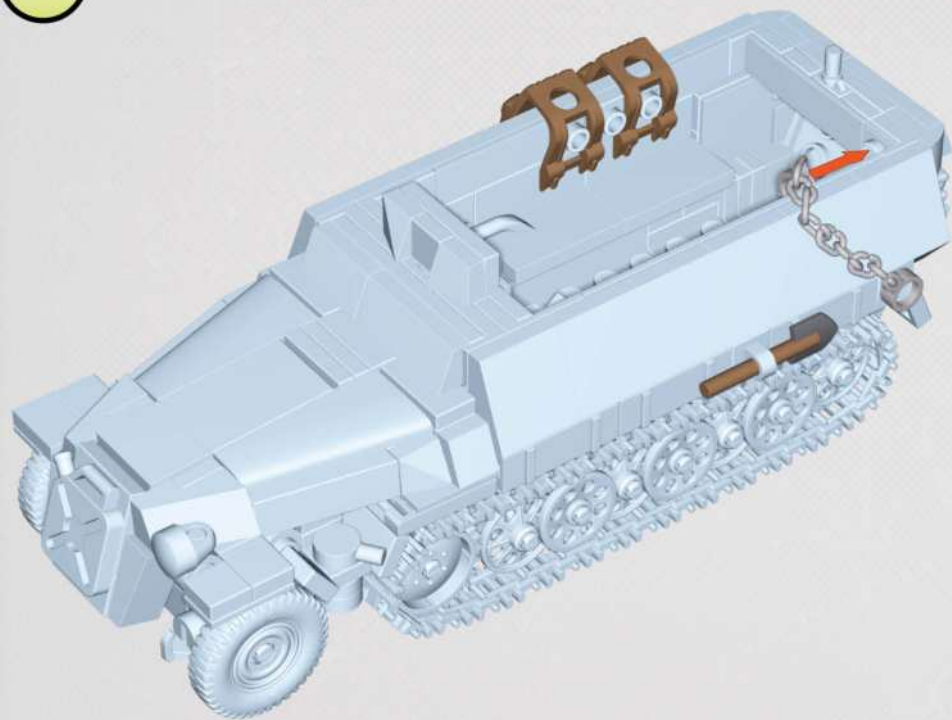

x2



x1



x1



x8



x2

72

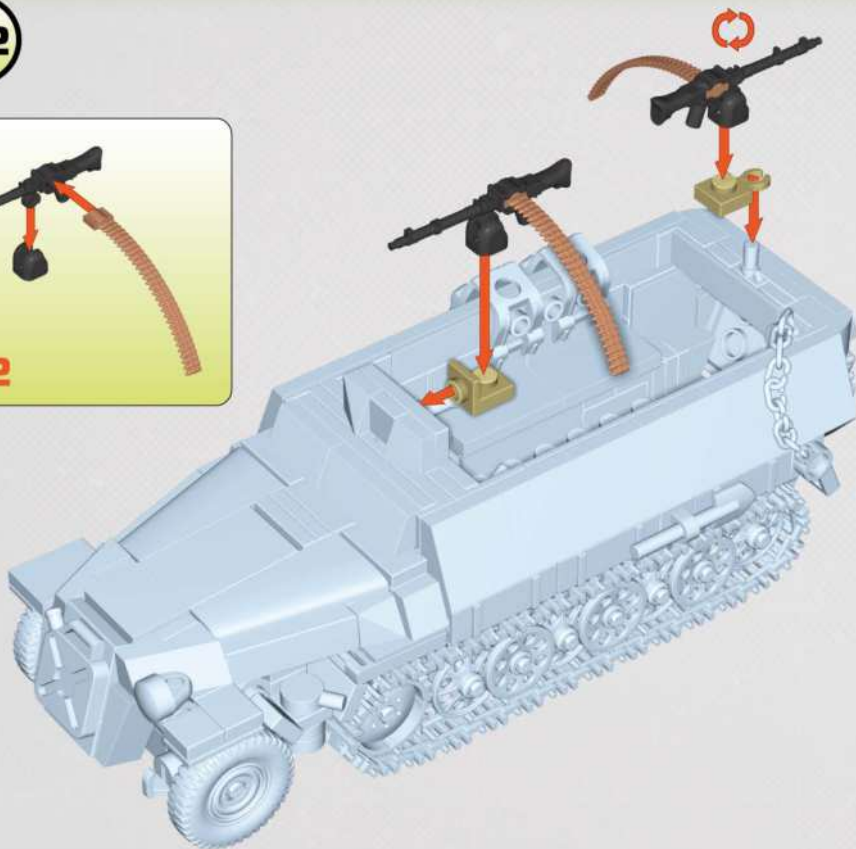









# HISTORICAL COLLECTION



H.M.C M8 SCOTT

★ 2279



MARDER III Ausf. M

+ 2282



BM-13 KATYUSHA (ZIS-6)

★ 2280



ZiS-3 SOVIET GUN

★ 2293





COMPANY OF  
HEROES 3



US AIR SUPPORT CENTER

★ 3042



GERMAN FIGHTING POSITION

⚔ 3043





# COMPANY OF HEROES 3



SHERMAN M4A1  
★ 3044



M3A1 STUART  
★ 3048



8,8cm FLAK  
✚ 3047



PANZER IV Ausf. G  
⚔ 3045



COMPANY OF HEROES



COMPANY OF HEROES 3



CHURCHILL MK. III  
🇬🇧 3046



**WARNING: CHOKING HAZARD.**  
Toy contains small parts.  
Not for children under 3 years.

WWW.COBI BRICKS.COM

21-03049-450

For  
news and  
special deals

Find us on:  
f cobi.bricks  
i cobi.klocki  
y COBI SA