

COMPANY OF HEROES 3

relic
ENTERTAINMENT

© SEGA

3050



MARDER III (Sd.Kfz.139)
IN SERVICE - 1942 - 1945
PLACE OF ORIGIN - GERMANY
TYPE - TANK DESTROYER
COMBAT WEIGHT - 10,67t (23,520Lb)
ARMOUR - 8-50mm (0.31-1.97")
ARMAMENT - 7,62cm PAK 36(r) L/54,8,
1x7,92cm (.312") MG 37(l)
ENGINE - PRAGA EPA I/II, 92kw (123hp)
SPEED - 42km/h (26mph) ON THE ROAD
RANGE - 165km (115mi)
CREW - 4

+

PAD PRINTED
NO STICKERS

Printed in EU



420 1

MARDER III (Sd.Kfz.139)

SCALE 1:35

1

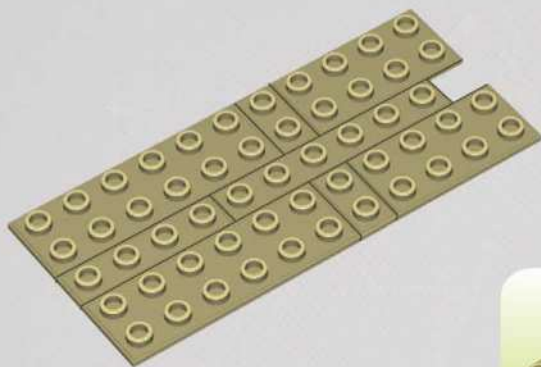

x2



x1



x1



x2



x2

2

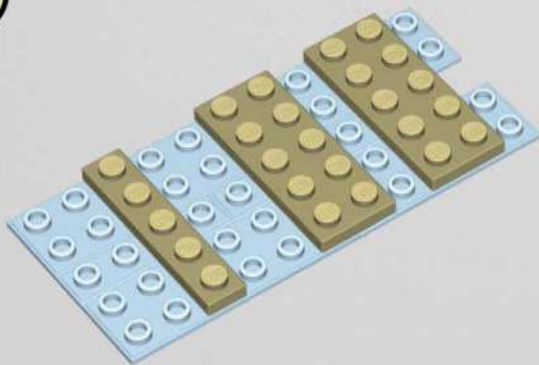

x2



x1

3

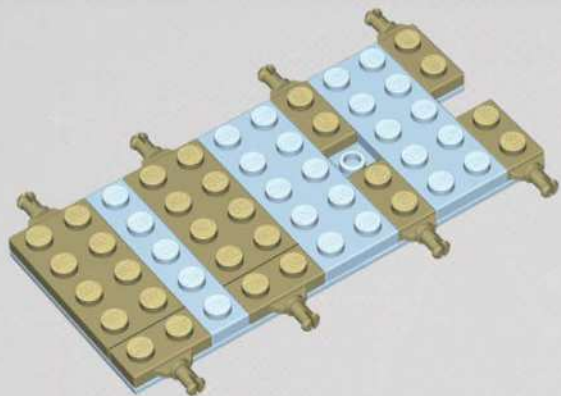

x2



x2



x4

4

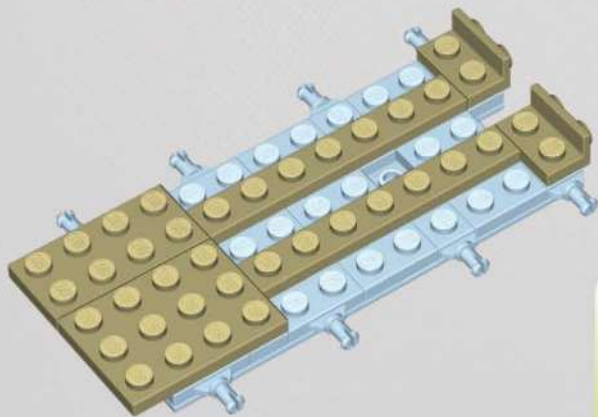

x1



x1



x2



x2

5

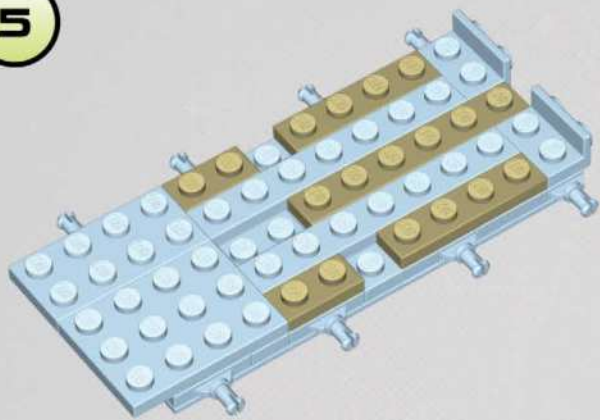

x1



x2



x2

6

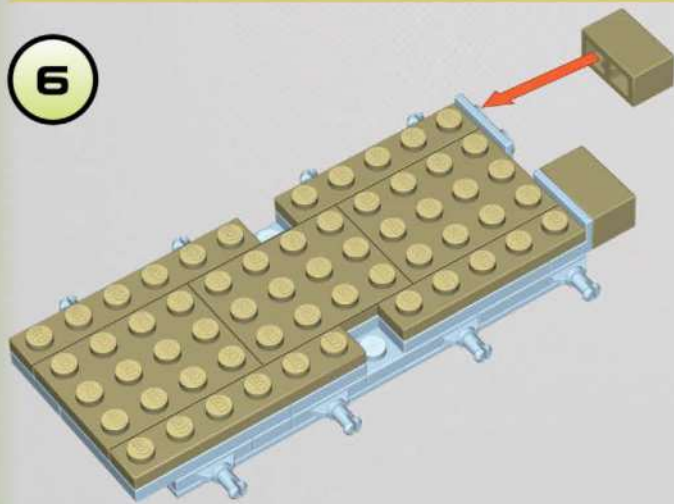

x3



x2



x2



x2

7

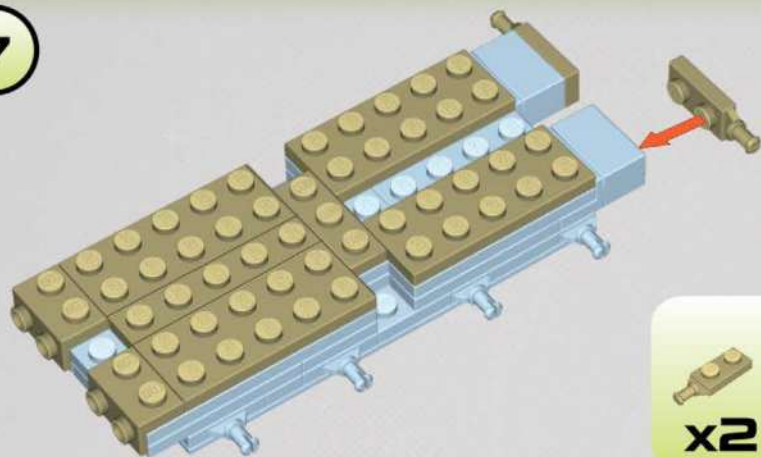

x2



x4



x1



x1



x2

8

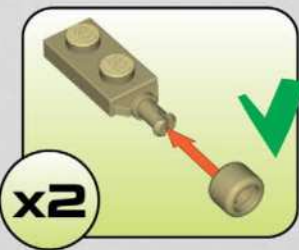
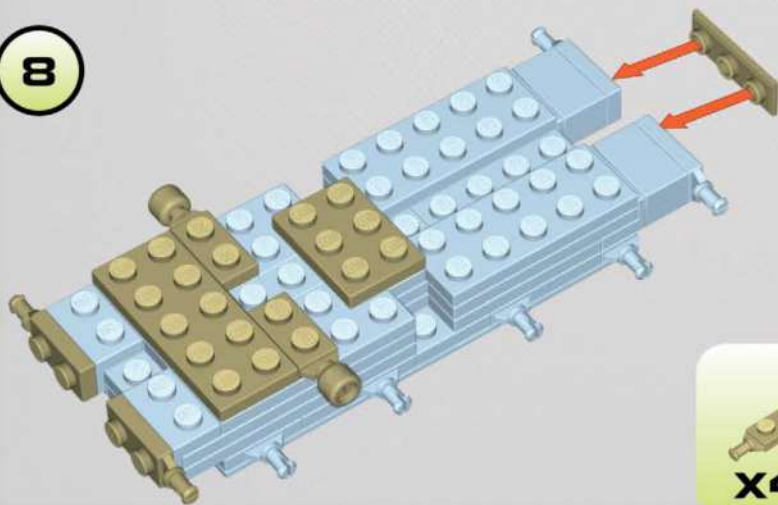

x2

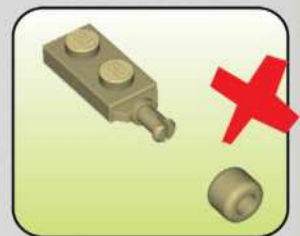

x4



x2



x1



x1



x1

9

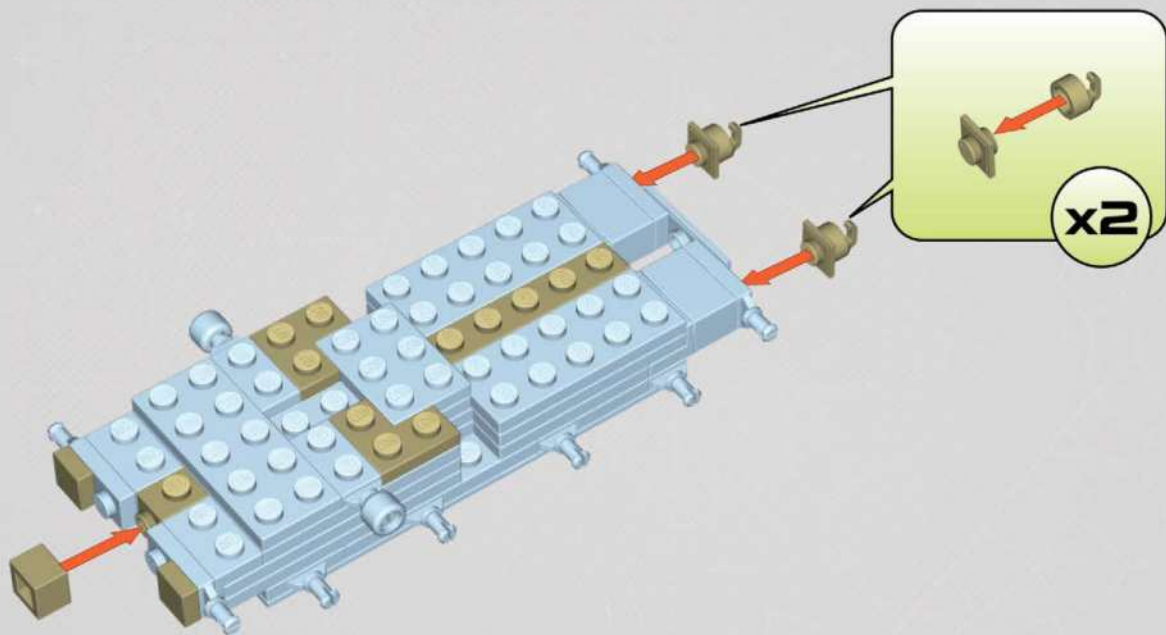

x2



x1



x1



x2



x1



x2



x2

10

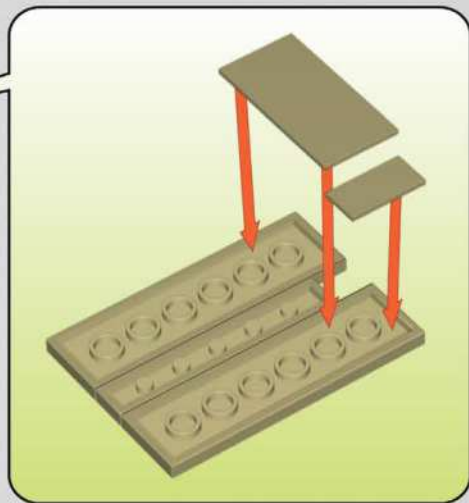
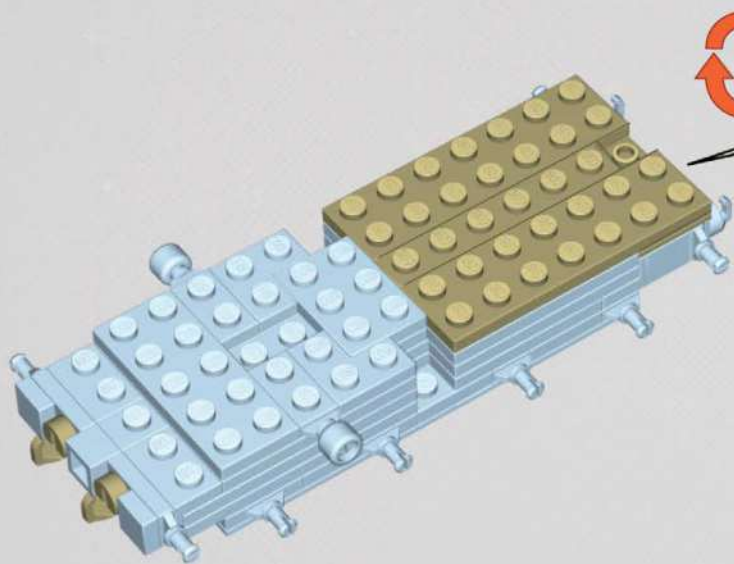



x2

x2

x1

x1

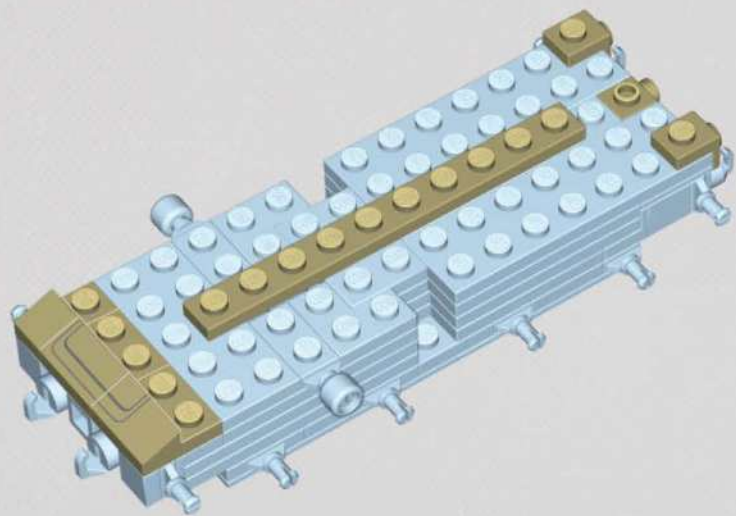
x1



x1



x1



x1



x1



x1



x2

12

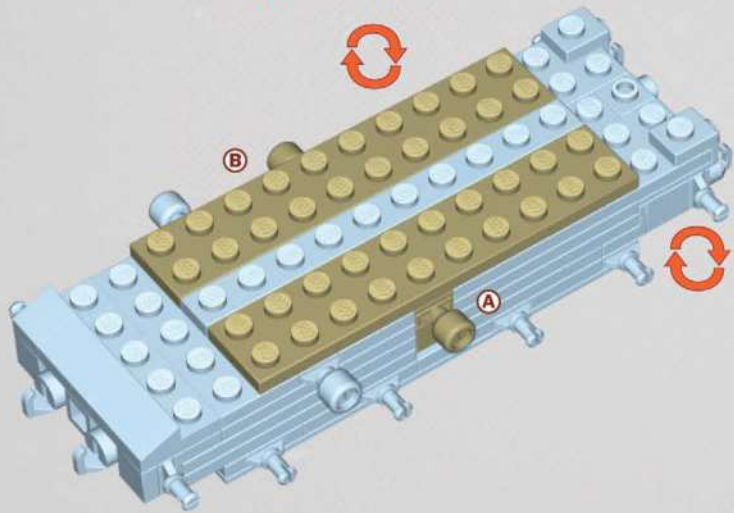
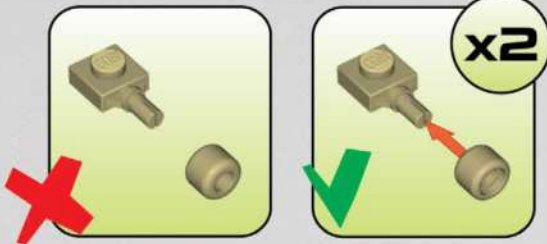

x2



x2



x2



x2



x2

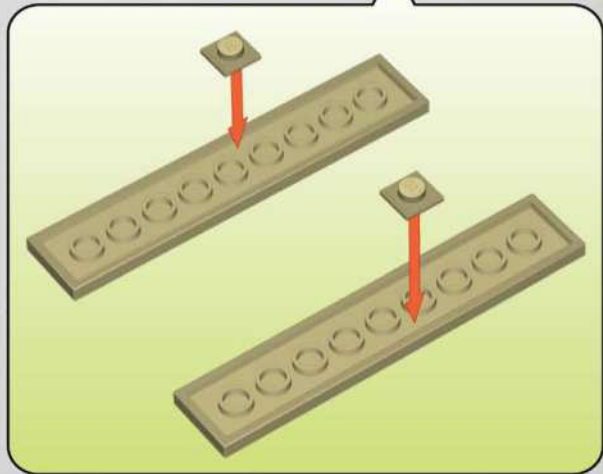
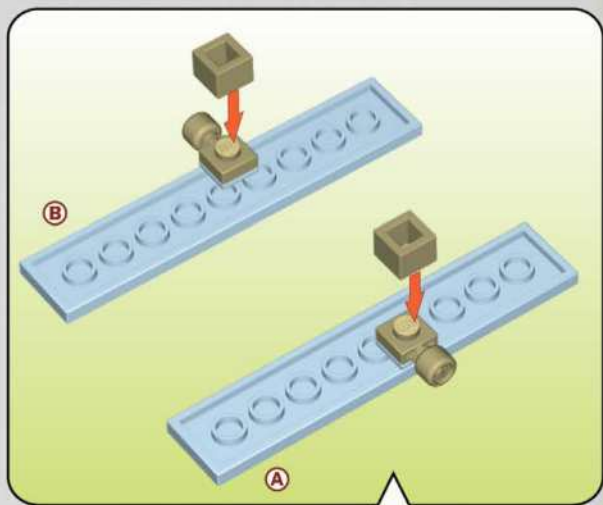

13

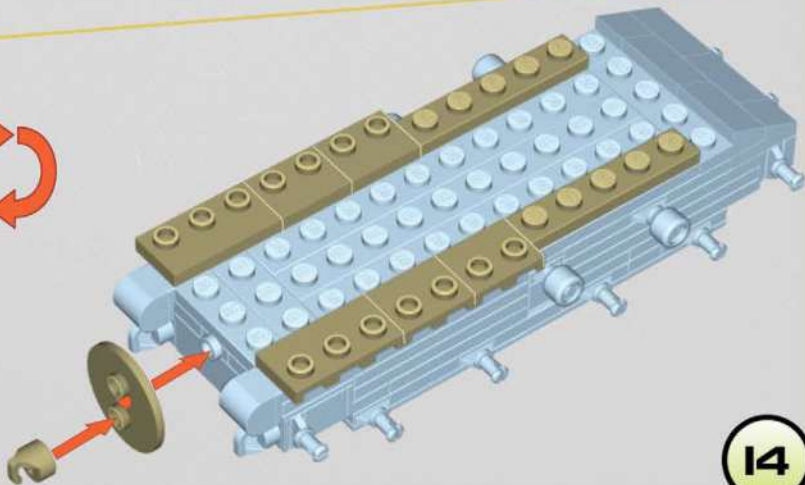
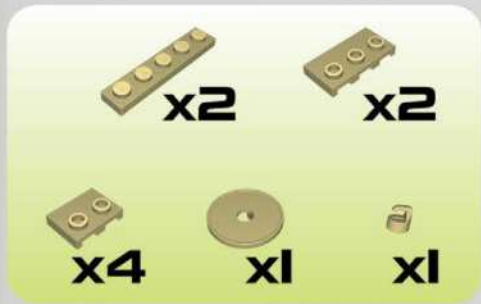
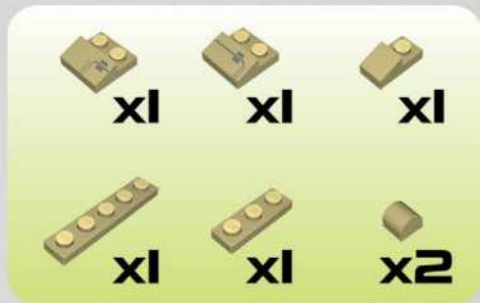
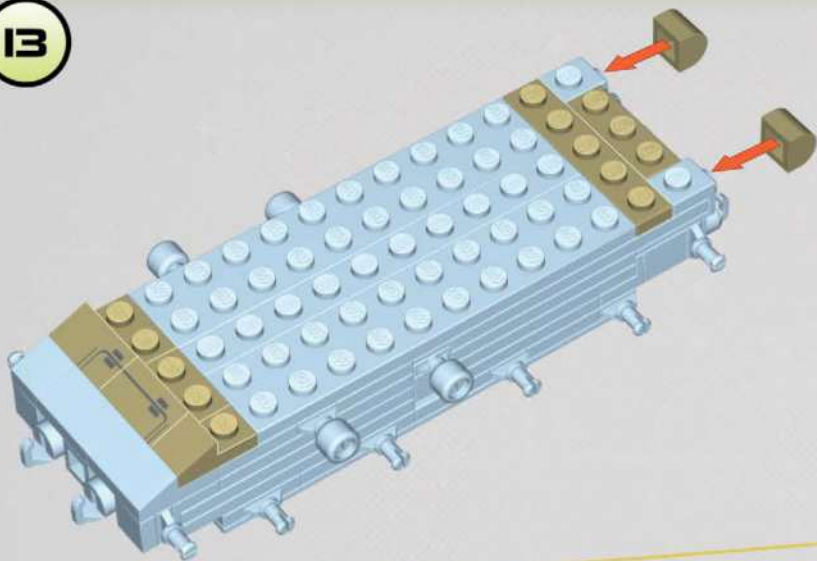

14

15

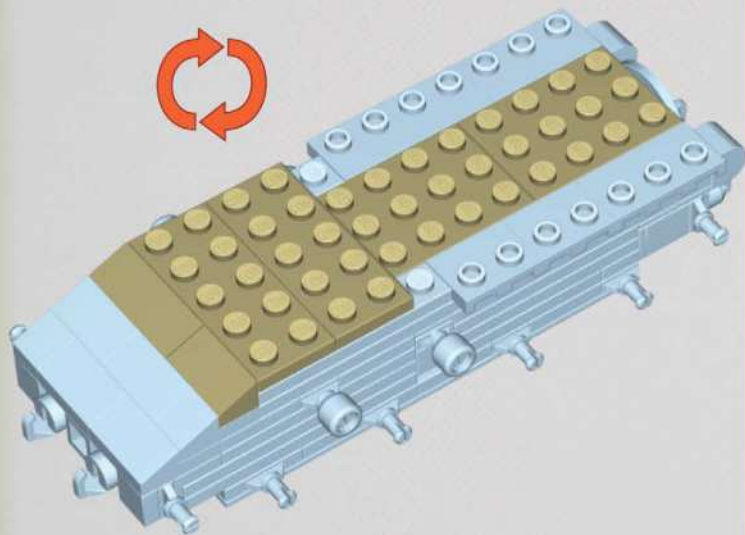

x1



x1



x2



x2

16

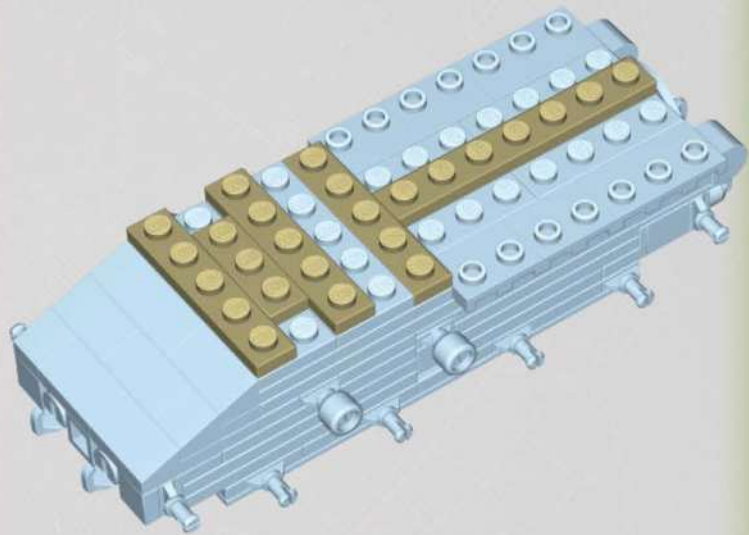

x3



x1



x1

17

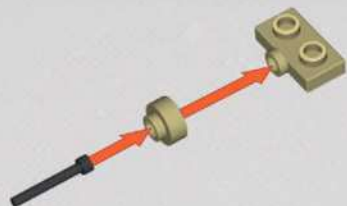

x1



x1



x1

18

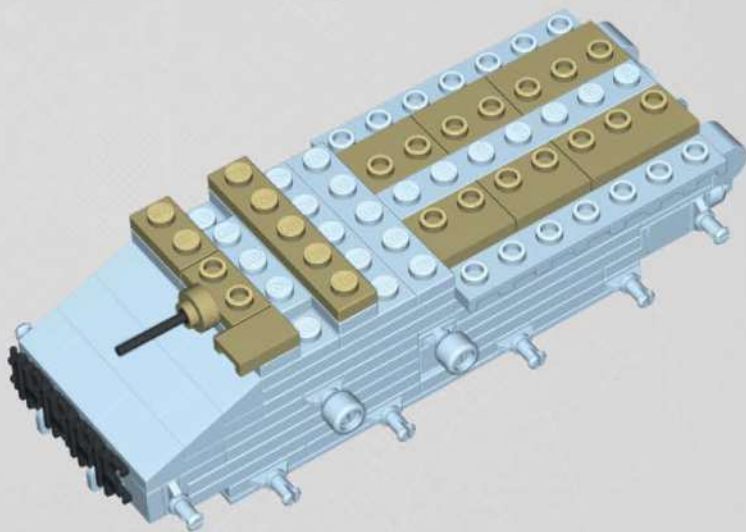
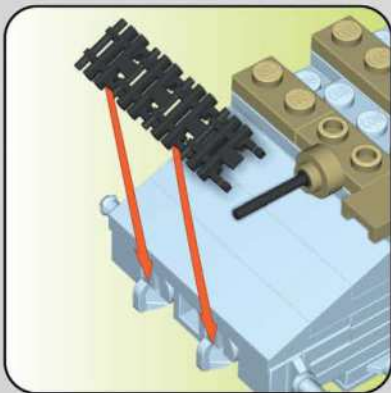
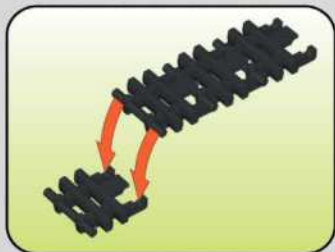

x4



x1



x1



x1



x4



x2

19

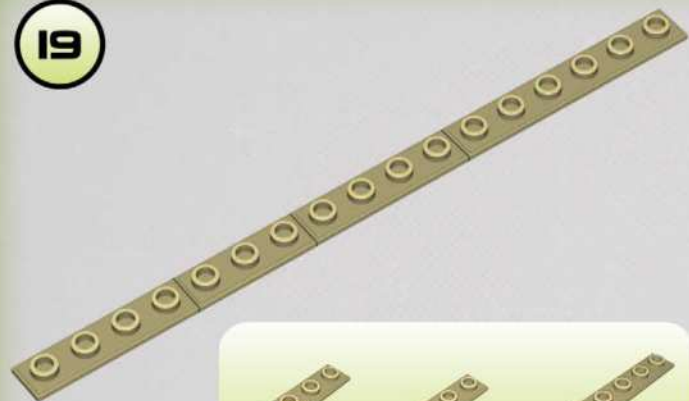

x2



x1



x1

20

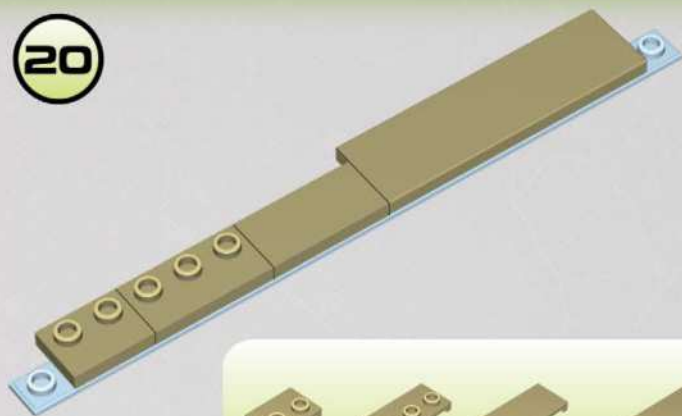

x1



x1



x1



x1

21

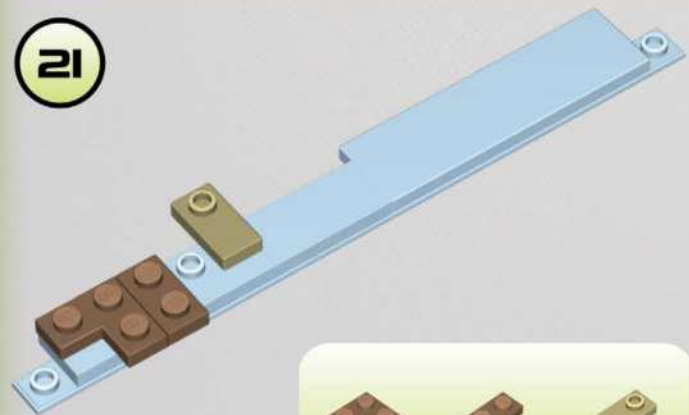

x1



x1



x1

22

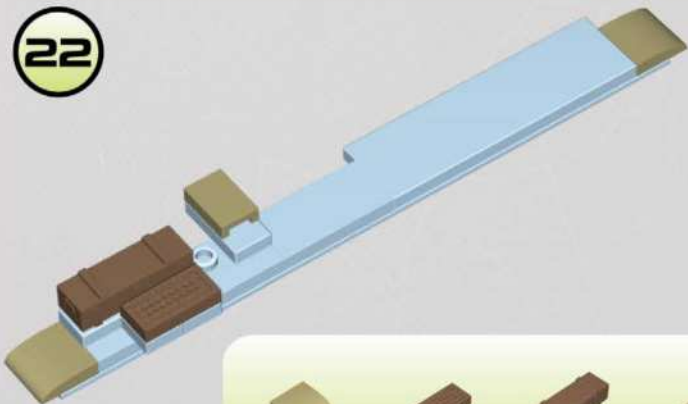

x2



x1



x1



x1

23



x2



x1



x1

24

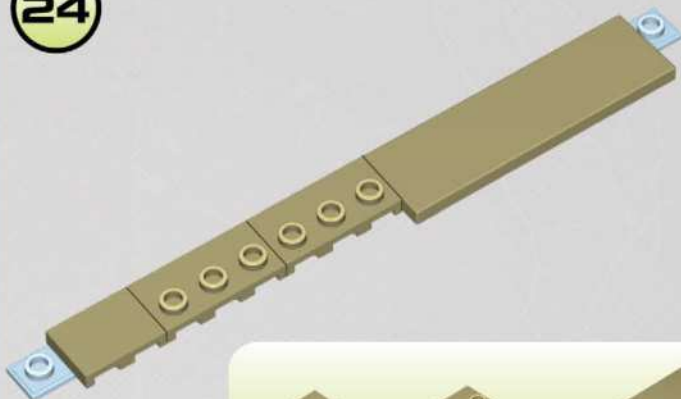

x1



x2



x1

25

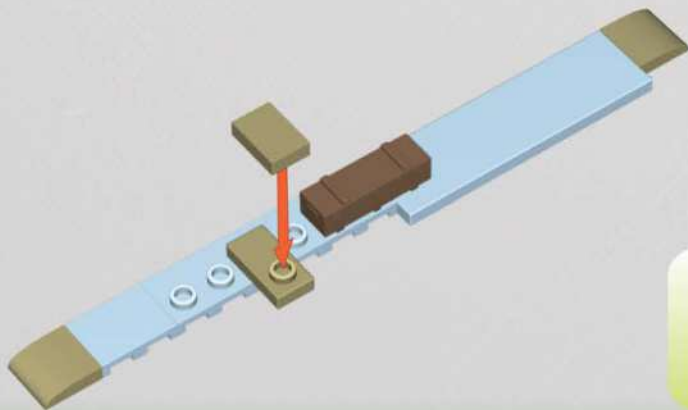

x2



x1



x1



x1

26

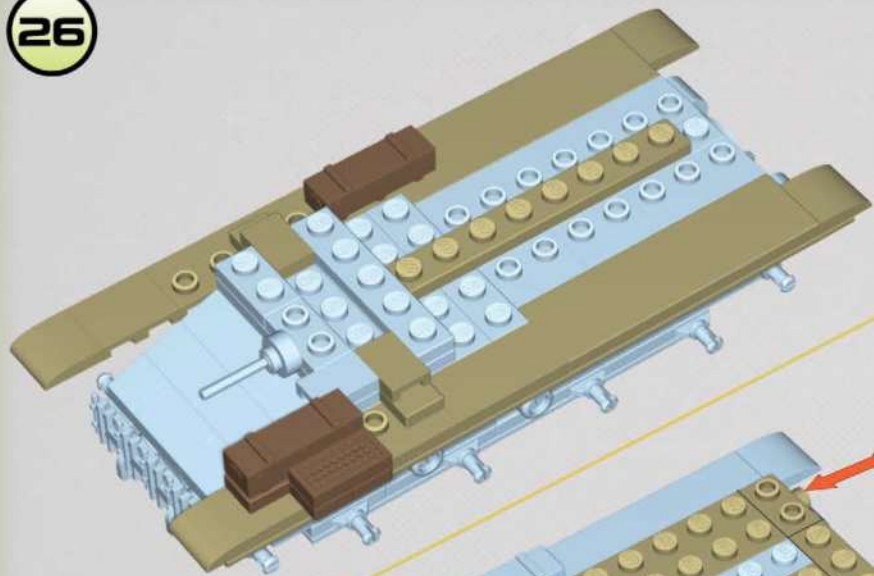

x1



27

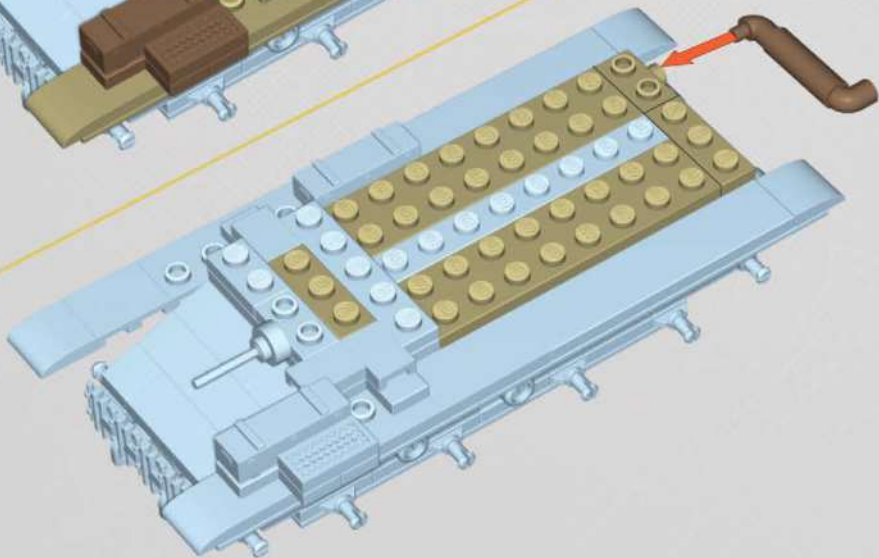

x2



x1



x2



x2



x1

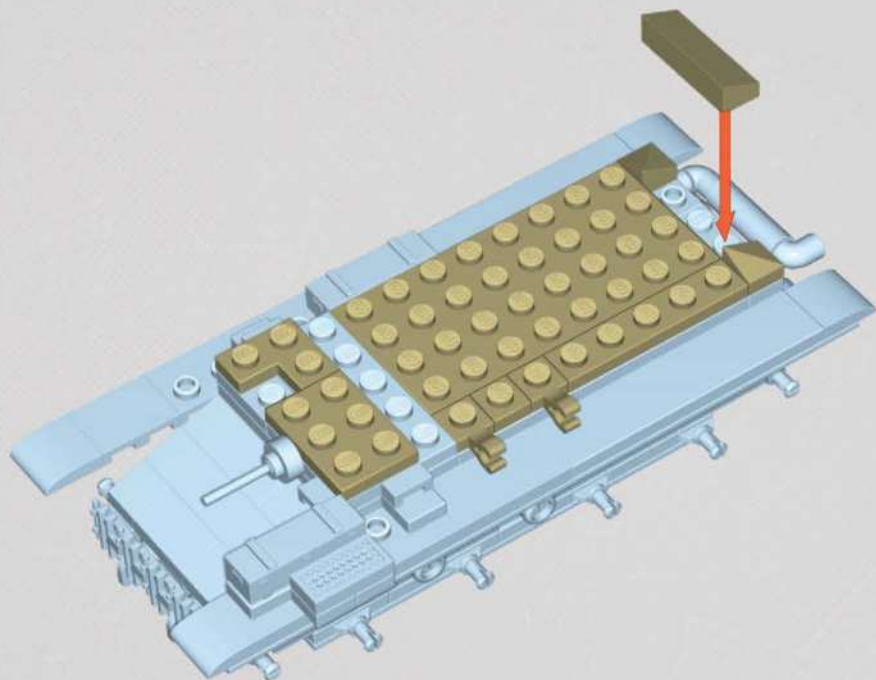

x1



x1



x2



x1



x1



x1







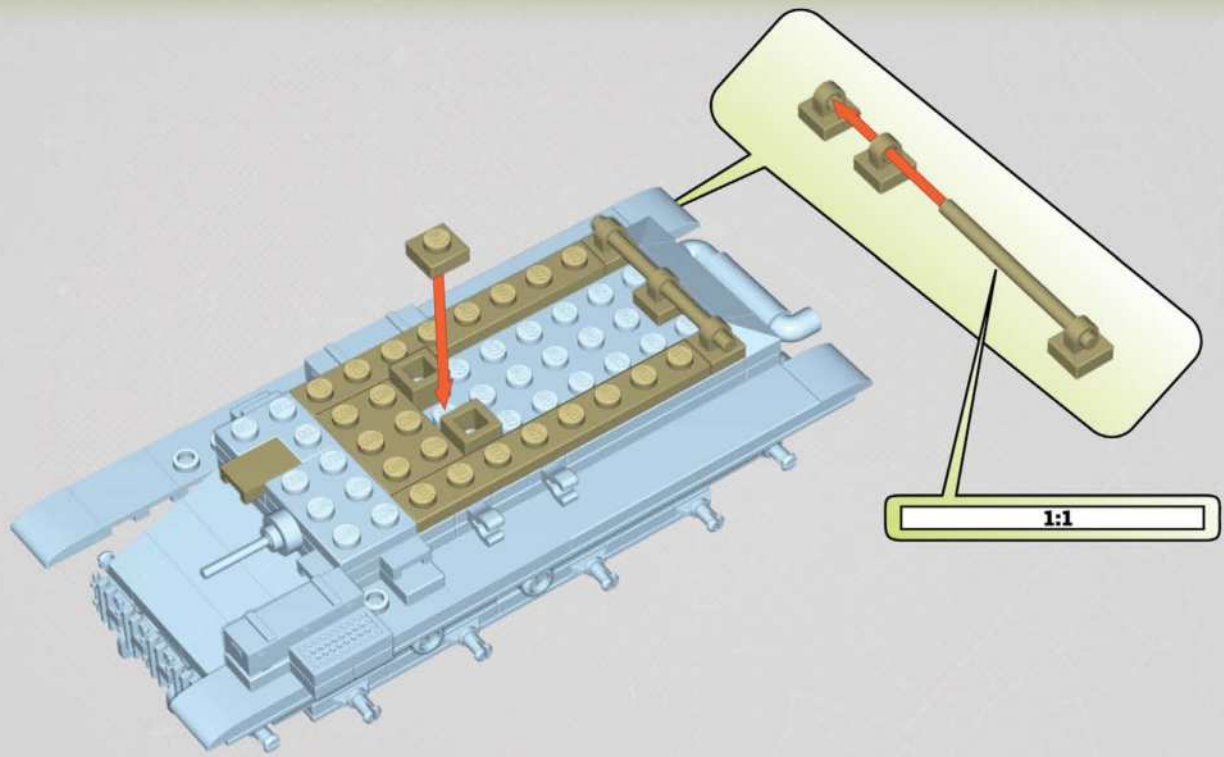

x2



x1



-  x1
-  x1
-  x2
-  x2
-  x1
-  x3
-  x1

30

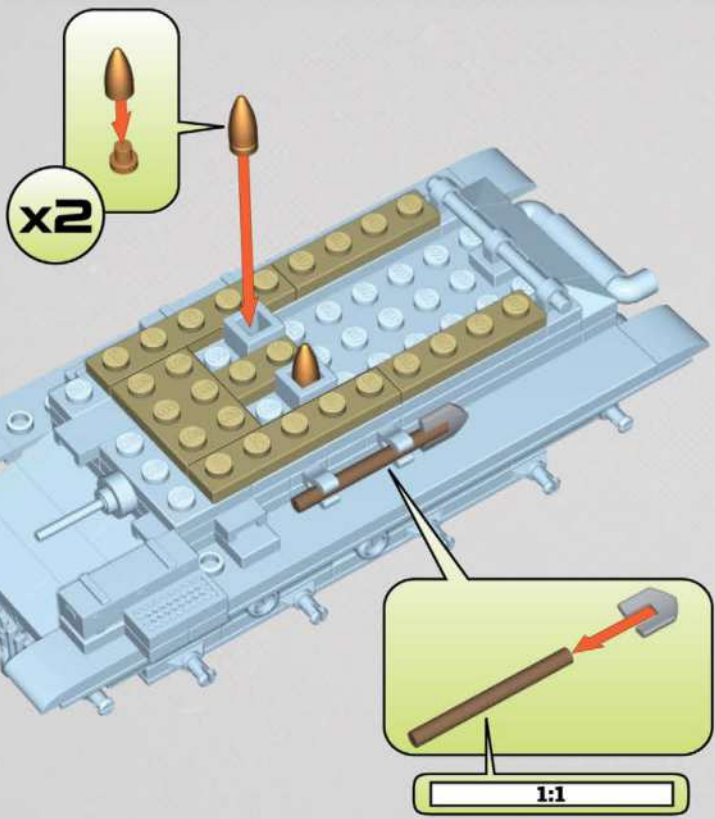

x2

1:1

-  x1
-  x2
-  x2
-  x1
-  x2
-  x2
-  x1
-  x1

31

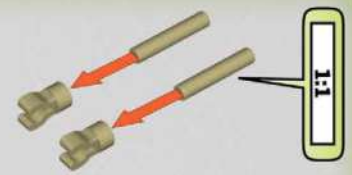

1:1



x2



x2

32

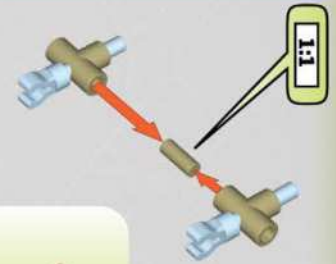

1:1



x2



x1

33

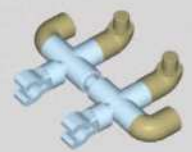

x4

34

1:1

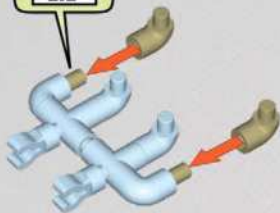

36

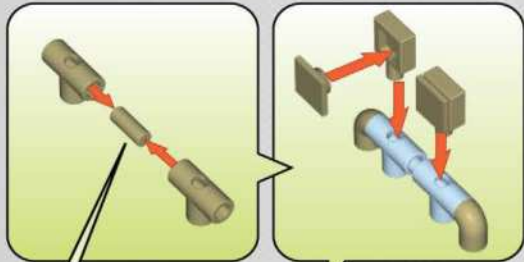
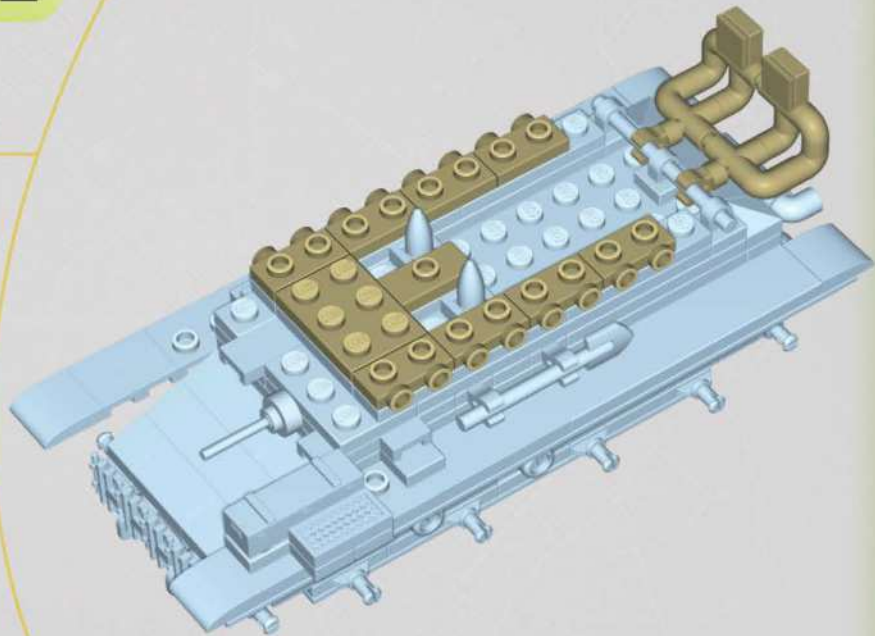

1:1

35

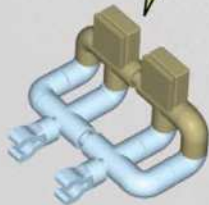

37

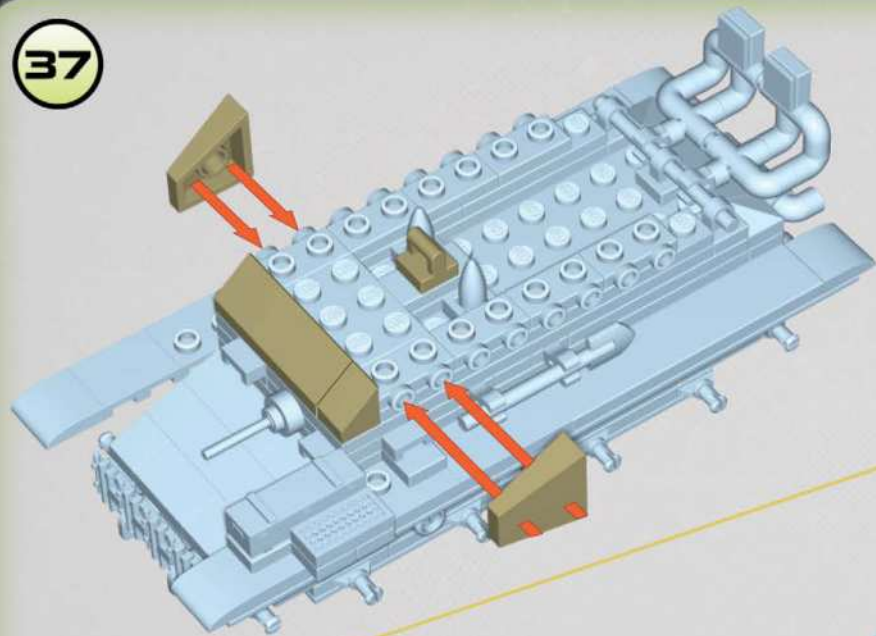

BE CAREFUL: NOTICE THE DIFFERENCE



x1

x2

x2

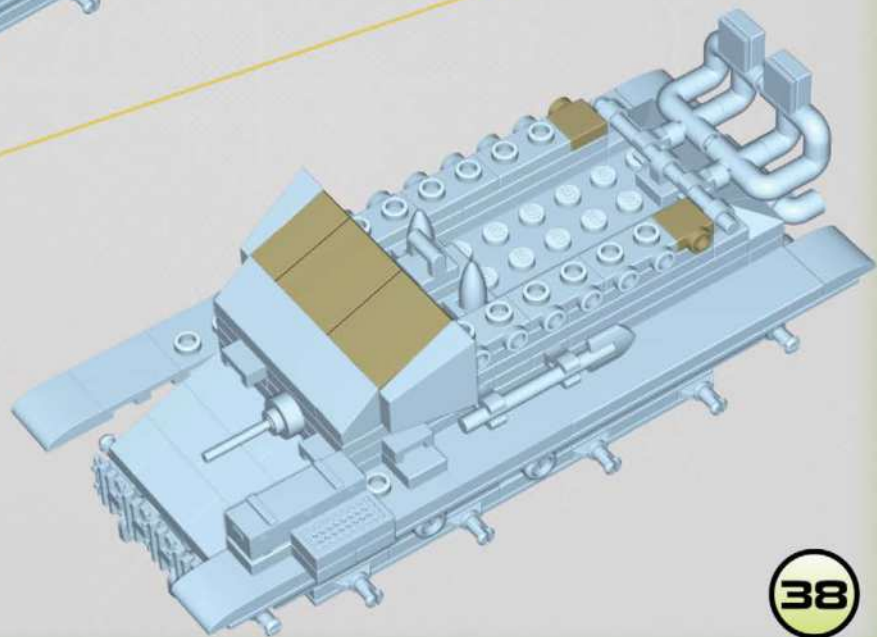

38

39

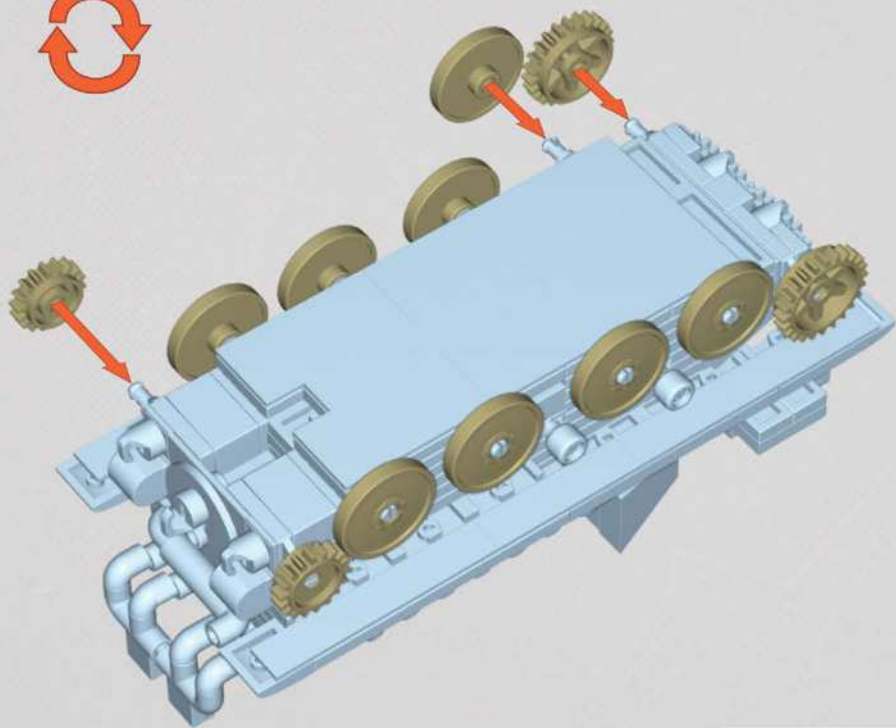

x2



x8



x2

40

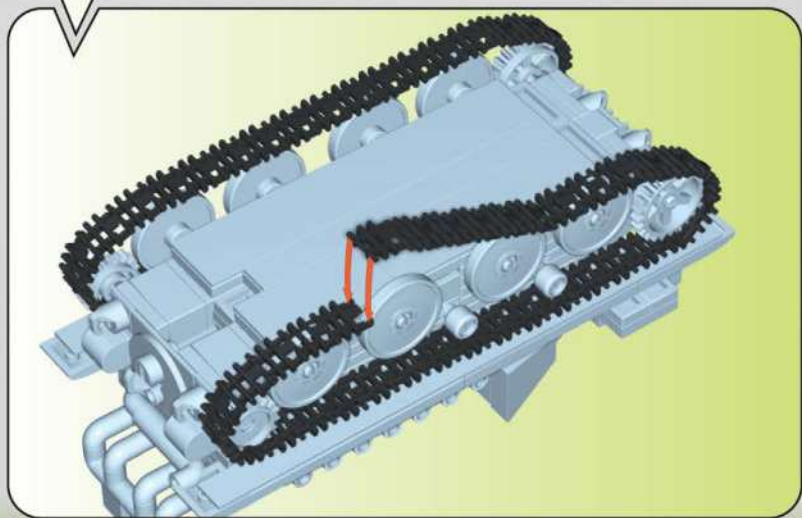
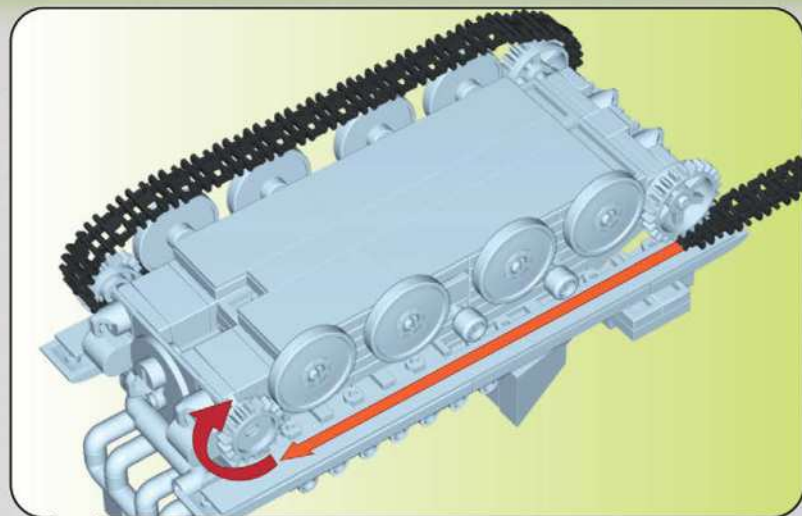
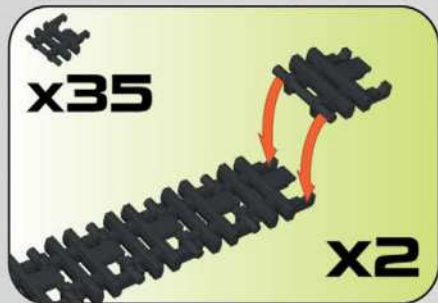

41

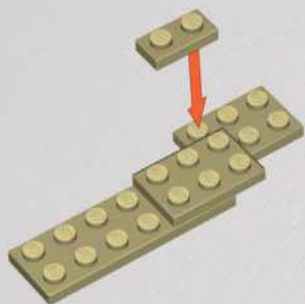

42

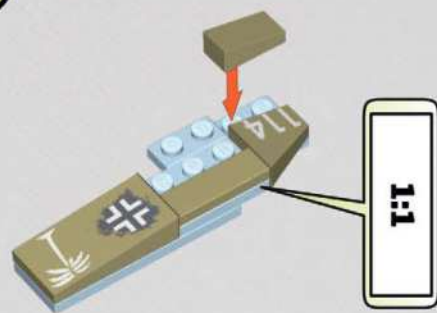

43

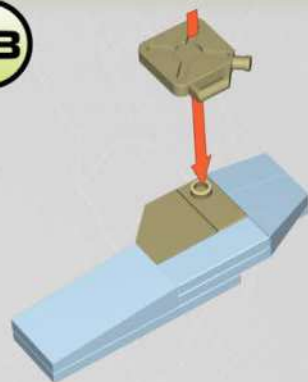

44

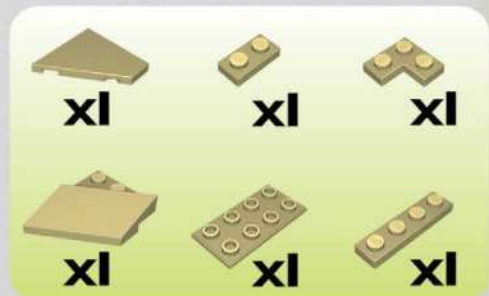
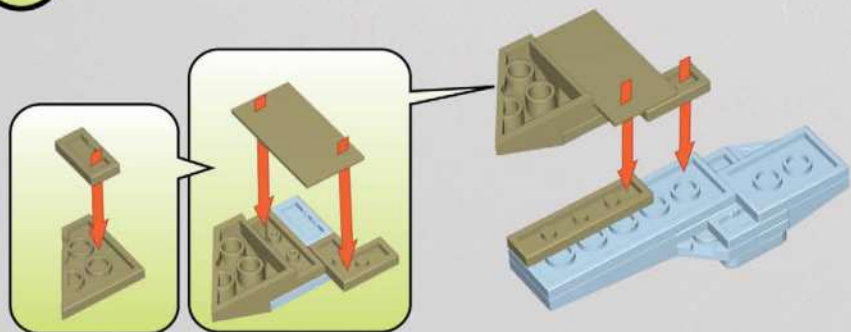

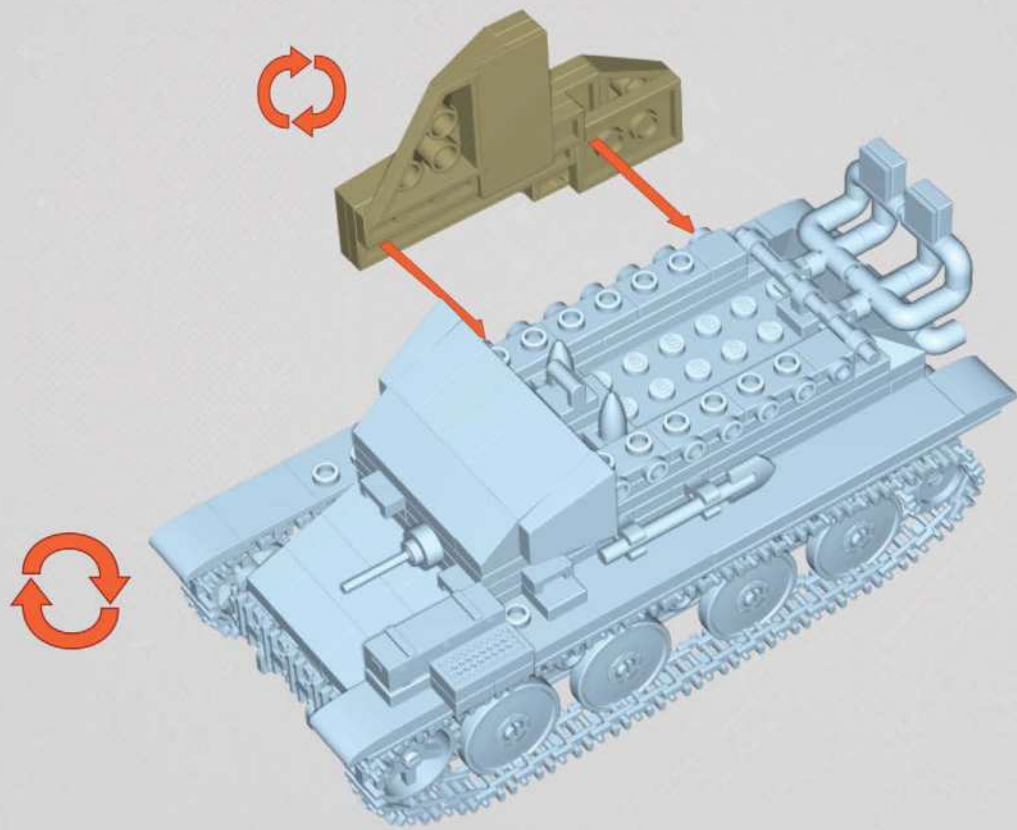

46

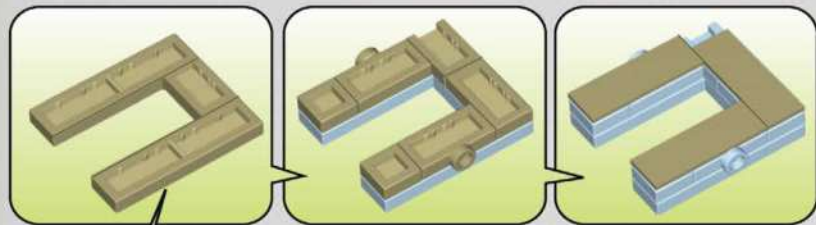

1:1

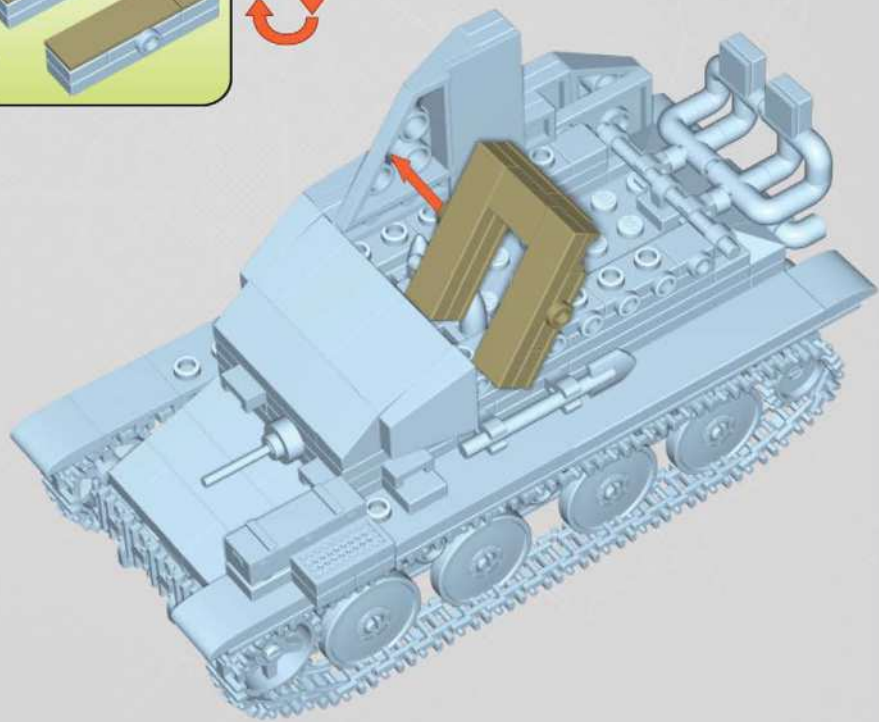

47

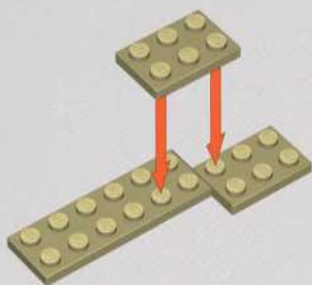

48

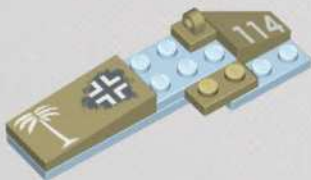

49

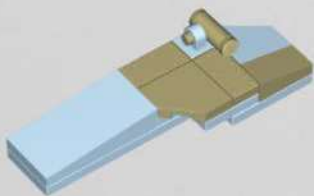

50

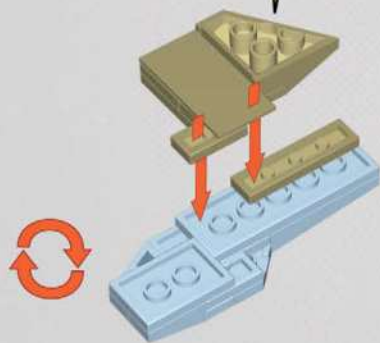
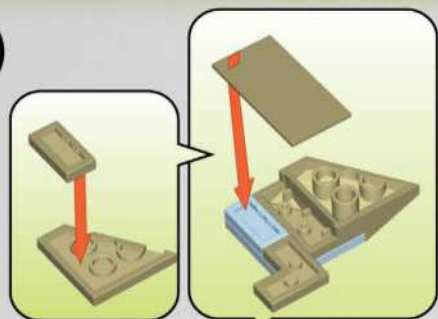

x1



x1



x1



x1



x1



x1

51

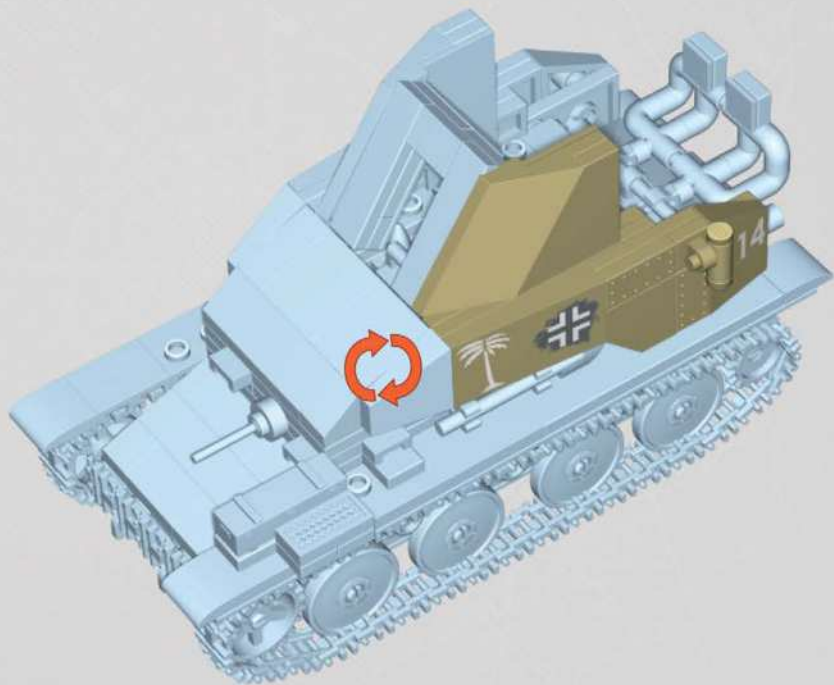

52



x1



x2



x2

53



x1



x1



x1



x1



x1



x1

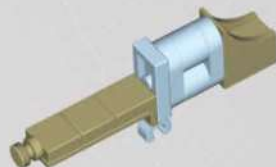
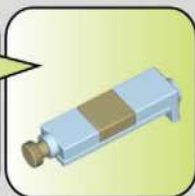
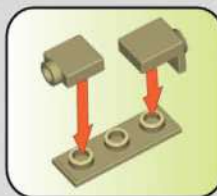
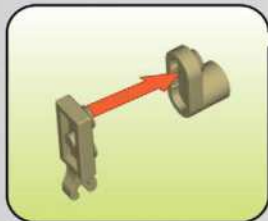

54

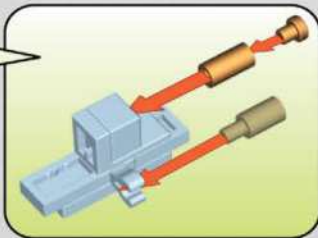
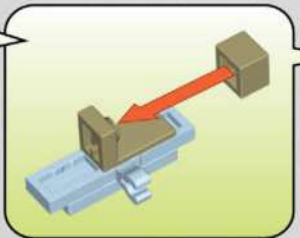

x1



x2



x1



x1



x1



x1



x1



x1

55

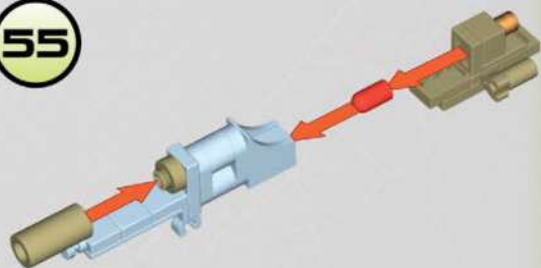

x1



x1



x1

56

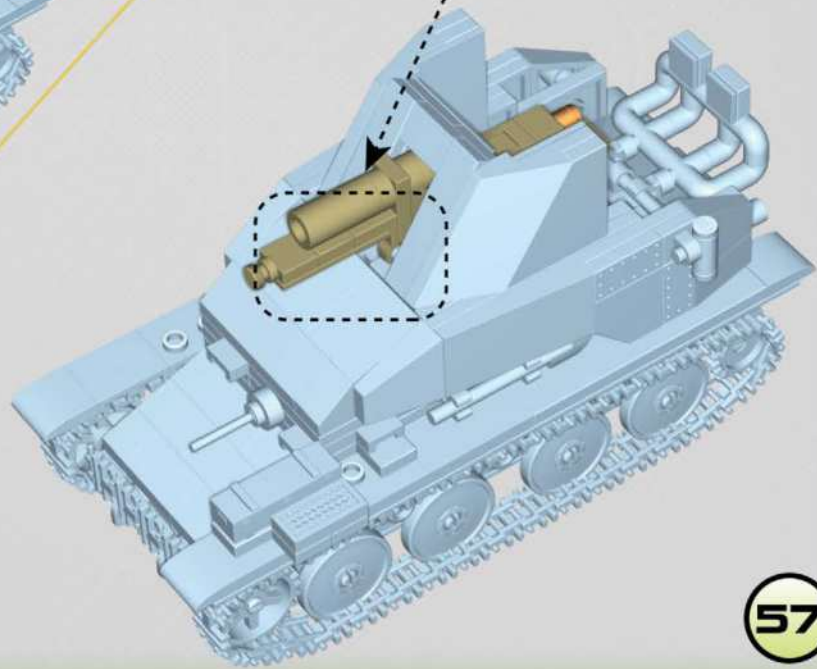
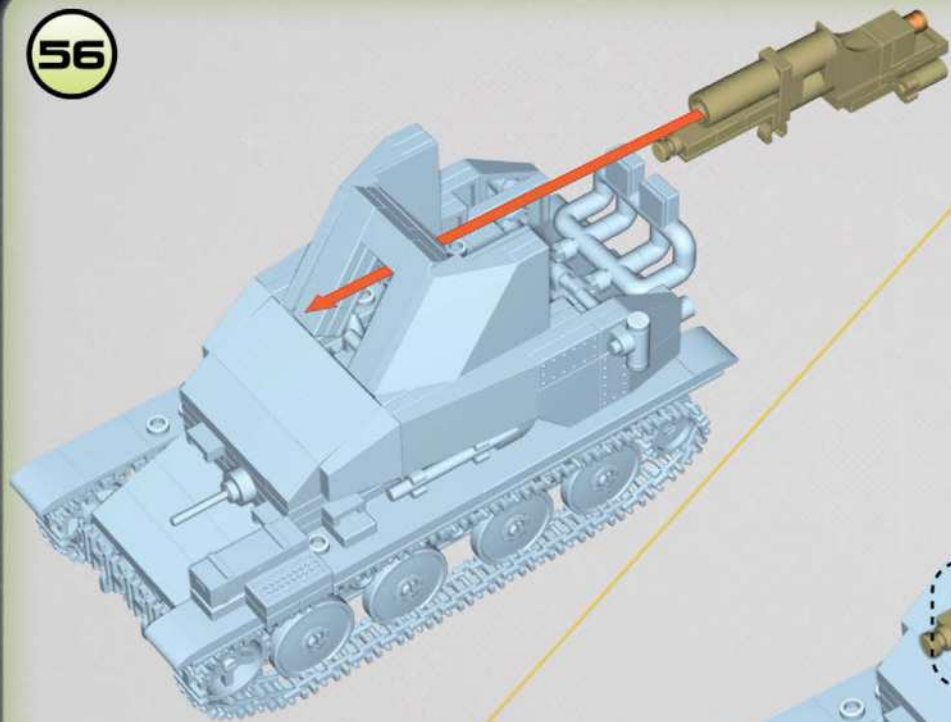

57

58

1:1

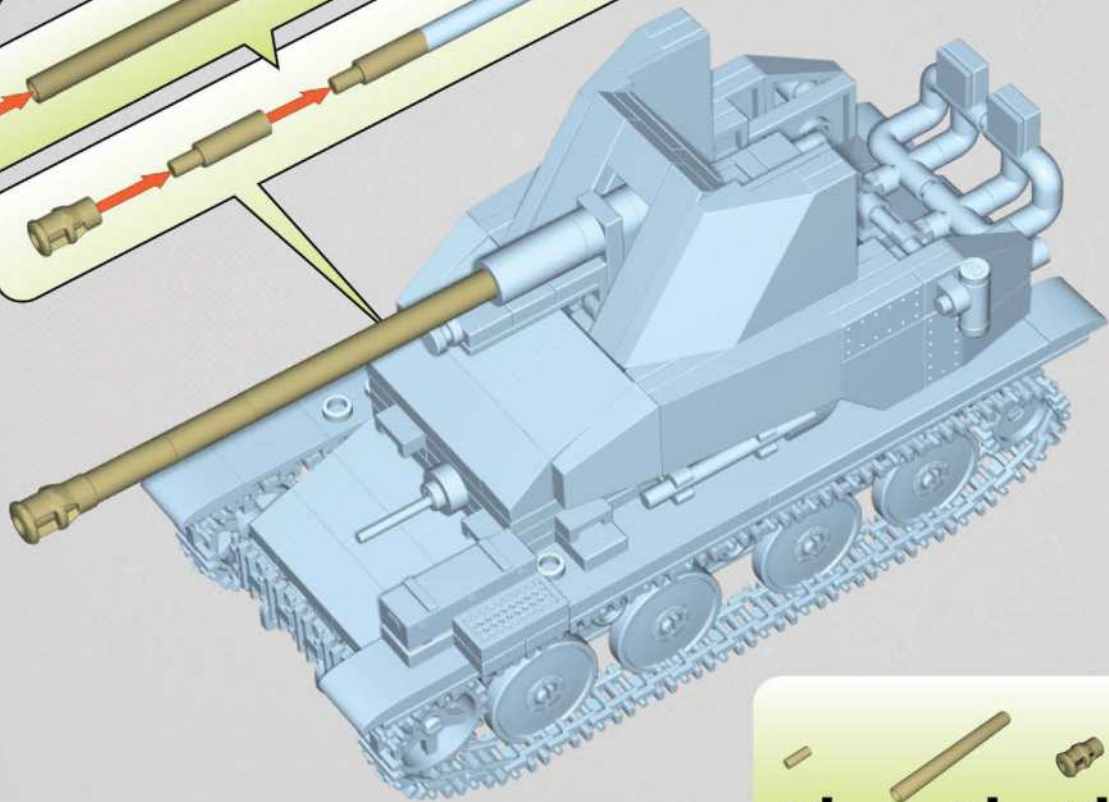

x1



x1



x1



x2

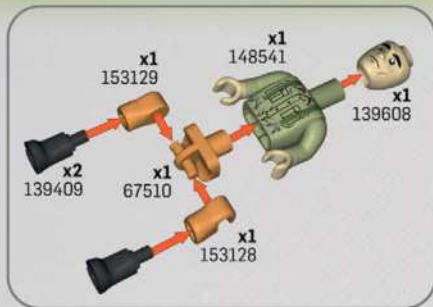



x9
155088

x1
155446

x2
155447

x1
155425

x1
155426

x5
155448

x1
155454

x1
155453

x6
155080

x1
155456

x1
155455

x1
155459

x1
155458

x3
154997

x3
105904

x1
154993

x2
152361

x8
155460

x1
147091

x2
153550

x2
155010

x1
155461

x1
155462

x8
155463

x4
155464

x2
155465

x2
155466

x4
155467

x1
155468

x74
102496

x1
155470

x2
155469

x5
155138

x5
155471

x2
155011

x1
91751

x1
154982

x1
141492

x2
155020

x1
155472

x1
155004

x1
104860

x1
155473

x3
155085

x3
155444

x1
155079

x9
155084

x2
155449

x2
155450

x2
155075

x1
77552

x2
155451

x2
155452

x1
155457

x2
155081



HISTORICAL COLLECTION



H.M.C M8 SCOTT

★ 2279



MARDER III Ausf. M

+ 2282



ZiS-3 76MM DIVISIONAL GUN M1942

★ 2293



BM-13 KATYUSHA (ZiS-6)

★ 2280





COMPANY OF
HEROES 3



US AIR SUPPORT CENTER

★ 3042



GERMAN FIGHTING POSITION

⚔ 3043



COMPANY OF HEROES 3



SHERMAN M4A1
★ 3044



M3A1 STUART
★ 3048



8,8cm FLAK
✚ 3047



PANZER IV Ausf. G
⚔ 3045



COMPANY OF HEROES



CHURCHILL MK. III
🇬🇧 3046



COMPANY OF HEROES 3



WARNING: CHOKING HAZARD-
Toy contains small parts.
Not for children under 3 years.

WWW.COBIBRICKS.COM

21-03050-411

For
news and
special deals

Find us on:
  [cobi.bricks](https://www.facebook.com/cobi.bricks)
[cobi.bricks](https://www.instagram.com/cobi.bricks)
 [cobi.bricks](https://www.youtube.com/cobi.bricks)
COBI SA