

HISTORICAL COLLECTION

WORLD WAR II

EXECUTIVE EDITION



IOWA-CLASS BATTLESHIP
IOWA (BB-61) / NEW JERSEY (BB-62)
MISSOURI (BB-63) / WISCONSIN (BB-64)

PLACE OF ORIGIN - UNITED STATES
 TYPE - IOWA-CLASS BATTLESHIP
 IN SERVICE - 1940 - 1992
 BUILT - 1940 - 1944 (PLANNED 6, BUILT 4)
 BUILDERS - NEW YORK NAVAL SHIPYARD (BB-61 & BB-63)
 PHILADELPHIA NAVAL SHIPYARD (BB-62, BB-64)
 STATUS - BB-61 MUSEUM SHIP IN LOS ANGELES, CALIFORNIA
 BB-62 MUSEUM SHIP IN CAMDEN, NEW JERSEY
 BB-63 MUSEUM SHIP IN PEARL HARBOR, HAWAII
 BB-64 MUSEUM SHIP IN NORFOLK, VIRGINIA
 DISPLACEMENT - 48592t (107,127,031lb)
 LENGTH - 270,4m (887' 3")
 BEAM - 33m (108' 2")
 INSTALLED POWER - 8x WATER-TUBE BOILERS
 340619shp (254000kw)
 PROPULSION - 4x SCREWS, 4x GEARED STEAM TURBINES
 ARMAMENT - MAIN ARTILLERY 3x TRIPLE 46cm (18.1") GUNS
 9x 406mm (16") GUNS
 20x 127mm (5") GUNS
 80x 40mm (1.57") AA GUNS
 49x 20mm (.787") AA GUNS
 AIRCRAFT CARRIED - 3x FLOATPLANES
 SPEED - 33knots (61,1km/h, 38mph)
 RANGE - 14890nm (27580km, 17140mi)
 CREW - 2700 OFFICERS AND MEN



4836

PAD PRINTED
NO STICKERS

Printed in EU



WARNING: CHOKING HAZARD-
 Toy contains small parts.
 Not for children under 3 years.

2685

IOWA-CLASS BATTLESHIP

SCALE 1:300



+



+



BE CAREFUL: NOTICE THE DIFFERENCE



UWAGA: RÓŻNE KLOCKI



1

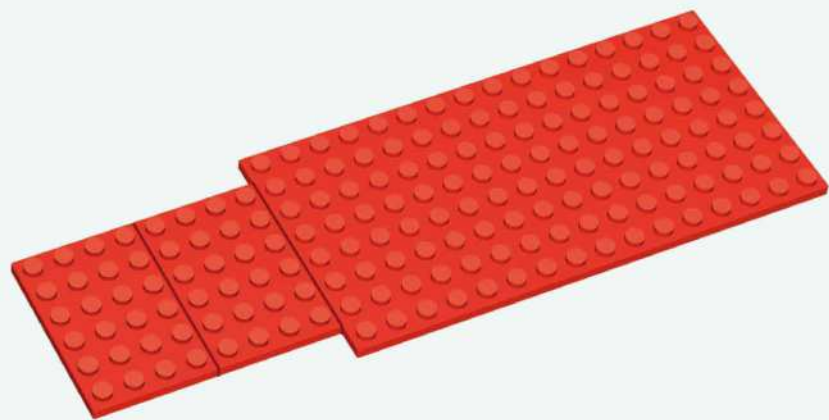

2

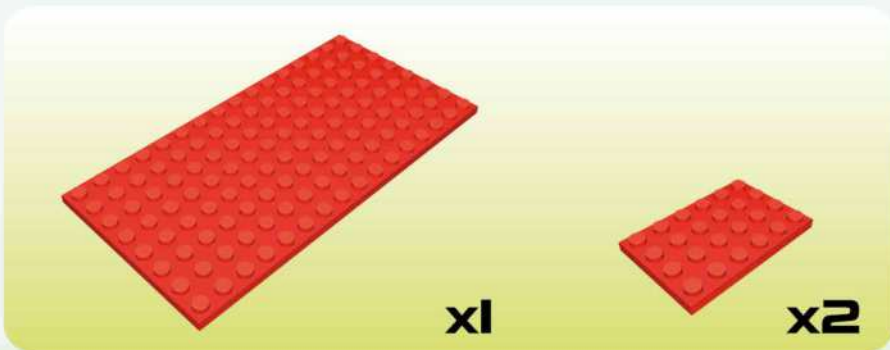
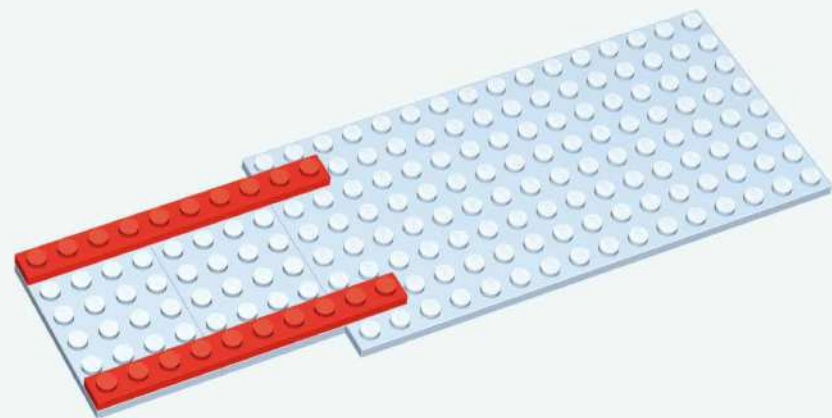

3

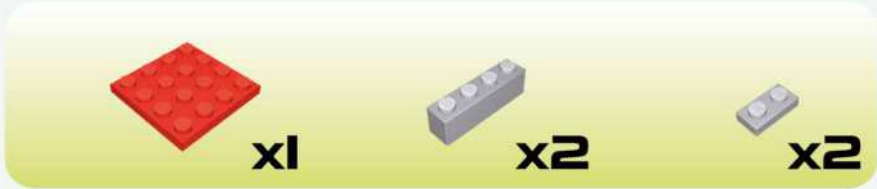

4

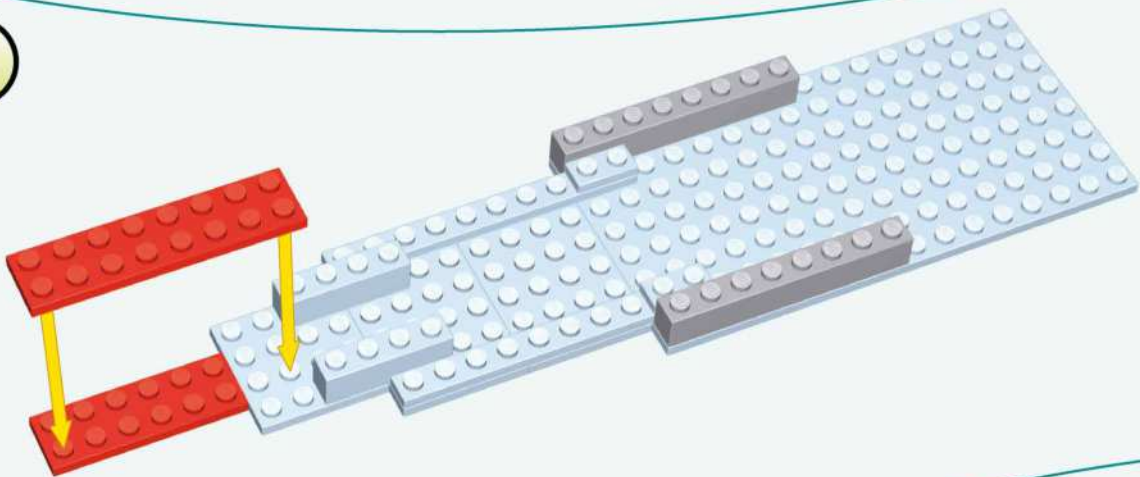

5

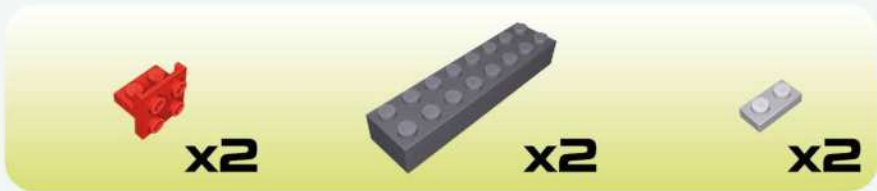
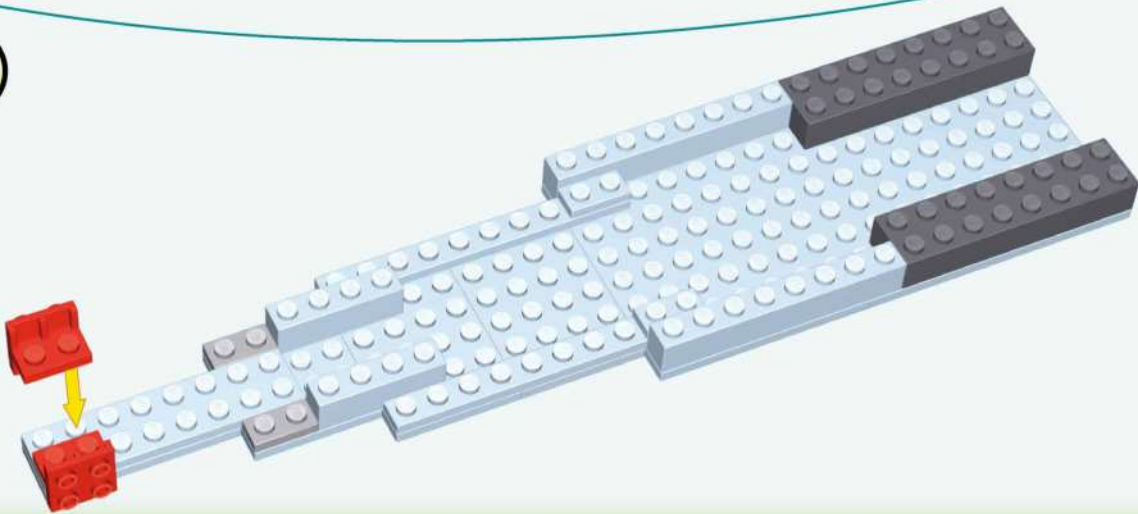

6

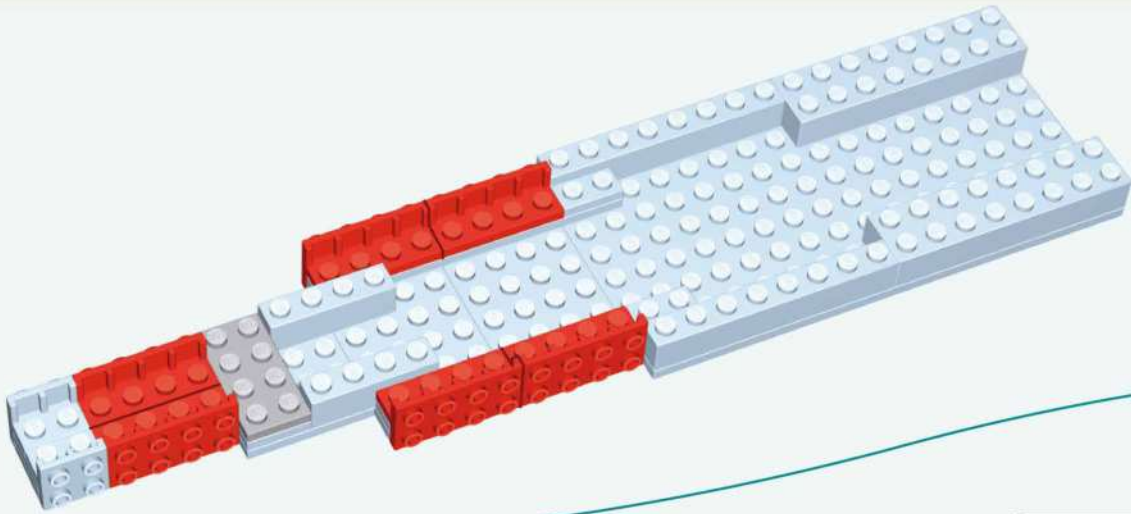

7

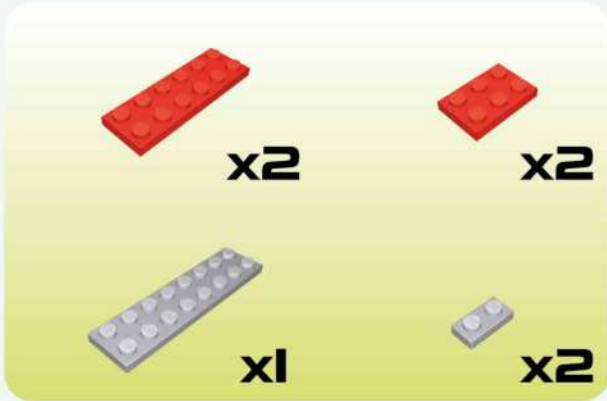
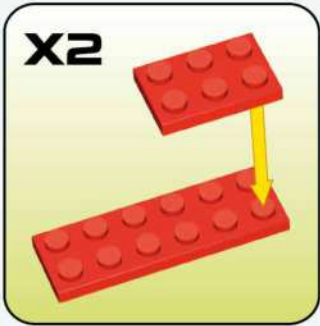
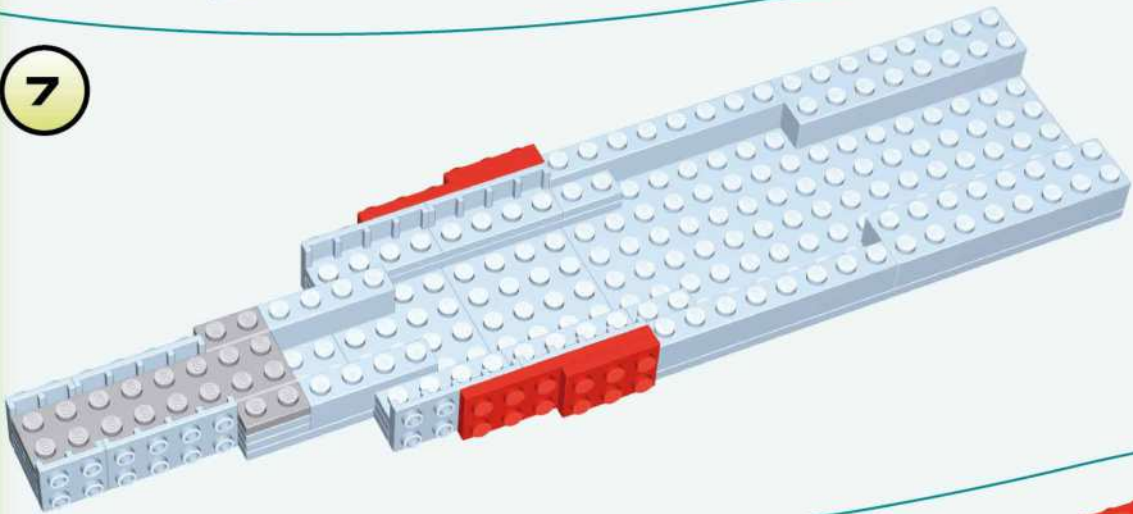

8

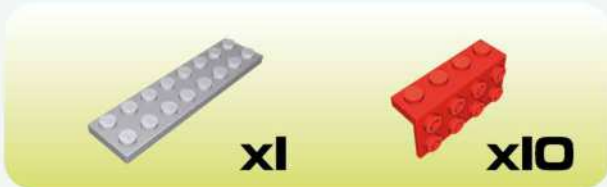
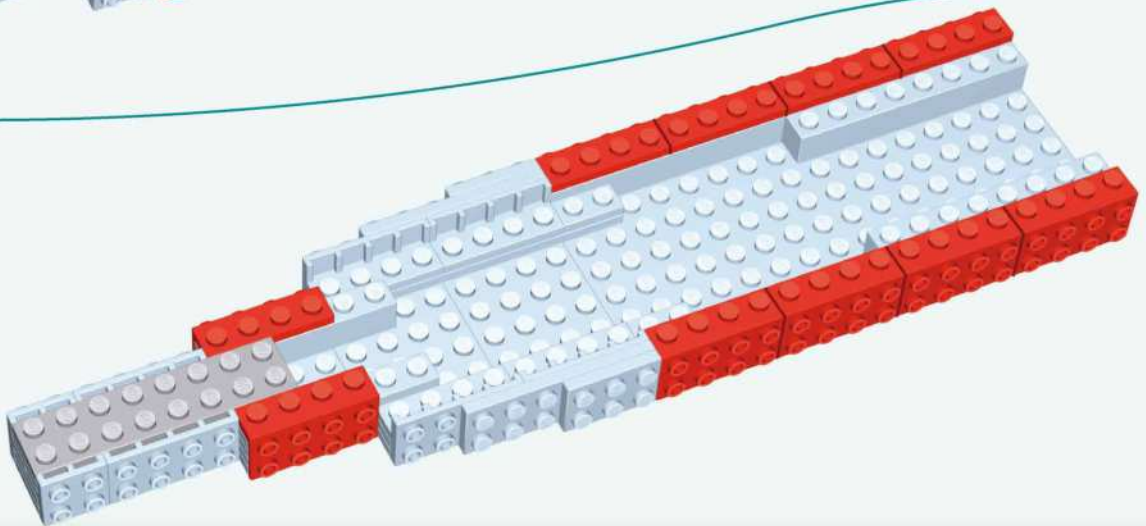

9

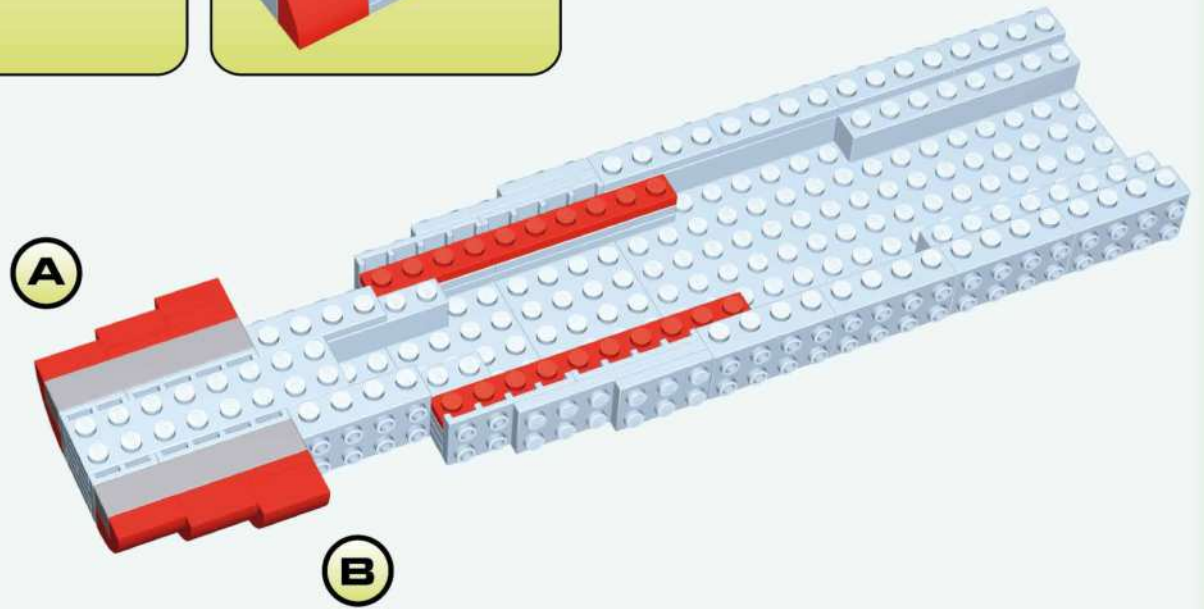
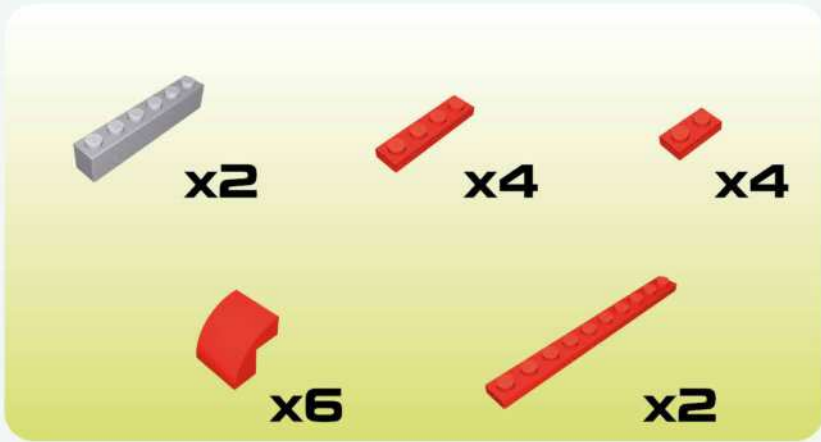
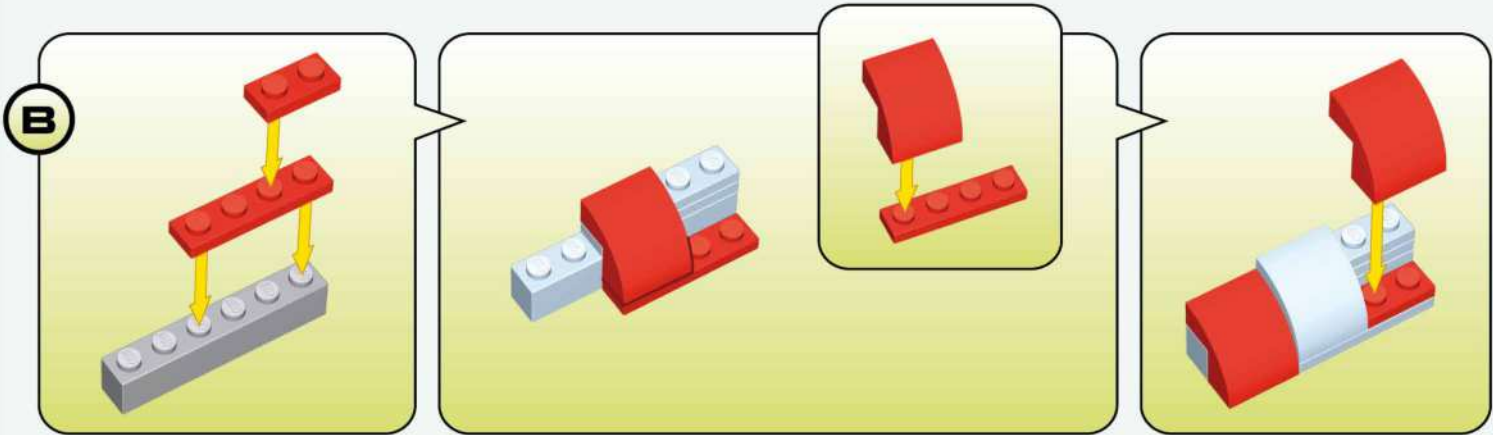
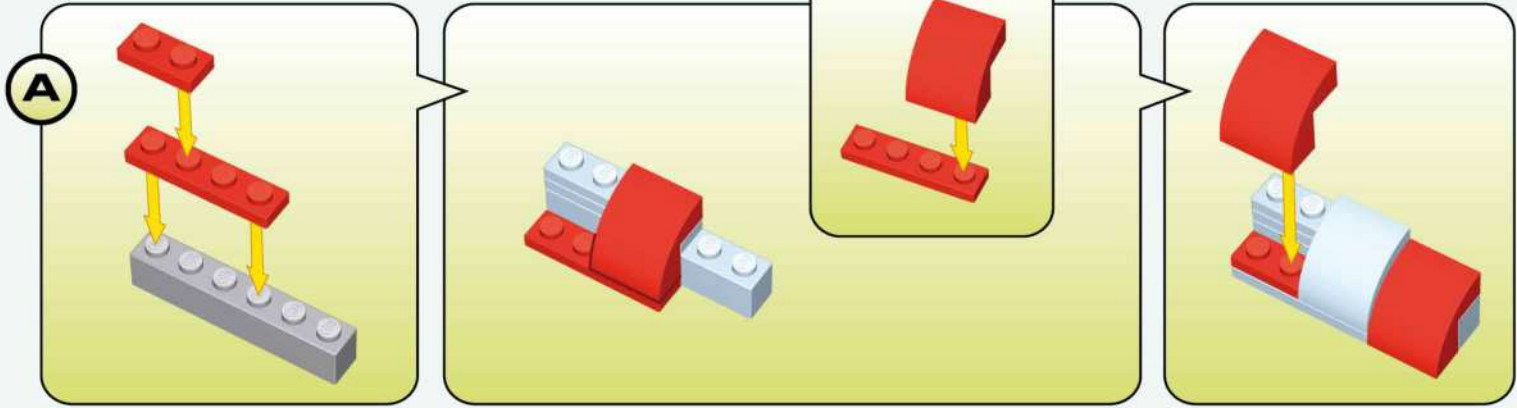





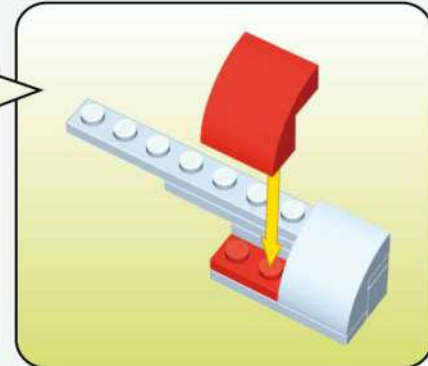
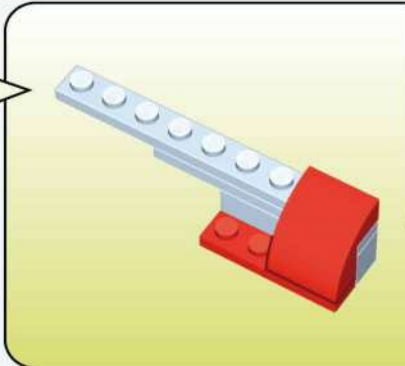
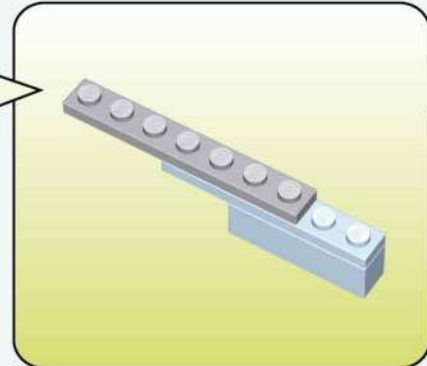
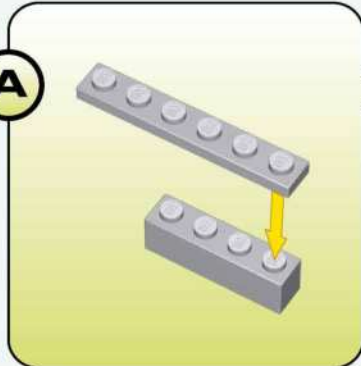

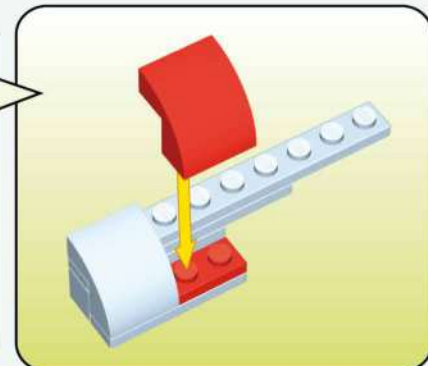
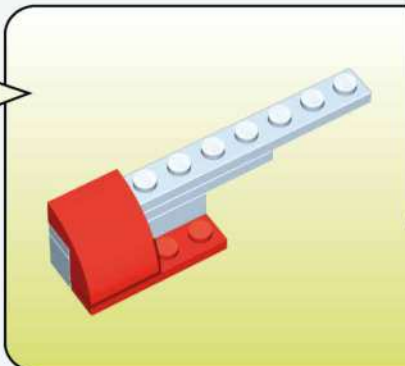
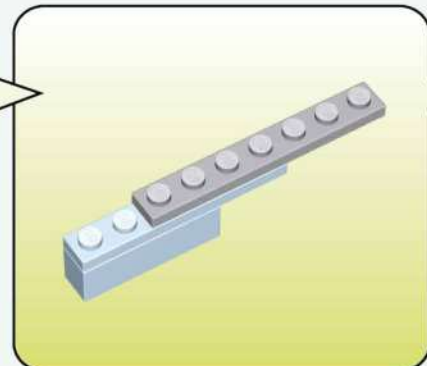
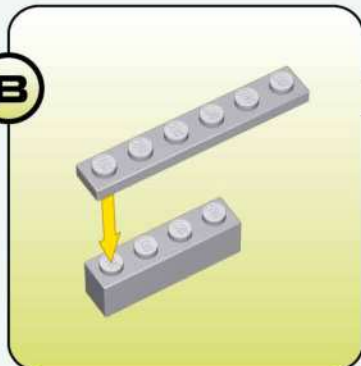

10

A



B



-  x2
-  x2
-  x2
-  x2
-  x4
-  x2
-  x2

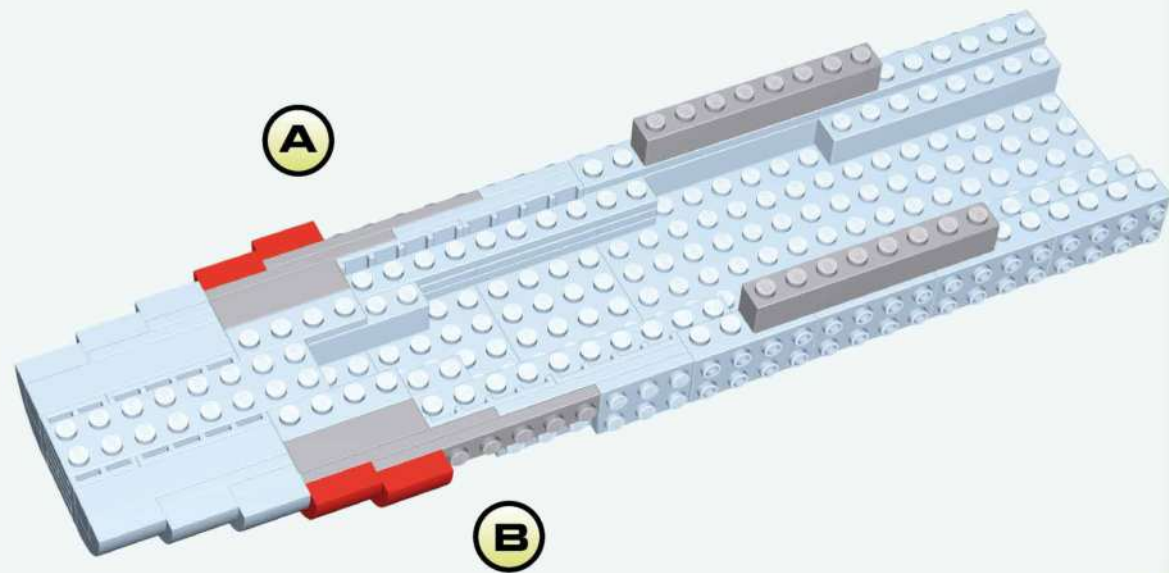

11

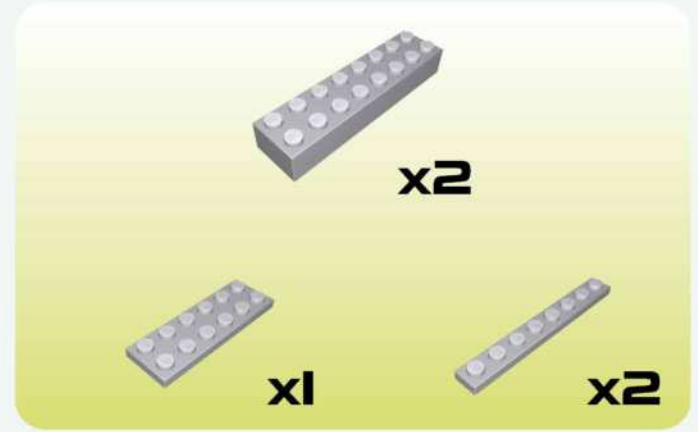
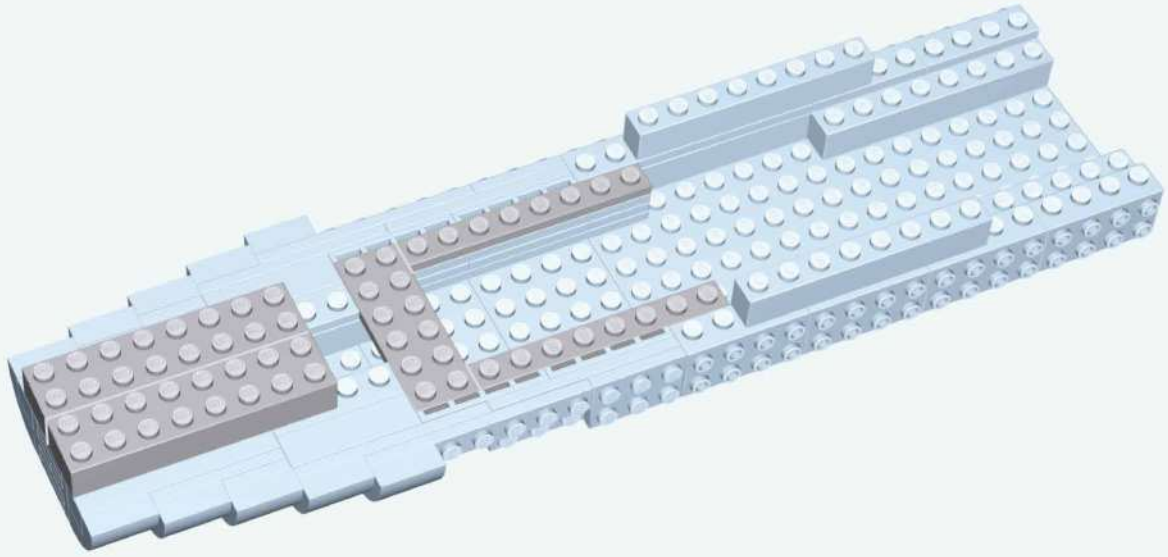

12

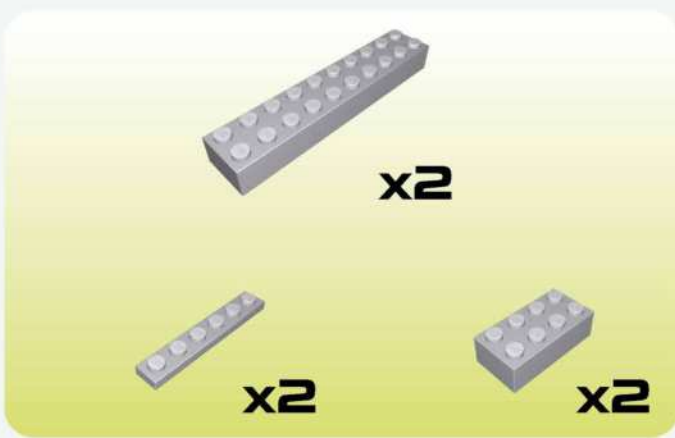
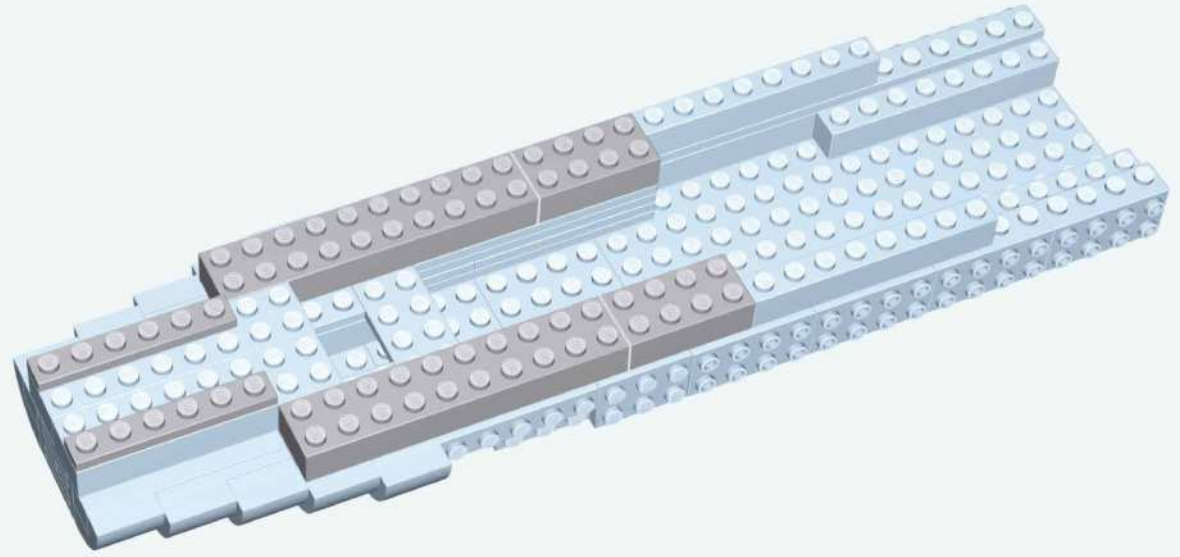

13

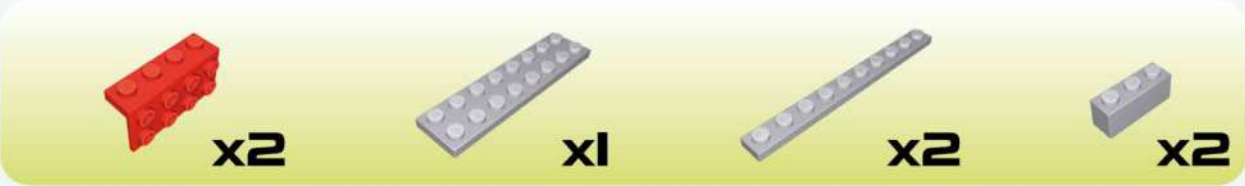
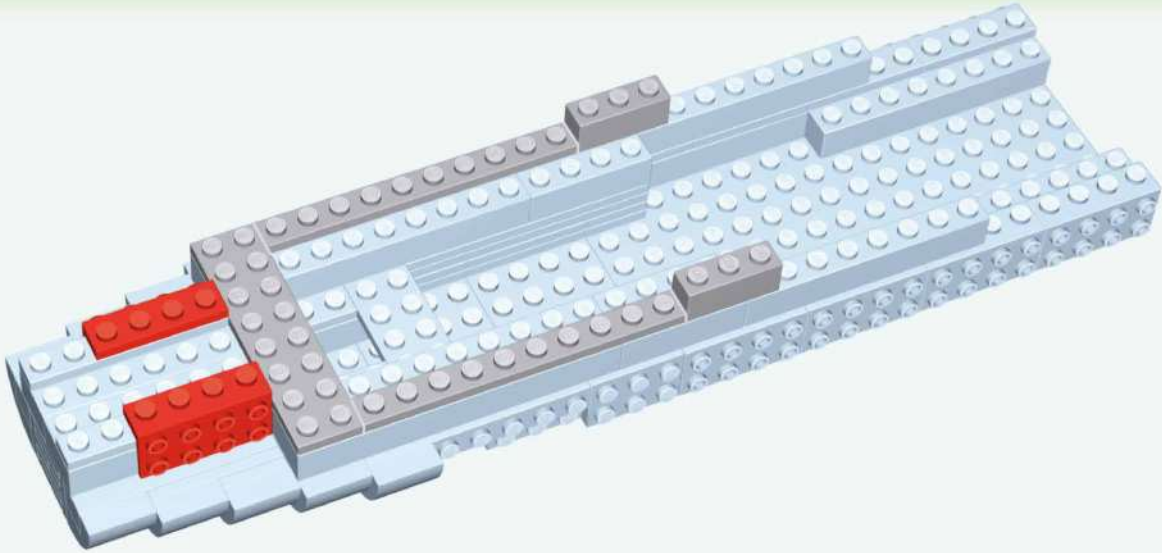

14

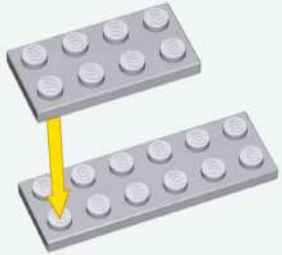

15

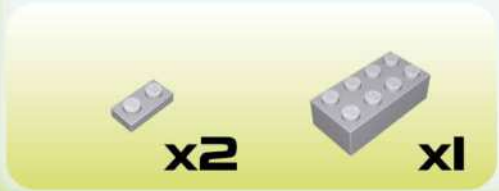
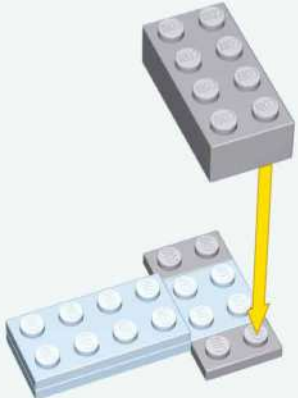

16

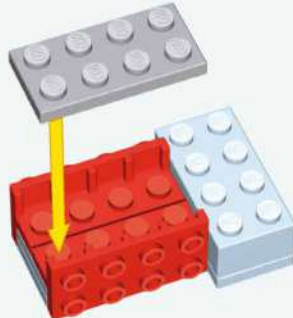

17

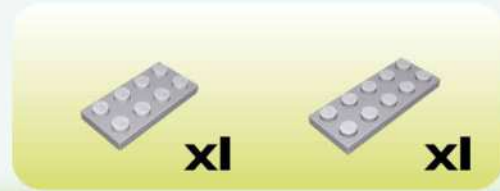
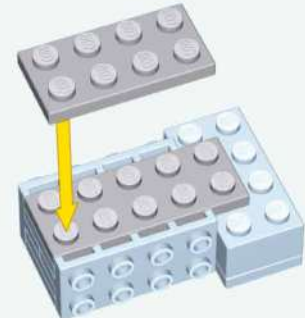

18

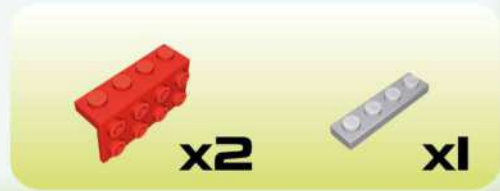
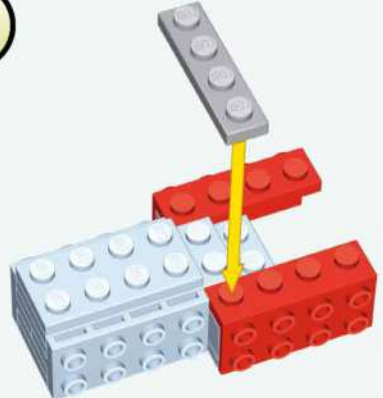

19

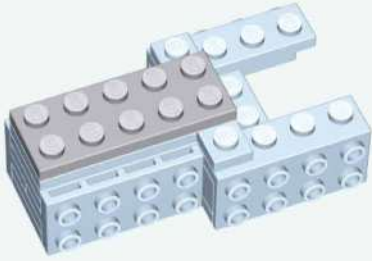

20

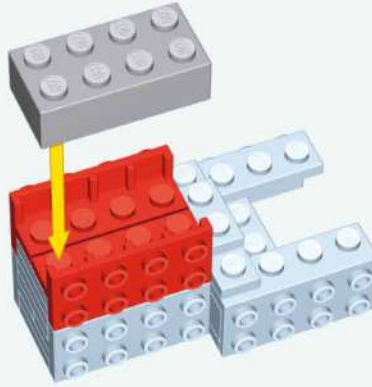

21

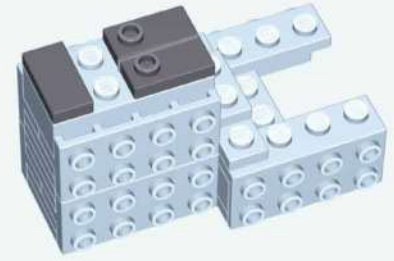

22

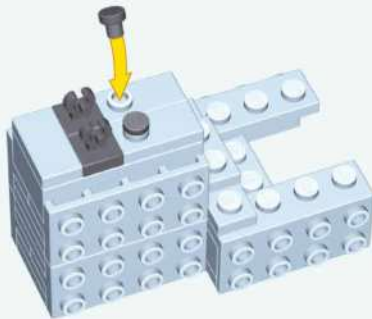

23

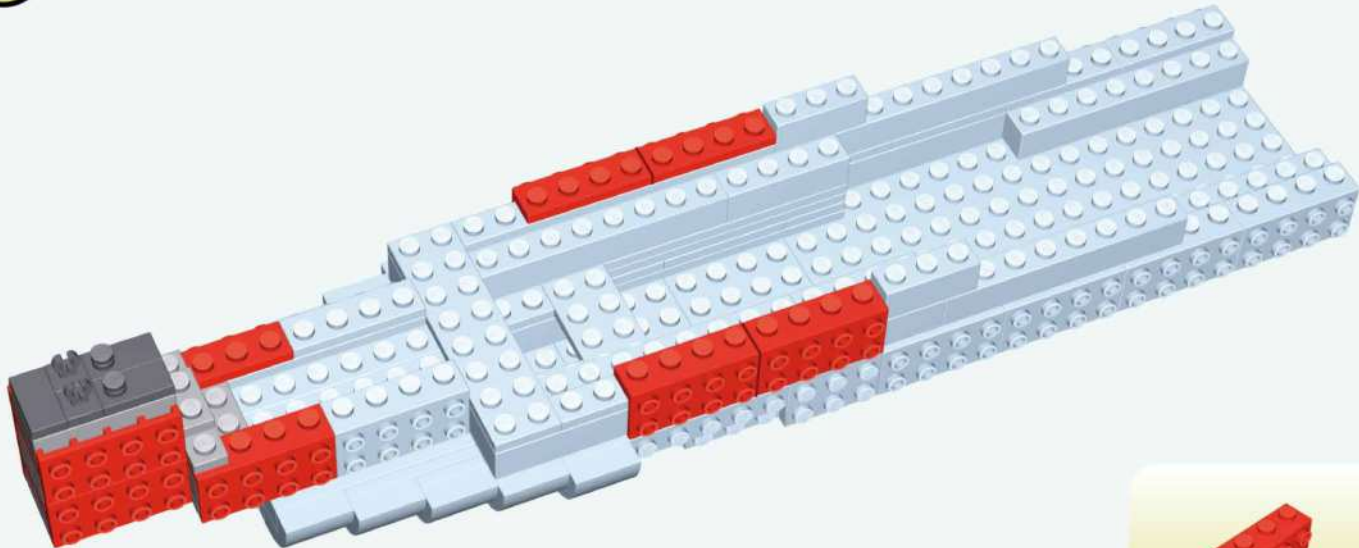

24

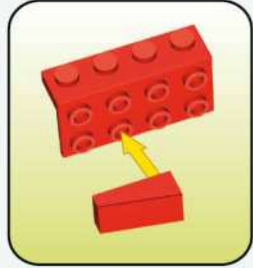
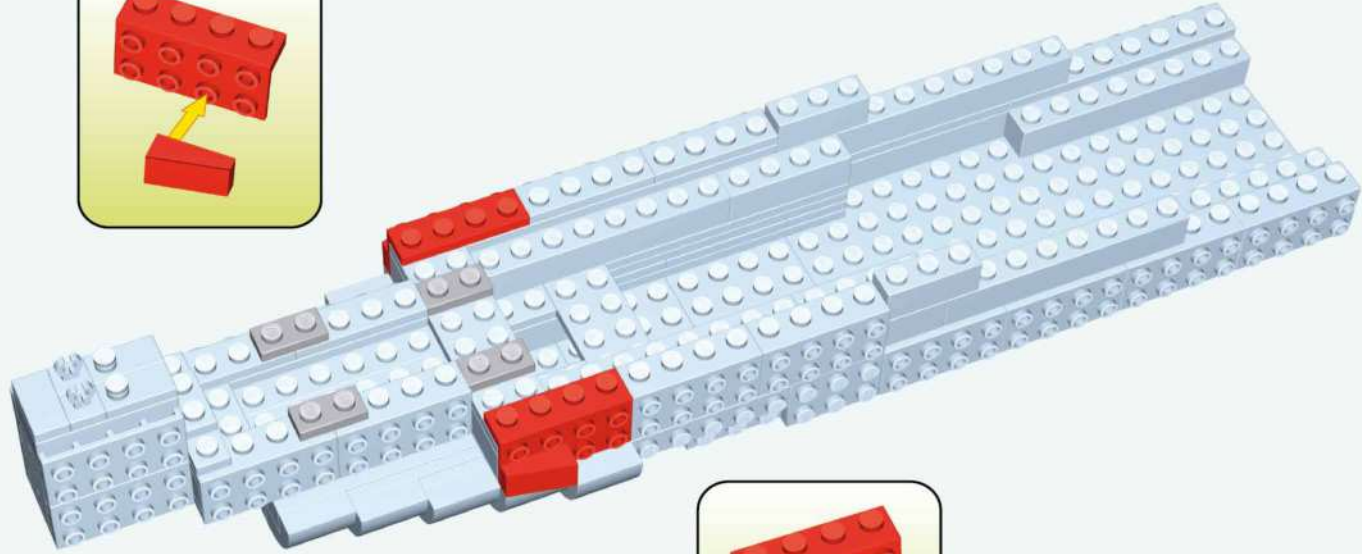
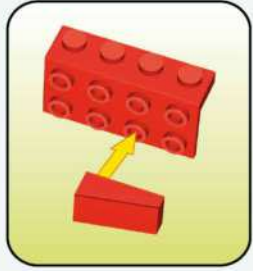

x2



x2



x4

25

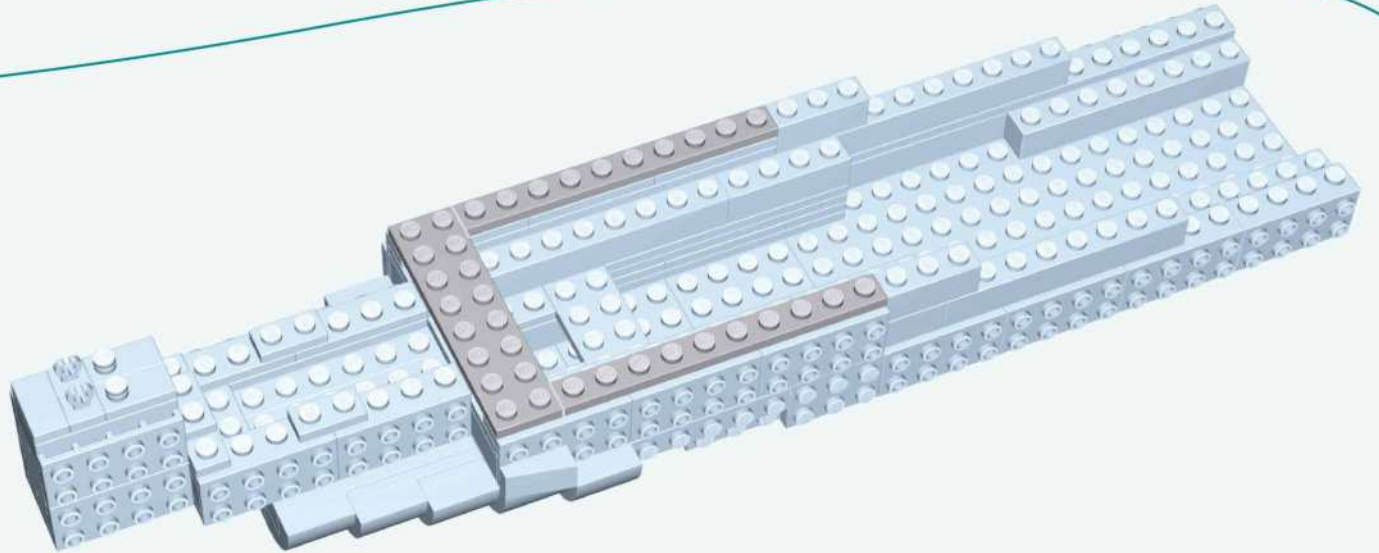

x1



x2

26

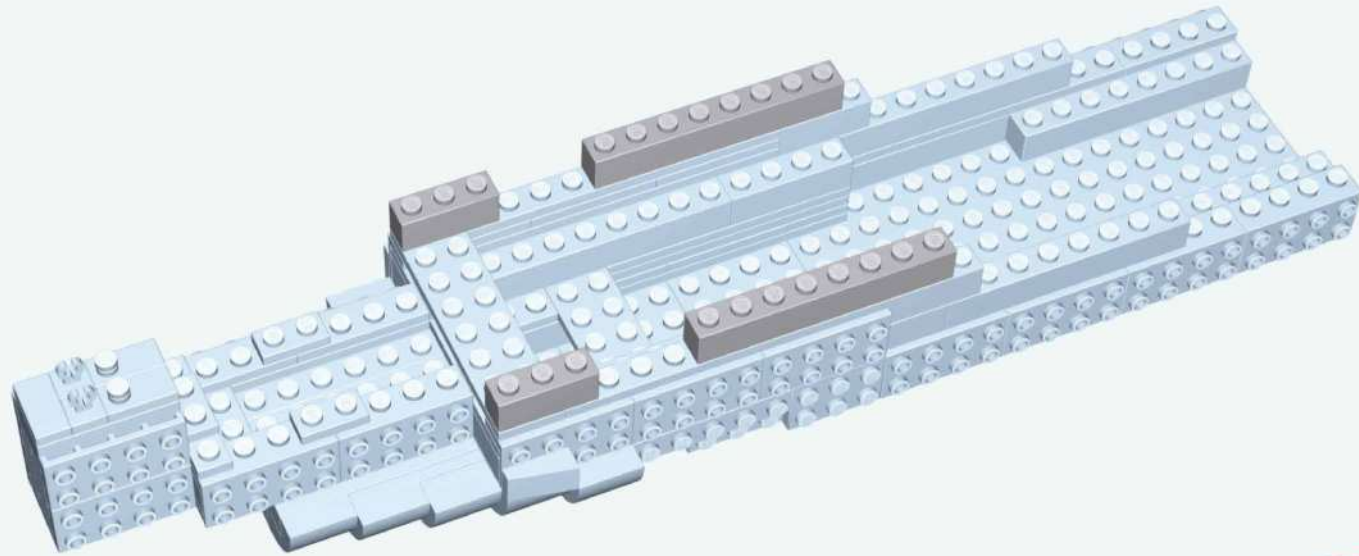

27

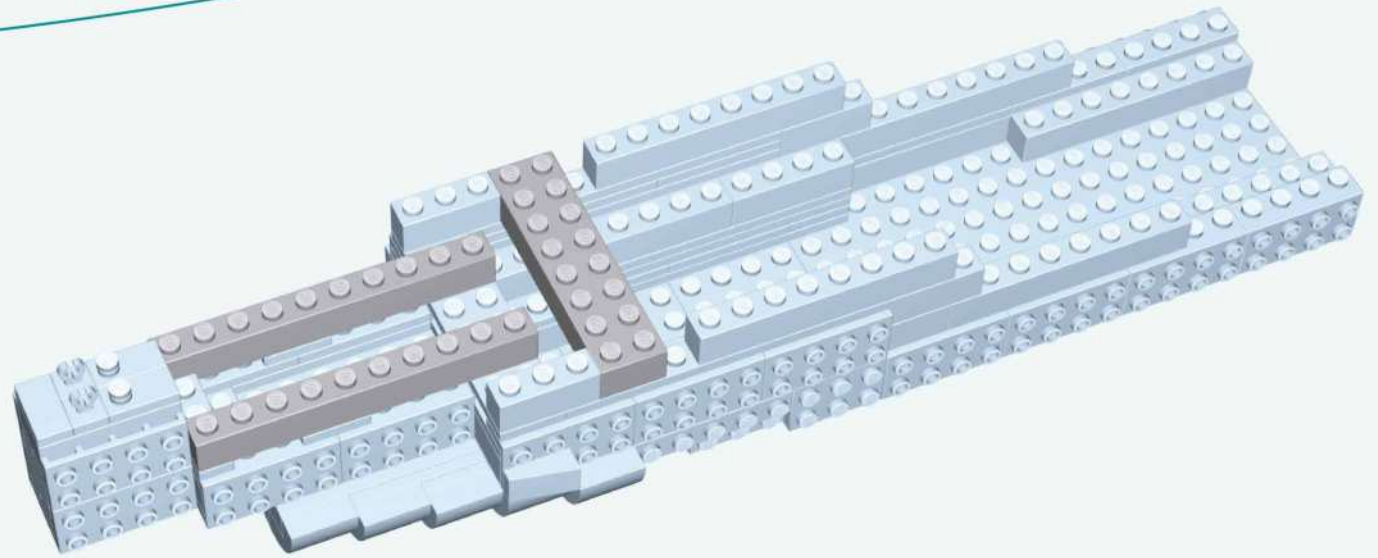

28

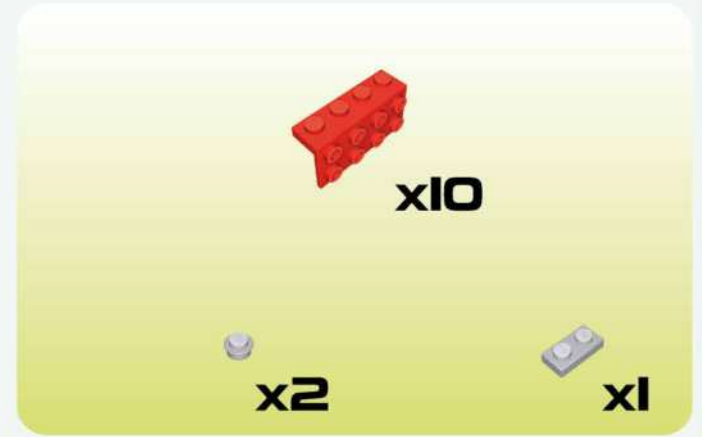
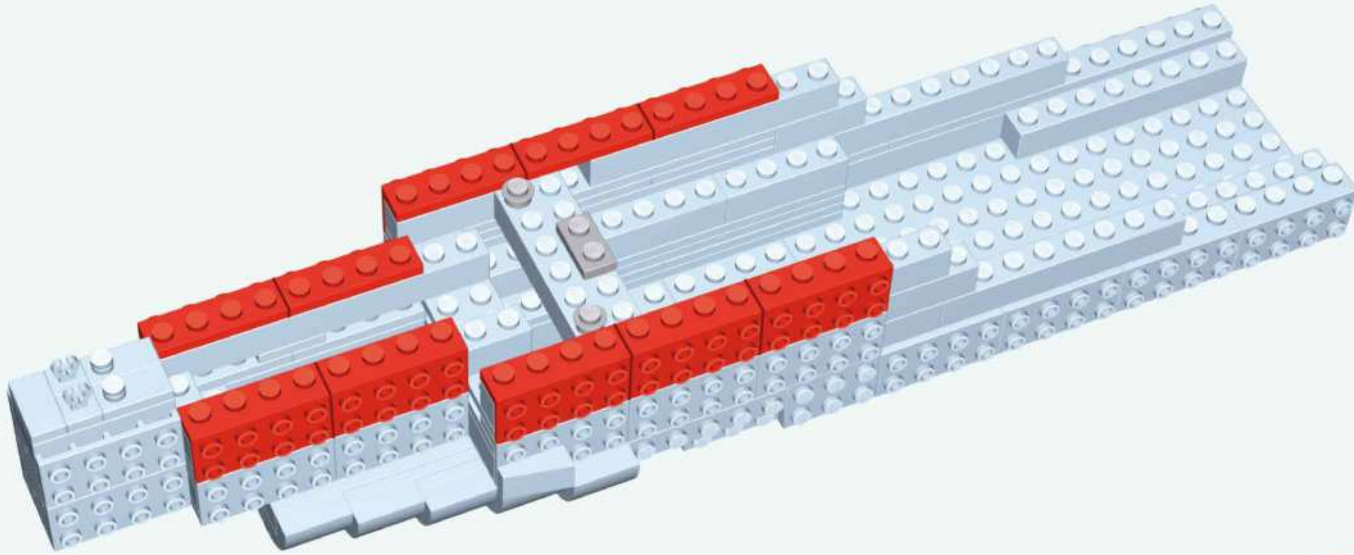

29

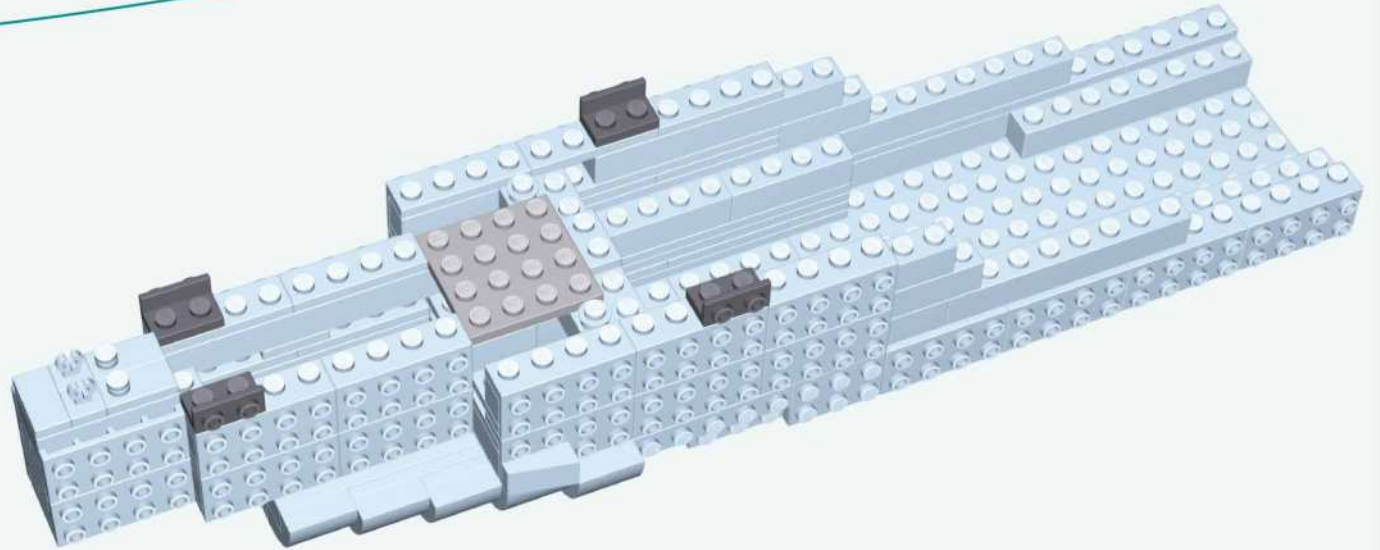

30

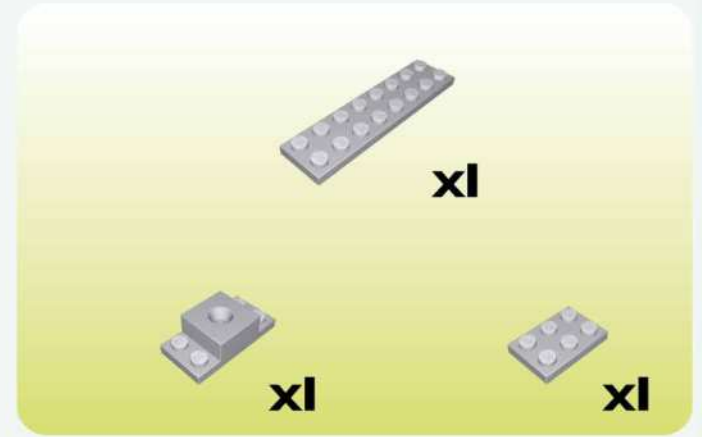

31

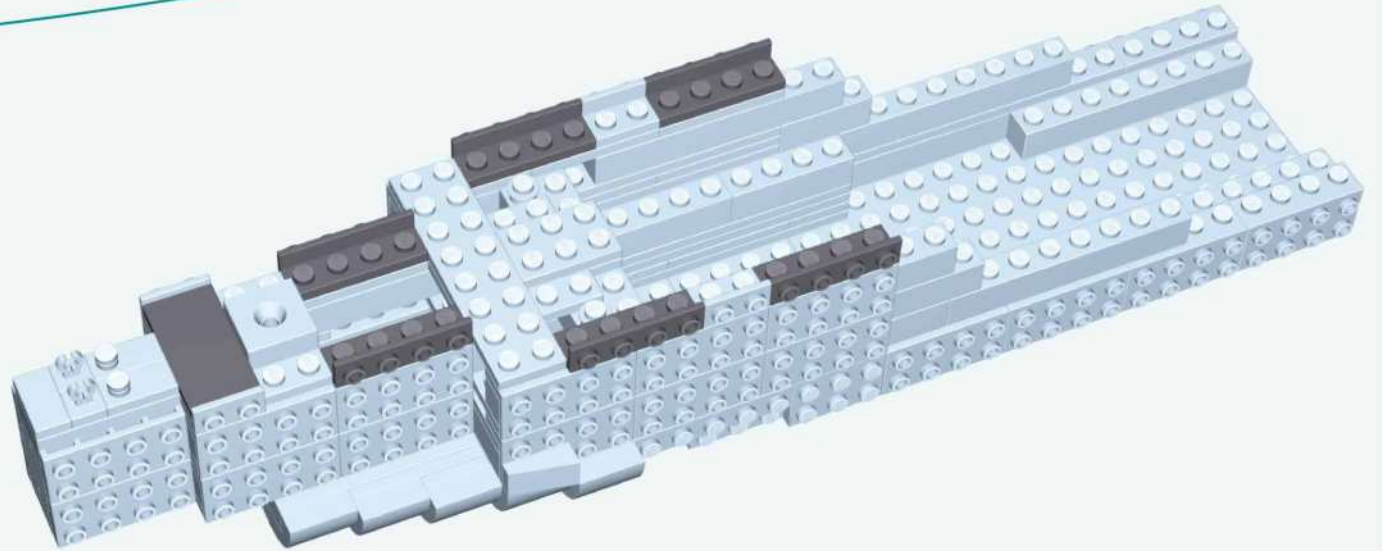

32

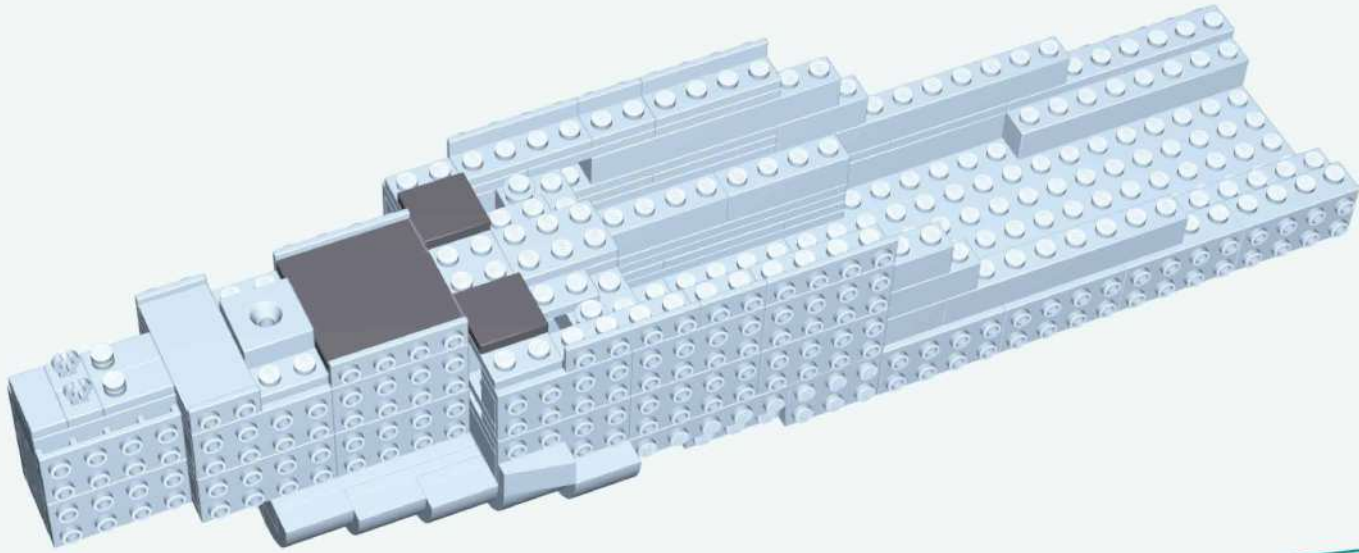

33

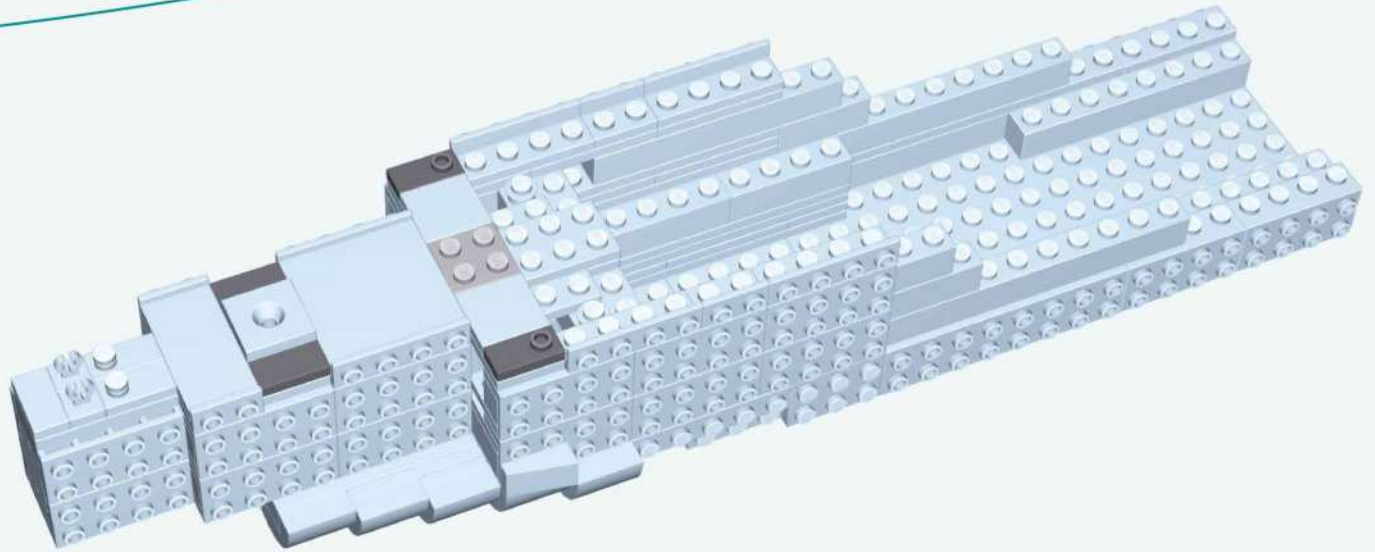
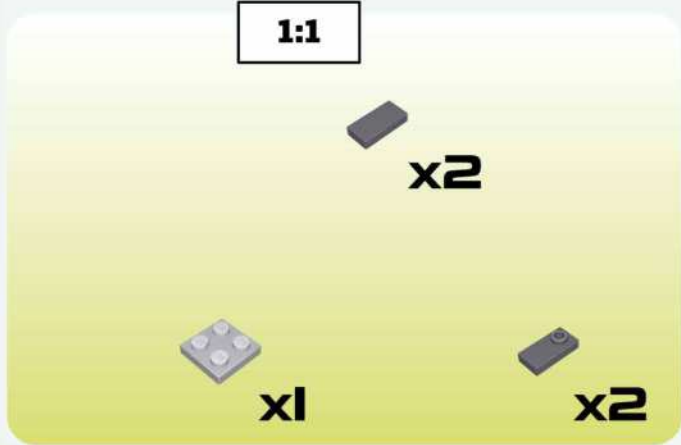

34

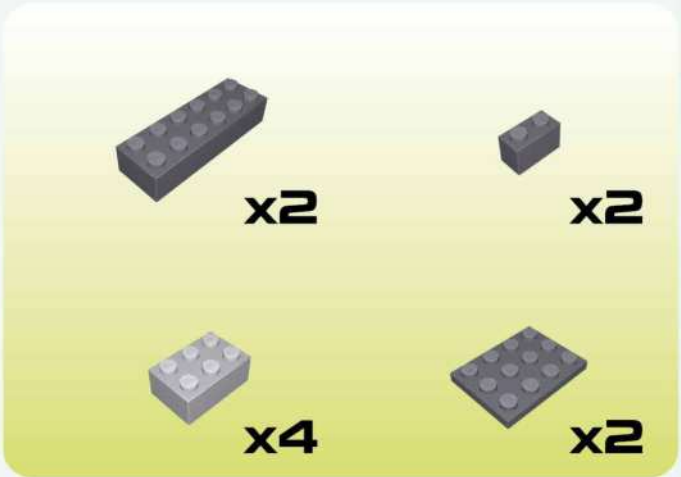
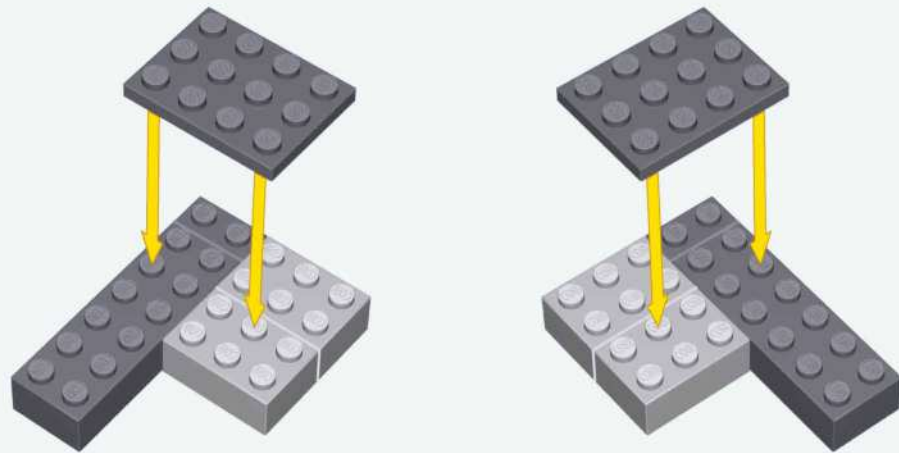

35

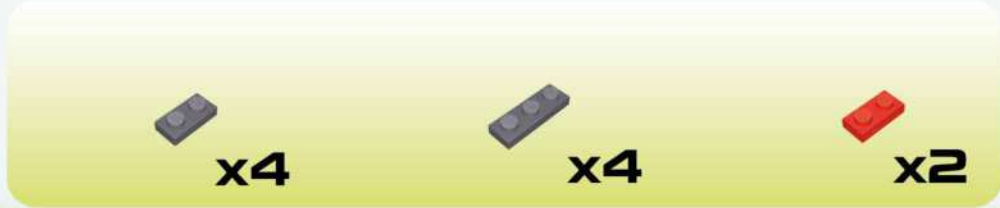
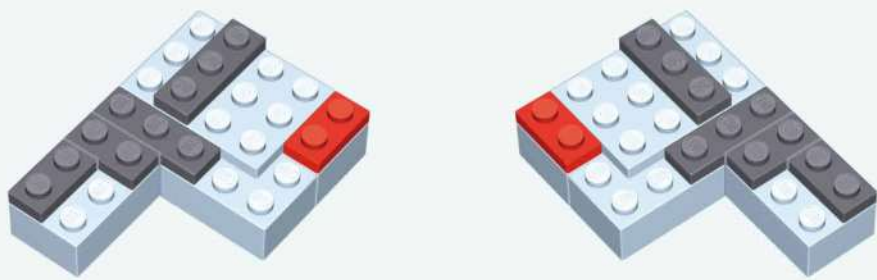

36



37

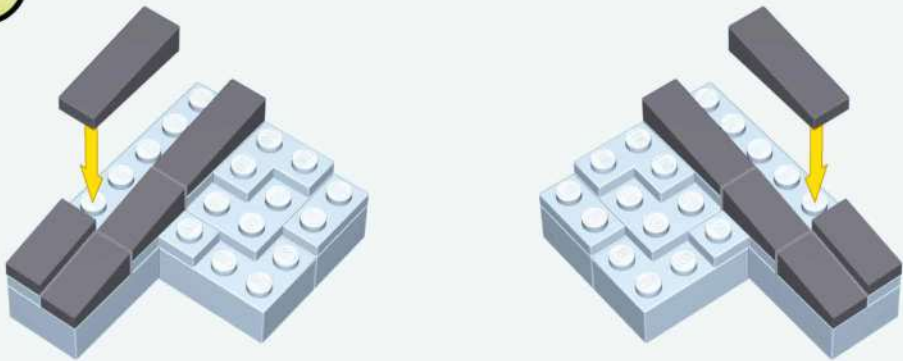

38

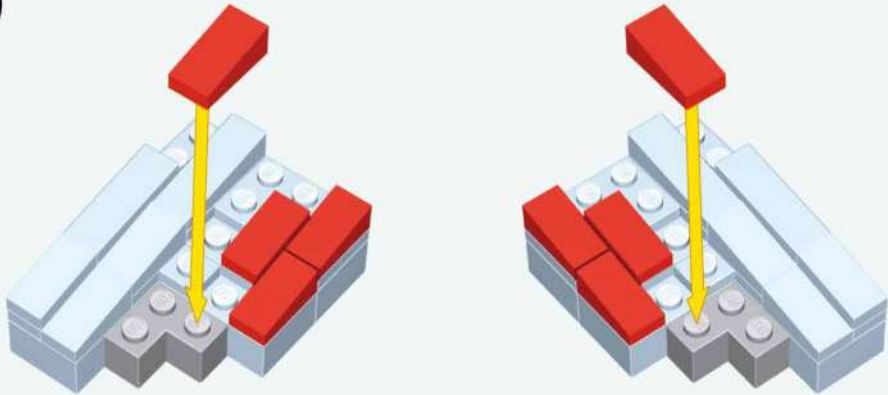

39

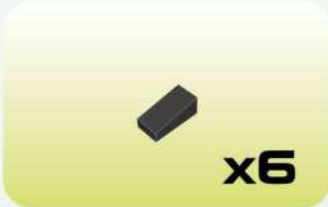
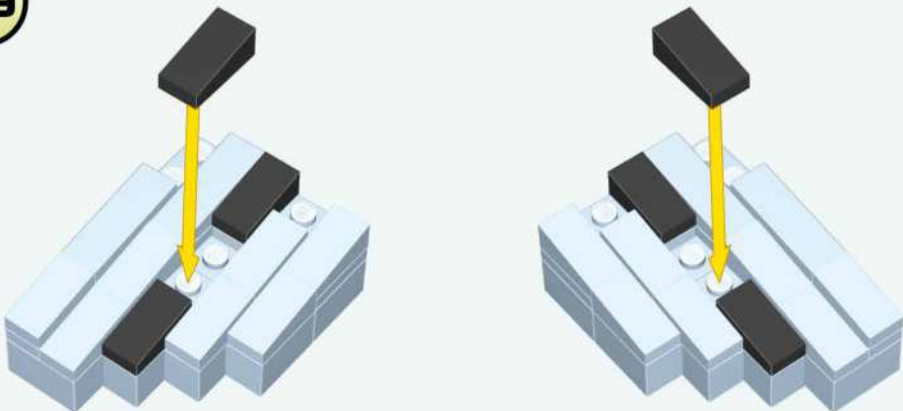

40

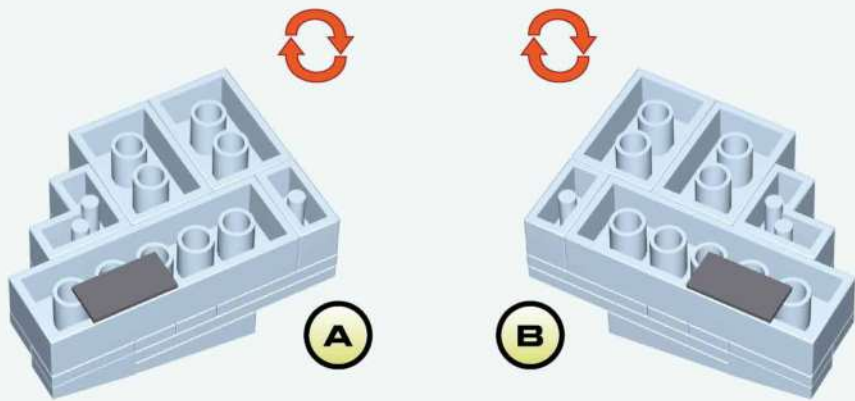

41

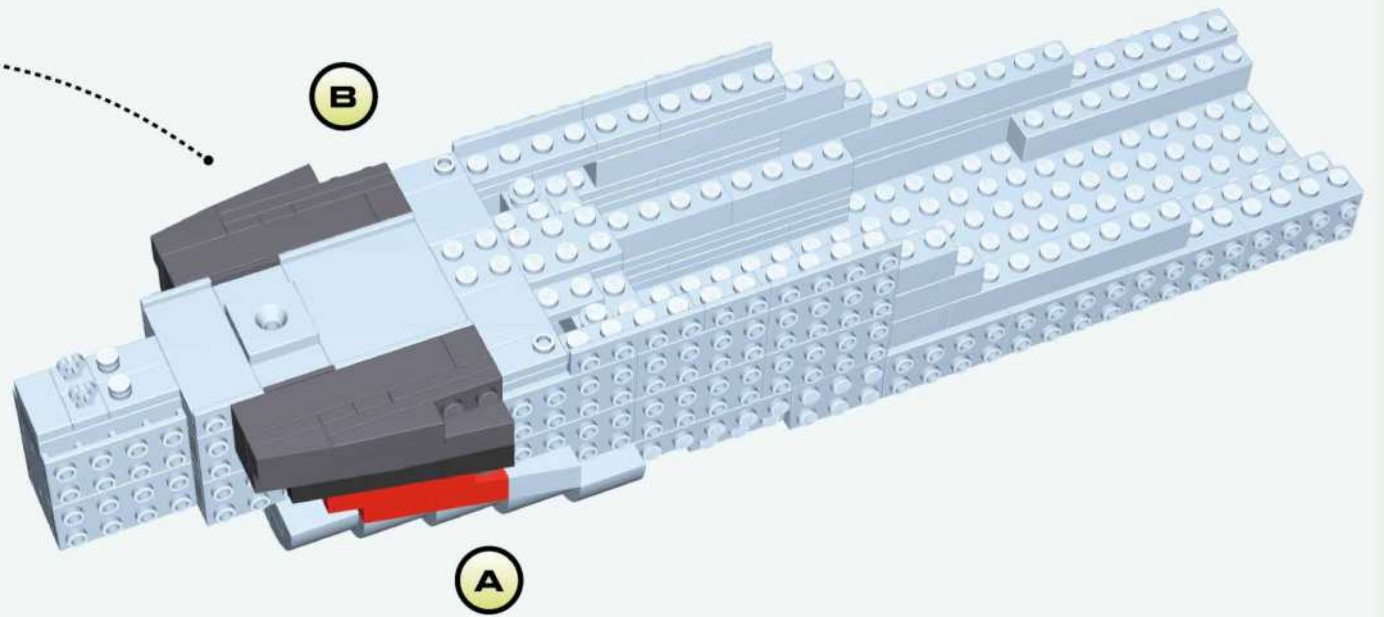
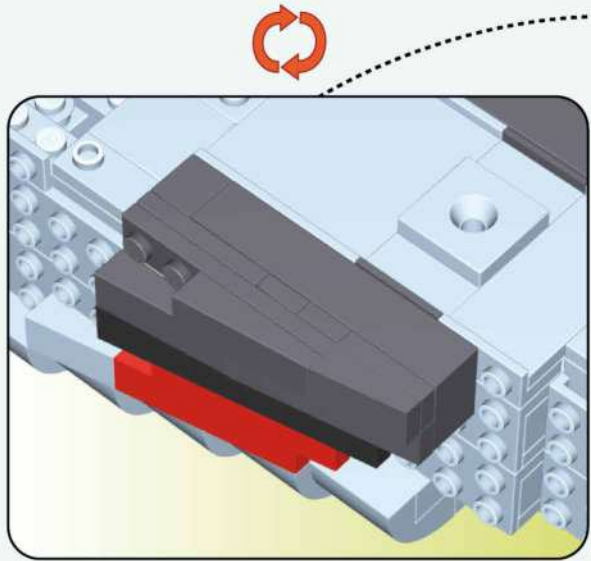

42

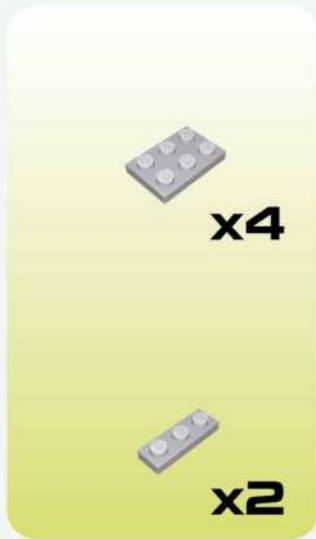
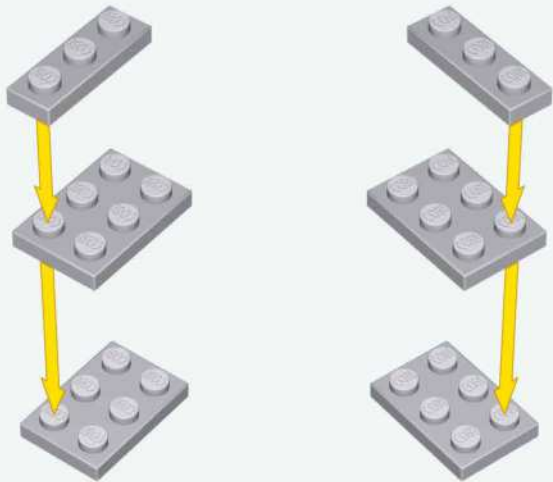

43

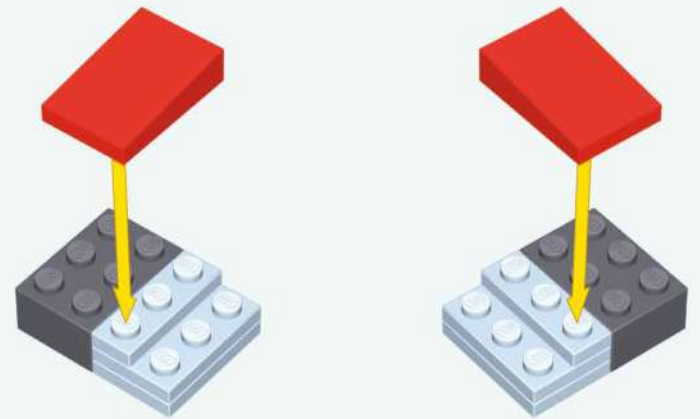

44

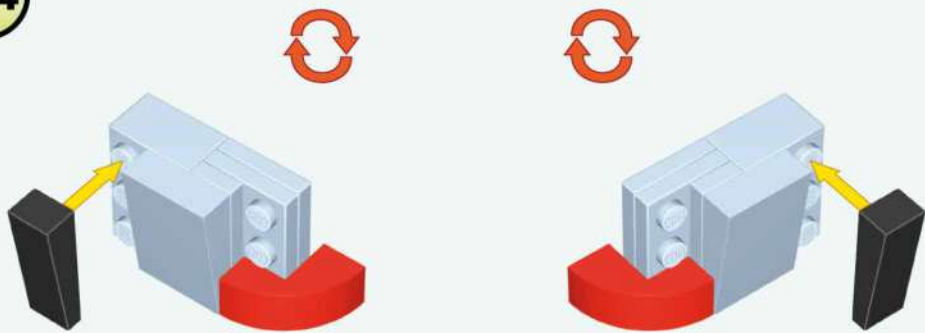

45

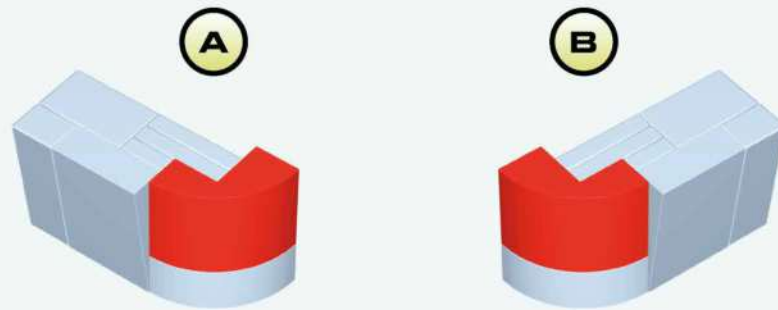

46

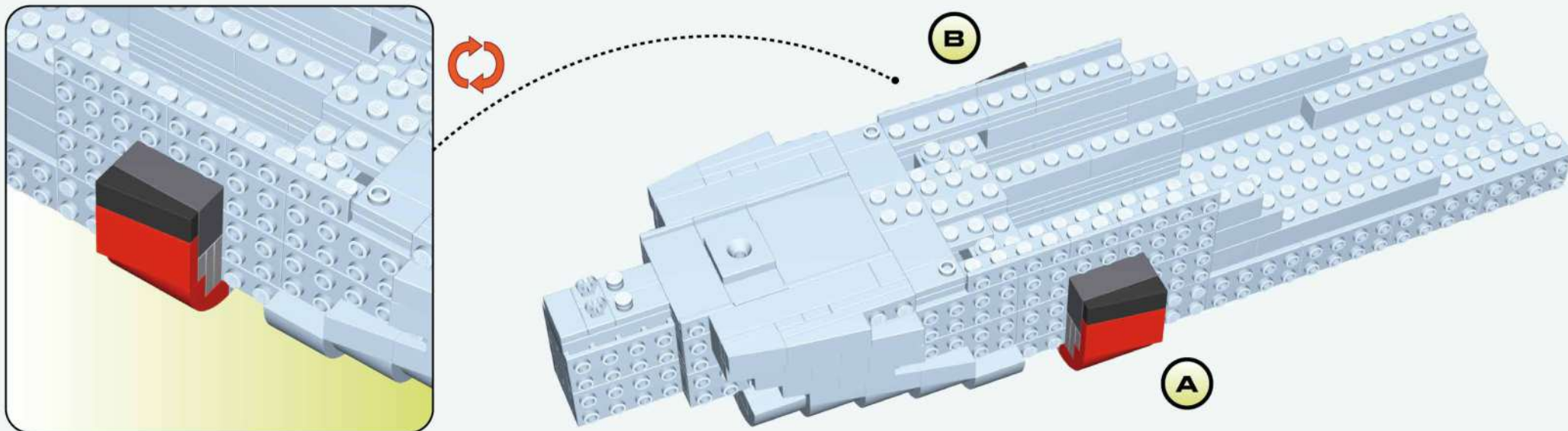

47

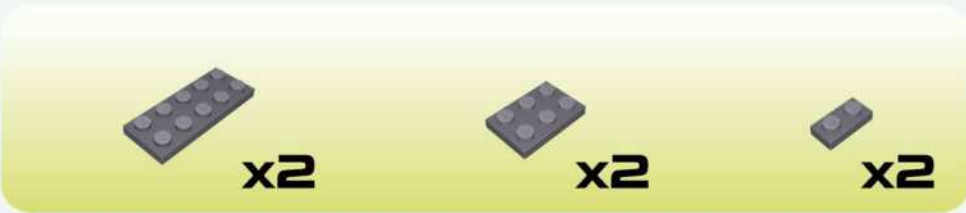

48

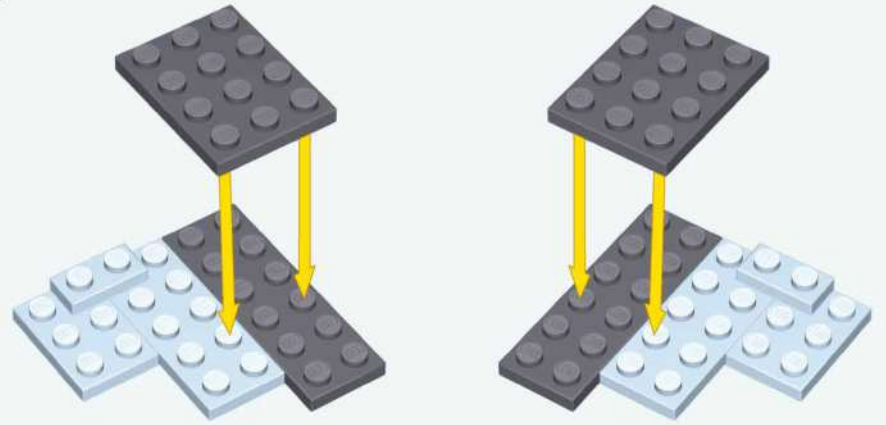

49

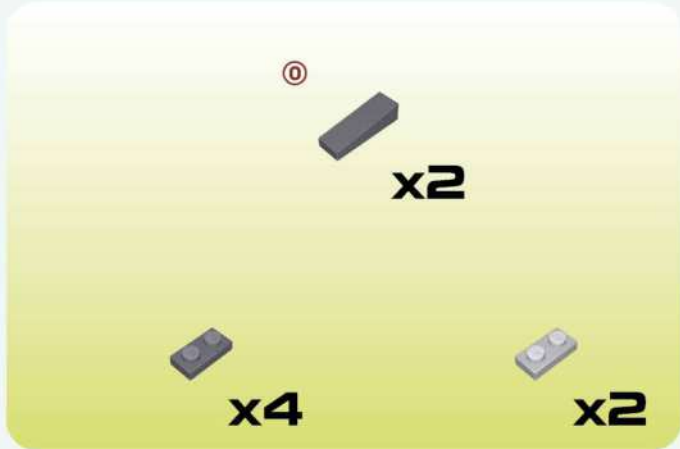

50

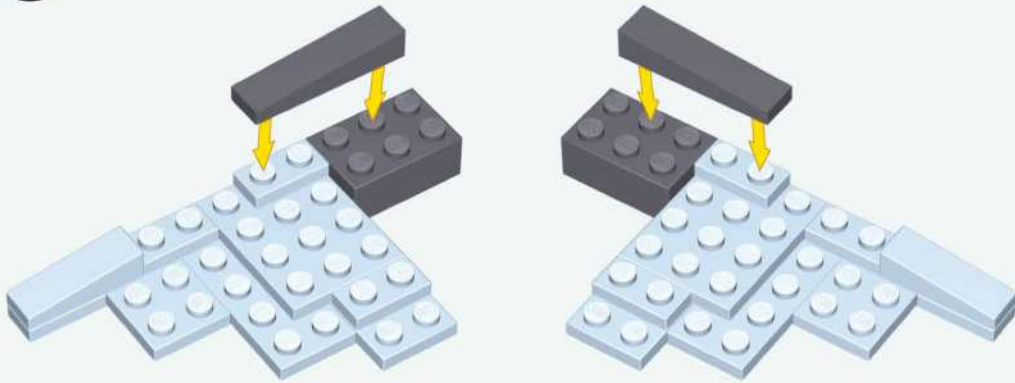

51

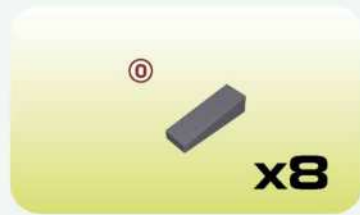
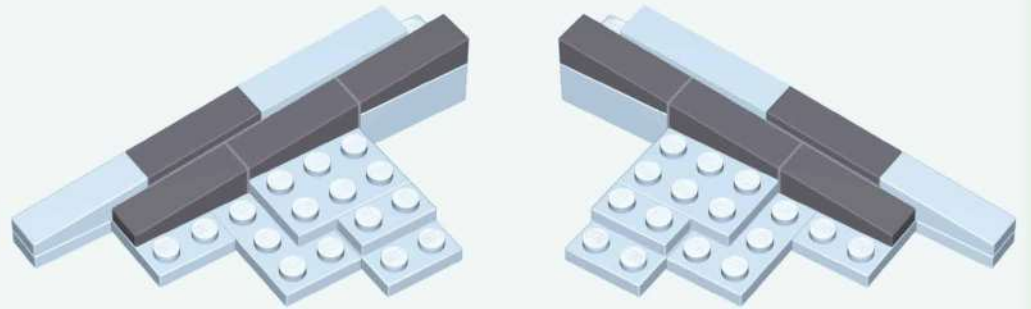

52

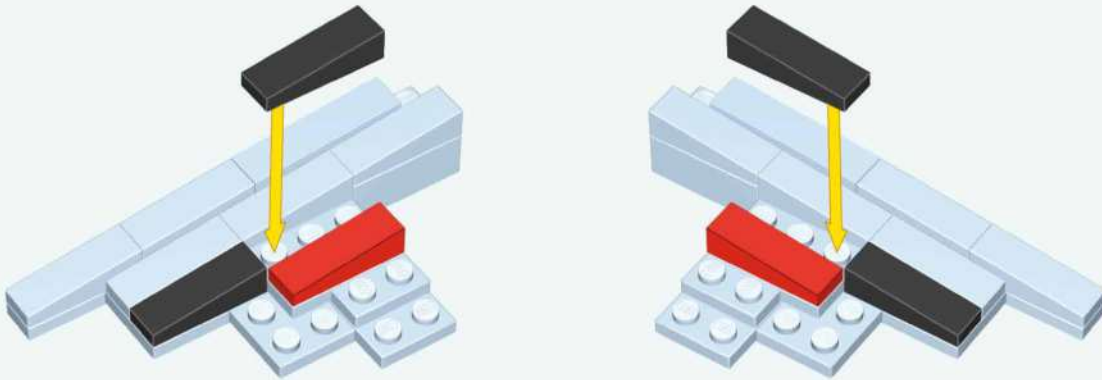

53

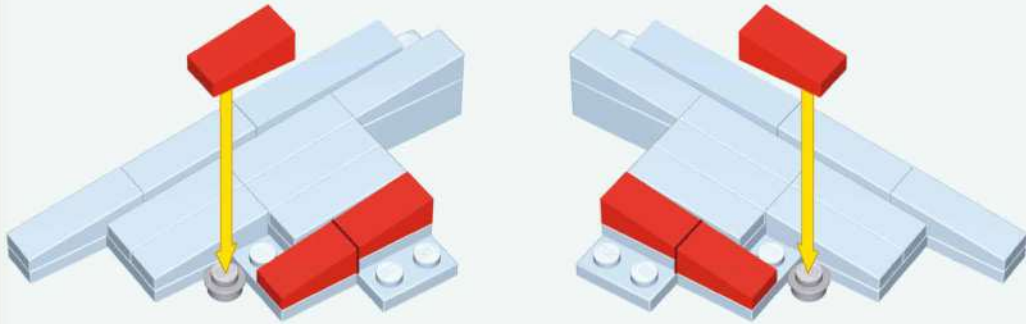

54

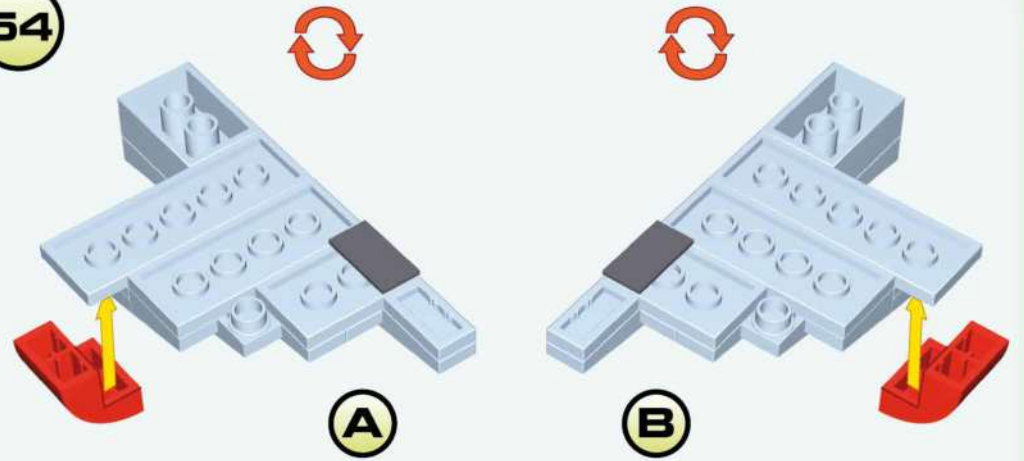

55

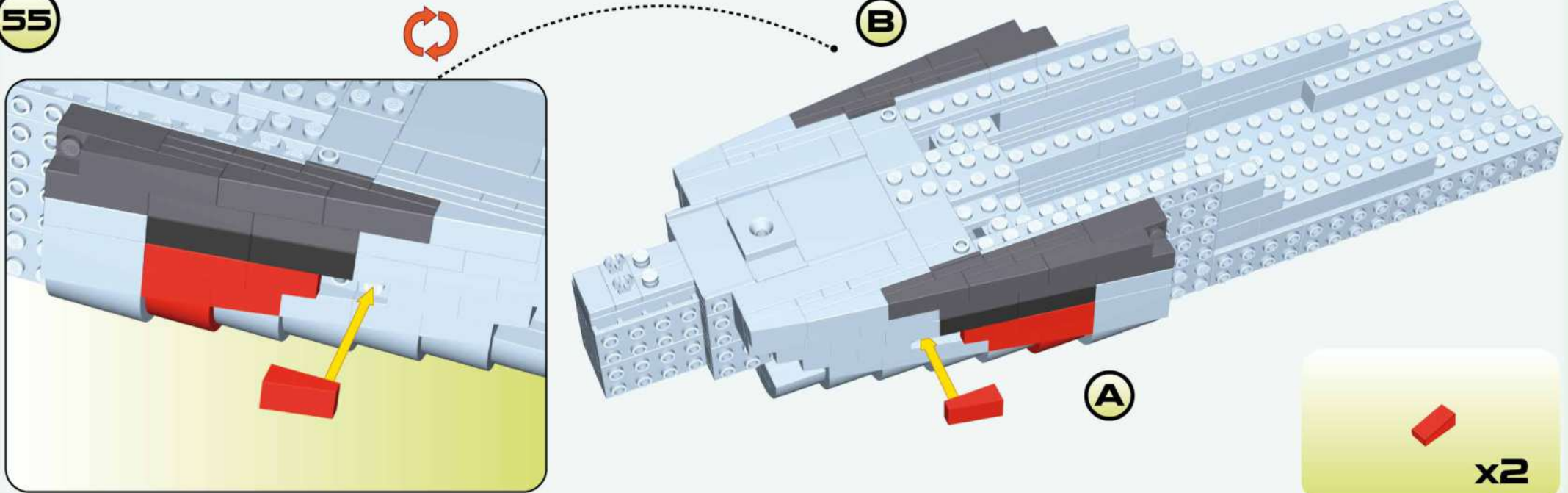



2

56

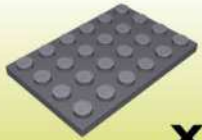

x1



x2

57

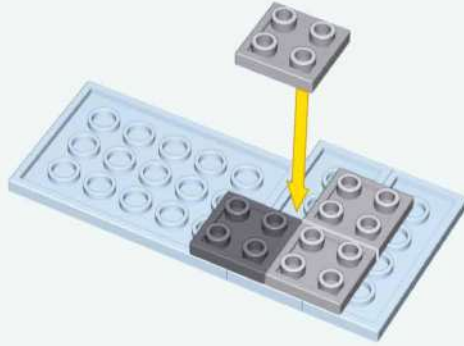

x1



x3

58

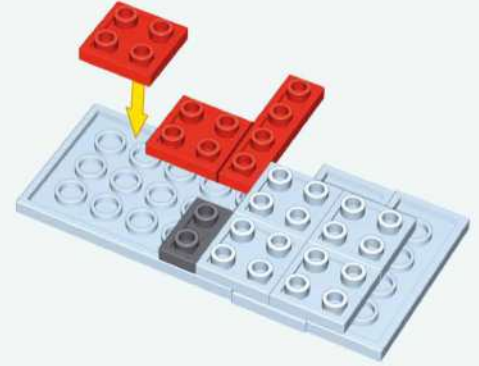

x2



x1



x1

59

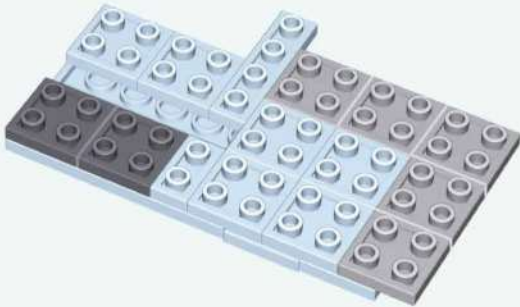

x2



x5

60

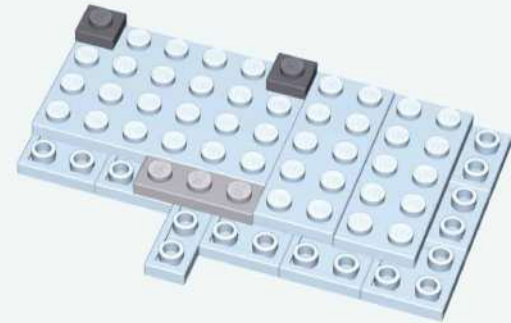

x1



x2

61

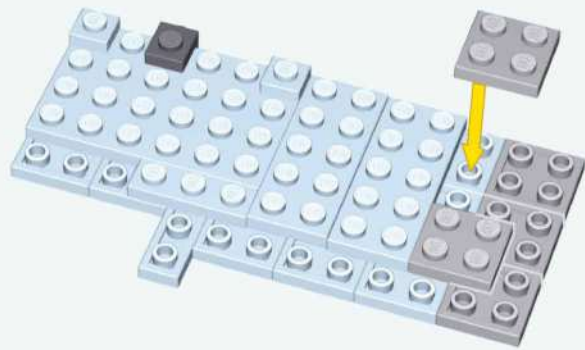

62

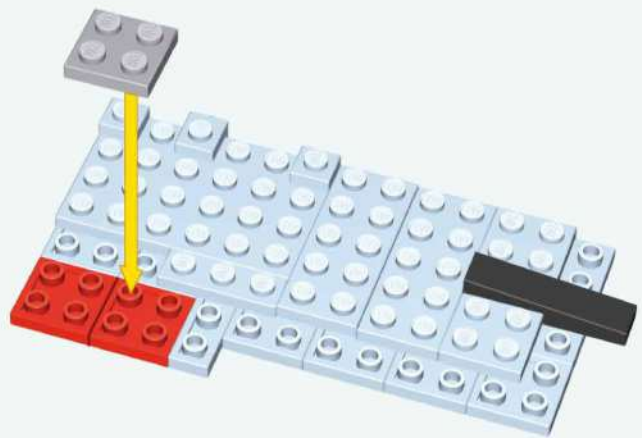

63

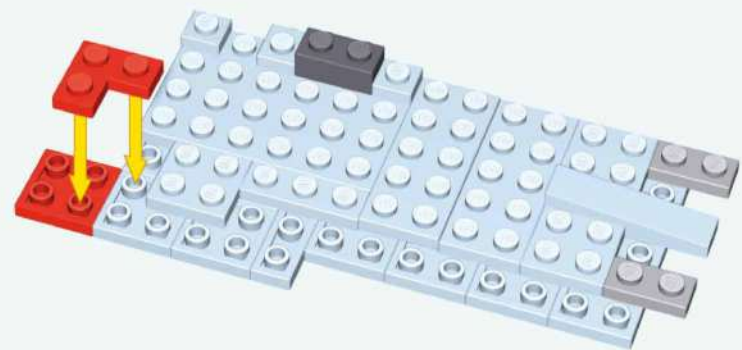

64



65

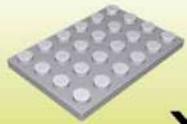
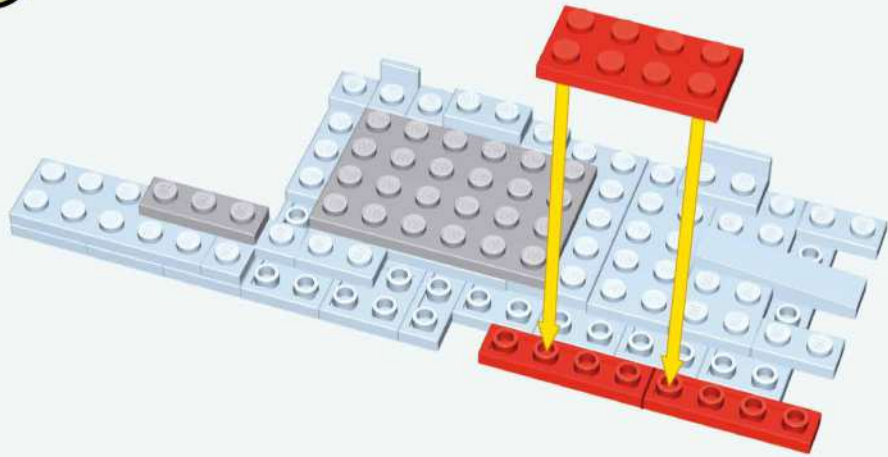

x1



x1



x2



x1

66

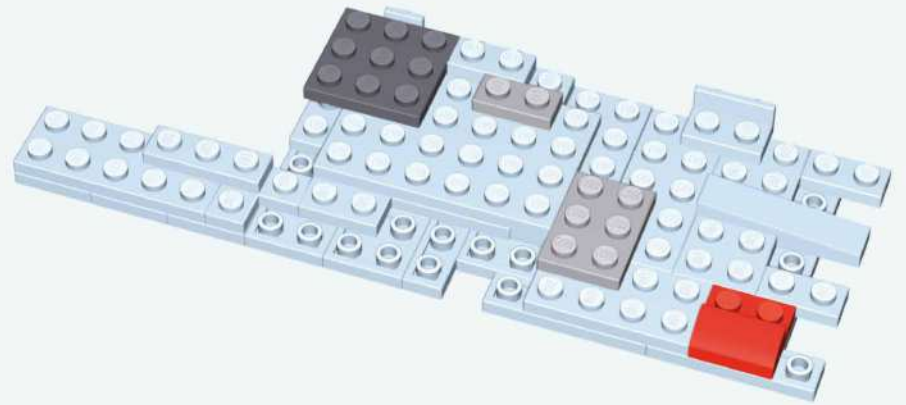

x1



x1



x1

®



x1

67

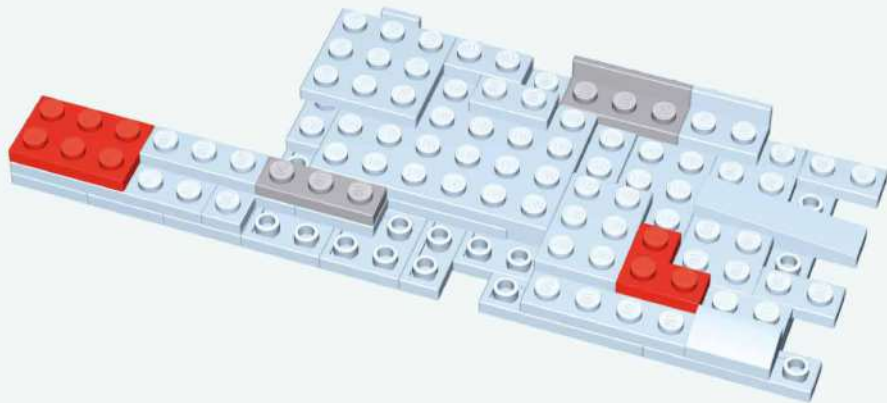

x1



x1



x1



x1

68

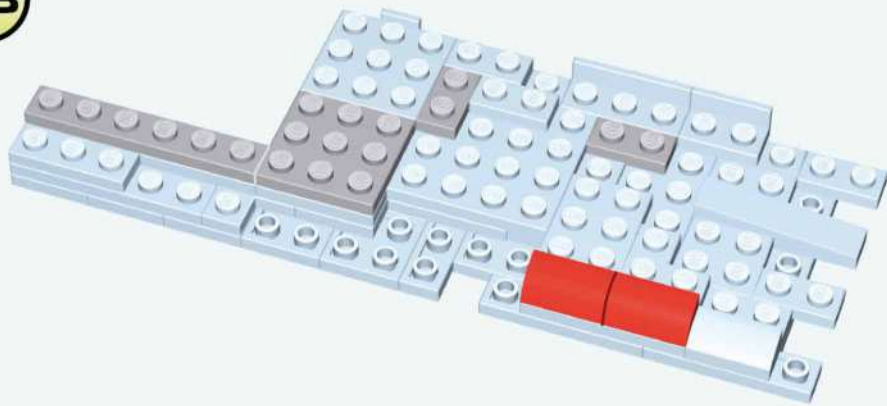

x1

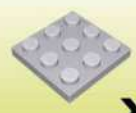

x1



x2



x2

69

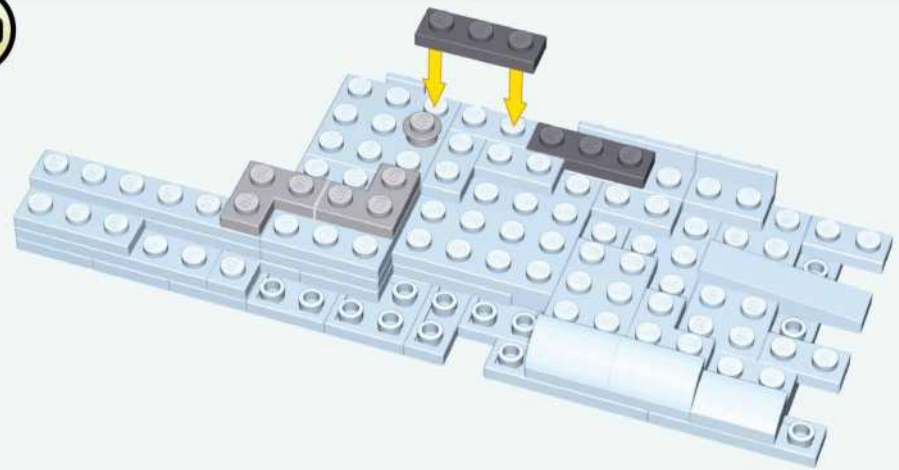

x2



x1



x2

70

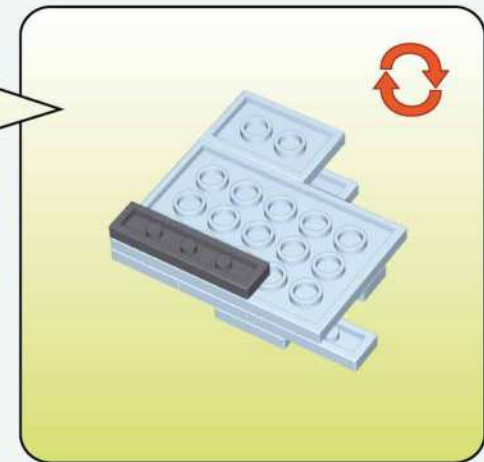
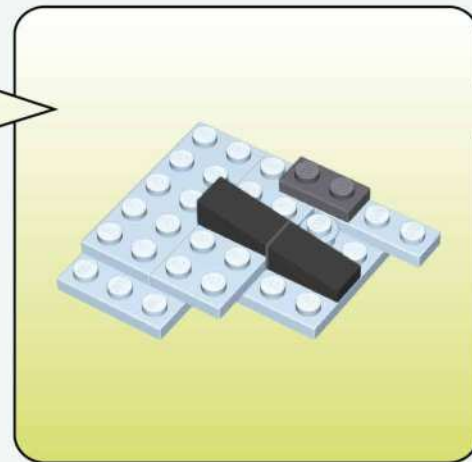
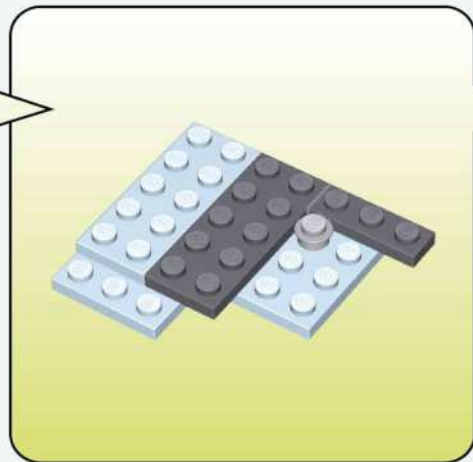
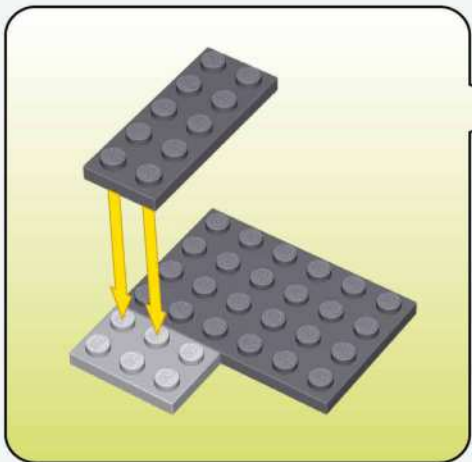

x1



x1



x2



x1



x1



x2



x1



x1

71

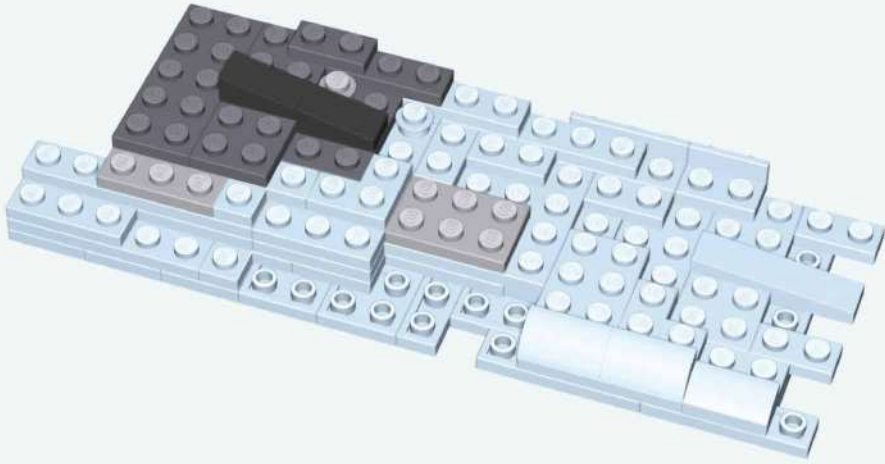

72

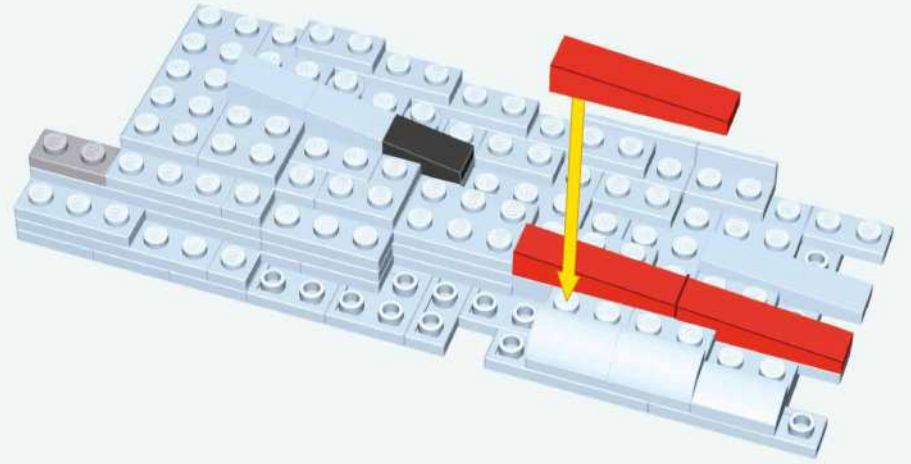

73

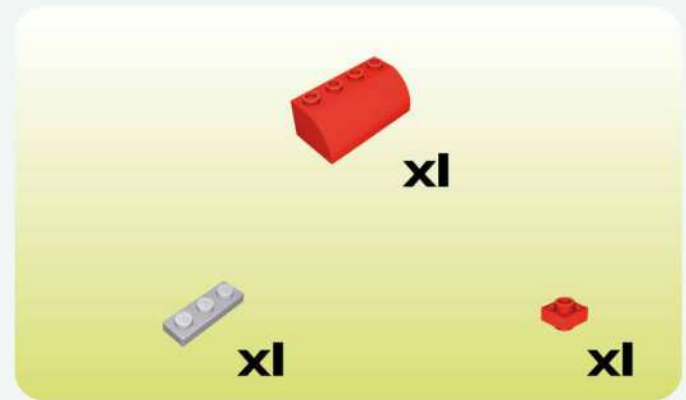
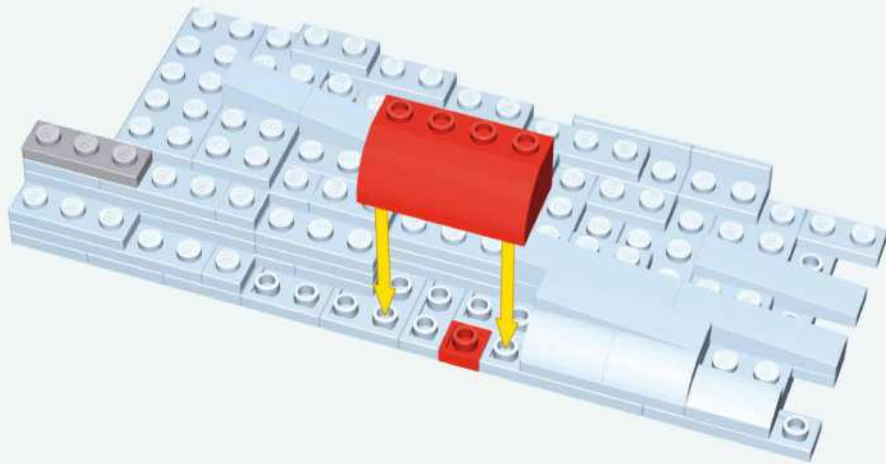

74

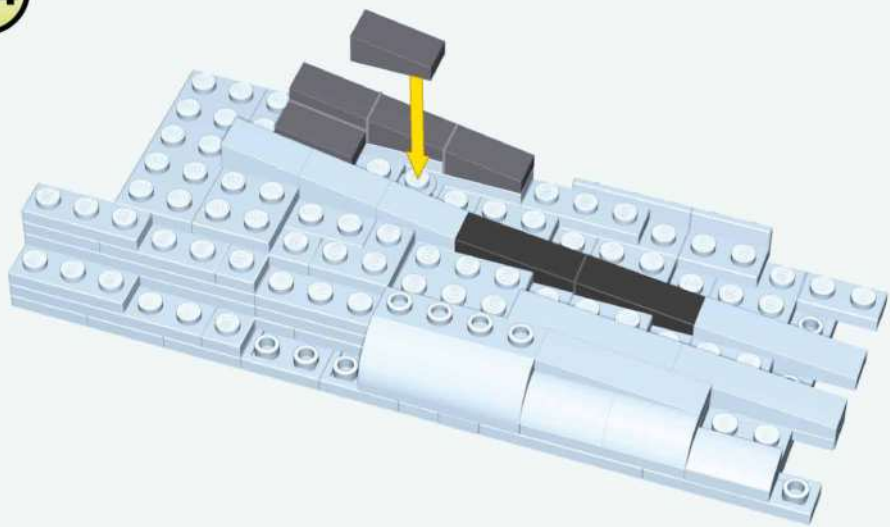

75

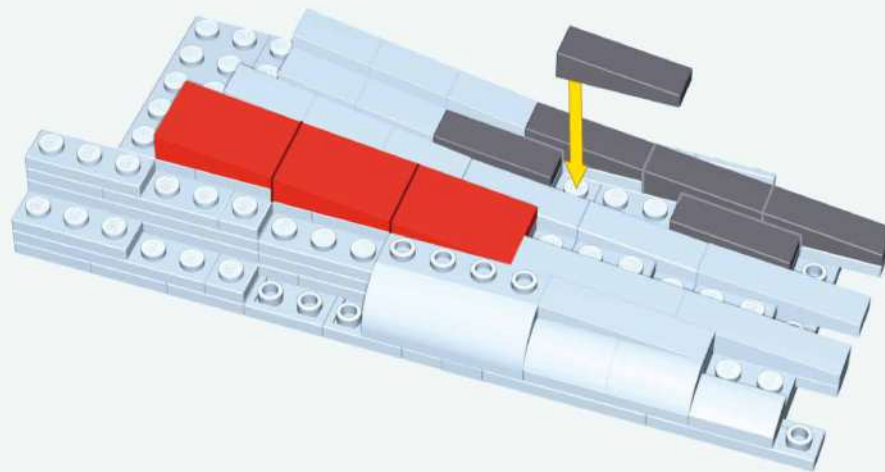

76

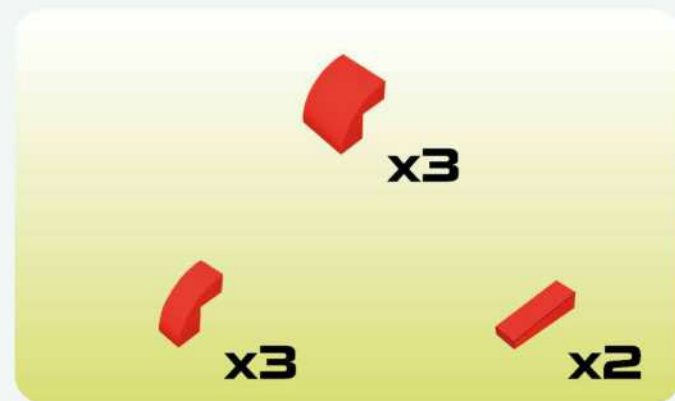
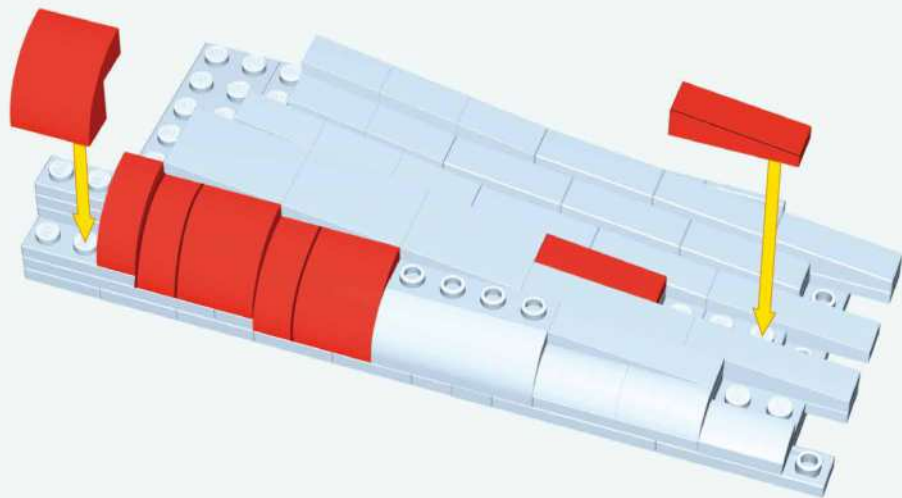

77

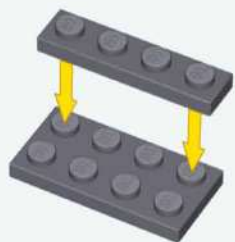

x1



x1

78

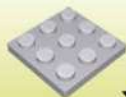

x1



x1

79

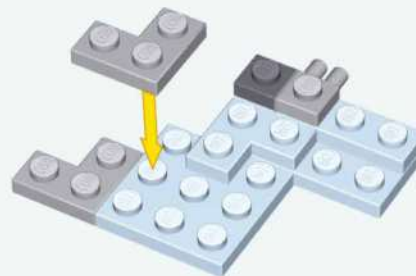

x2



x1



x1

80

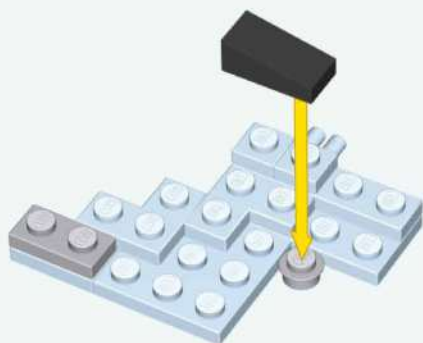

x1



x1



x1

81

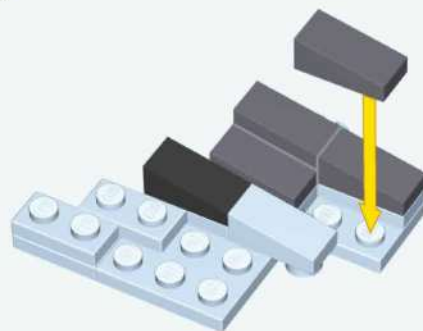

x1



x4

82

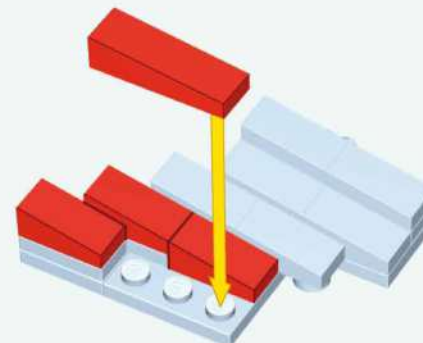

x1



x3

83



84

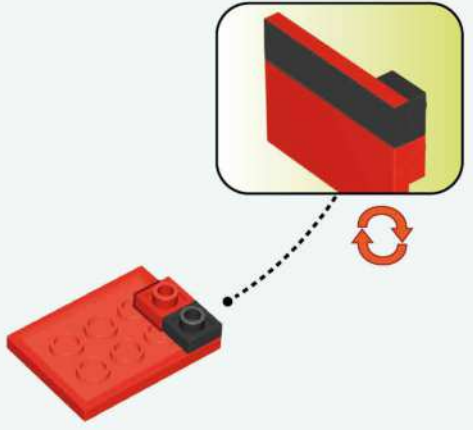



85



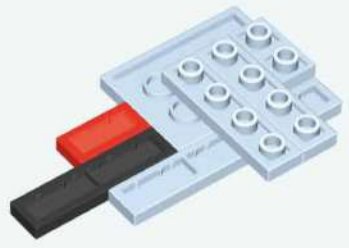

86



 x1
  x1
  x1

1:1
 x1
  x2

1:1 1:1
 x1
  x1

87

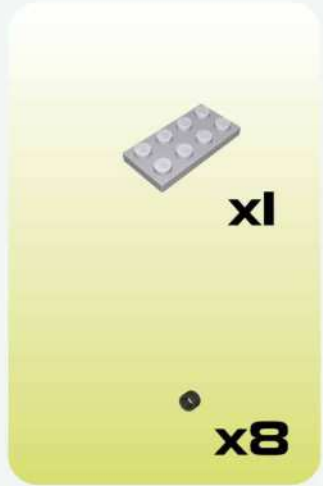
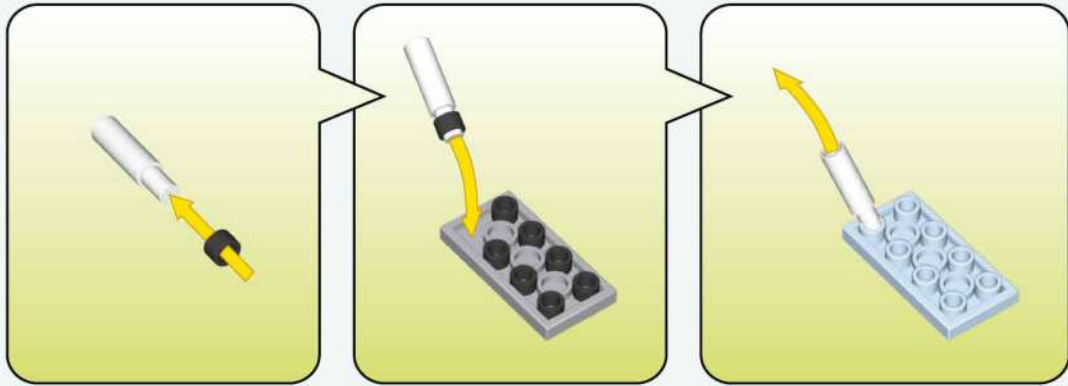

88

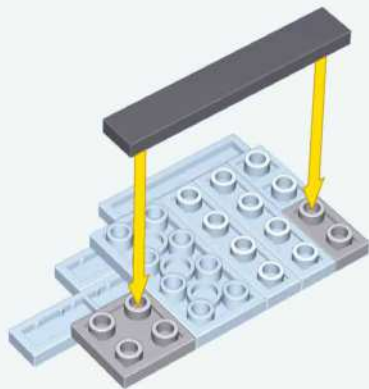

1:1



x1



x1



x1

89

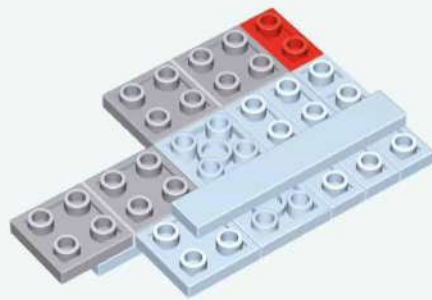

x4



x1

90

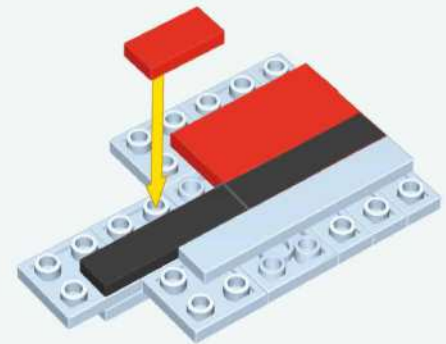

1:1

1:1



x1



x1



x1

91

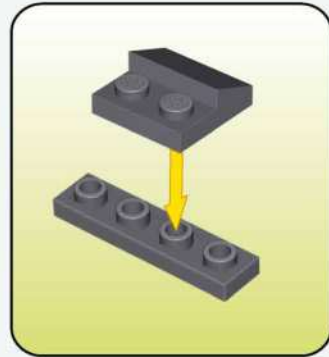
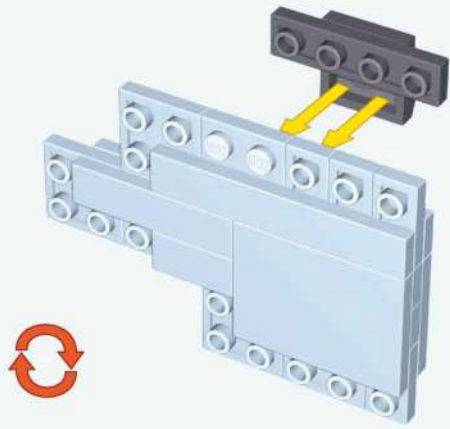

92

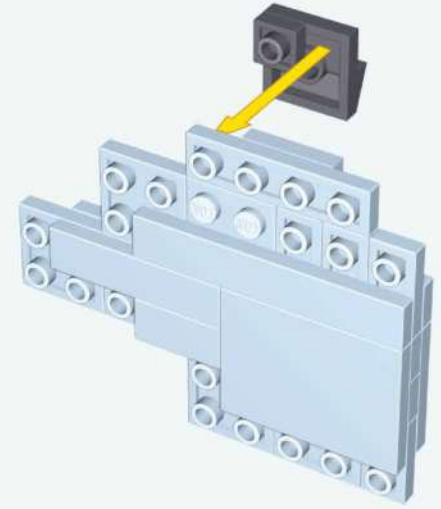
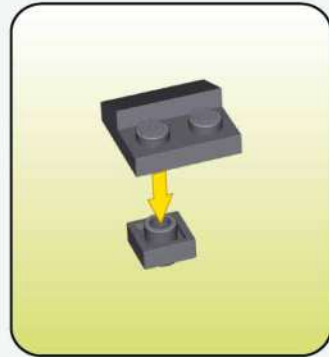

93

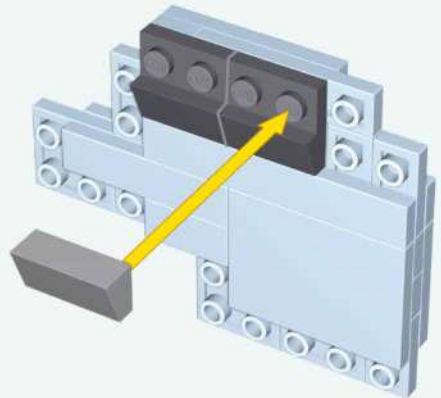

94



95

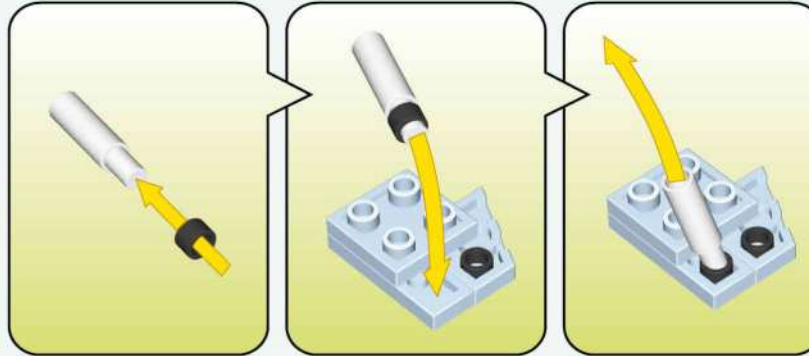

96



97



98

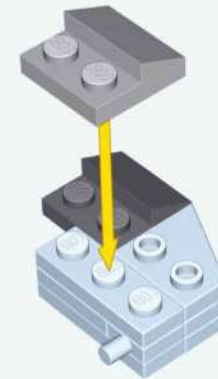

99

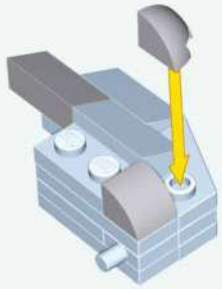

©



100

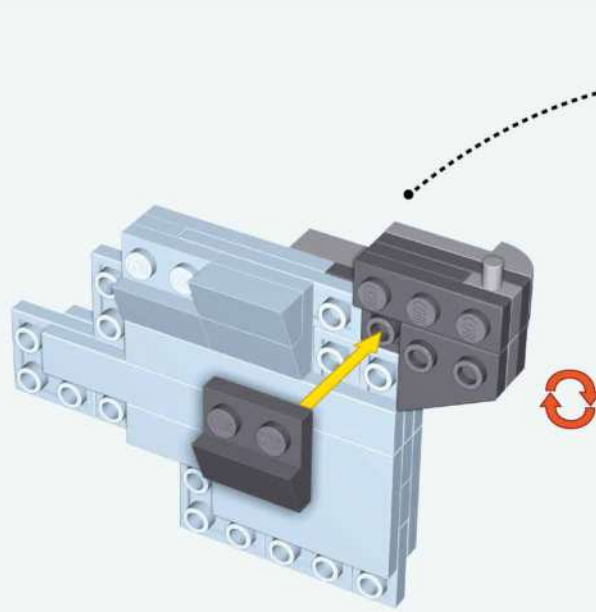

101

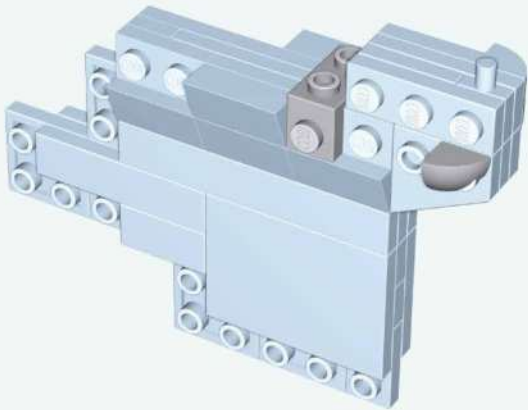

©



102

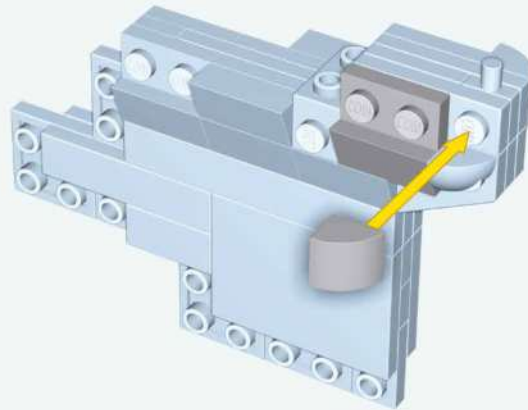

103

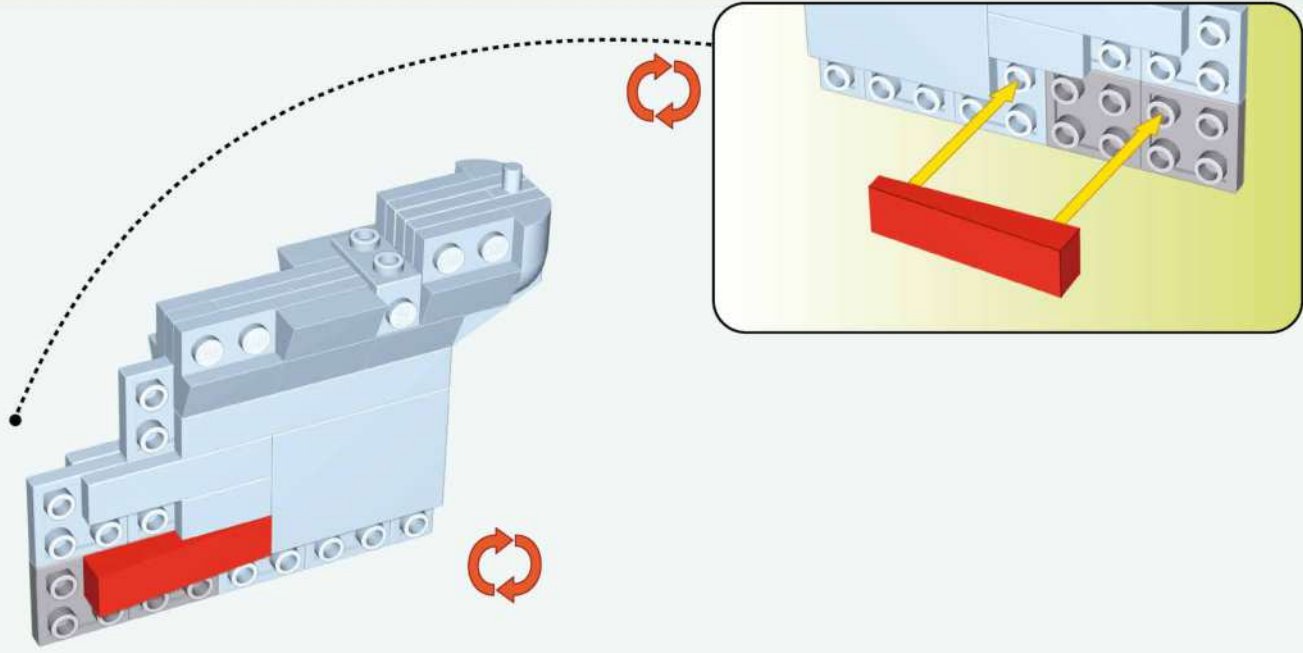
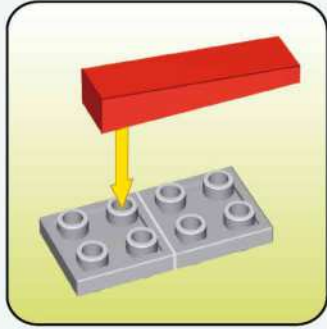

104

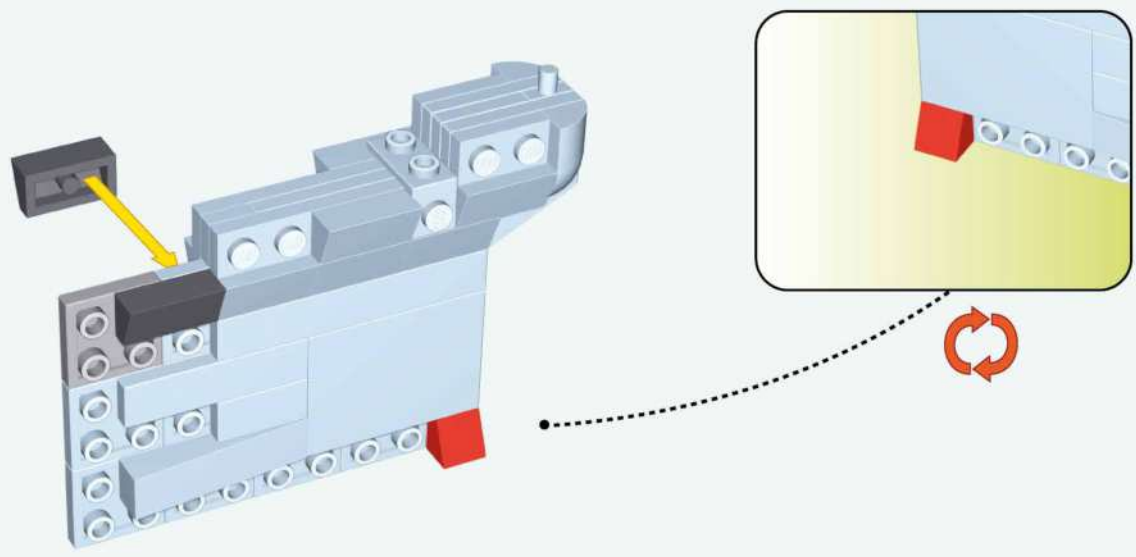
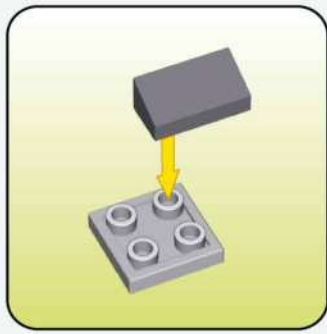

105

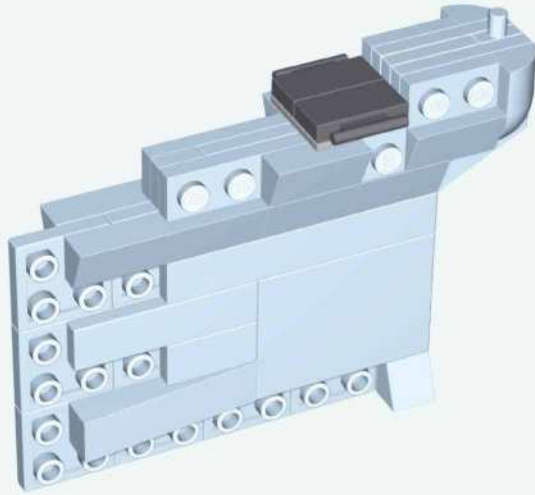
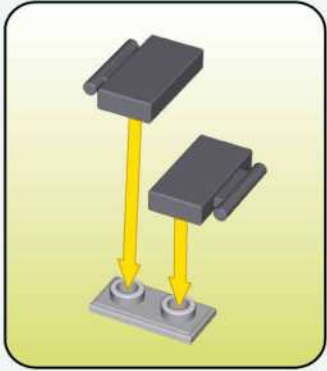

106

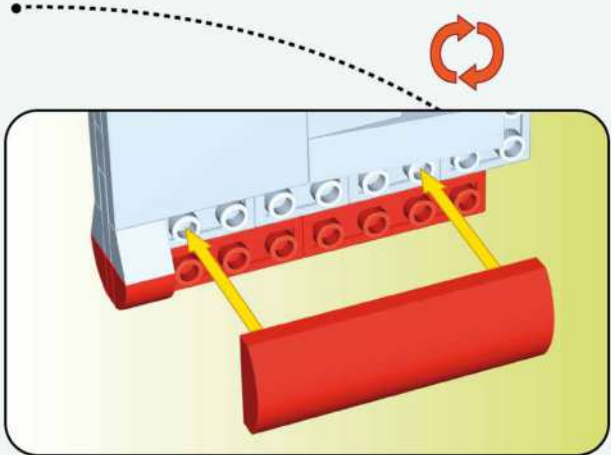
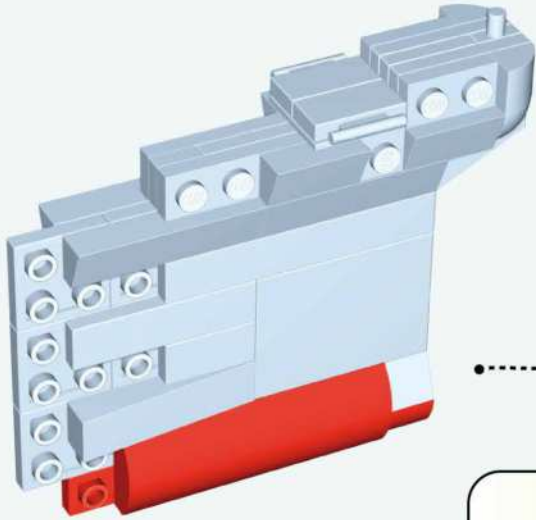
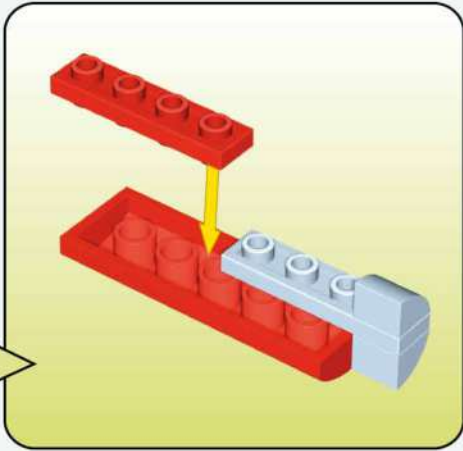
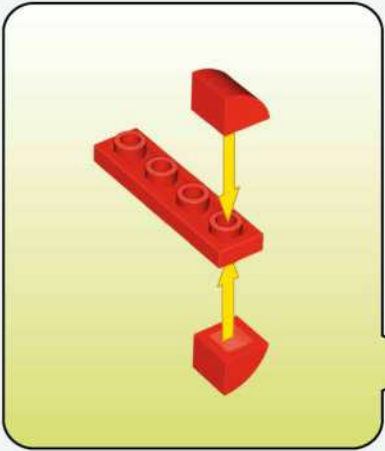

107

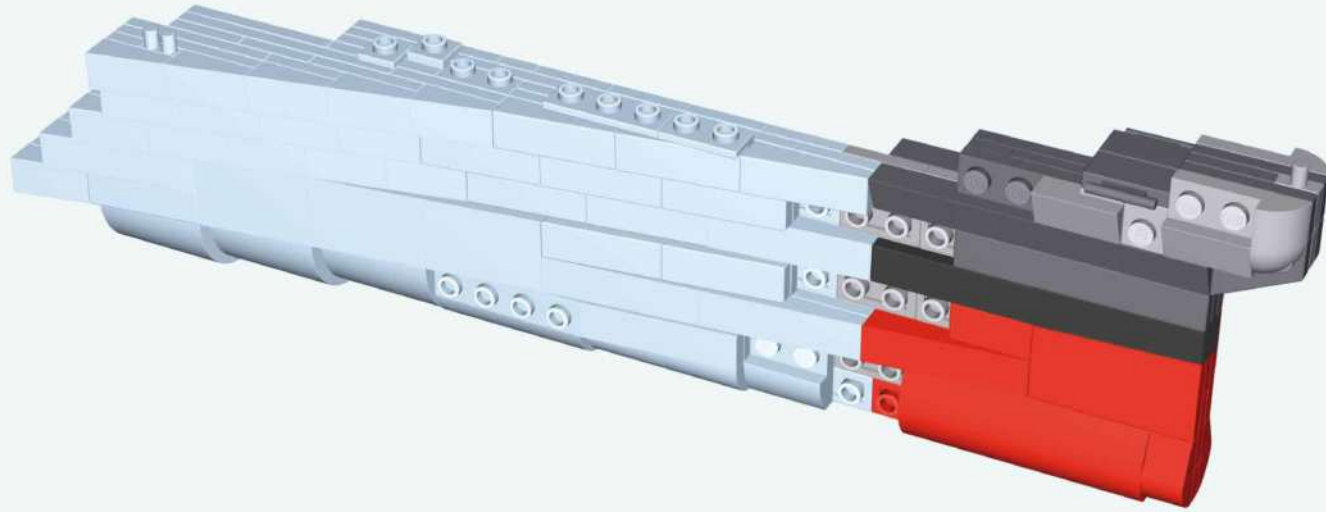

108

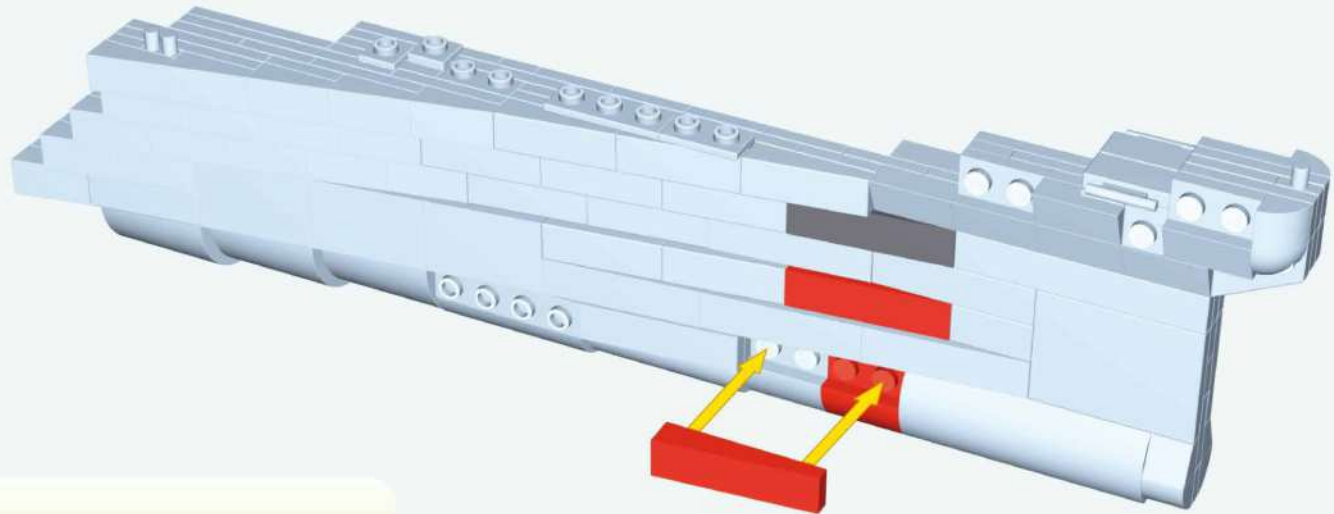

109

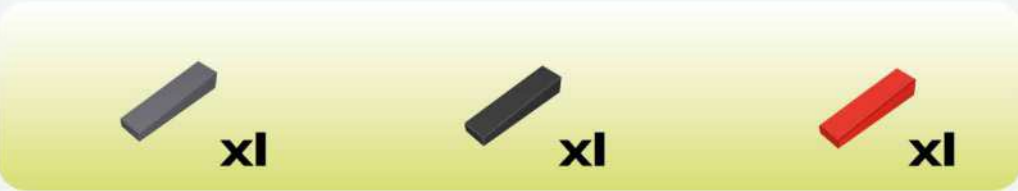
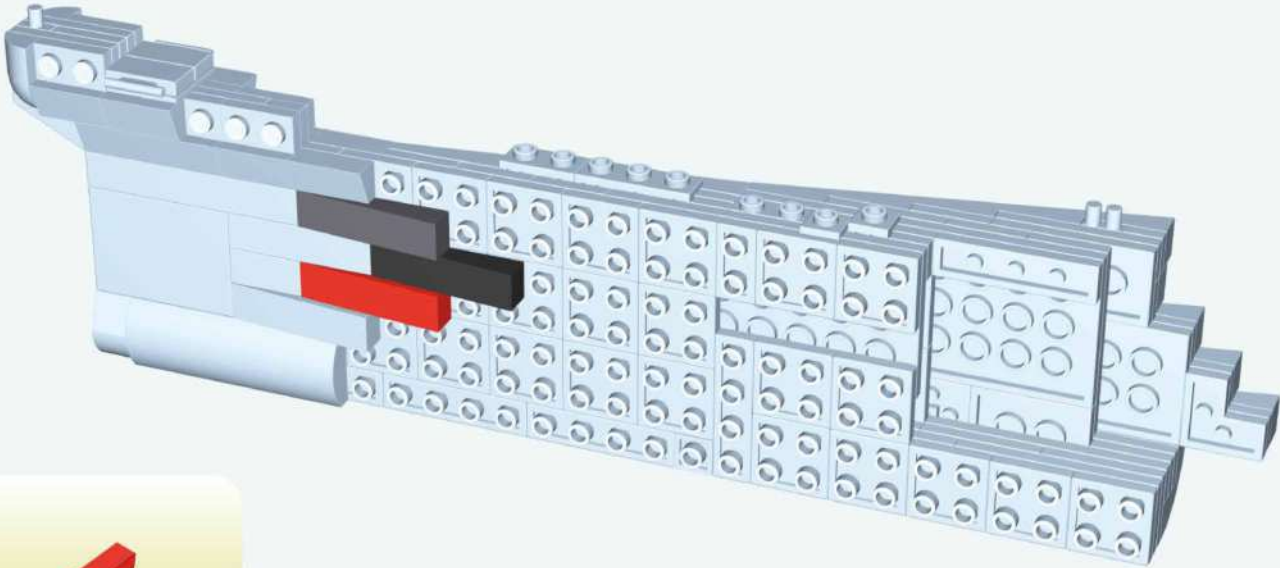

110

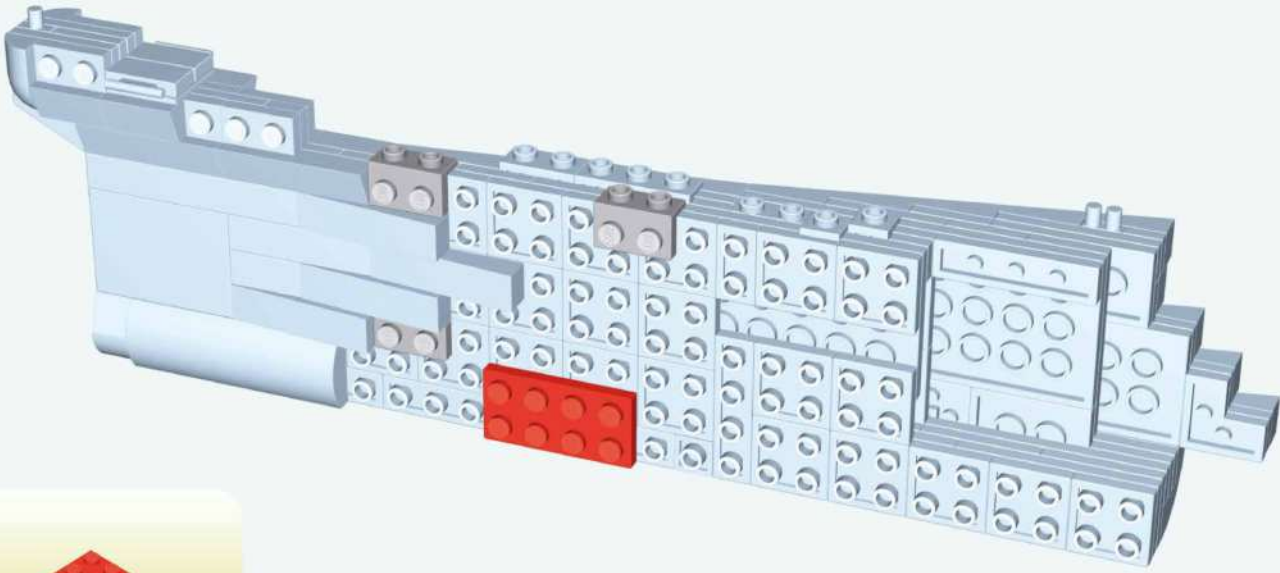

III

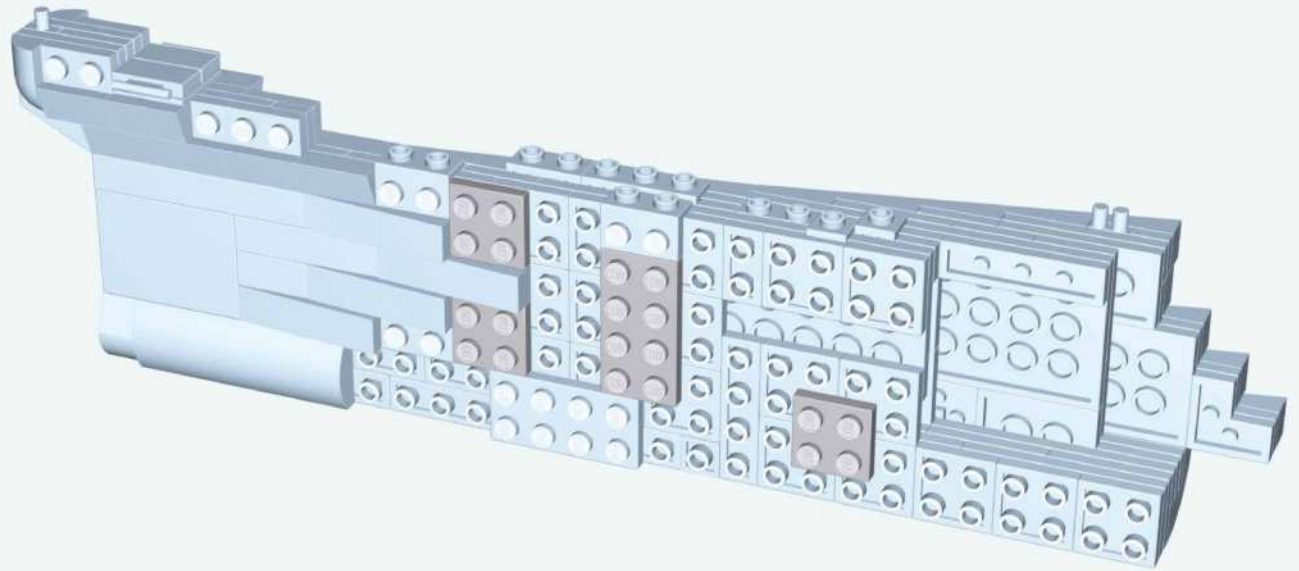

x3



x1

II2

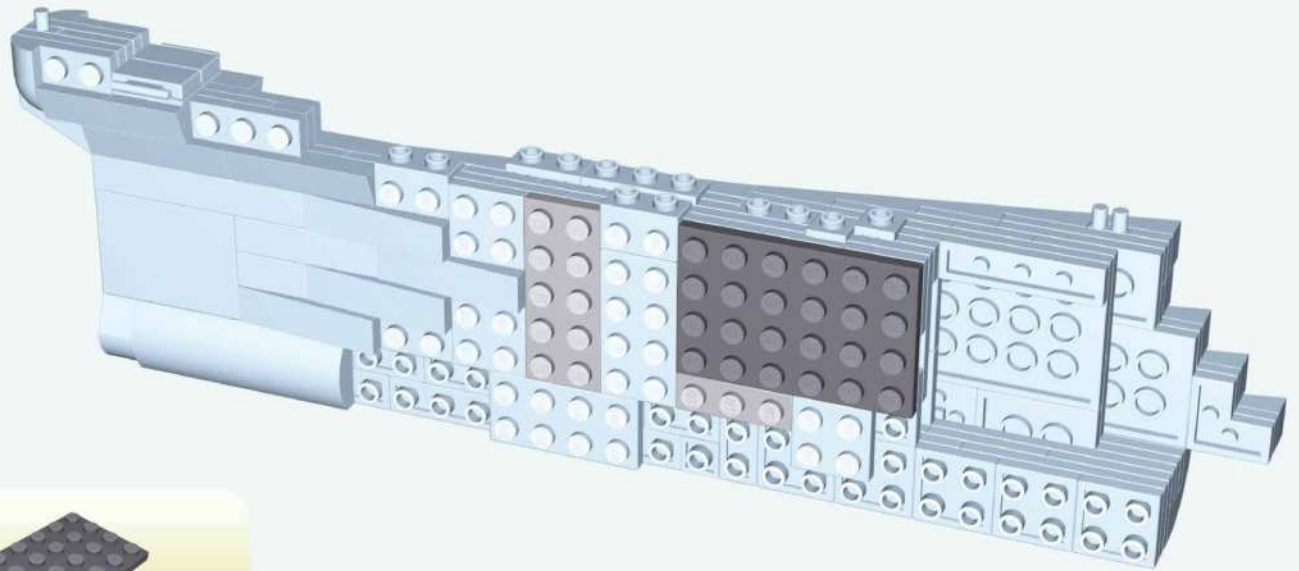

x1



x1



x1

113

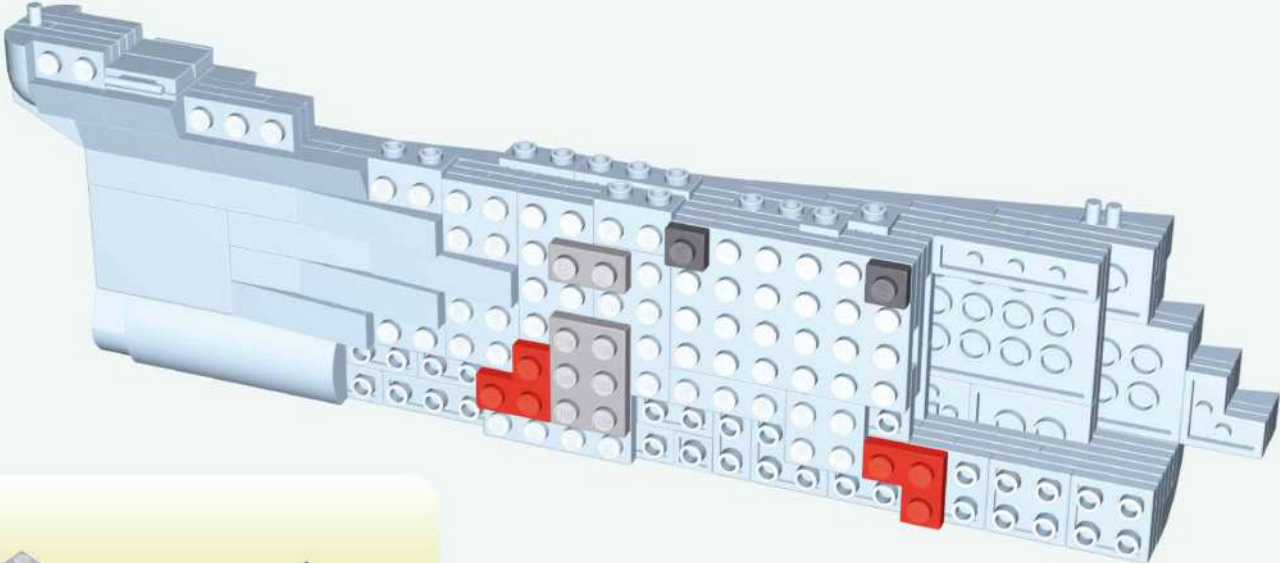

x2 x1 x1 x2

114

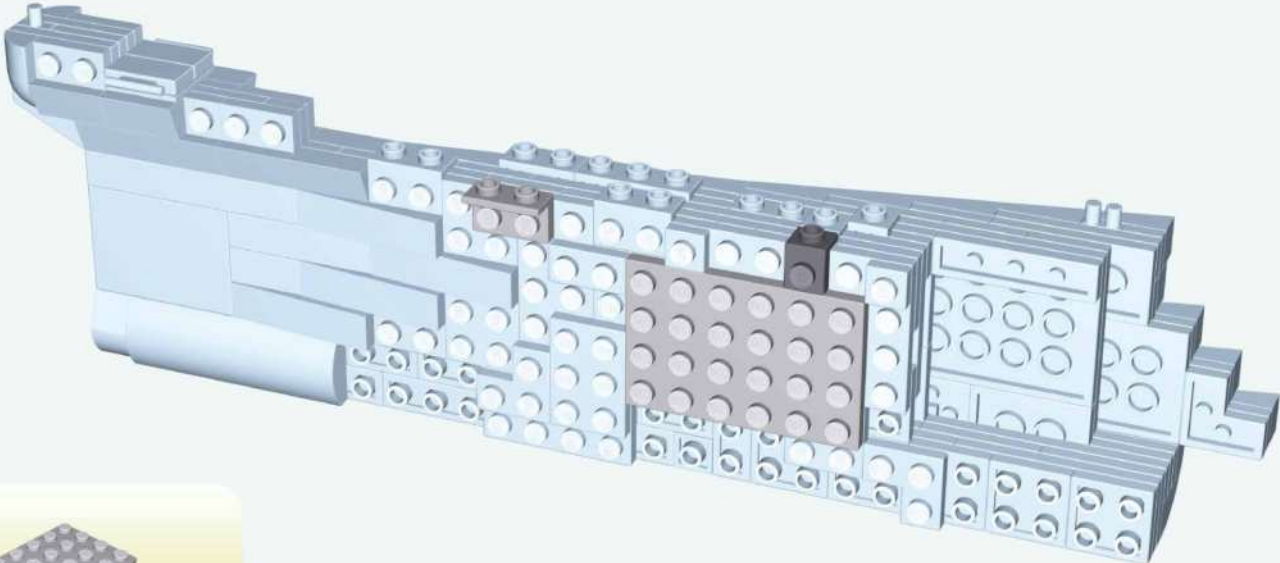

x1 x1 x1

115

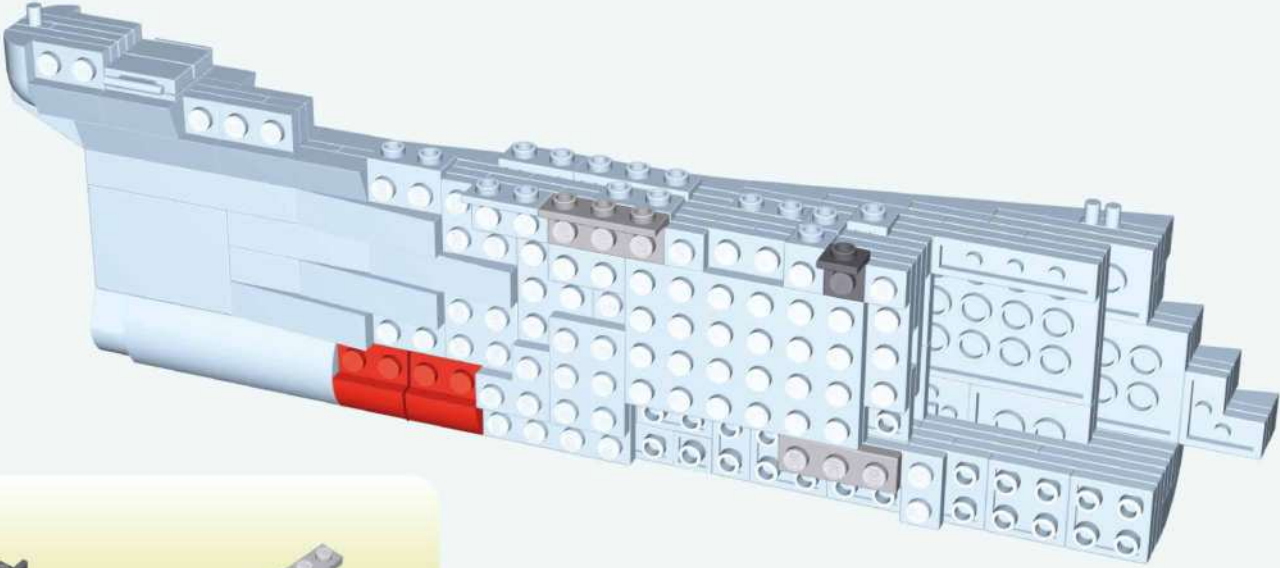

®
x2 x1 x1 x1

116

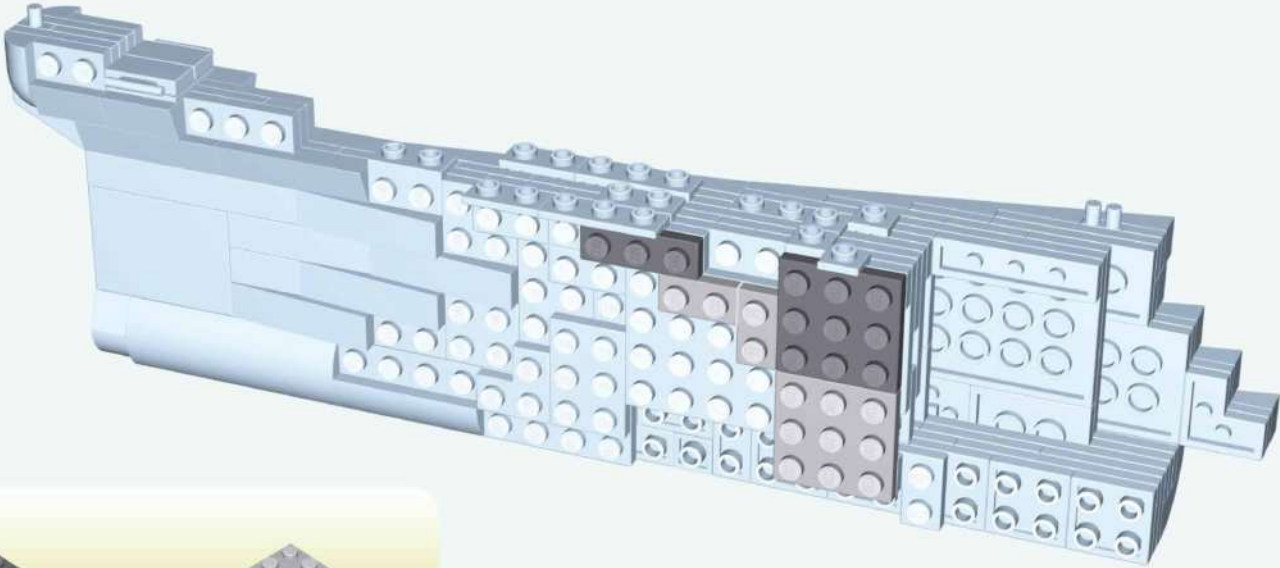

x1 x2 x1 x1

117

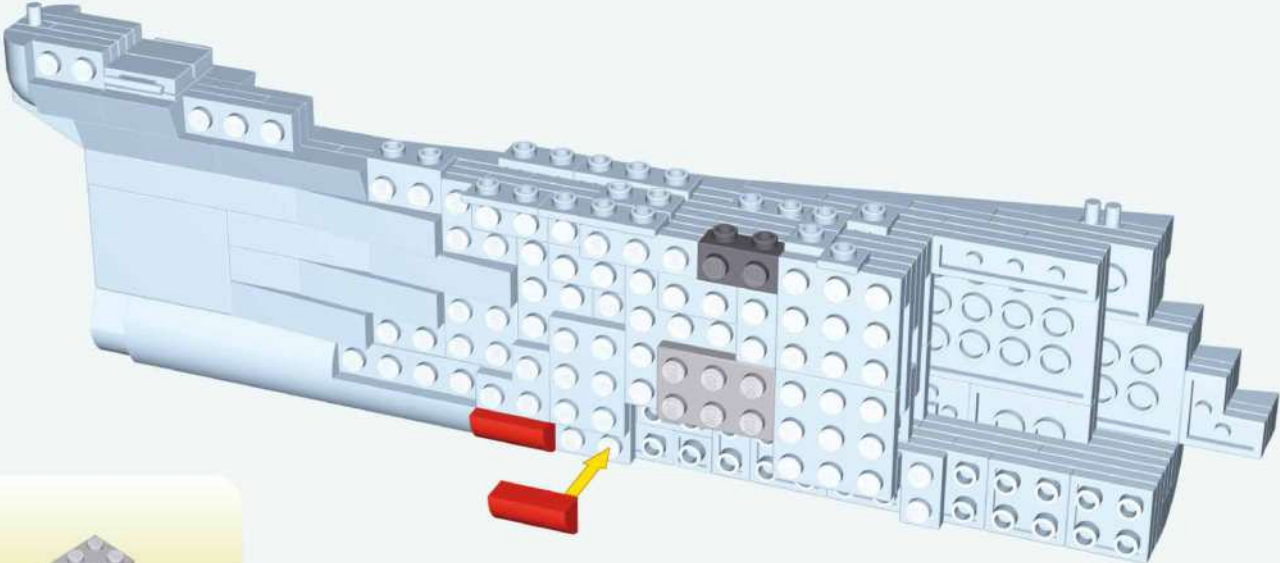

x2 ^① x1 x1

118

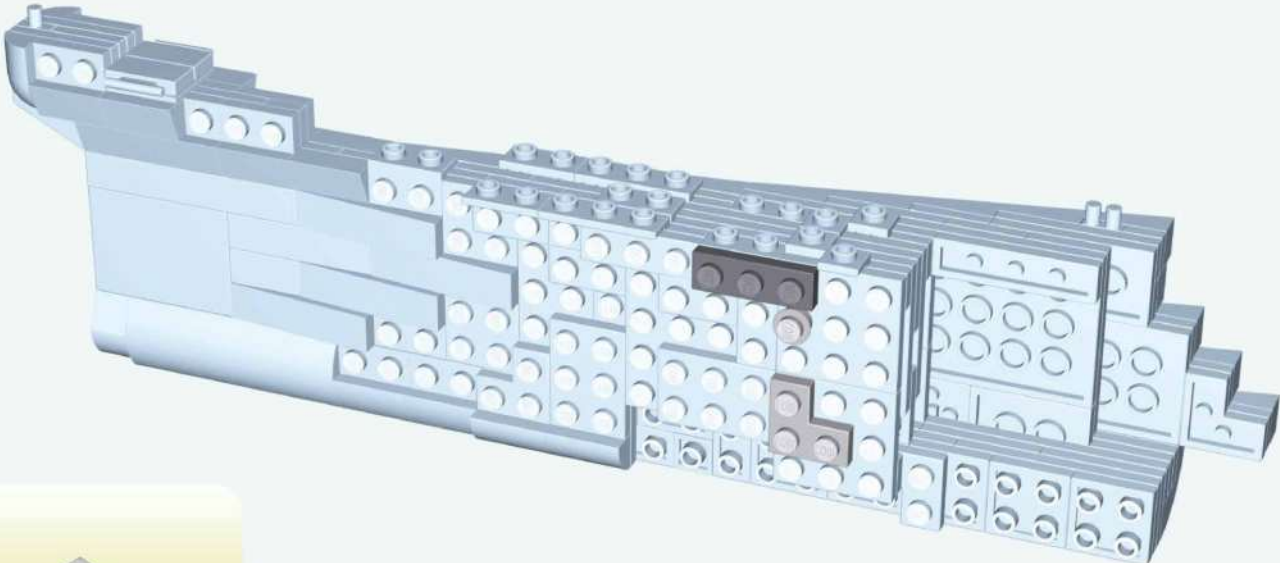

x1 x1 x1

119

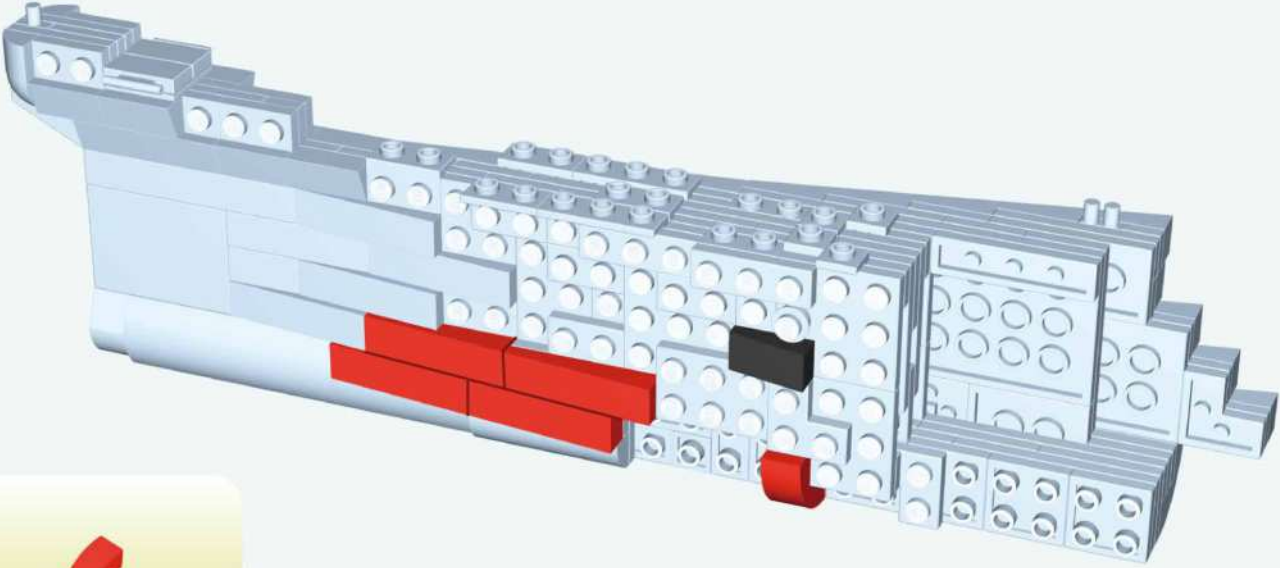

x4 x1 x1

120

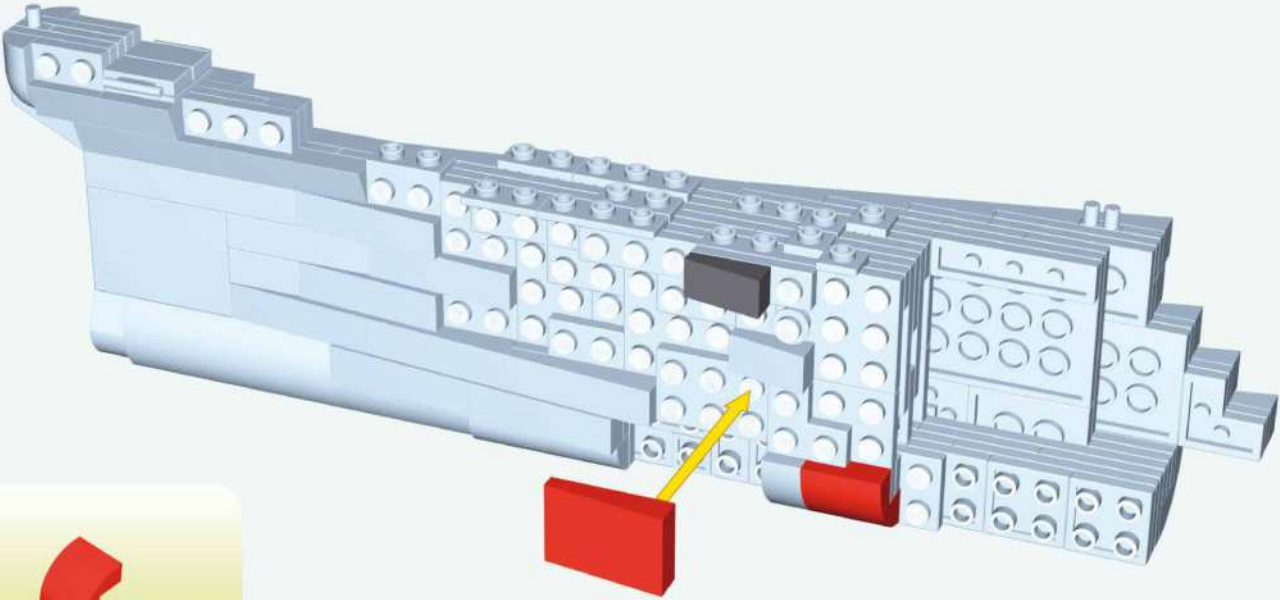

® x1 x1 x1

121



x2



x1

122

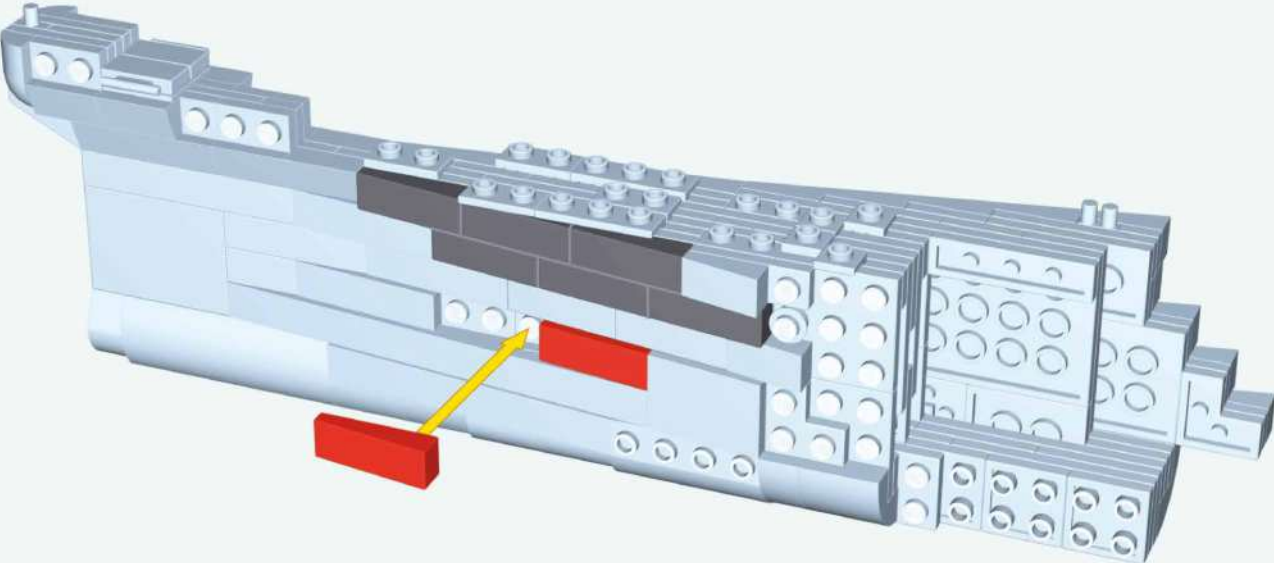

⊙



x6



x2

123

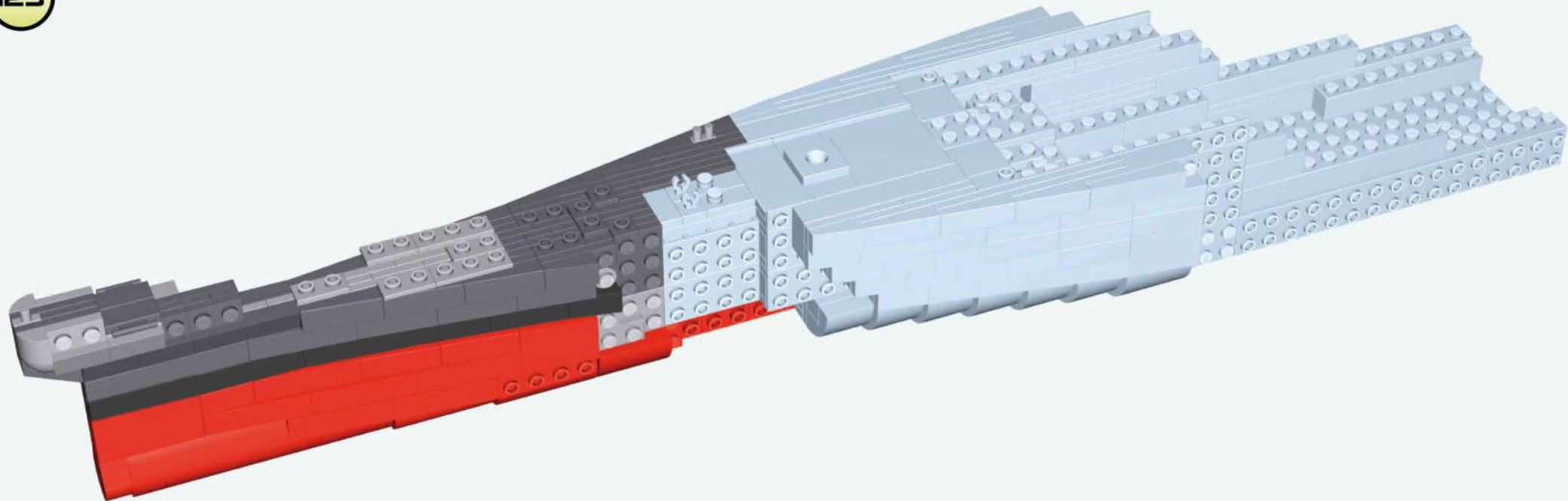

124

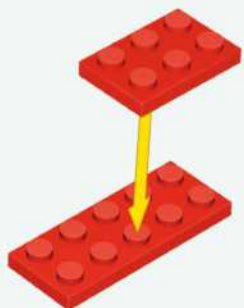

x1



x1

125

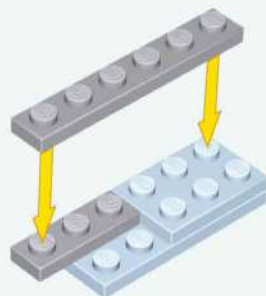

x1



x1

126



x1



x1

127



x1



x1

128

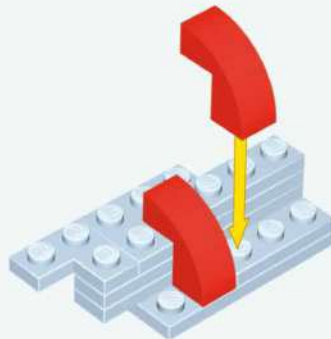

x2

129

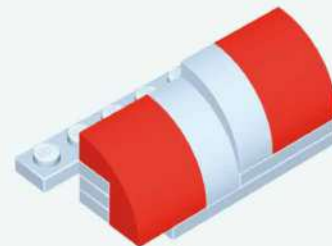

x2

130

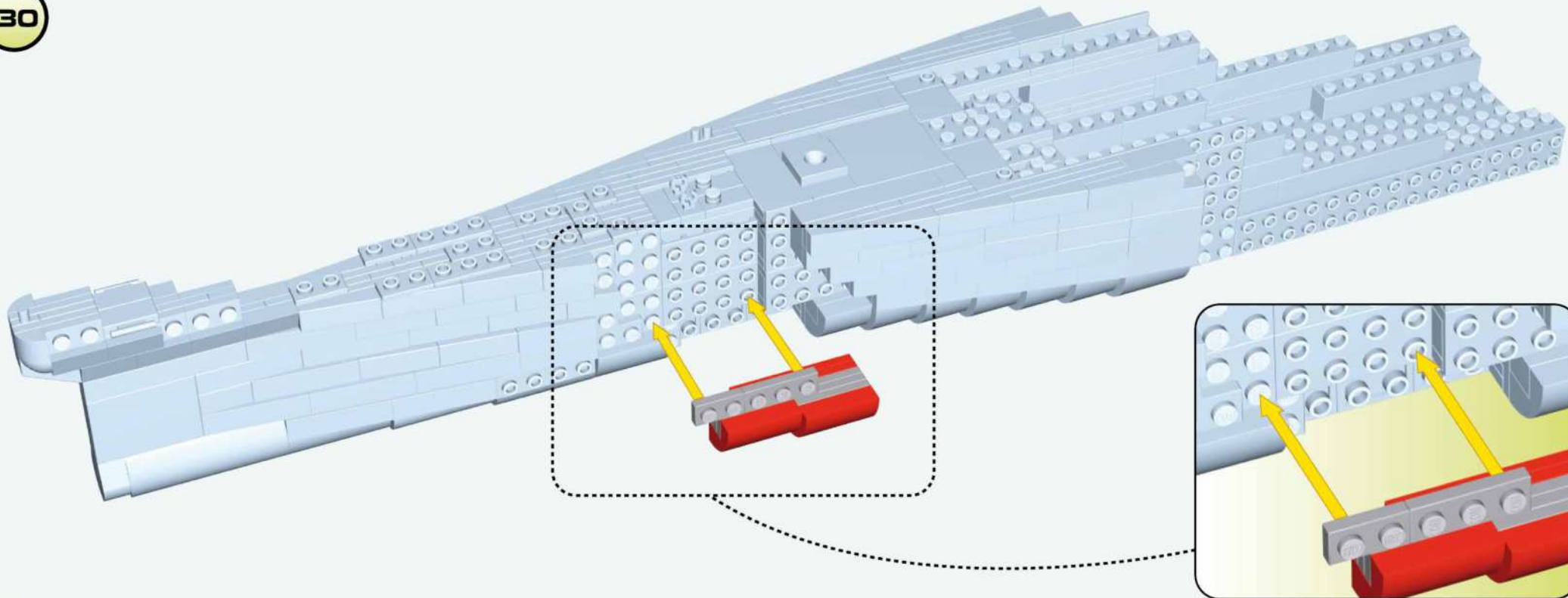

131

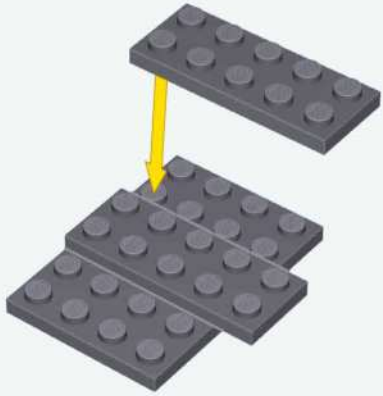

x1



x2

132



x1



x2

133

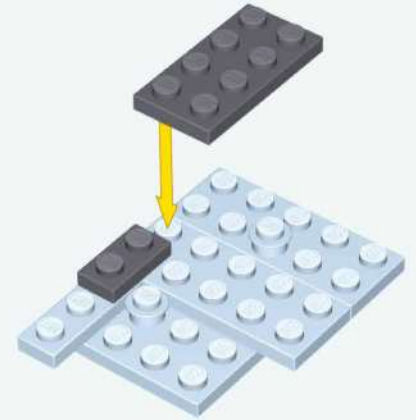

x1



x1

134

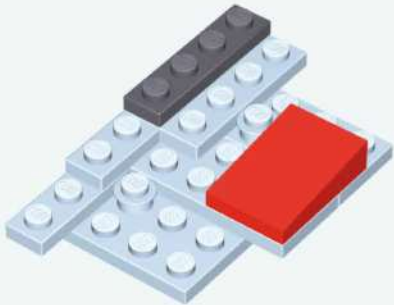

x1

®



x1

135

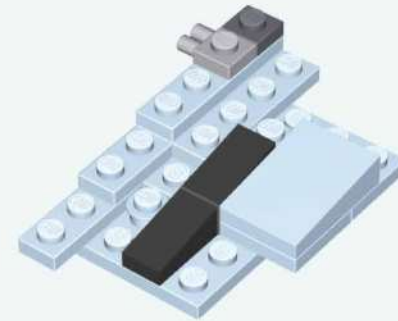

x1



x1



x2

136

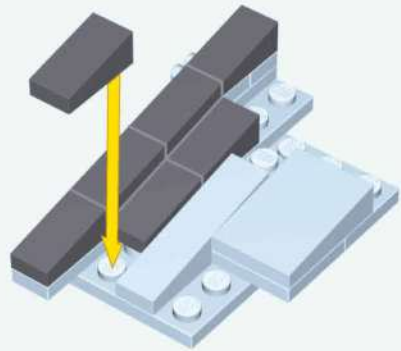



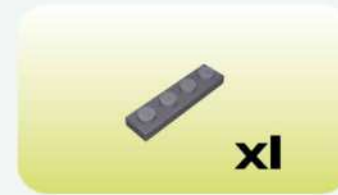
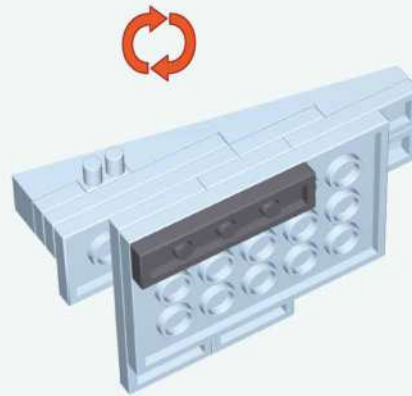



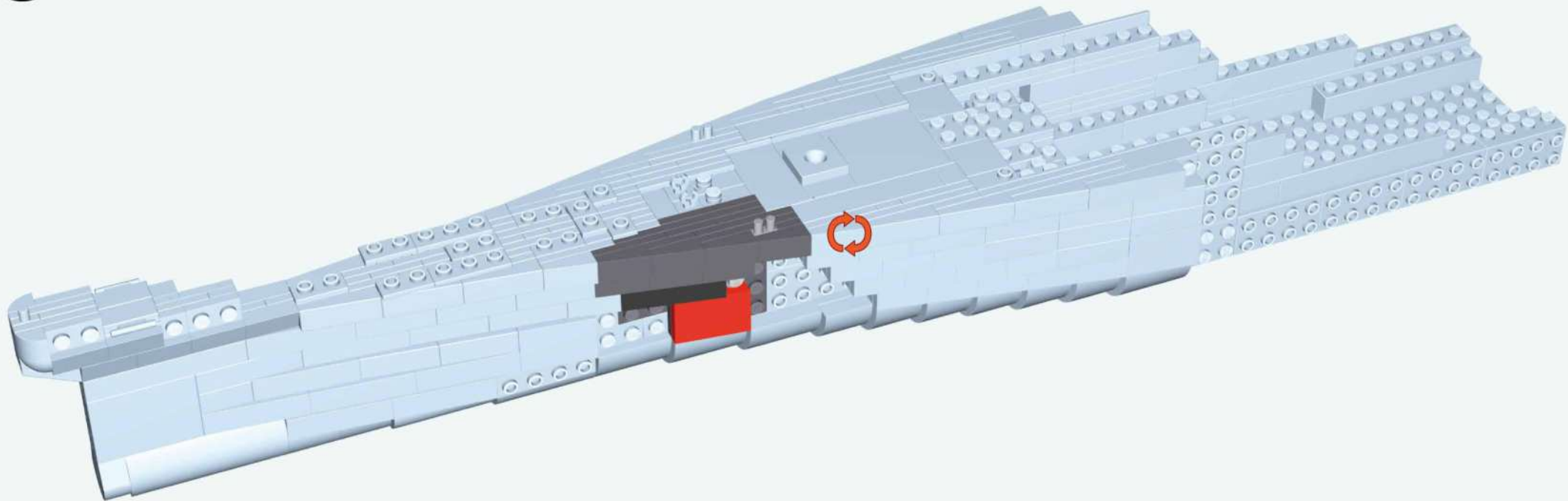

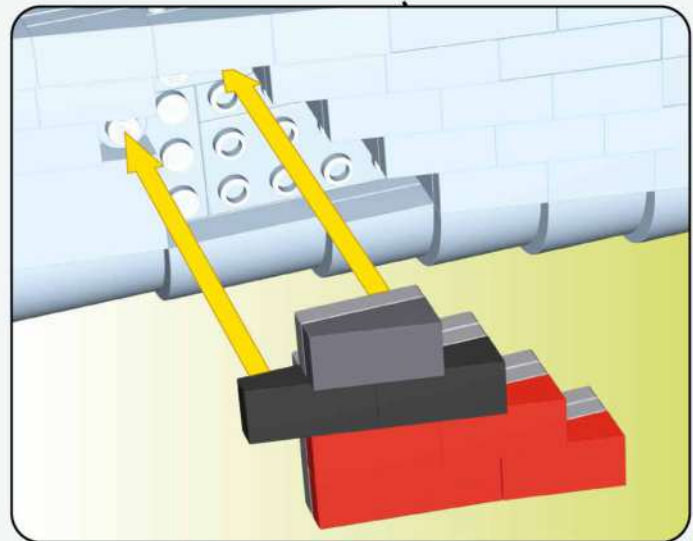
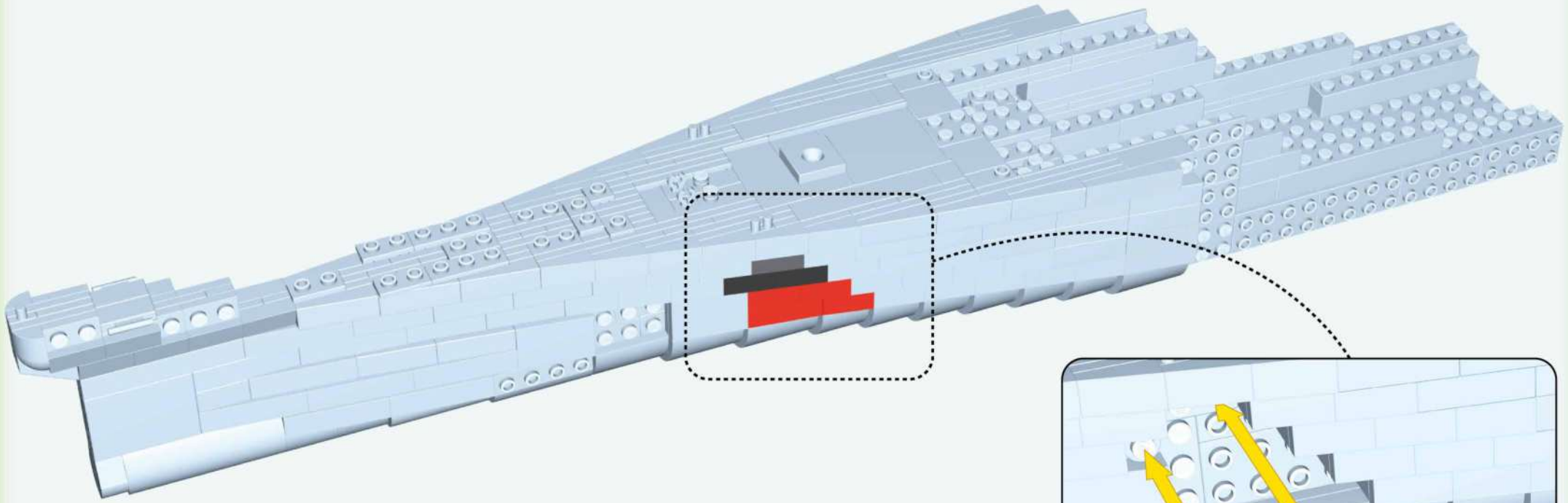
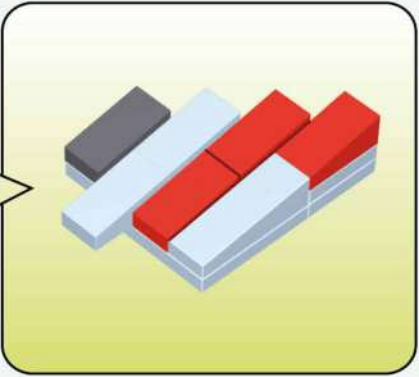
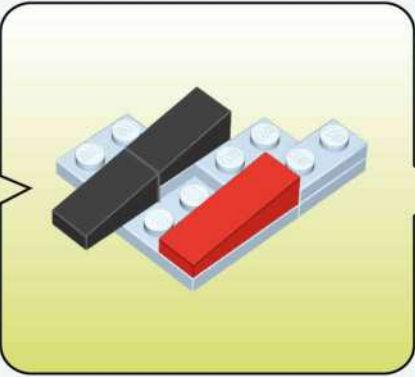
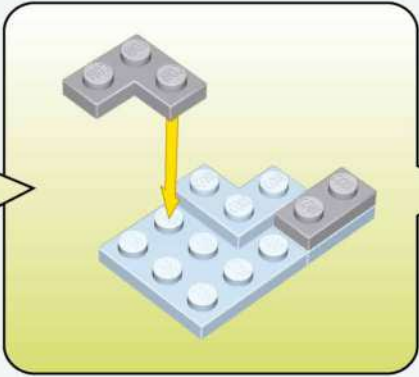
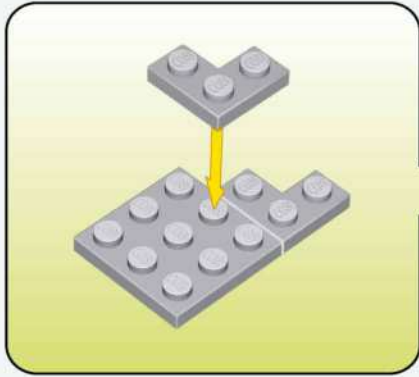
137



138





-  x1
-  x3
-  x1
-  x2
-  x1
-  x1
-  x3

140

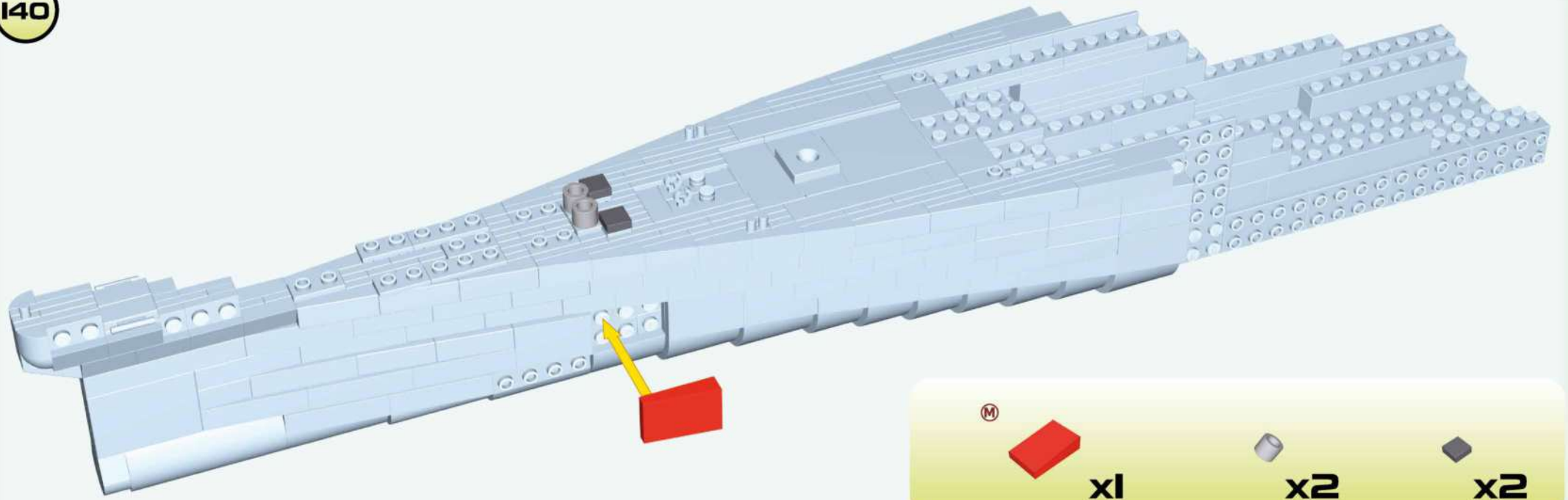

 x1
  x2
  x2



141

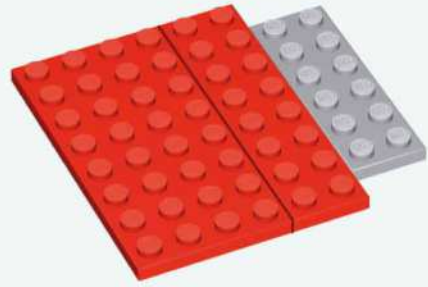

 x1
  x1
  x1

142

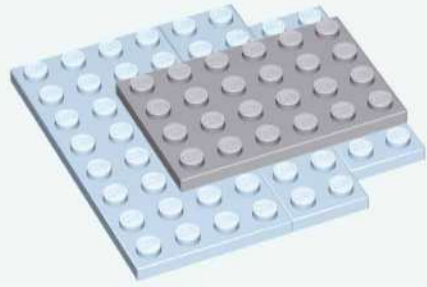

 x1

143

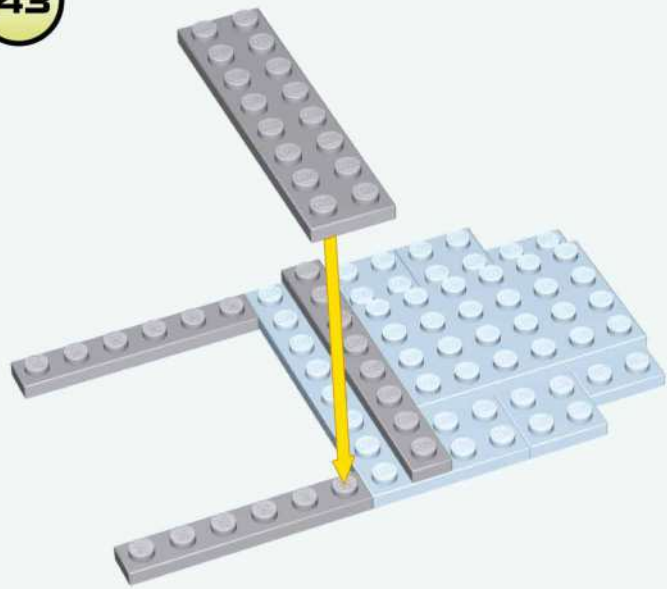

144

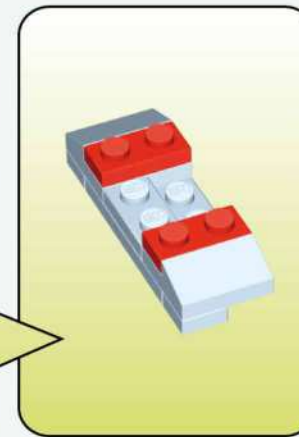
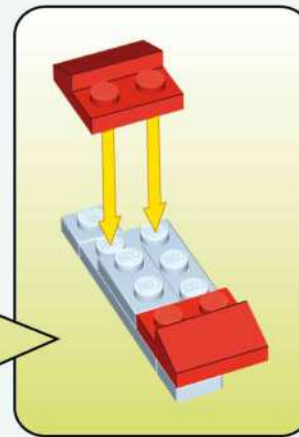
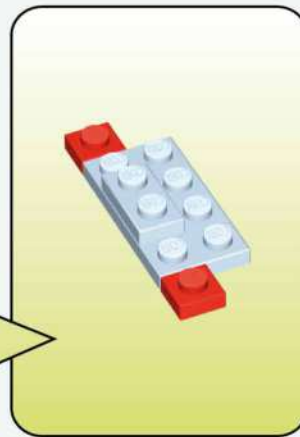
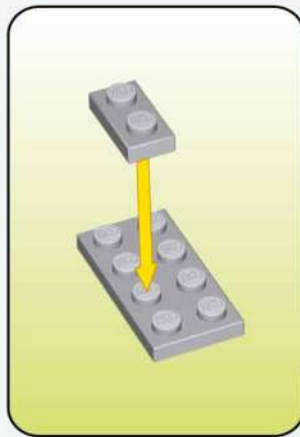

145

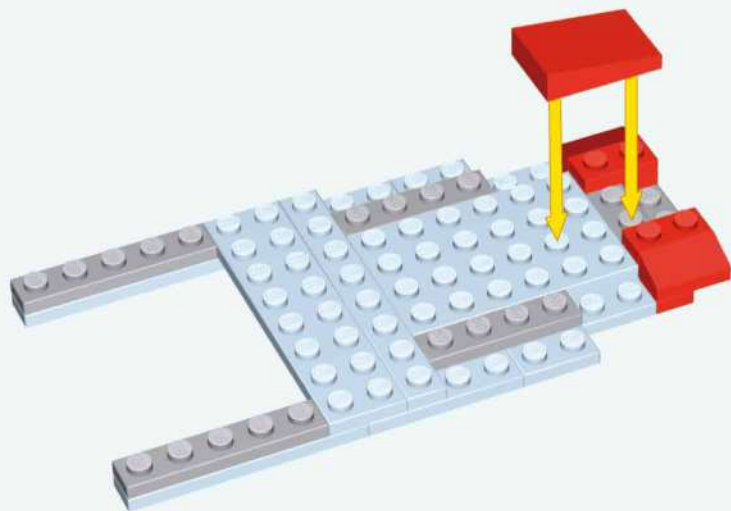

146

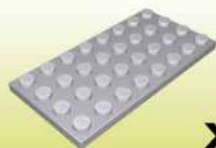
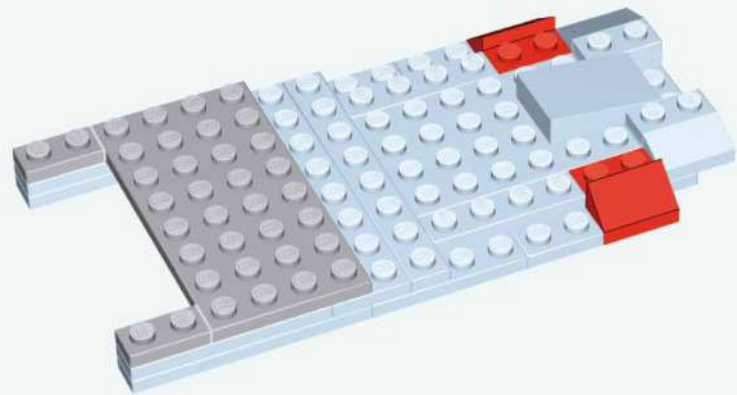

x1



x2

Ⓑ



x2

147

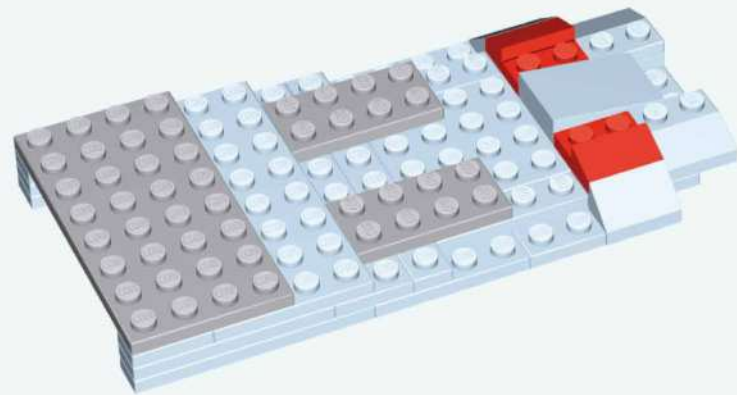

x1



x2

Ⓒ



x2

148

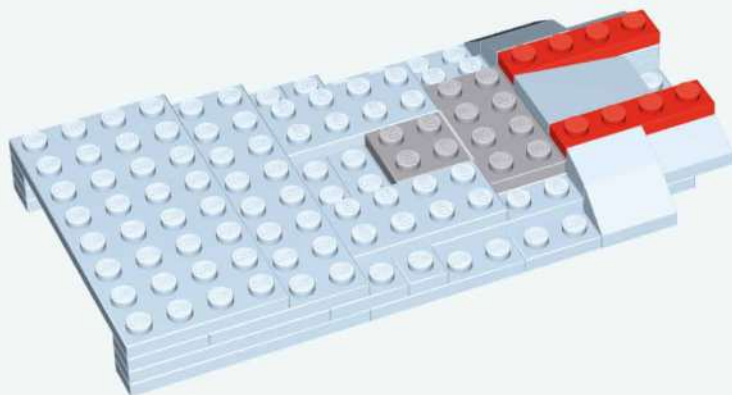

x1



x1



x2

149

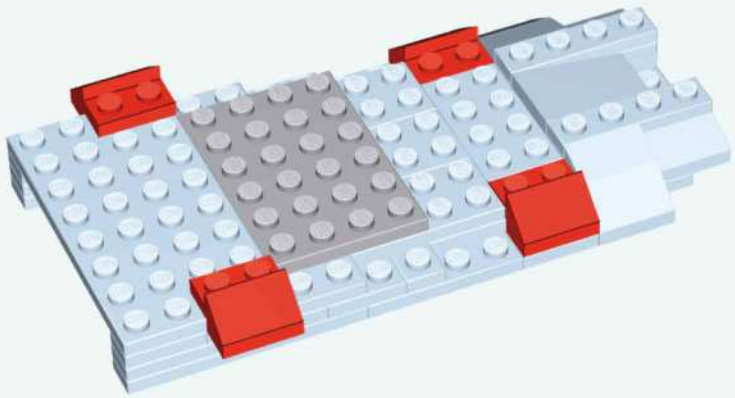

150

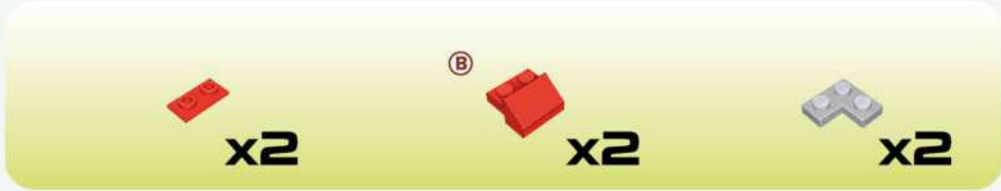
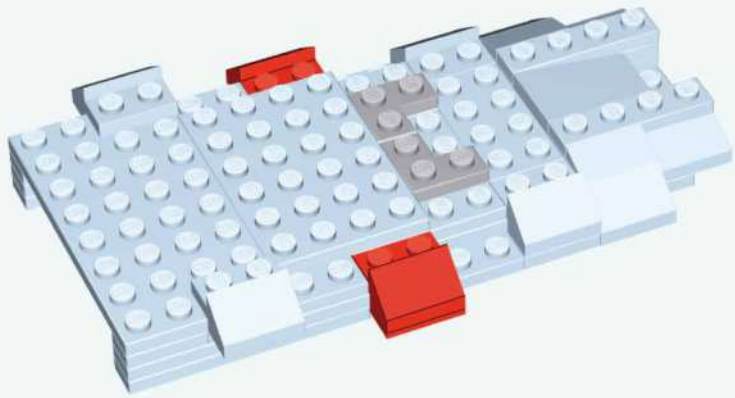
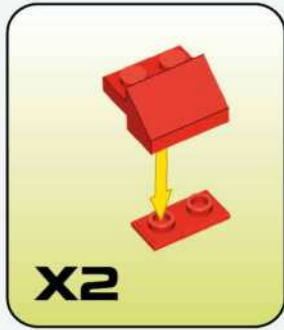

151

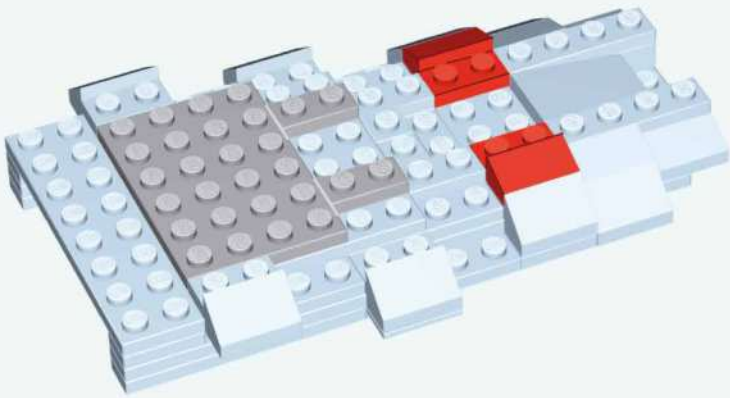

152

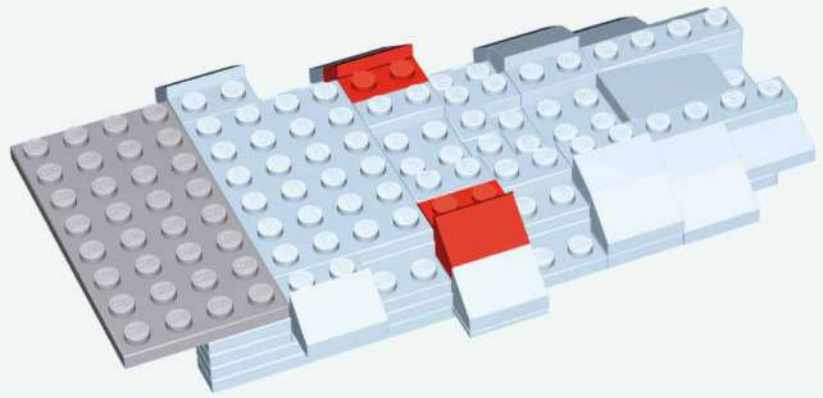

153

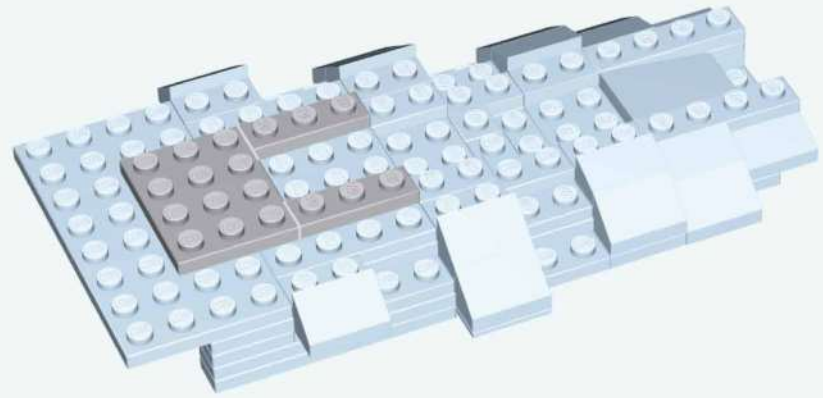

154

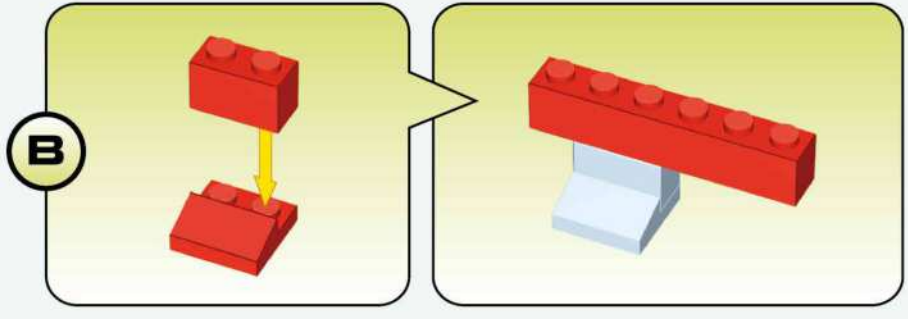
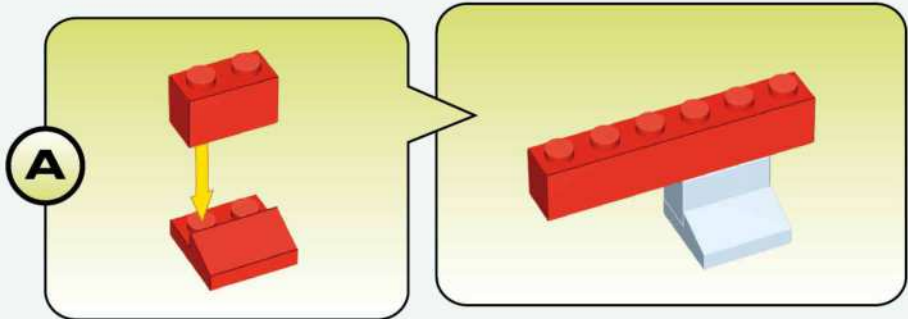

155

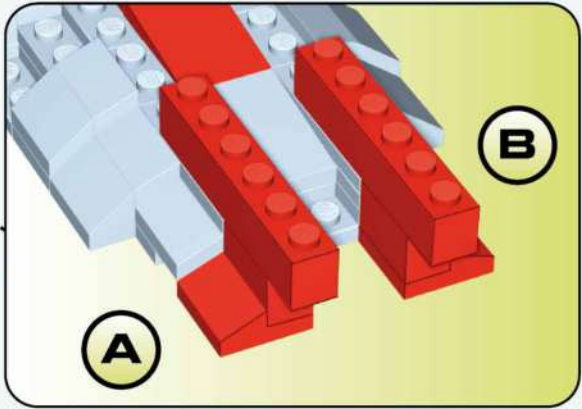
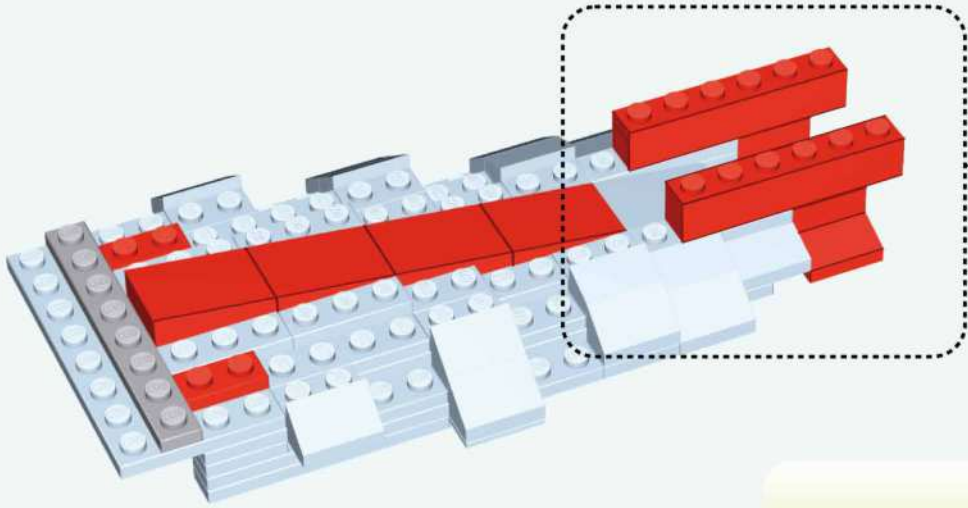

156

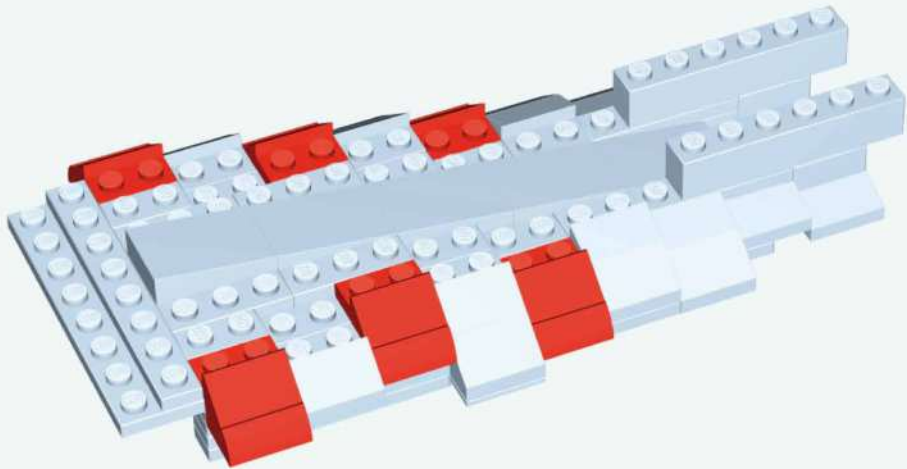
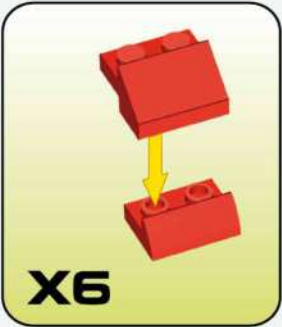

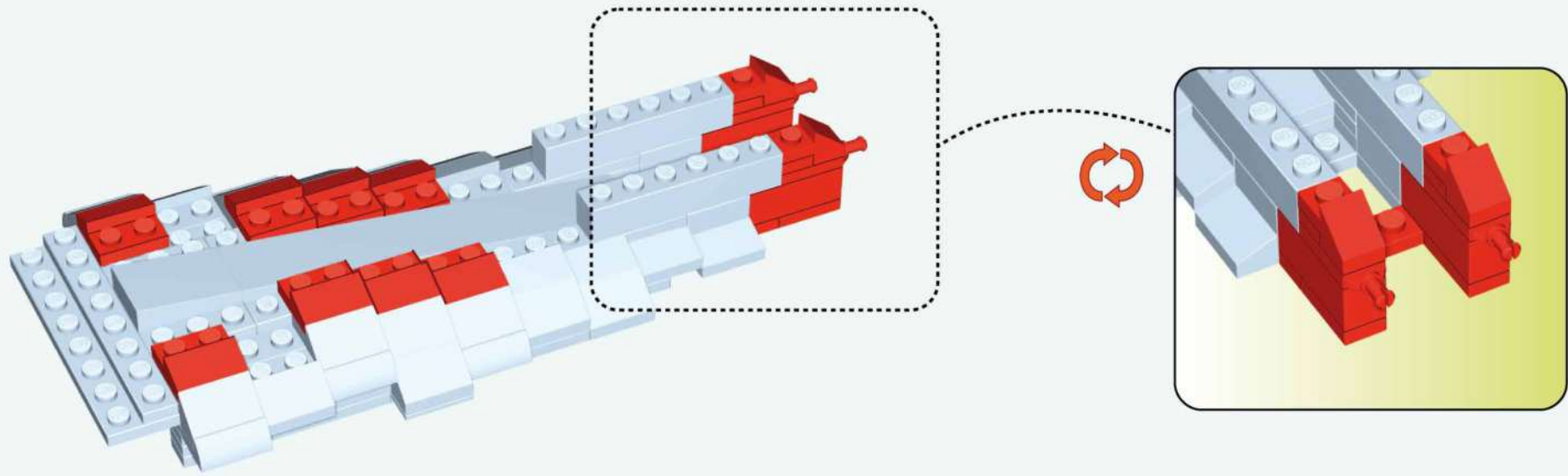
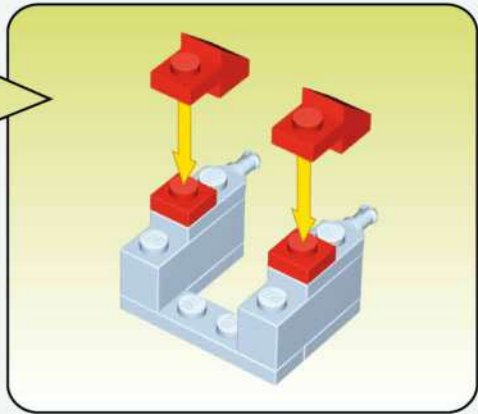
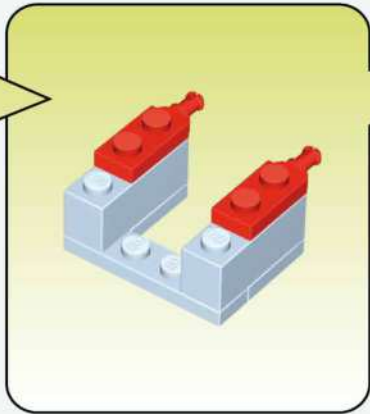
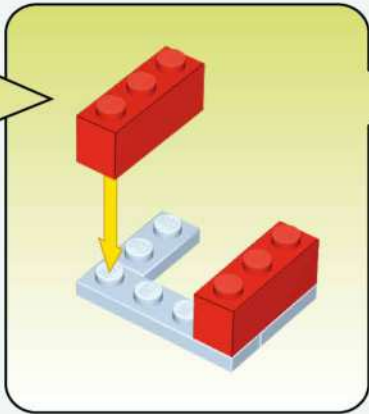
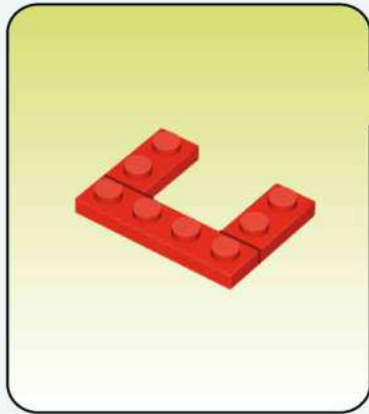

158

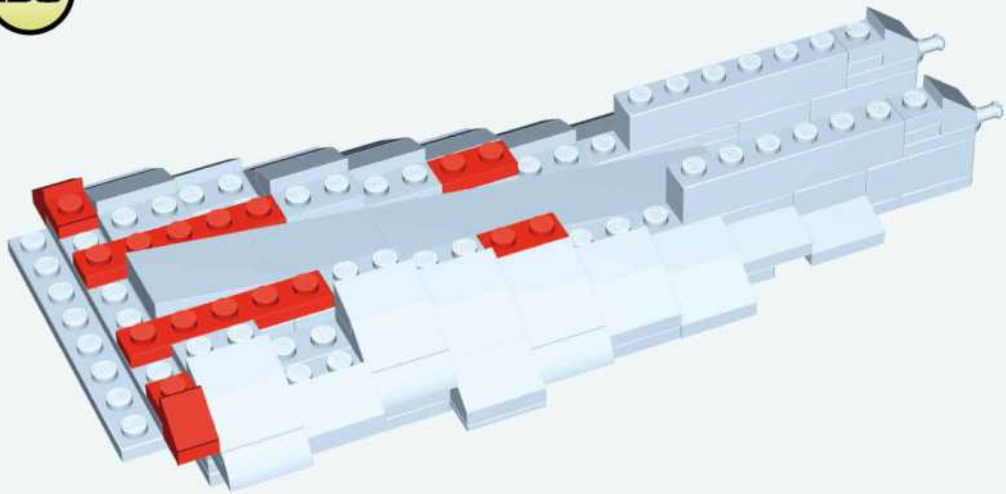

159

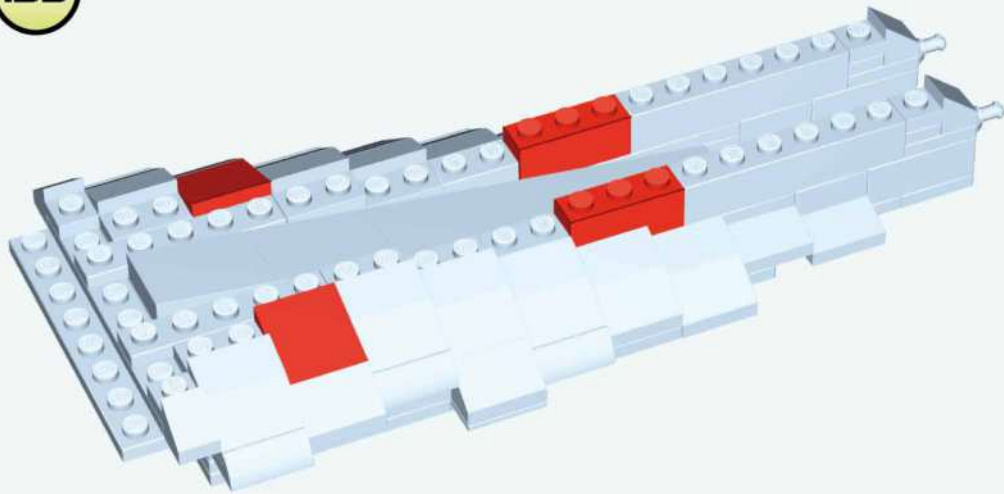

160

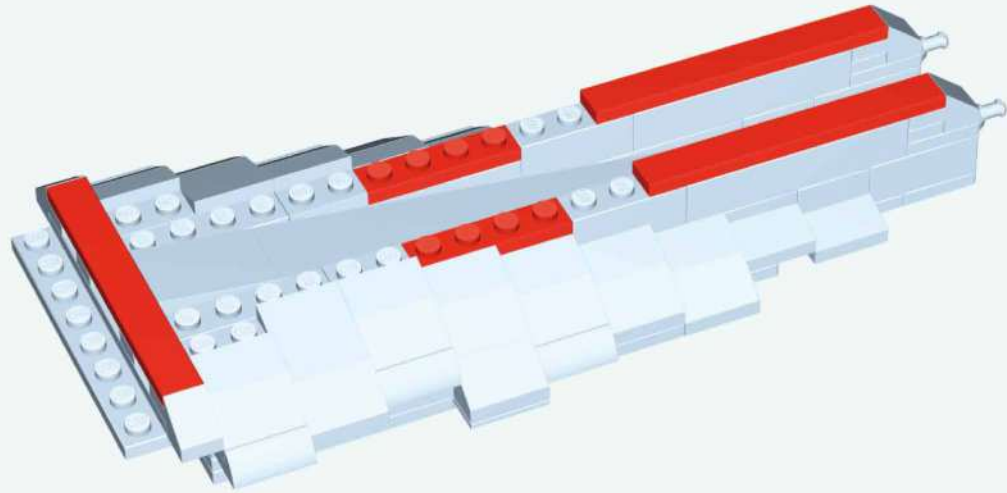

161

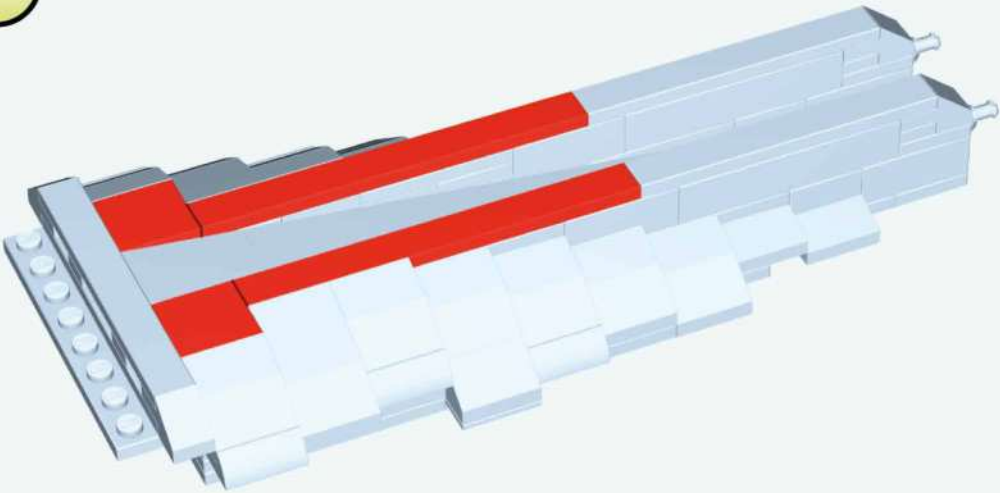

1:1



162

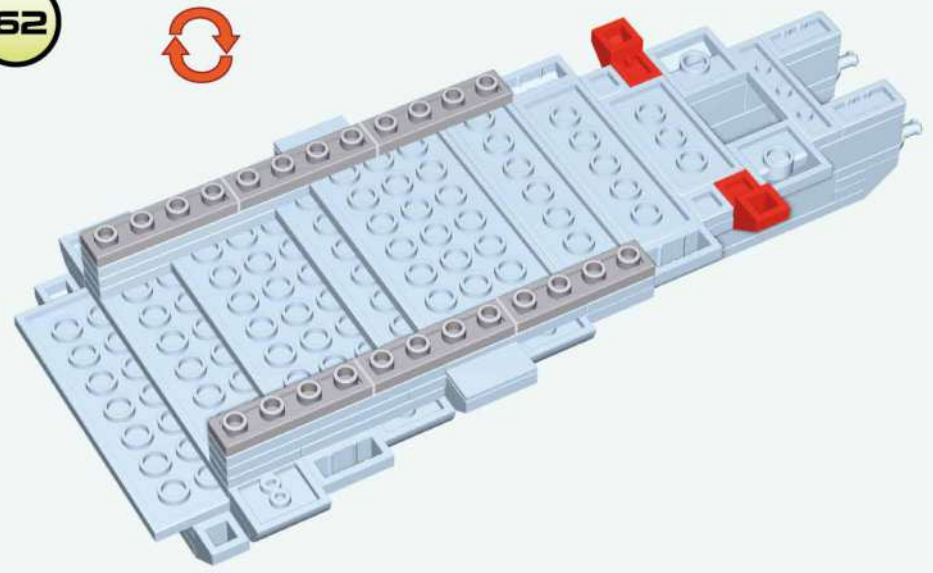

163

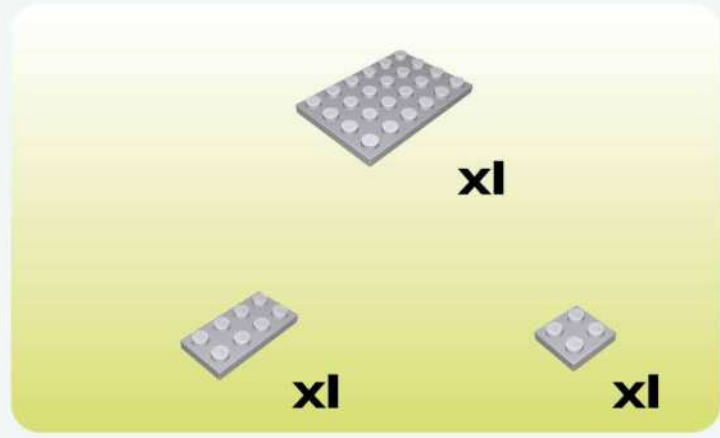
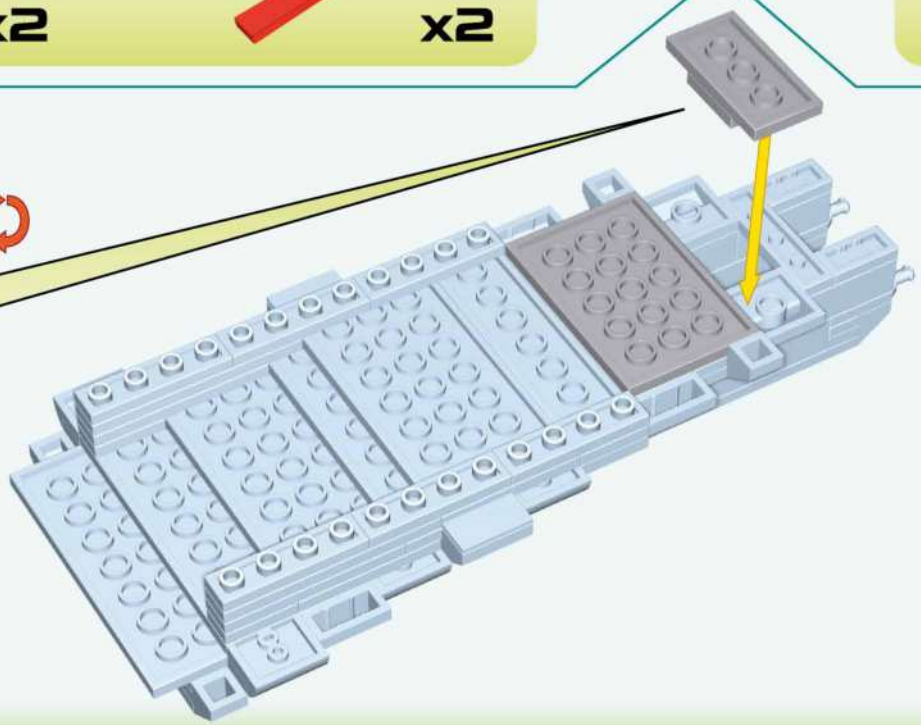
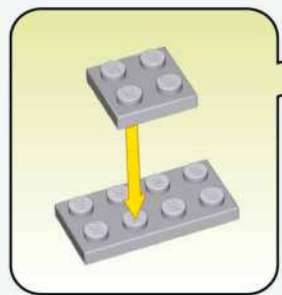

164

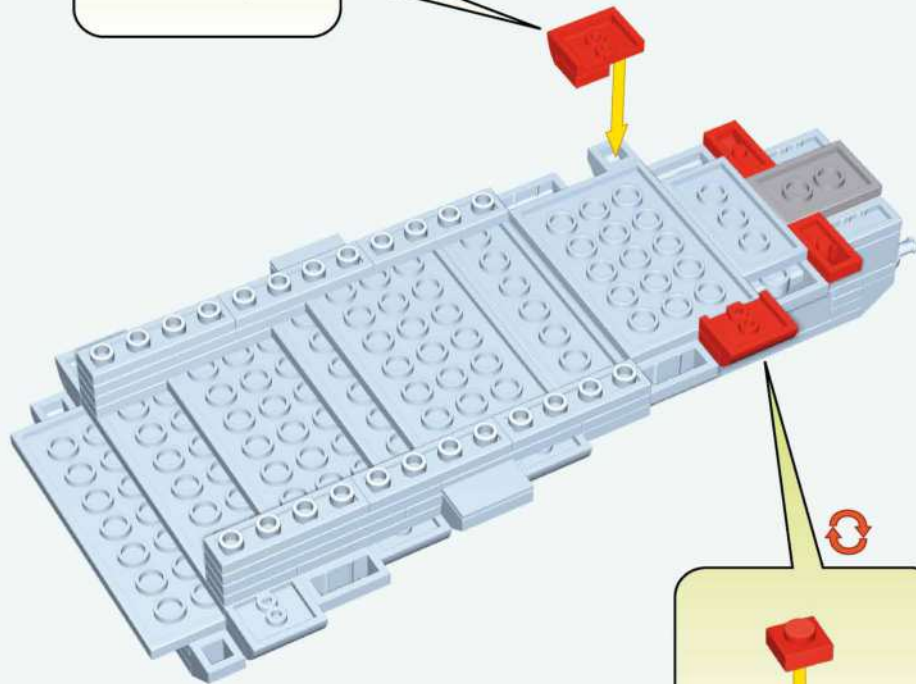

165

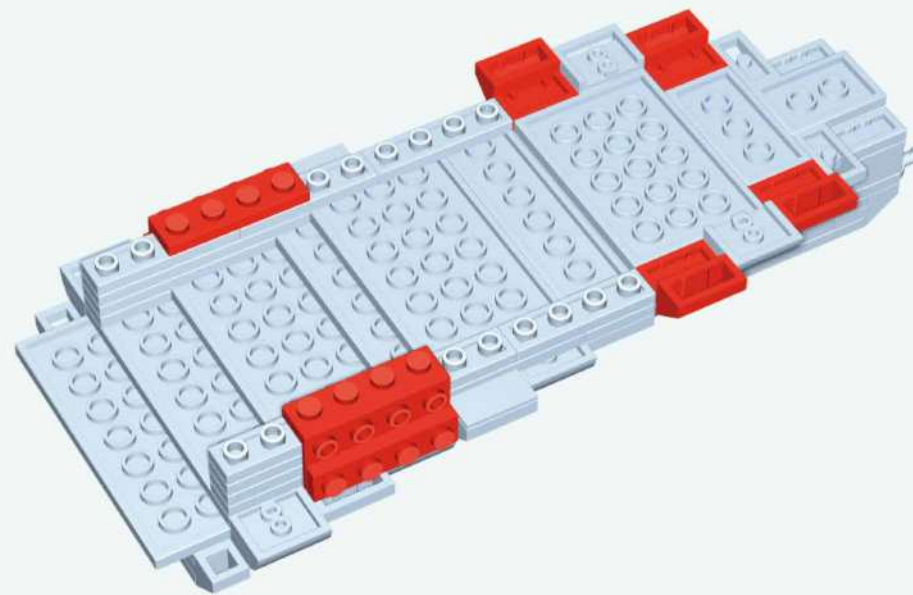
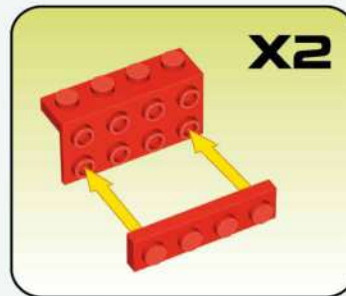

166

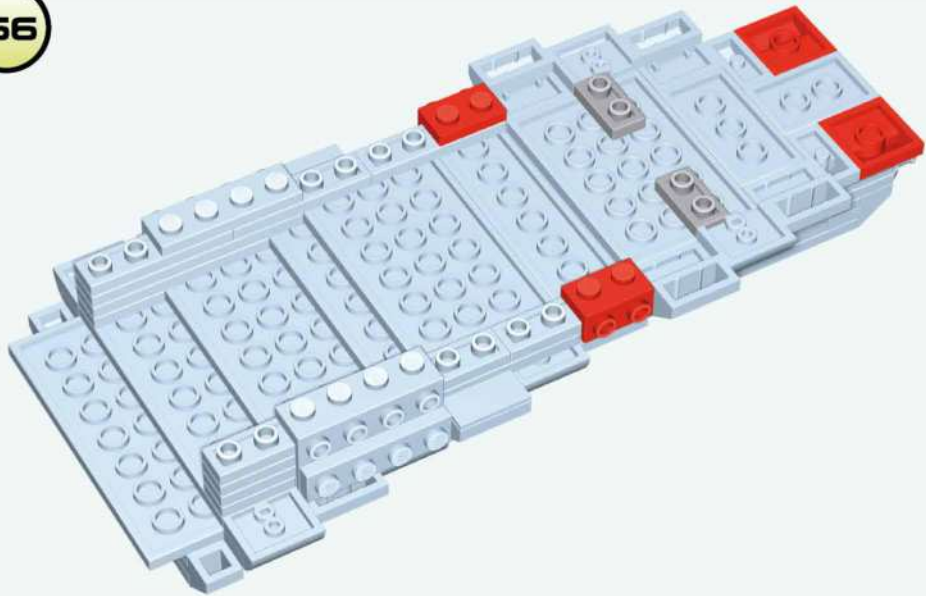

x2



x2

5



x2

167

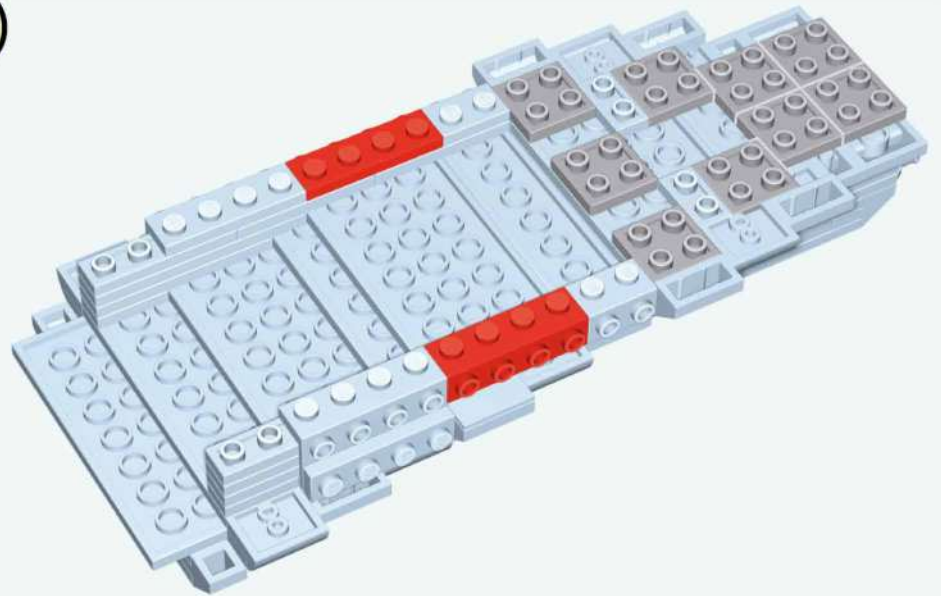

x2



x9

168

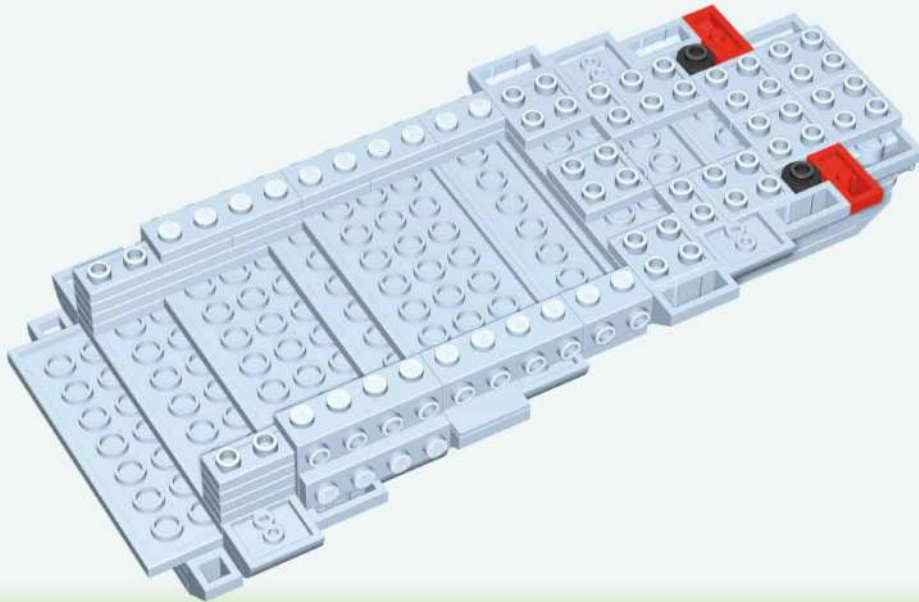

x2



x2

169

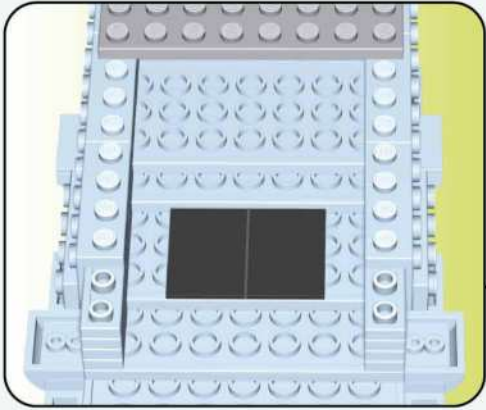
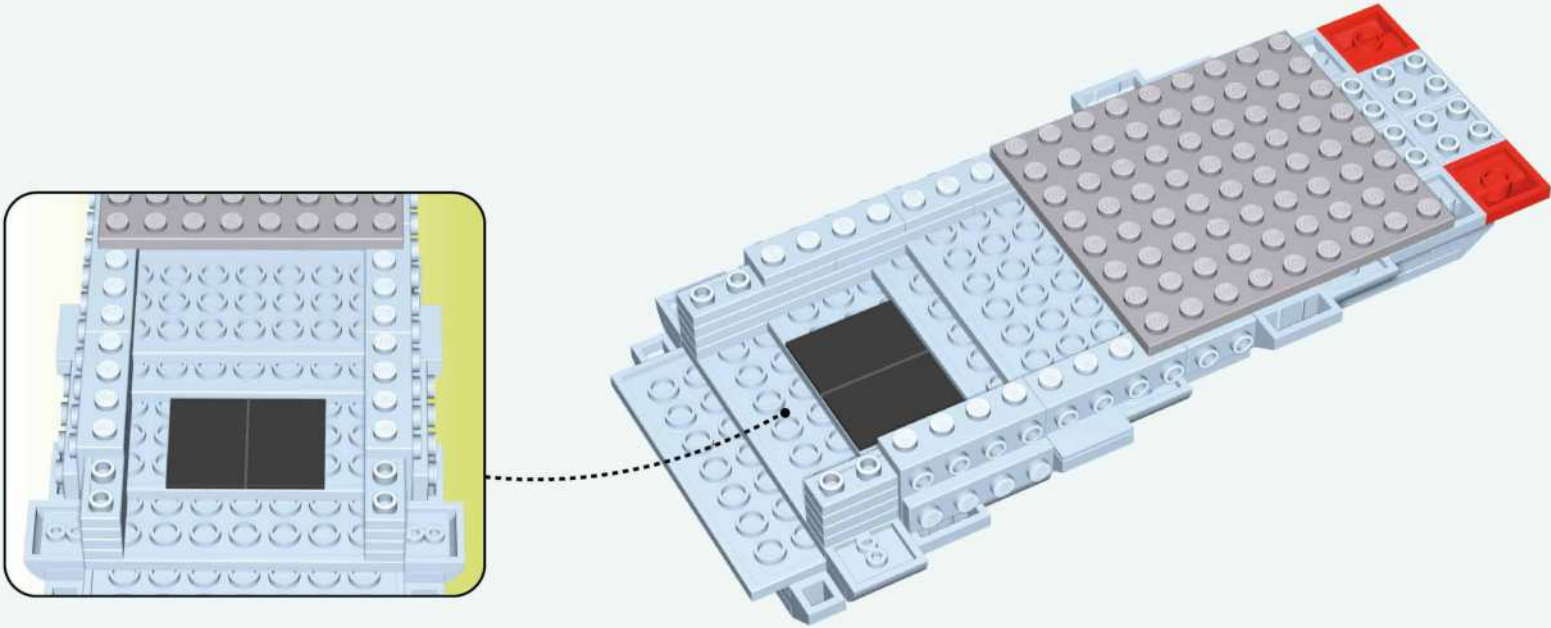

x2



x1



x2

170

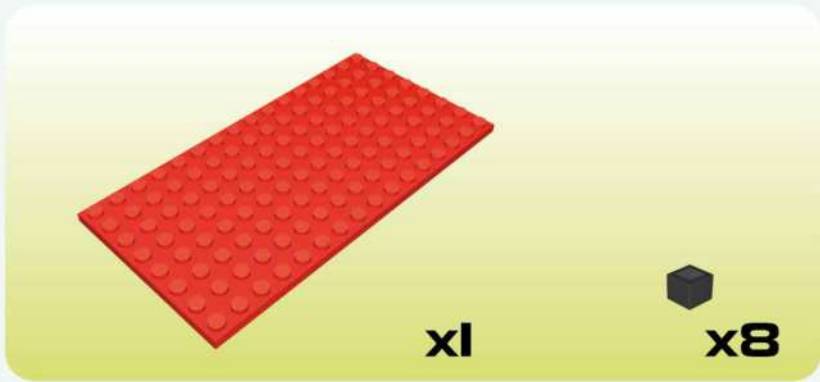
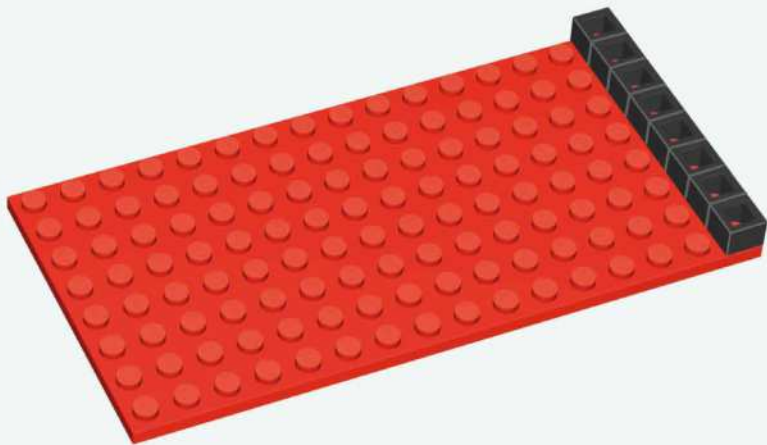

x1



x8

171

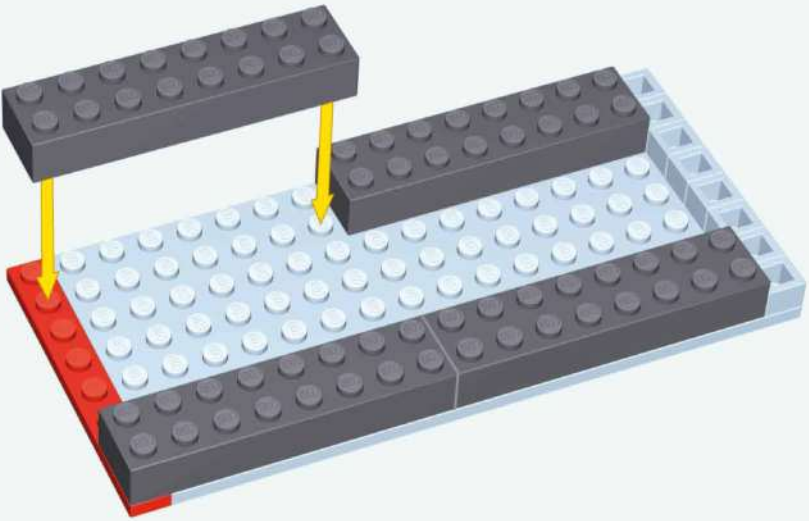

172

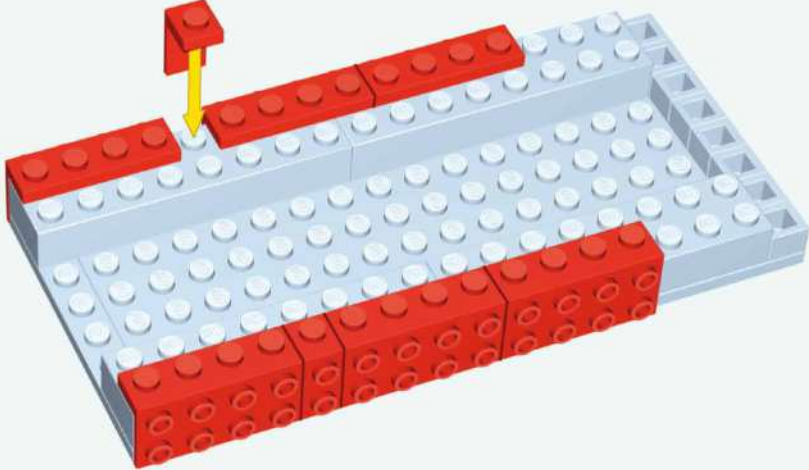

173

