

HISTORICAL COLLECTION

WORLD WAR II

EXECUTIVE EDITION

PENNSYLVANIA-CLASS BATTLESHIP
USS ARIZONA (BB-39)
USS PENNSYLVANIA (BB-38)

PLACE OF ORIGIN - UNITED STATES
 TYPE - PENNSYLVANIA-CLASS BATTLESHIP
 LAUNCHED - (BB-39) 19 JUNE 1915,
 (BB-38) 12 MARCH 1915
 COMMISSIONED - (BB-39) 17 OCTOBER 1916,
 (BB-39) 12 JUNE 1916
 FATE - (BB-39) SUNK, PEARL HARBOR, 7 DECEMBER 1941
 (BB-38) SCUTTLED, KWAJALEIN ATOLL 10 FEBRUARY 1948
 DISPLACEMENT - 35381t (78,001,759Lb)
 LENGTH - 185,3m (608')
 BEAM - 29,6m (97')
 INSTALLED POWER - 12 BABCOCK & WILCOX BOILERS
 34000shp (25000kw)
 PROPULSION - 4 SHAFTS, 4 STEAM TURBINES
 SPEED - 21knots (39km/h, 24mph)
 RANGE - 7775nmi (14400km, 8950mi)
 ARMAMENT - 4x TRIPLE 356mm (14") GUNS
 20x 127mm (5") GUNS
 8x 12,7mm (.50") AA MG
 AIRCRAFT CARRIED - 3x FLOATPLANES
 AVIATION DEVICES - 2x CATAPULTS
 CREW - ~1050 MEN



4842

PAD PRINTED
NO STICKERS

Printed in EU



WARNING: CHOKING HAZARD-
 Toy contains small parts.
 Not for children under 3 years.

2088

PENNSYLVANIA-CLASS BATTLESHIP

SCALE 1:300



+



+



BE CAREFUL: NOTICE THE DIFFERENCE

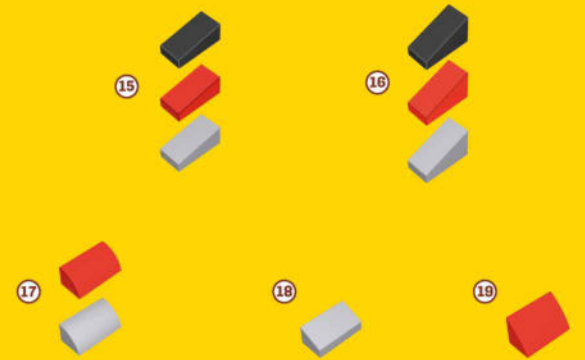
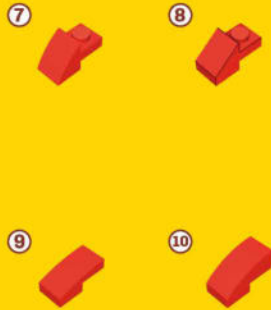
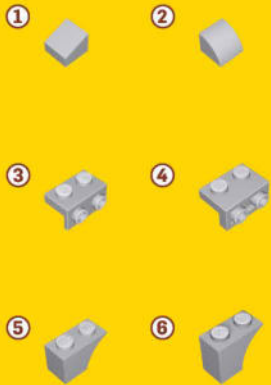

UWAGA: RÓŻNE KLOCKI



1

1

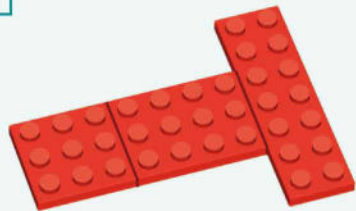

x1



x1



x1

2

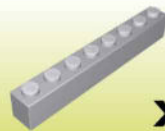
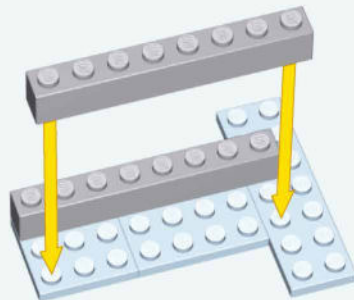

x2

3

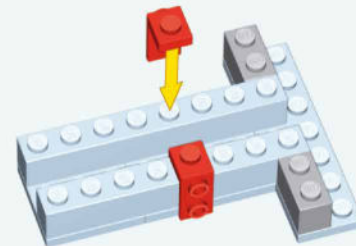

x2



x2

4

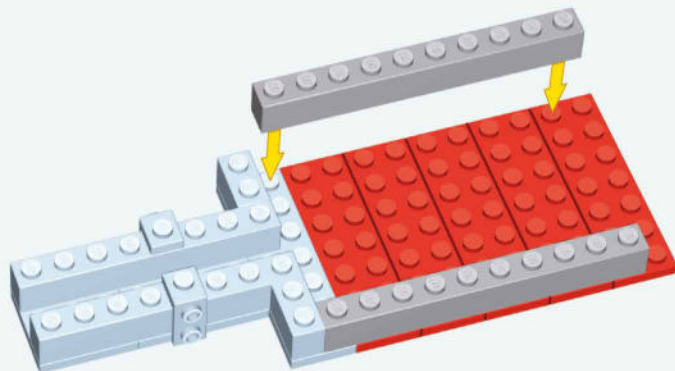

x5

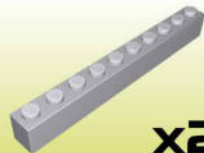

x2

5

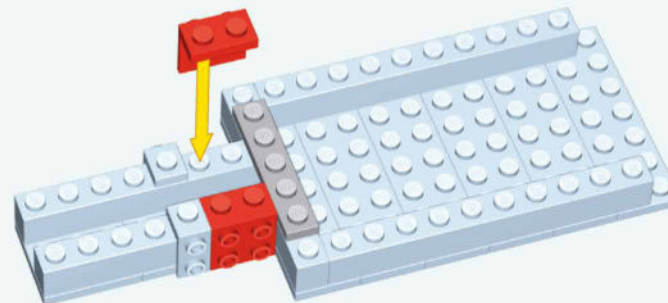



x2



x1

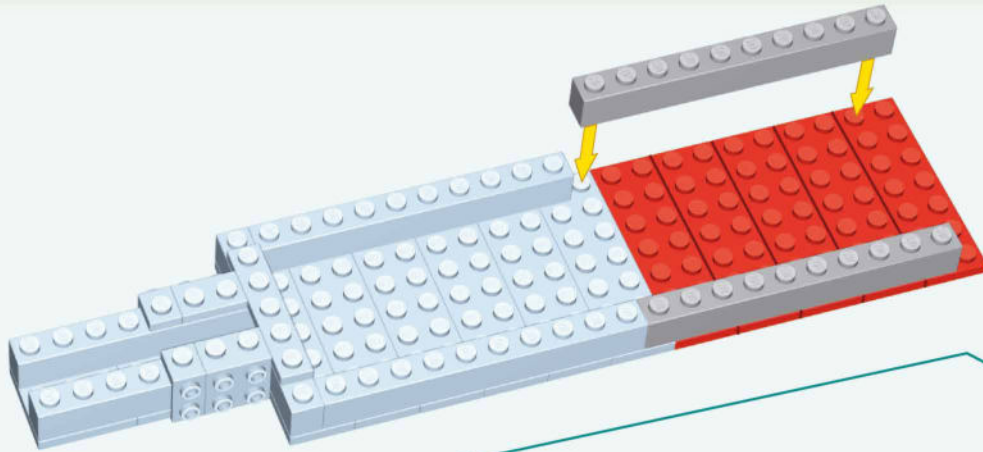

6

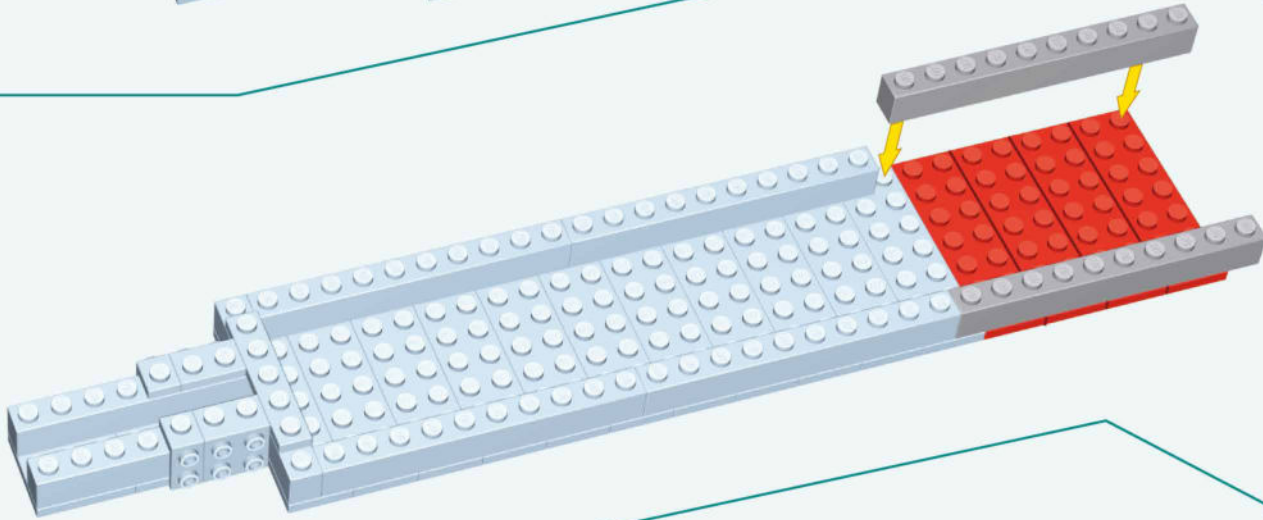

 x5
 x2

7



 x4
 x2

8

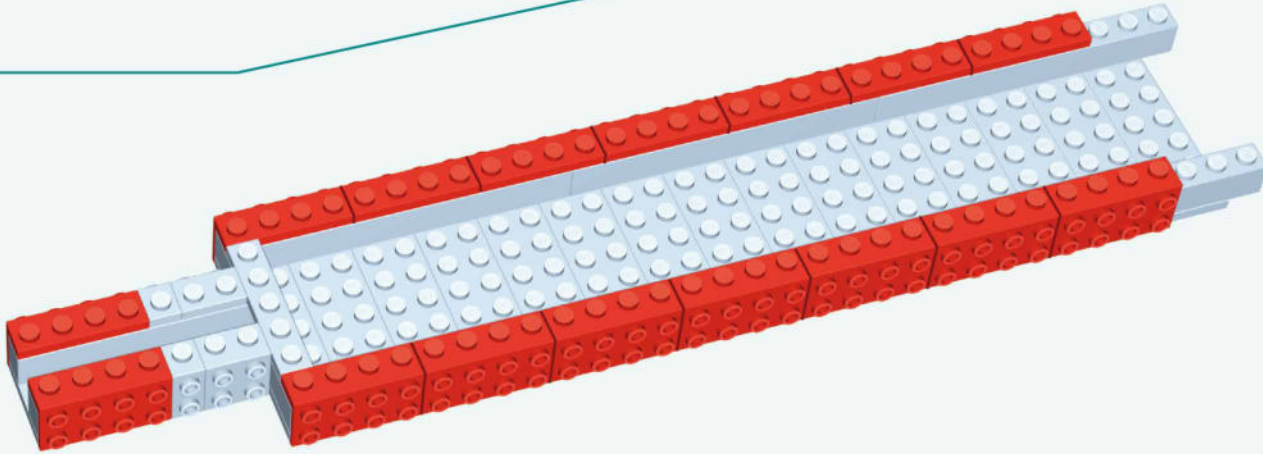

 x16

9

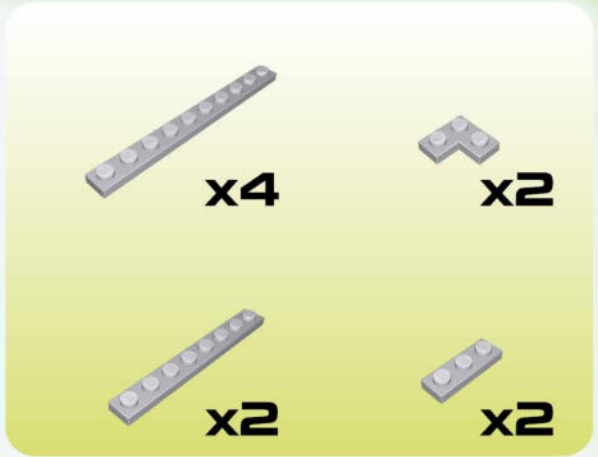
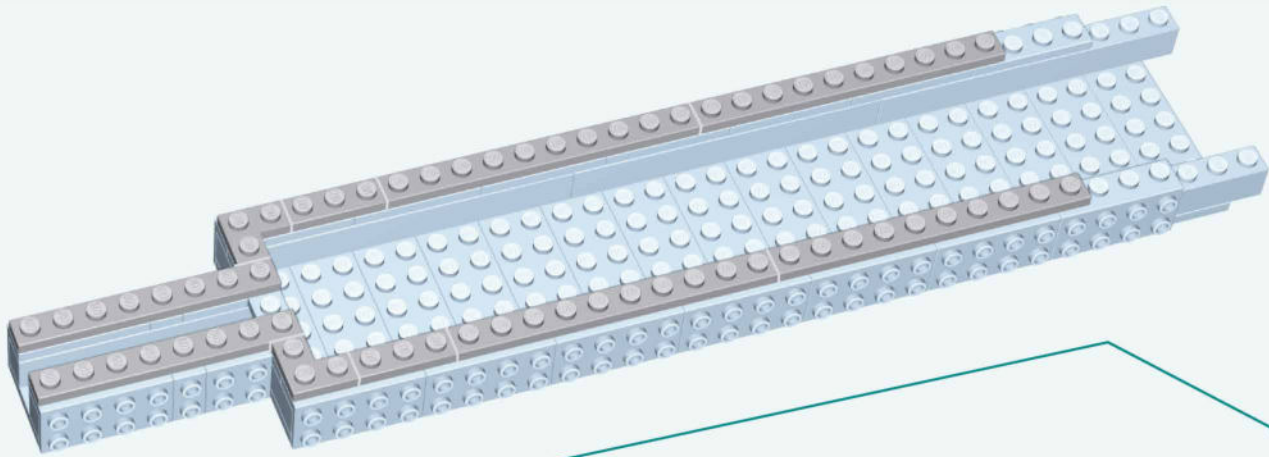

10

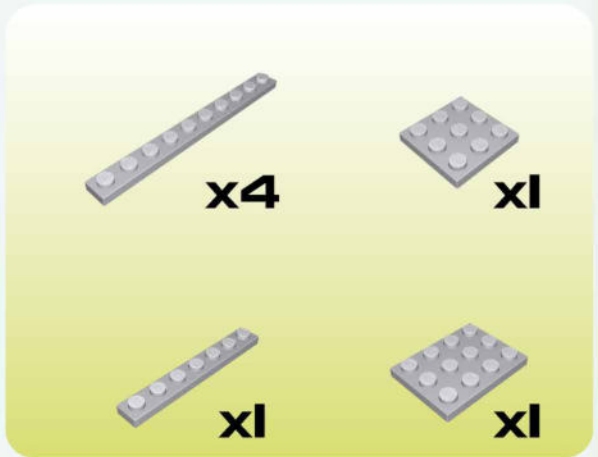
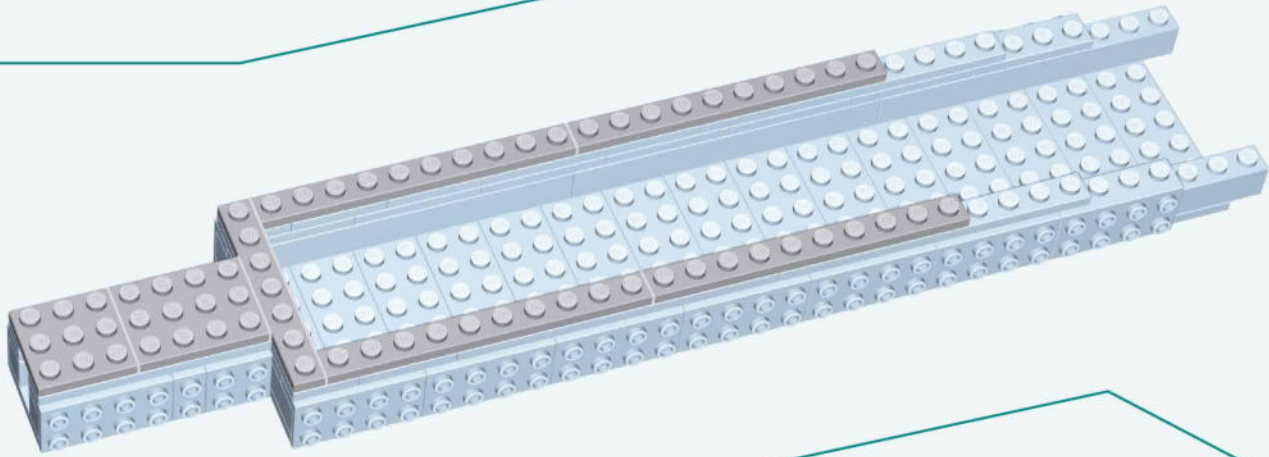

11

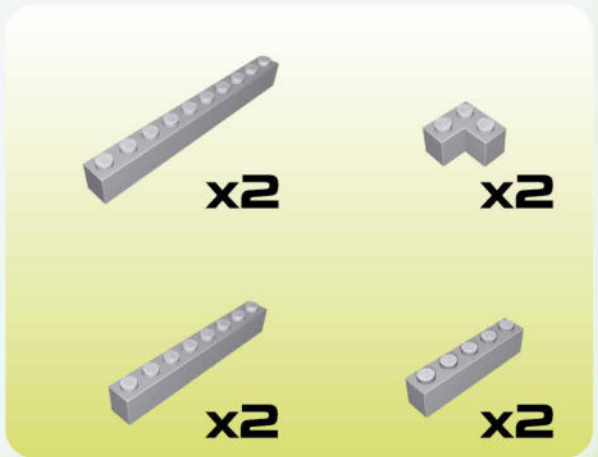
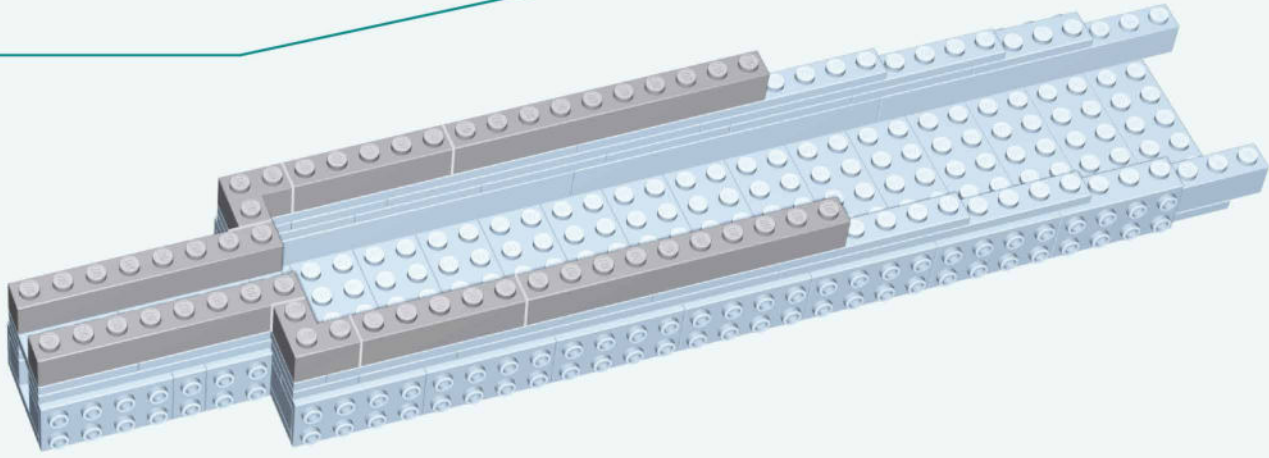

12

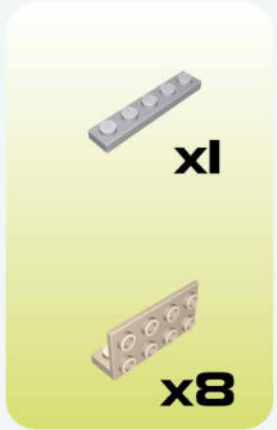
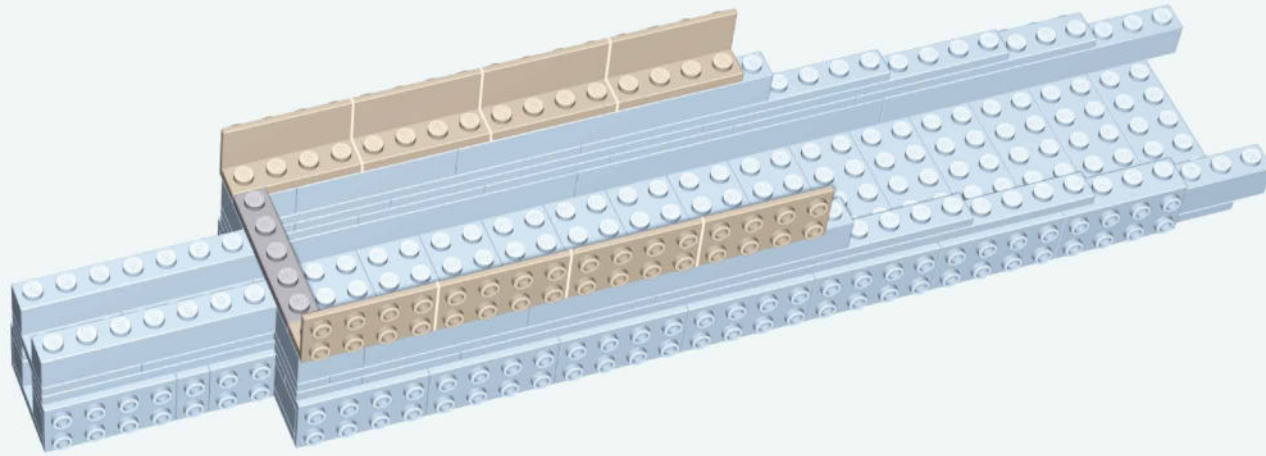

13

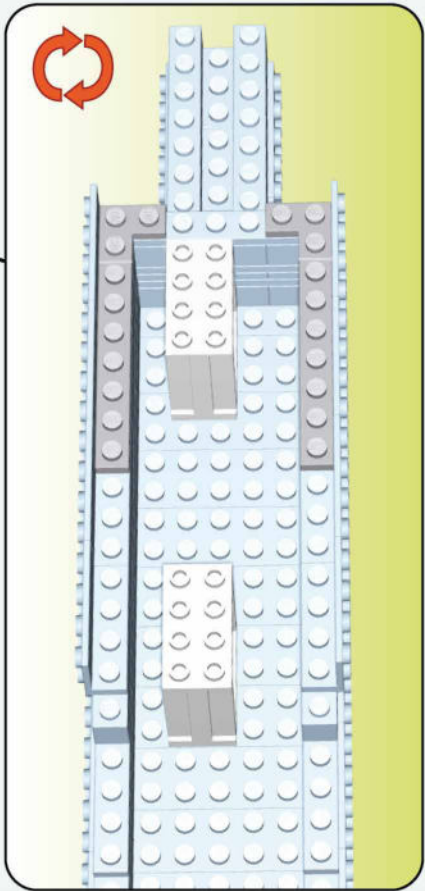
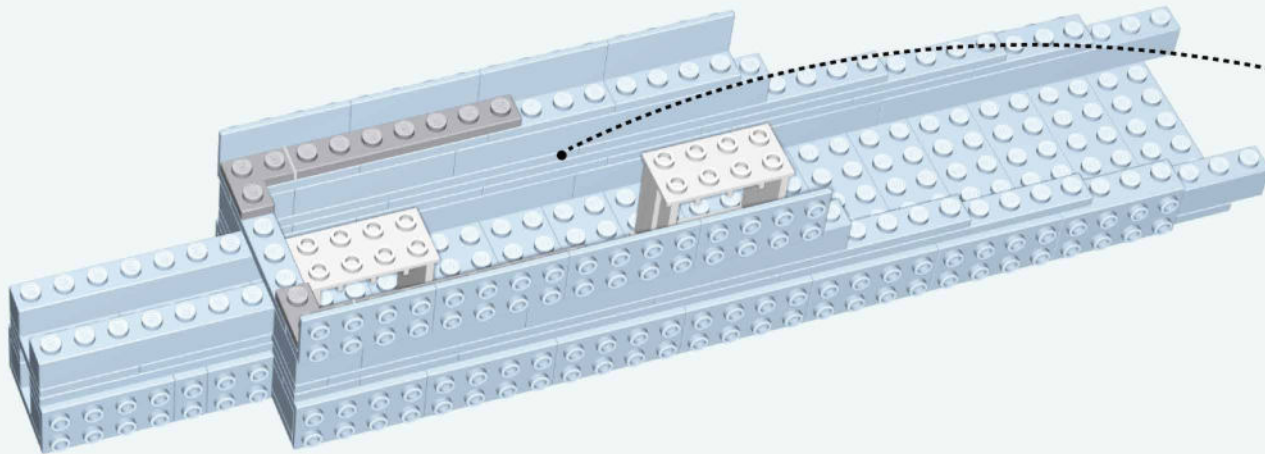

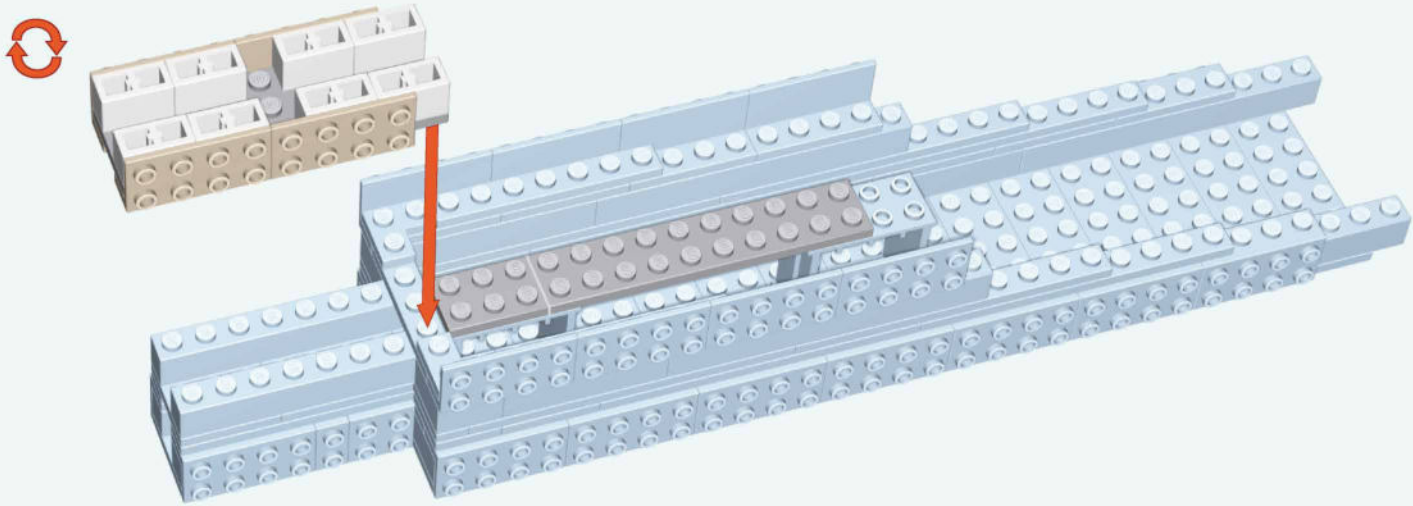
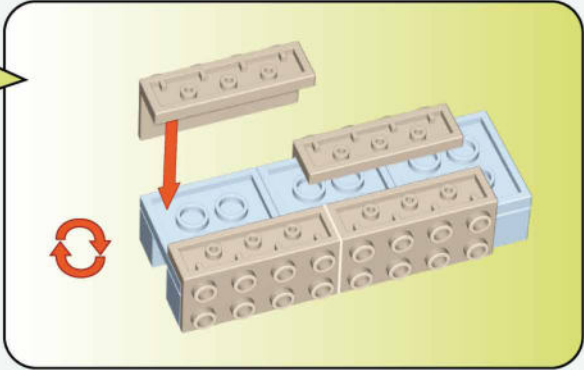
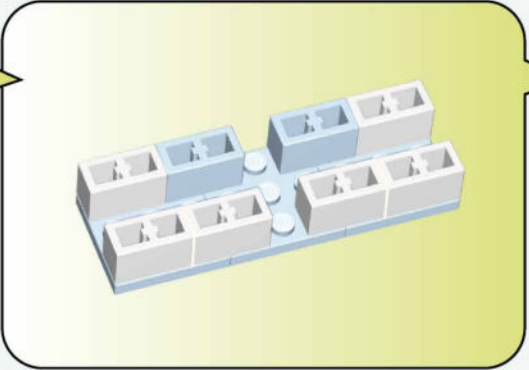
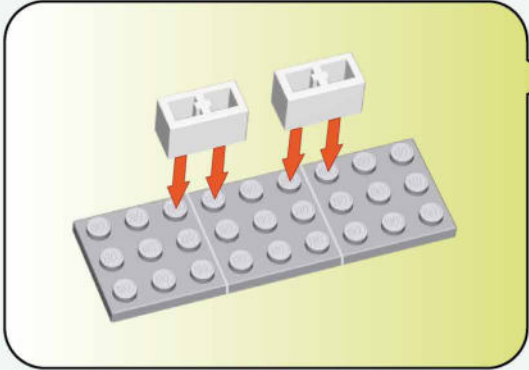

x3



x8



x4



x1

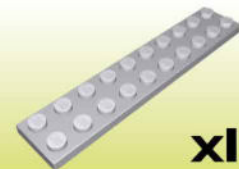

x1

15

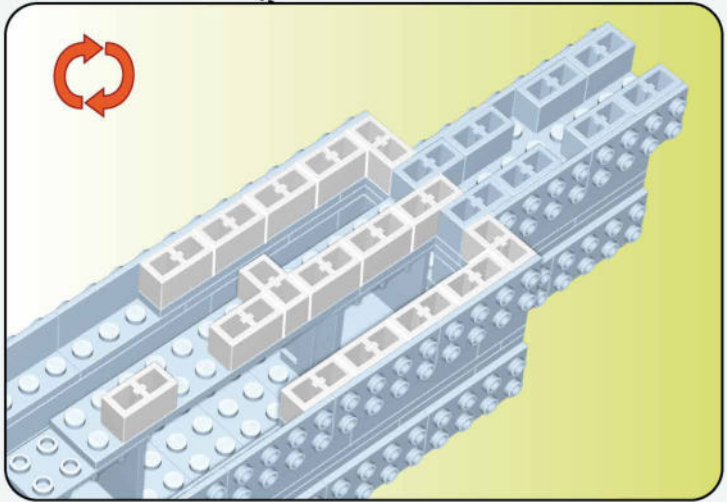
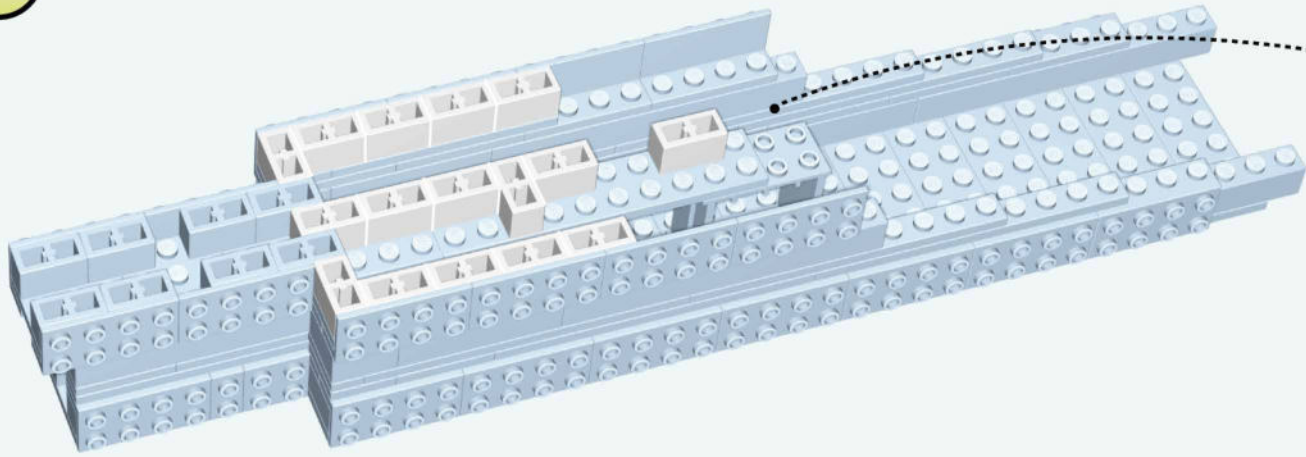

16

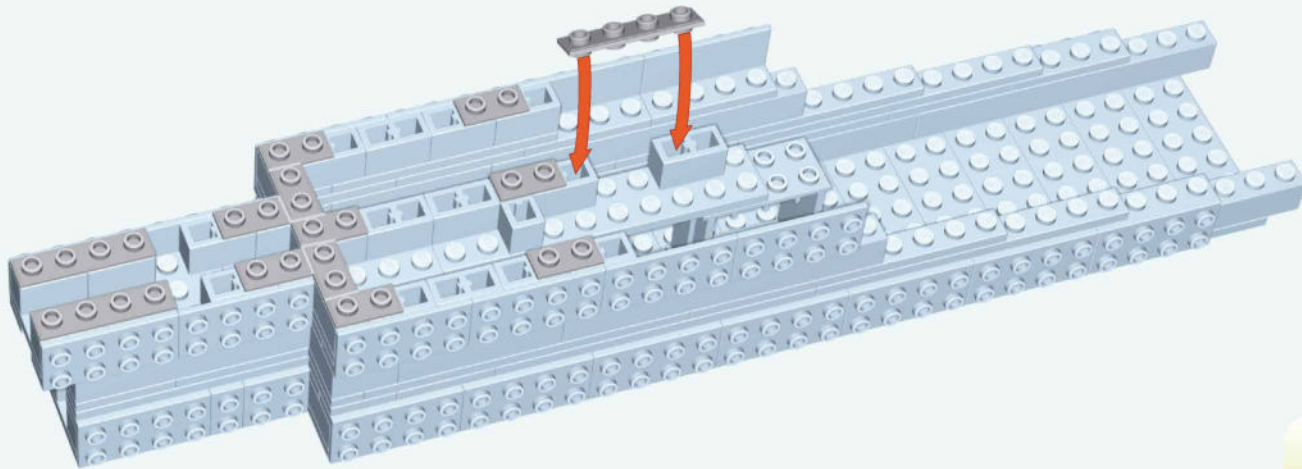

17

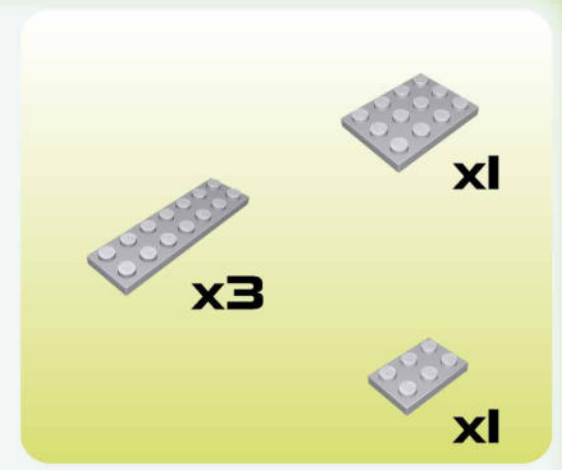
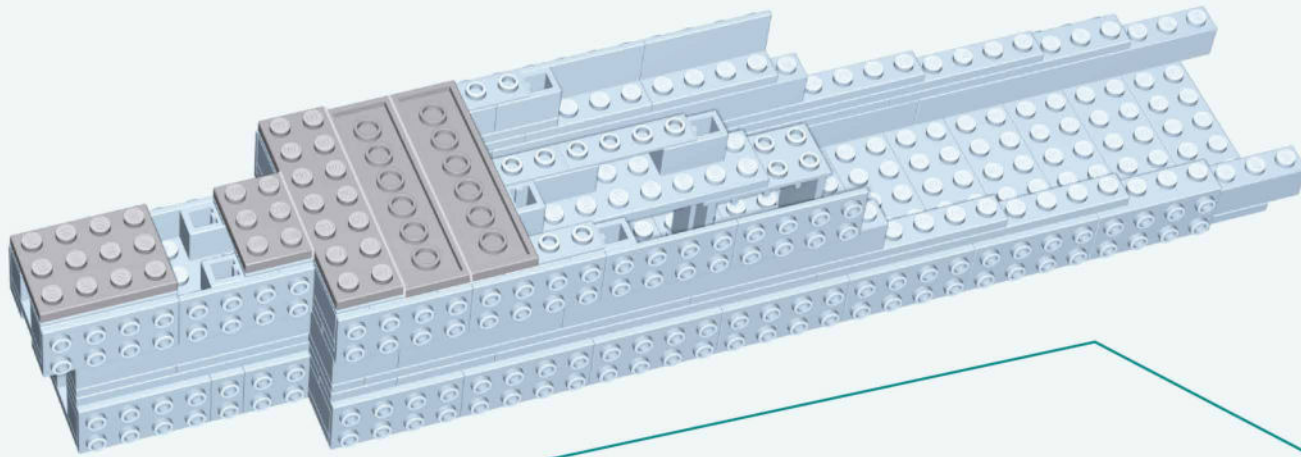

18

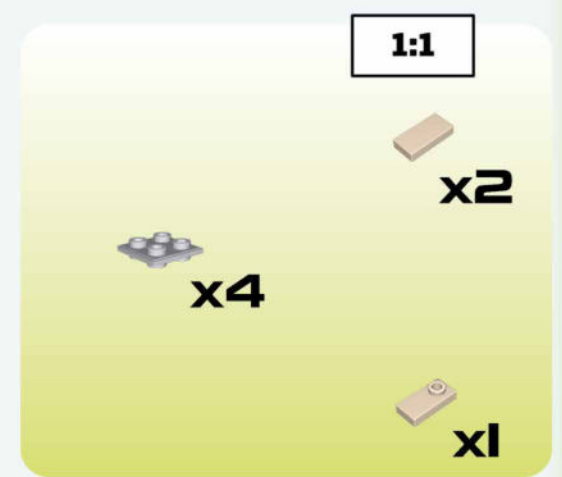
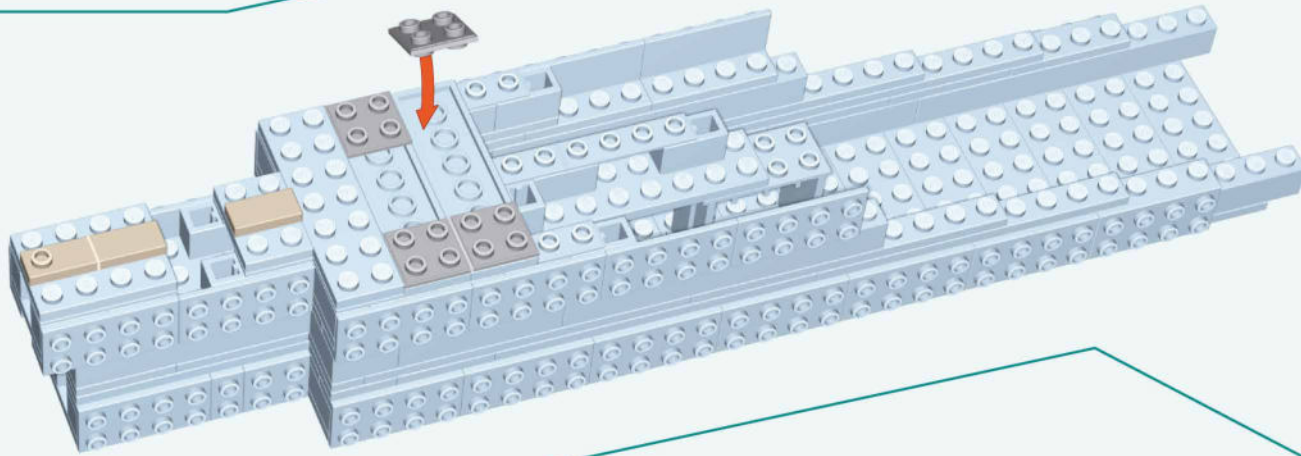

19

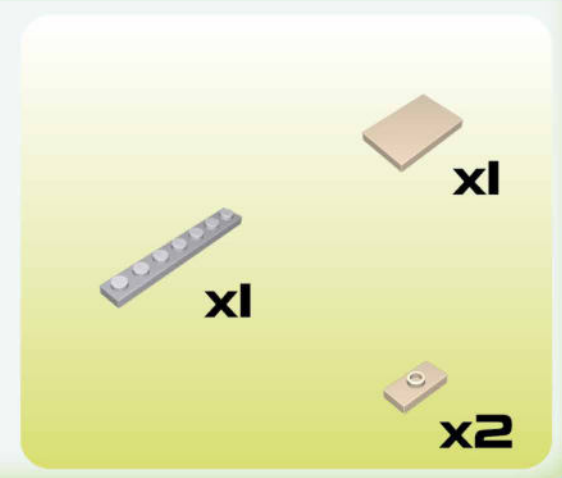
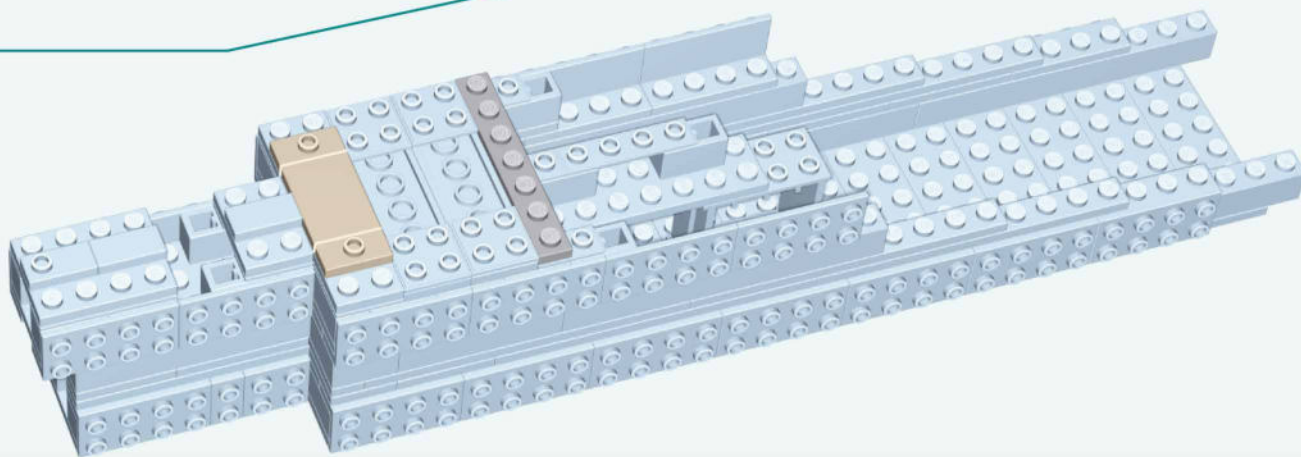

20

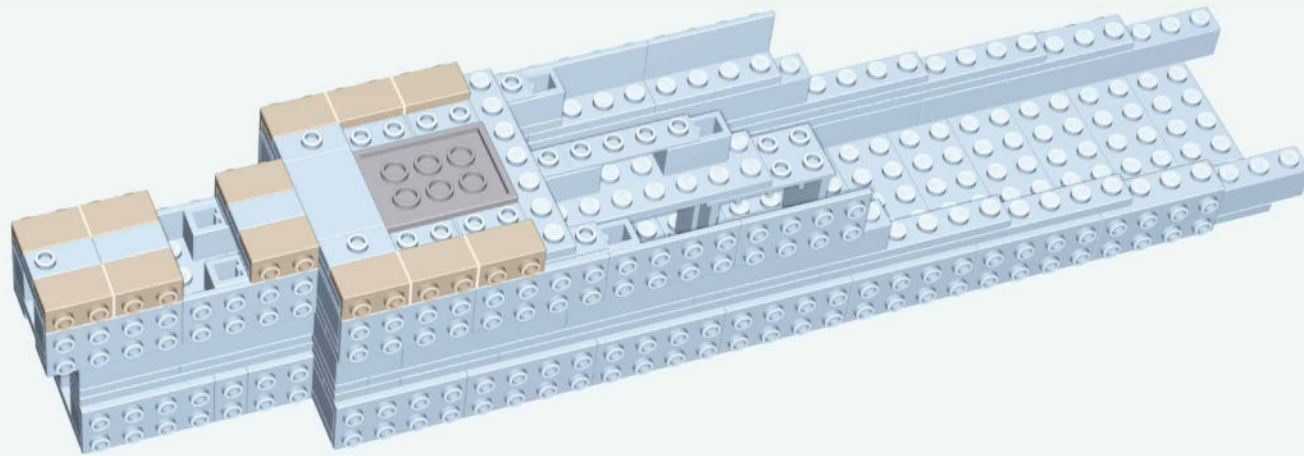

x12



x1

21

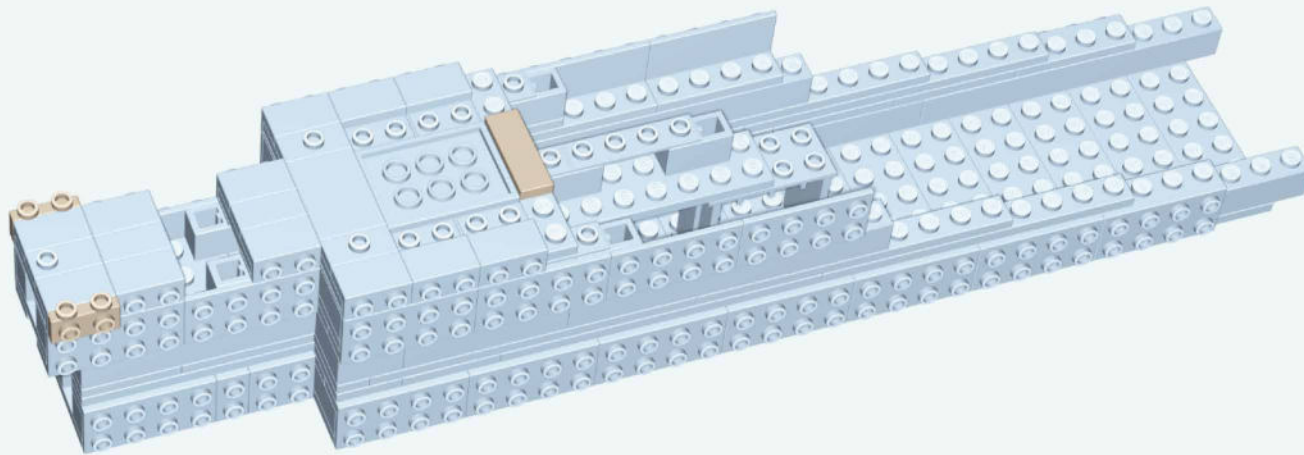

1:1



x1



x2

22

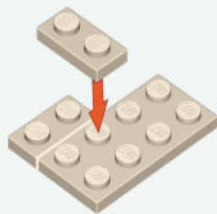

x1



x2

23

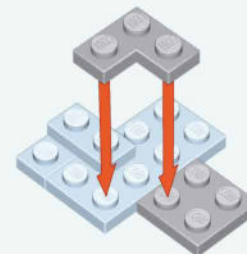

x1



x1

24

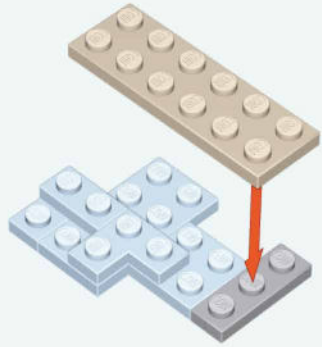

25

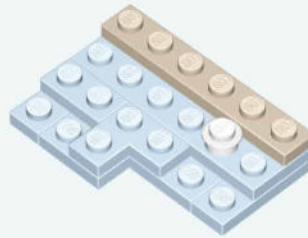

26

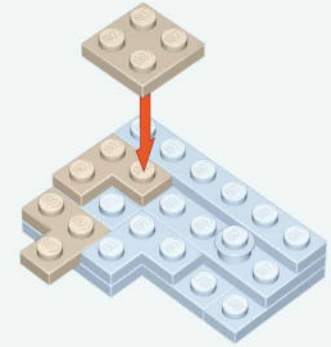

27

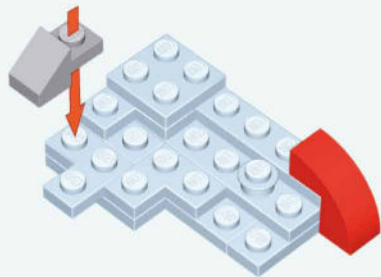

28

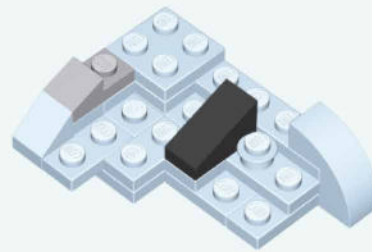

29

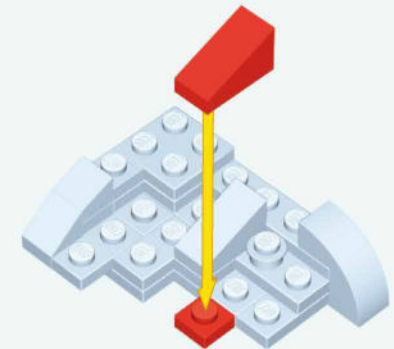

30

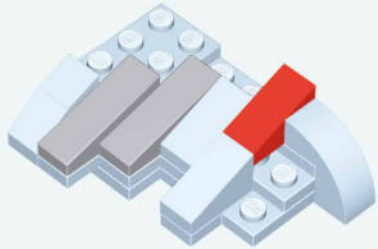

31

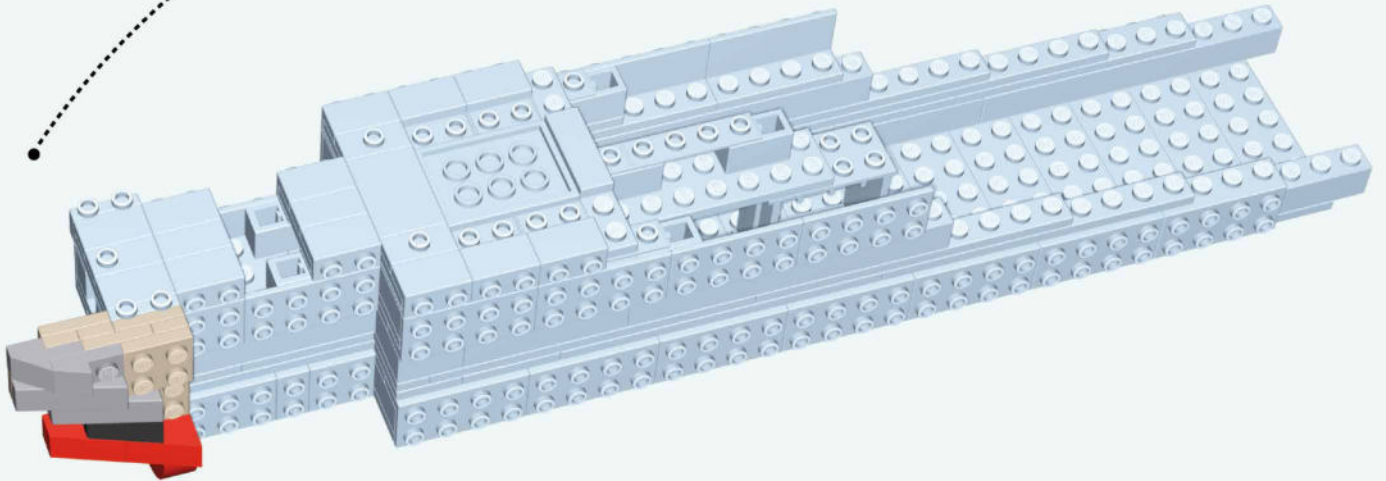
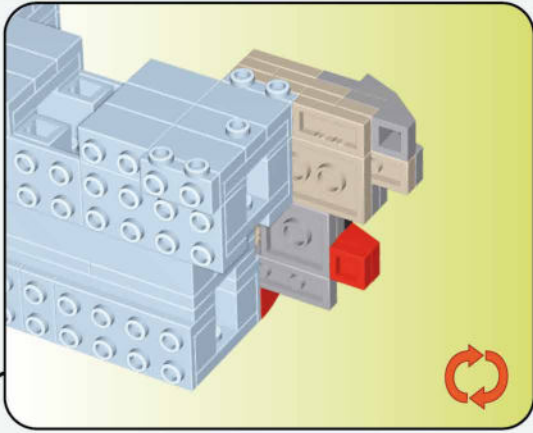

32

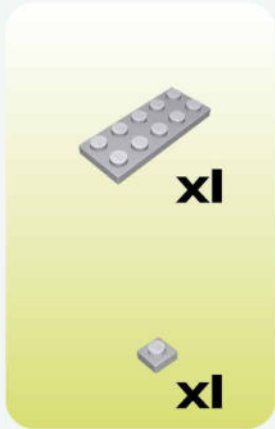
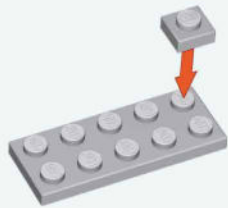

33

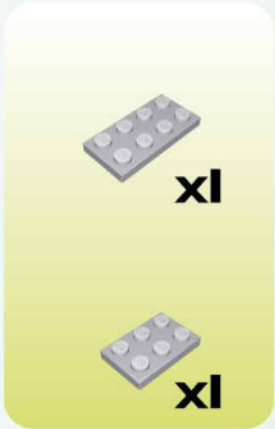

34

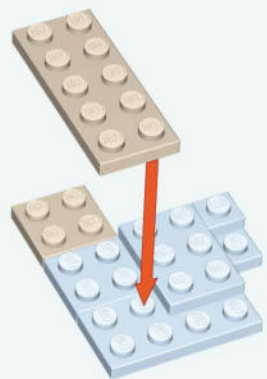

x1



x1

35



x1



x1

36

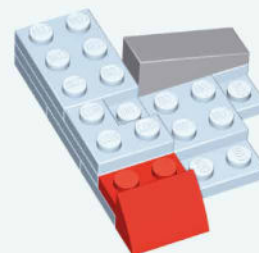

11



x1



x1

37

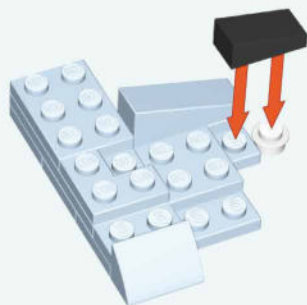

x1

15



x1

38

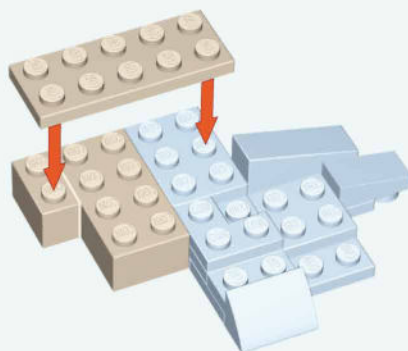

x1



x1



x1

39

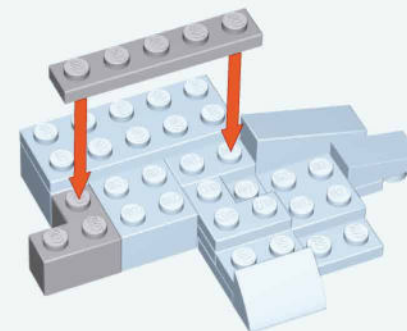

x1



x1

40

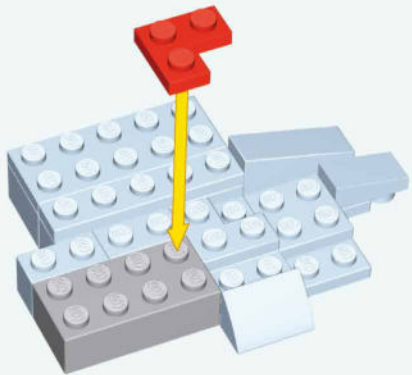

x1



x1

41

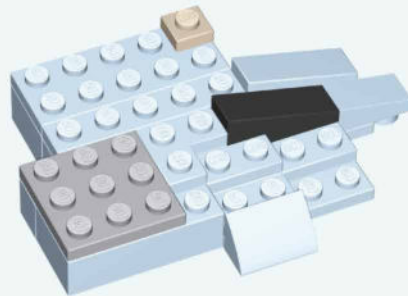

x1



x1

14



x1

42

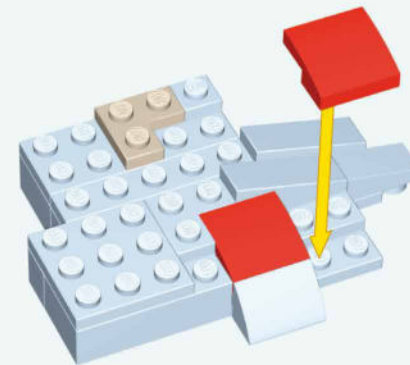

x1



x2

43

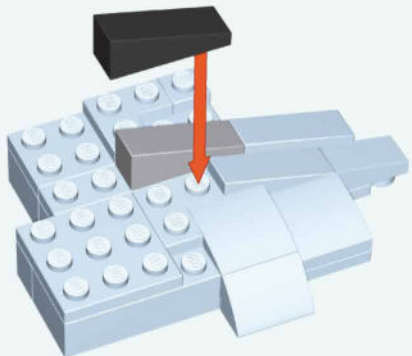

x1

14



x1

44

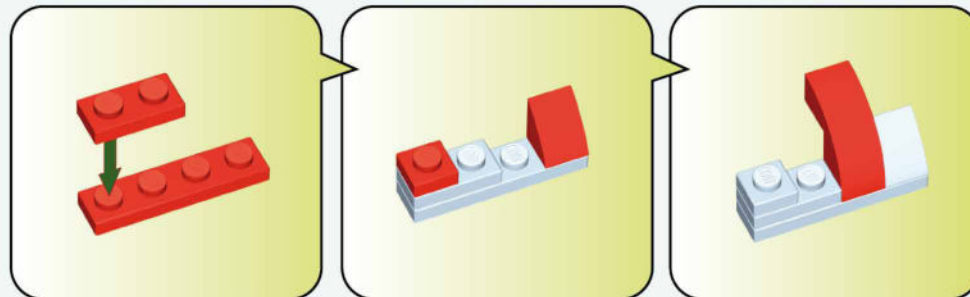

x1



x1



x1



x1



x1

45

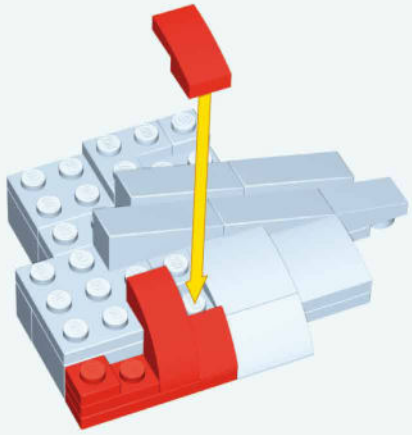

46

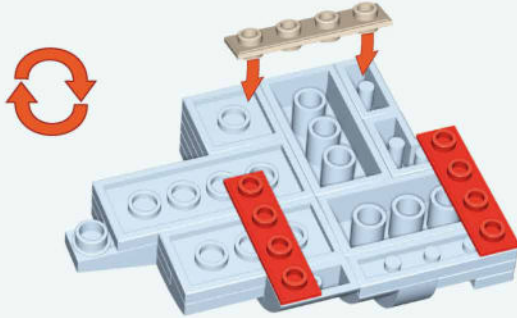

47

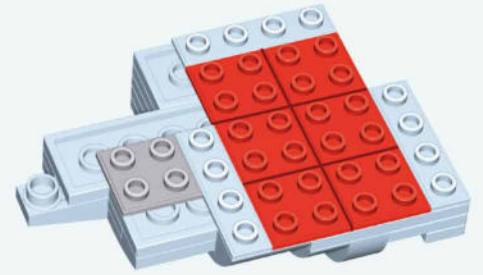

48



49

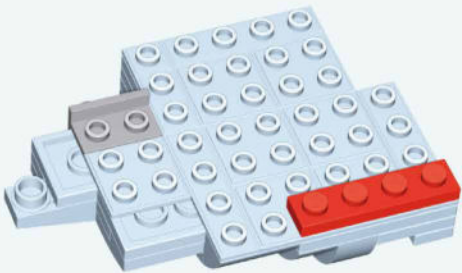

50

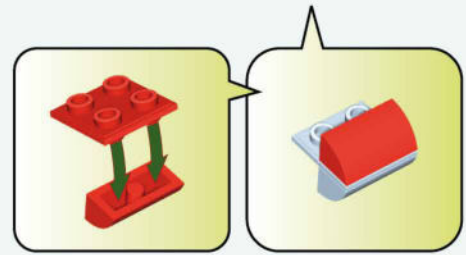

51

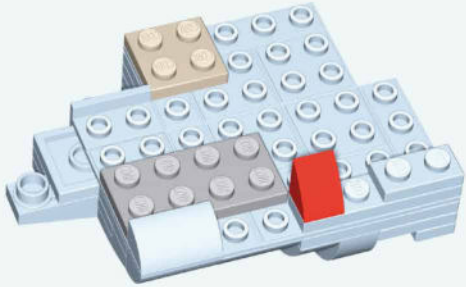

x1



x1



x1

52



x1



x1

15



x1

53

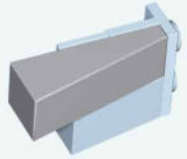

x1

54



x1

55

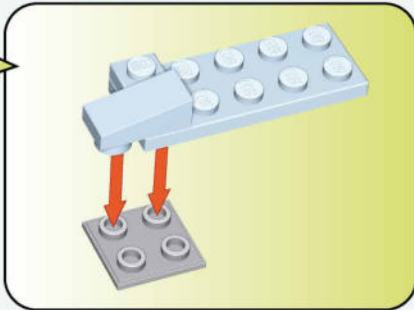
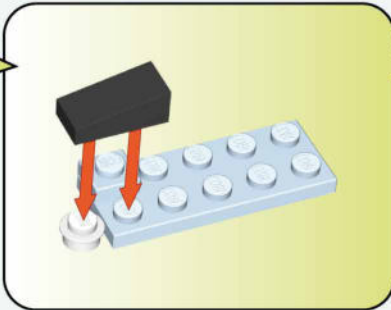
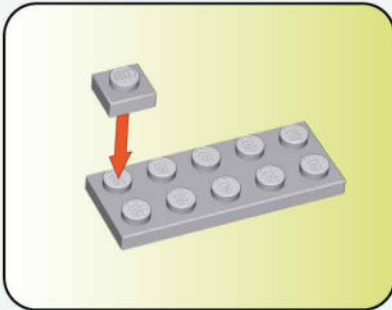

x1



x1



x1

15



x1



x1

56

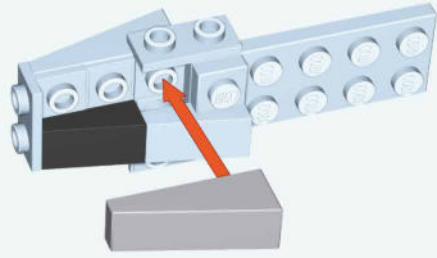

57

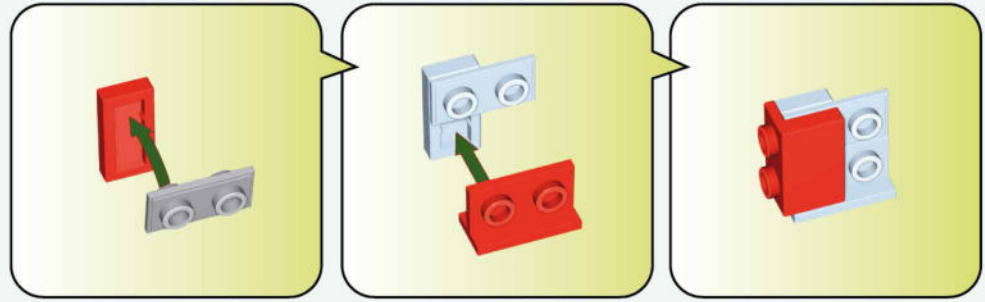

58

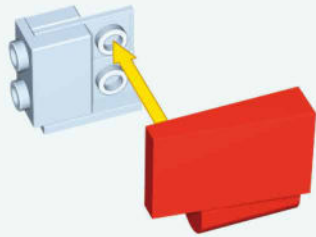
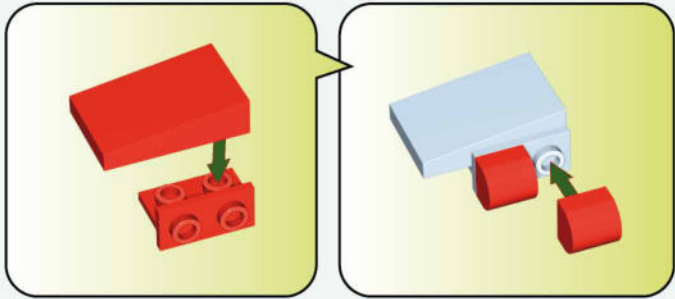

59

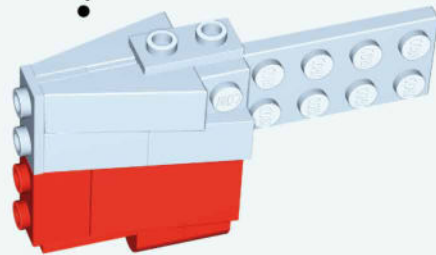
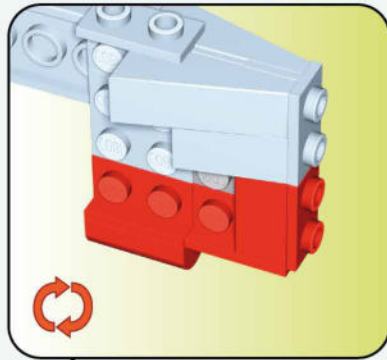

60

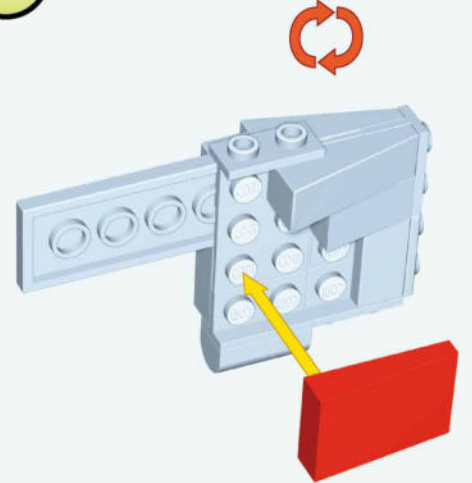

61

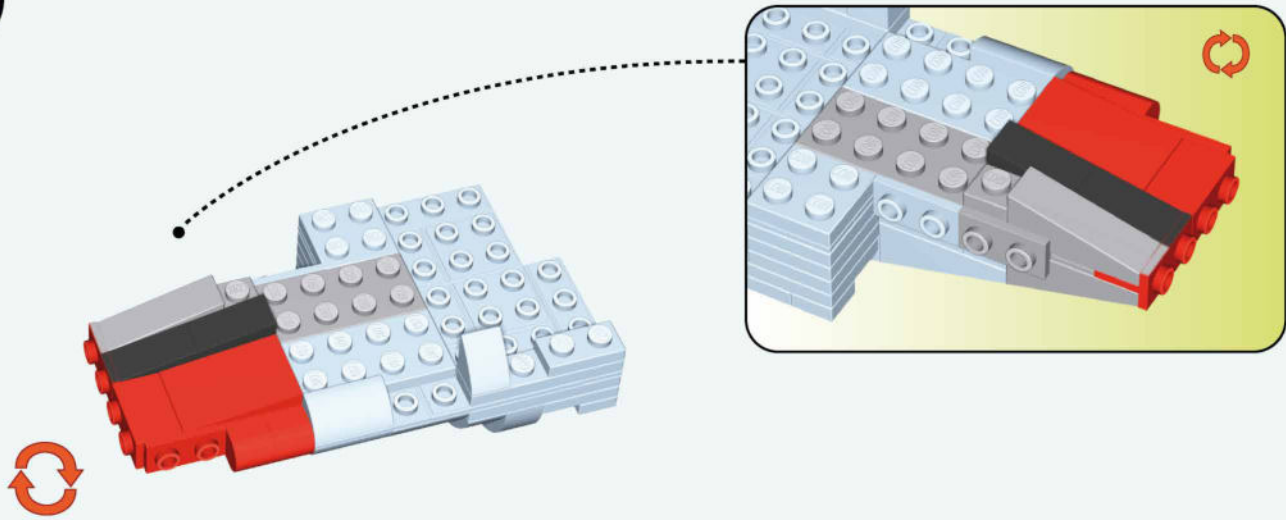

62



63

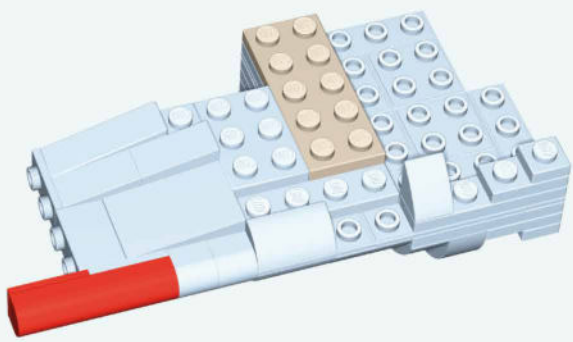
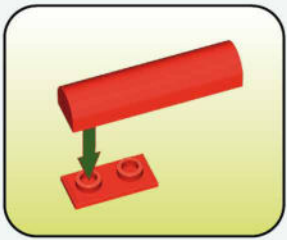

64

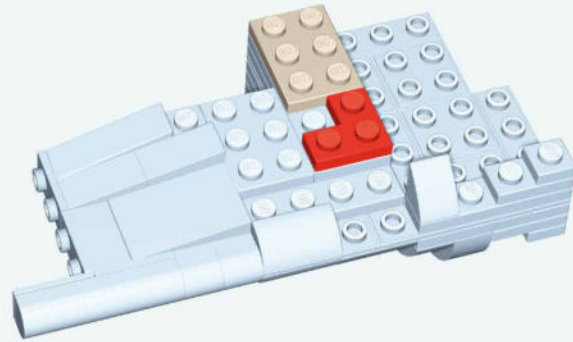

65

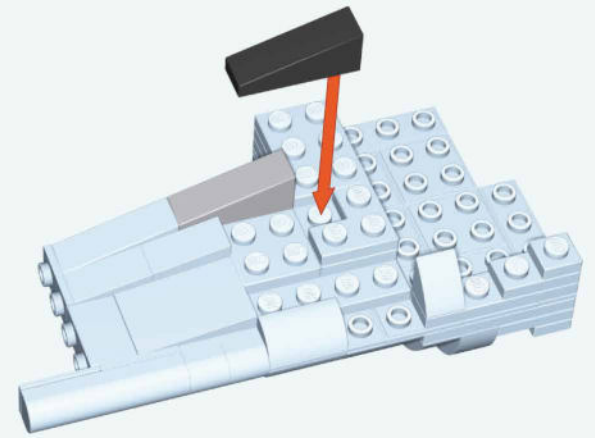

66



x1



x1

67



x1



x1

68



x1



x1

69

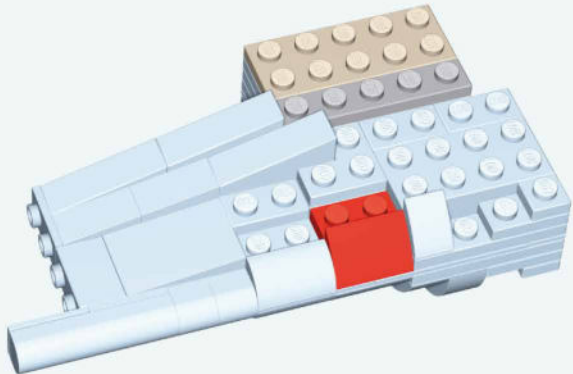

x1



x1

Ⓜ



x1

70

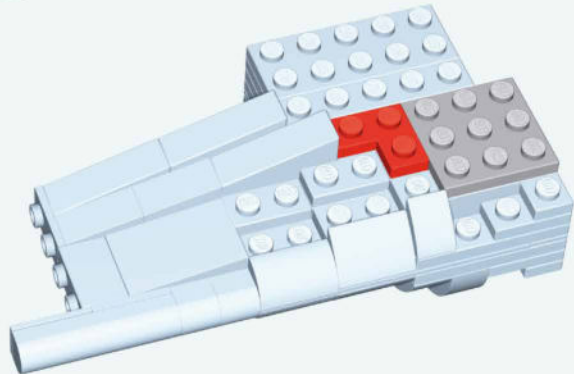

x1



x1

71

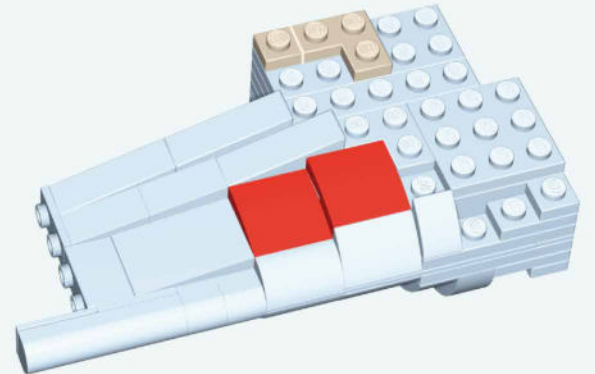

x1



x1



x2

72

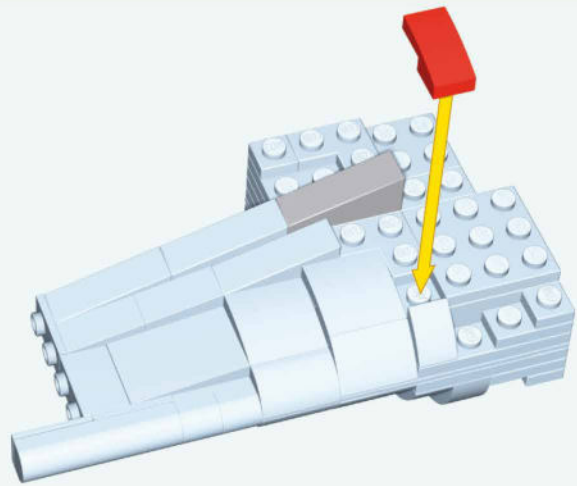

73

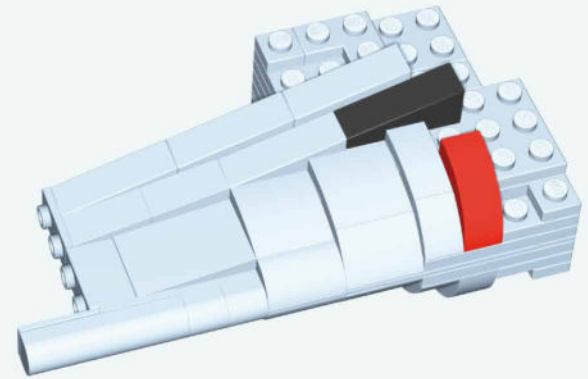

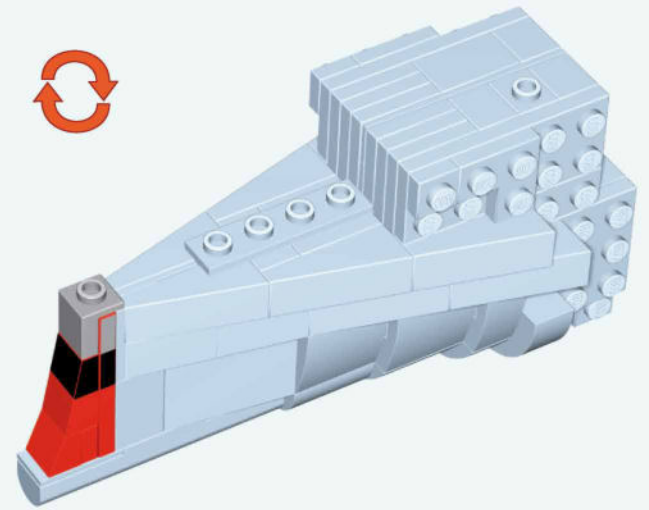
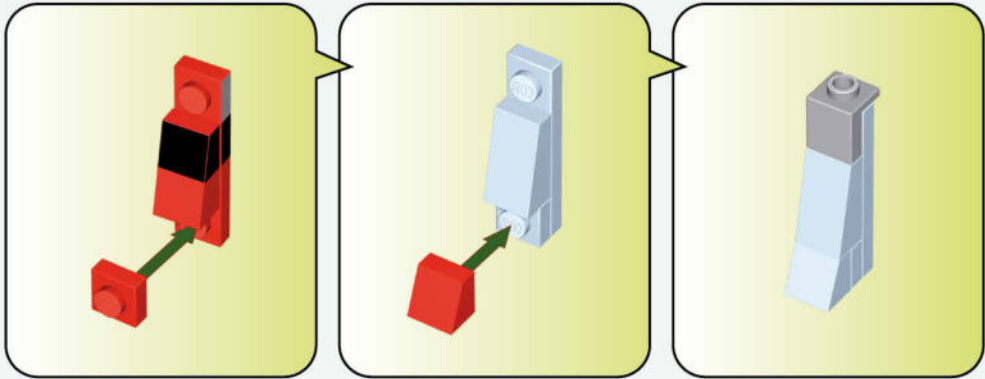

74

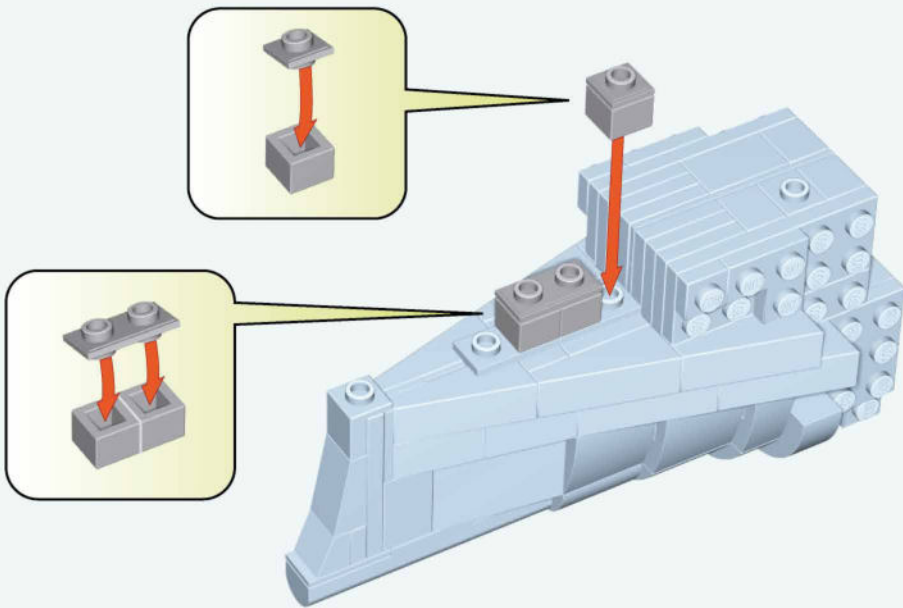

75



-  x3
-  x1
-  x1

76

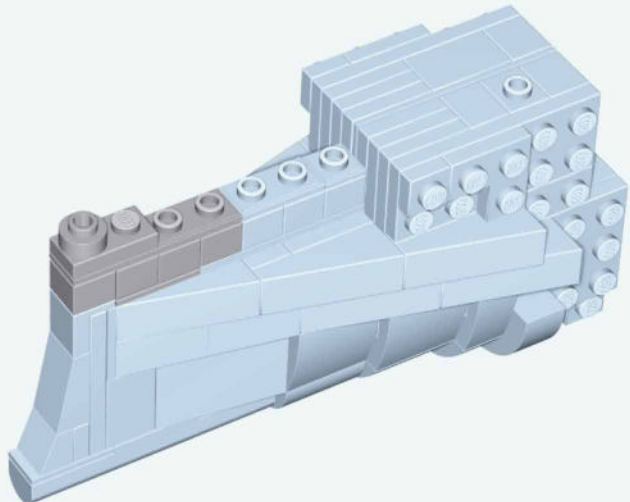
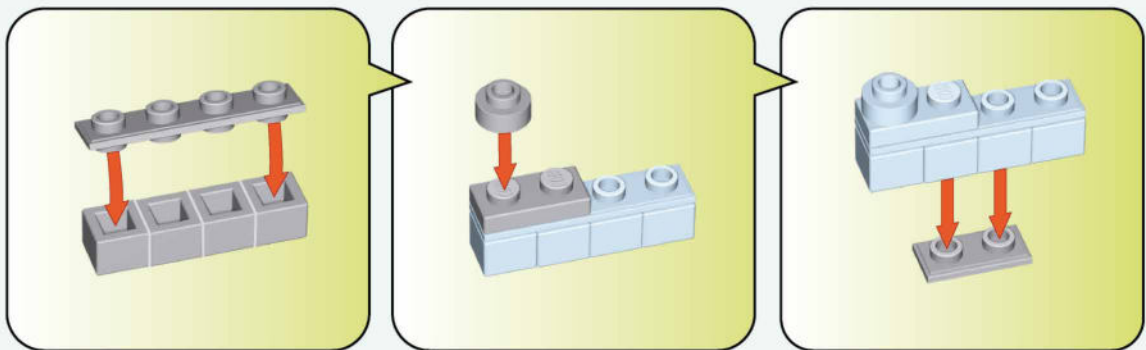

-  x4
-  x1
-  x1
-  x1
-  x1

77

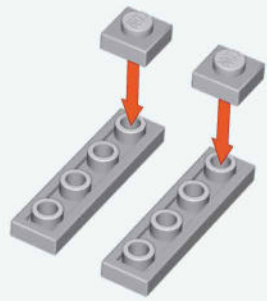

x2



x2

78

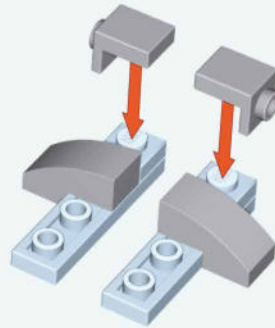

x2



x2

79

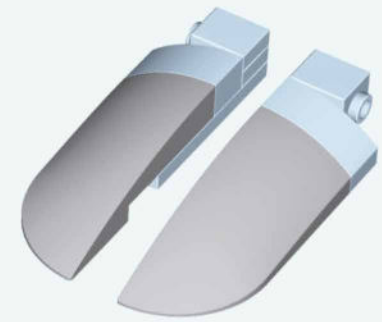

x1



x1

80

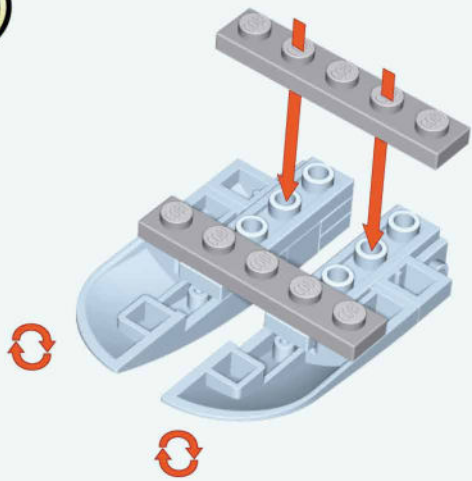

x2

81

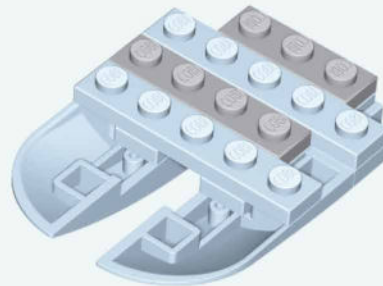

x1



x1

82

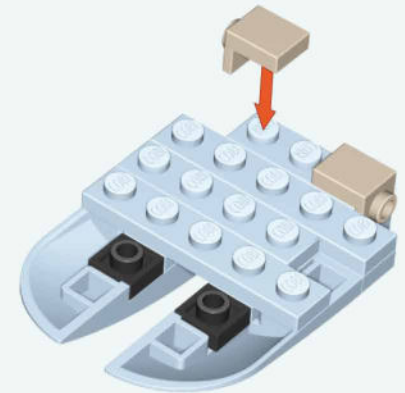

x2



x2

83

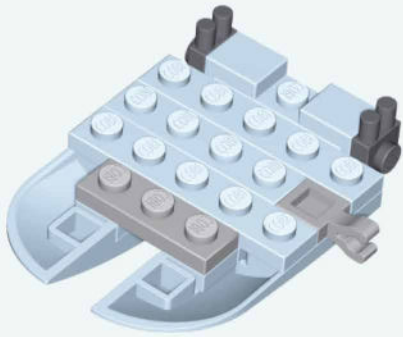

84

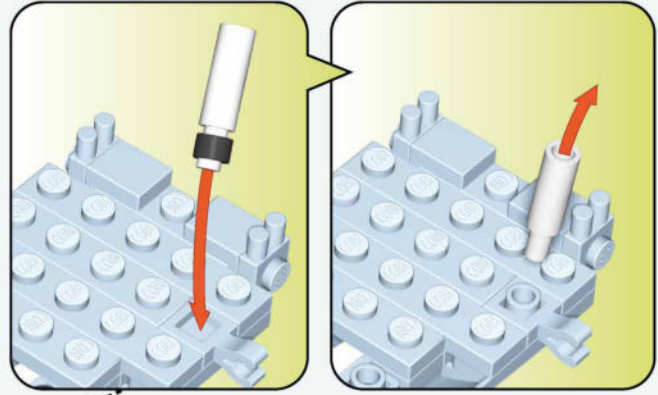
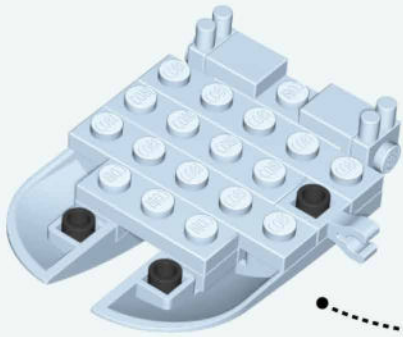

85

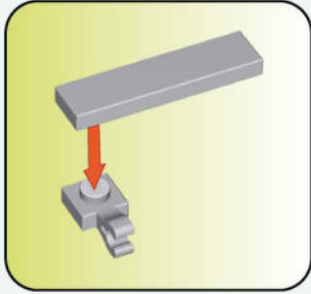
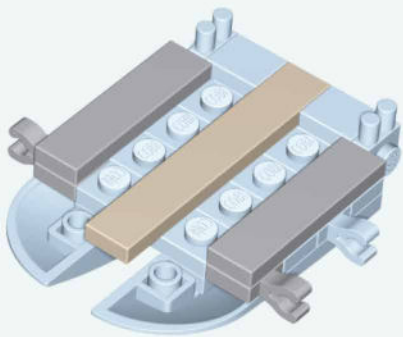
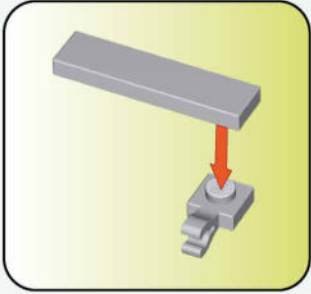

1:1

1:1



86

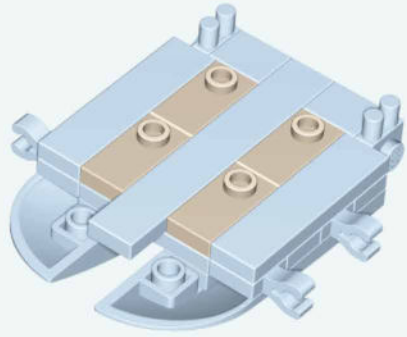

87

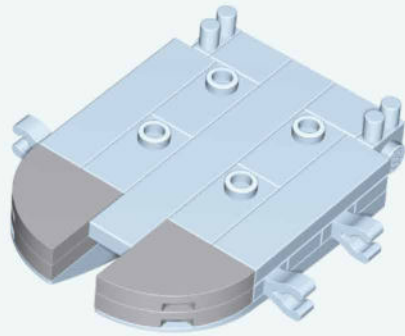
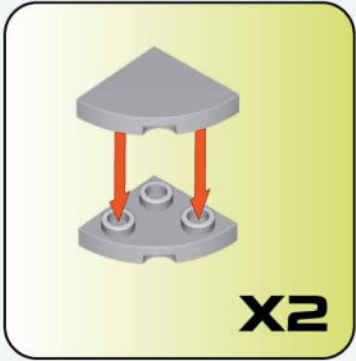

88

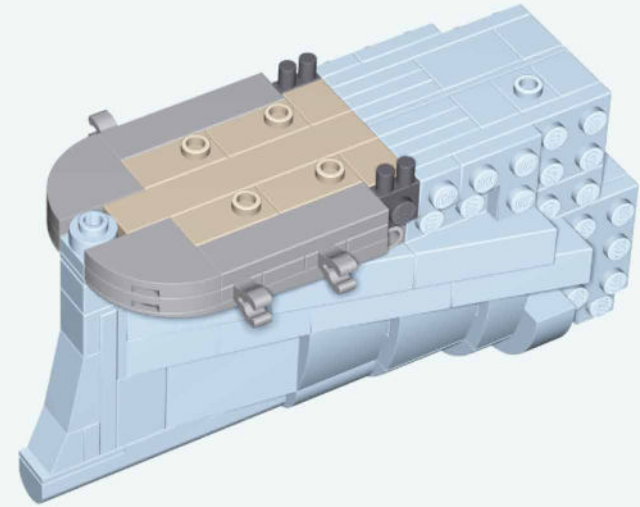

89

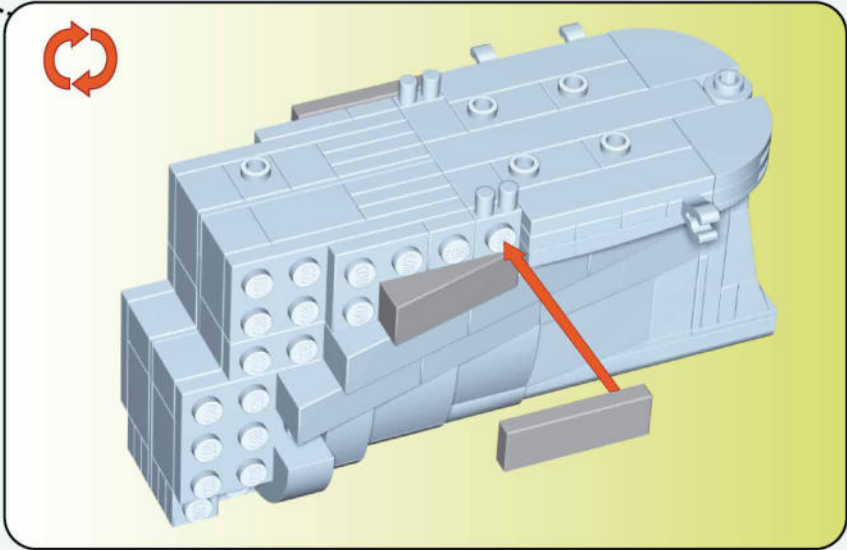
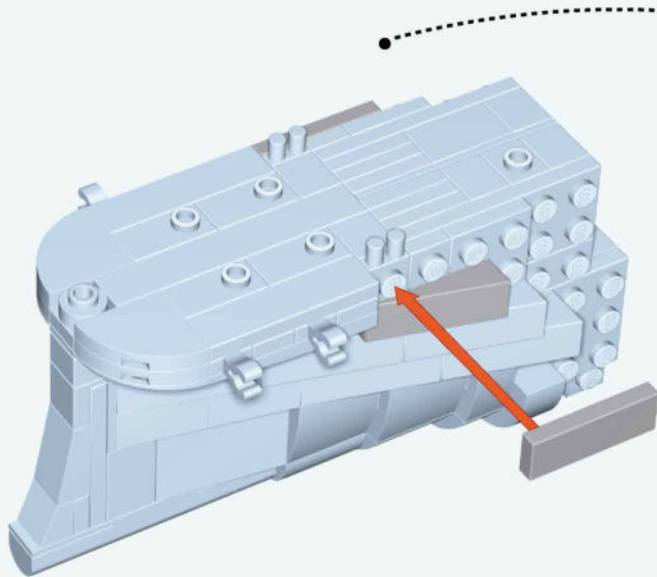
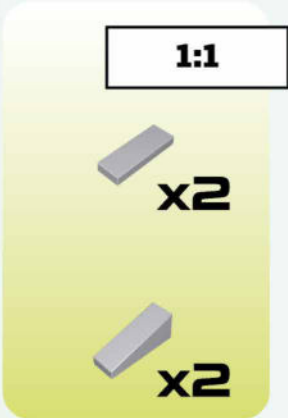

90

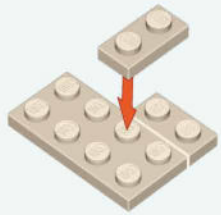

x1



x2

91

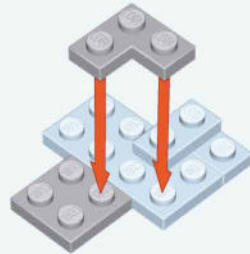

x1



x1

92

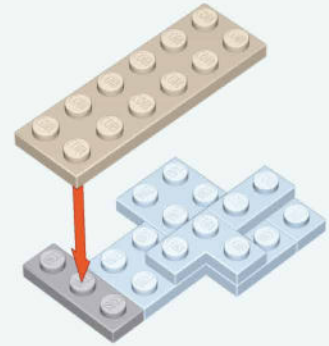

x1



x1

93



x1



x1

94

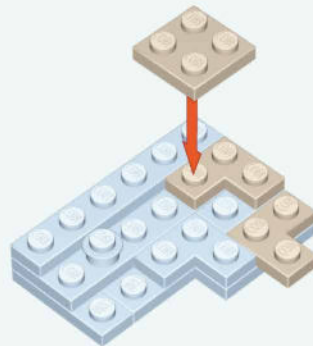

x2



x1

95

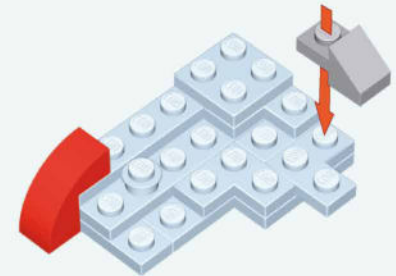

x1



x1

96

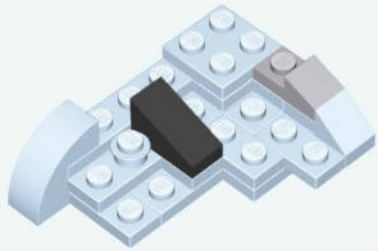

 x1

 x1

97

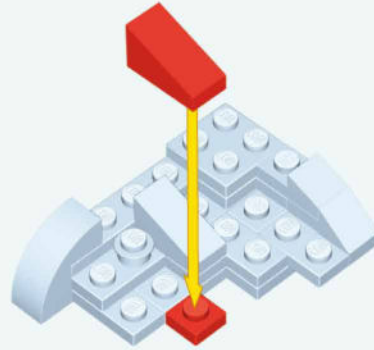

 x1

 x1

98

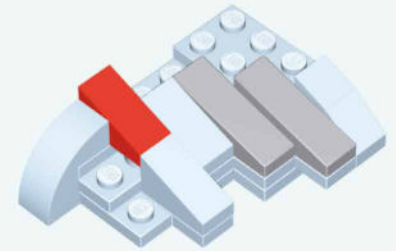

 x2

 x1

99

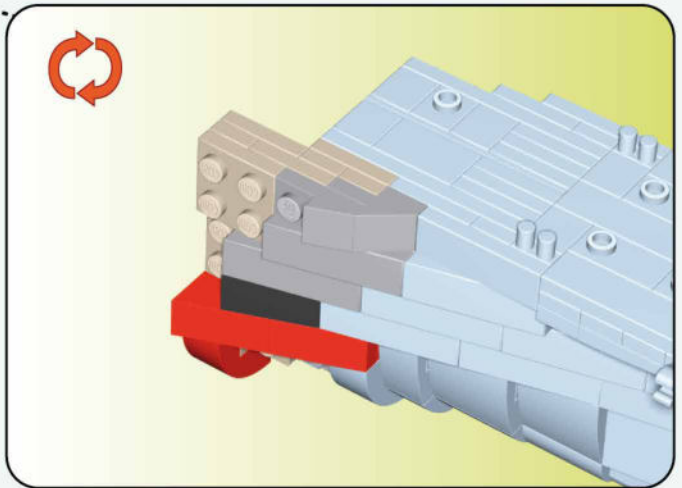
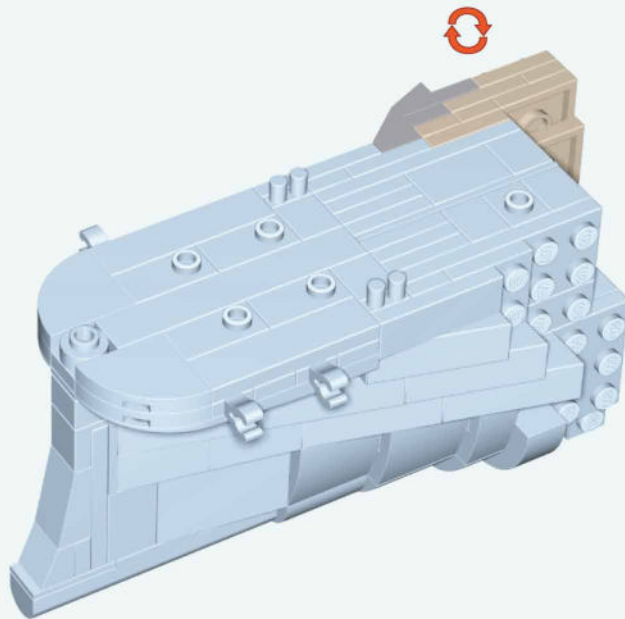

100

 x2

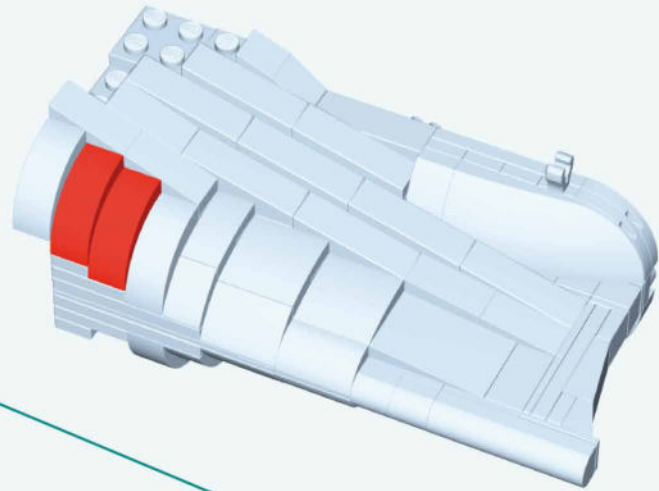

101

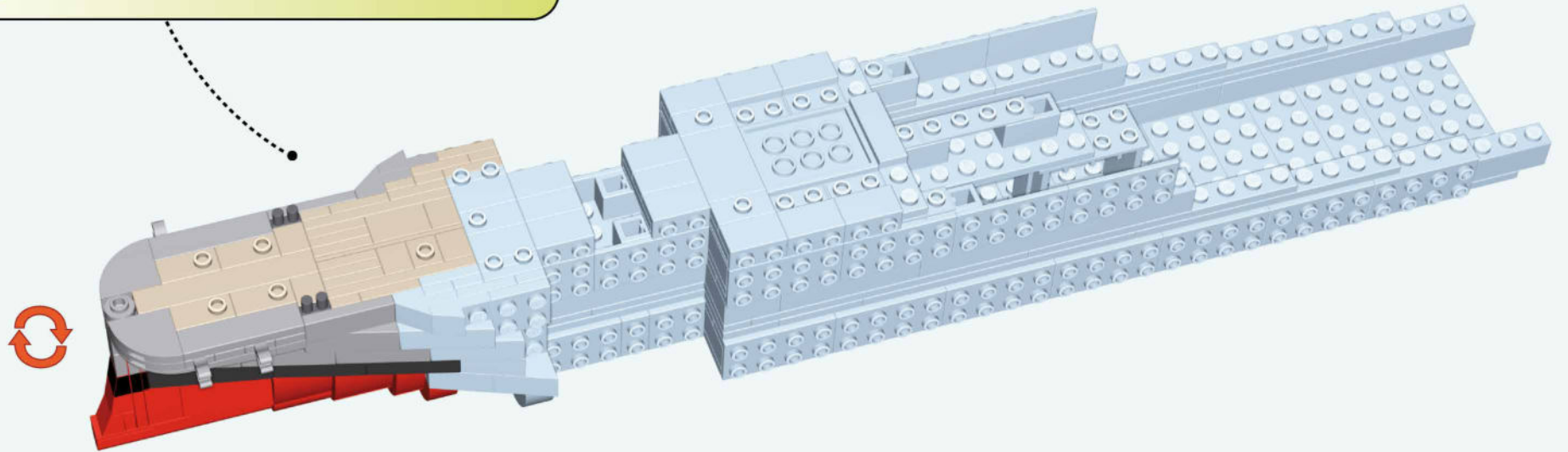
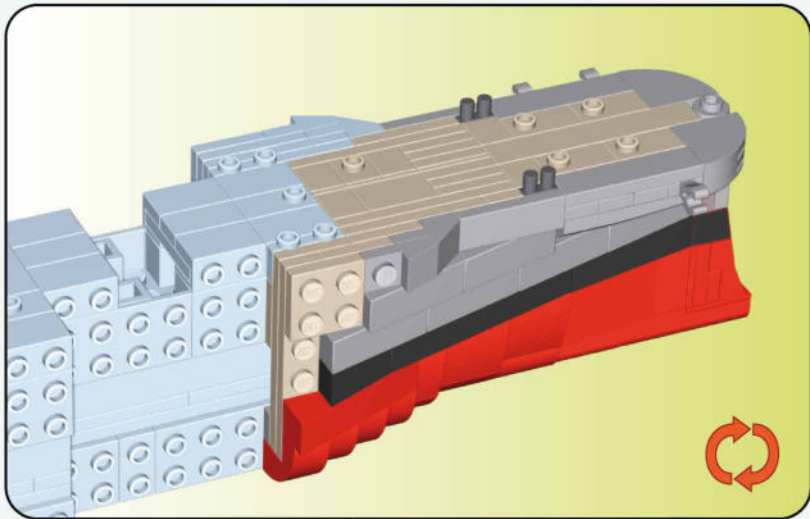



102

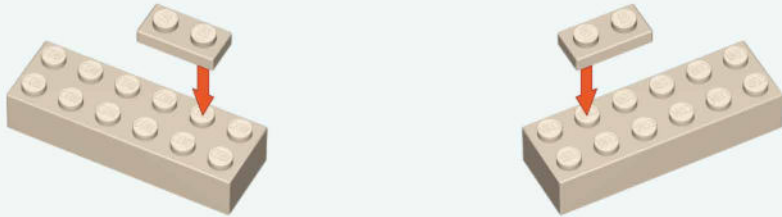

103

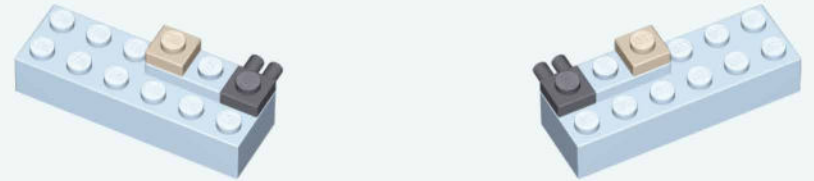

104

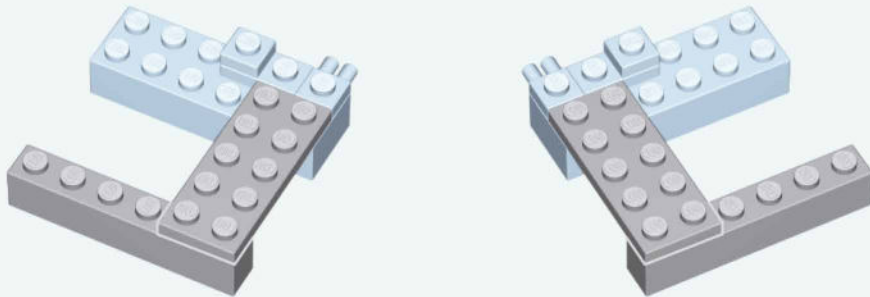

105

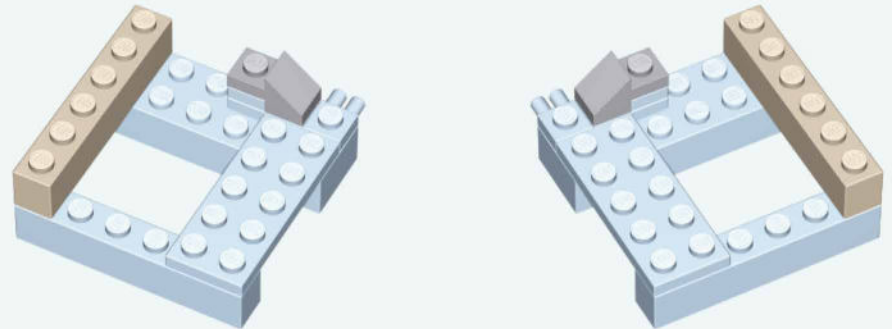

106

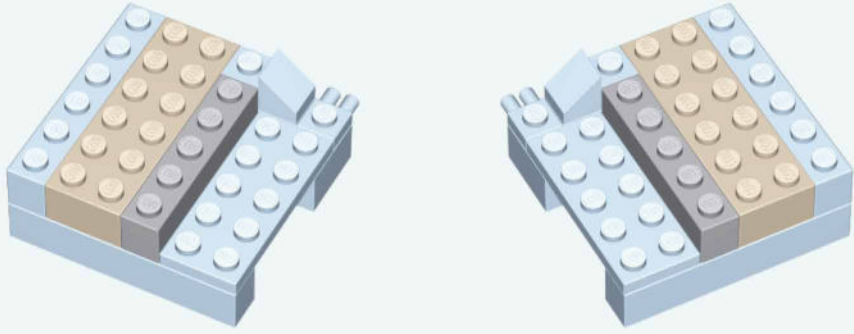

107

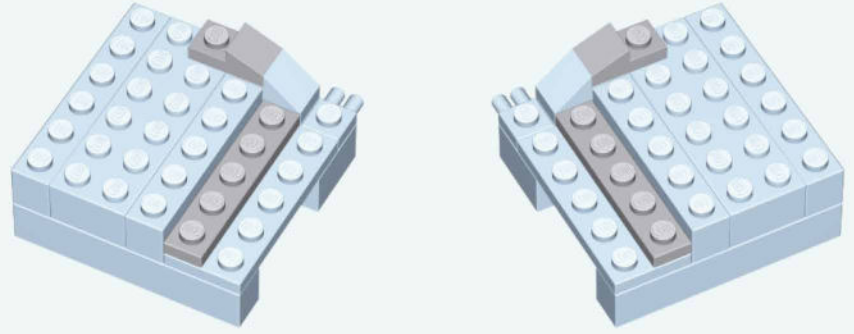

108



109

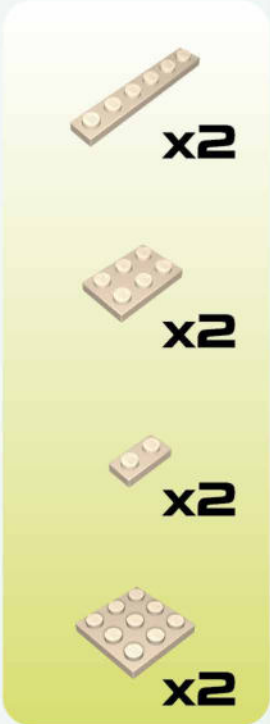
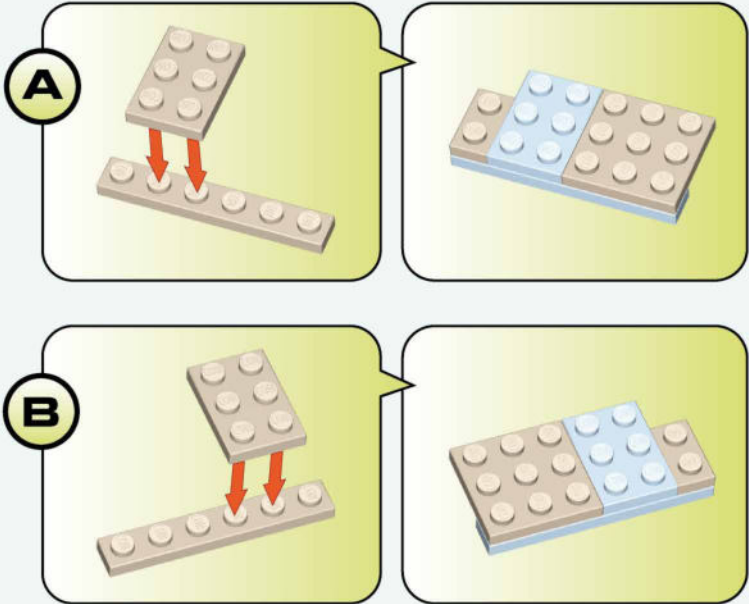

110

A

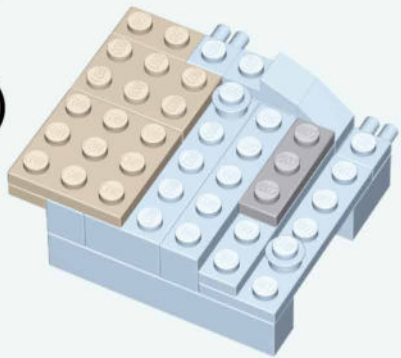

B

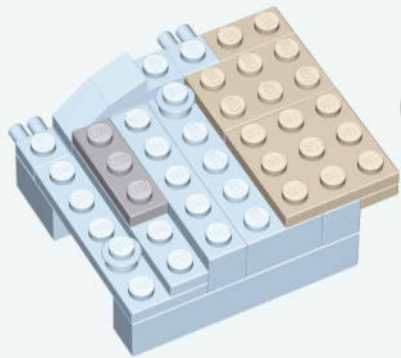

111

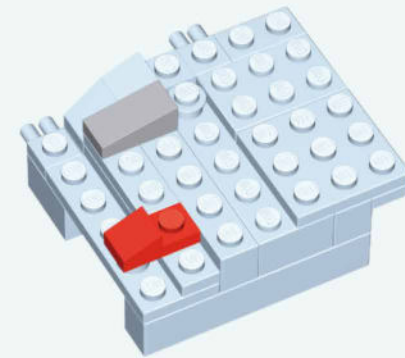
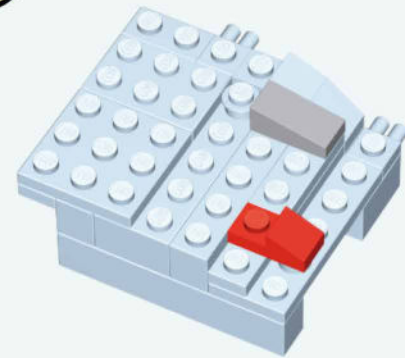

112

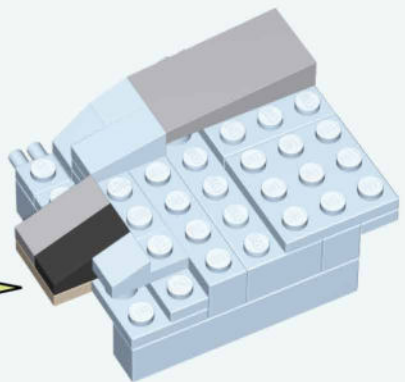
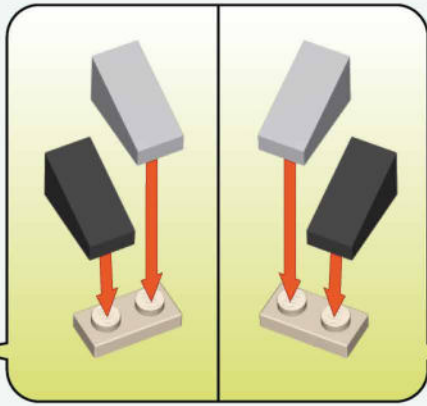
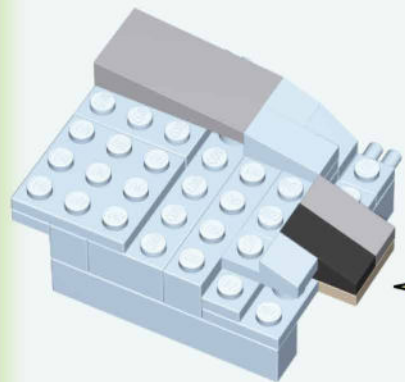

113



114

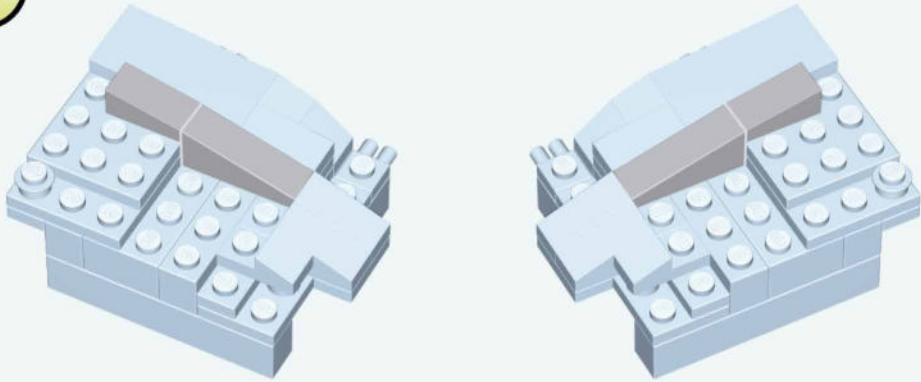

115

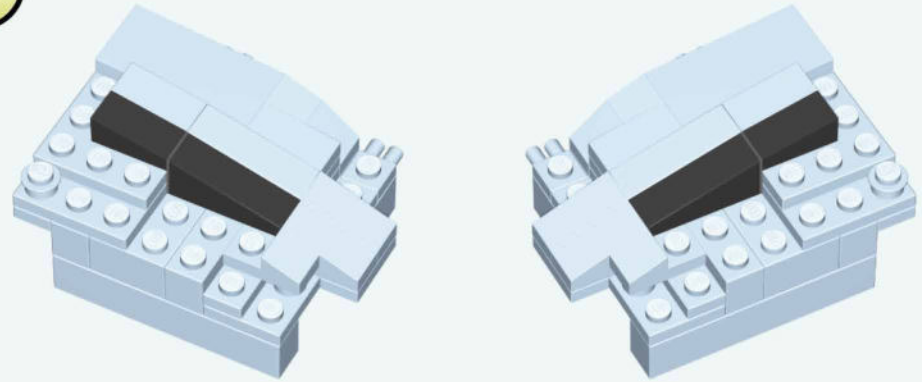

116

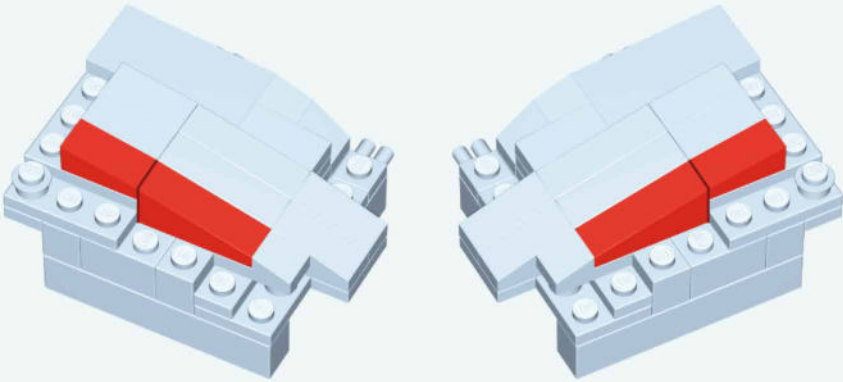

117

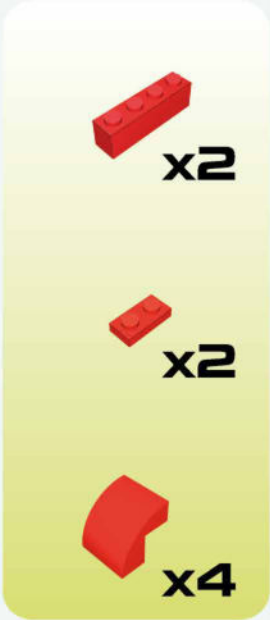
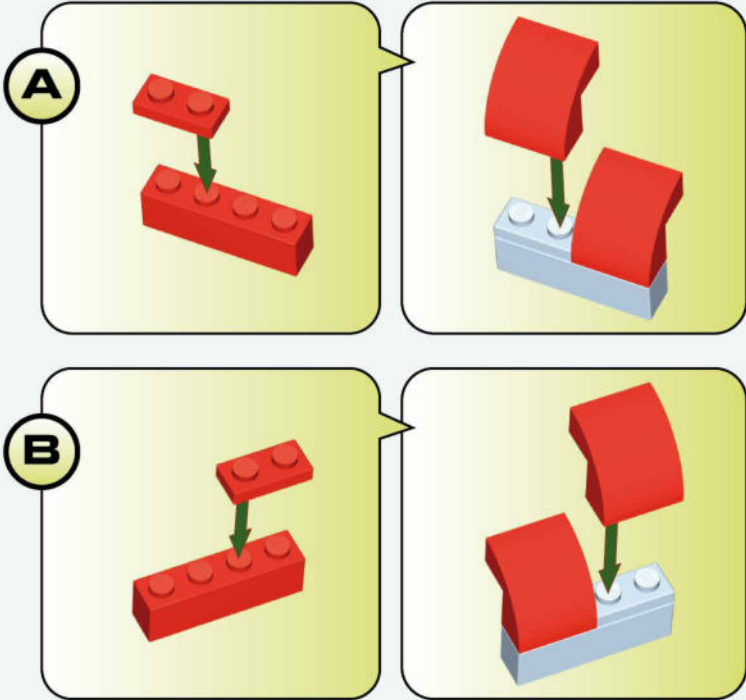

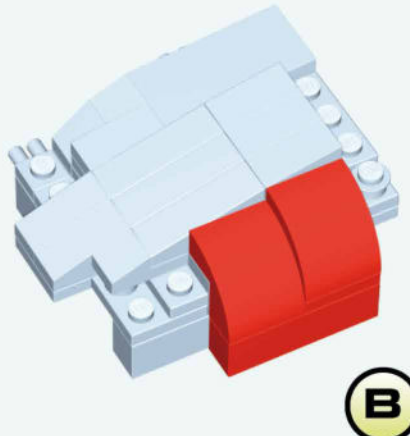
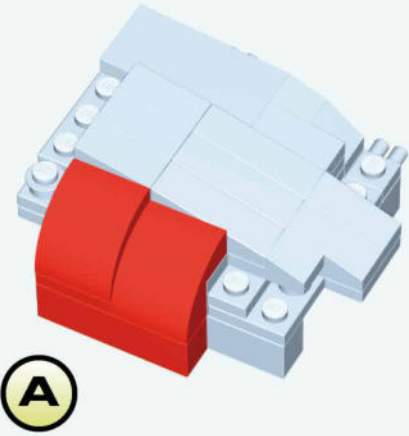

118

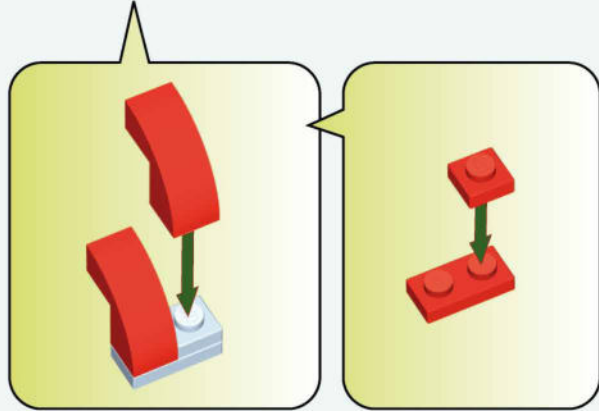
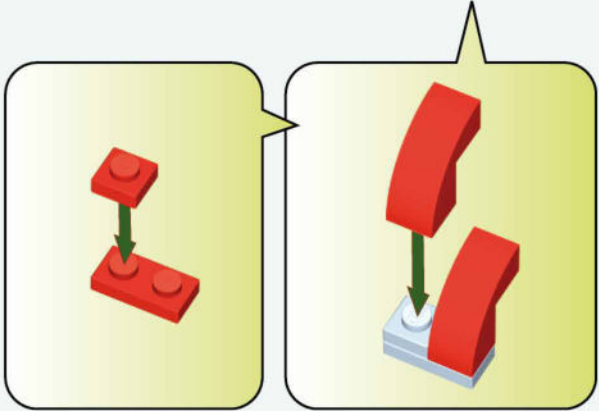
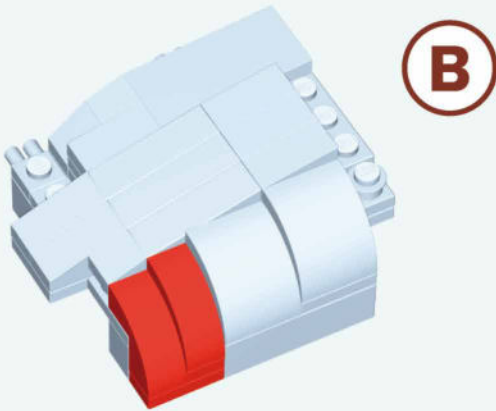
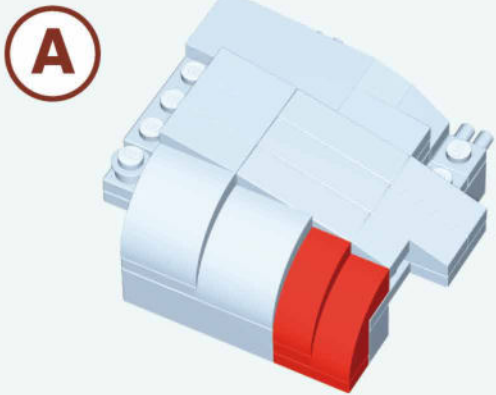

119



-  x2
-  x2
-  x4

120

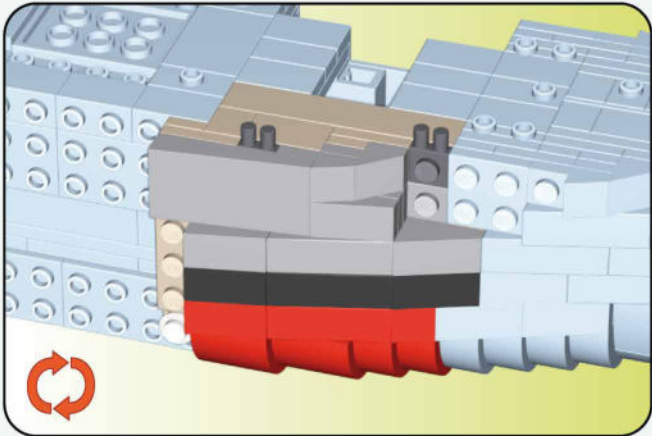

A

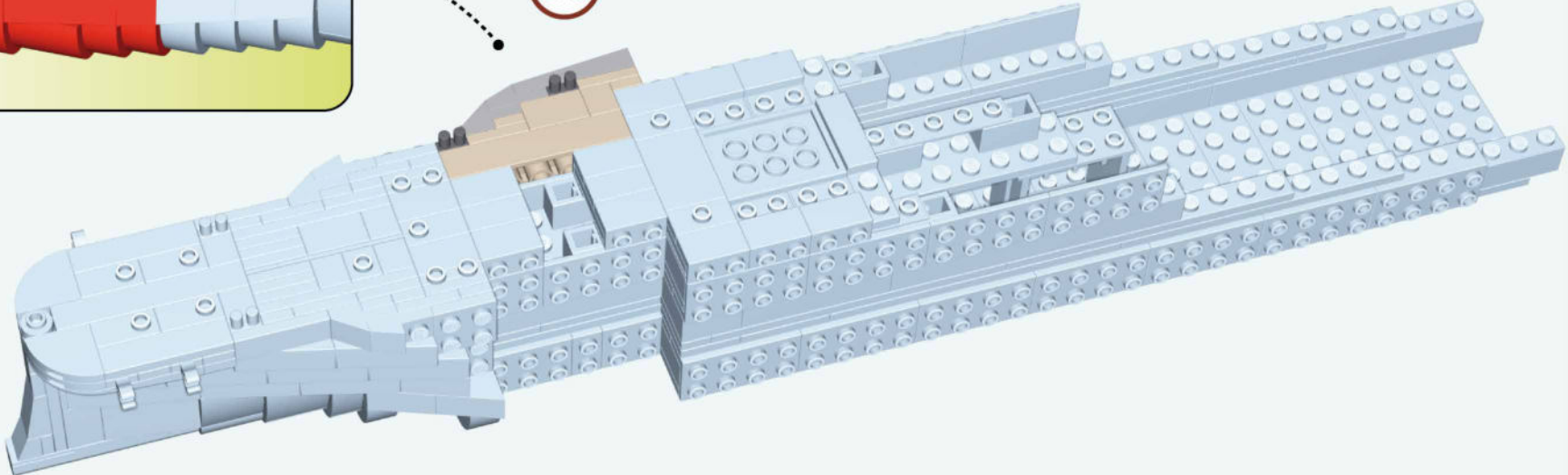

121

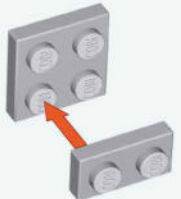

122

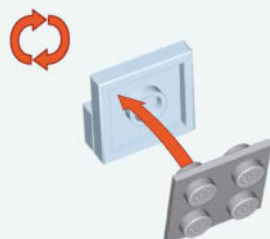

123

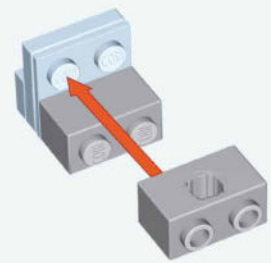

124

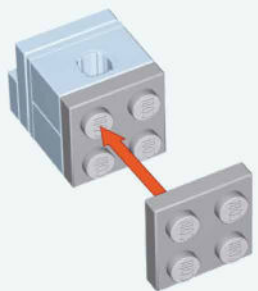

125

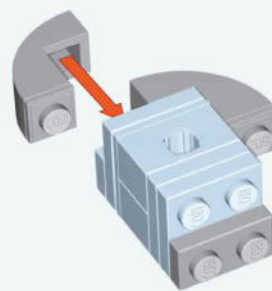
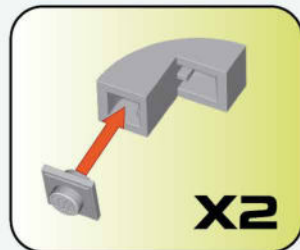

126

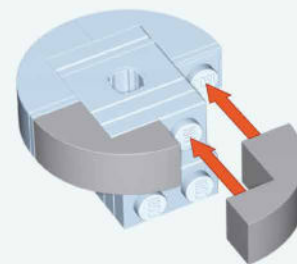

127

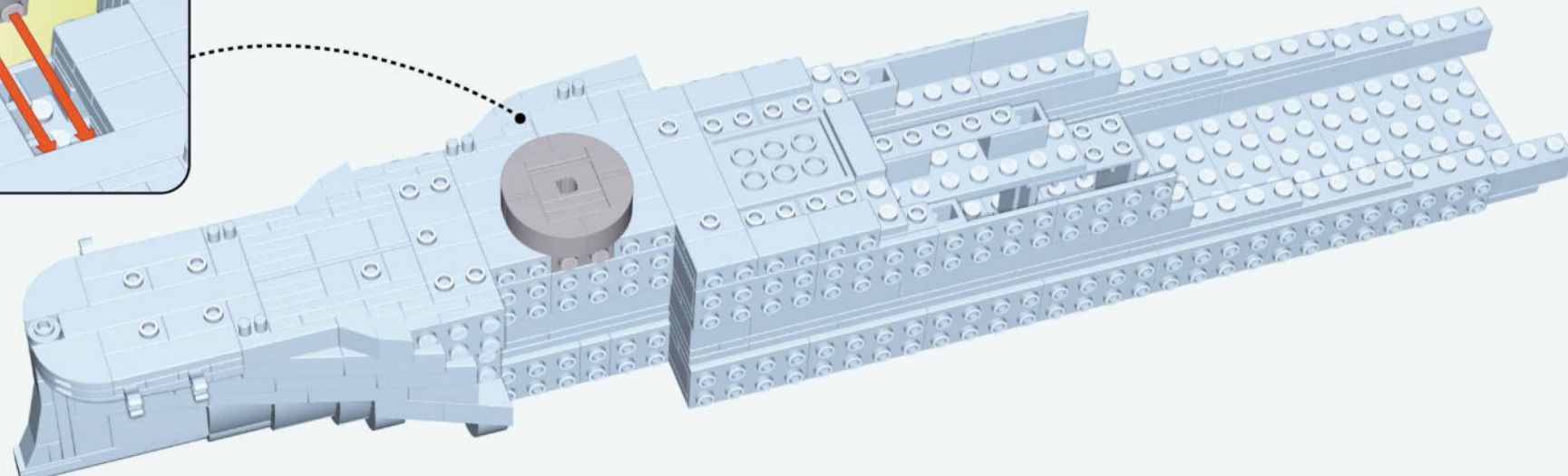
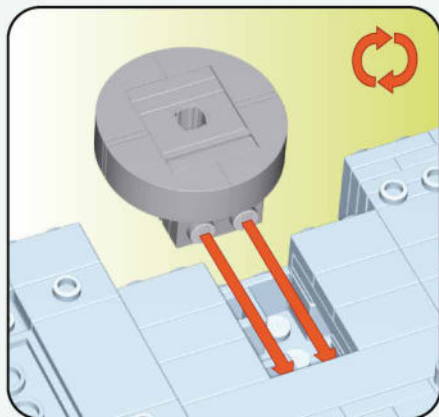

128

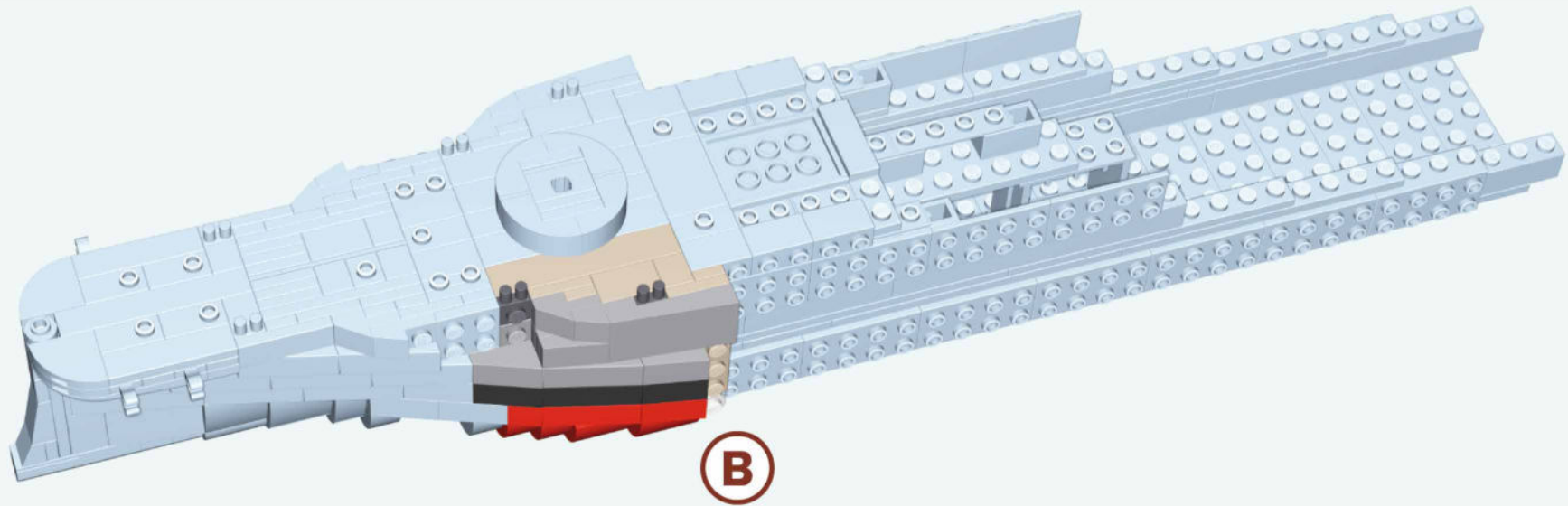

129

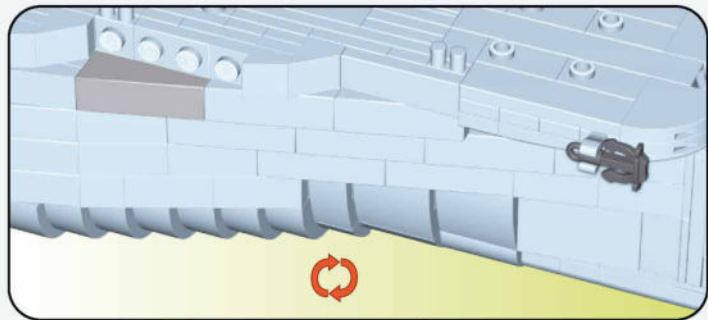

Parts list for step 129:

- x3
- x2
- x2
- x2

Scale: 1:1

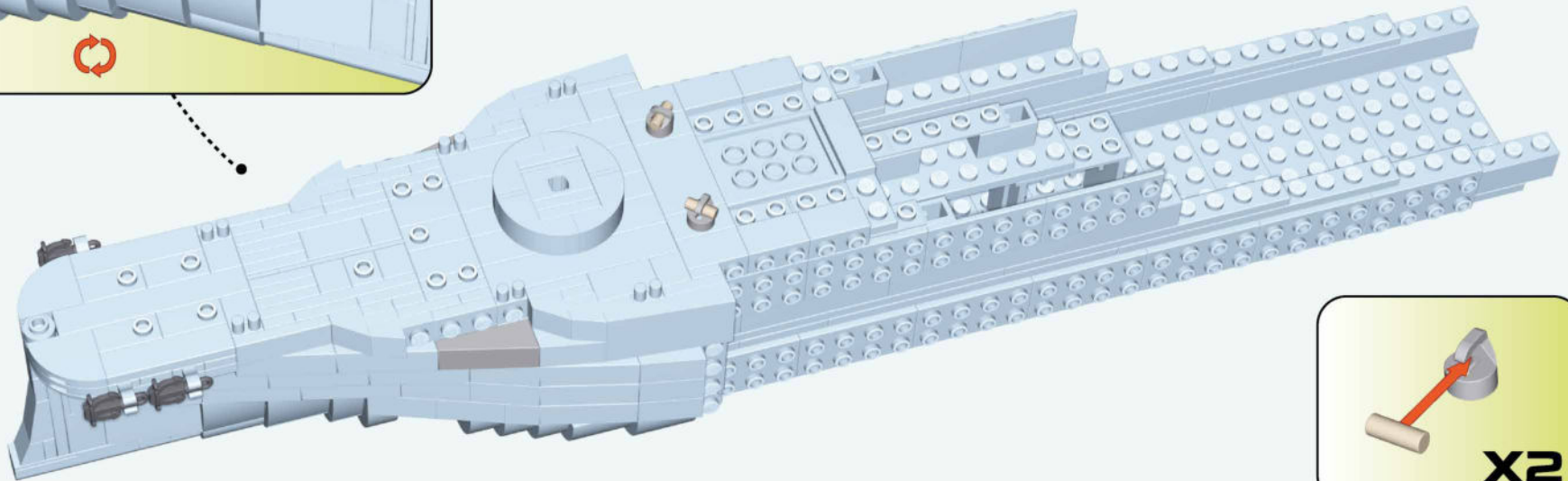

Parts list for step 129 (continued):

- x2

130

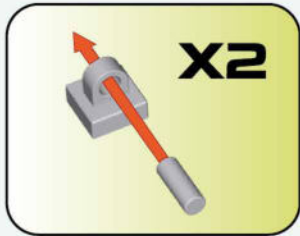

1:1

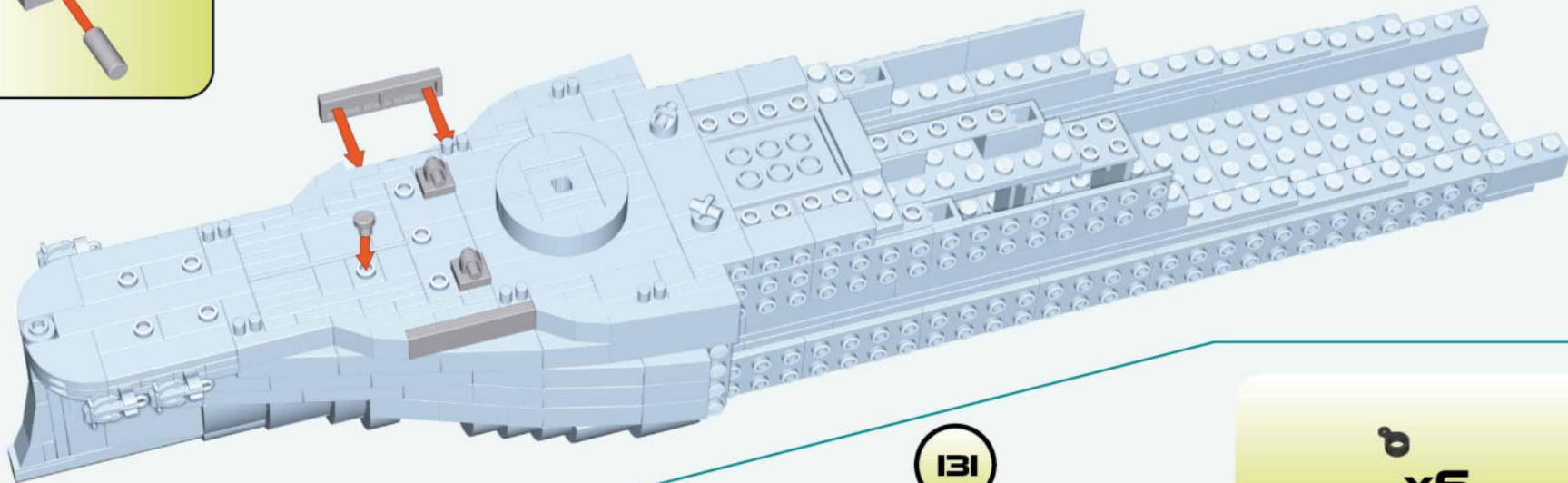

131



<p>A</p> <p>x2</p>		<p>x13</p>	
<p>B</p> <p>x2</p>		<p>x12</p>	
<p>C</p> <p>x2</p>		<p>x9</p>	

132

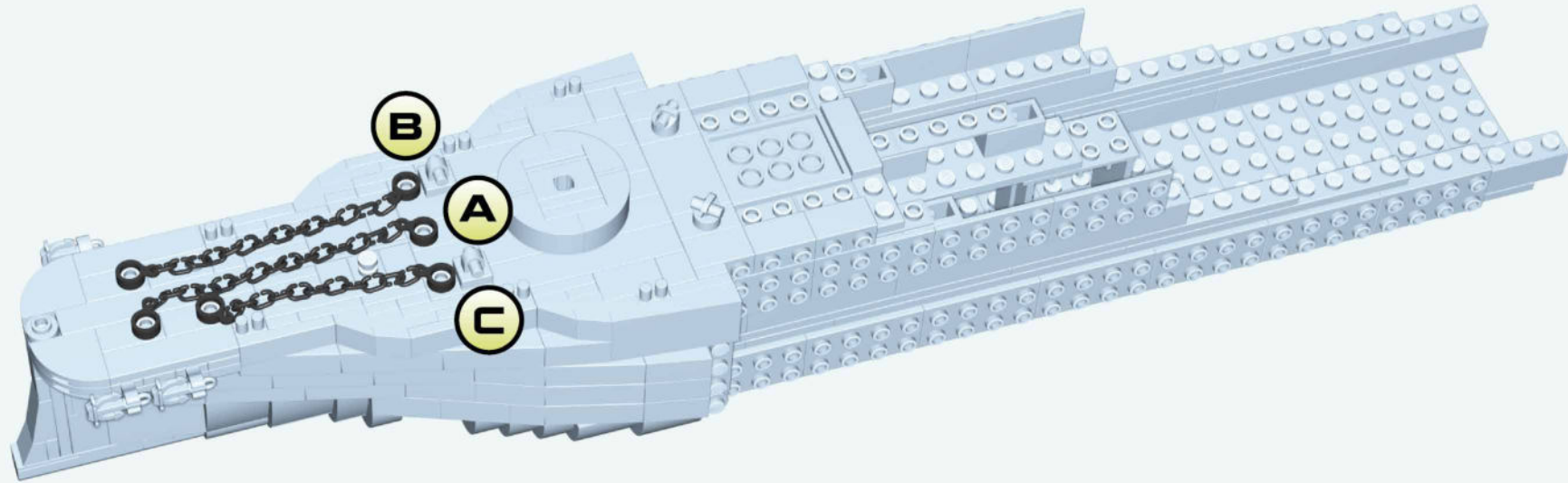

133

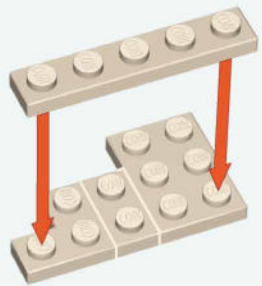

x1



x1



x1



x1

134



x1



x1

135

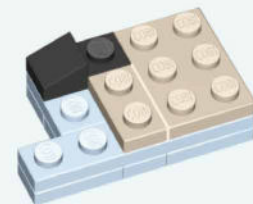

x1



x1



x1

136

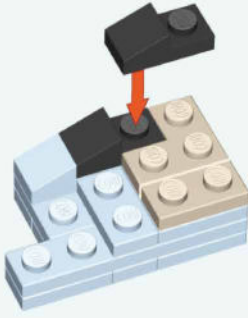

-  x2
-  x1
-  x1

137

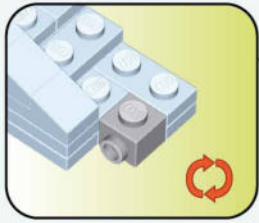

-  x1
-  x1

138

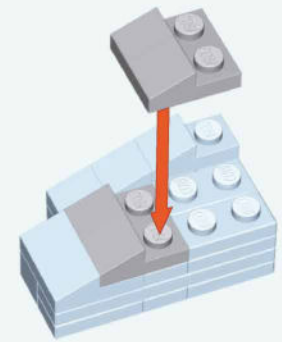

-  x2

139

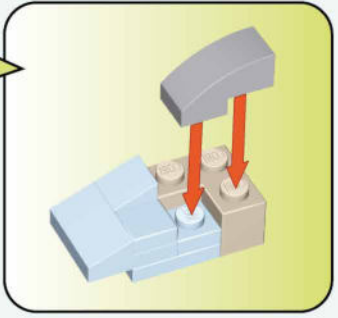
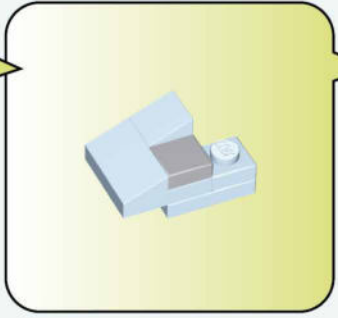
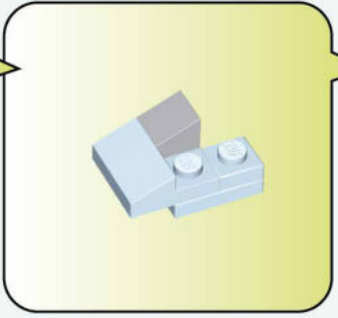
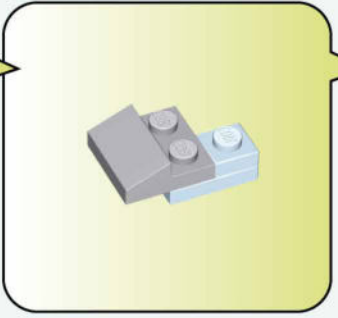
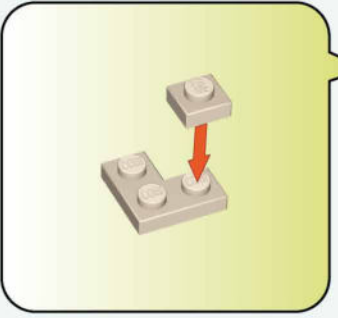

-  x1
-  x1
-  x1
-  ^① x1
-  x1
-  x1
-  x1

140

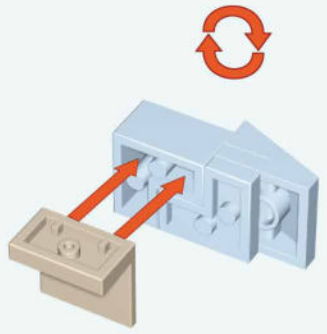

141

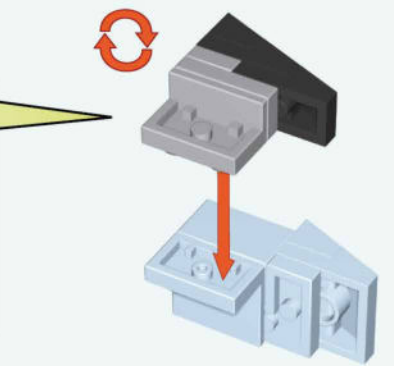
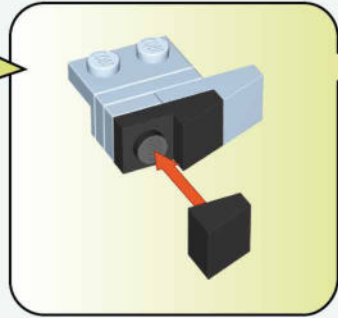
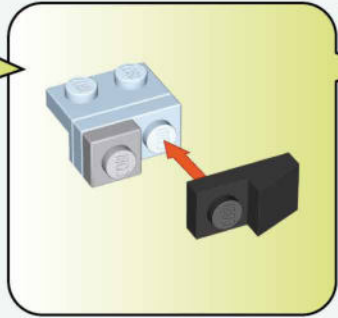
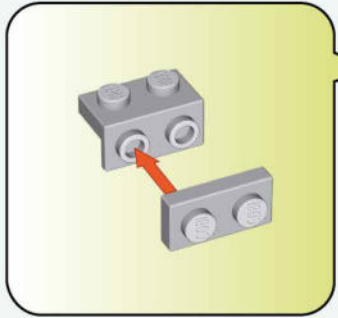

142

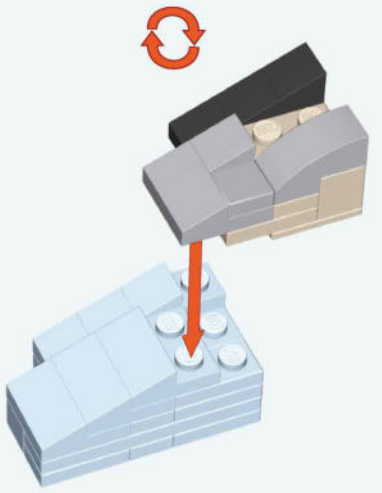

144

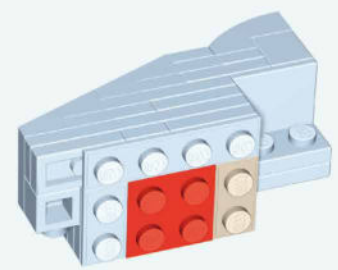

143

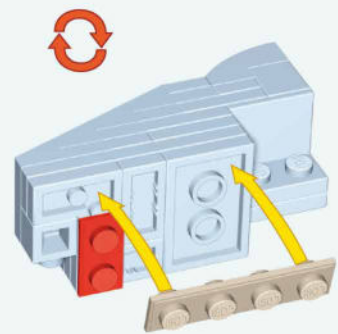



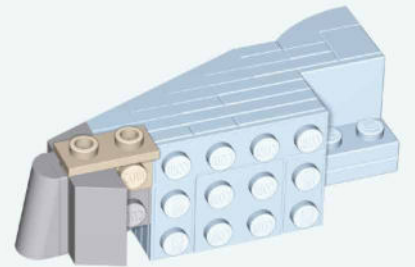
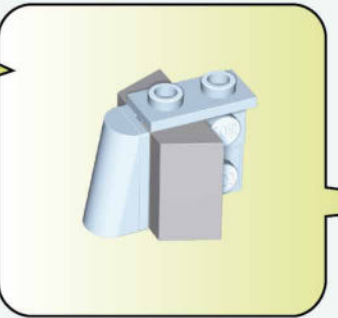
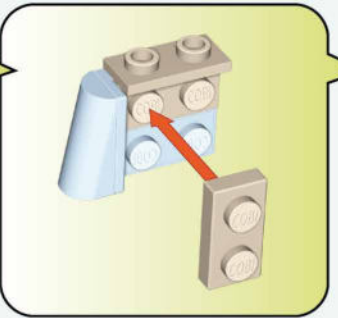
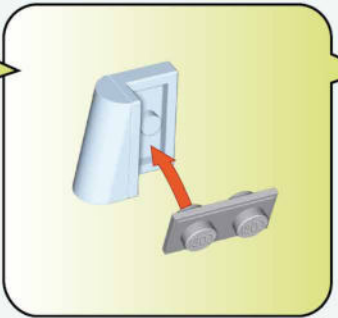
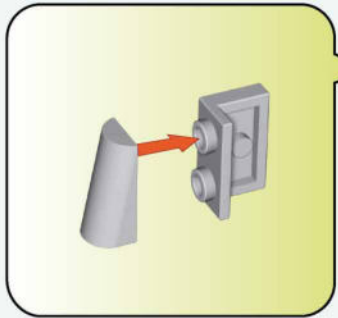

145

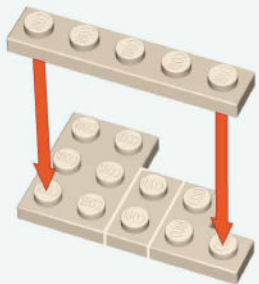

-   x1
-  x1
-  x1
-  x1
-  x1
-   x2

146



-  x1
-  x1
-  x1
-  x1

147

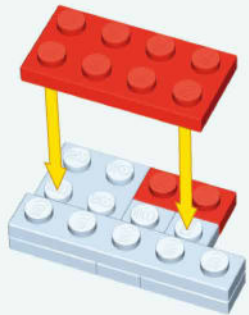

-  x1
-  x1

148

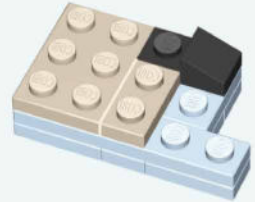

-  x1
-  x1
-  x1

149

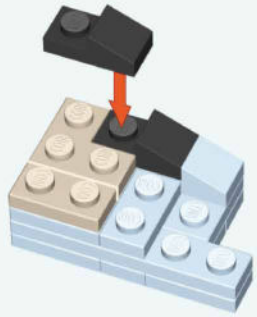

150

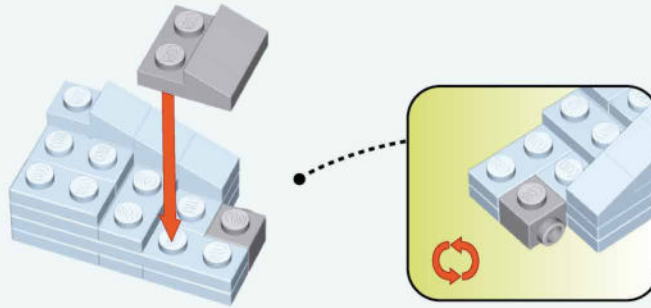

151

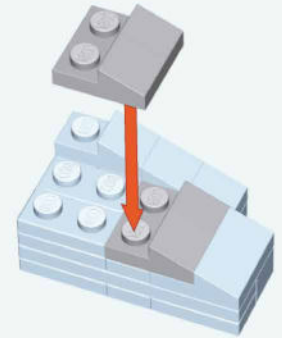

152

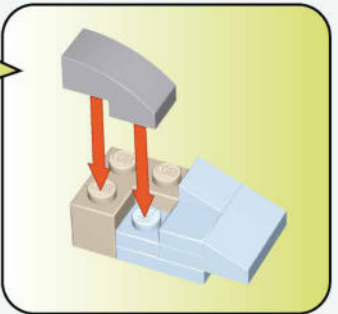
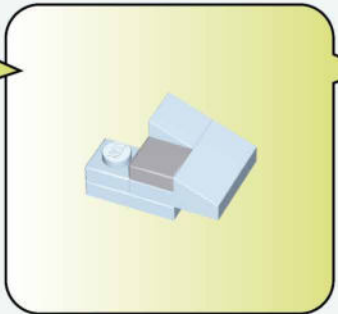
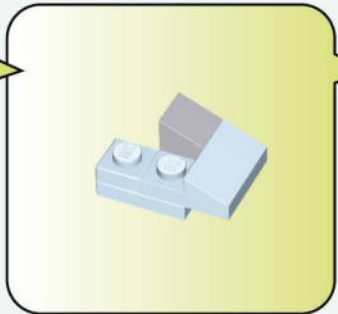
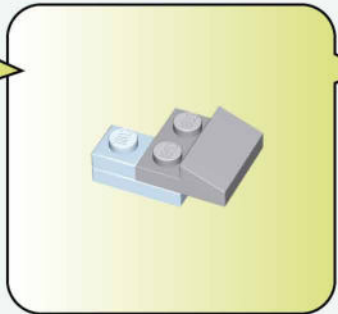
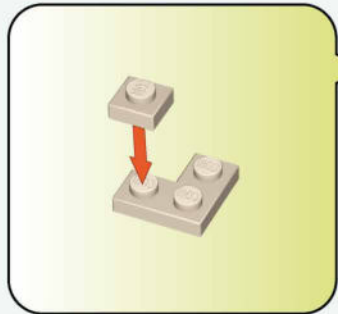

153

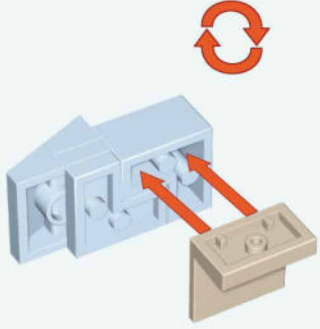

154

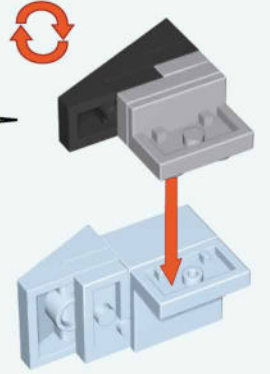
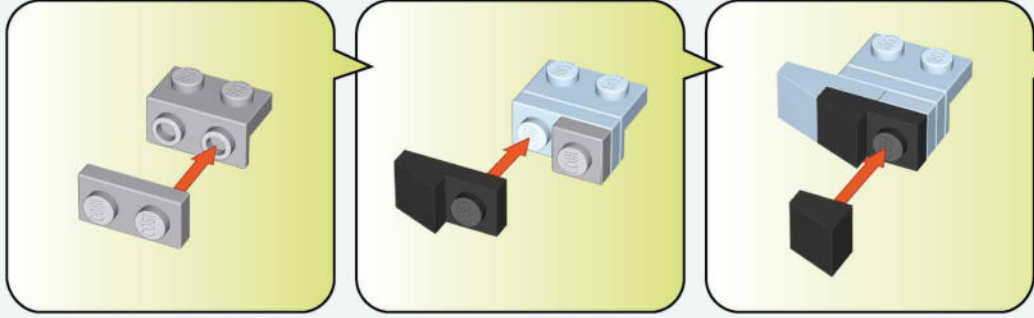

155

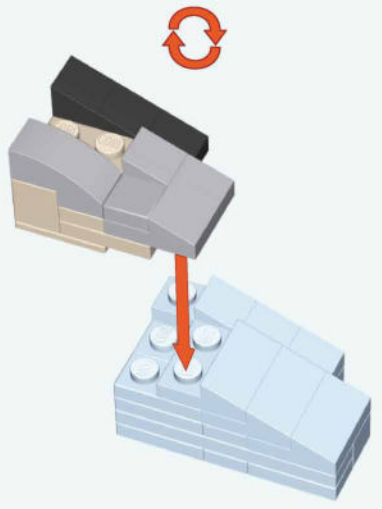

156

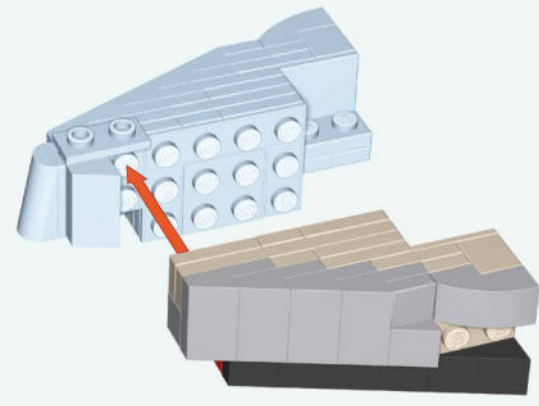

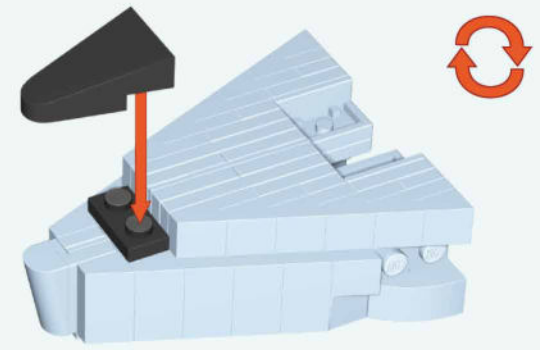

157

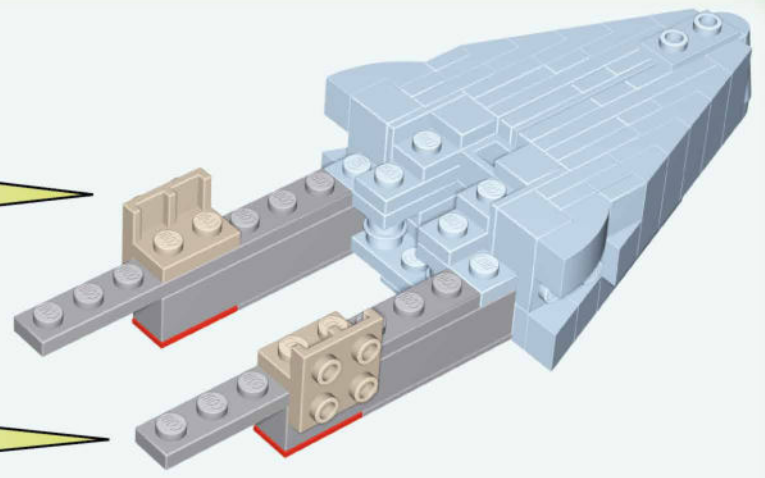
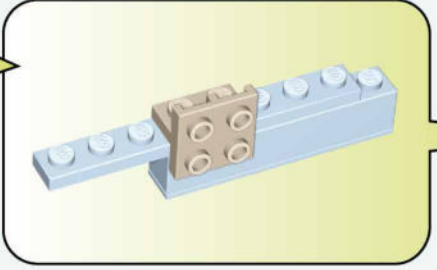
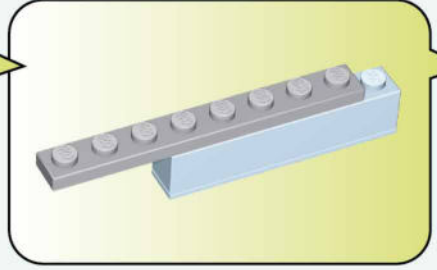
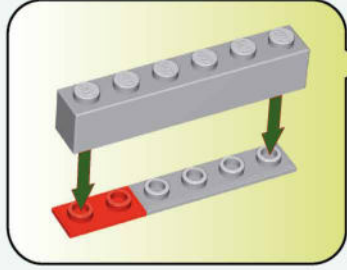
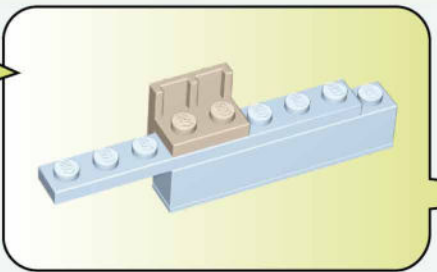
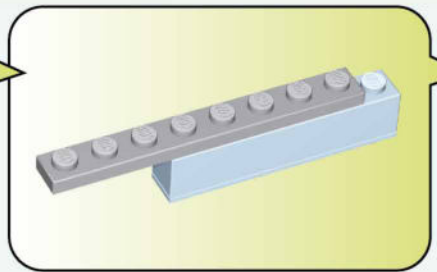
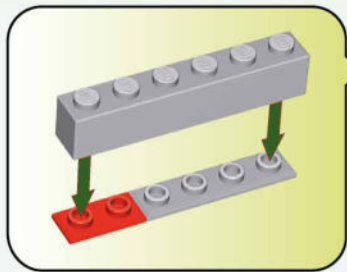

160



-  x2
-  x2
-  x2
-  x2
-  x2

161

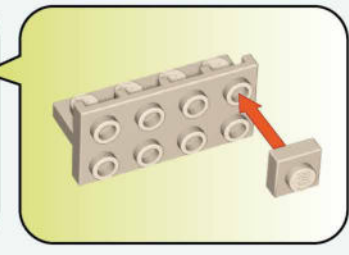
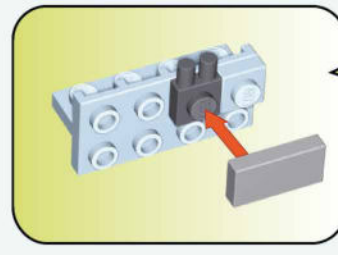
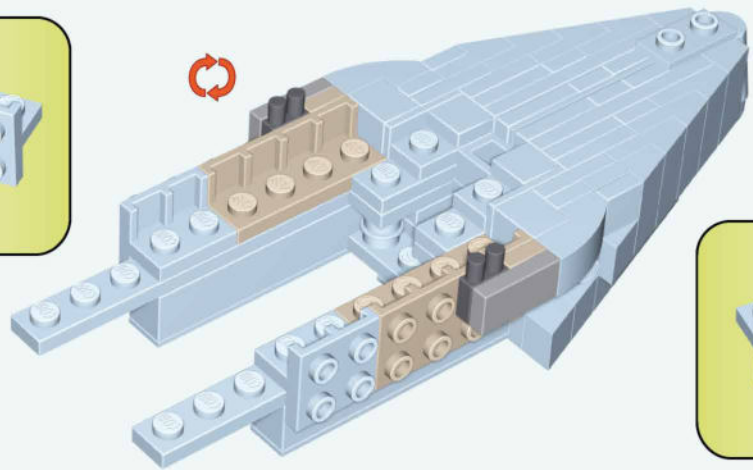
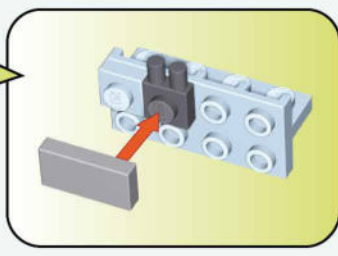
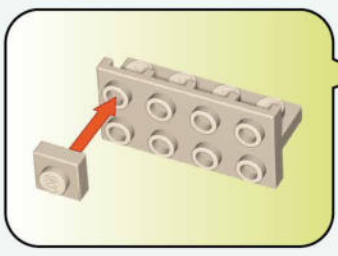

-  x2
-  x2
-  x2
-  x2
-  1:1

162

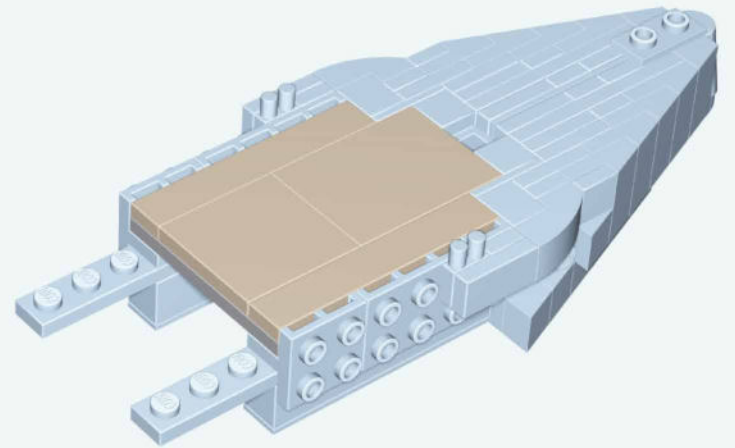
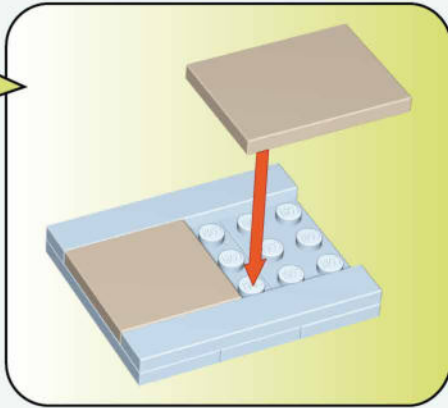
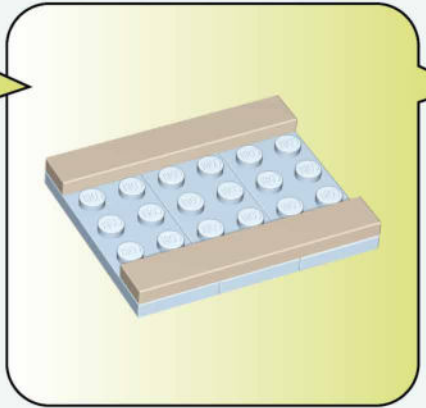
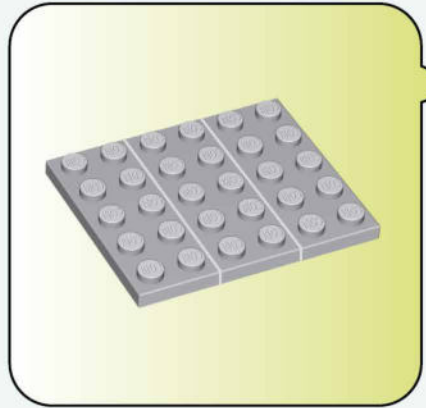

1:1



x3



x2

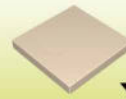

x1



x1

163

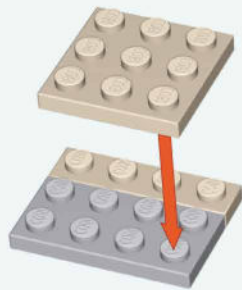
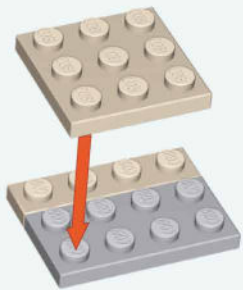

x2



x2



x2

164

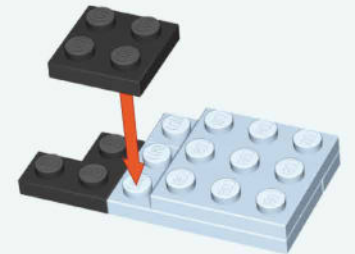
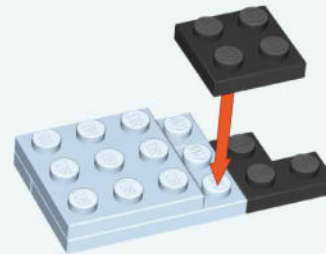

x2



x2

165

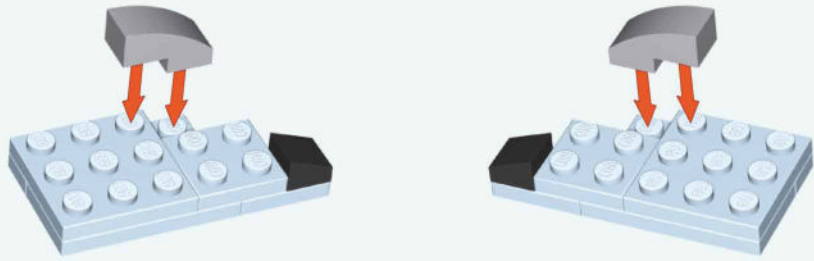

166

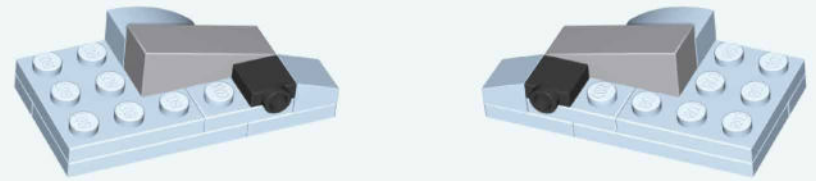

167

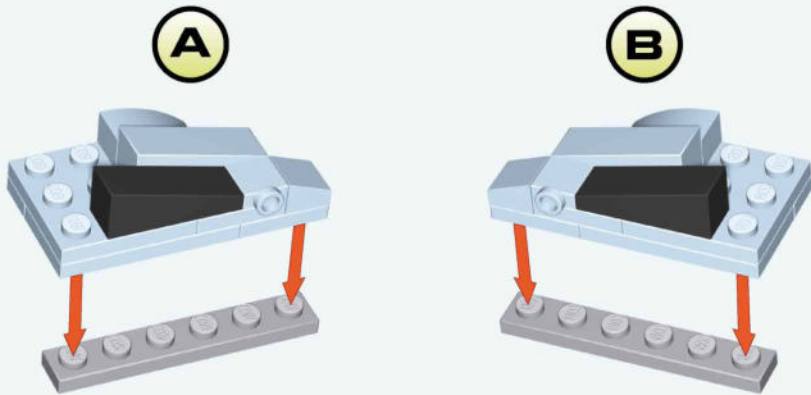

168

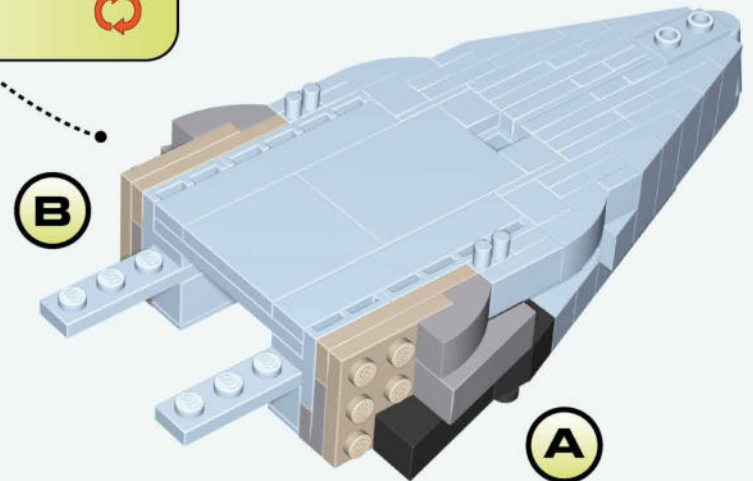
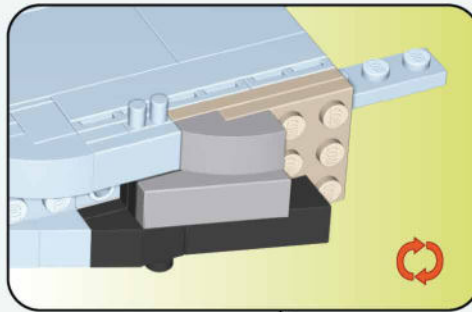

175

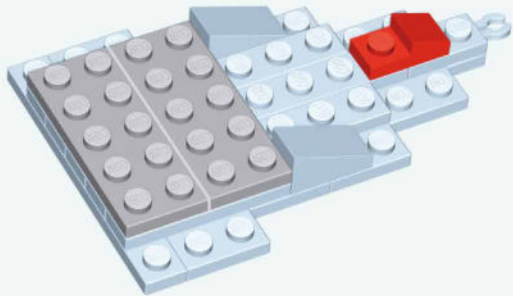

x2



x1

176

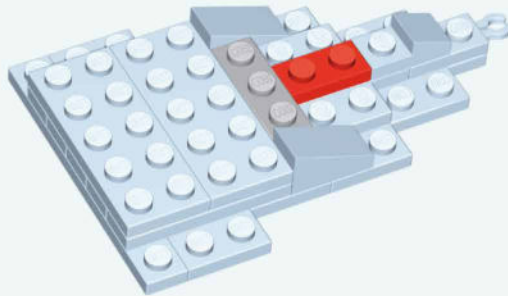

x1



x1

177

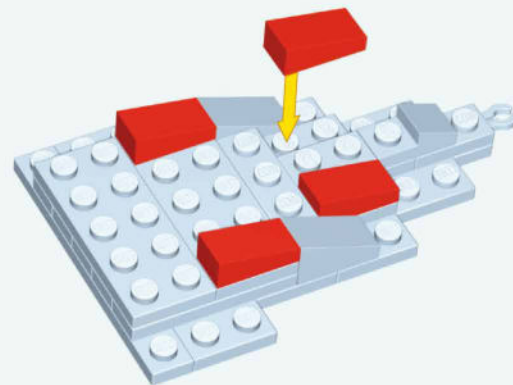

15



x4

178

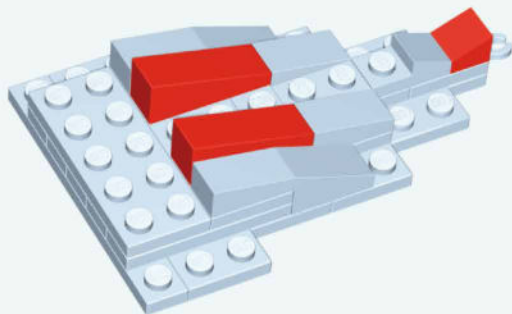

14



x2



x1

179

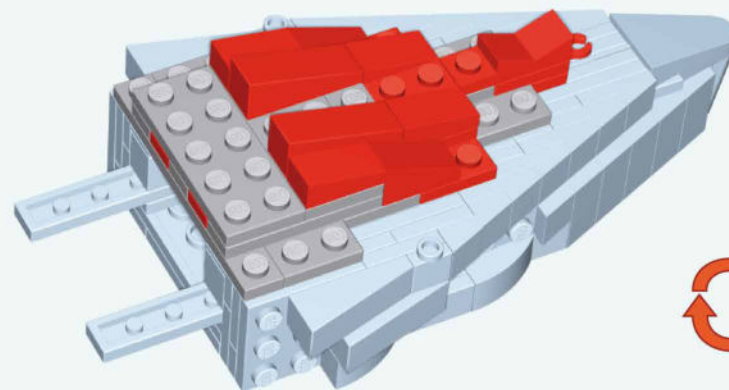

180

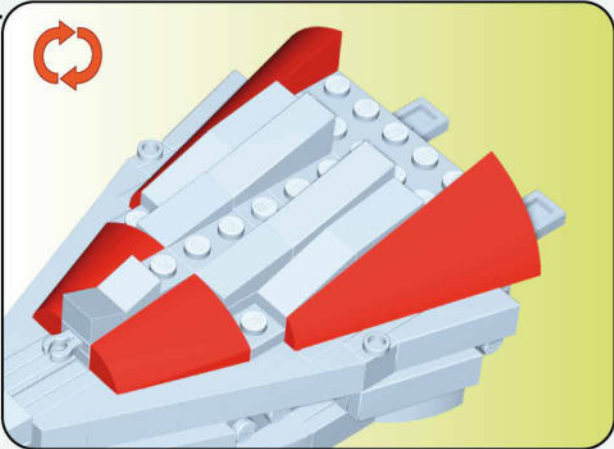
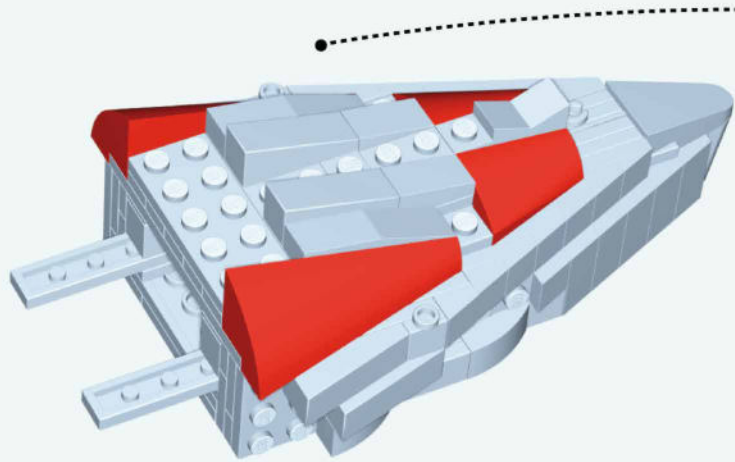

181

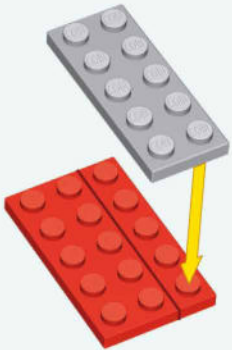

182

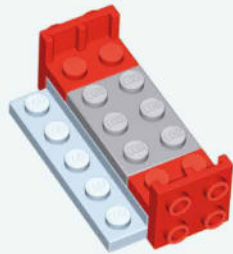

183

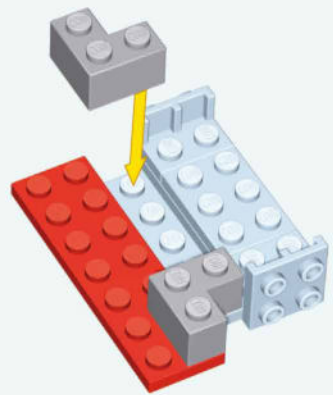

184

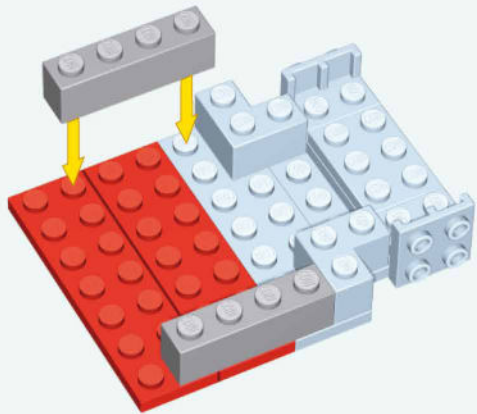

x2



x2

185

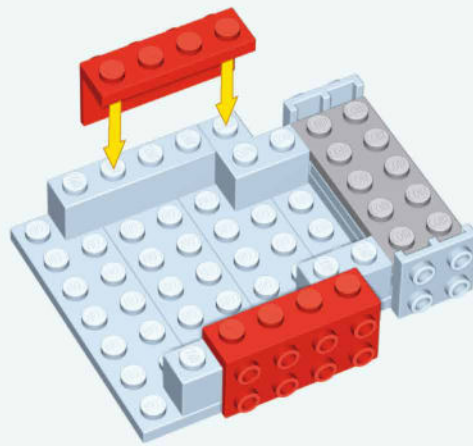

x2



x1

186

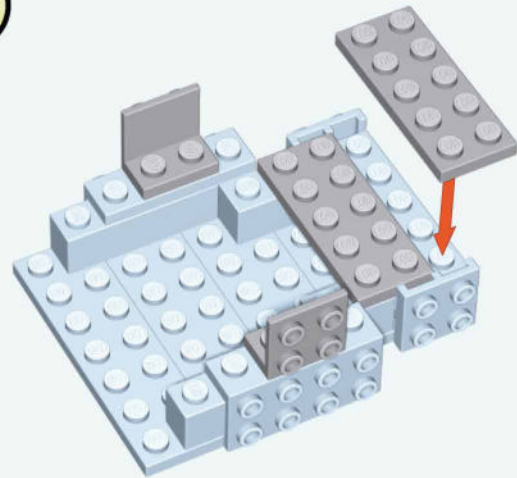

x2



x2

187

A

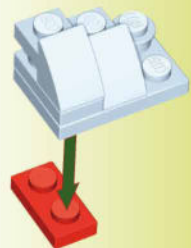
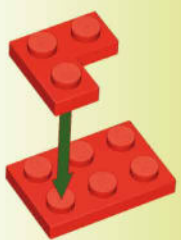

B

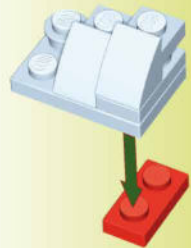
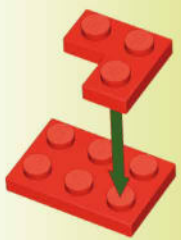

x2



x2



x2

7



x4



x4

188

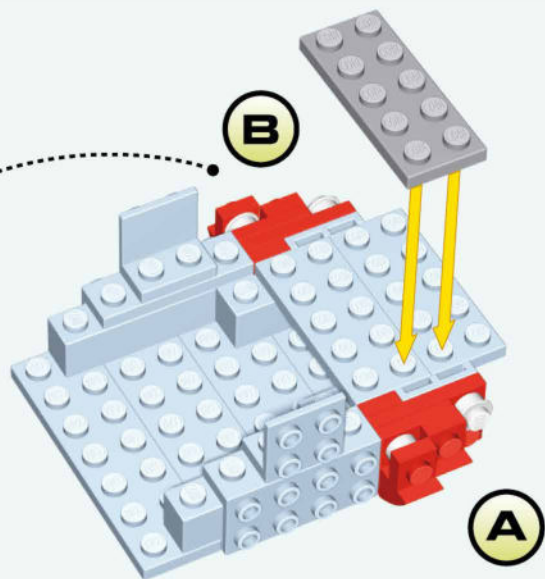
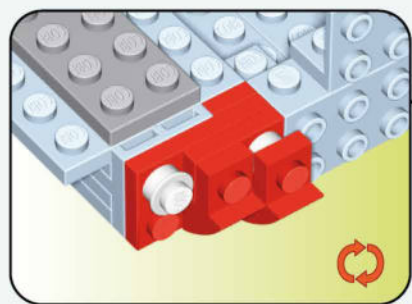

x1

189

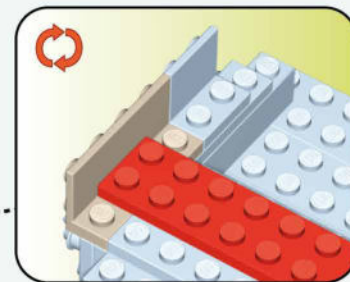
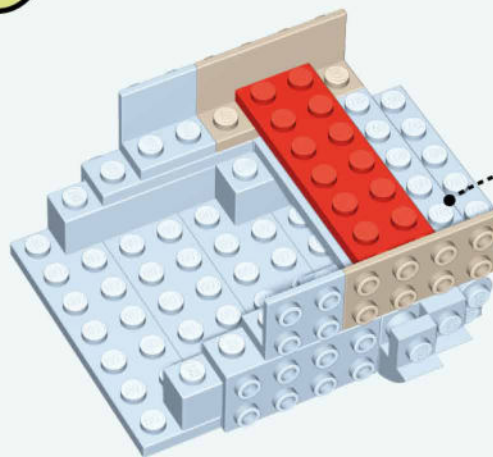

x2



x1

190

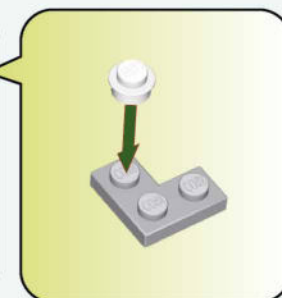
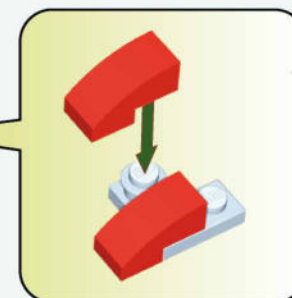
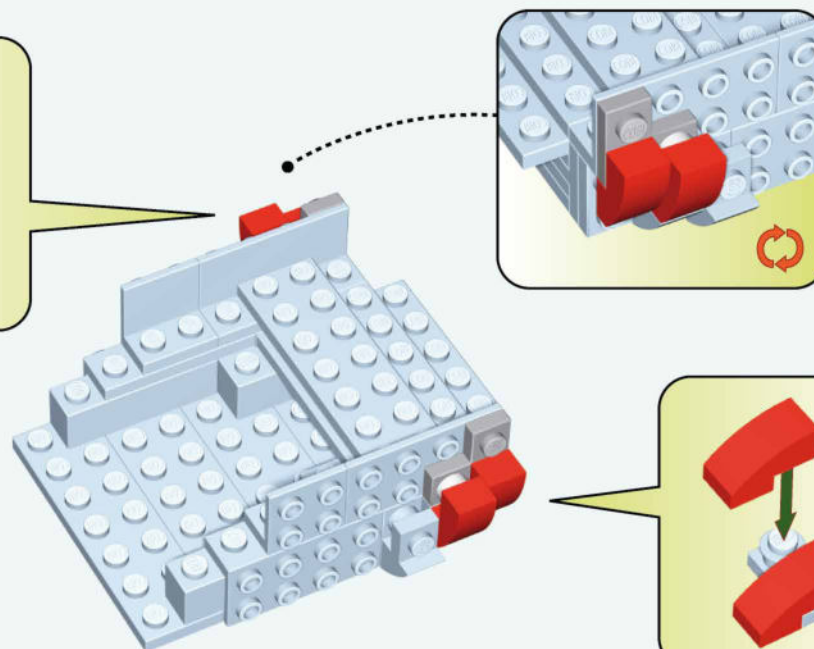
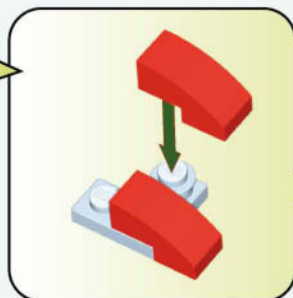
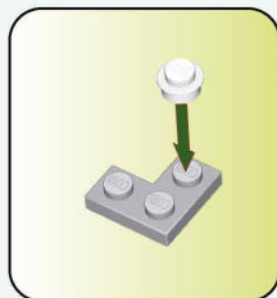

x2



x2



x4

191

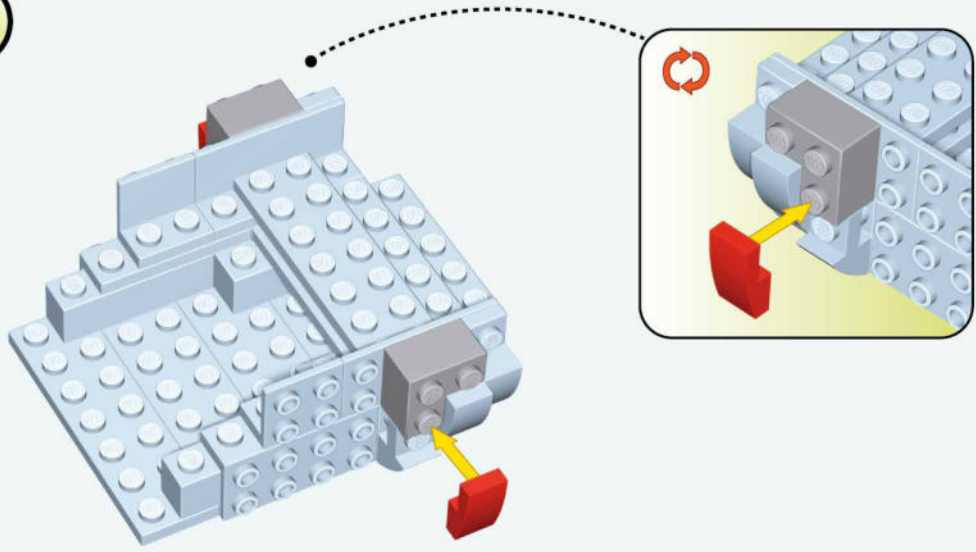

192

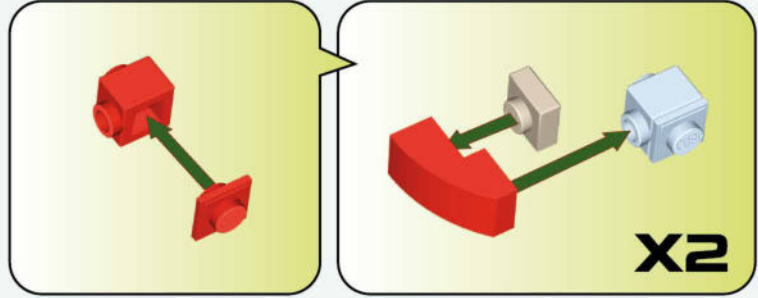

193

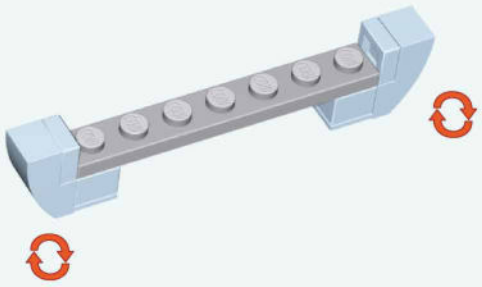

194

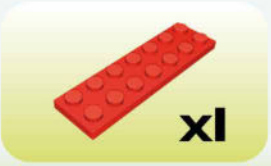
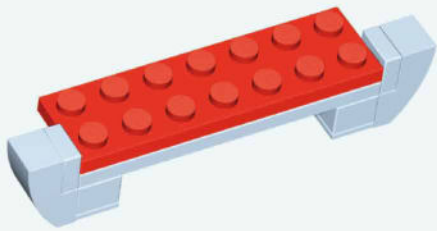

195

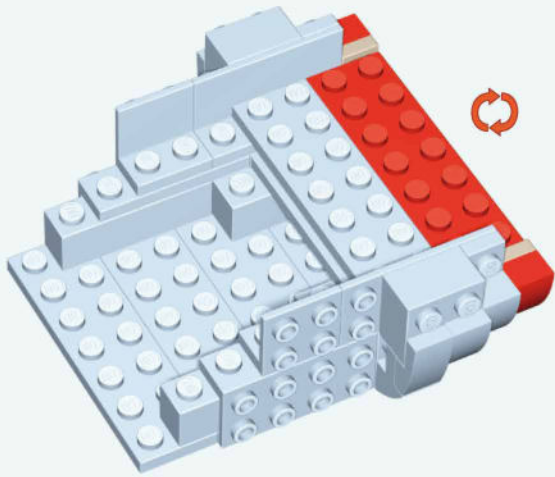

196

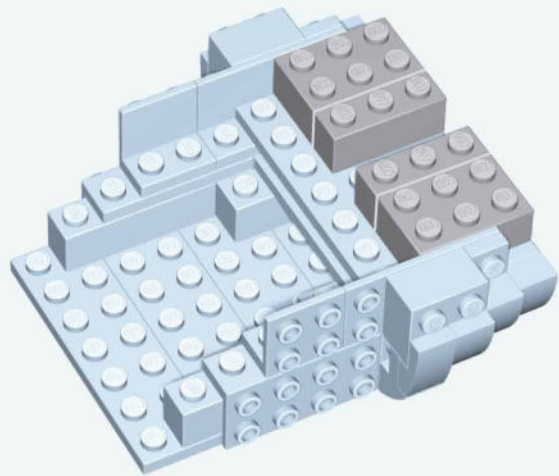

x2



x2

197

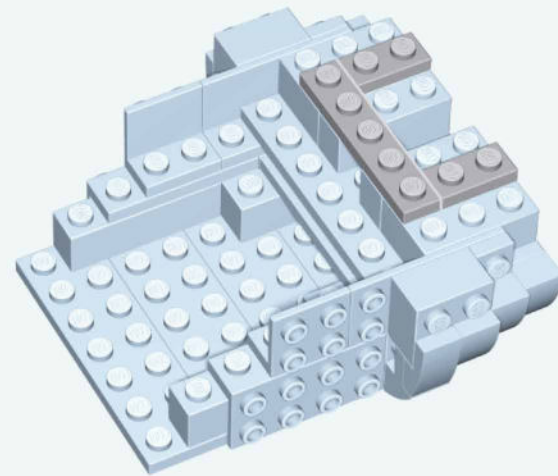

x1



x2

198

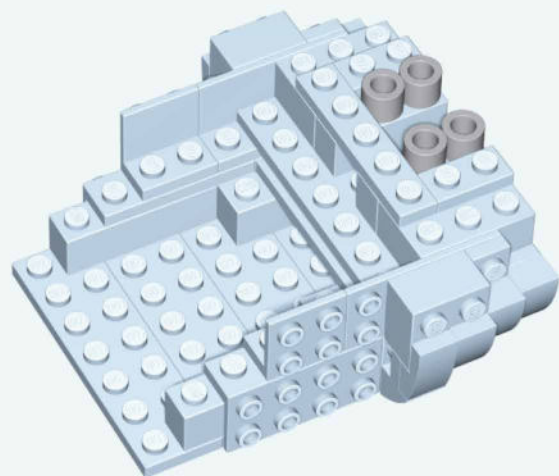

x4

199

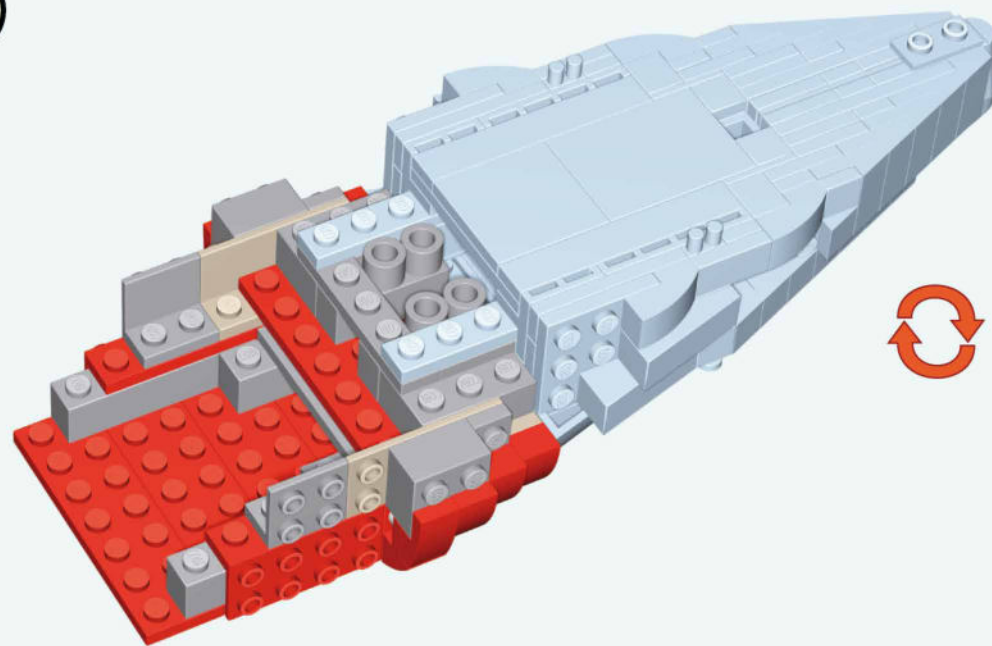

206

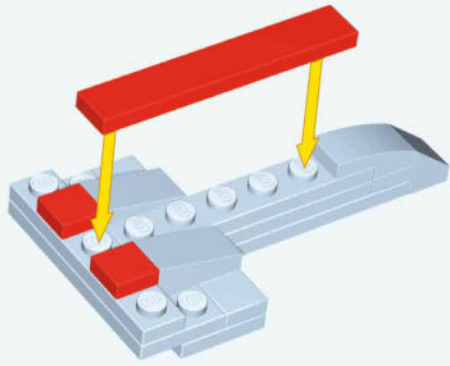

1:1



207

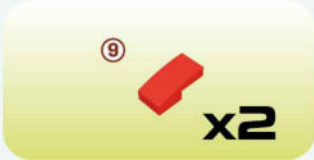
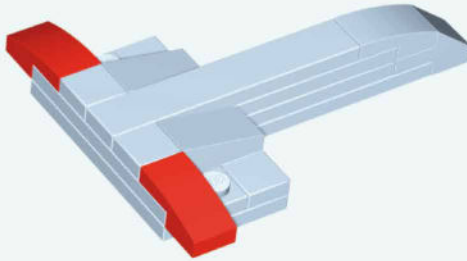

208

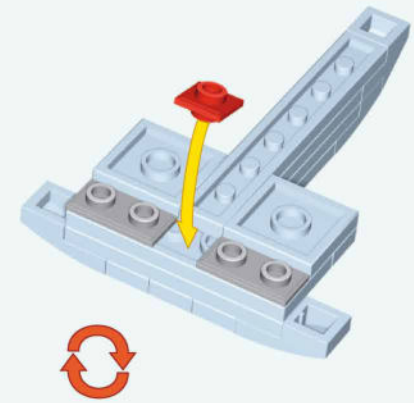

209

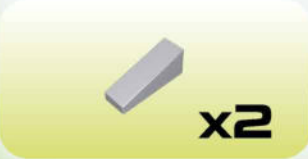
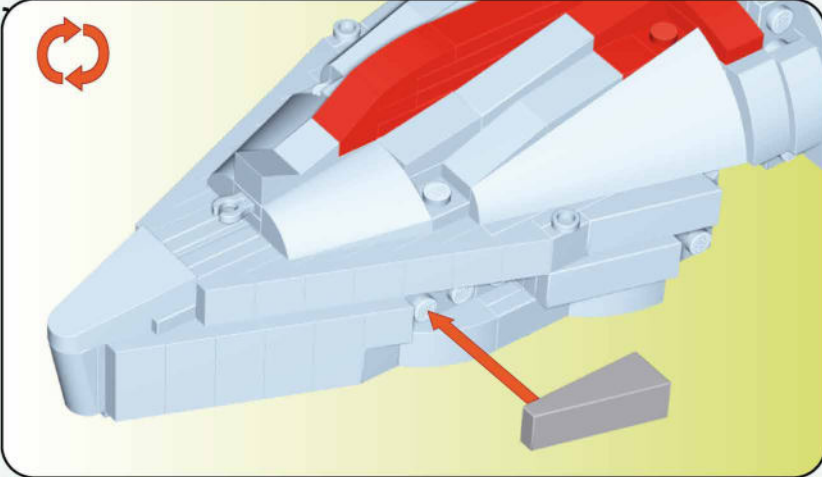
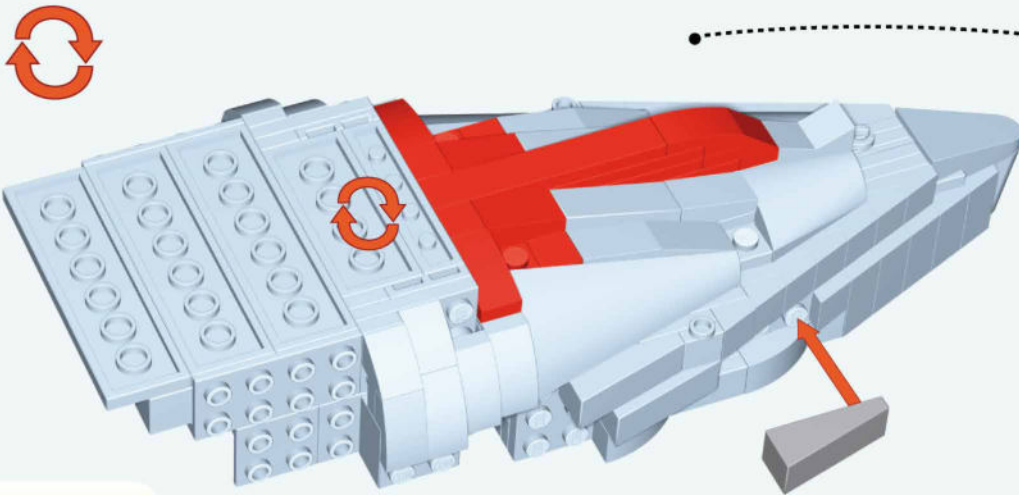

210

211 □ 273

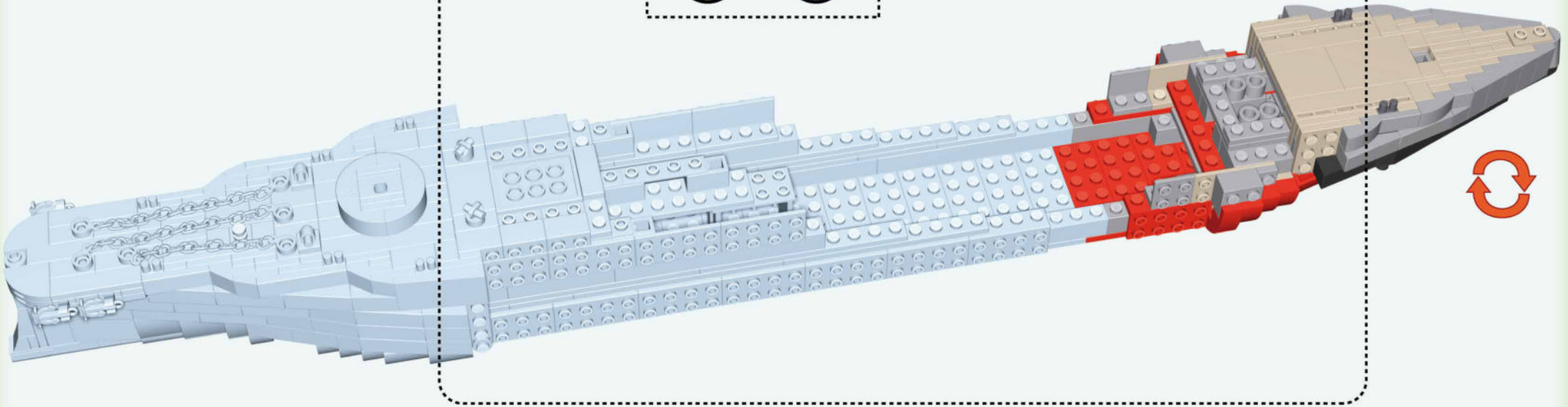

211

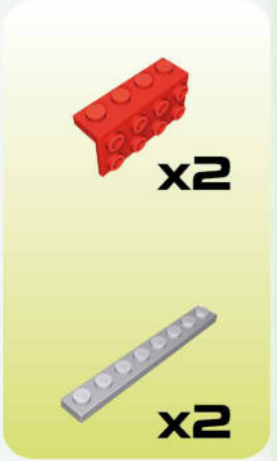
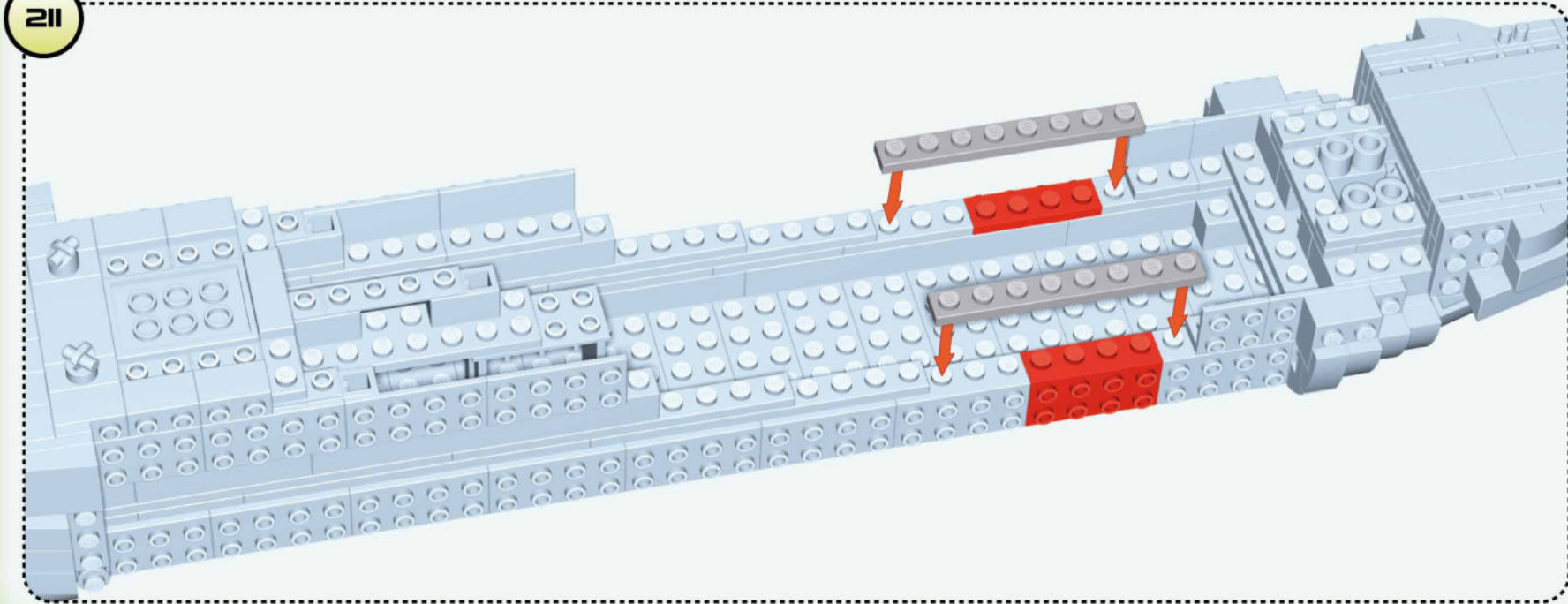

212

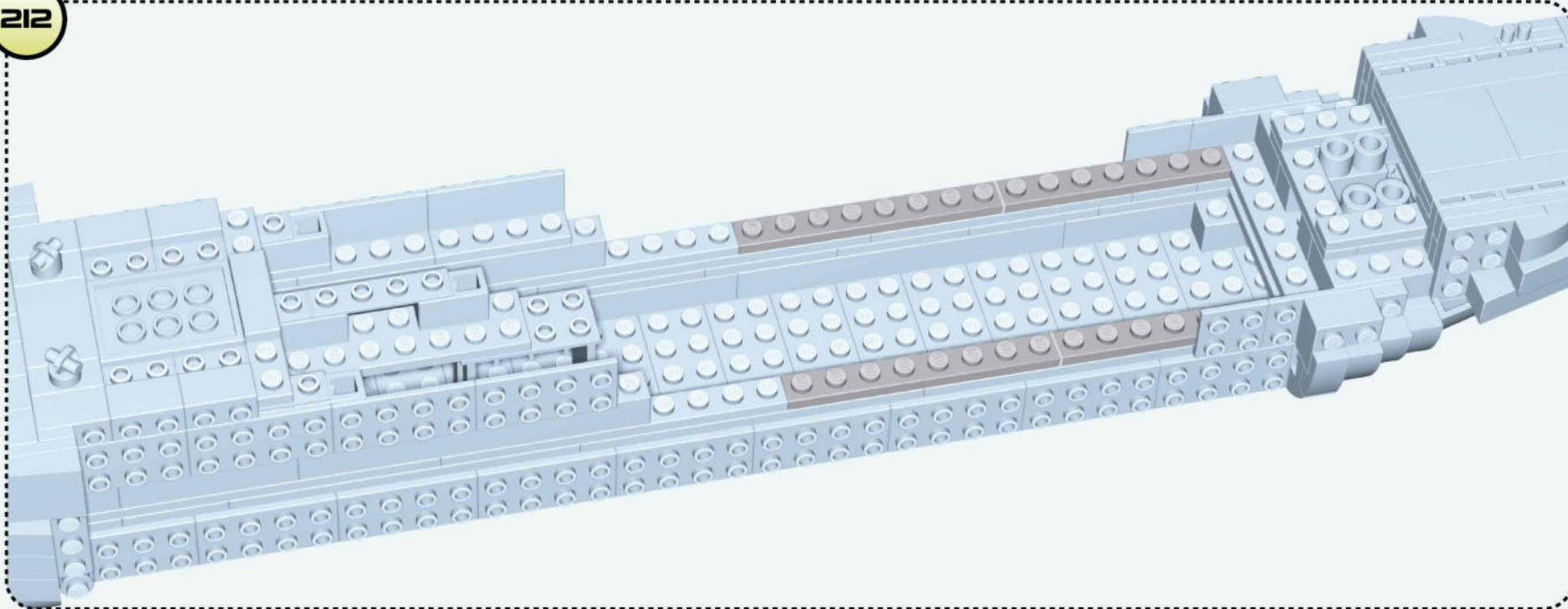

x2



x2

213

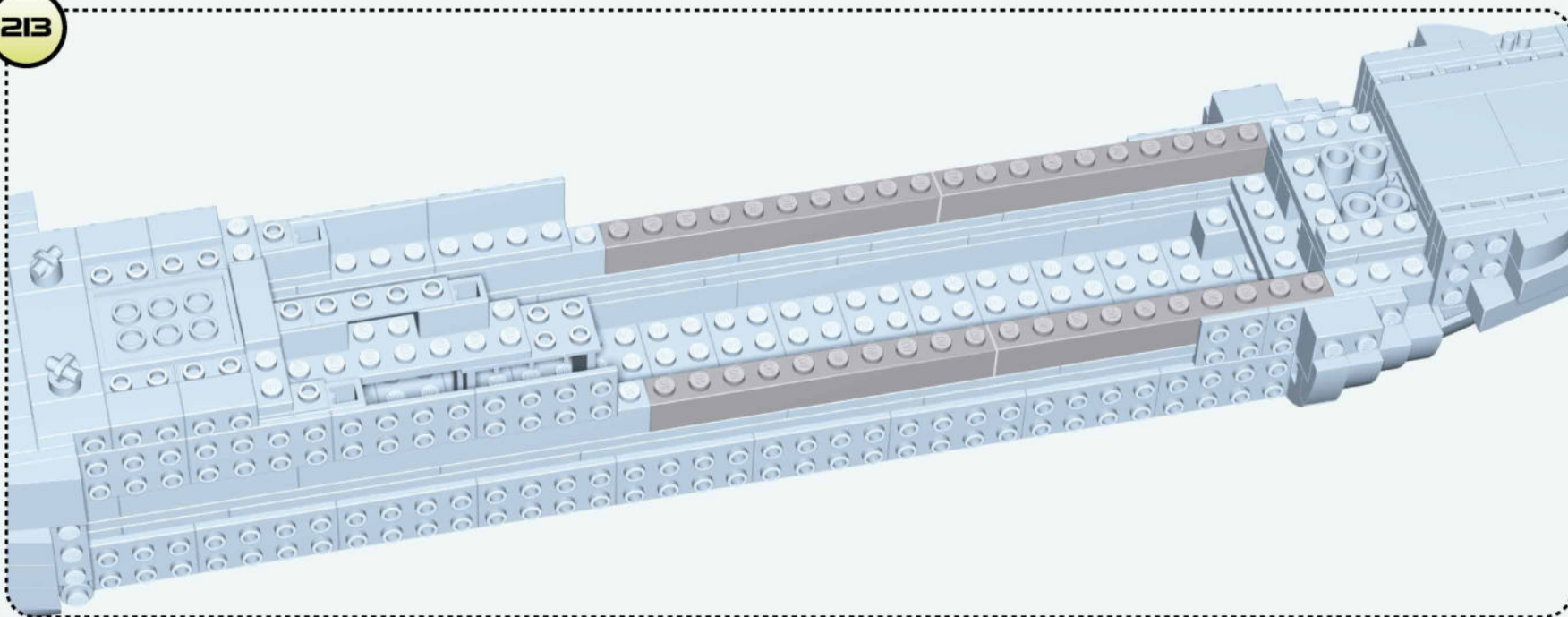

x4

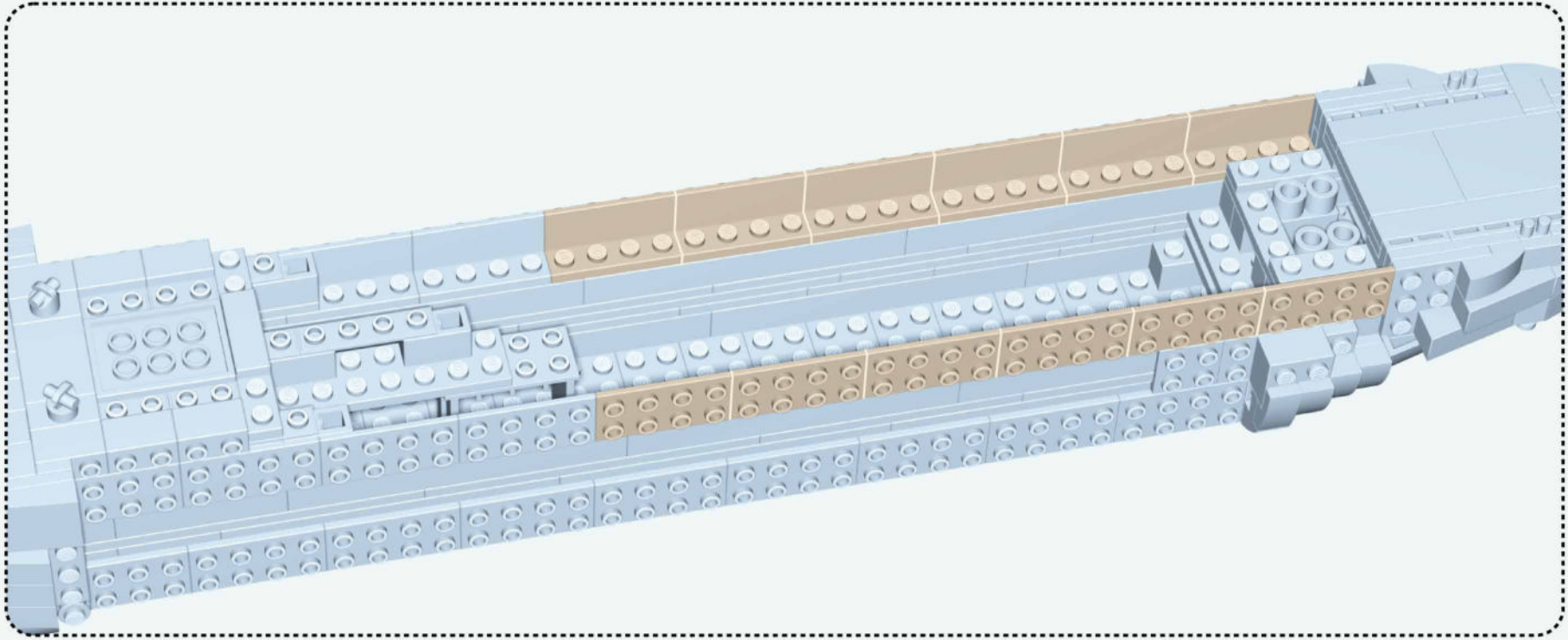

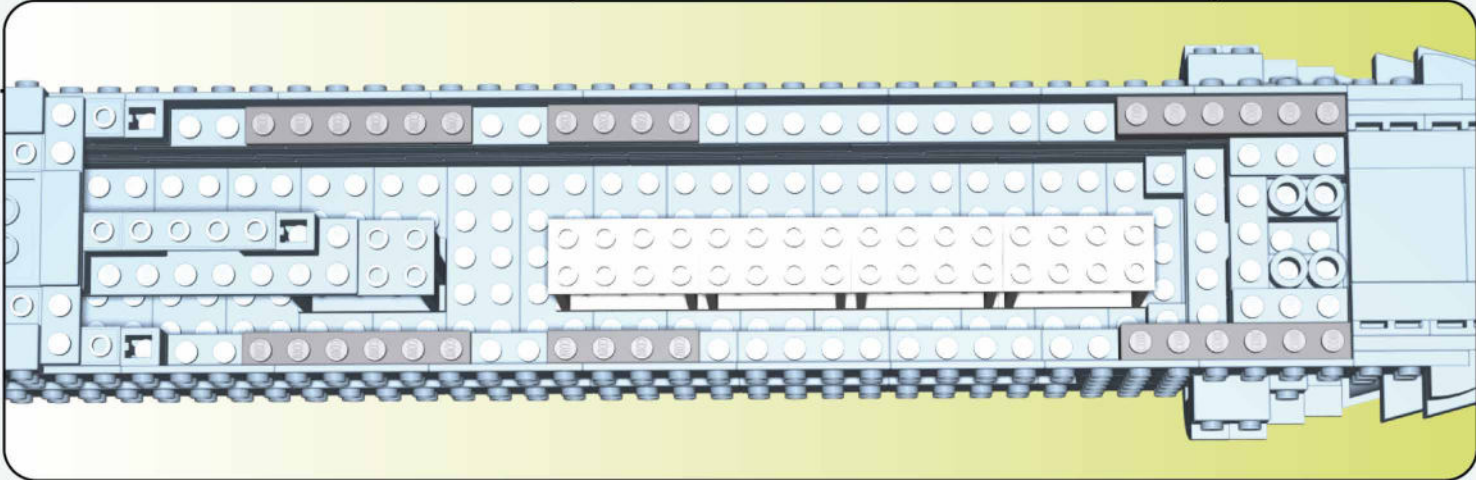
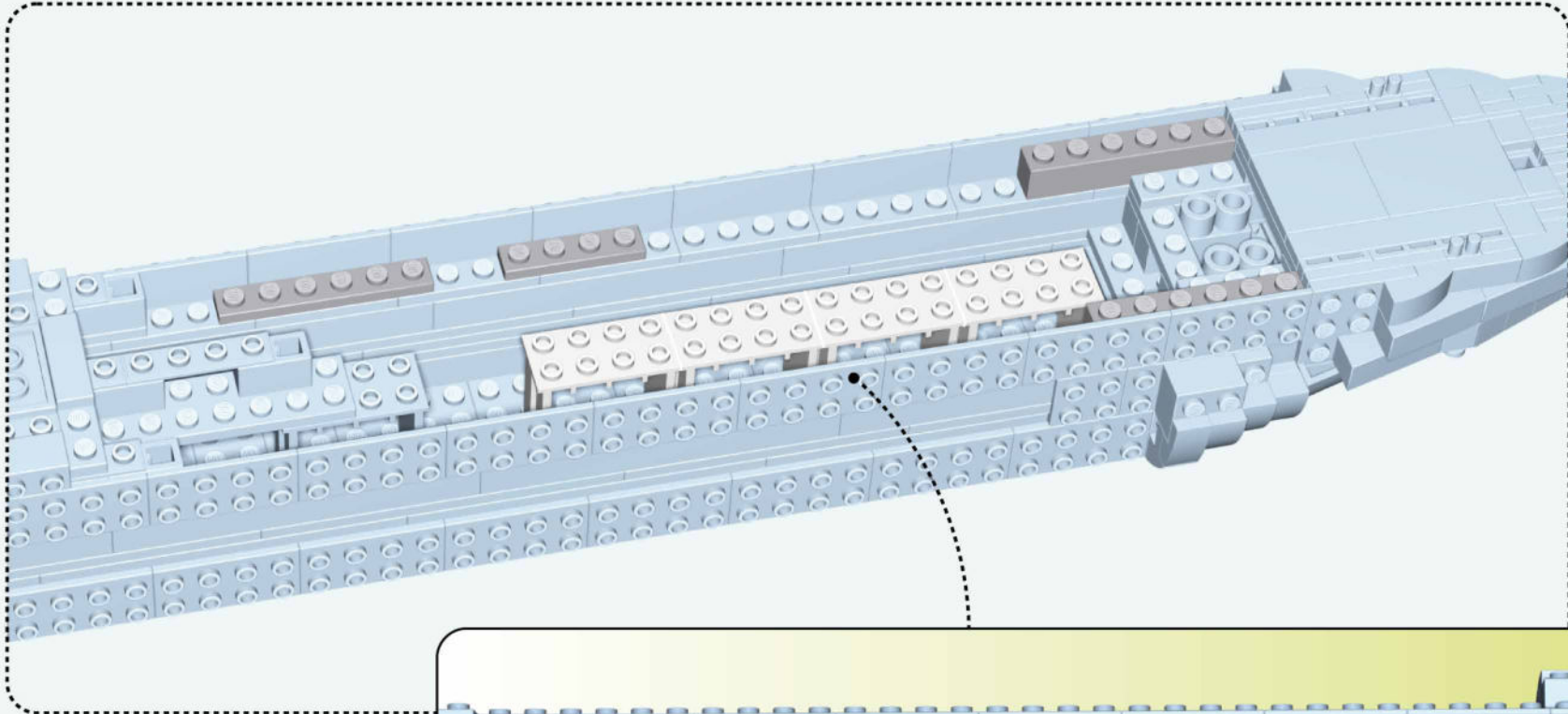

x2



x2



x2



x4

216

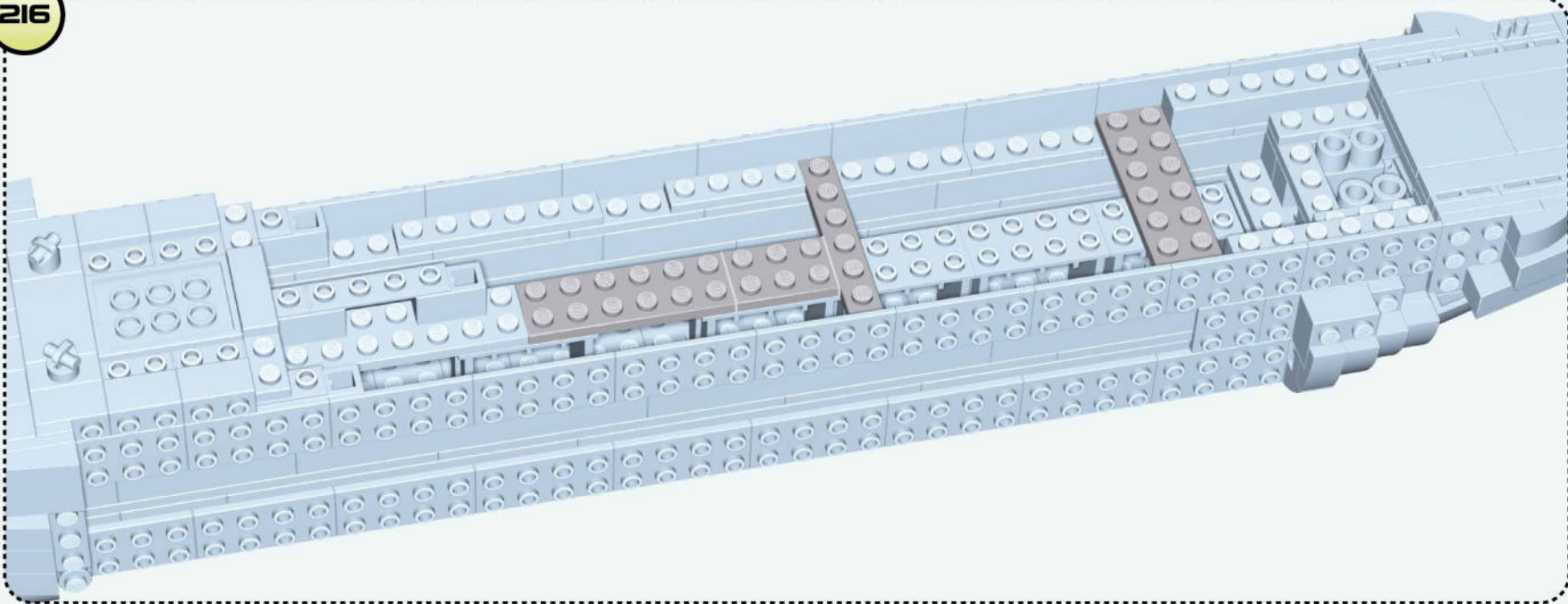

x1



x1



x1



x1

217

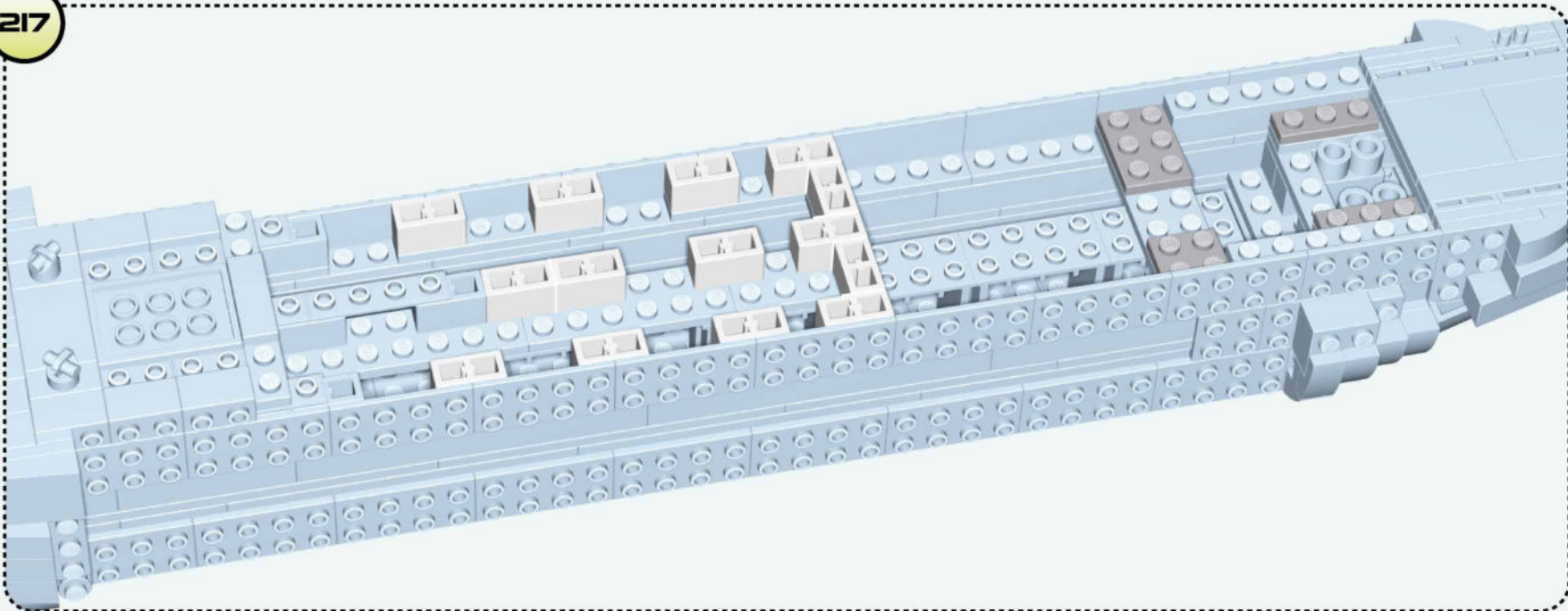

x2



x1



x1



x14

218

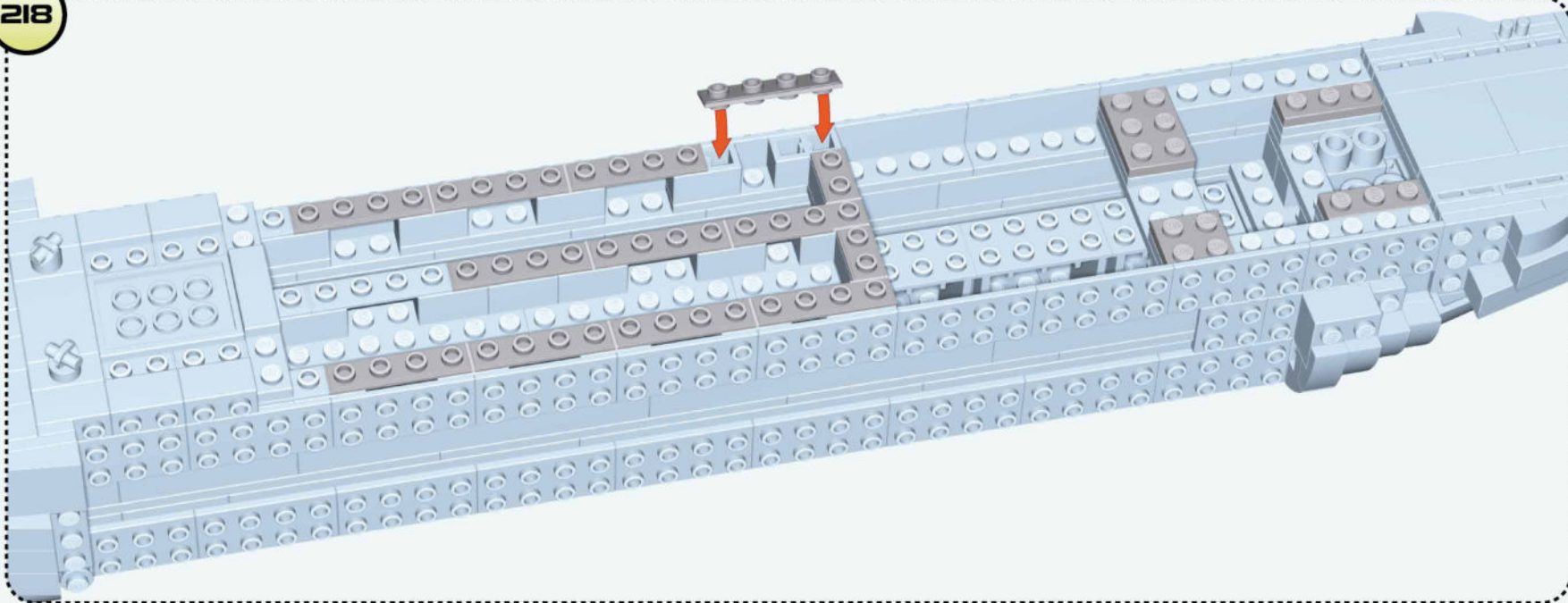

x11



x2



x1



x1



x2

219

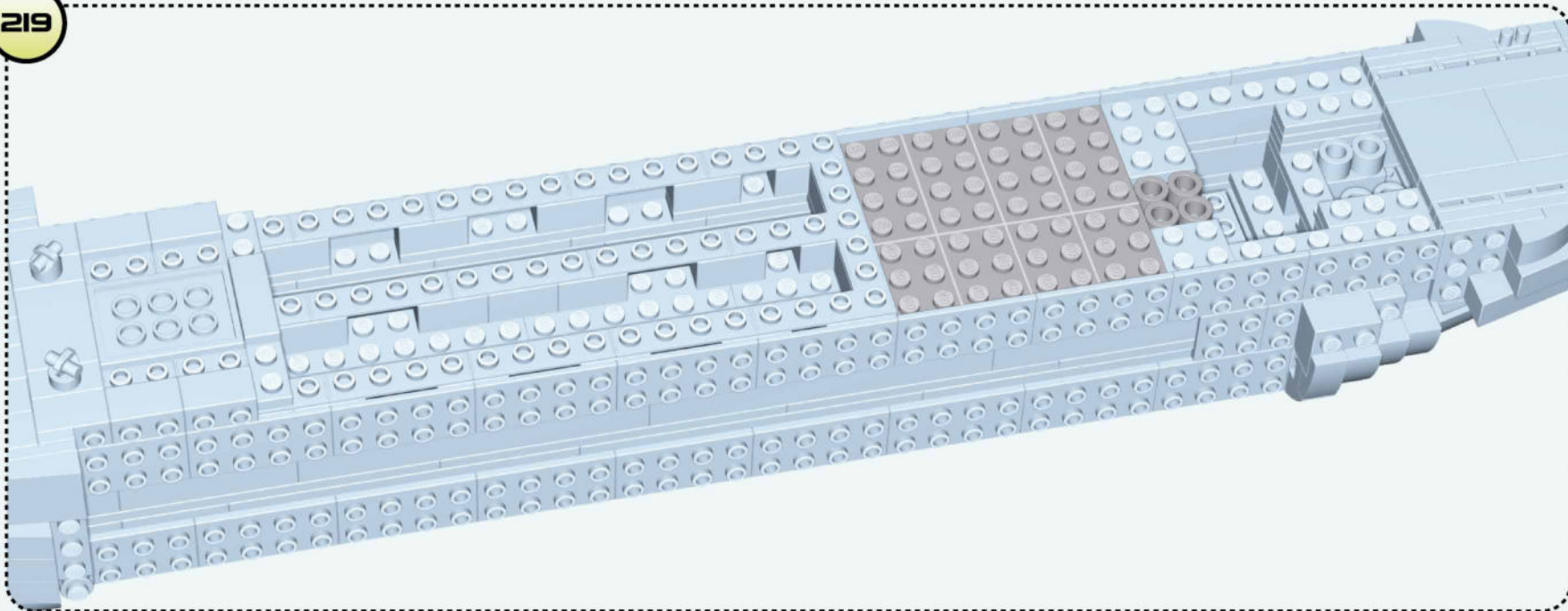

x4



x4



x4

220

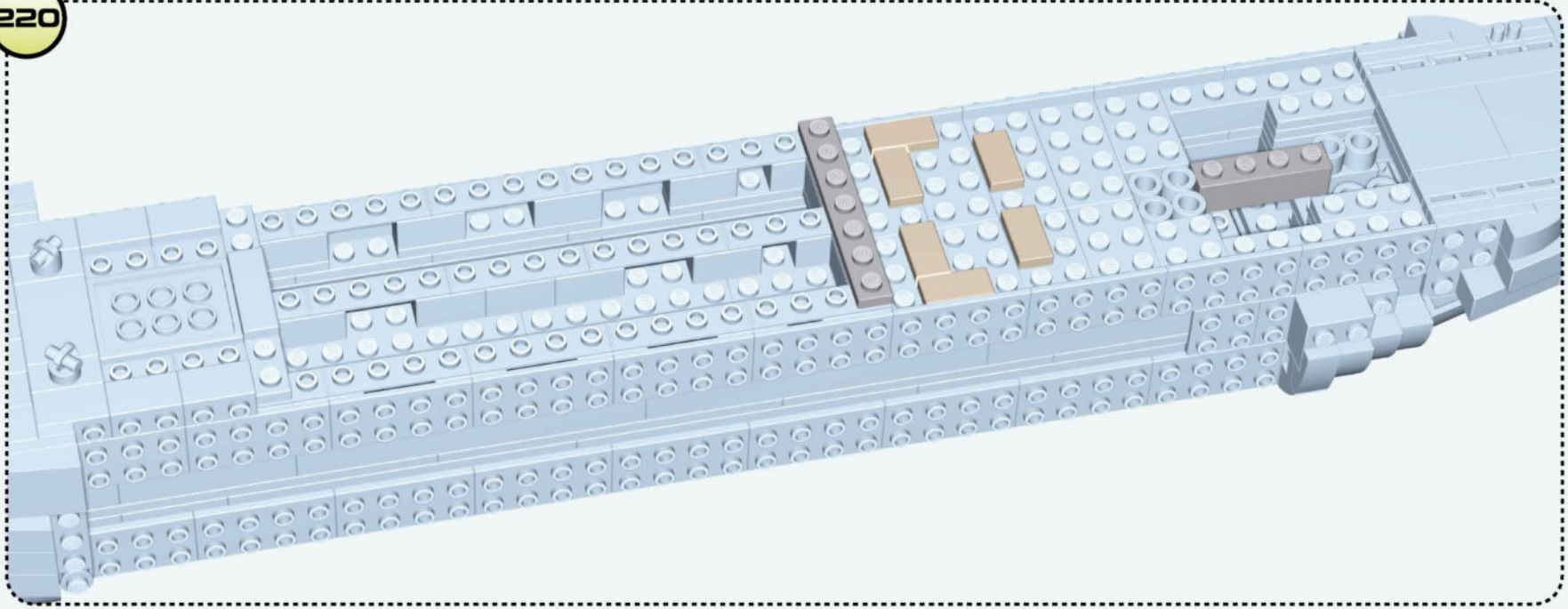

1:1



x1



x6



x1

221

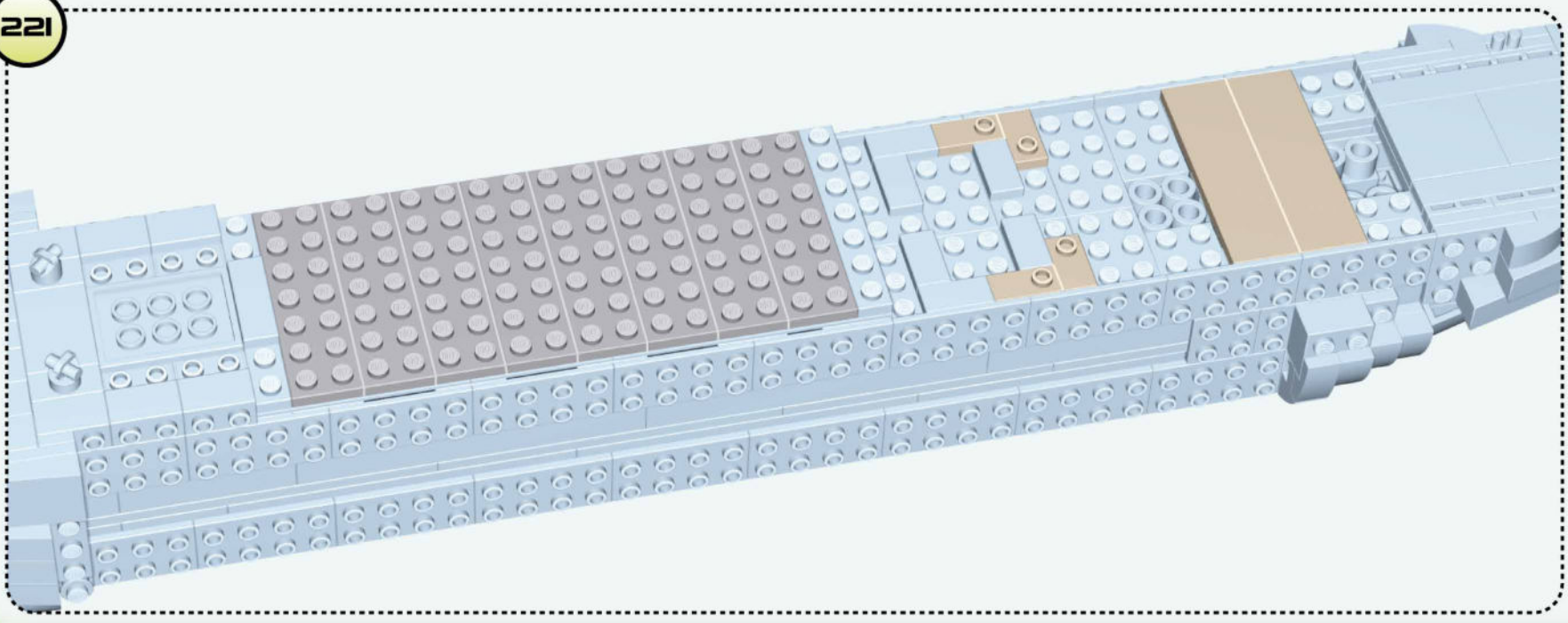

x8



x4

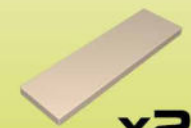

x2

222

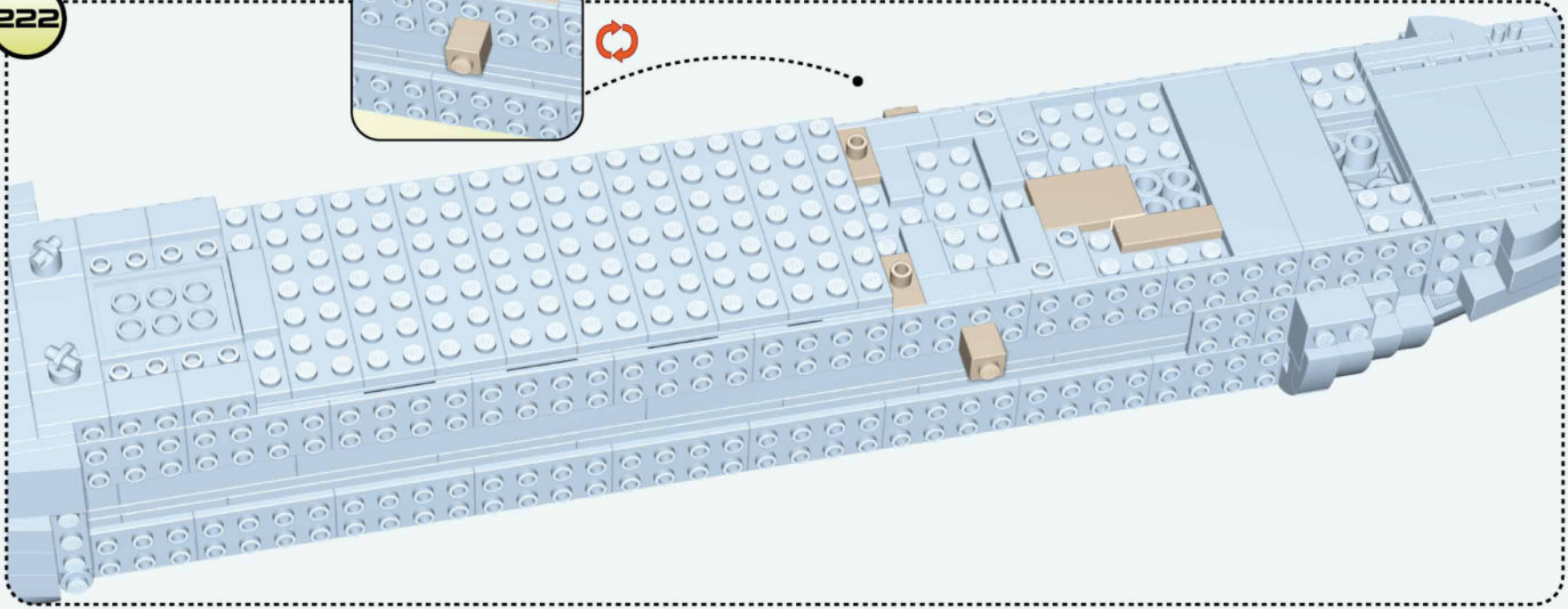
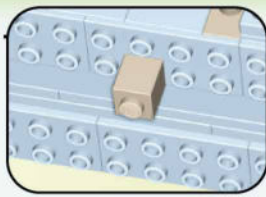

 x2

 x2

 x1

1:1

 x1

223

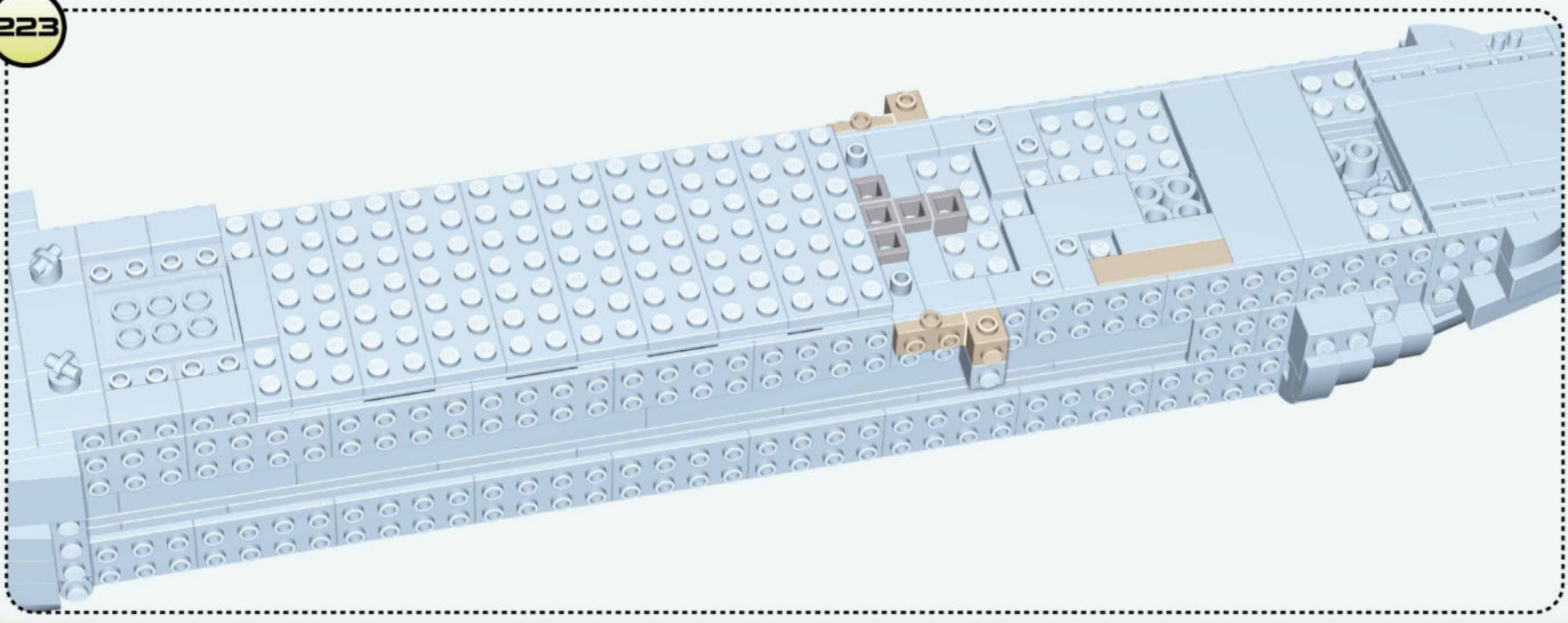

 x2

 x2

 x5

1:1

 x1

226

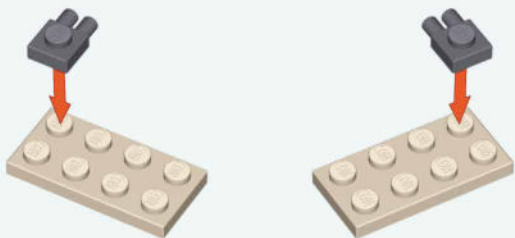

x2



x2

227

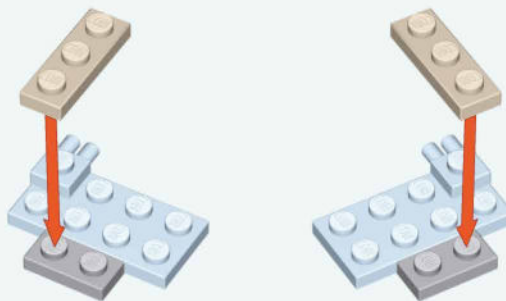

x2



x2

228



x2



x2

229



x2

230

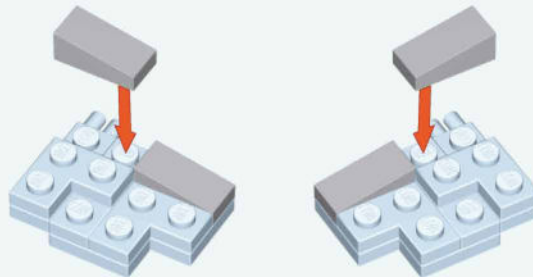

15



x4

231

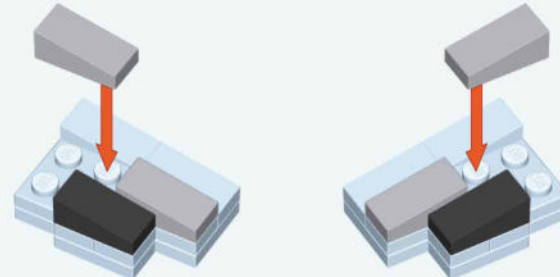

15



x4

15



x2

232



233

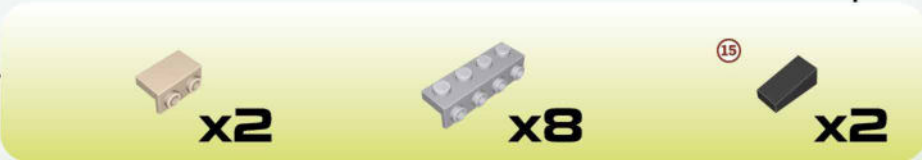
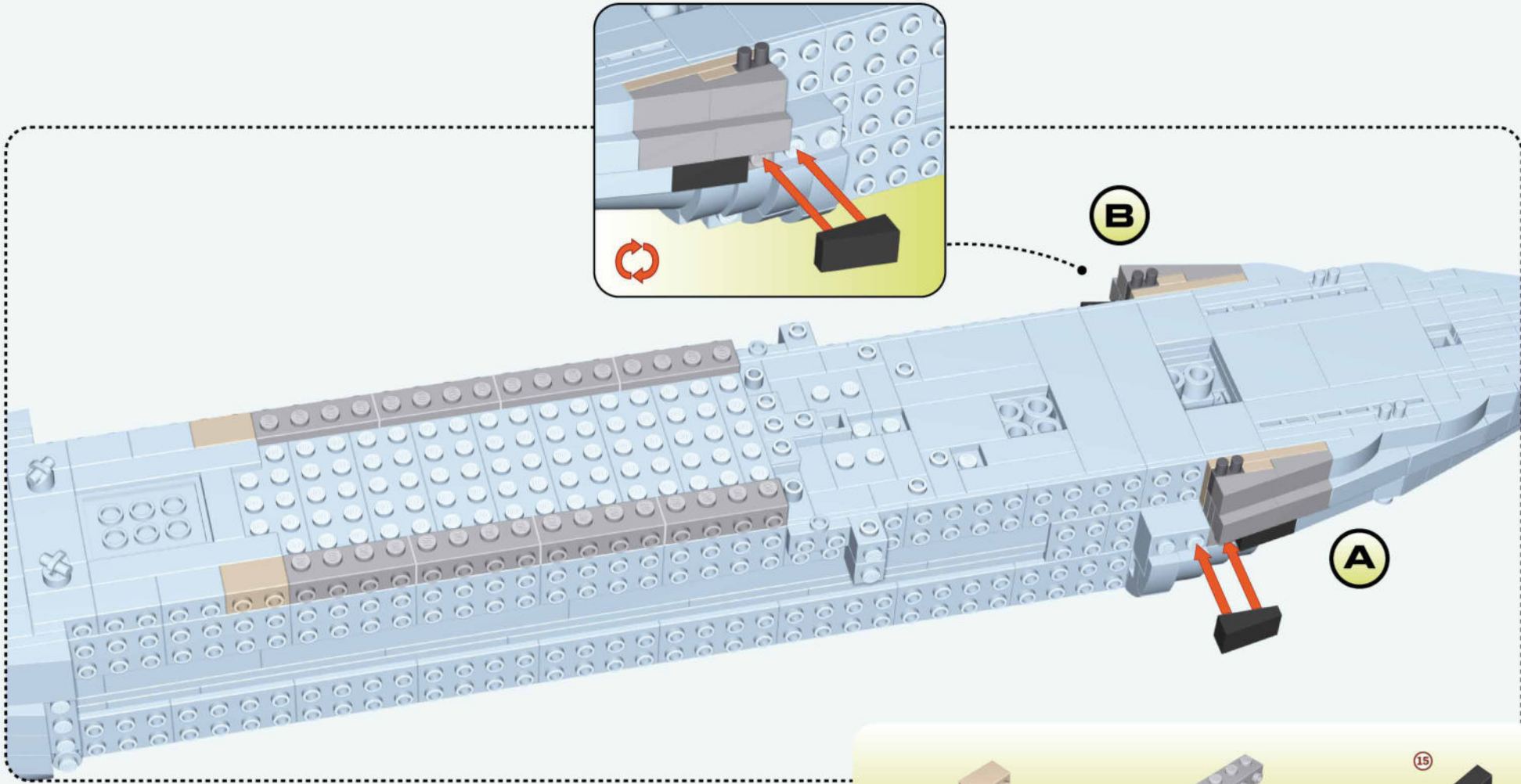



HISTORICAL COLLECTION



BATTLESHIP MISSOURI (BB-63)

 4837



BATTLESHIP TIRPITZ

 4839





HISTORICAL COLLECTION



BATTLESHIP YAMATO



HMS HOOD



WWW.COBI.EU

00-04842/1-2087

For news and special deals

Find us on:

