

HISTORICAL COLLECTION

WORLD WAR II

VICKERS WELLINGTON MK II

PLACE OF ORIGIN - UNITED KINGDOM
 IN RAF SERVICE - 1939 - 1945
 ROLE - MEDIUM BOMBER
 CREW - 6
 WINGSPAN - 26,27M (86' 2")
 LENGTH - 19,69M (64' 7")
 HEIGHT - 5,31M (17' 5")
 WEIGHT - 8435KG (18,556LB)
 ENGINE - 2x BRISTOL PEGASUS XVIII, 2x 1050HP (780KW)
 RANGE - 4106KM (2,558MI)
 RATE OF CLIMB - 5,7M/S (1,120FT/MIN)
 MAXIMUM FLIGHT LEVEL - 5490M (18,000FT)
 SPEED - 378KM/H (235MPH)
 ARMAMENT - 8x 7,7MM (.303") BROWNING GUNS,
 2040KG (4,500LB) BOMBS



**PAD PRINTED
NO STICKERS**

Printed in EU 5723



WARNING: CHOKING HAZARD-
 Toy contains small parts.
 Not for children under 3 years.

1162 **2**

VICKERS WELLINGTON MKII

SCALE 1:37



BE CAREFUL: NOTICE THE DIFFERENCE

A **B**

UWAGA: RÓŻNE KLOCKI

1

x2	x1
x2	x1

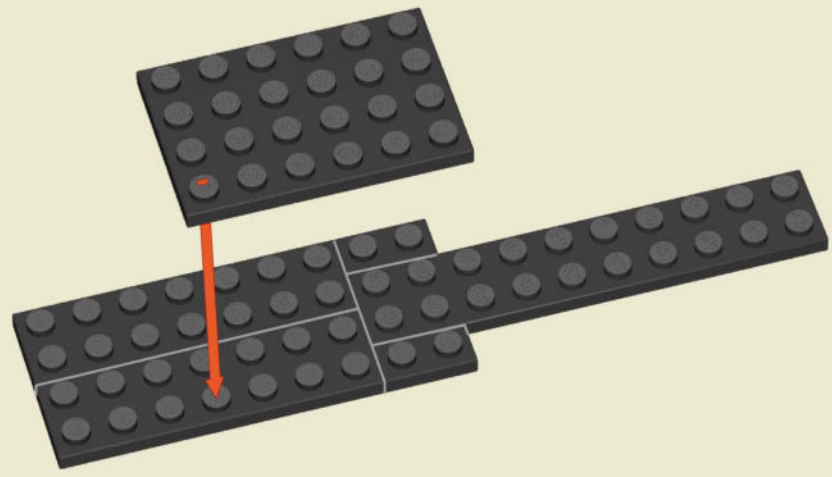

2

x1	x1
x1	x2

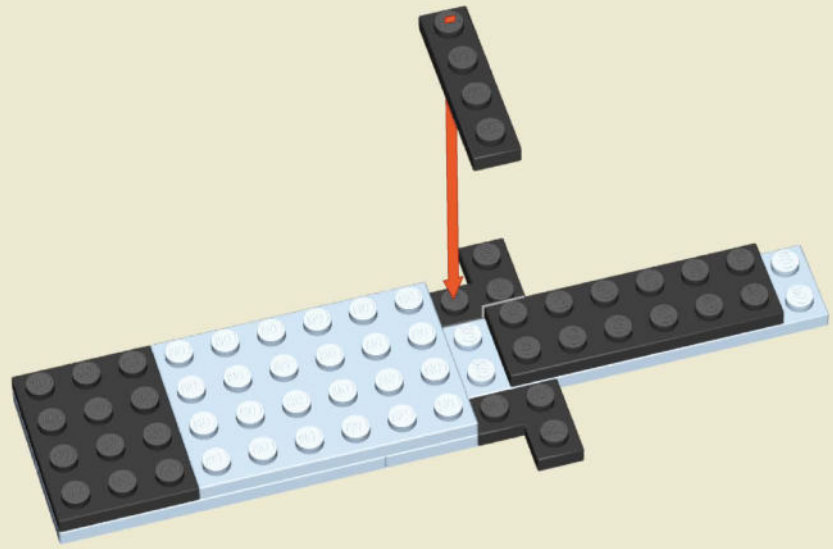

3

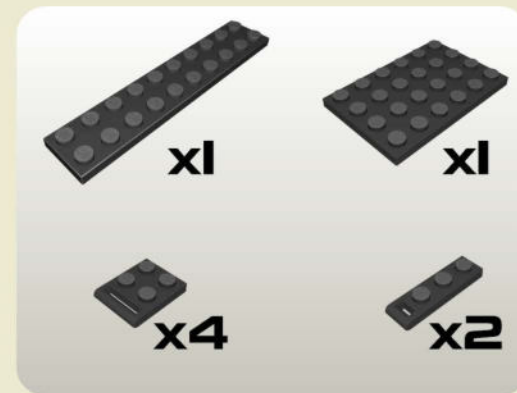
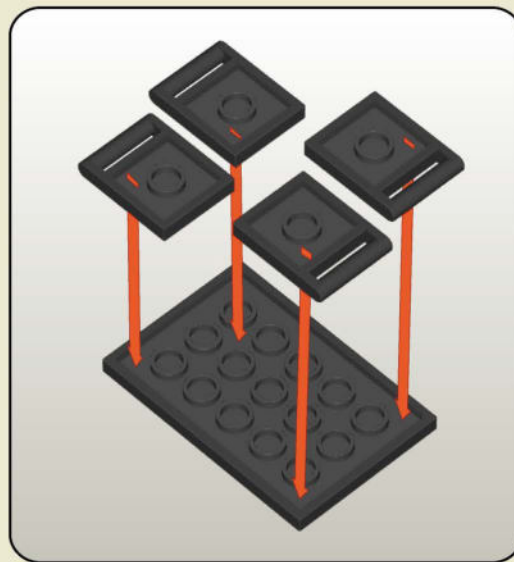
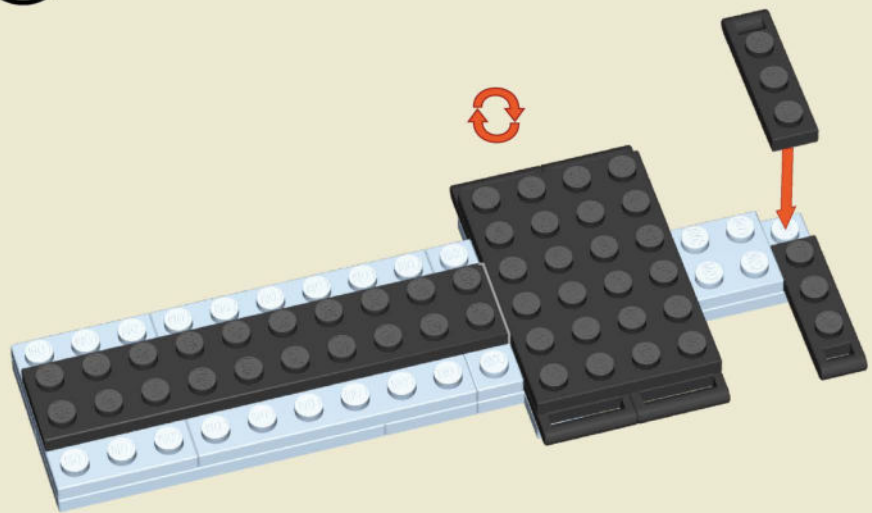

4

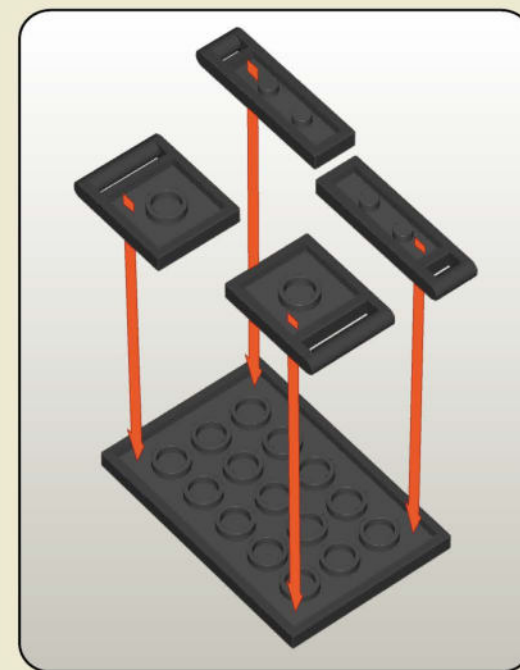
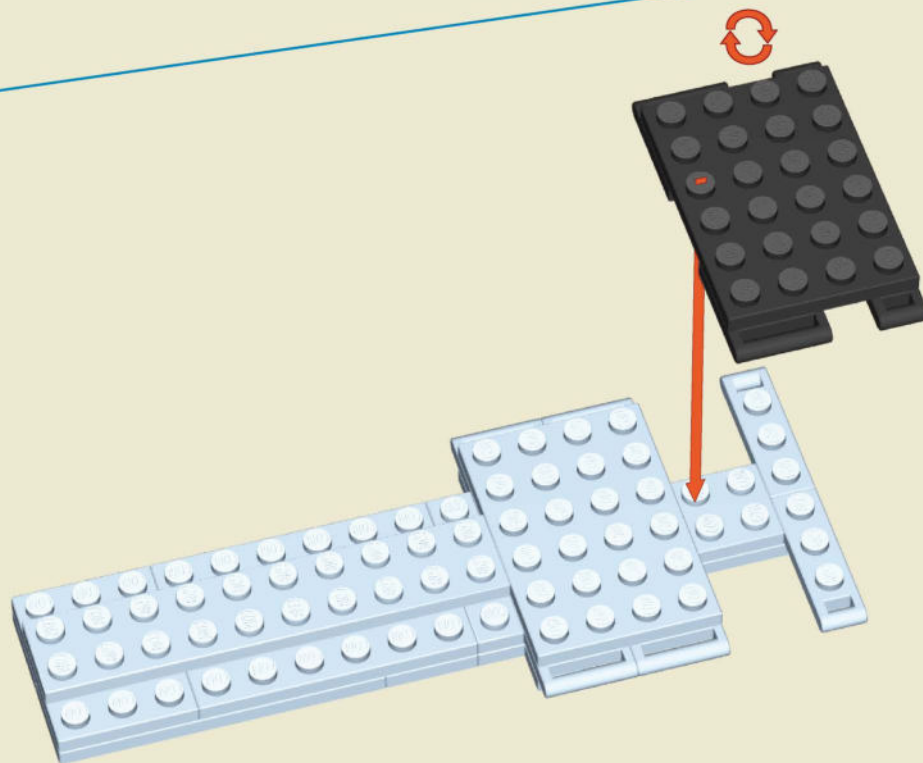
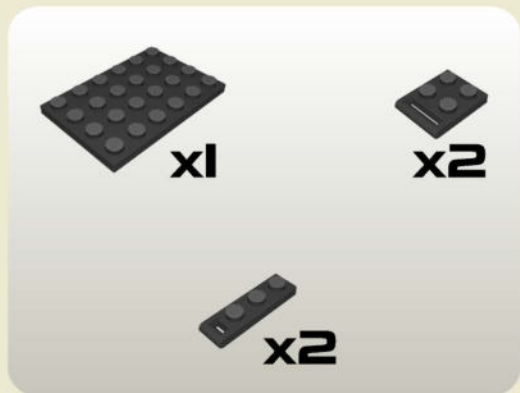

5

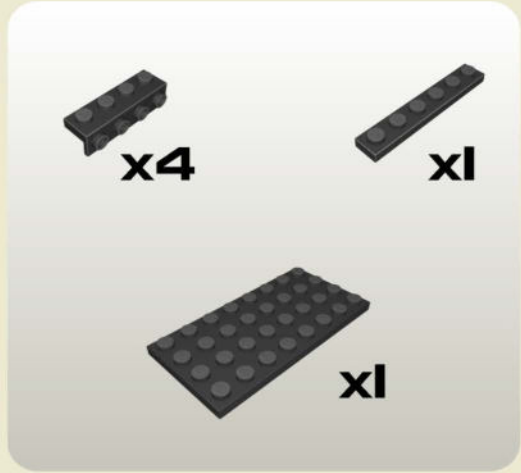
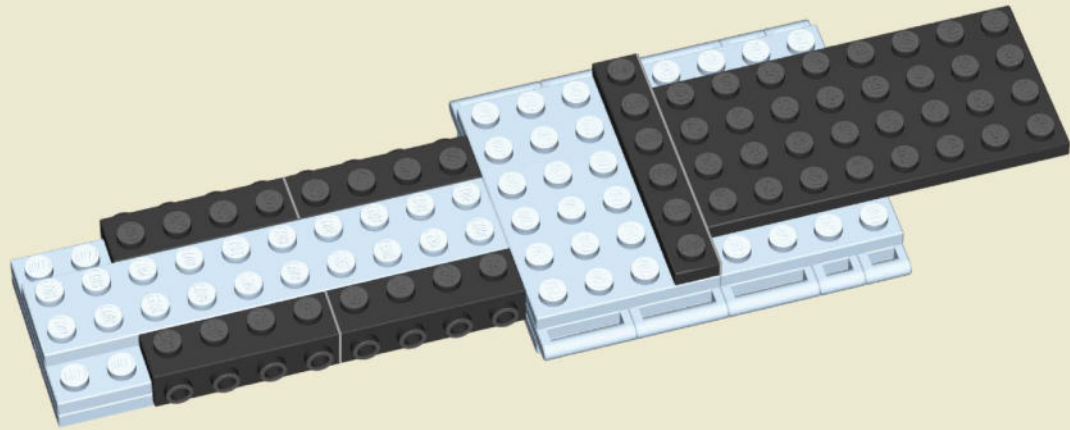

6

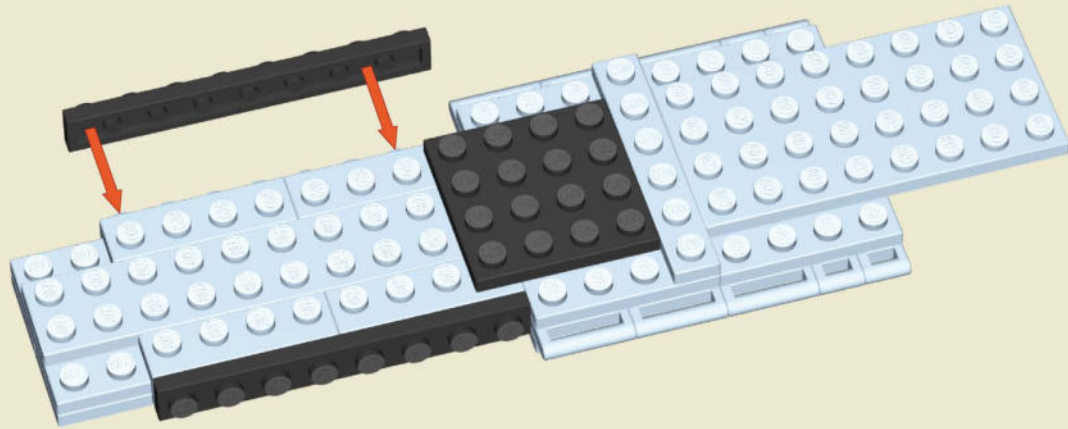
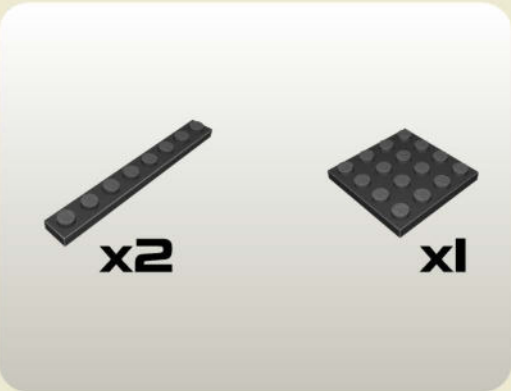

7

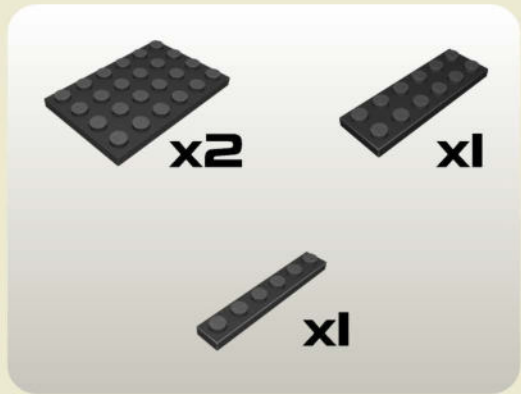
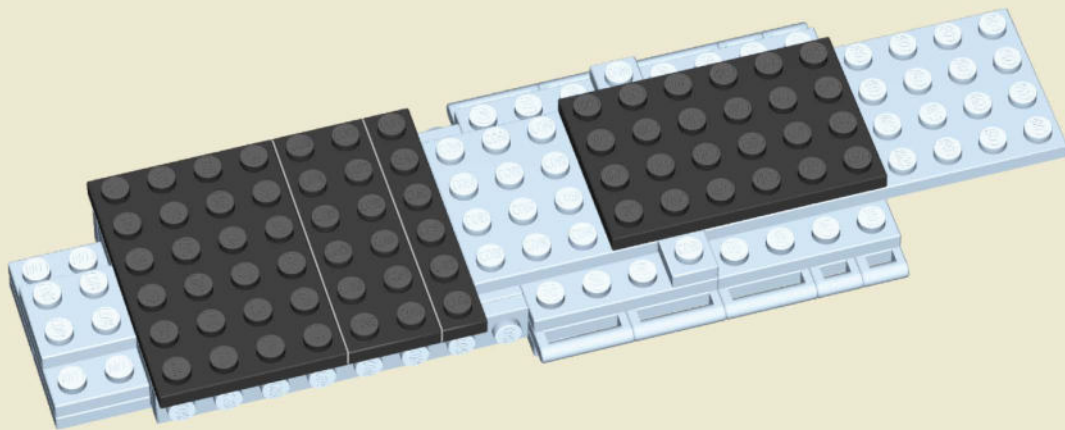

8

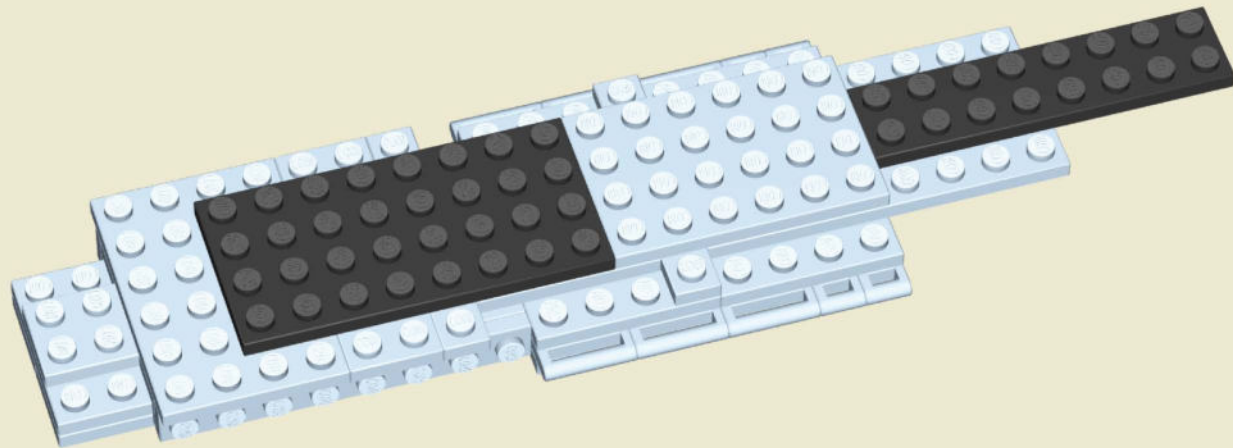
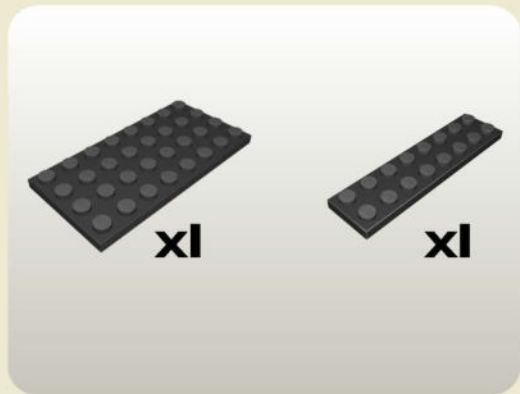

9

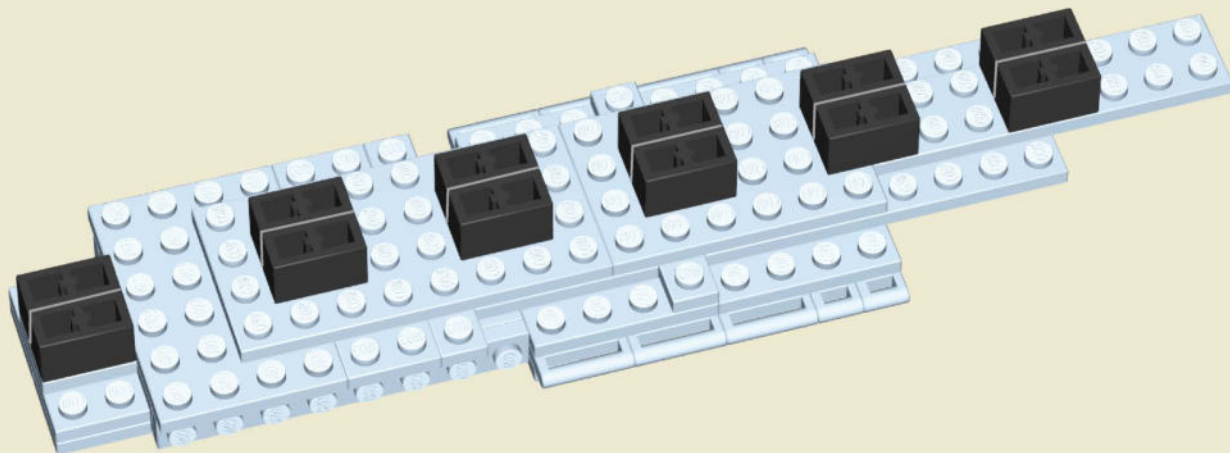

10

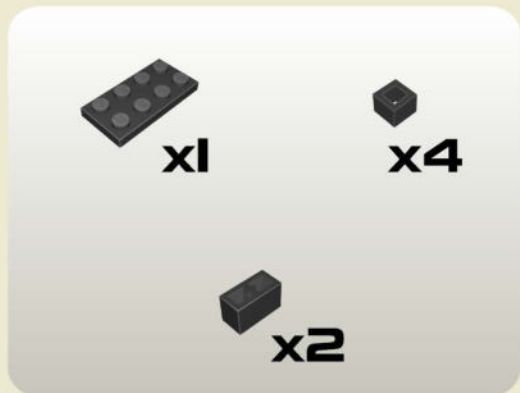
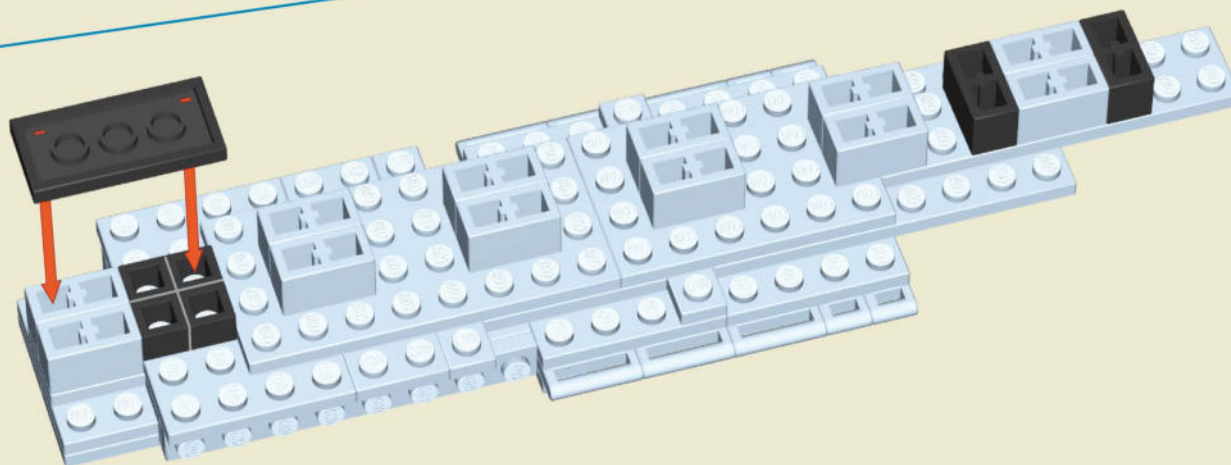

11

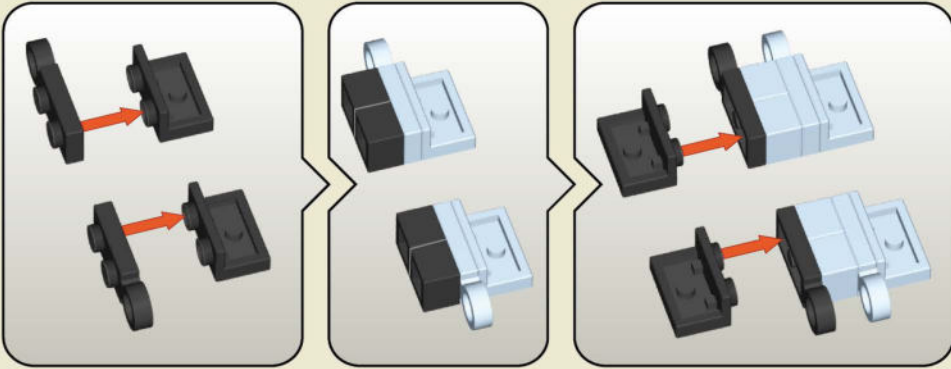
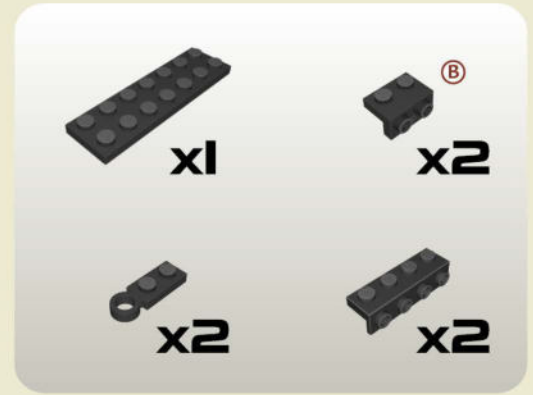
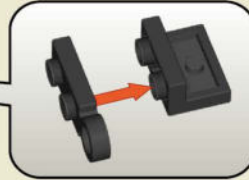
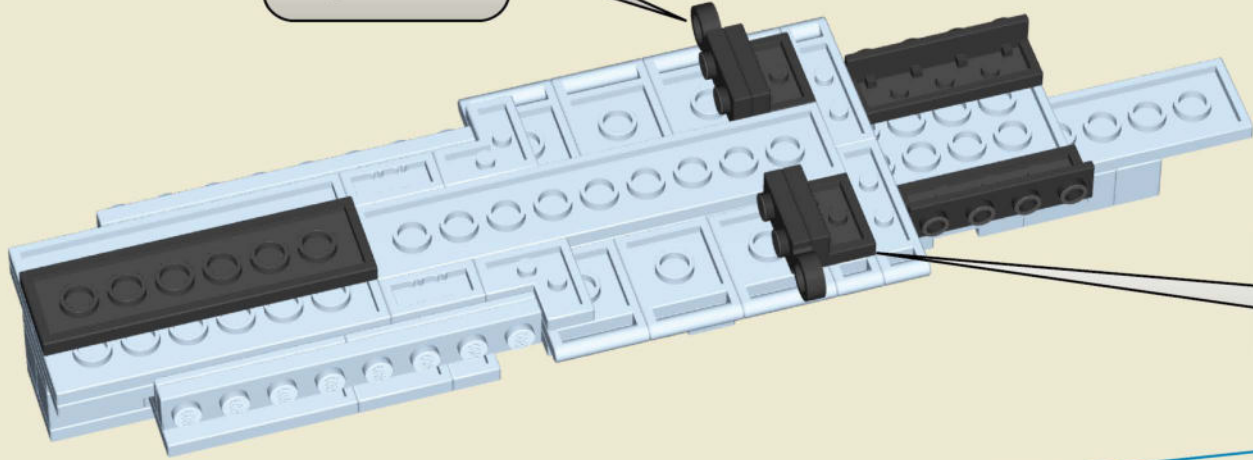
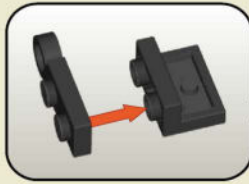

12

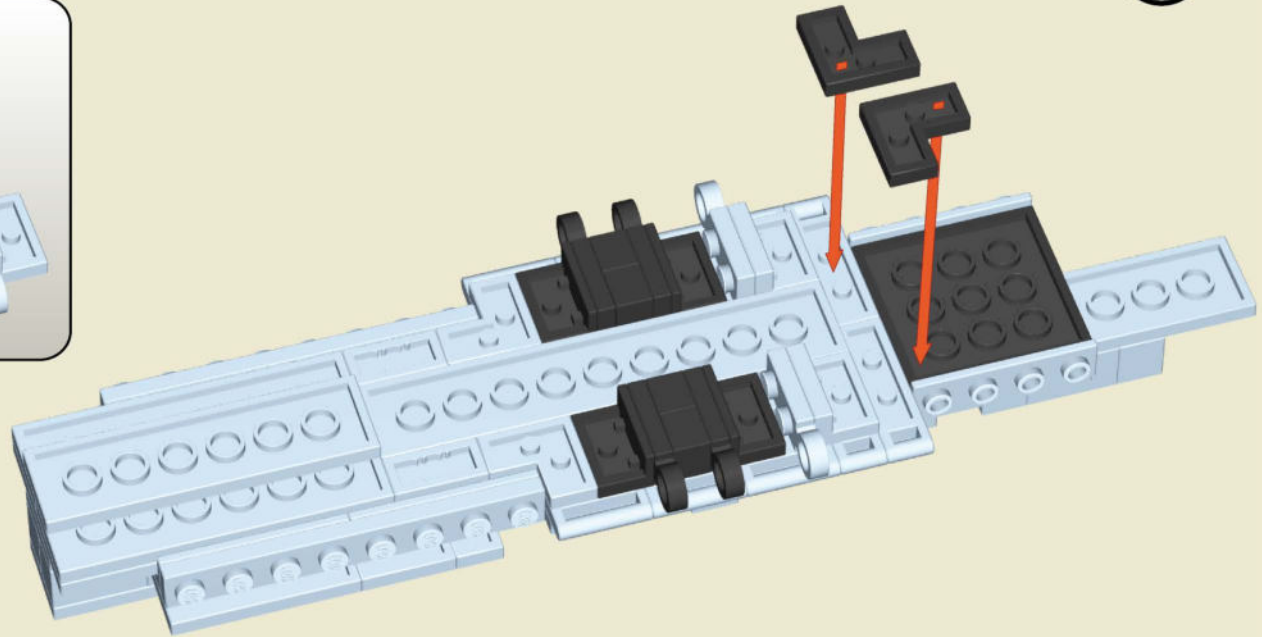

13

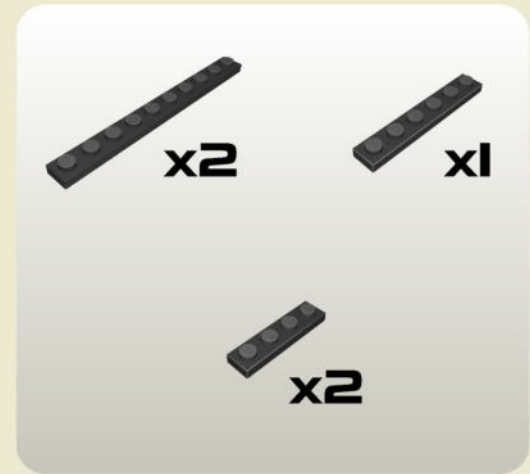
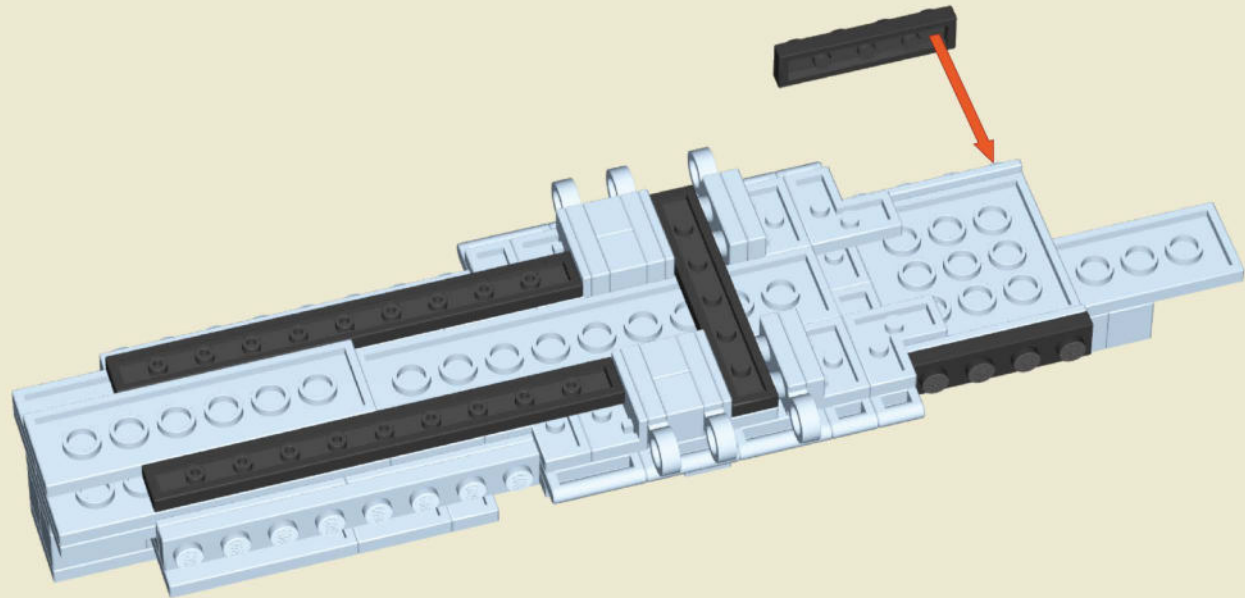

14

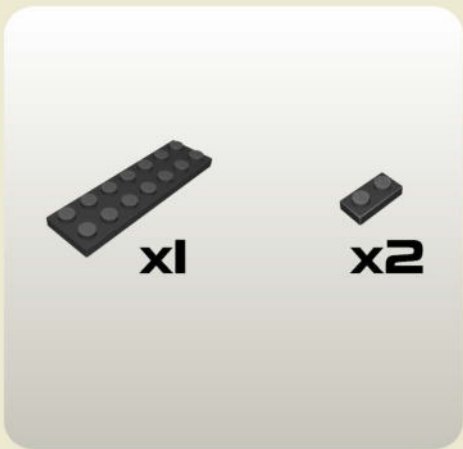
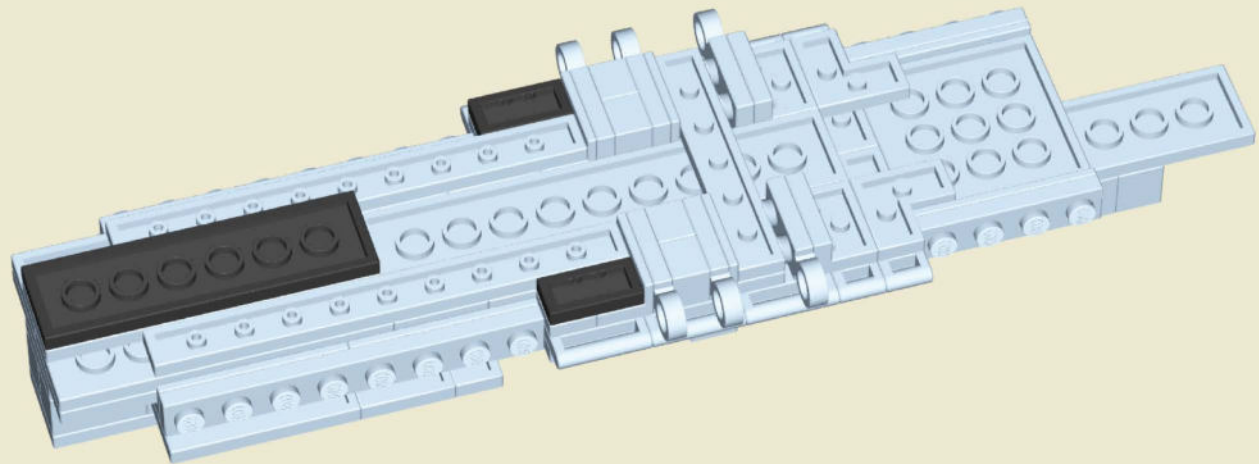

15

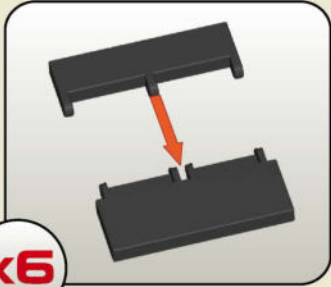
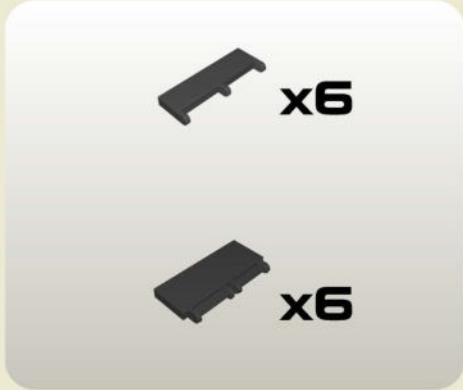
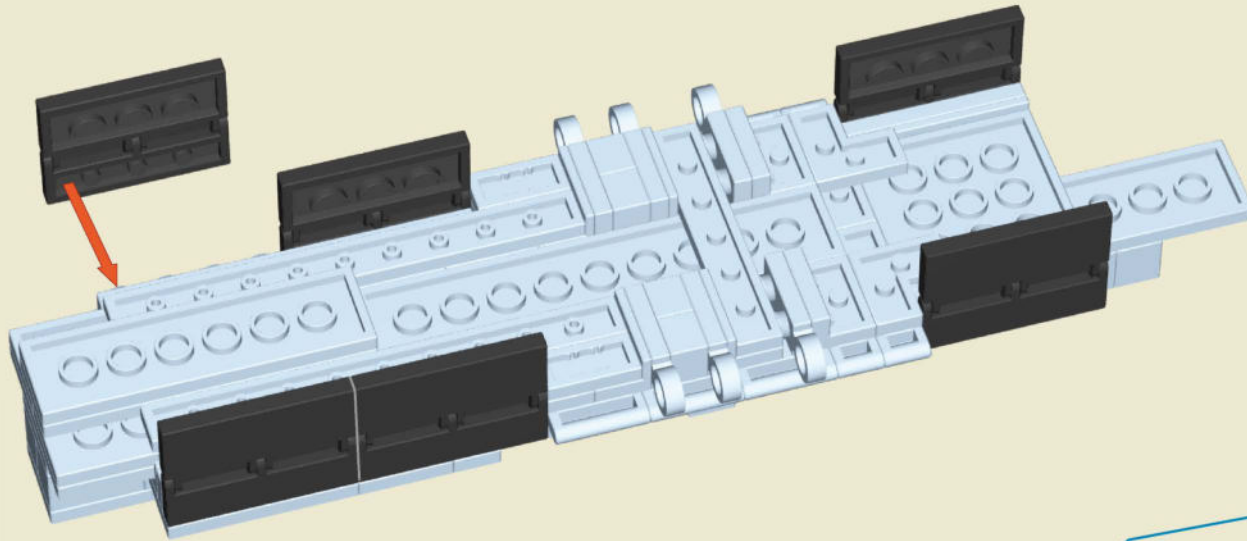

x6

16

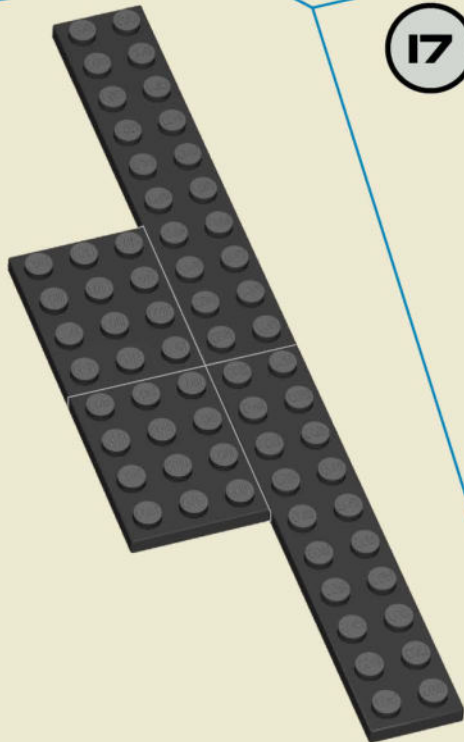
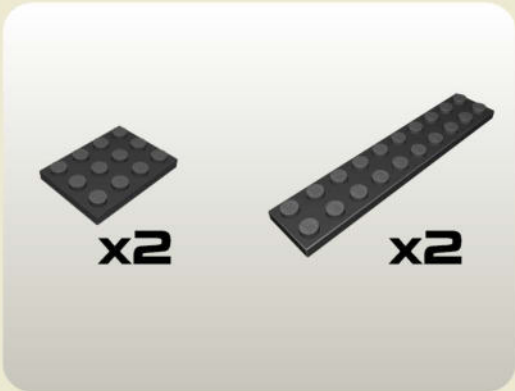

17

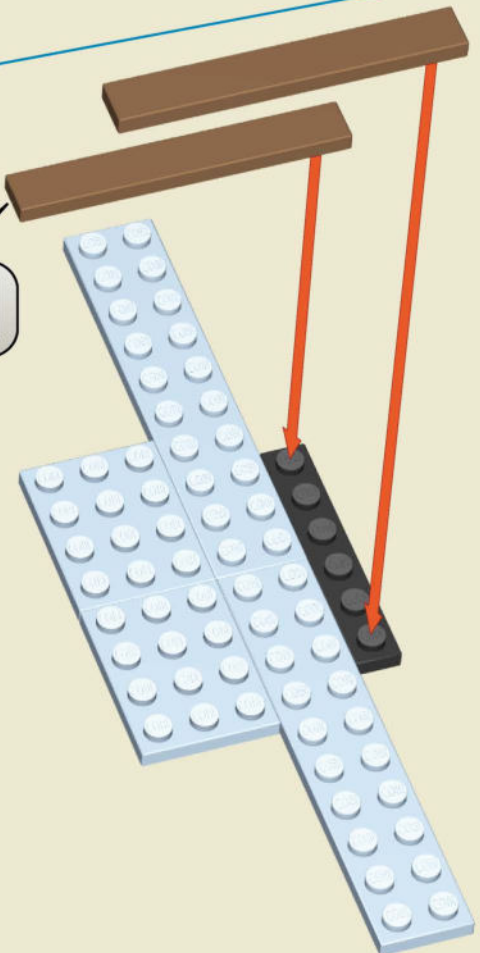
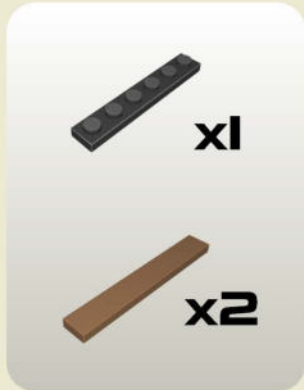

18

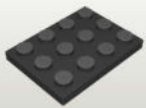
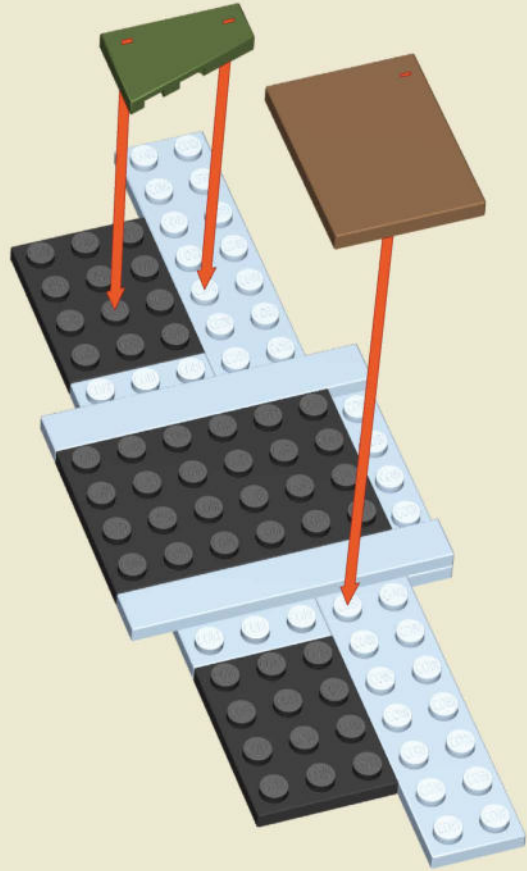

x2



x1

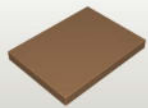

x1



x1

19

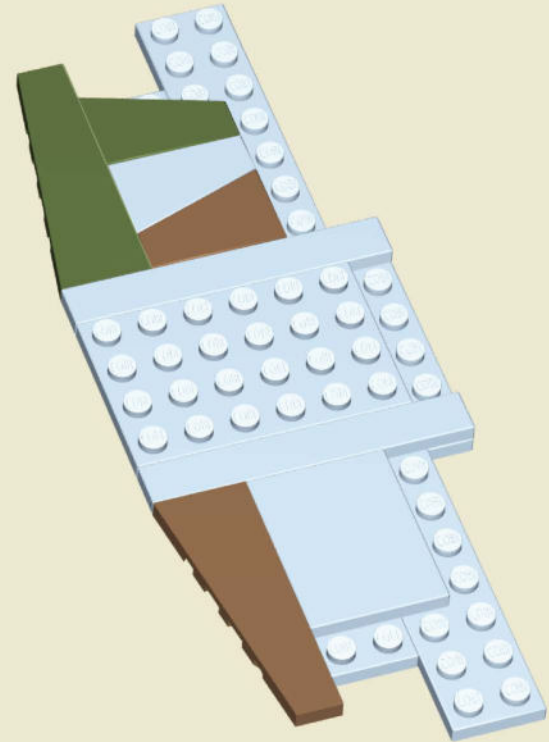

x1



x1



x1



x1

20

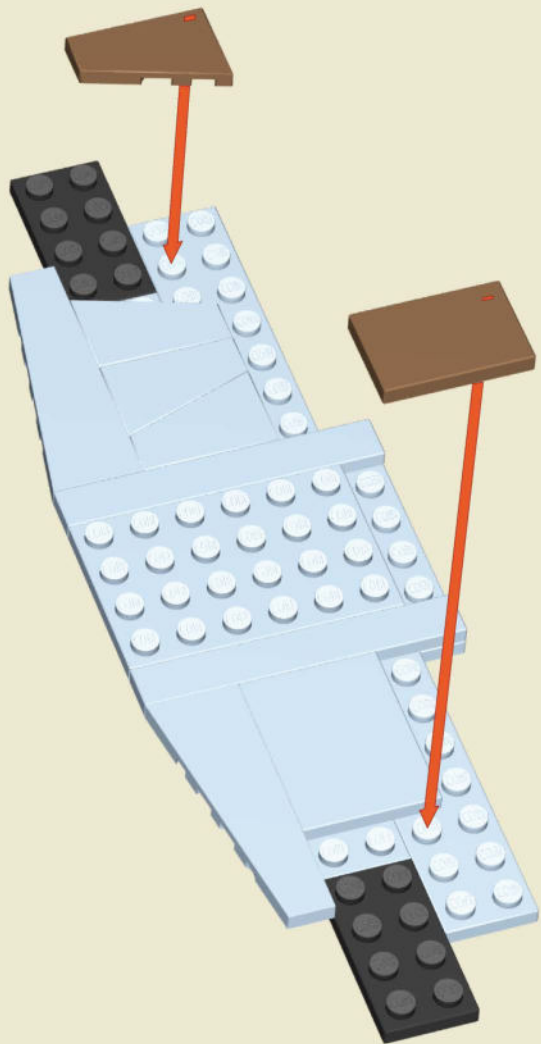

x2



x1



x1

21

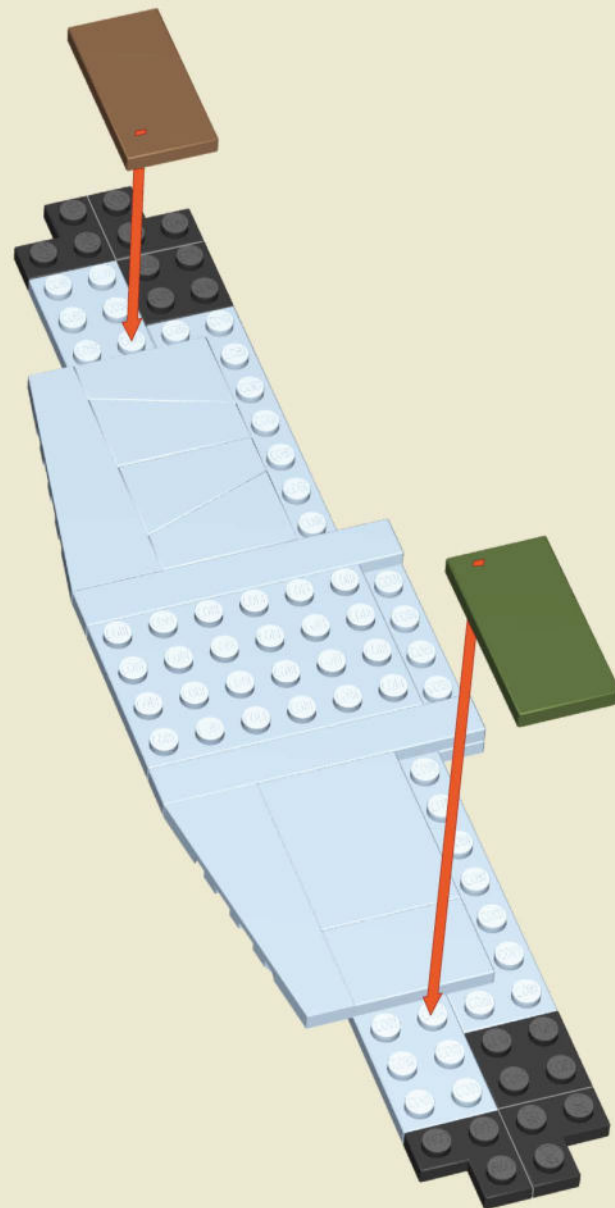

x4



x2



x1



x1

22

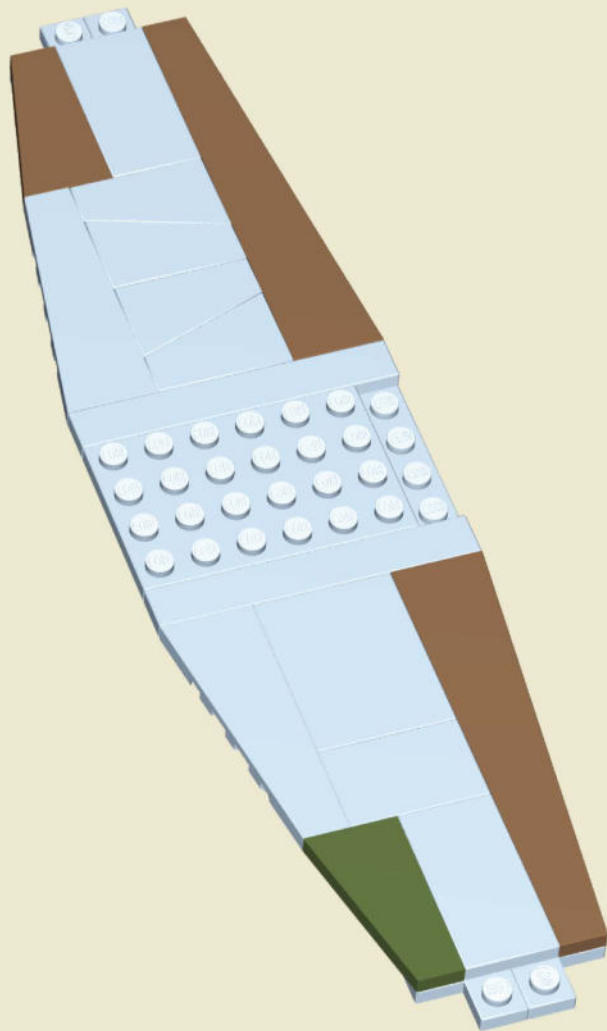

23

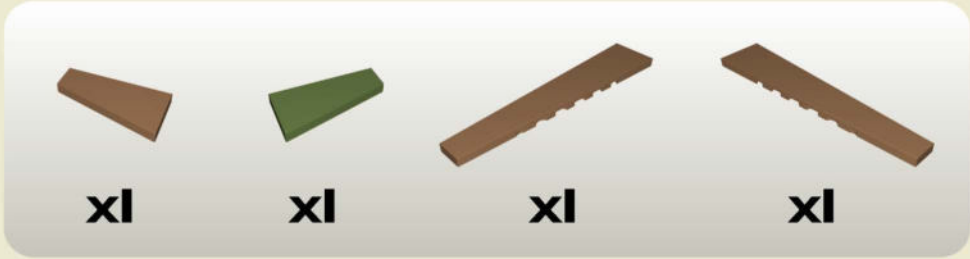
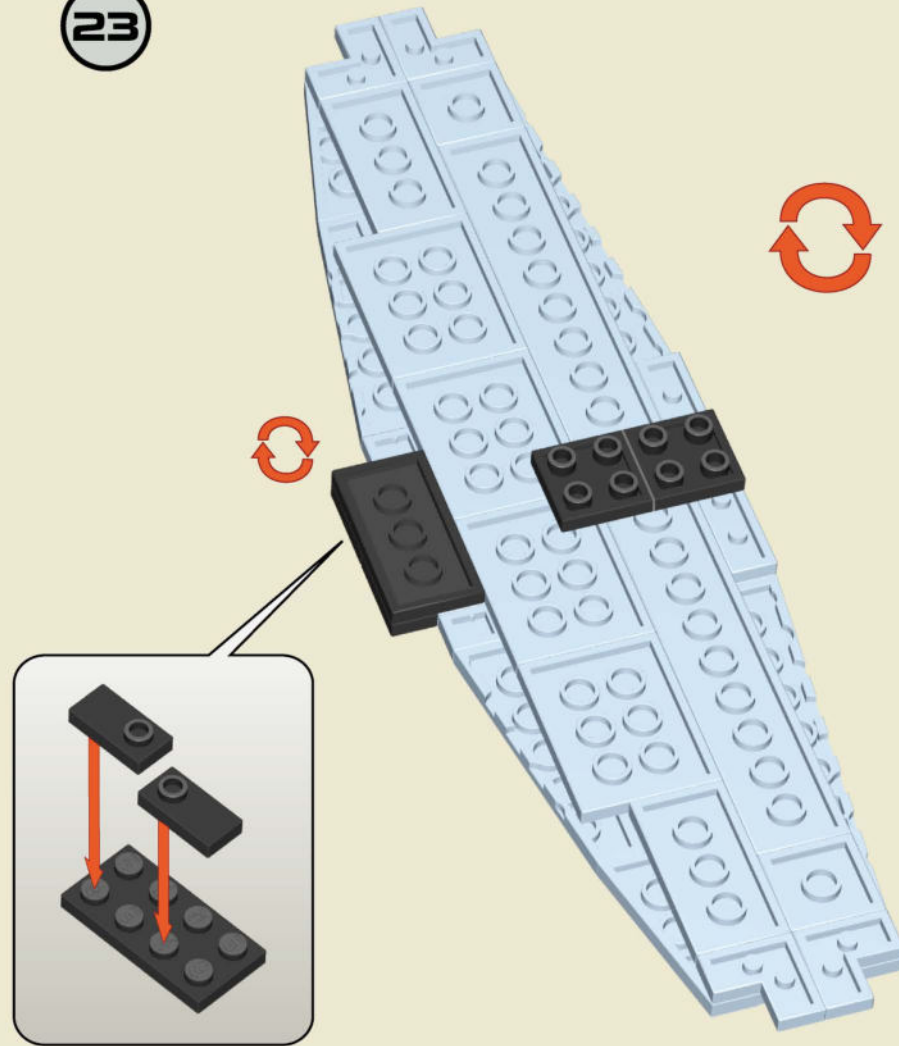

24

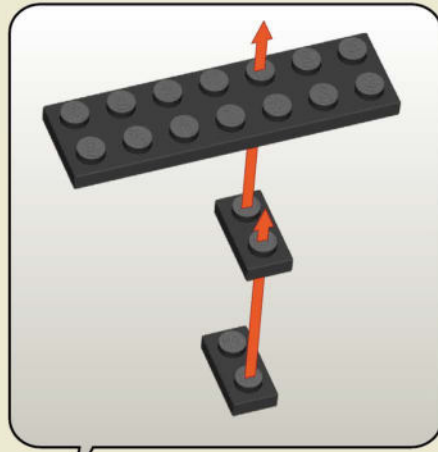
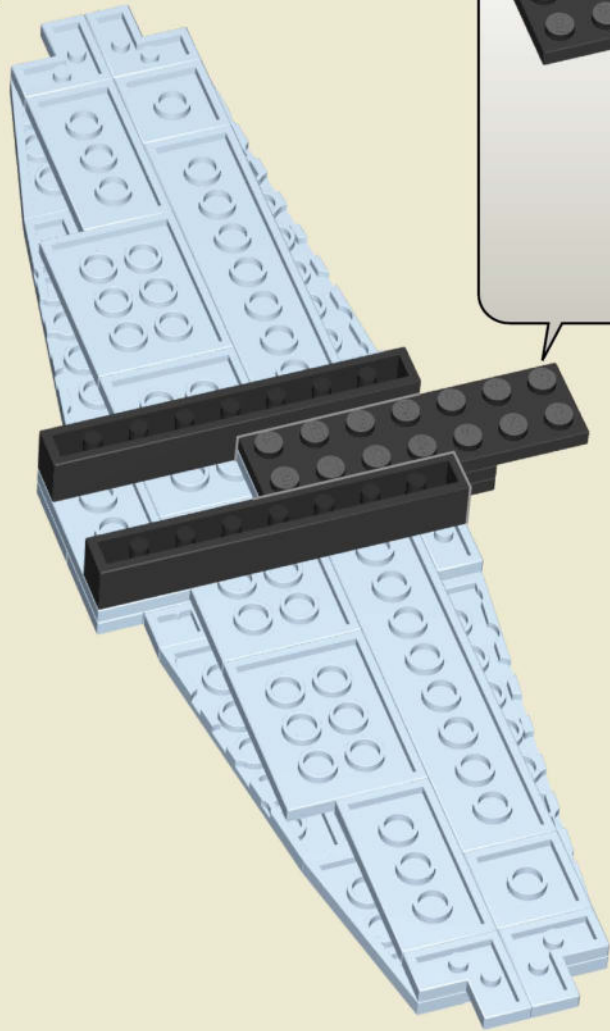

x2



x1



x2

25

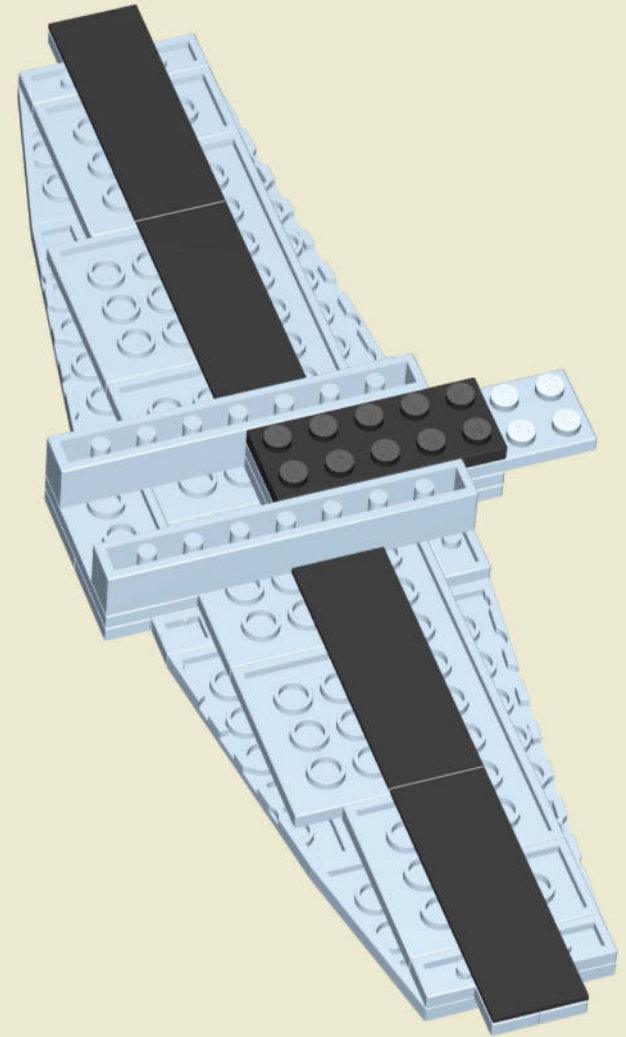

x4



x1

26

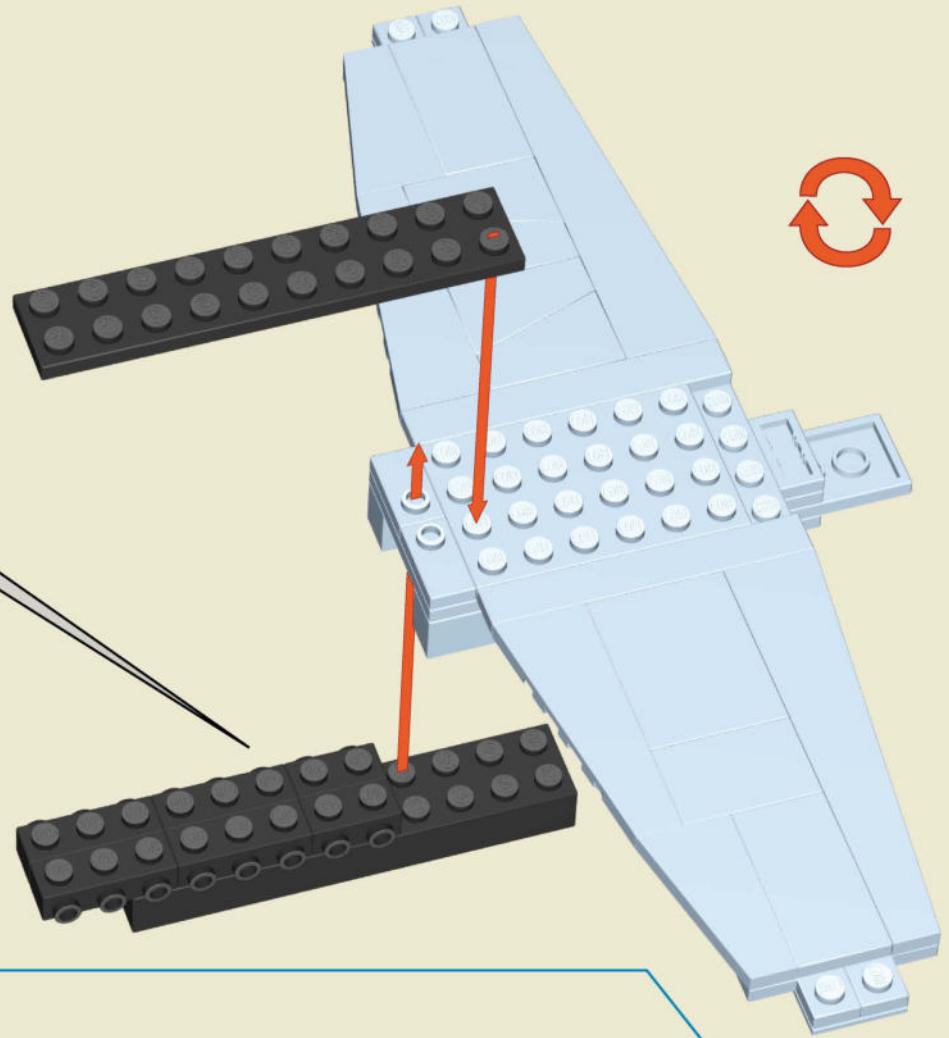
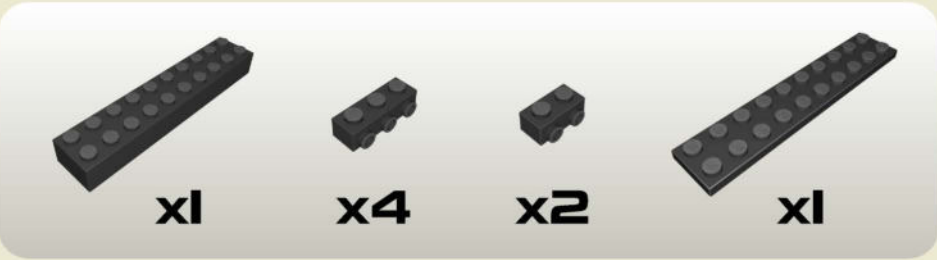
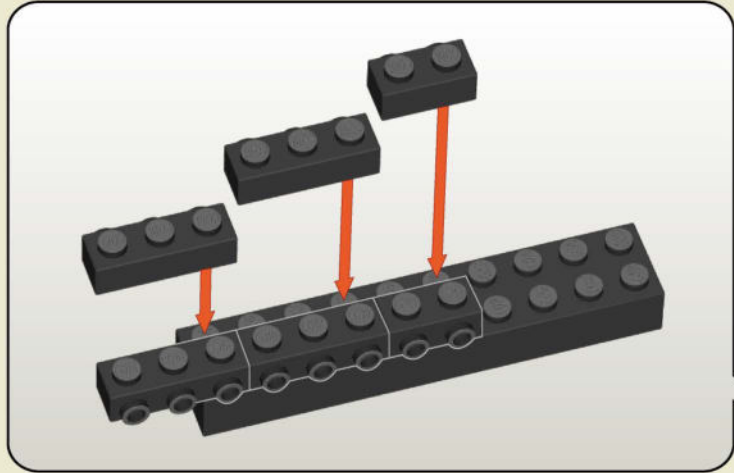

27

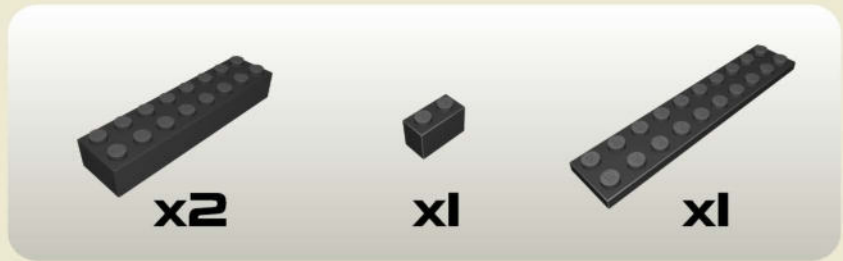
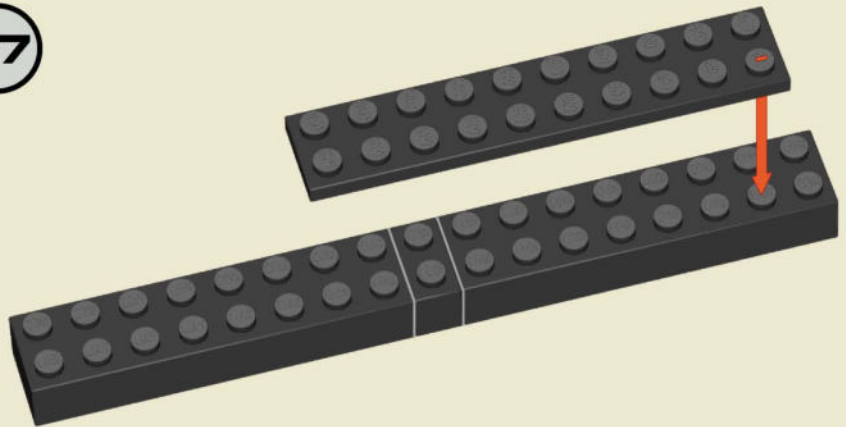

28

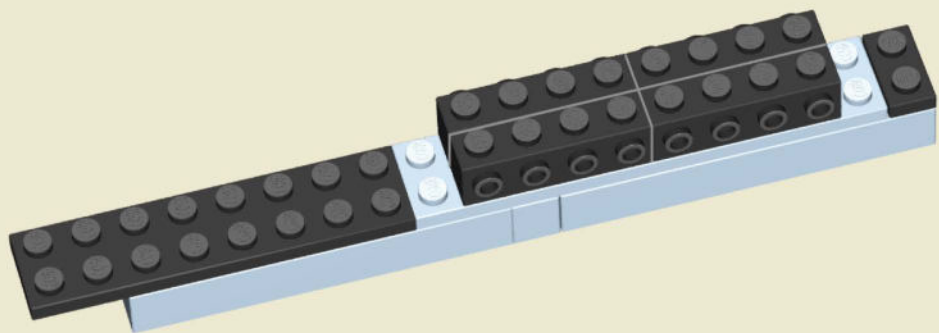

x1

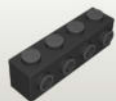

x4



x1

29

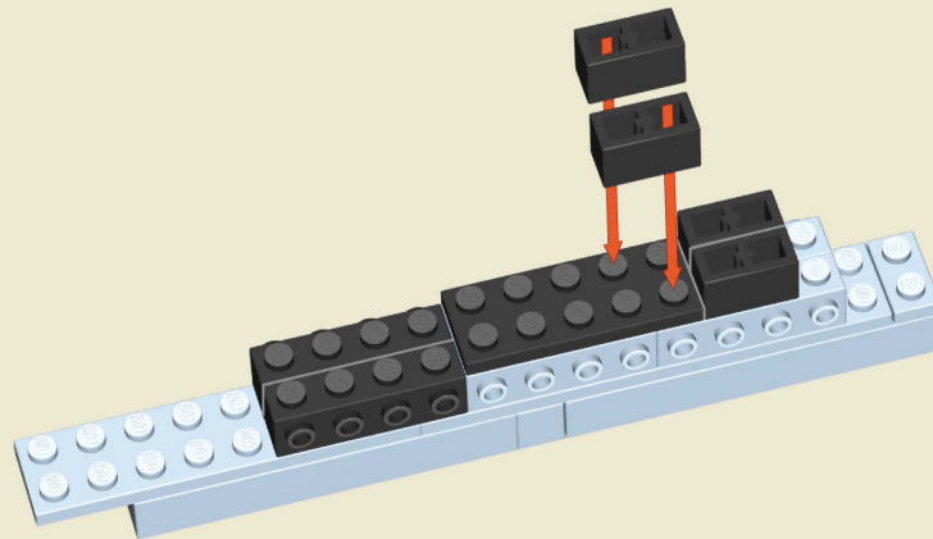

x2



x1



x4

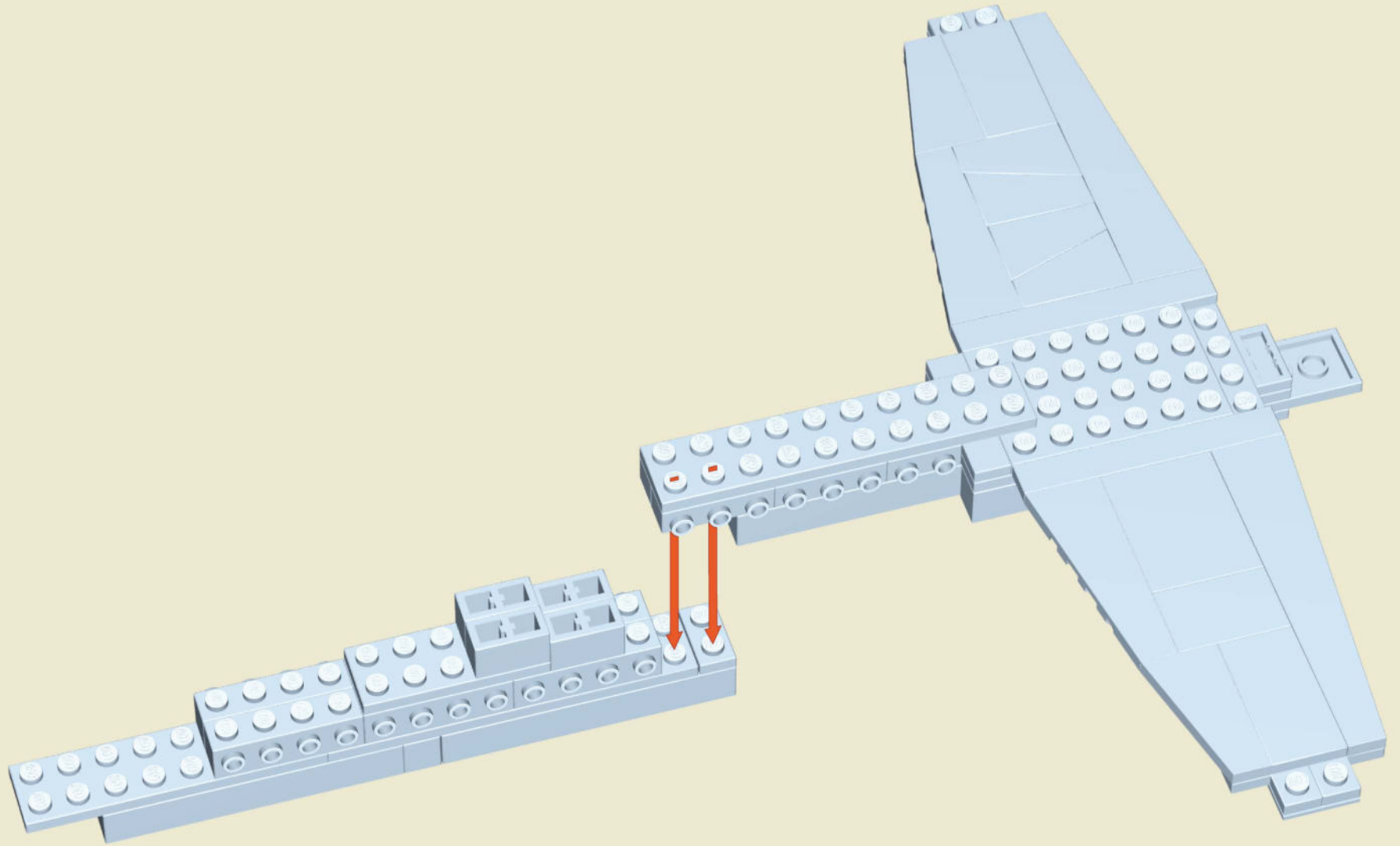

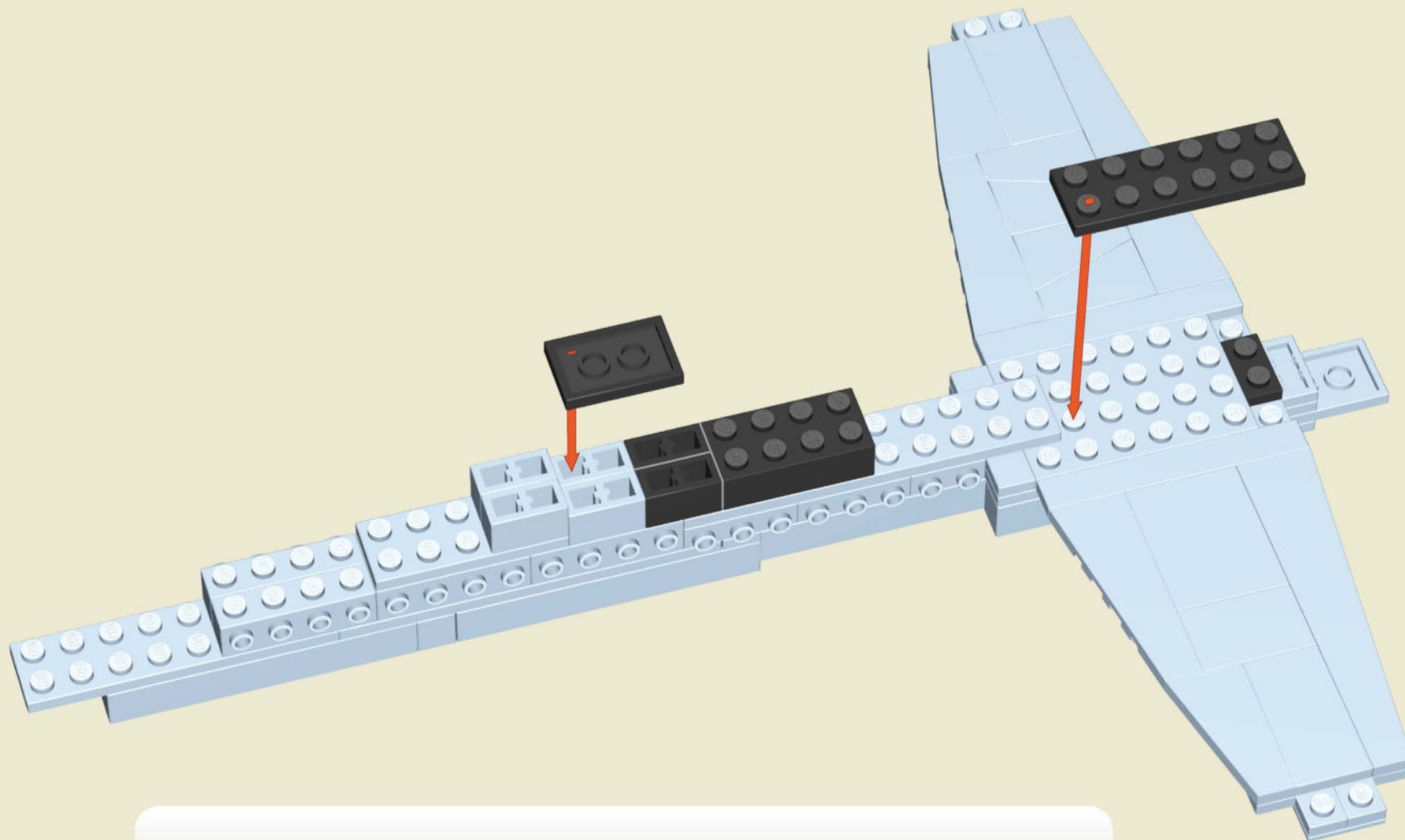

x2

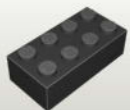

x1

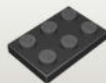

x1



x1



x1

32

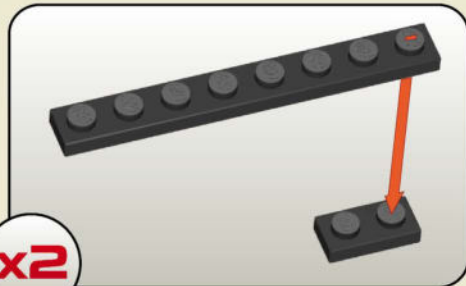
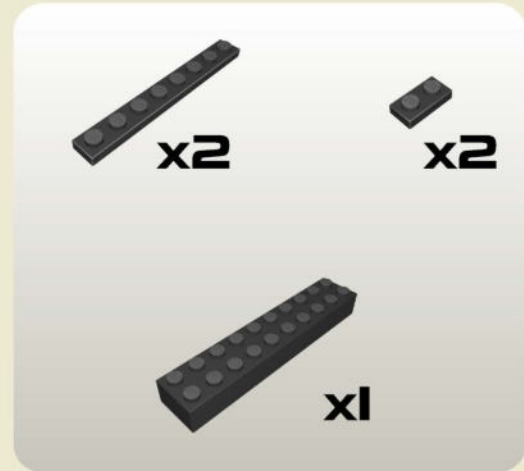
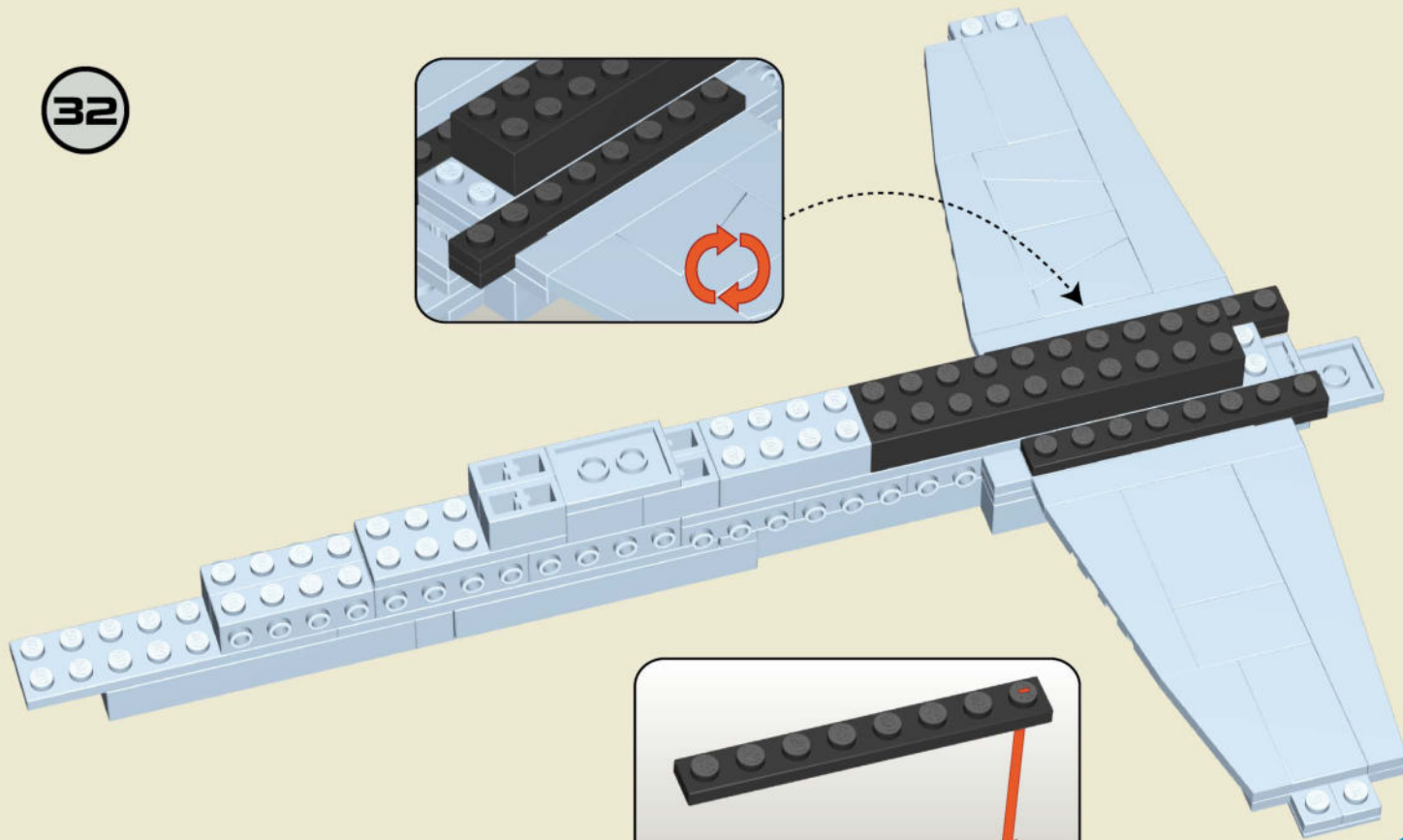
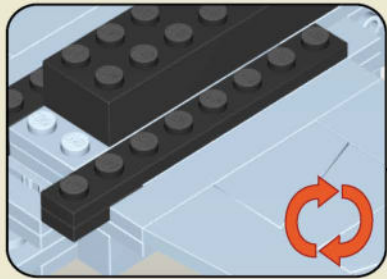

x2

33

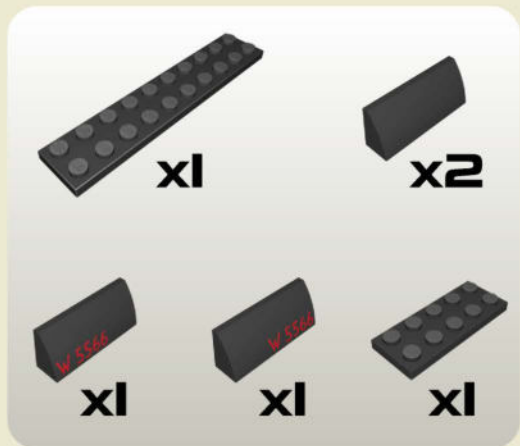
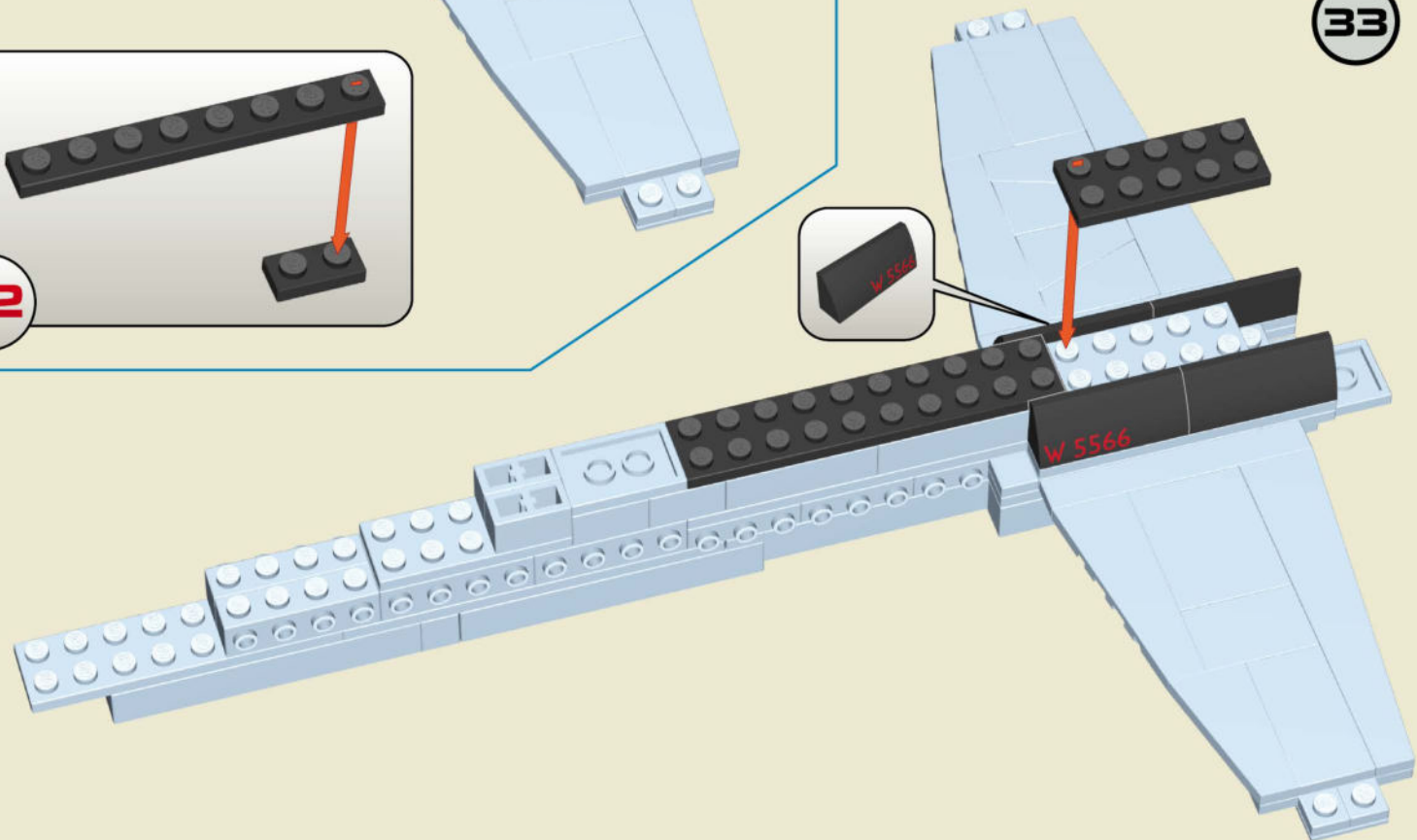

34

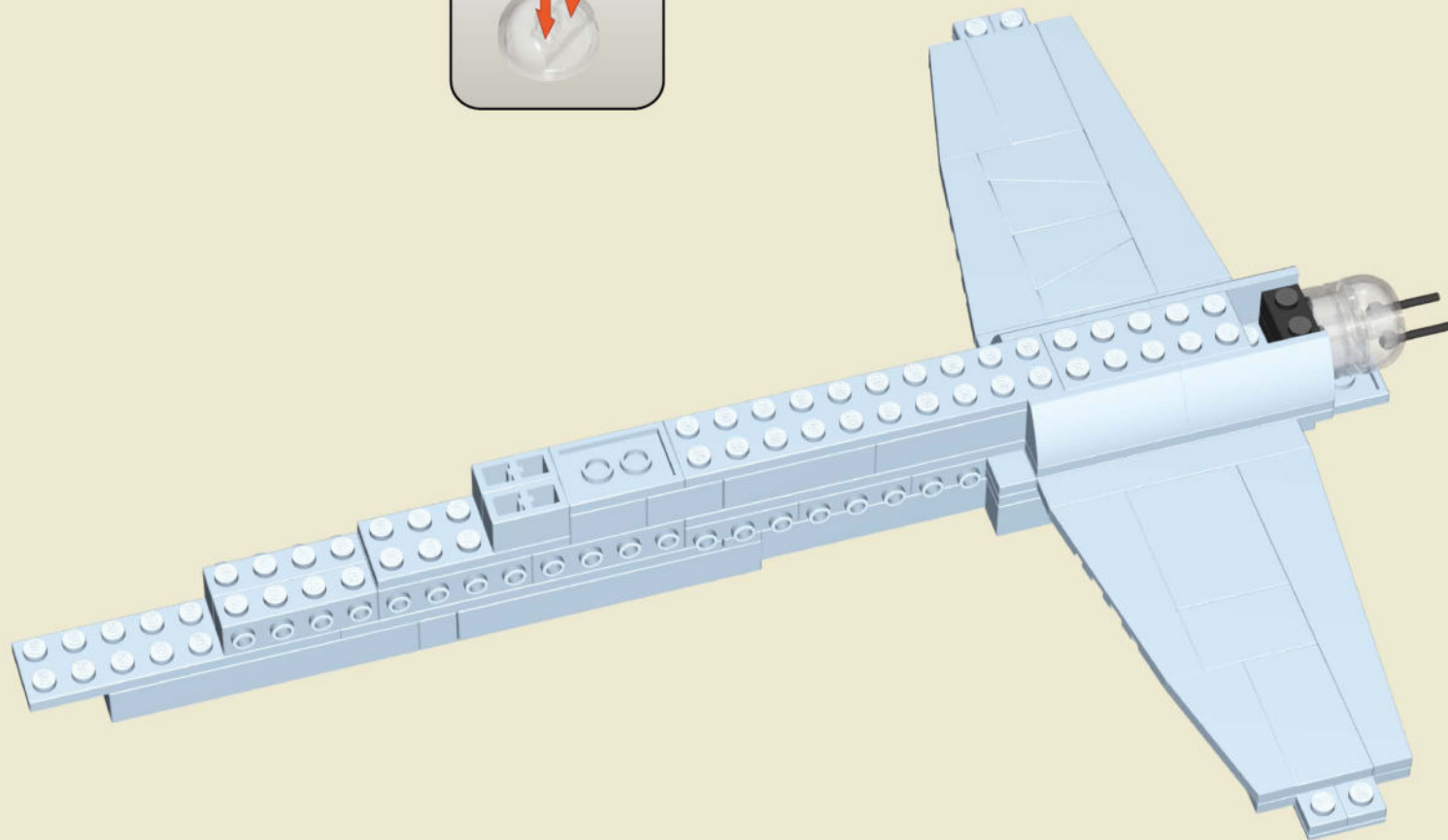
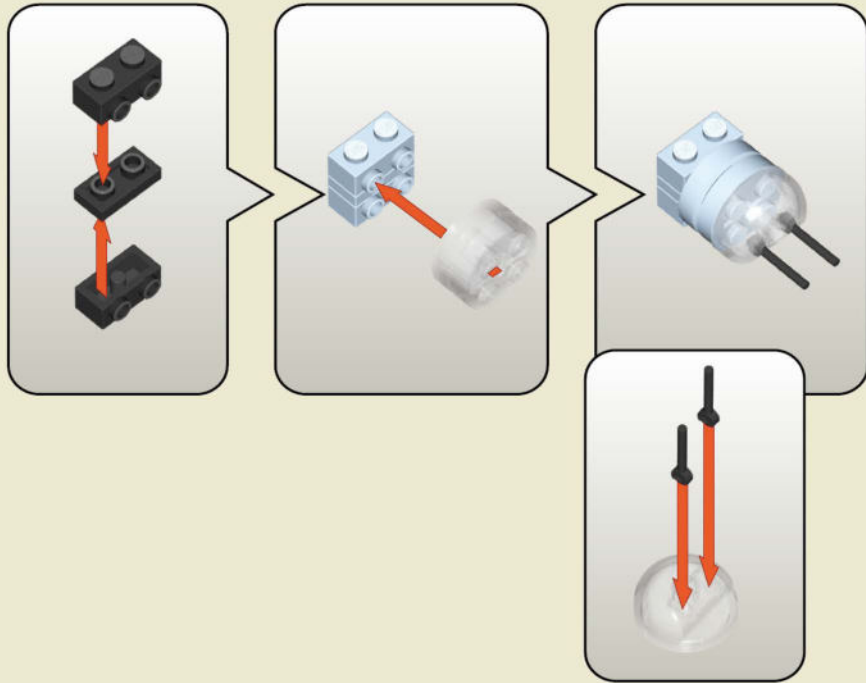

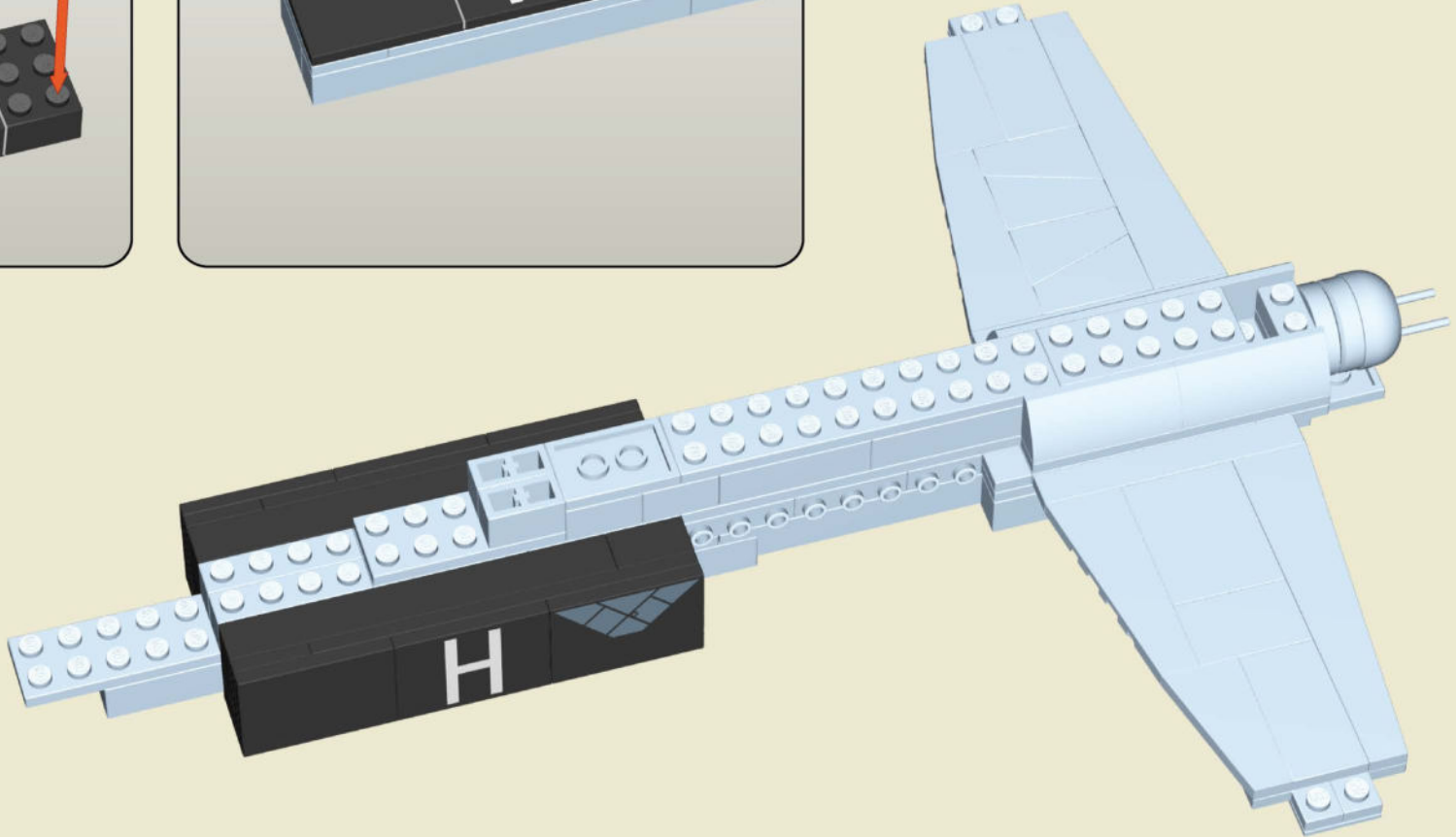
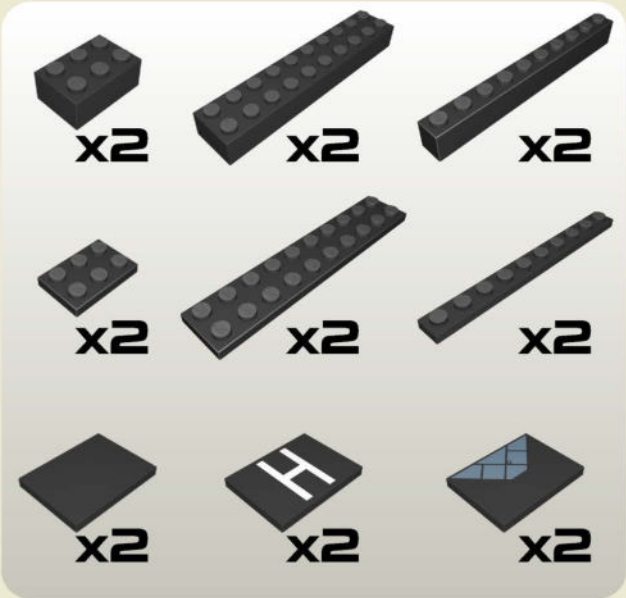
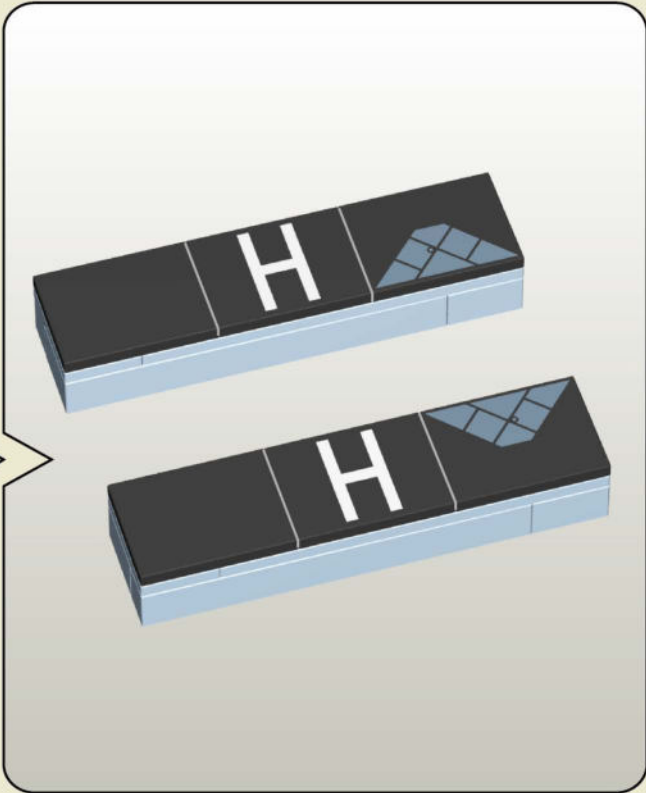
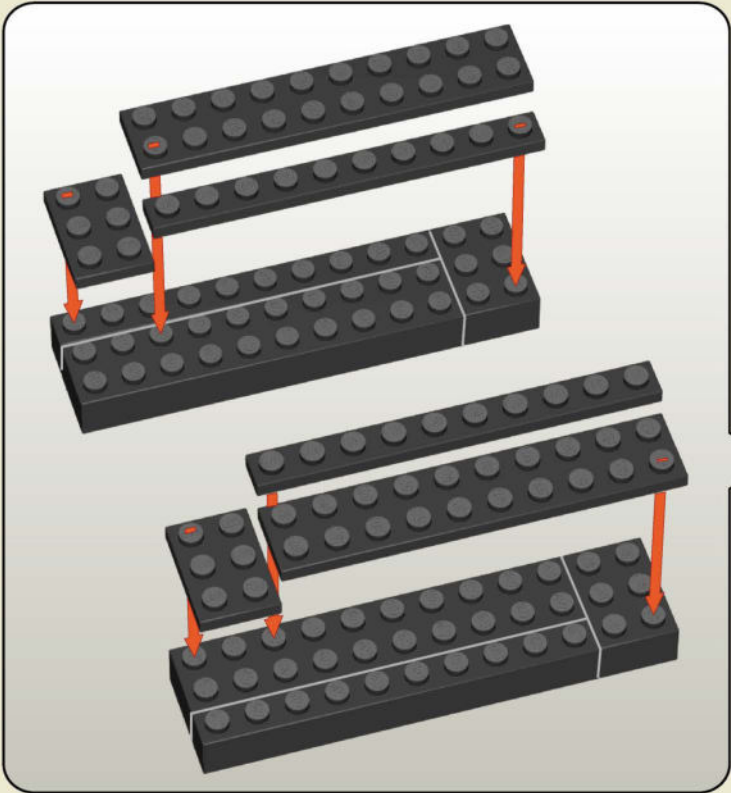

36

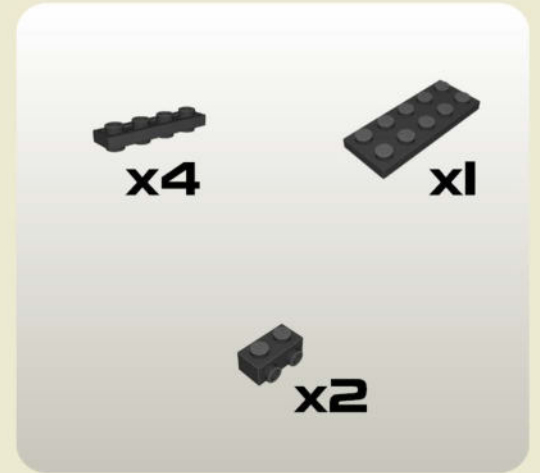
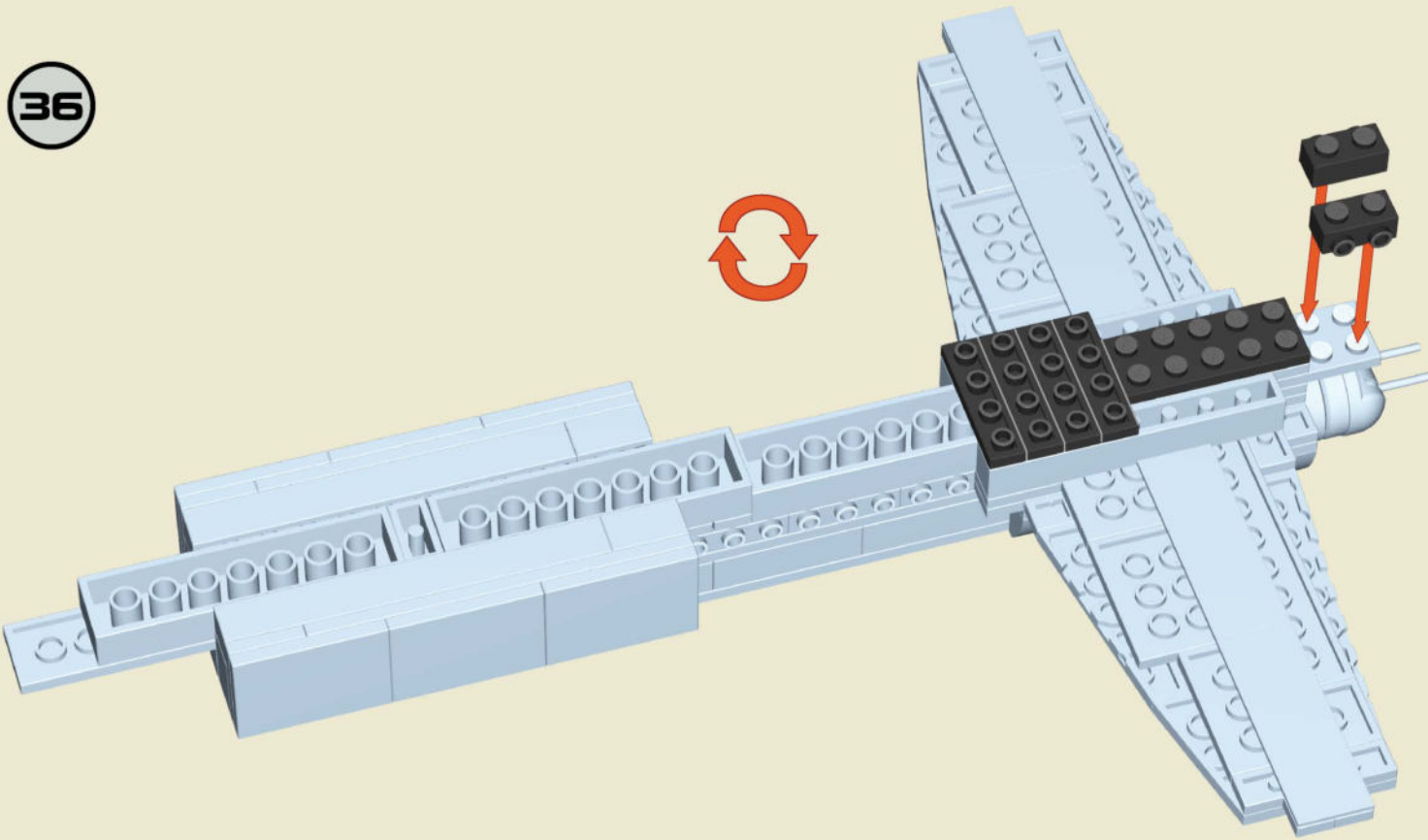

37

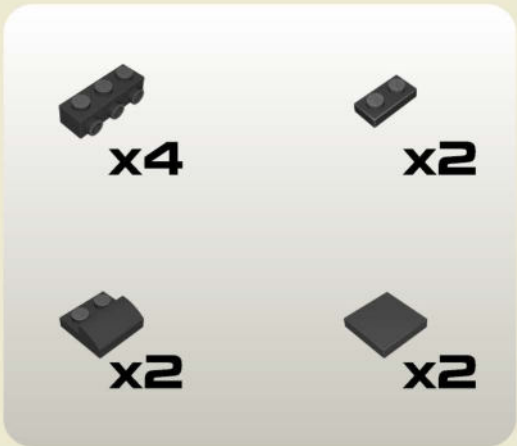
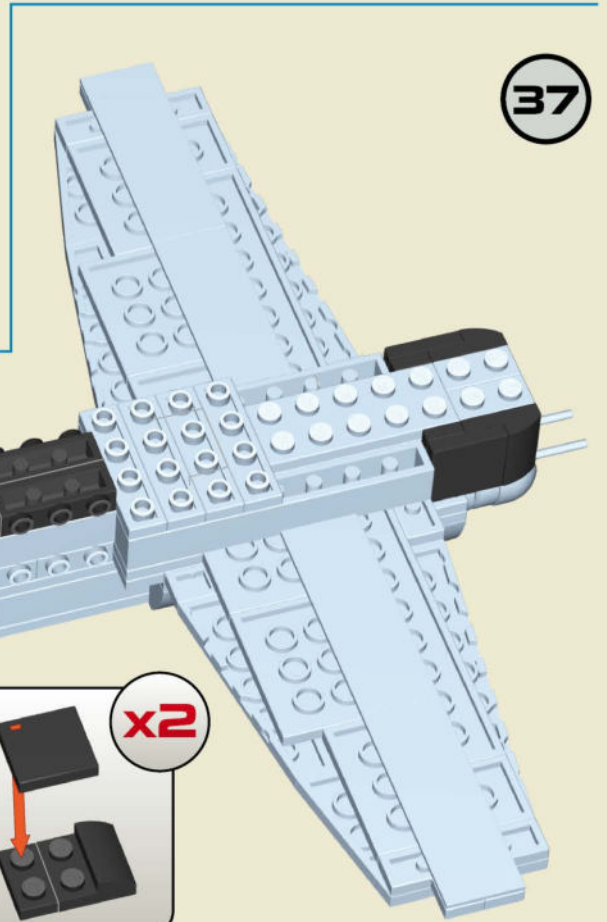

38

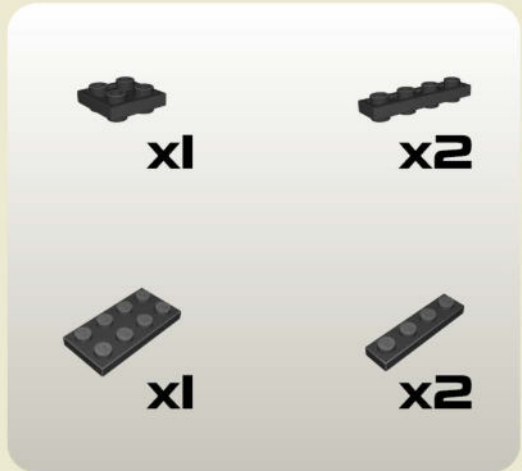
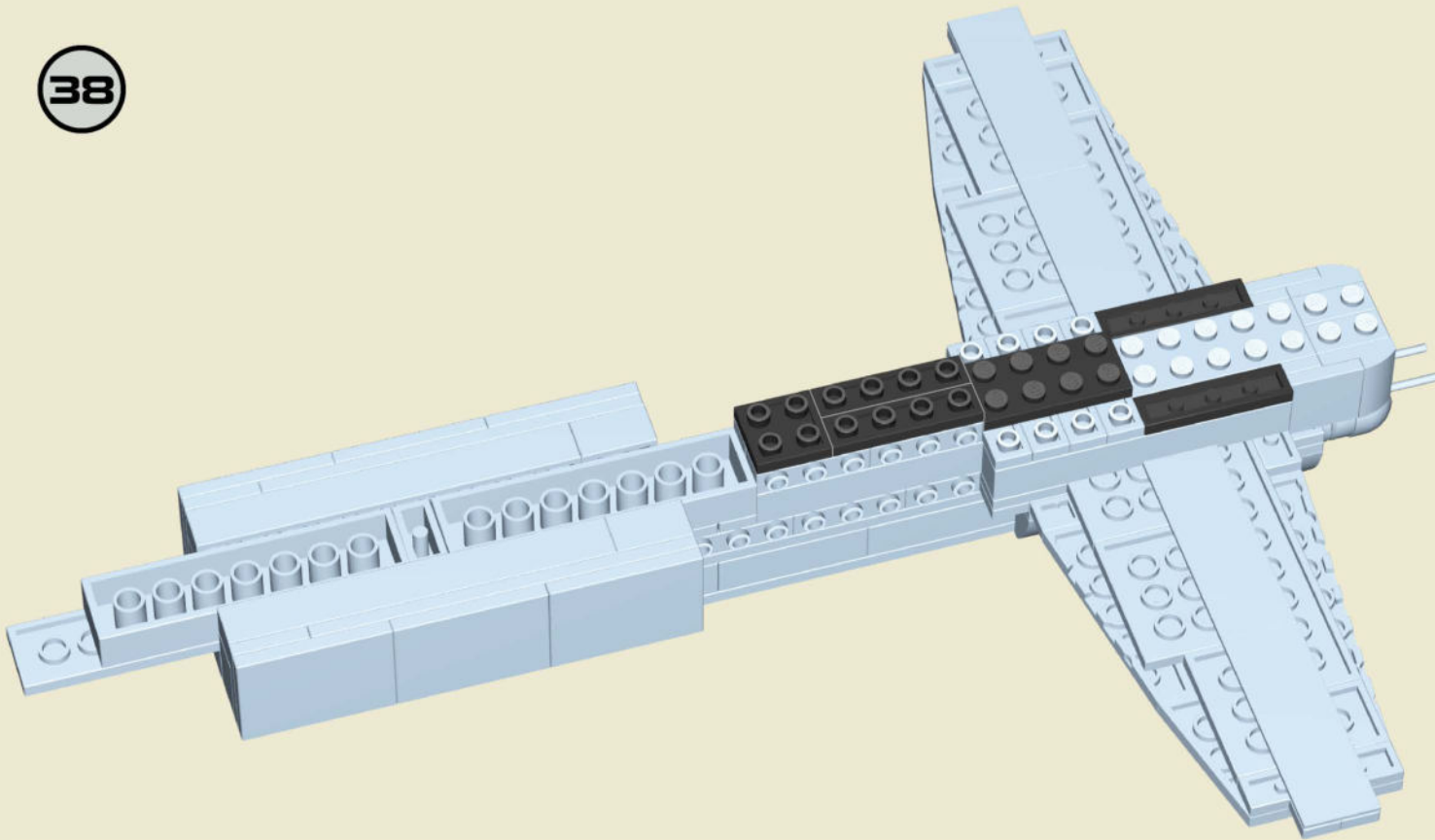

39

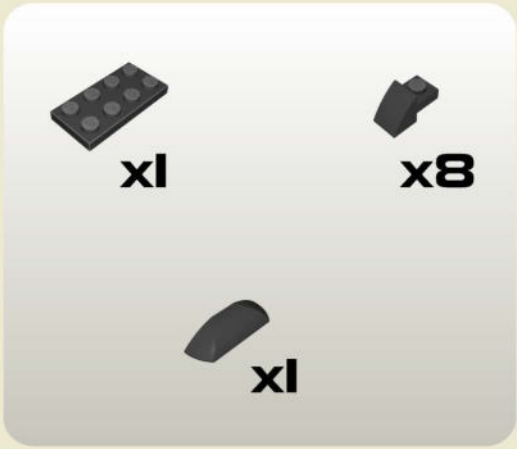
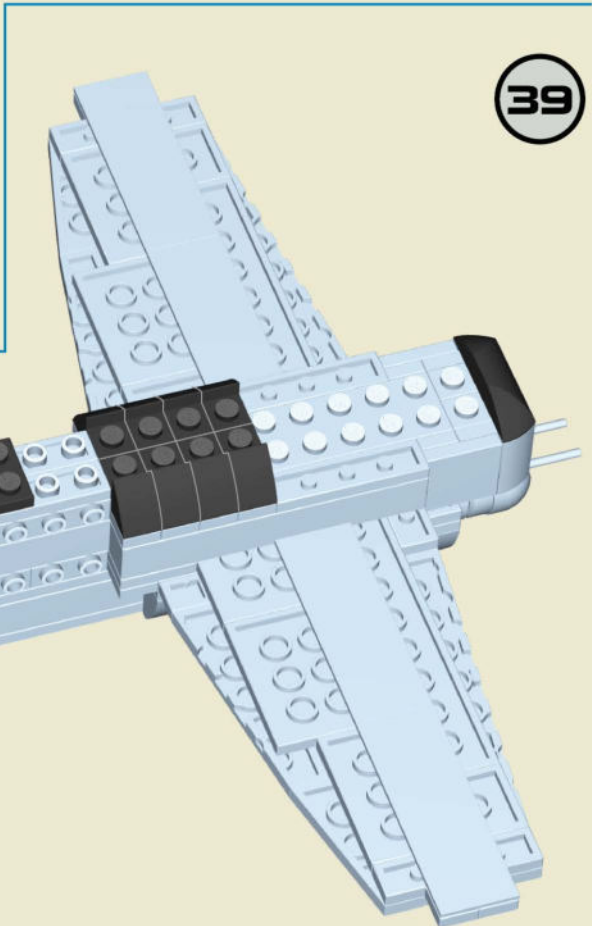

40

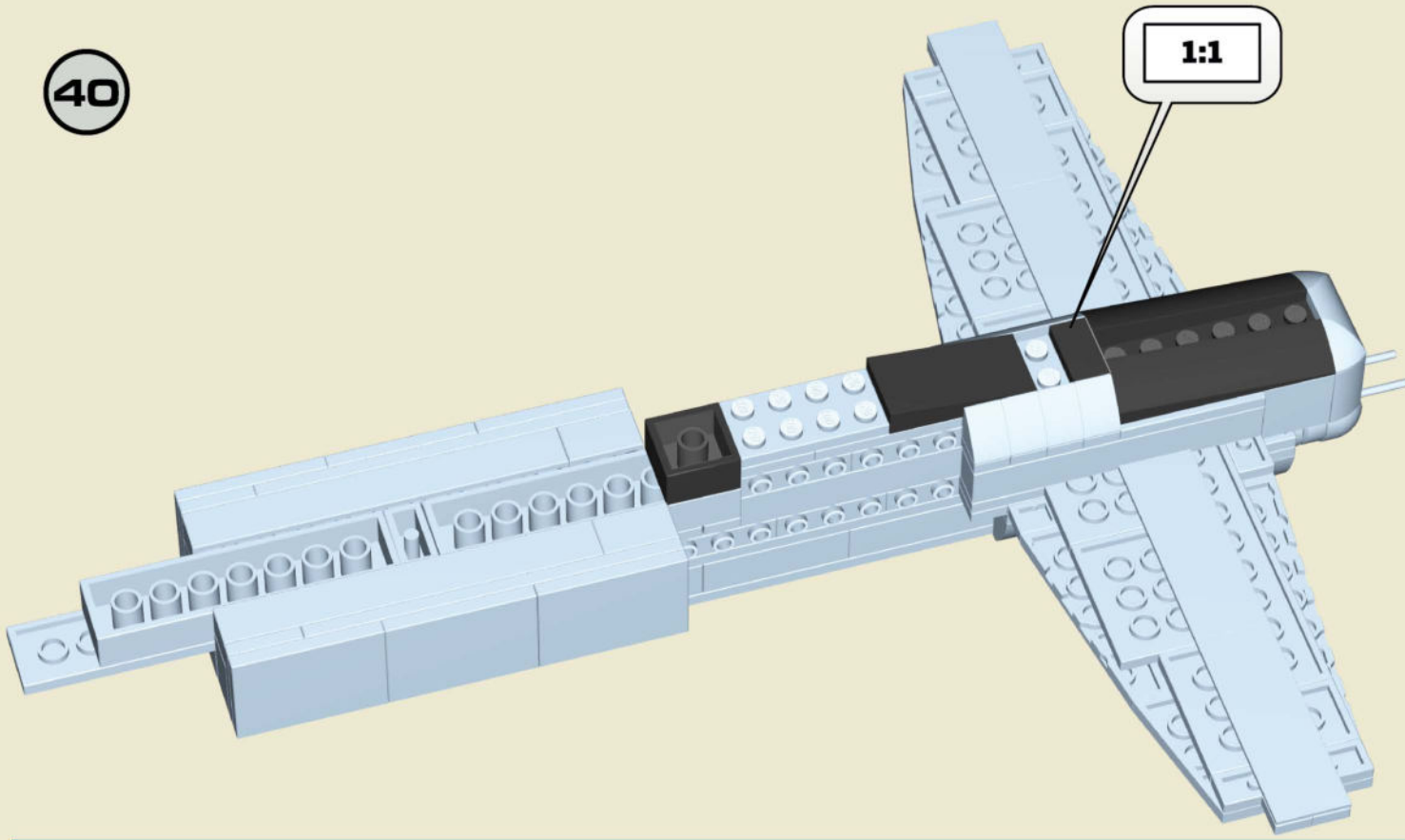

1:1

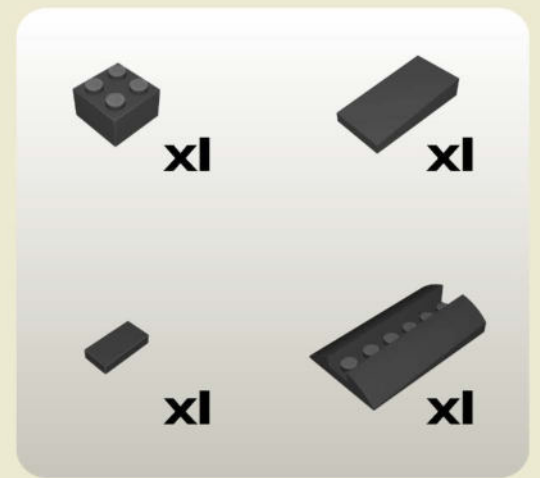

41

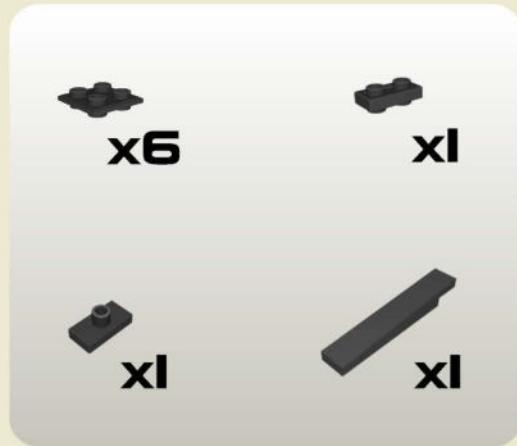
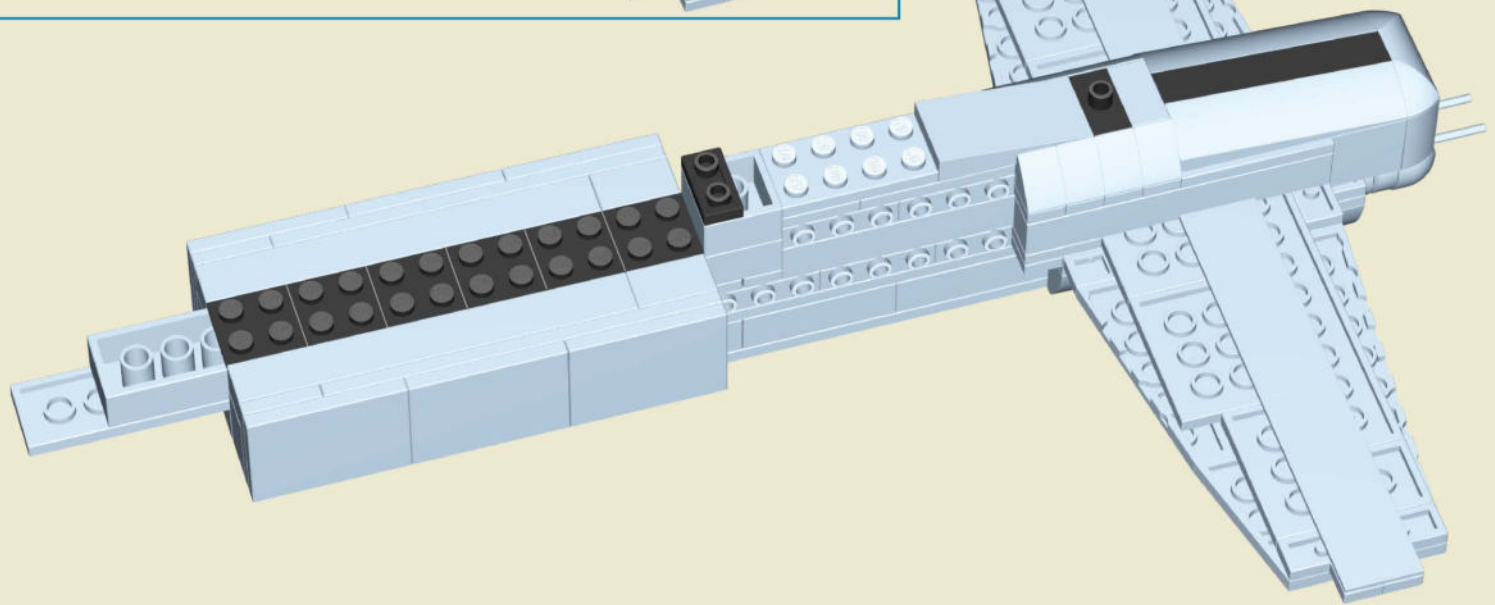

42

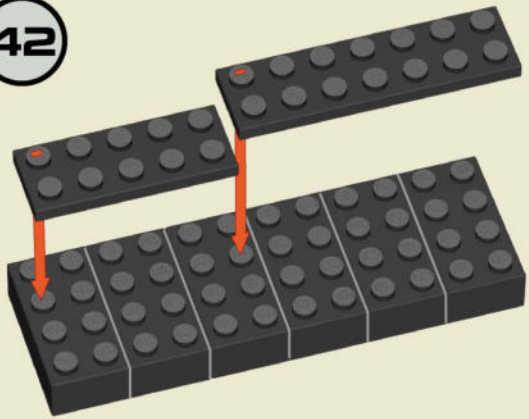

x6



x1



x1

43

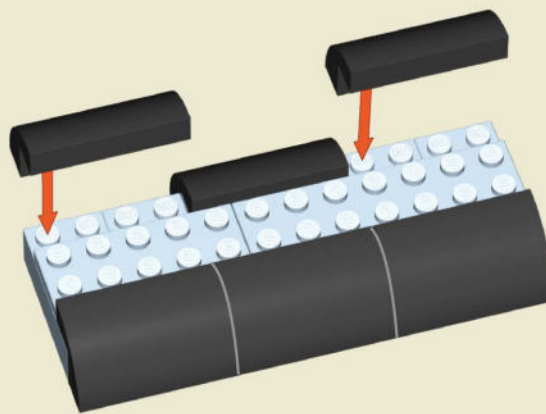

x6

44

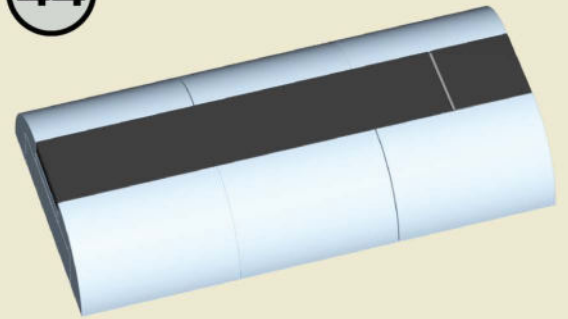

x1



x1

45



x2

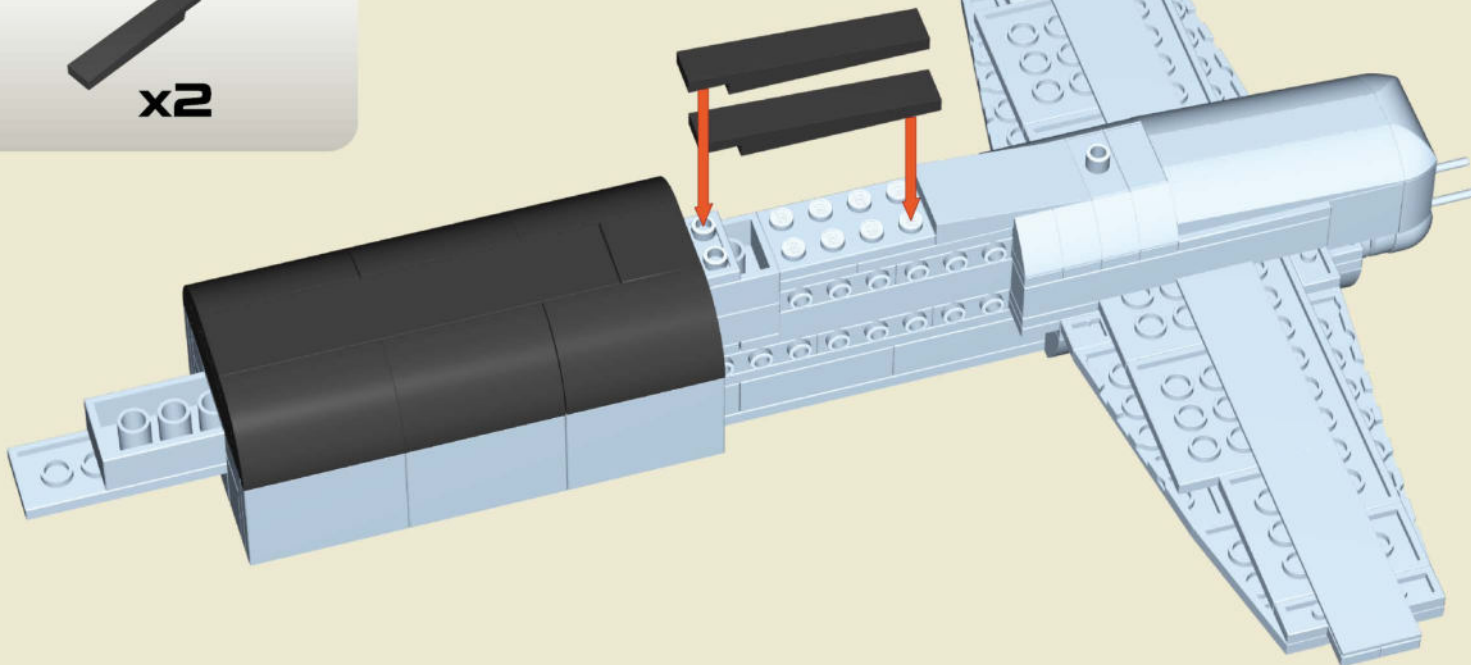

46

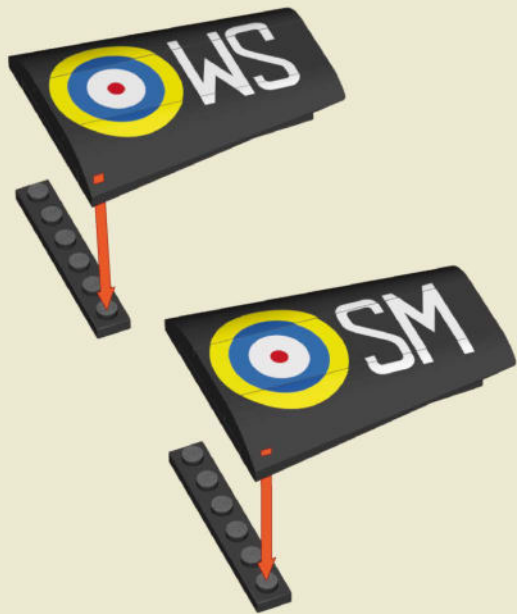

47

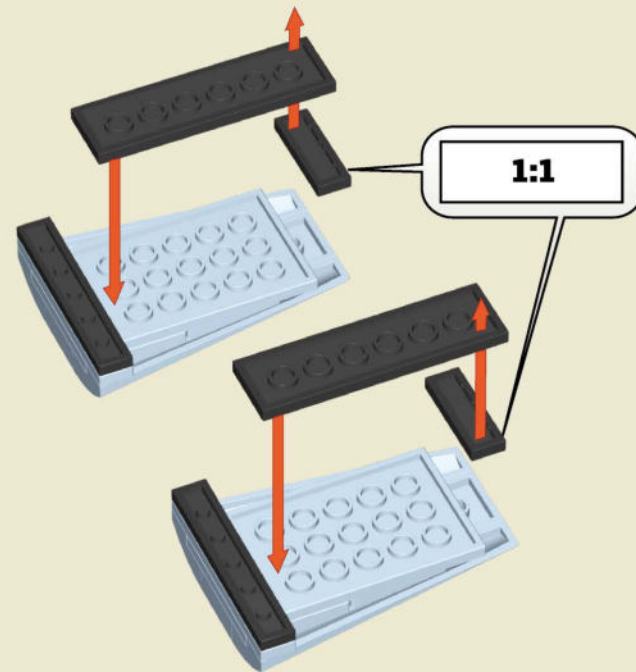

48

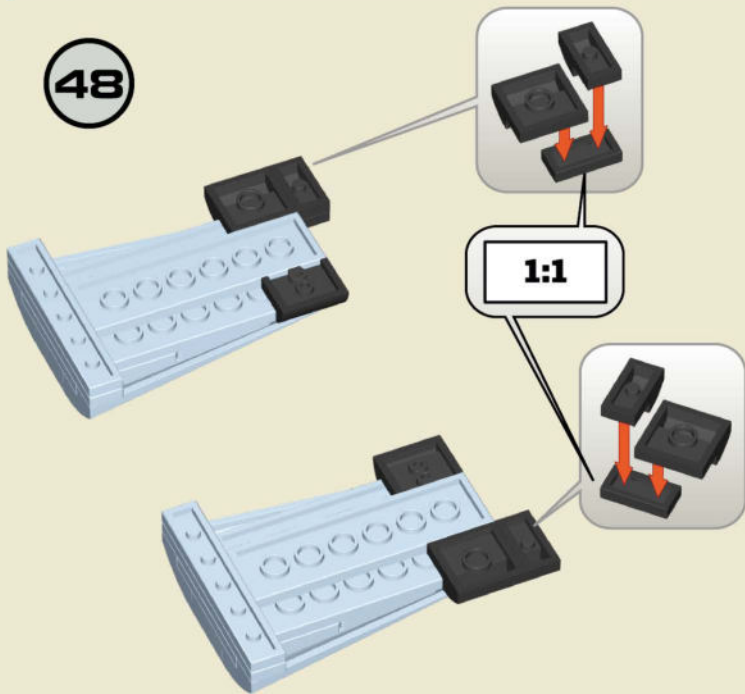

49

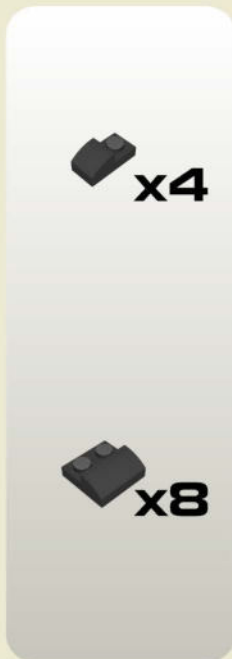
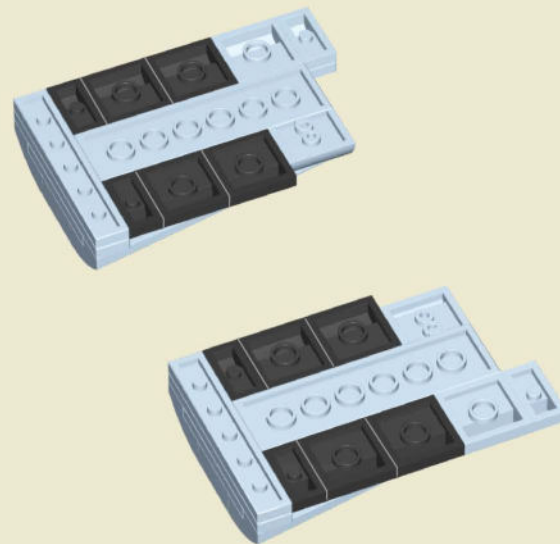

50

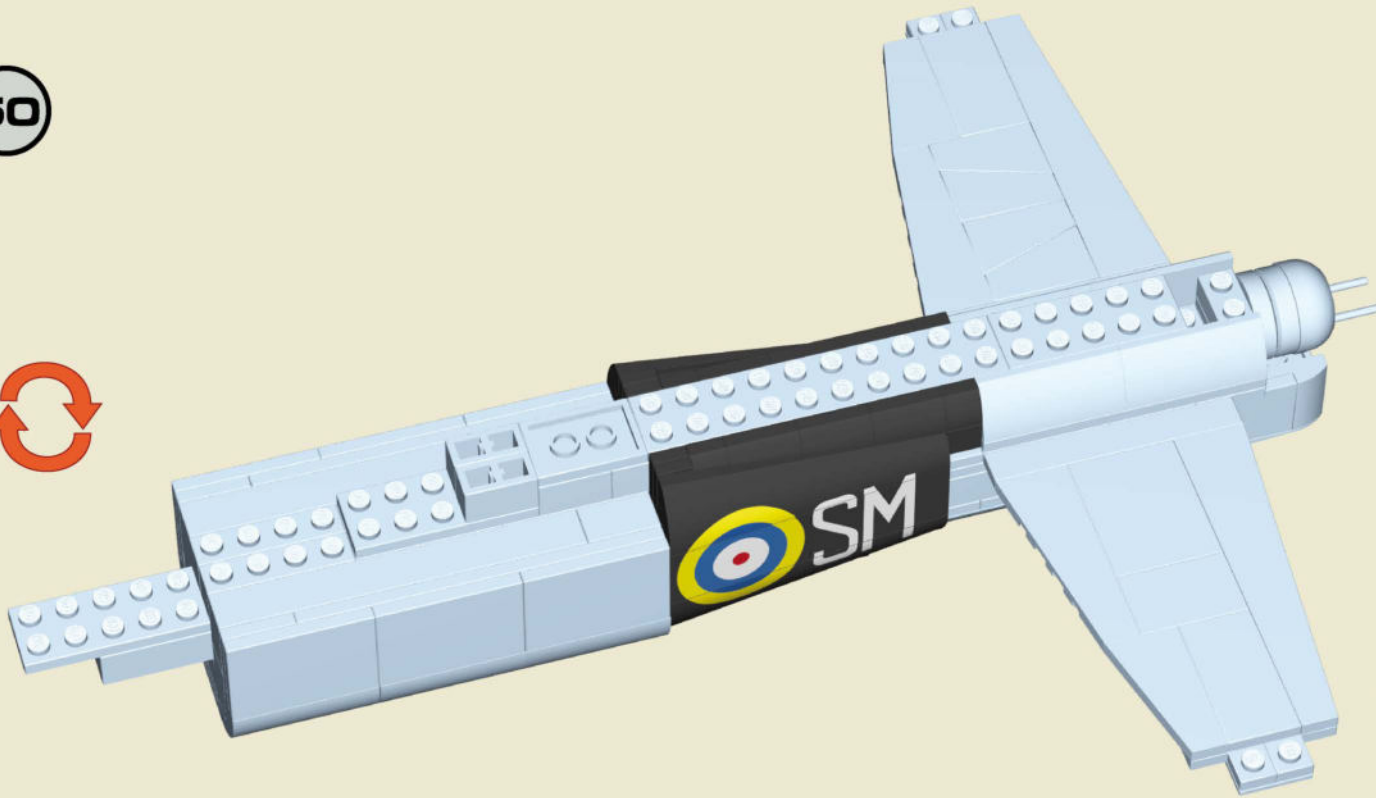

51

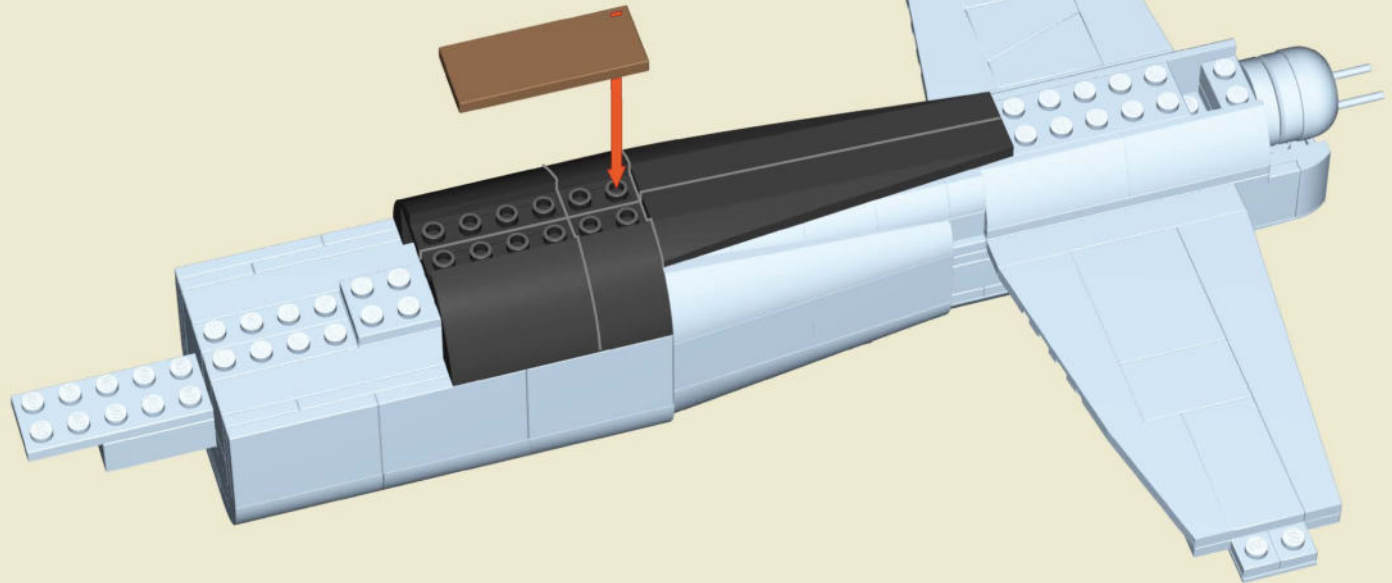
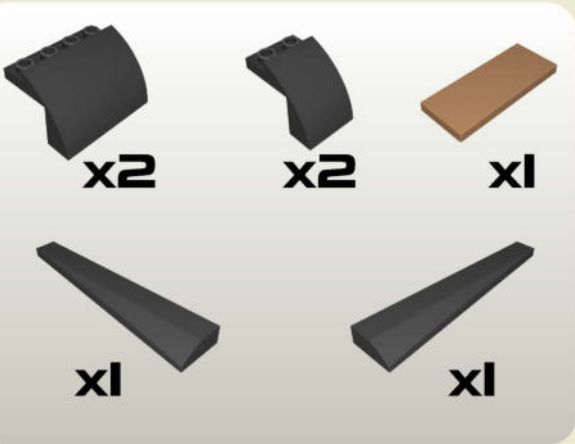

52

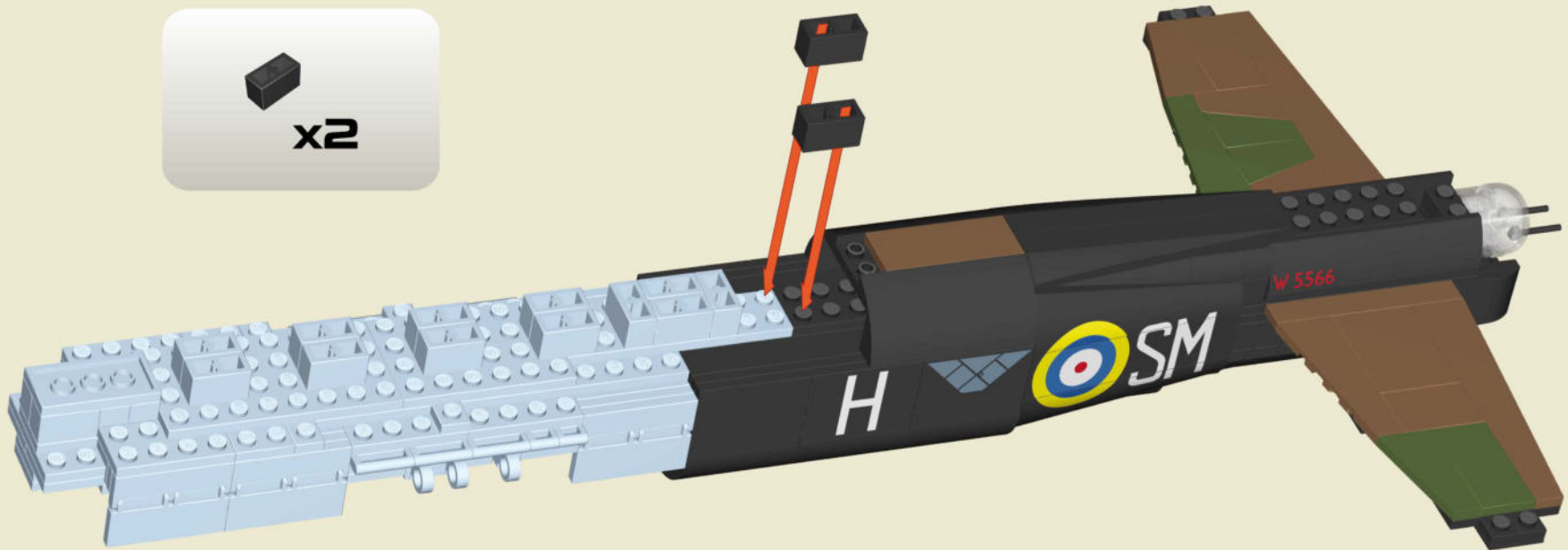

53

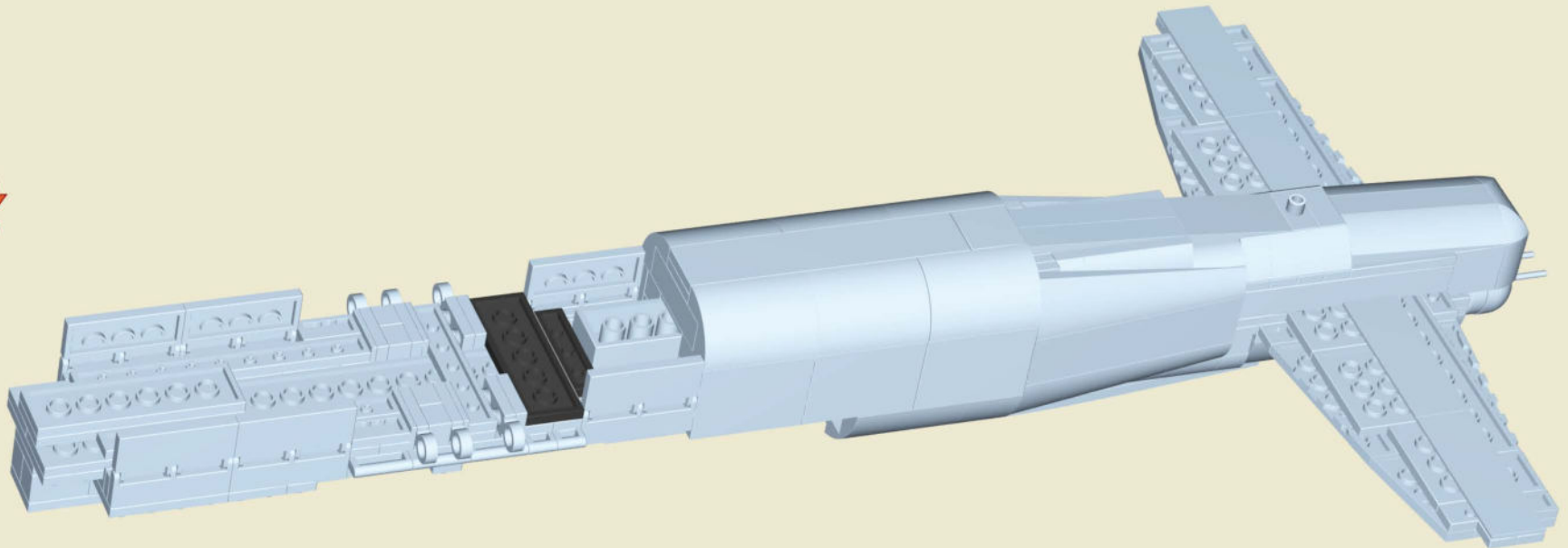
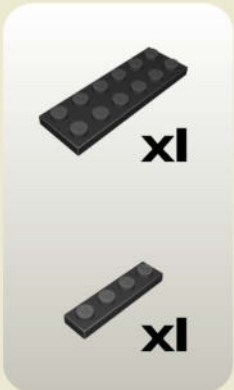

54

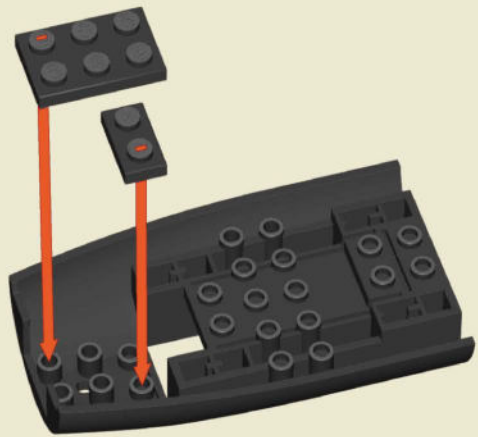

x1



x1

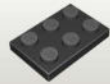

x1

55

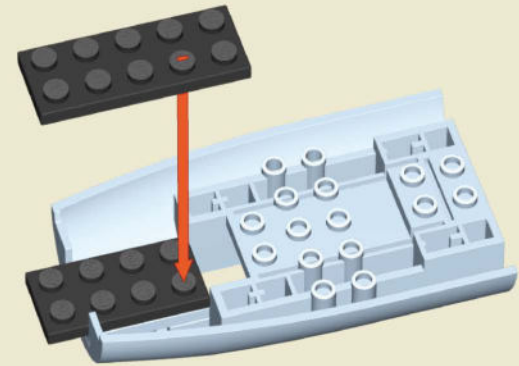

x1



x1

56

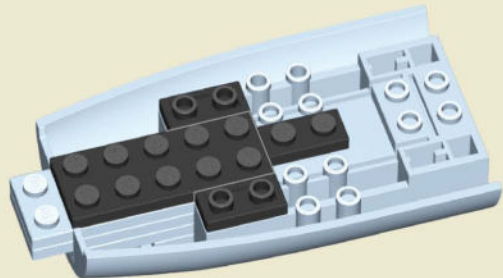

x1



x2



x1

57

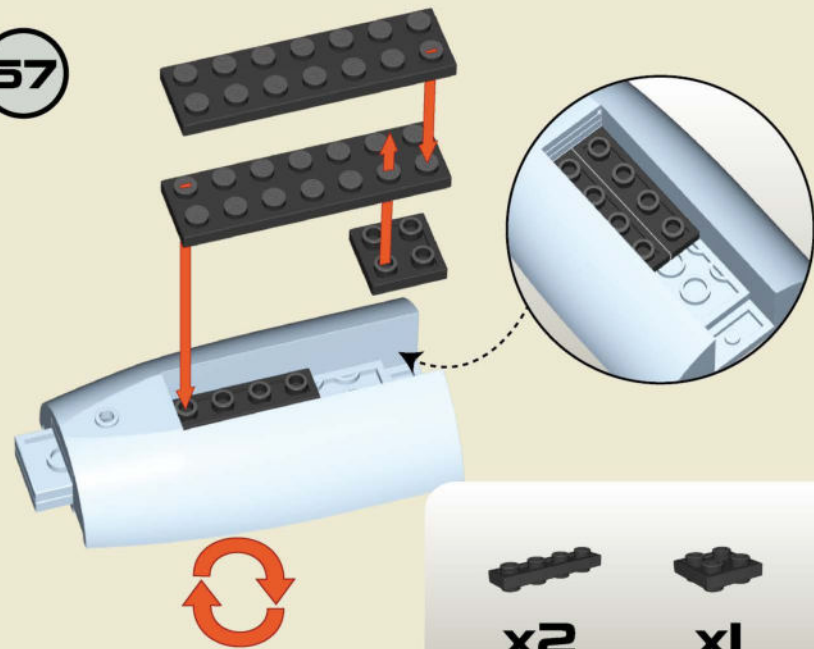

x2



x1



x2

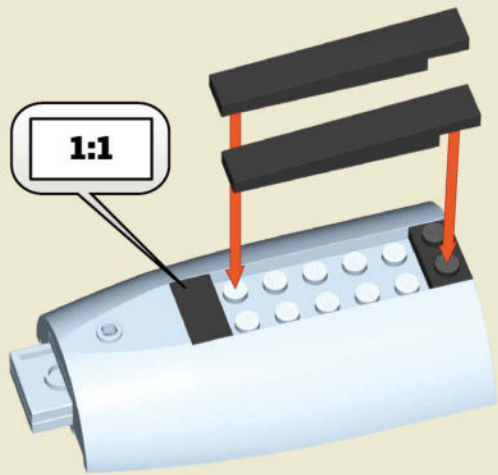

58



 **x1**
  **x1**
  **x2**

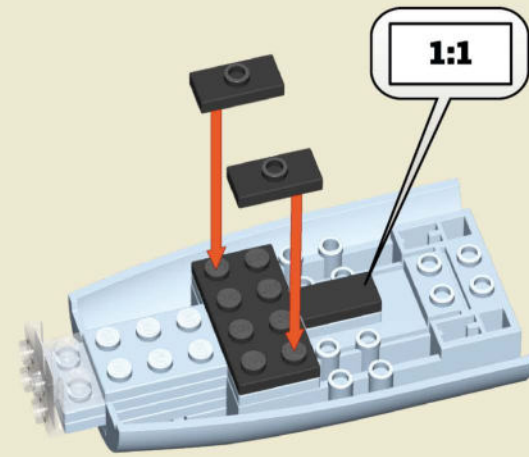

59

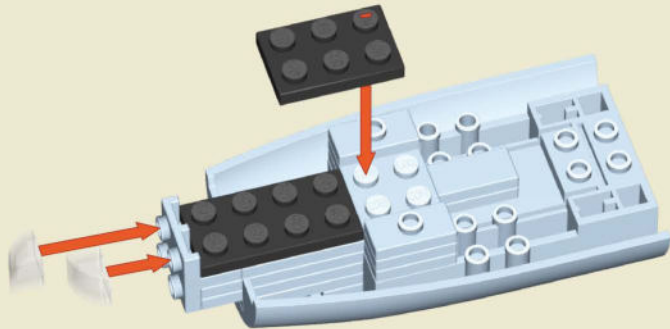

 **x1**
  **x1**
  **x1**
  **x2**

60



 **x1**
  **x1**
  **x2**

61

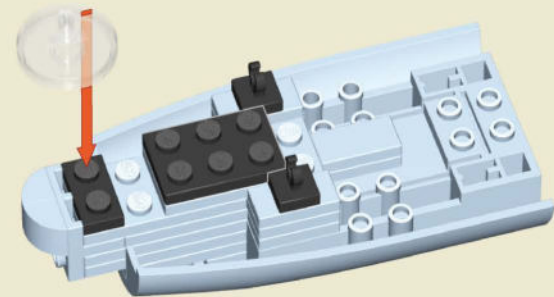

 **x1**
  **x1**
  **x1**
  **x2**

62



x2

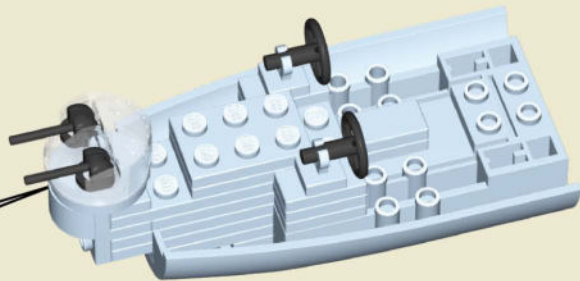

x2



x2



x1



x2

63

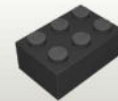
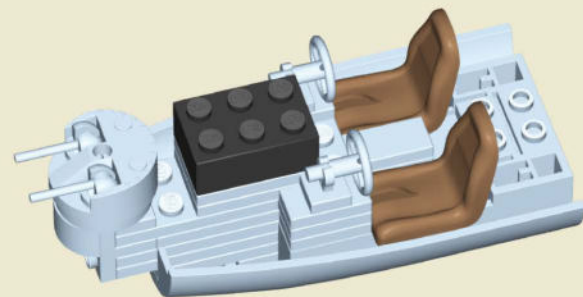

x1



x2

64

65 = 66



x1



x1



65

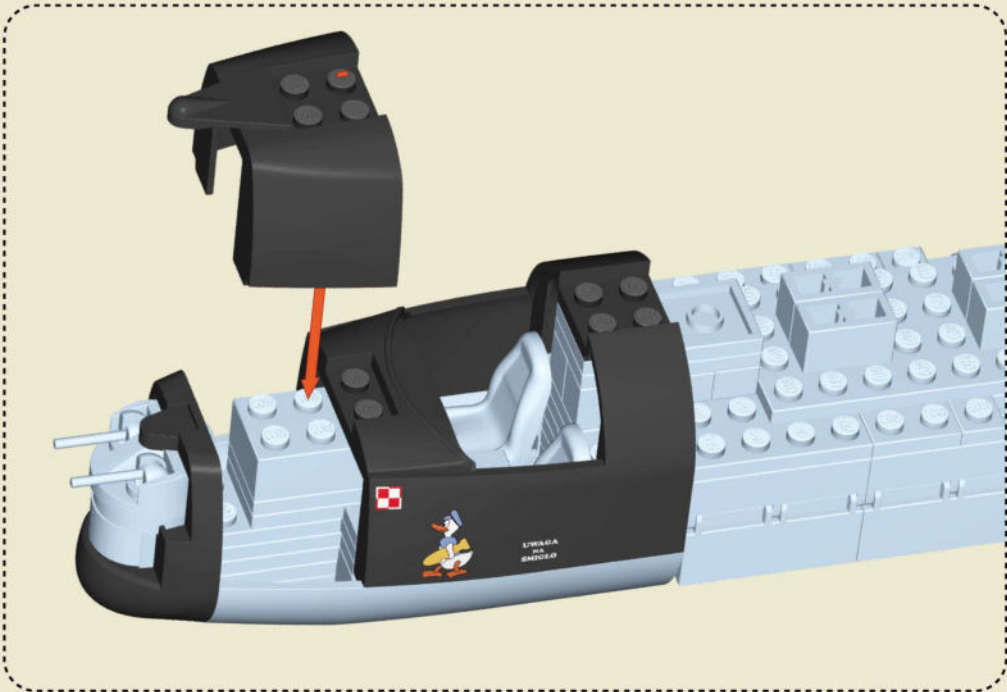

x1



x1



x1

66

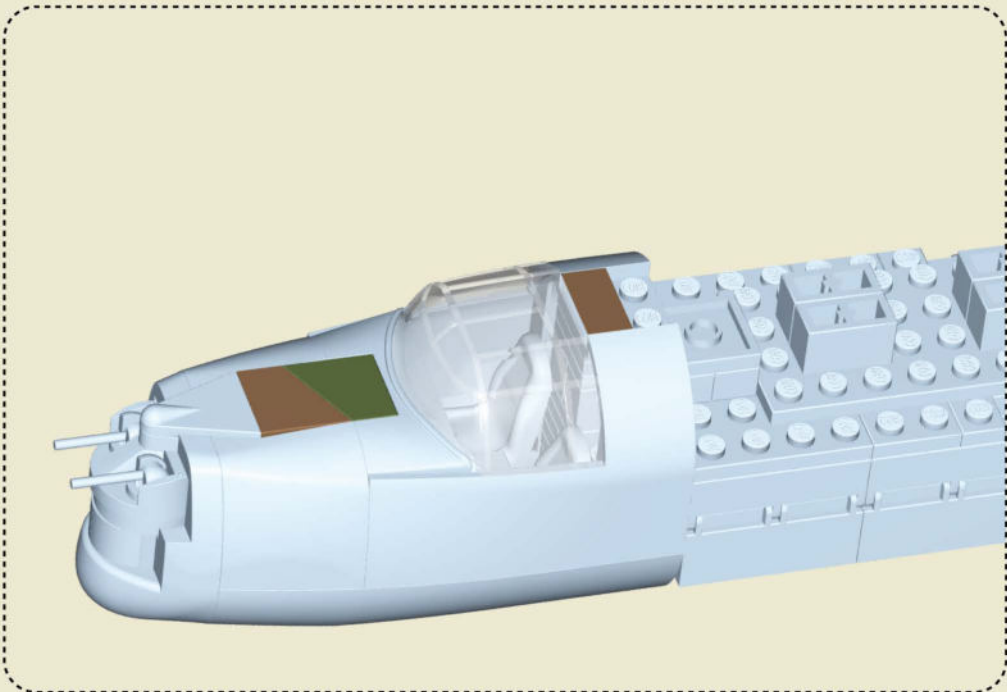

x1



x1



x1



67

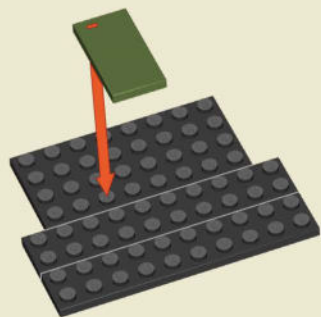

1:1

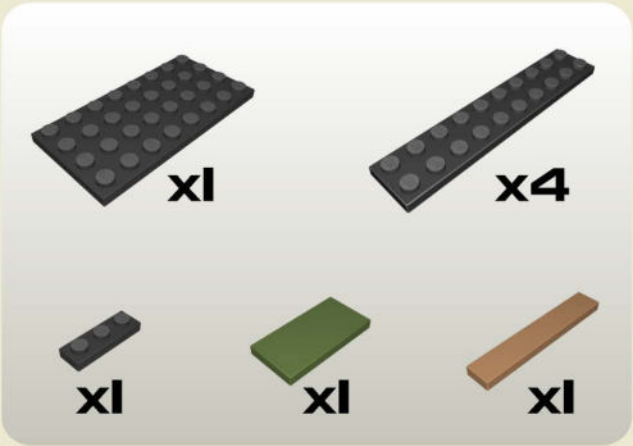
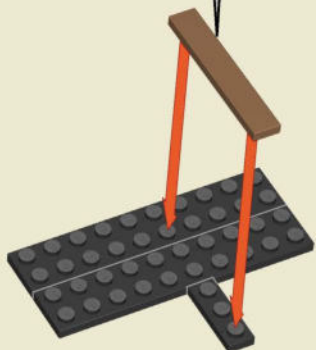

68

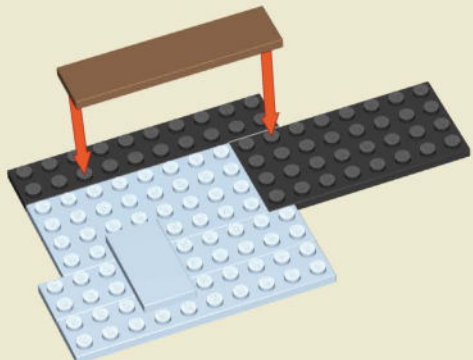

1:1

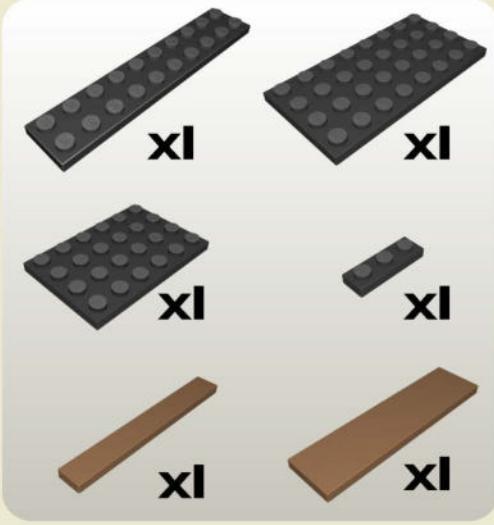
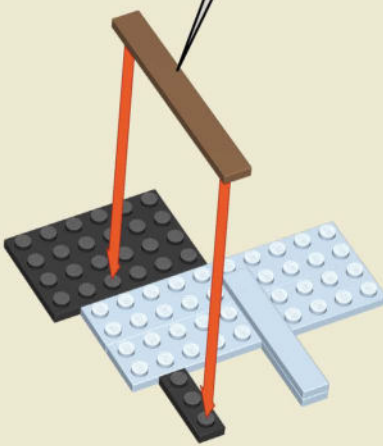

69

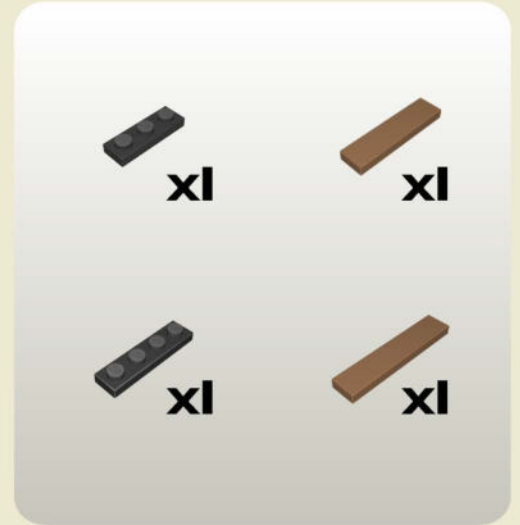
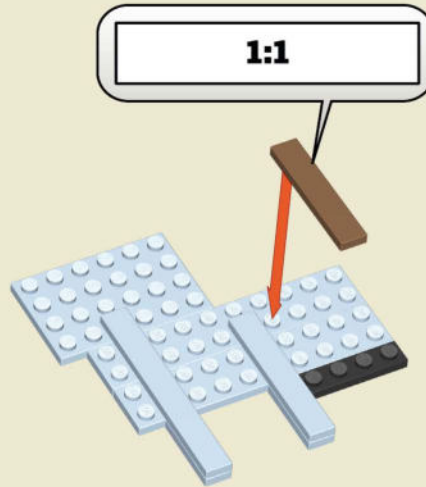
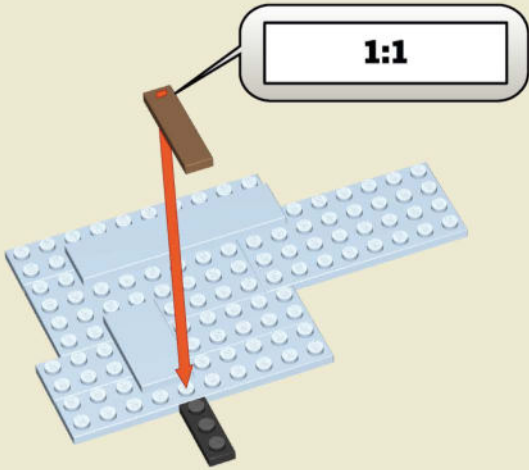

70

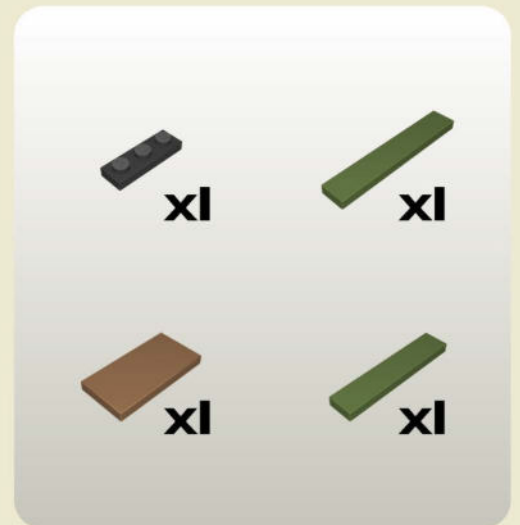
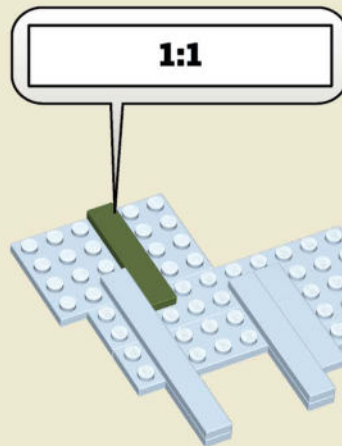
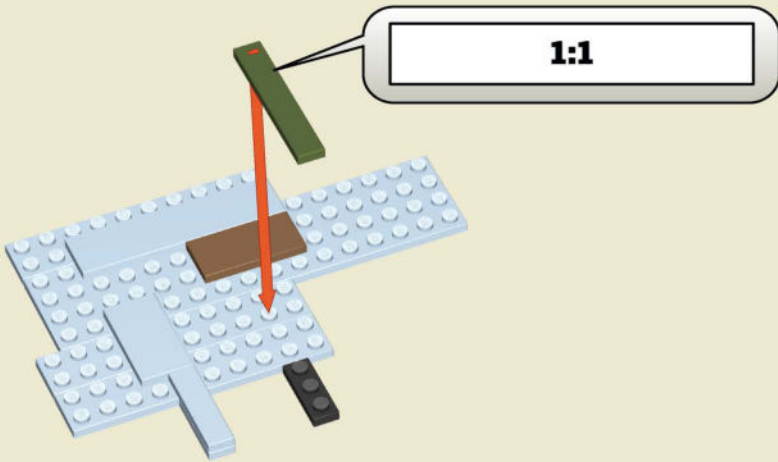

71

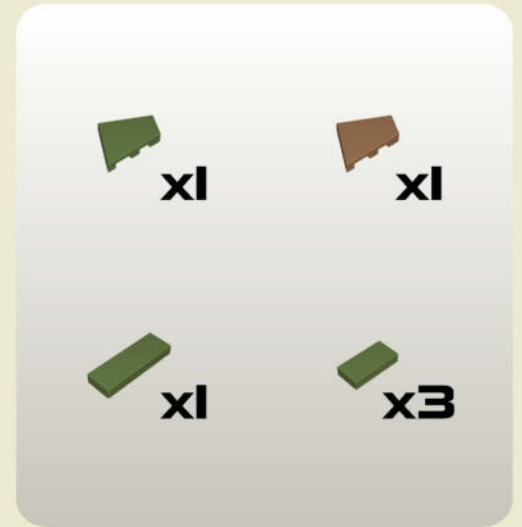
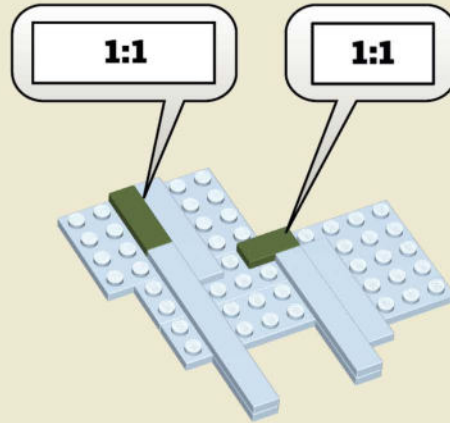
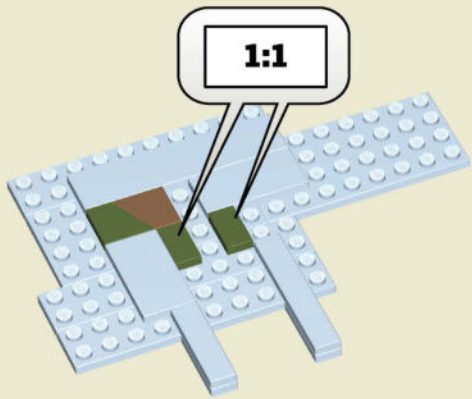

72

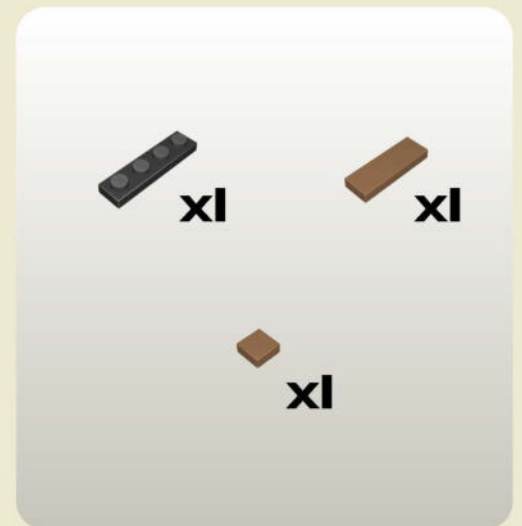
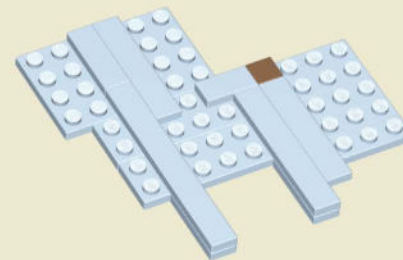
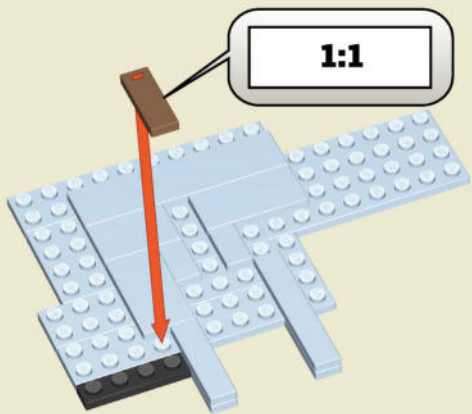

73

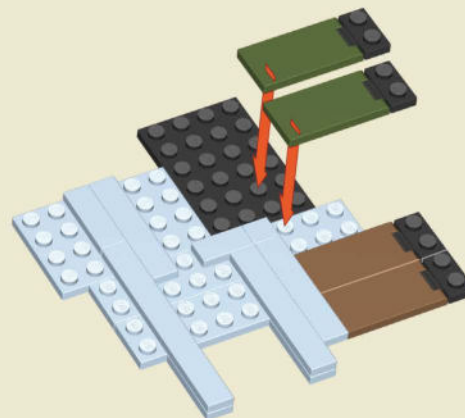
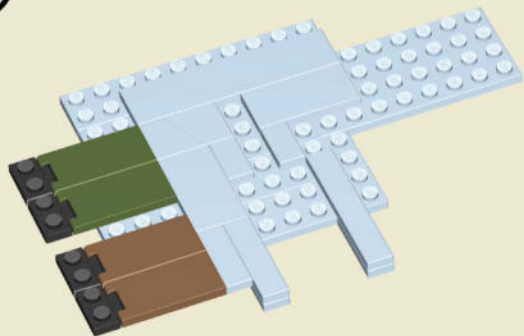

74

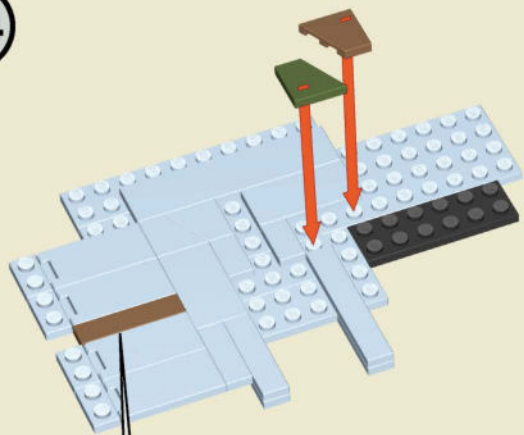

1:1

1:1

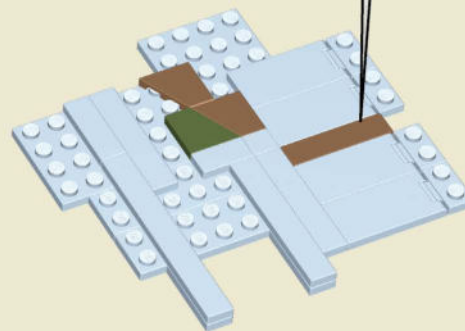

75

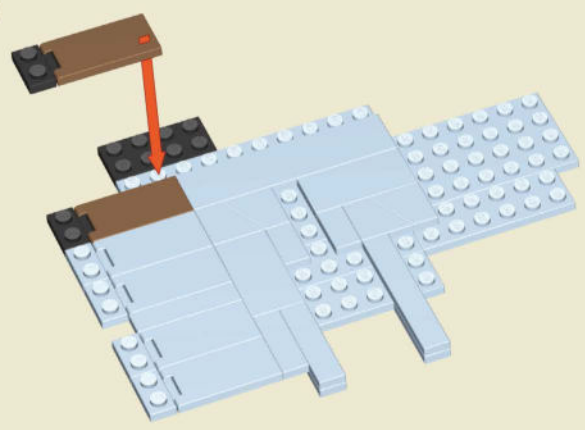

1:1

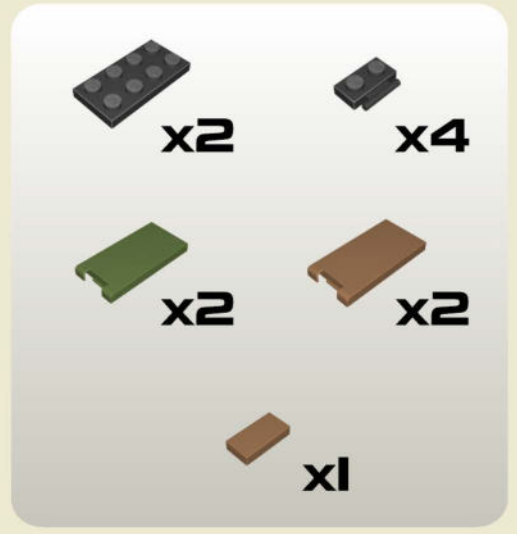
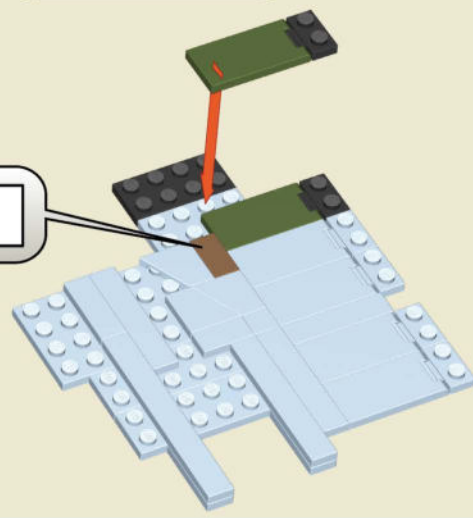

76

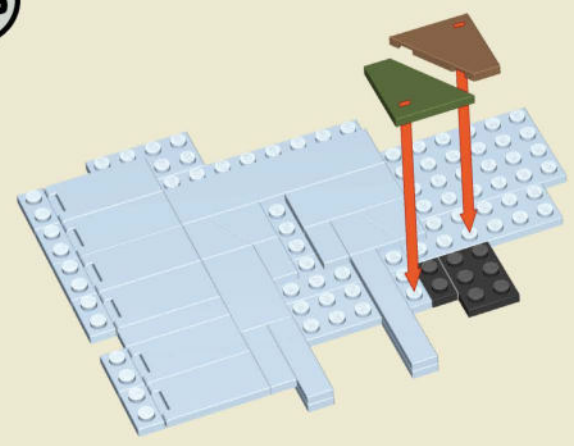

1:1

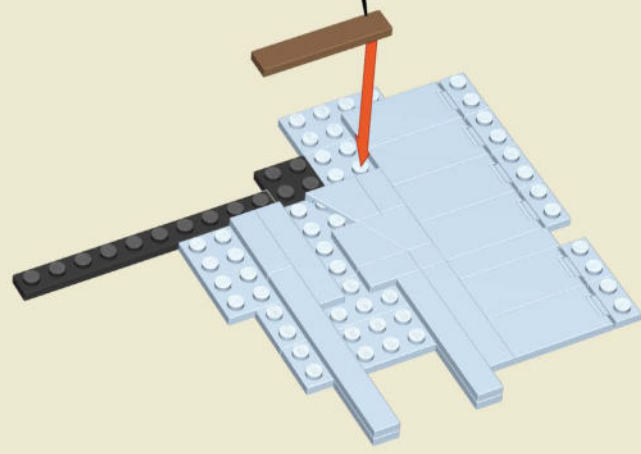

77

1:1

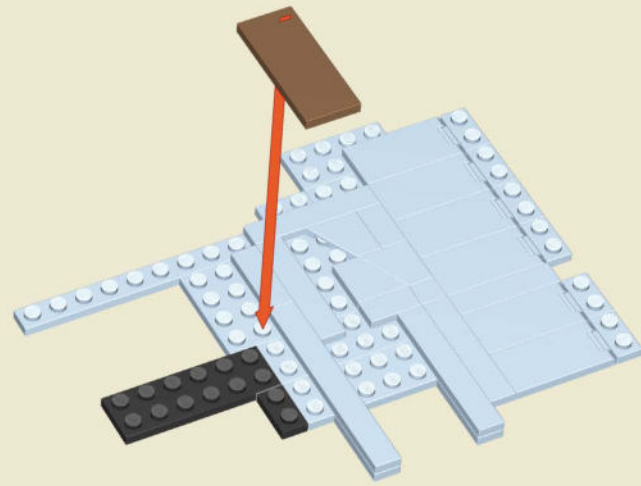
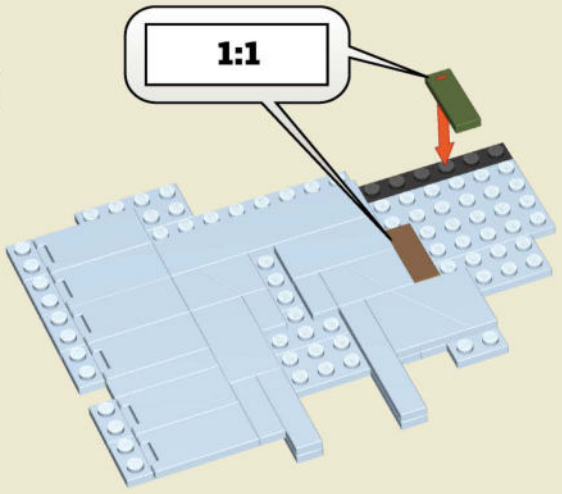

78

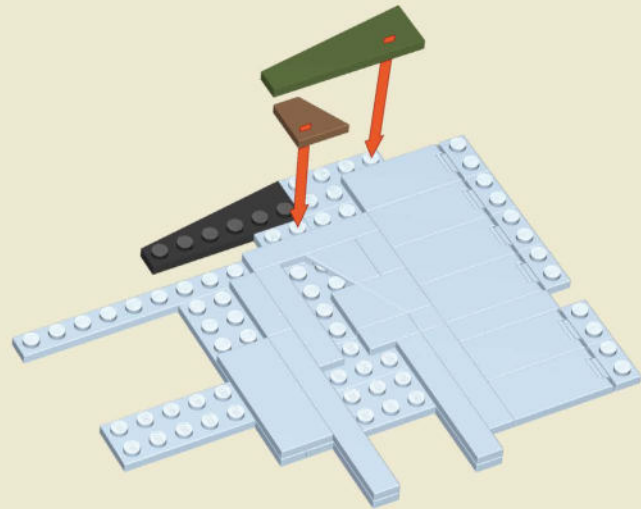
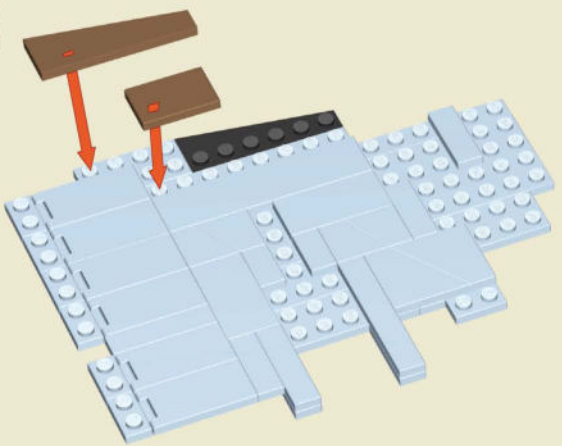

79

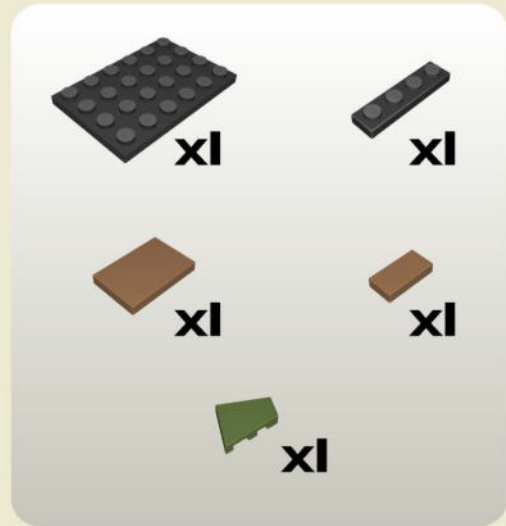
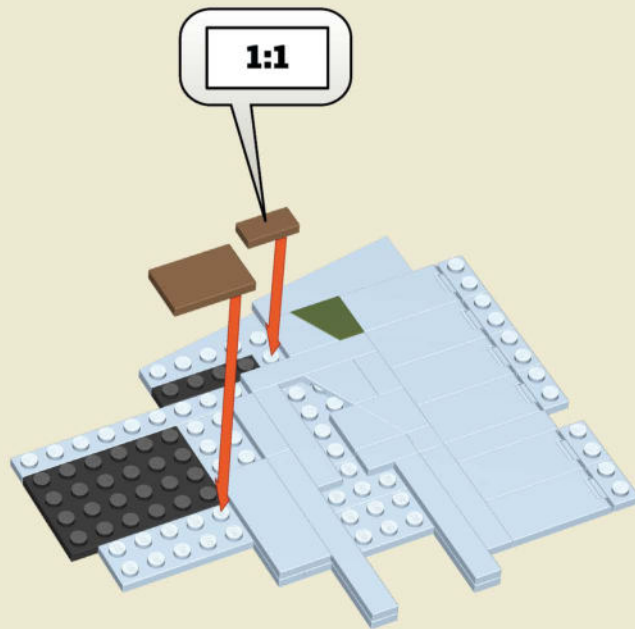
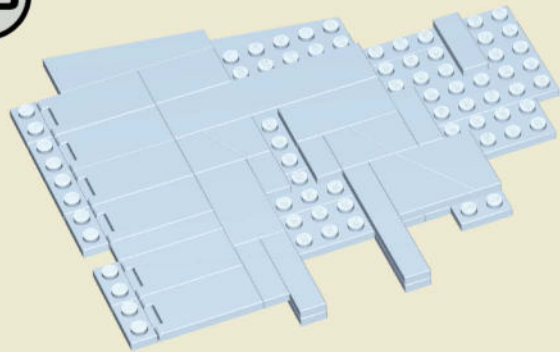

80

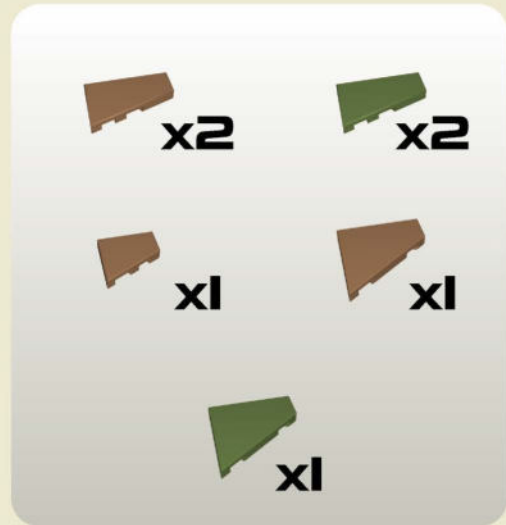
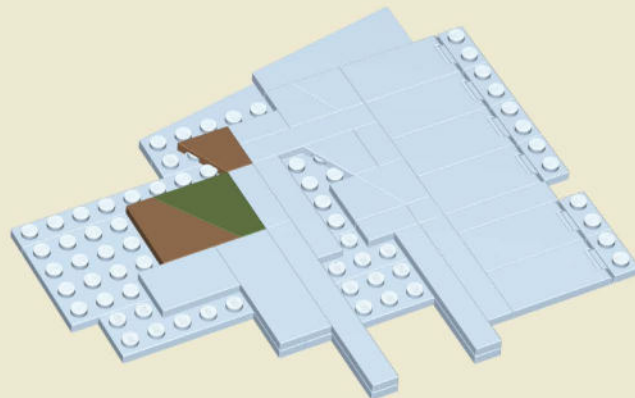
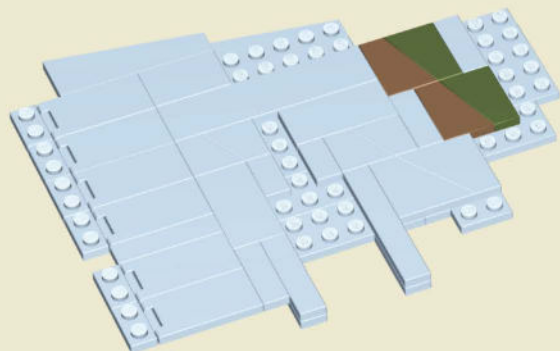

81

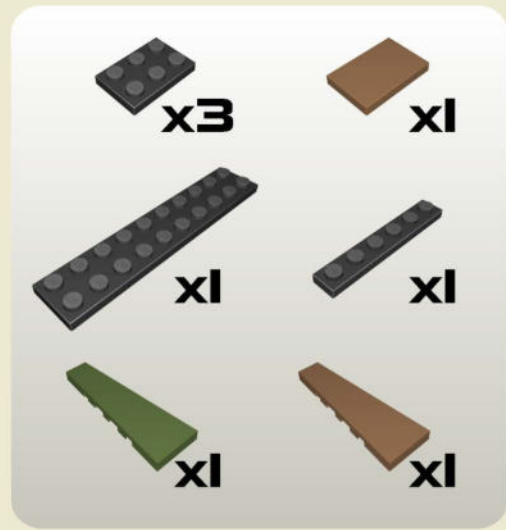
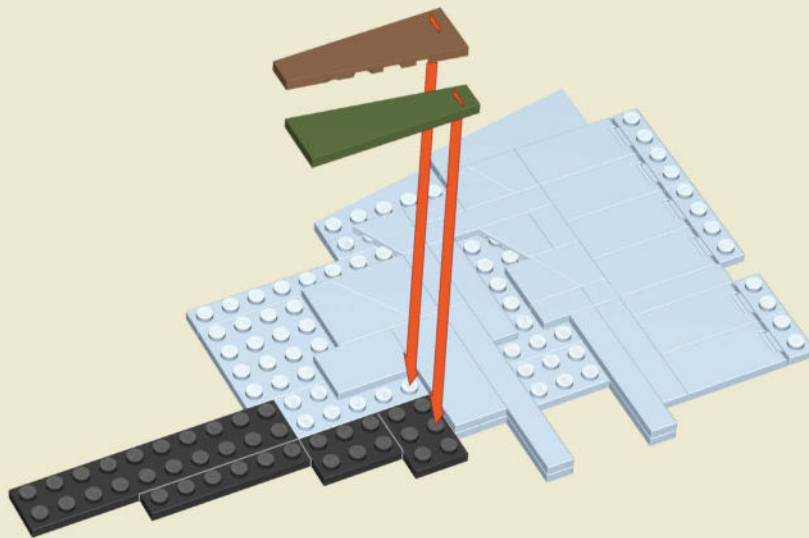
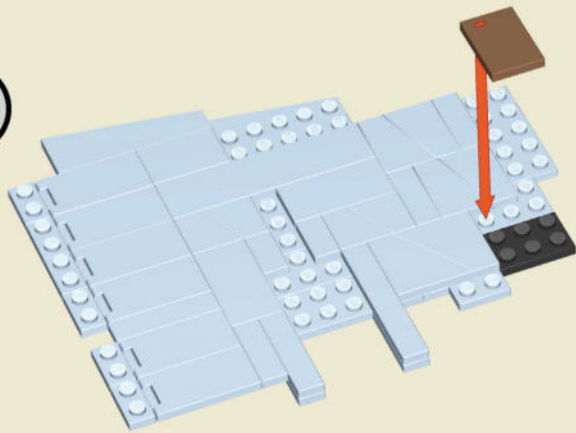

82

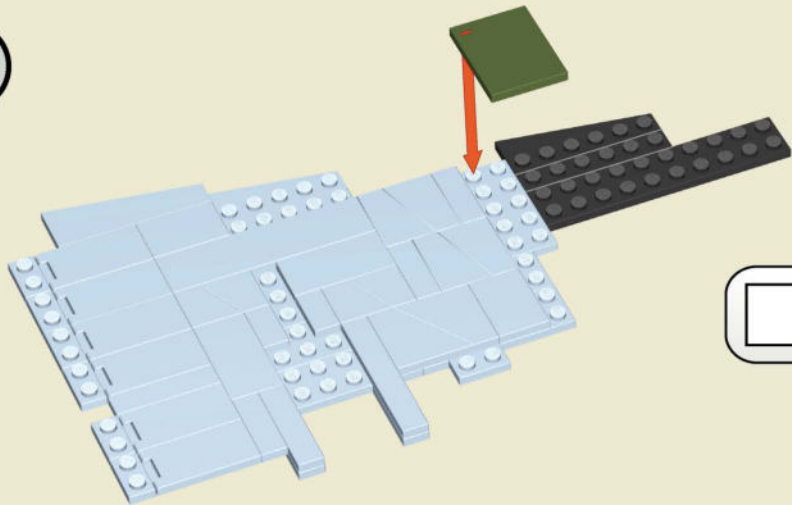

1:1

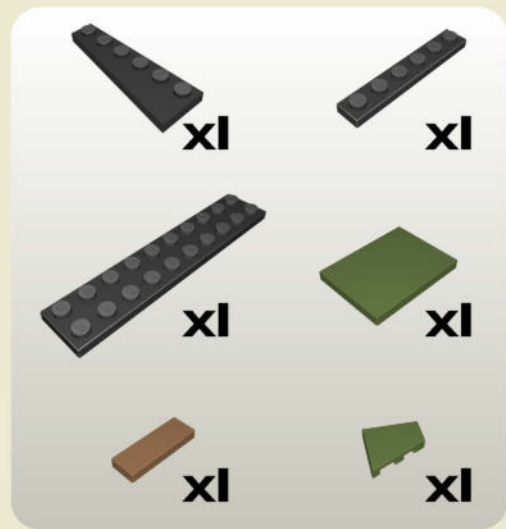
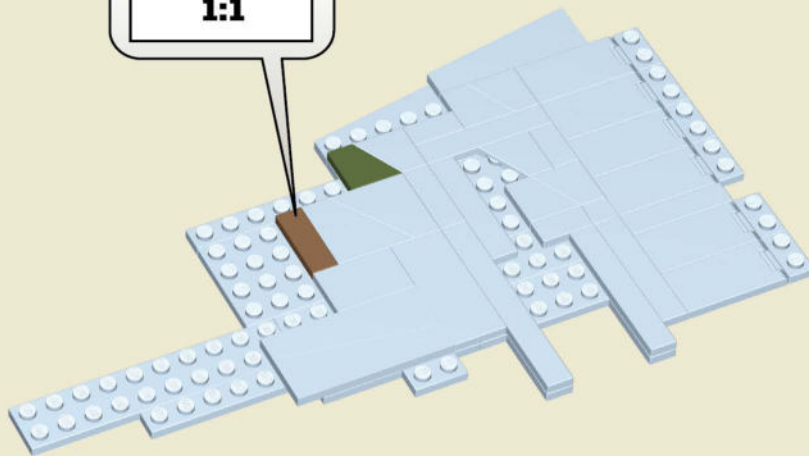

83

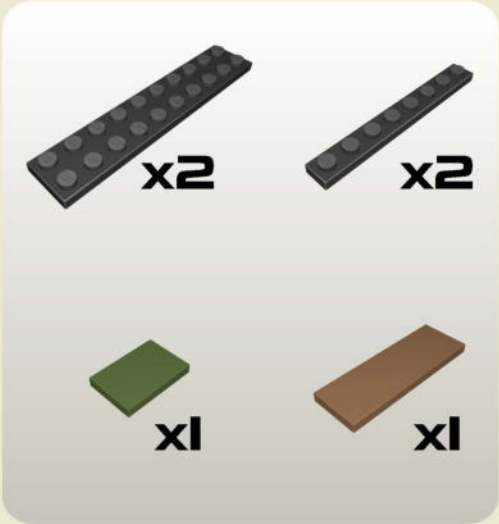
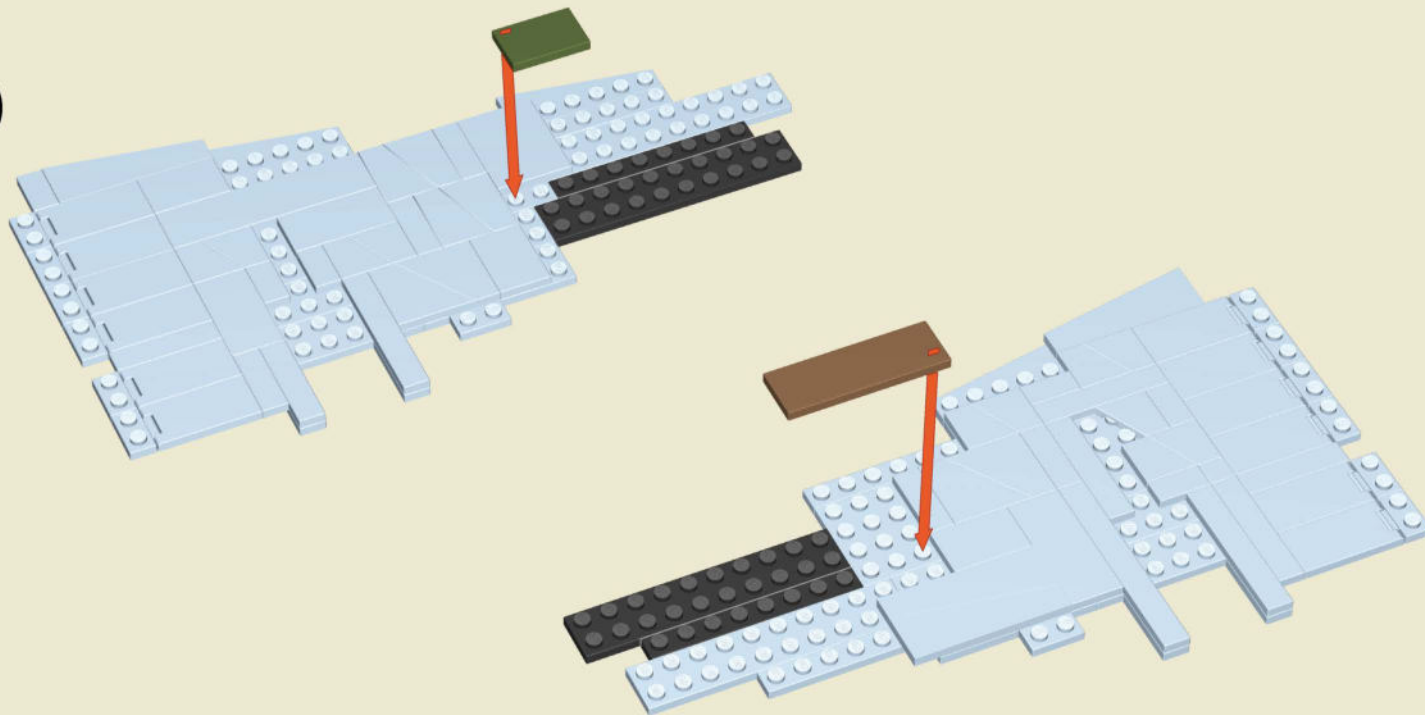



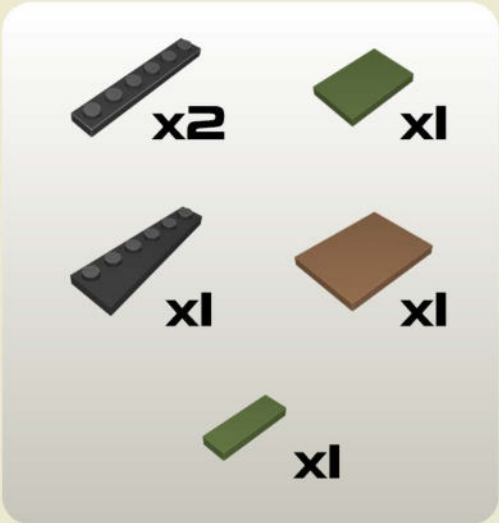
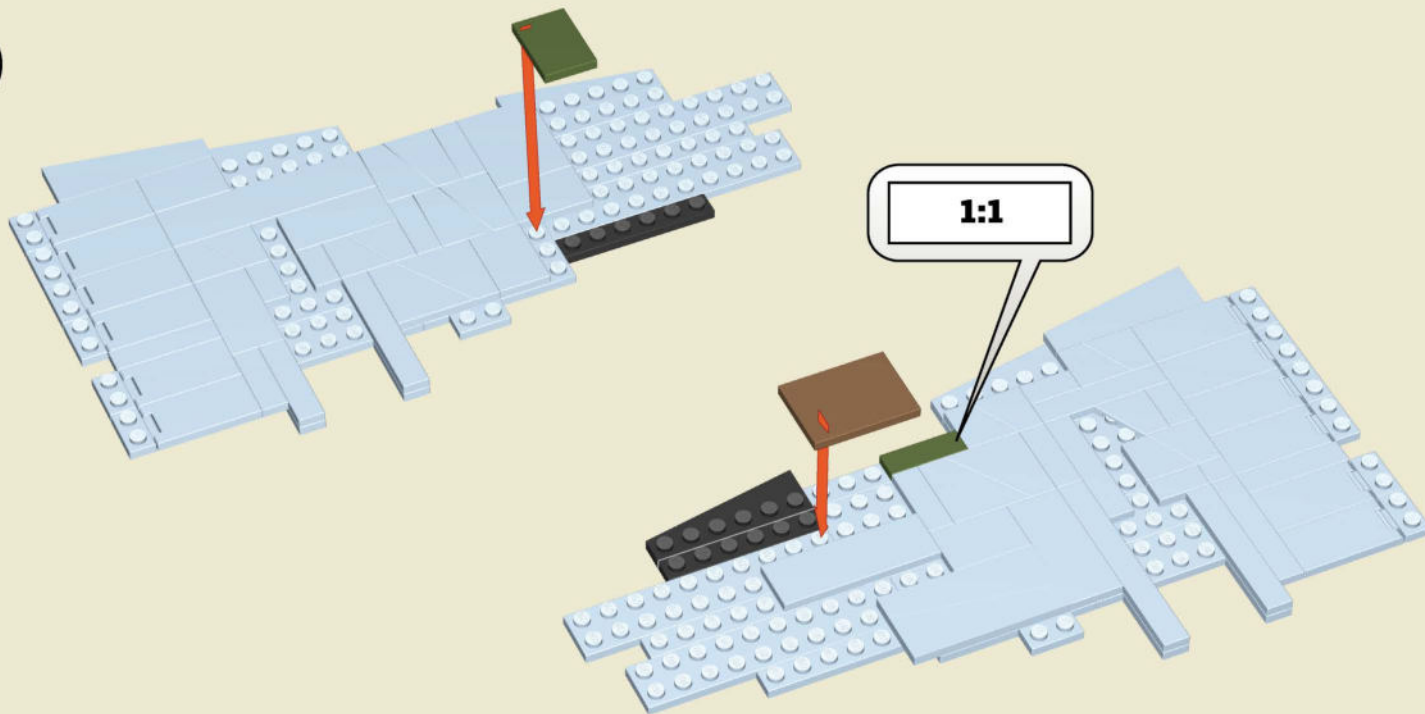

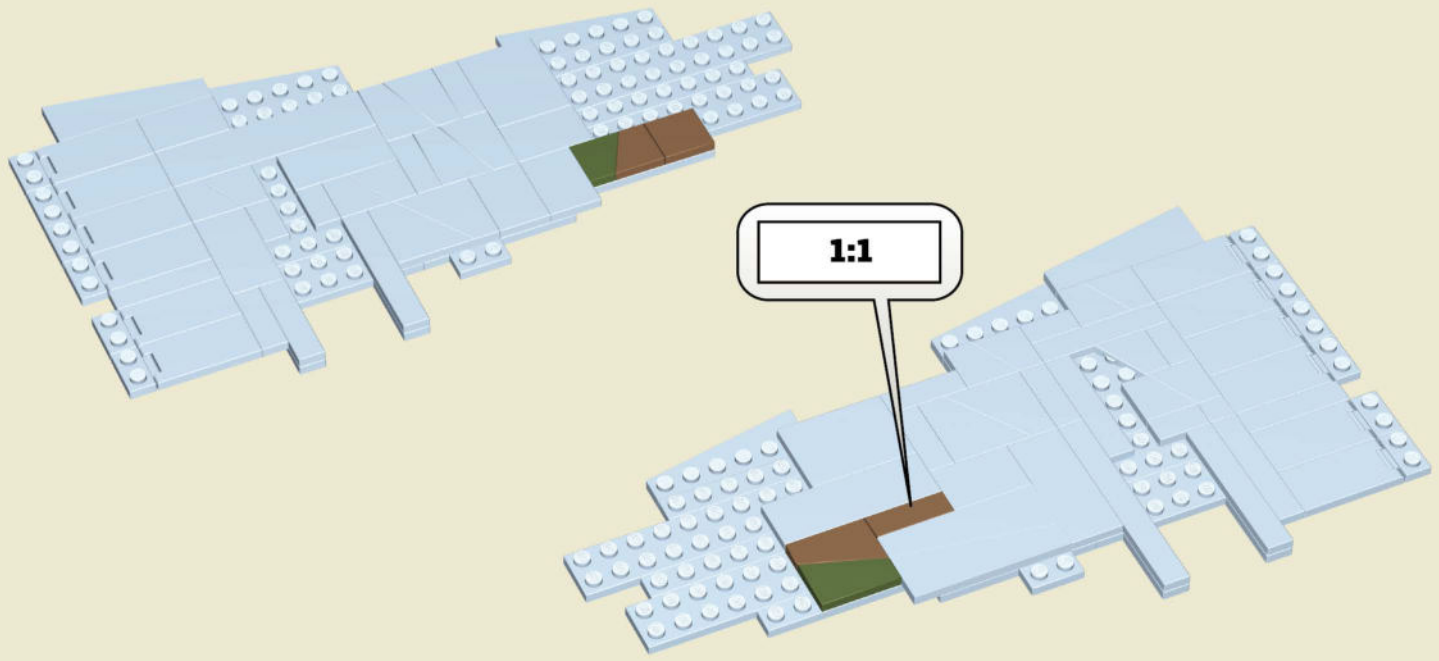

84









85

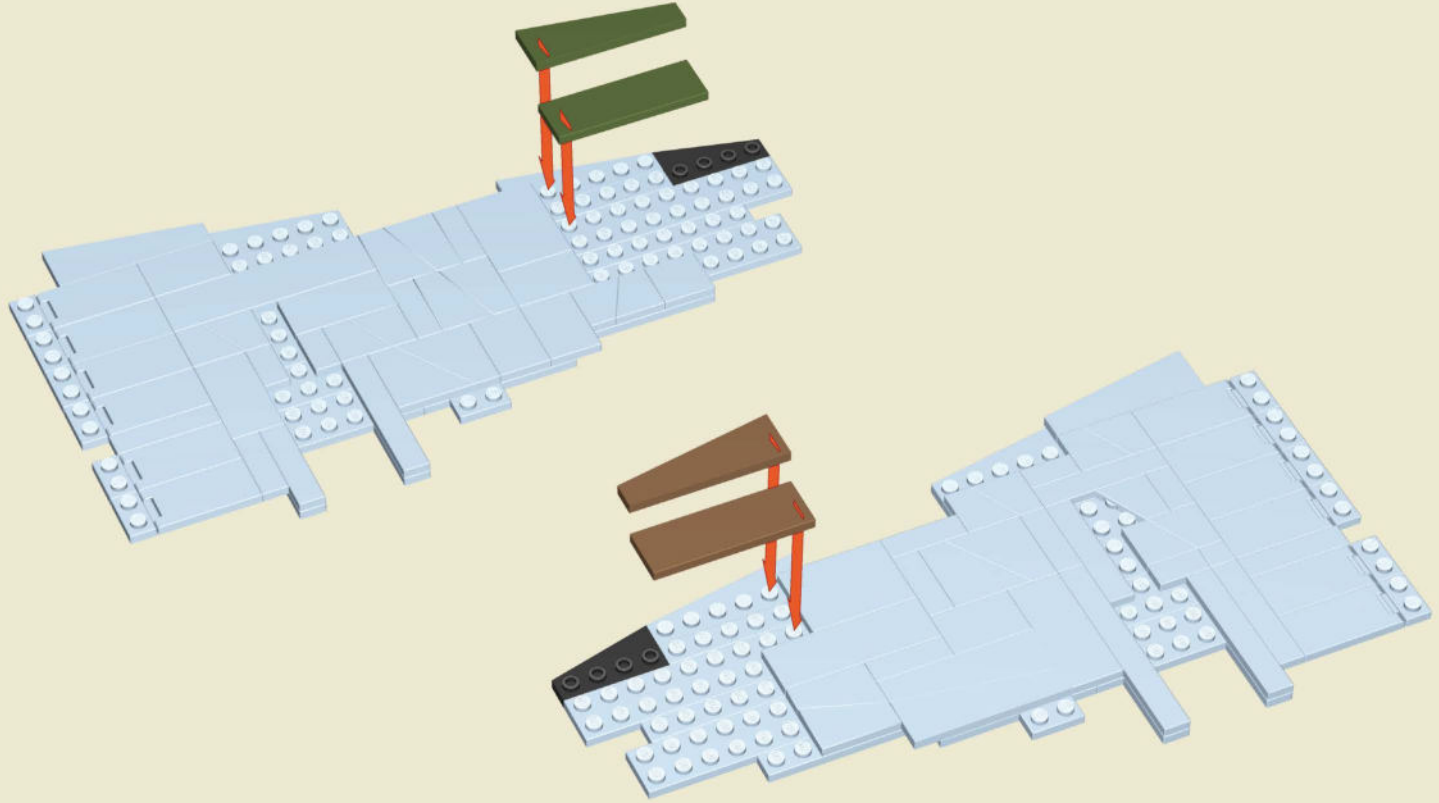

-  xl
-  xl
-  xl
-  xl
-  xl
-  xl

86



-  xl
-  xl
-  xl
-  xl
-  xl
-  xl

87

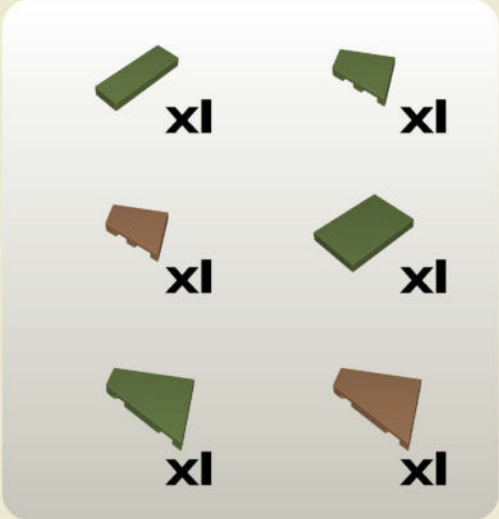
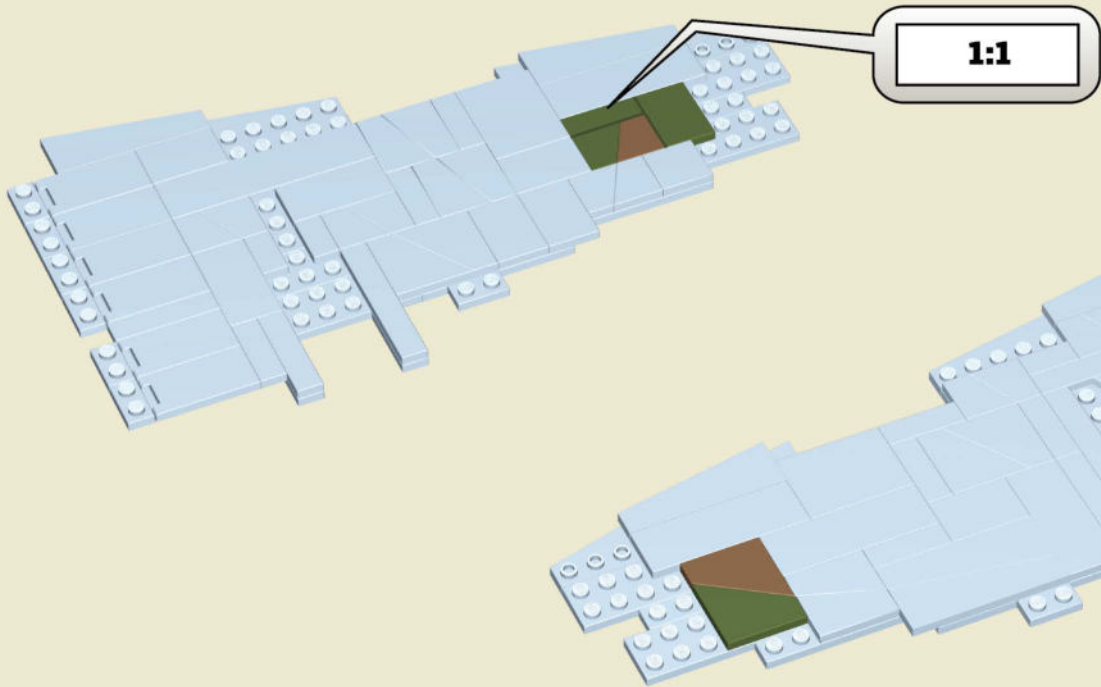

88

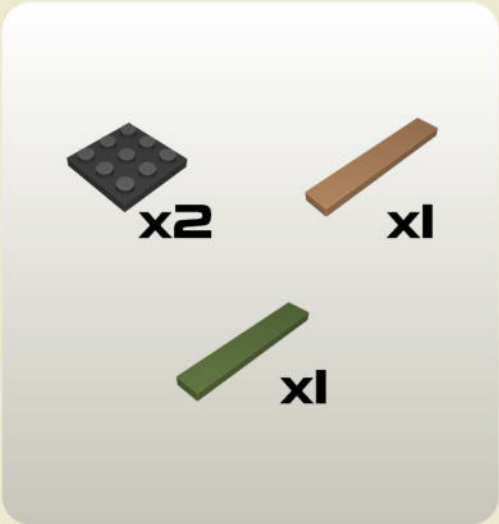
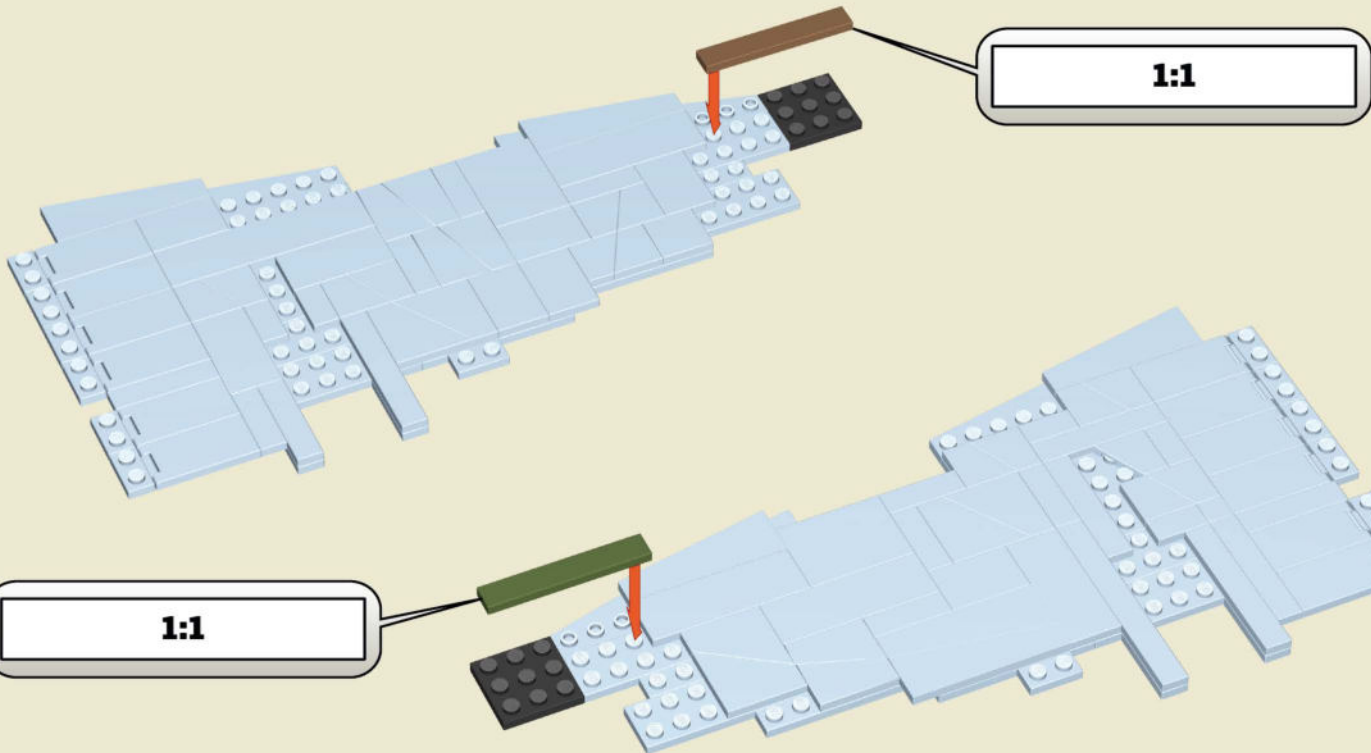

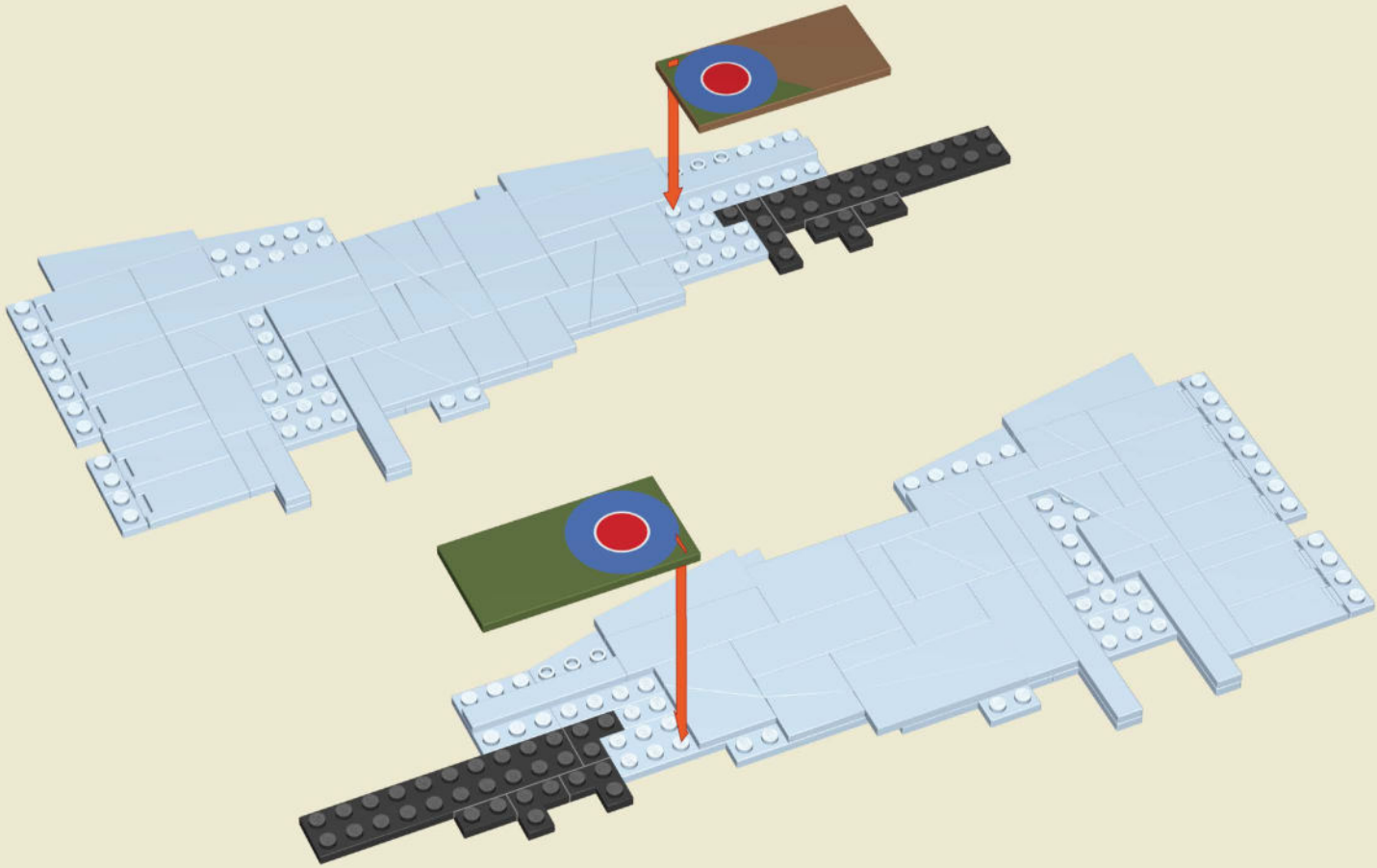

-  x1
-  x1
-  x2
-  x4
-  x2
-  x1
-  x1

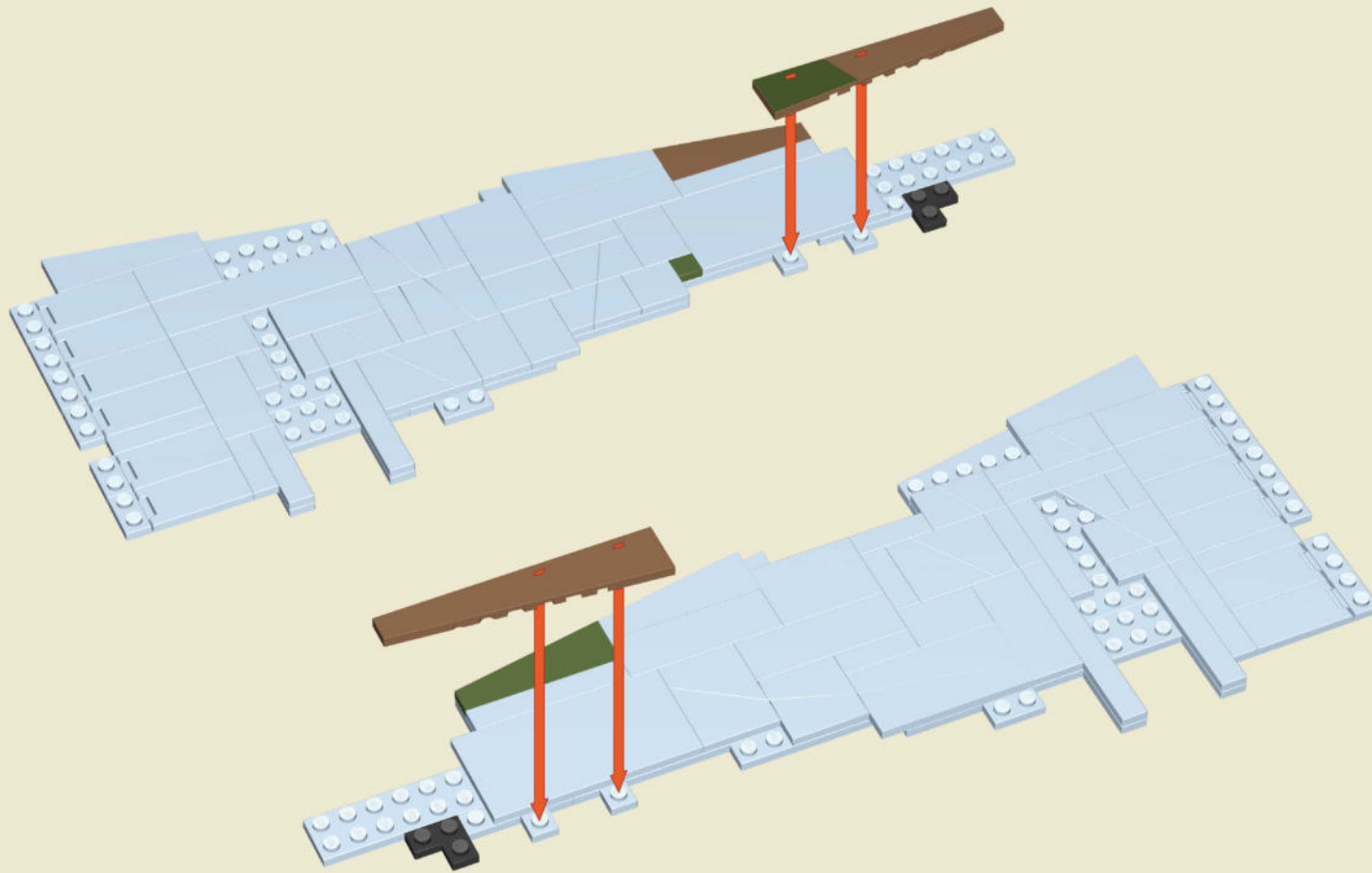

x2



x1



x1



x1



x1

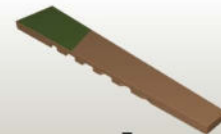

x1

91

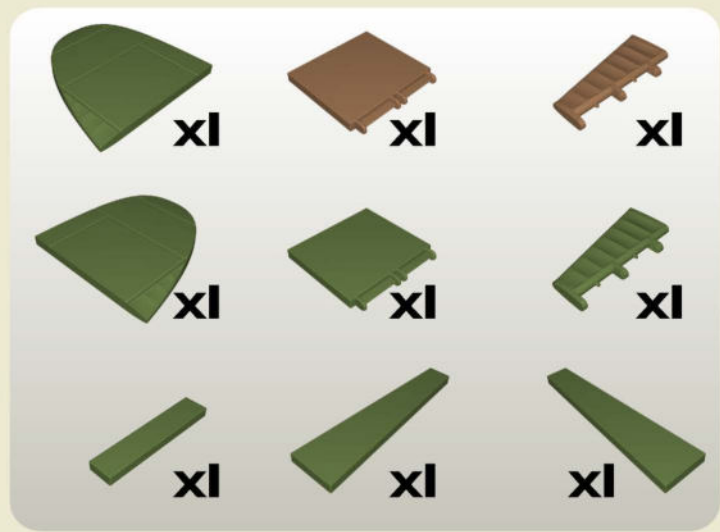
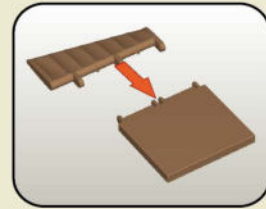
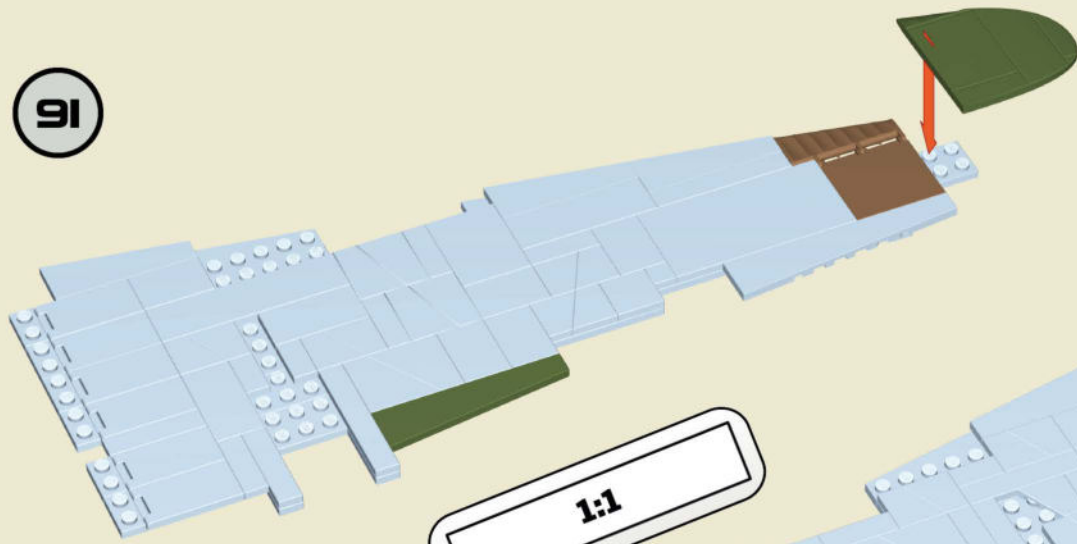

1:1

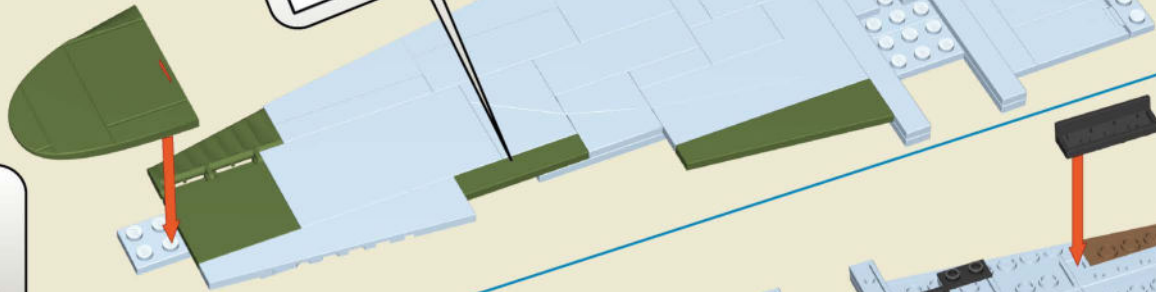

92

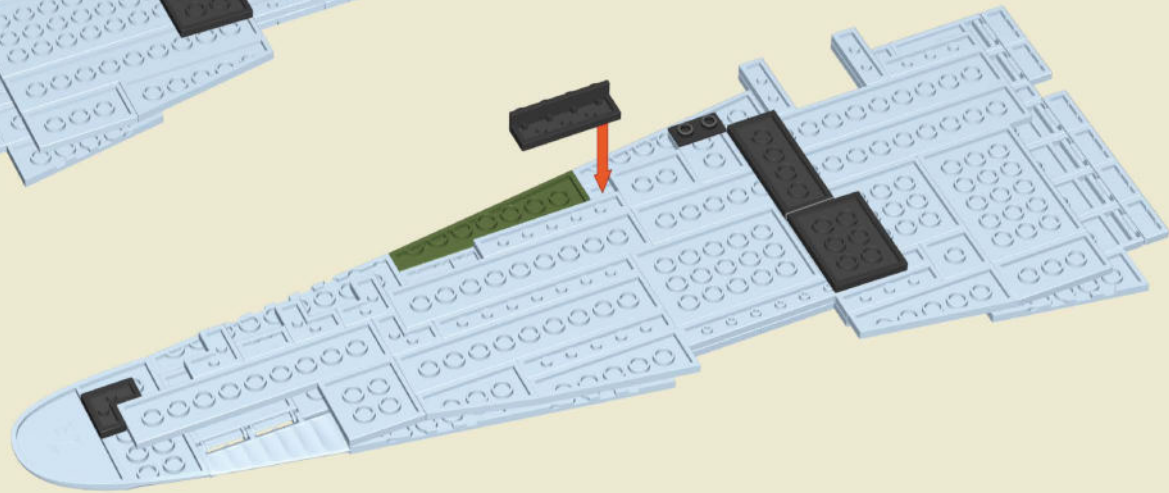
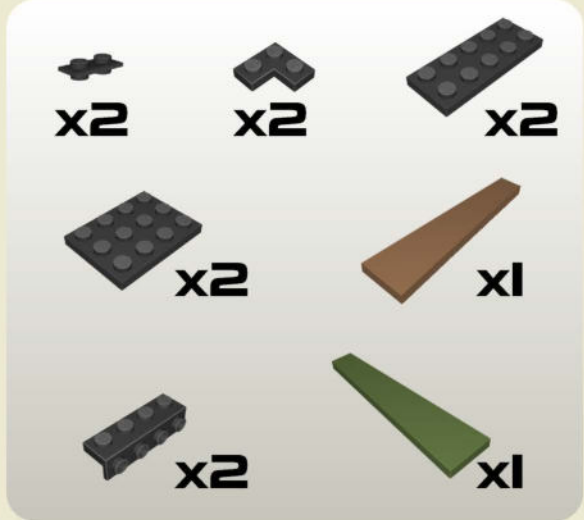
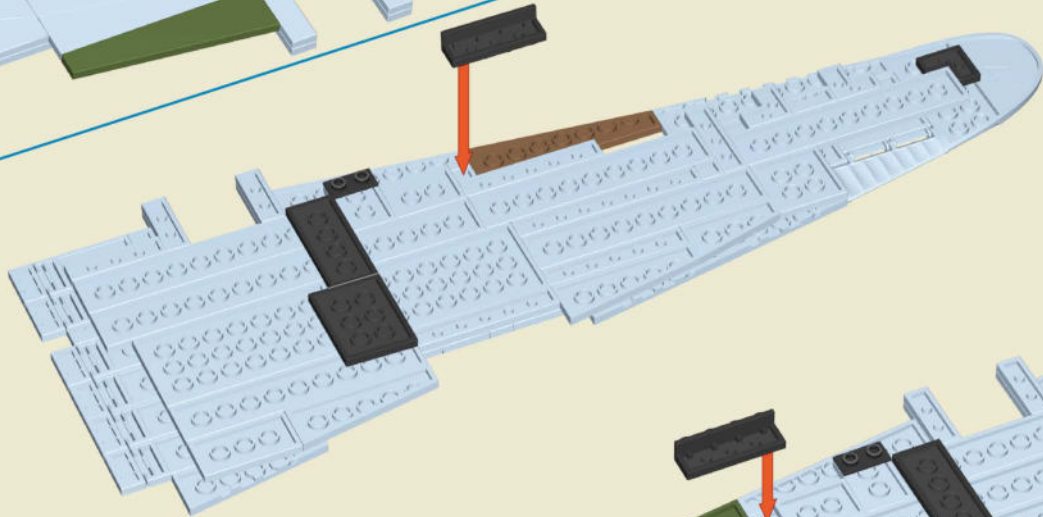

93

1:1

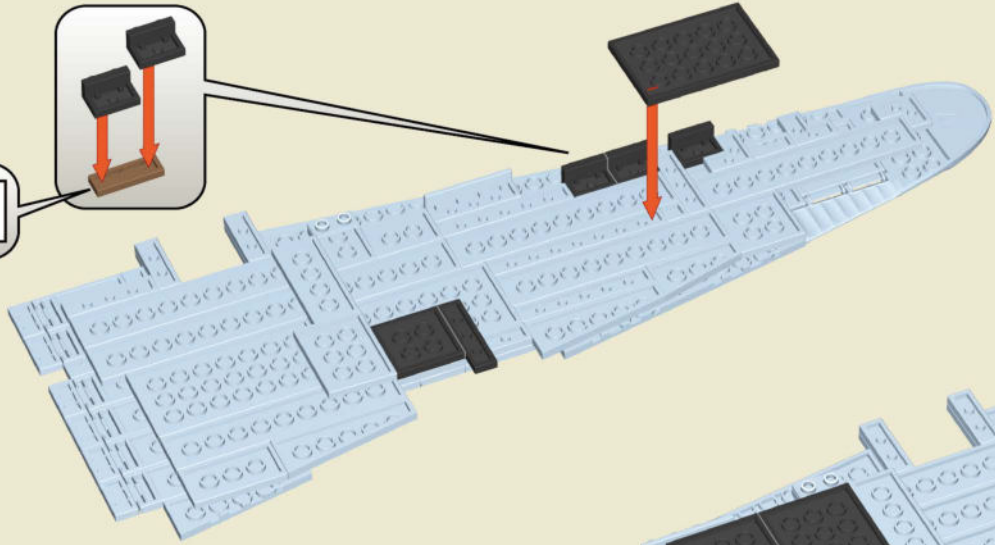

^B
x3

x3

x2

x2

x1

94

x1

x2

x2

x2

x1

x1

x1

1:1

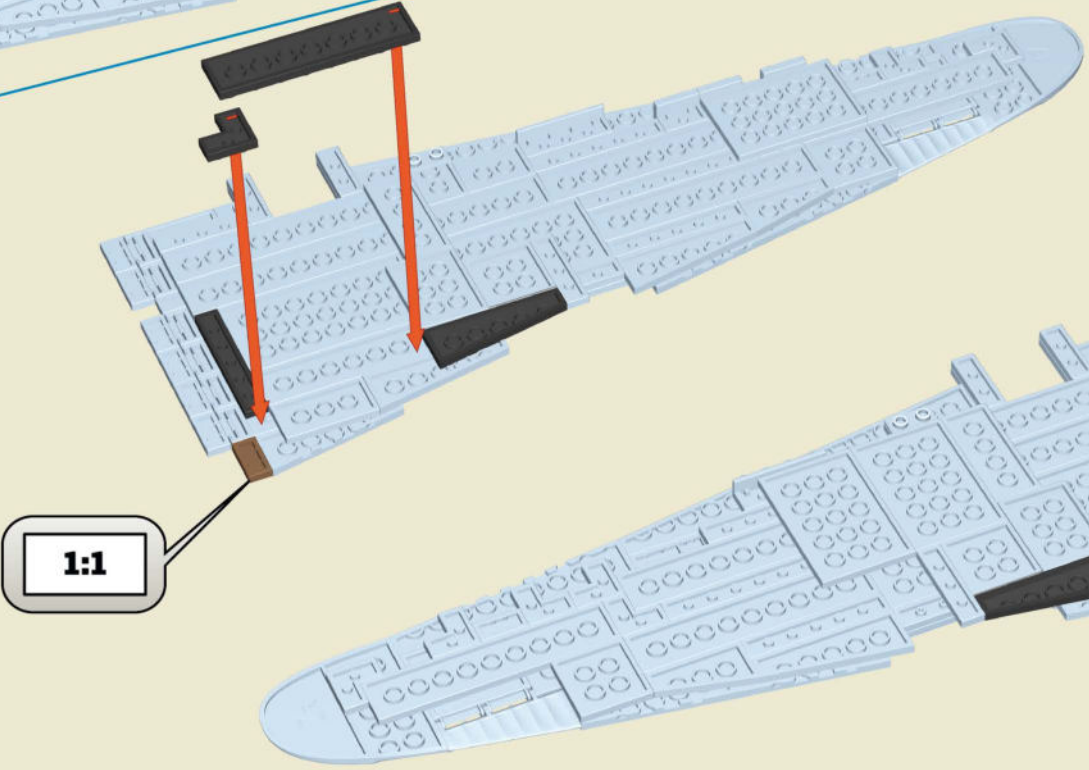

1:1

1:1

95

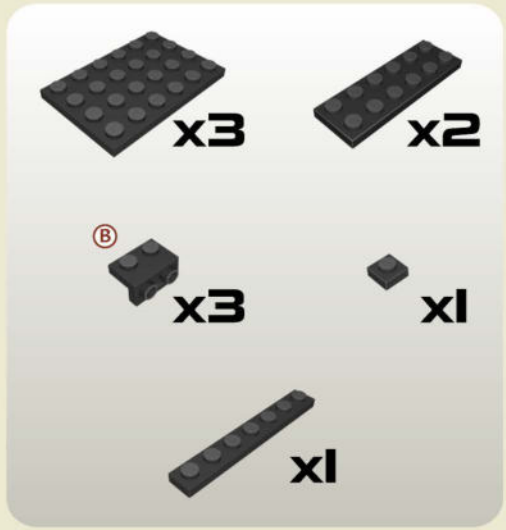
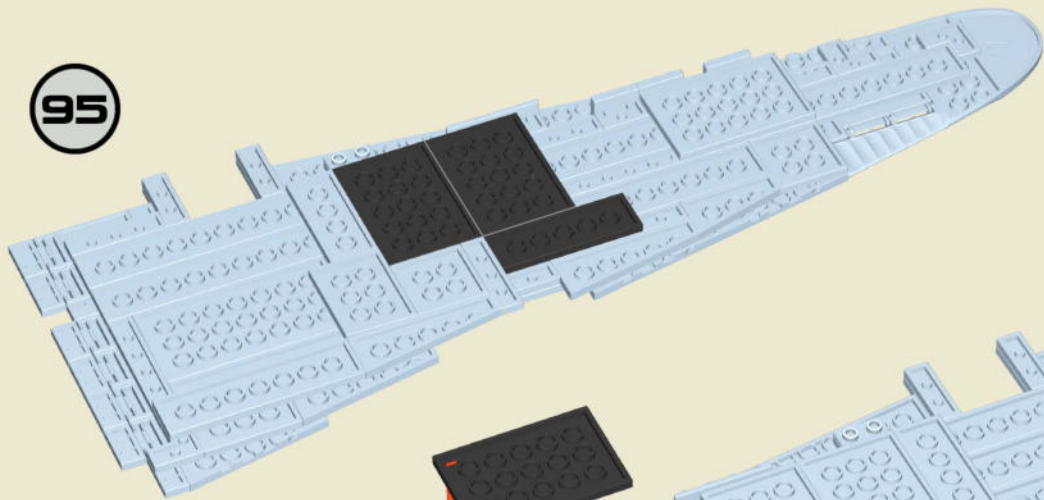

96

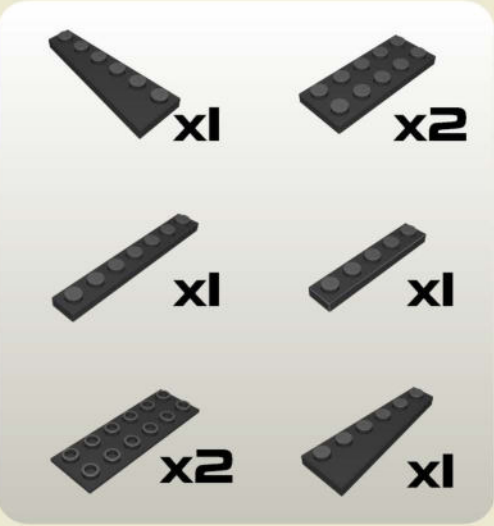
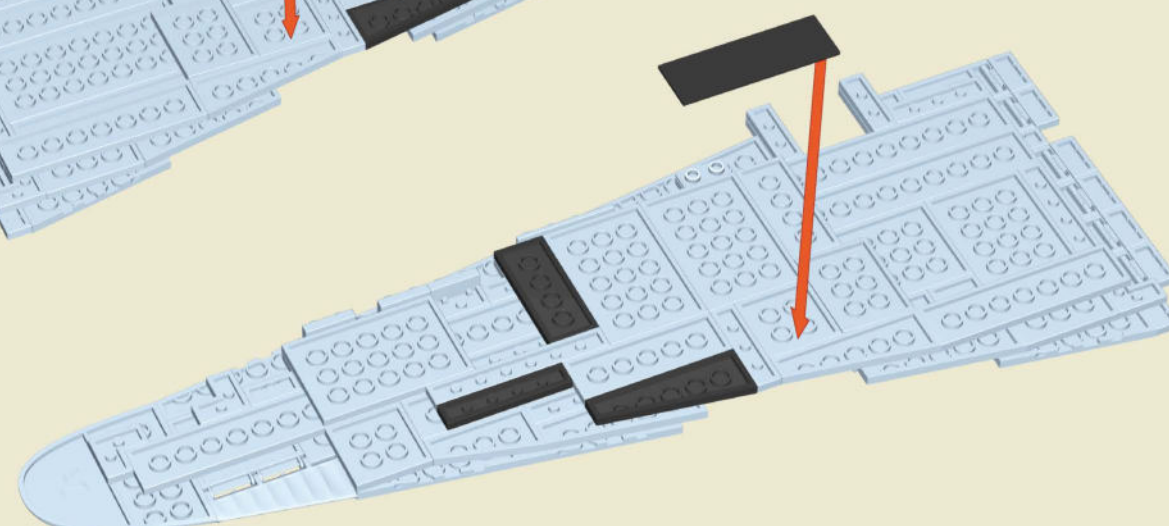
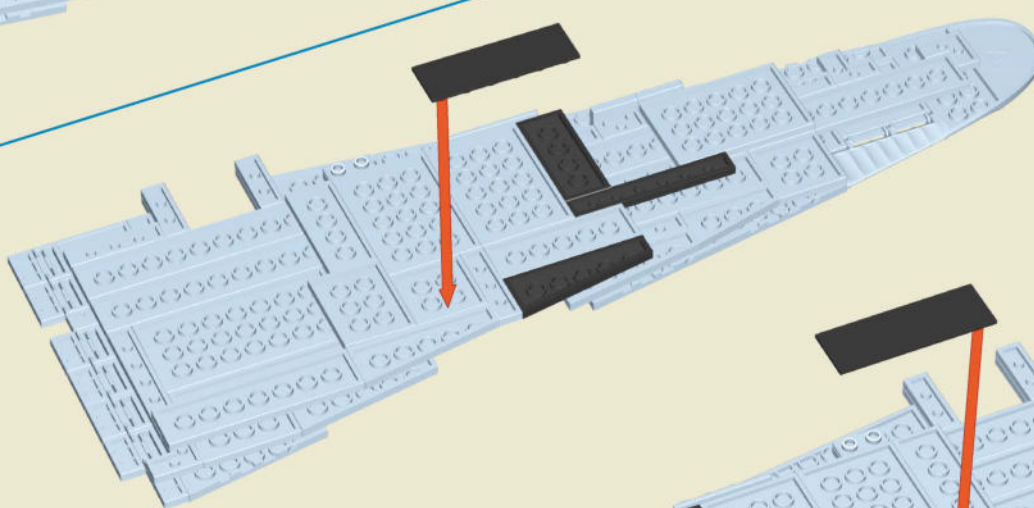
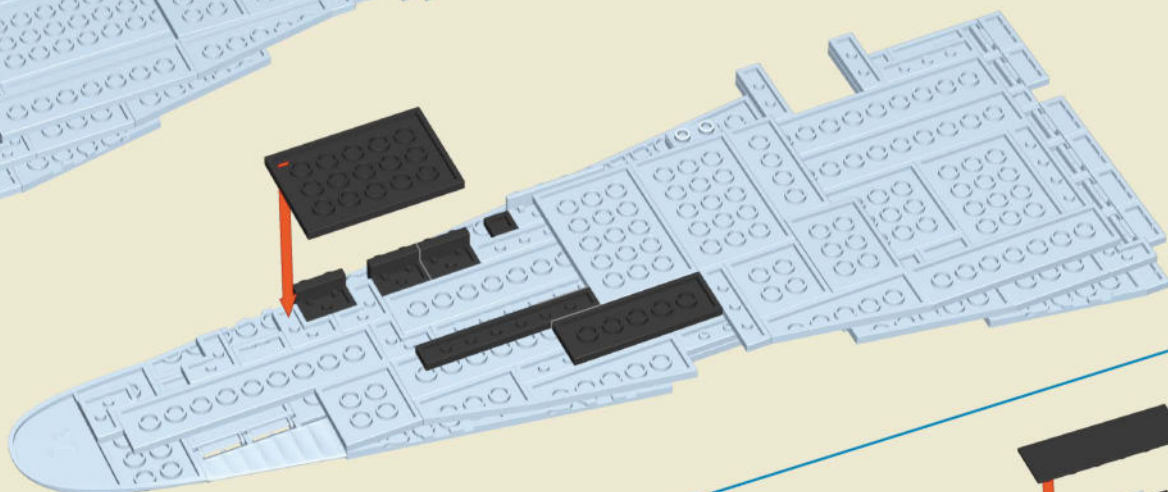

97

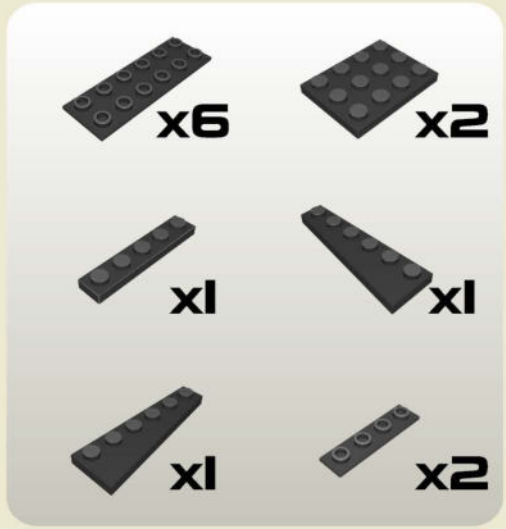
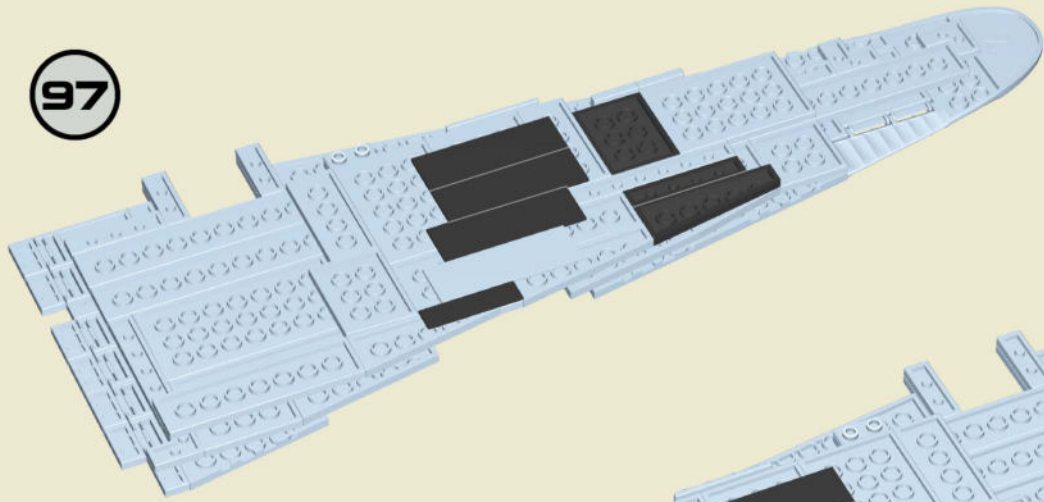

98

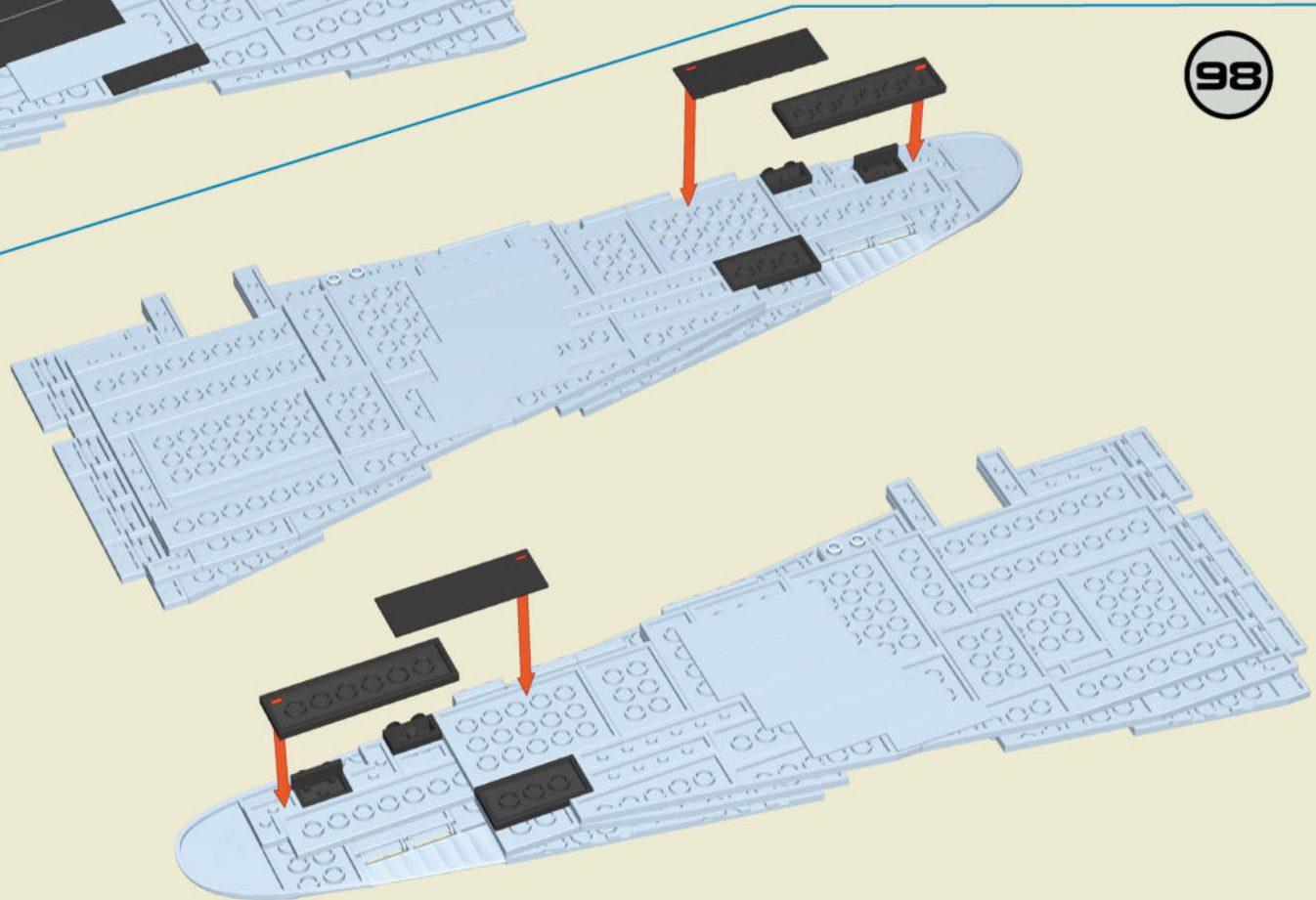

99





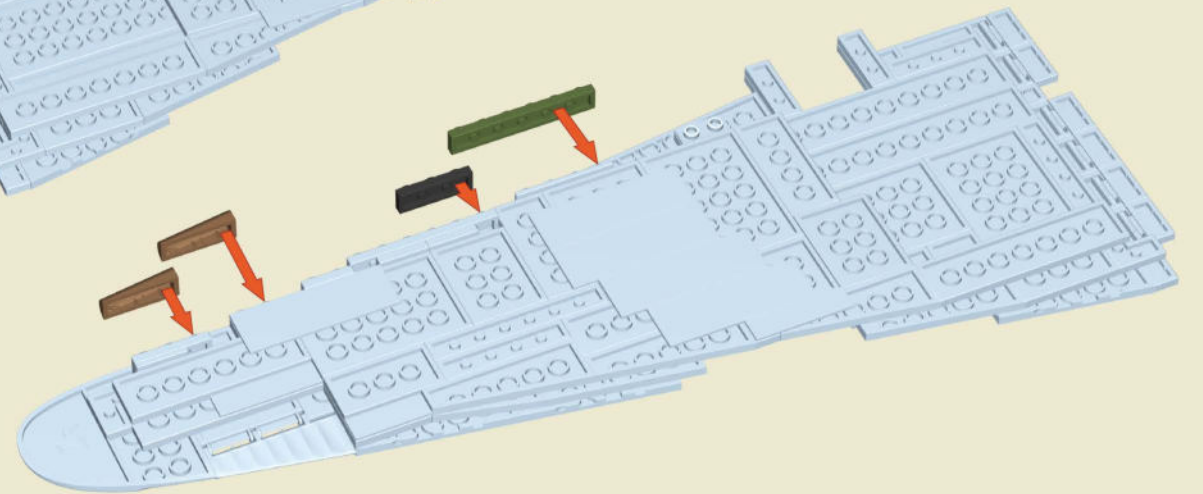

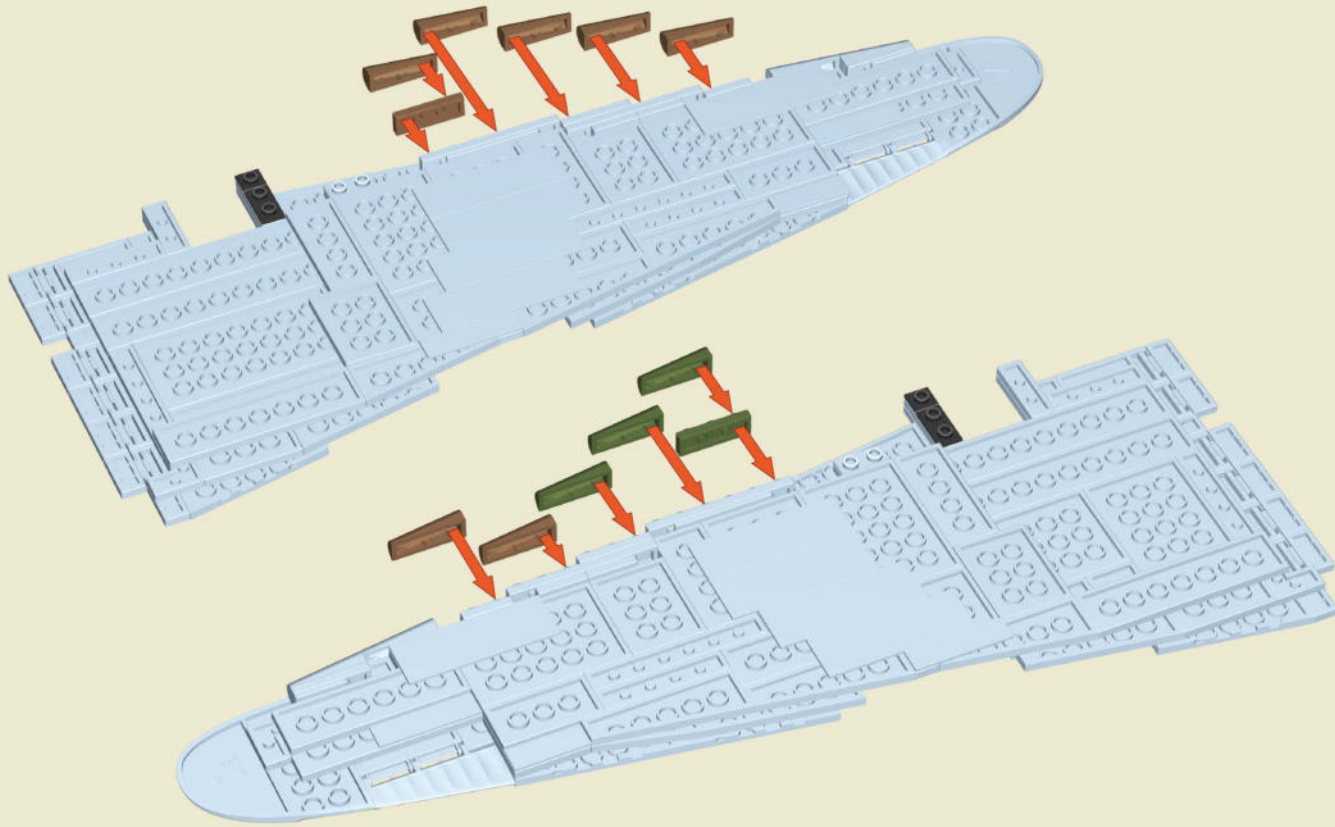

100



101



 x2	 x2
 x1	 x7
 x1	 x3

102

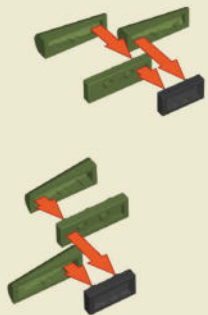

 x4
 x2
 x2

103

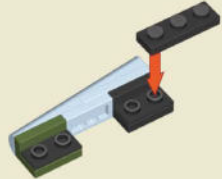

 x2
 x4
 x2
 x2

104

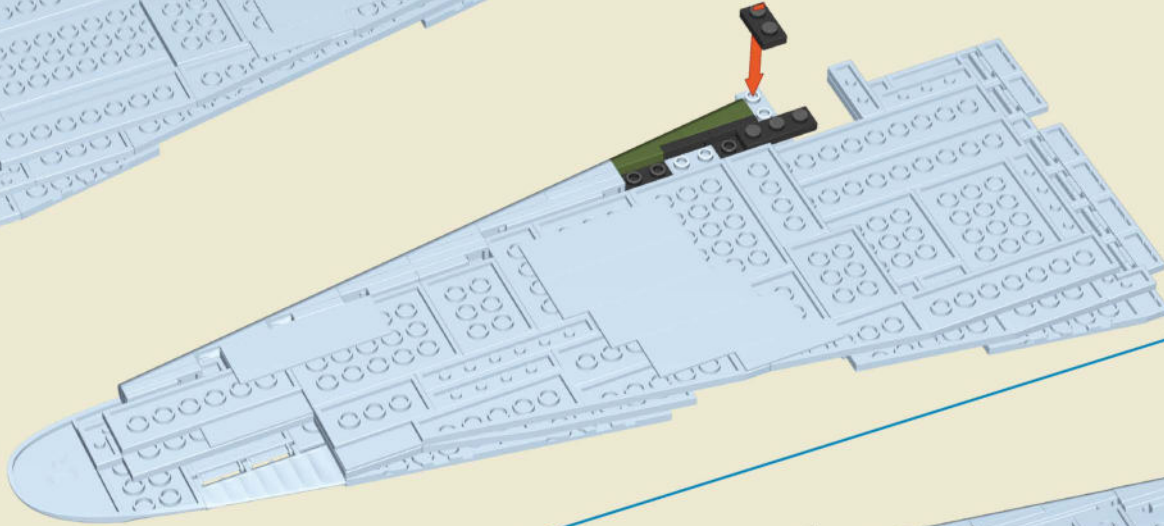

x2

105

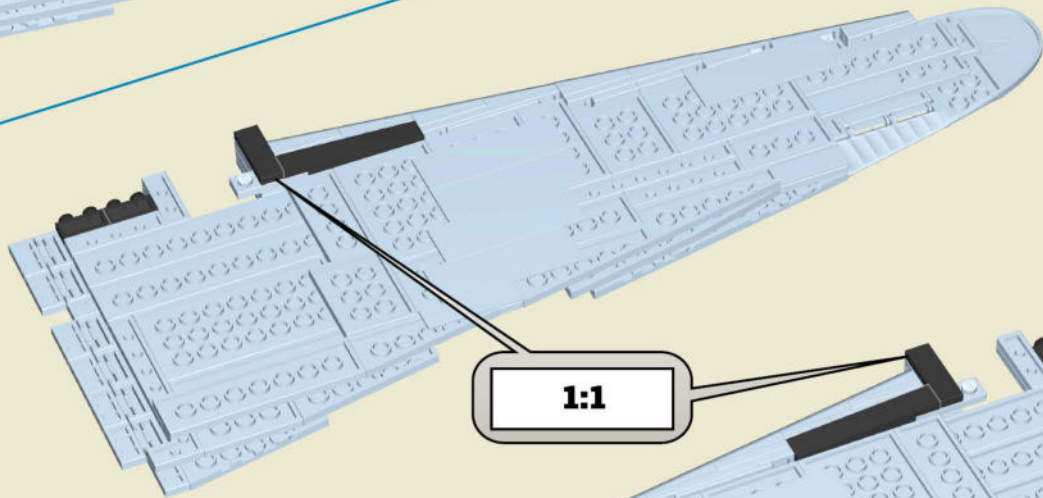

1:1



x4



x2



x2



x2

106



 x4

 x2

 x16

 x2

107

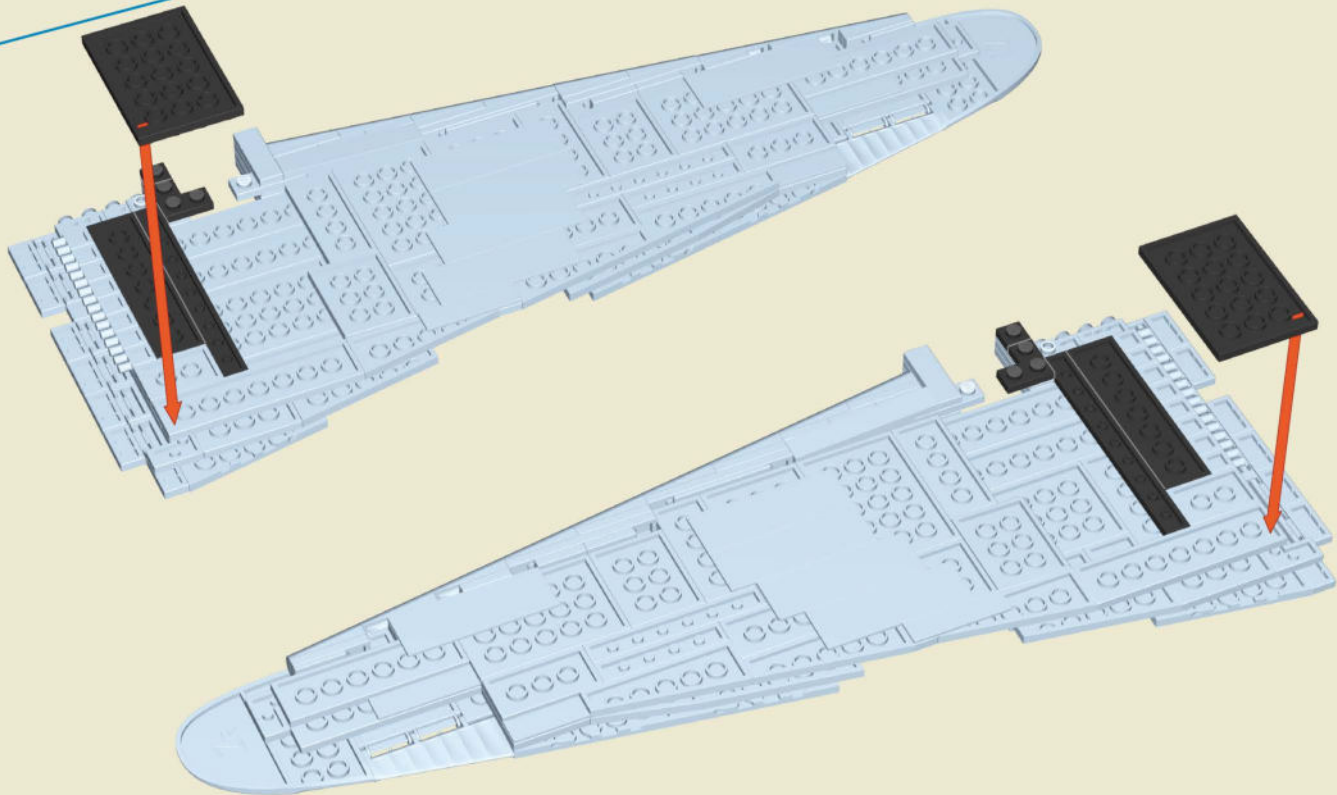

 x2

 x2

 x2

 x2

 x2

108

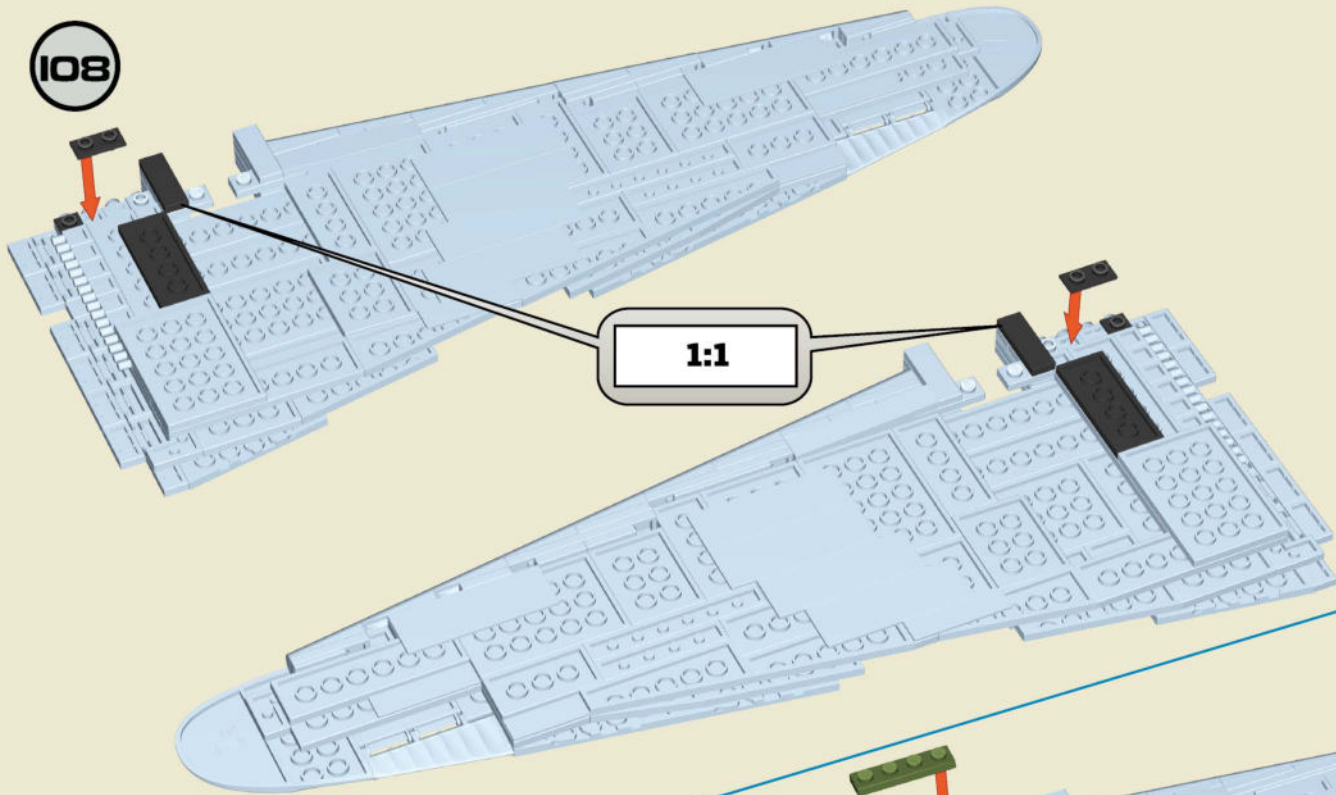

1:1

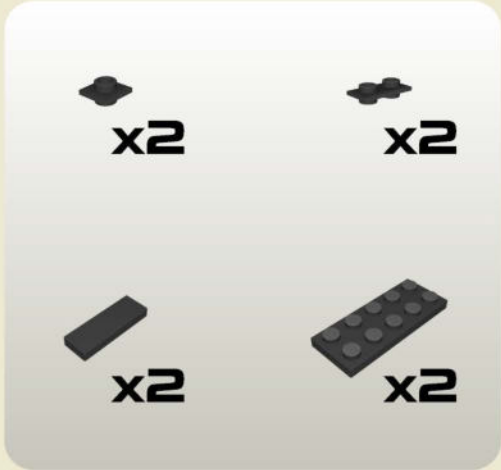

109

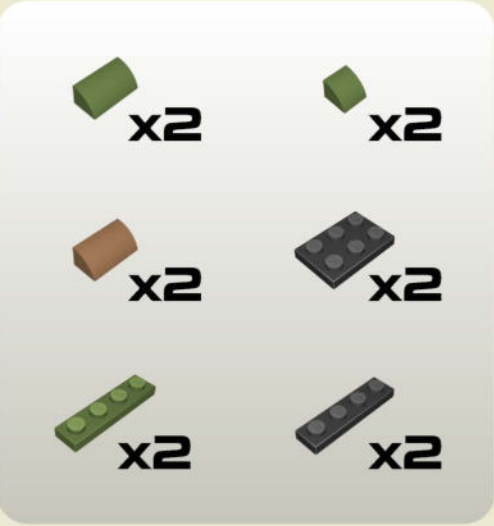
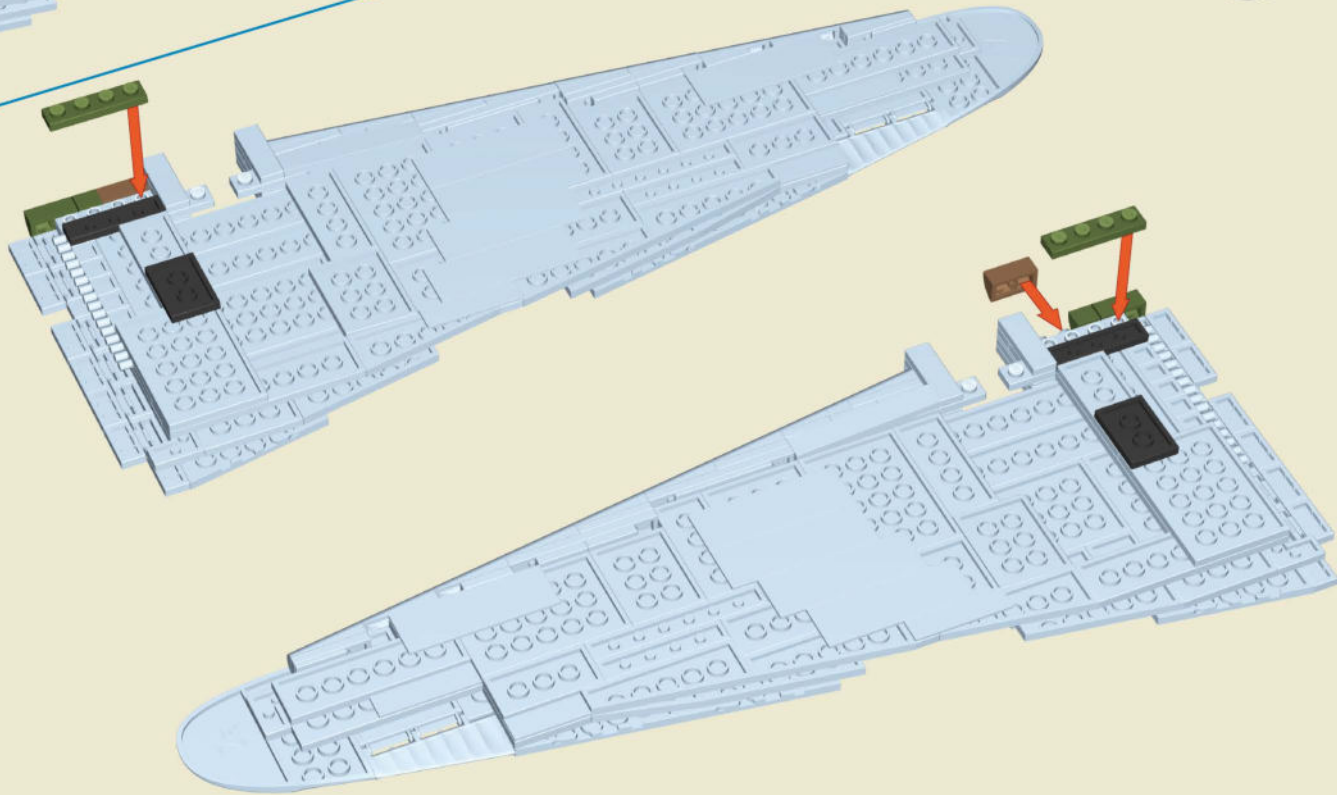

110

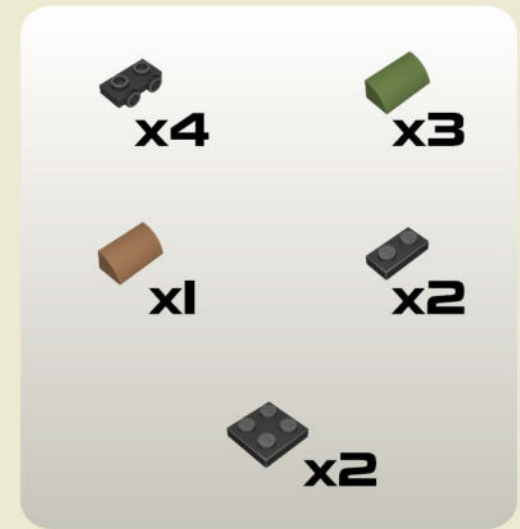
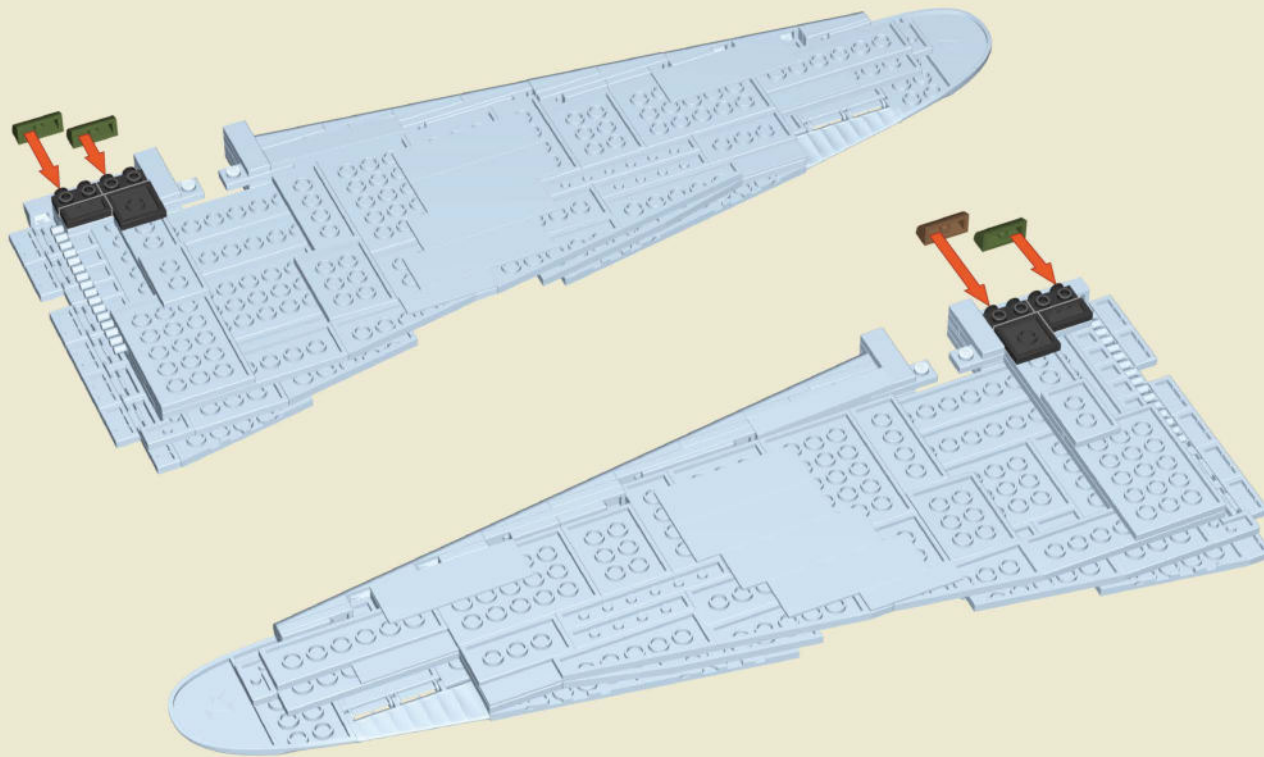

111

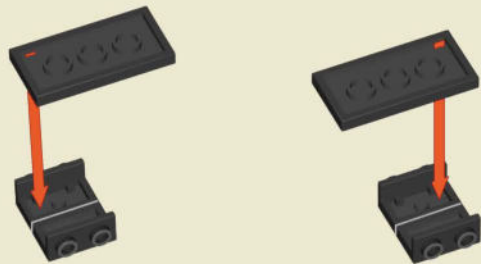

112



113

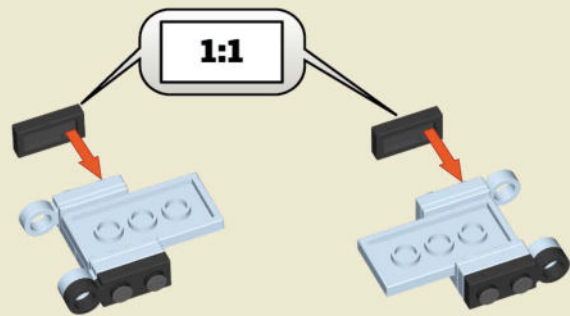

114

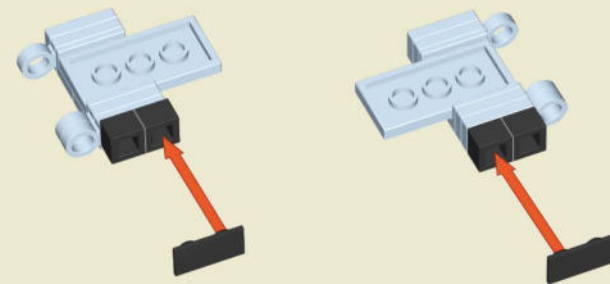

115

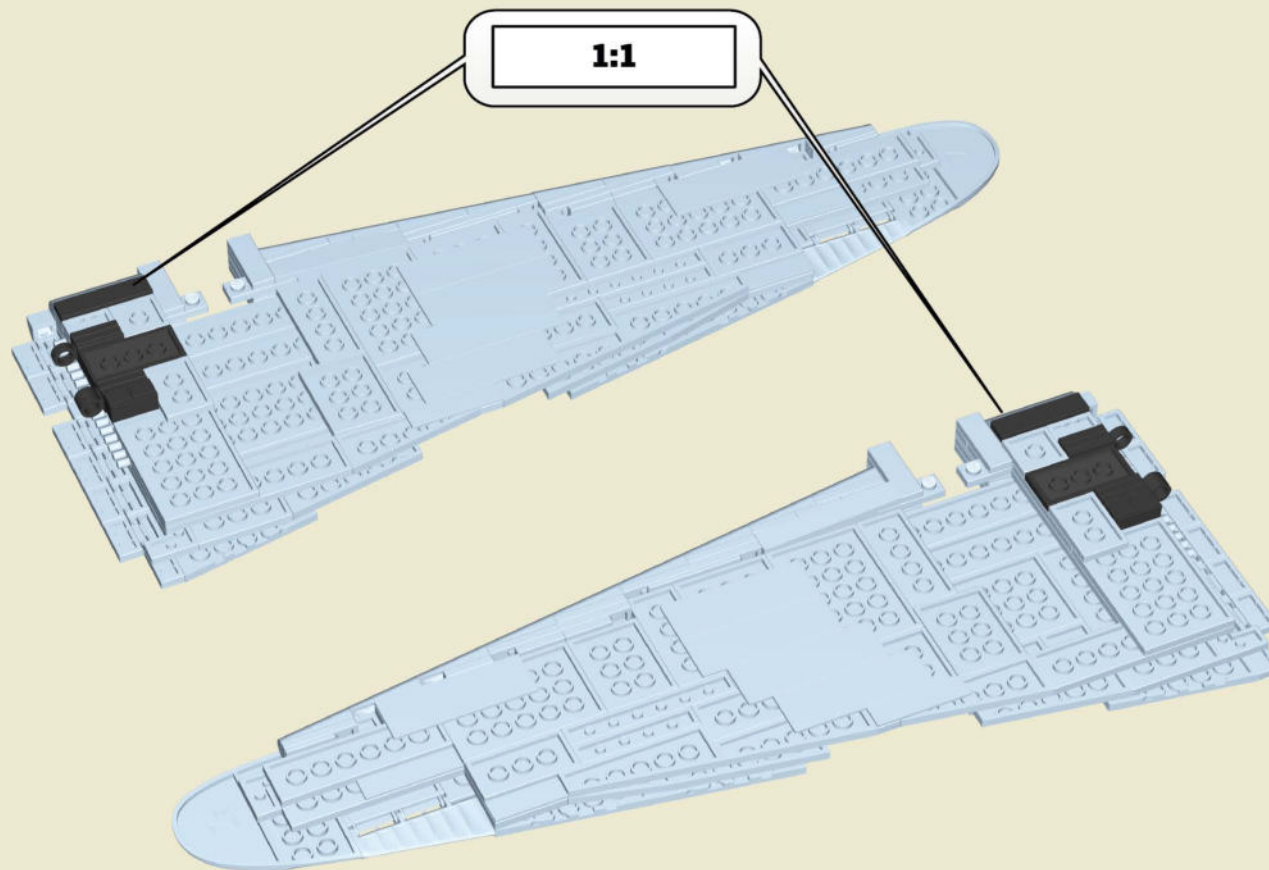



3

116

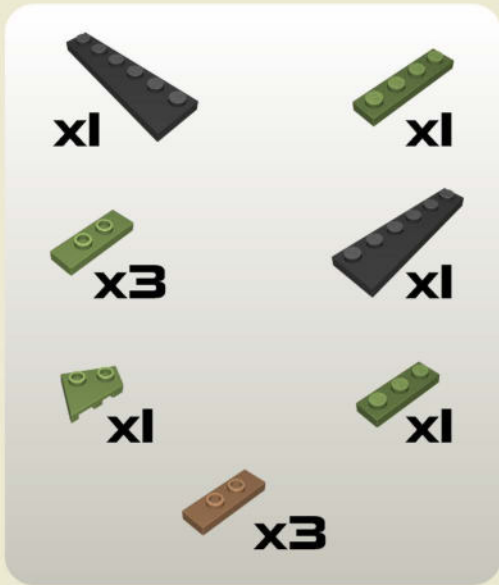
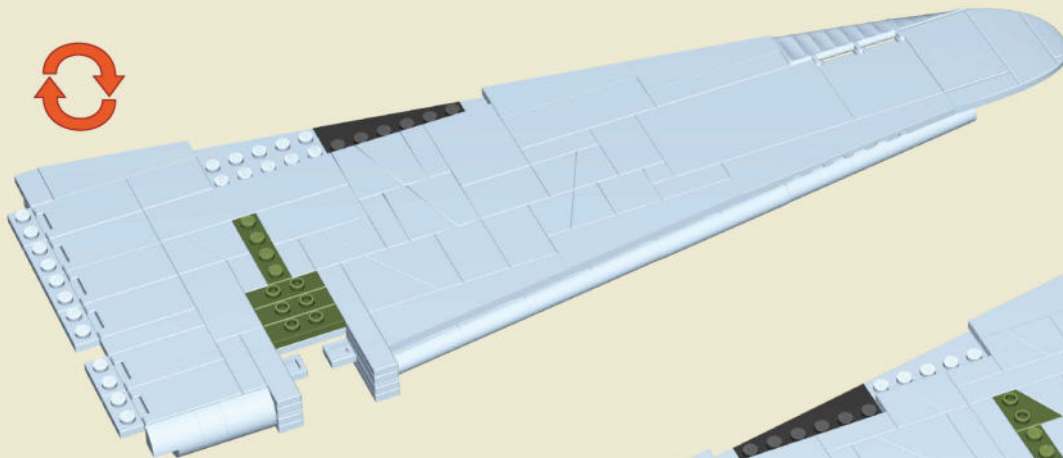

117

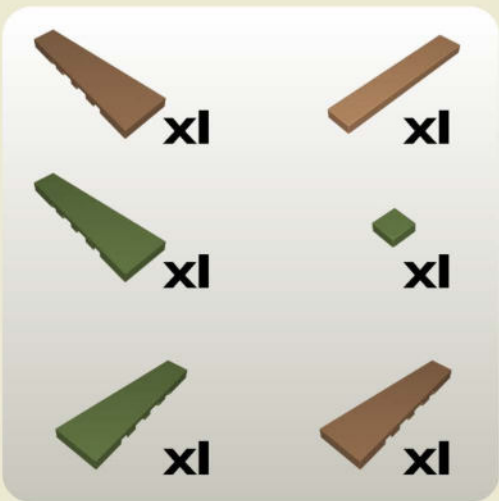



1:1



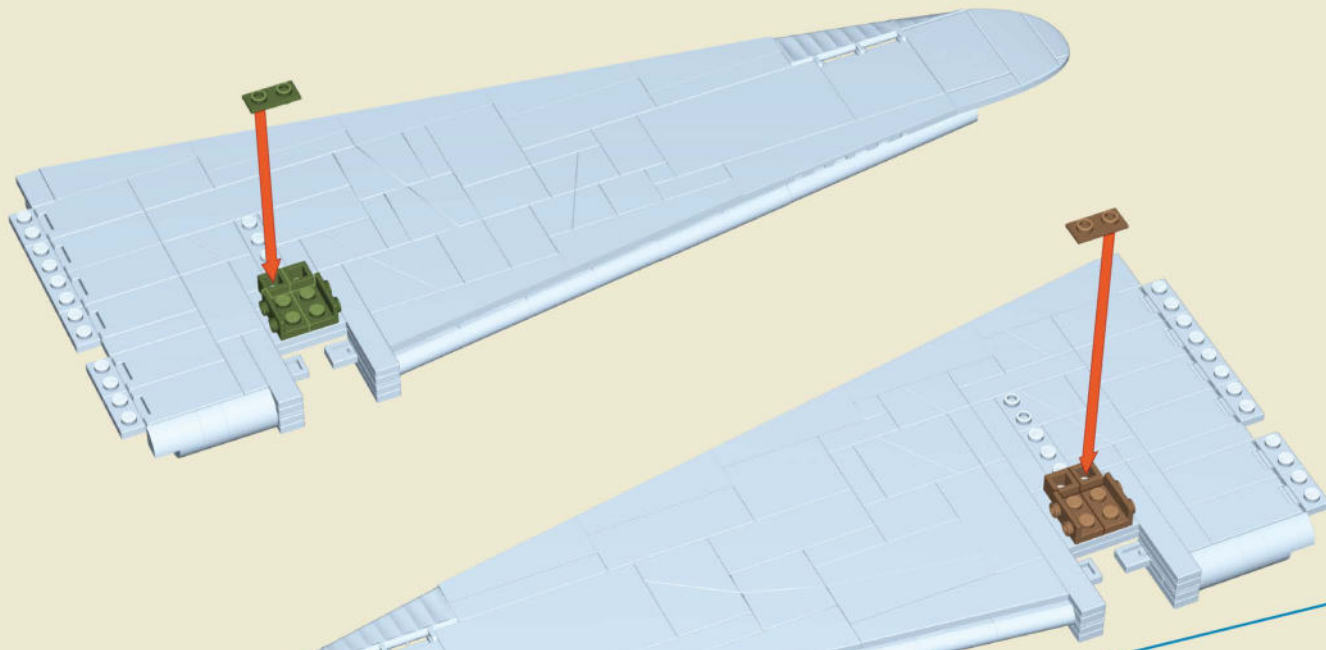



118

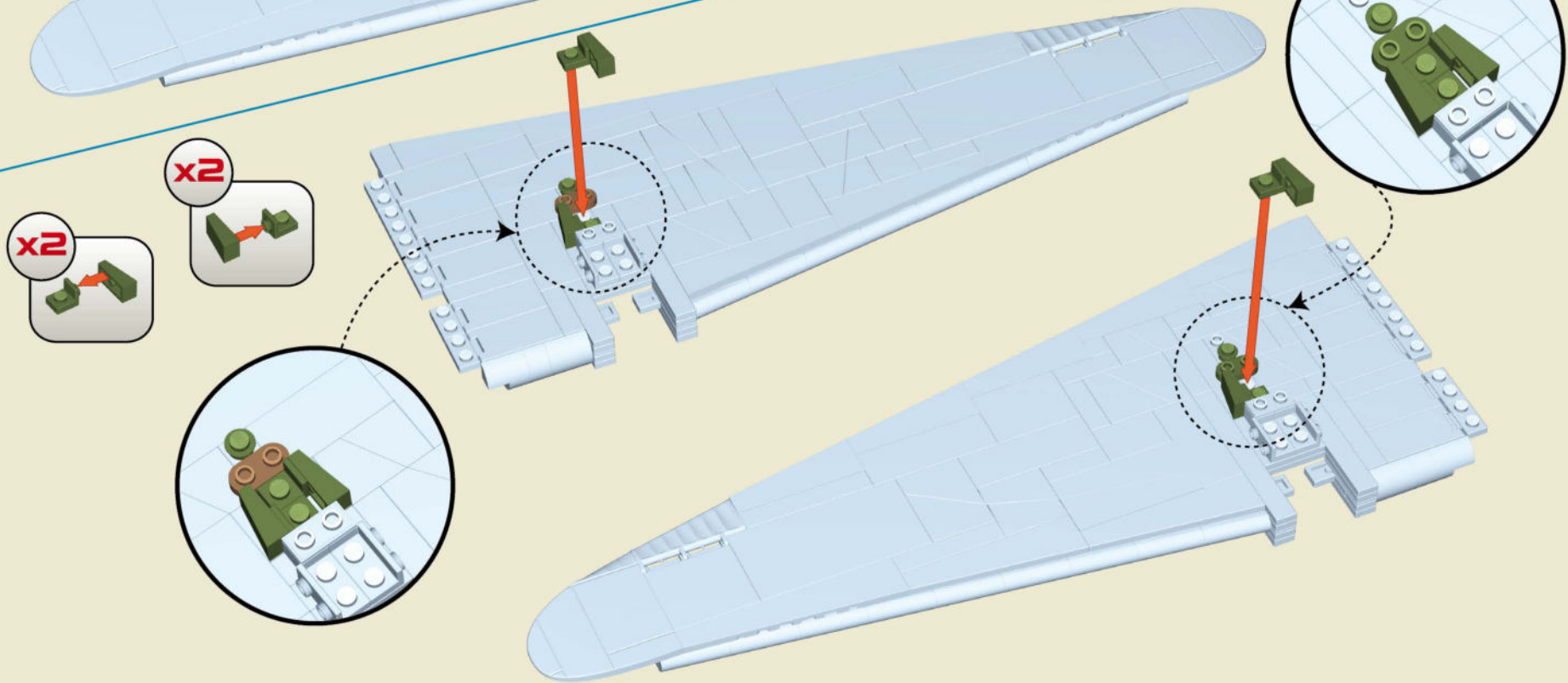

-  x2
-  x2
-  x1
-  x2
-  x2
-  x1

119



-  x2
-  x1
-  x4
-  x4
-  x1

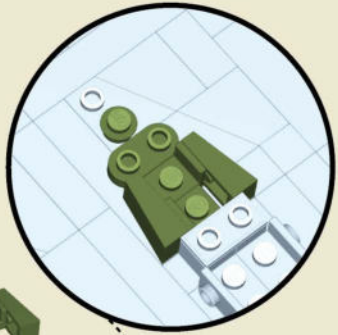
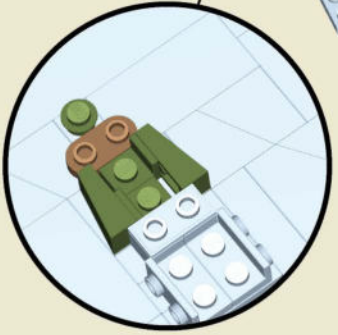

120

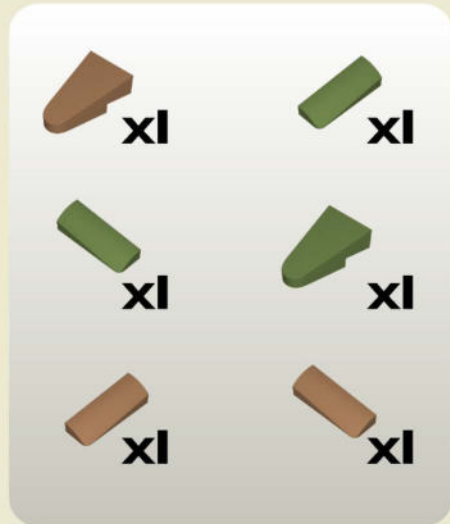
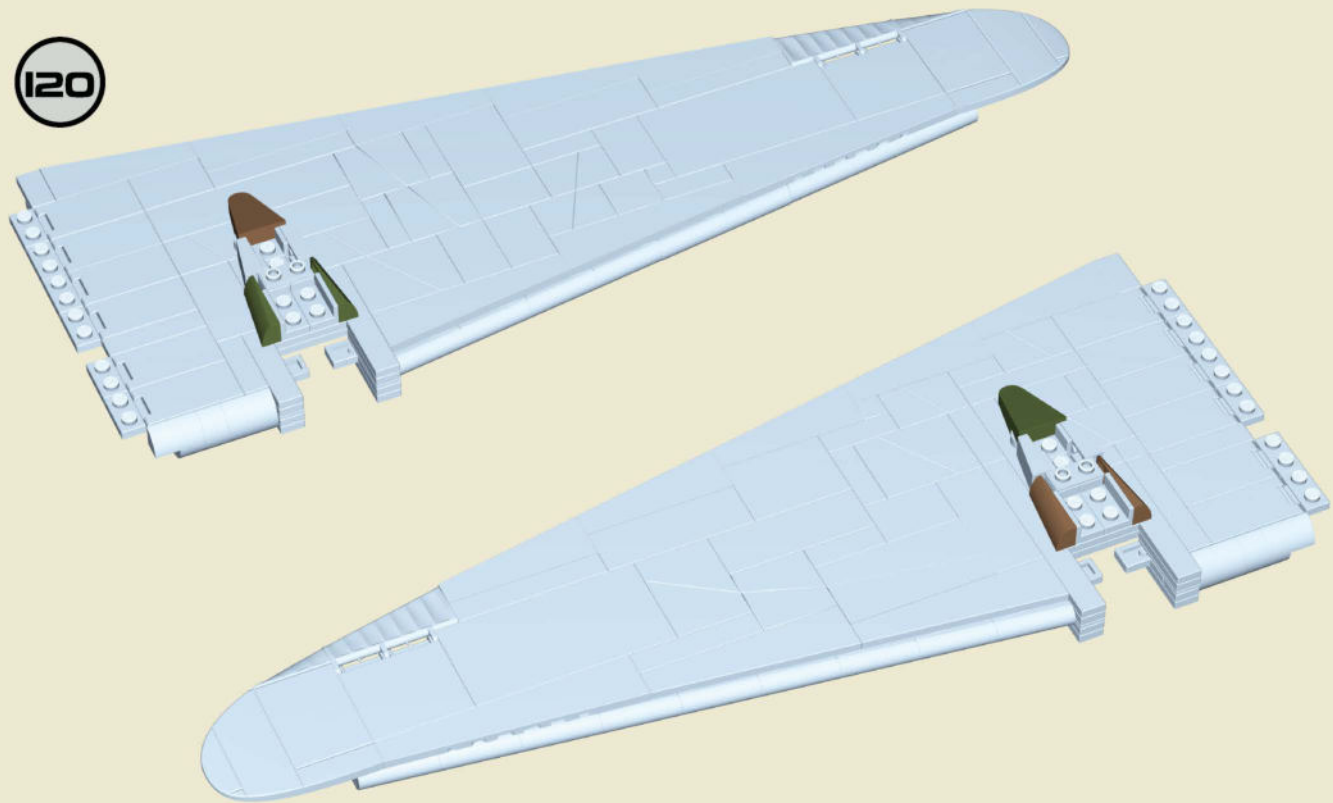

121



122



123

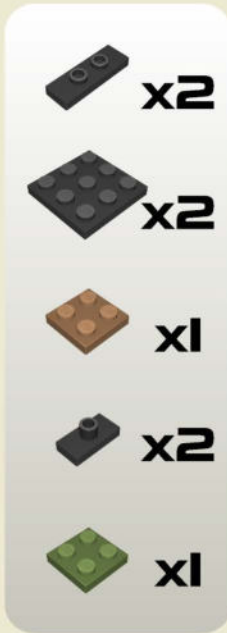
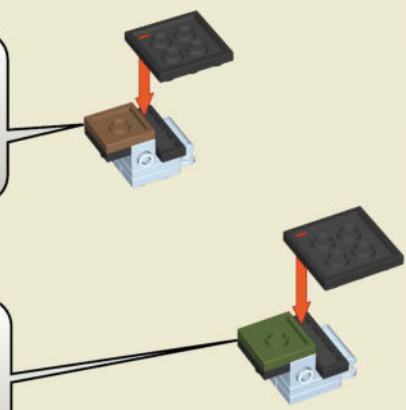

124

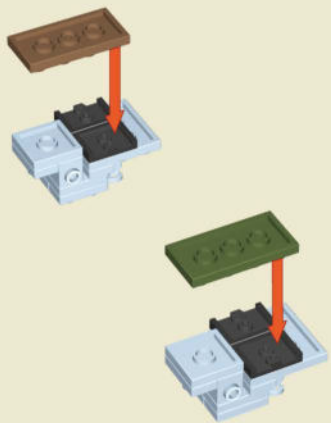

x4



x1



x1

125

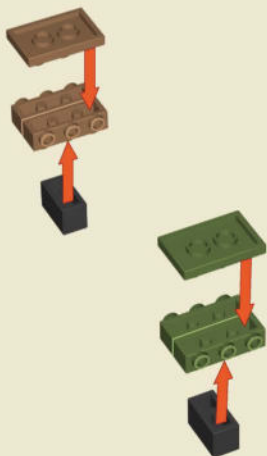

x2



x1

x2



x2



x1

126

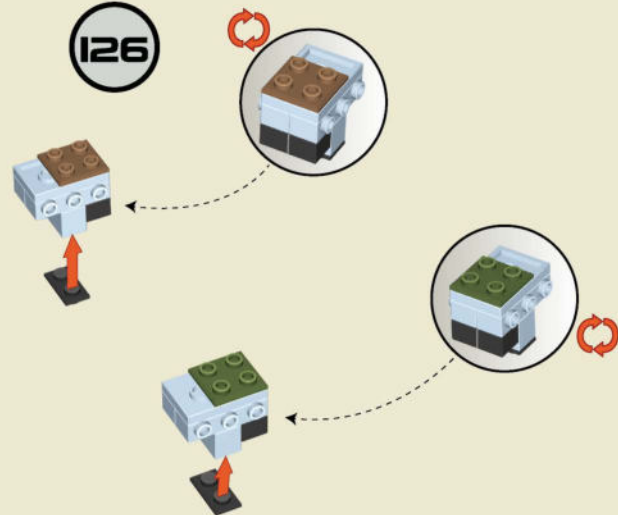

x2

x4

x1

x1

127

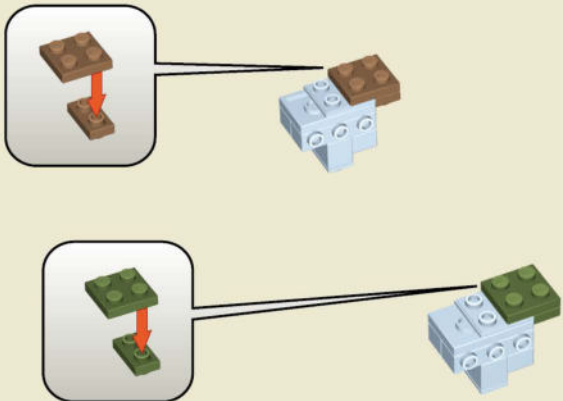

x1



x1

x1



x1

128



129

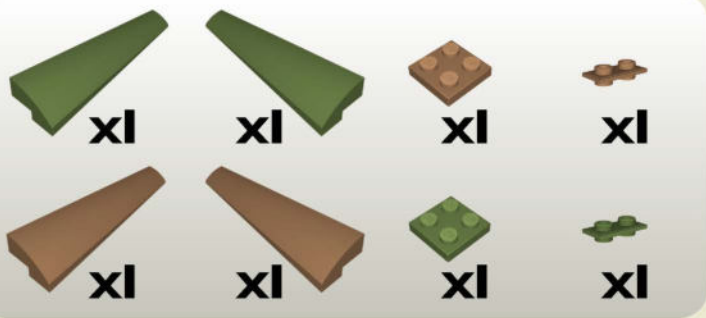
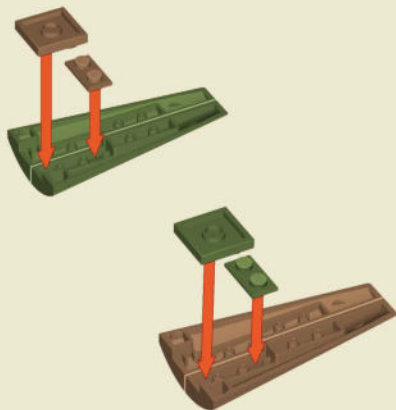

130

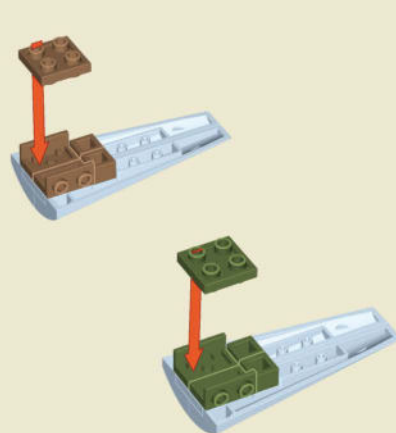

131

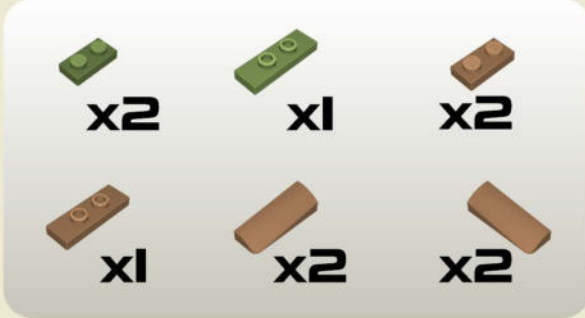
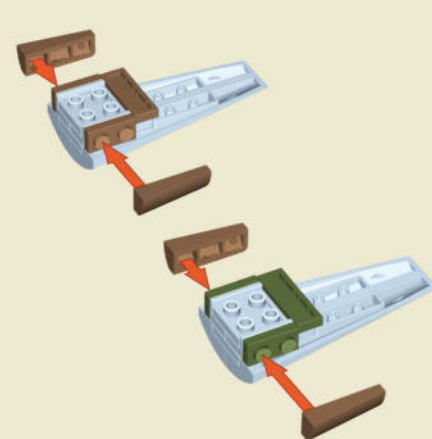

132

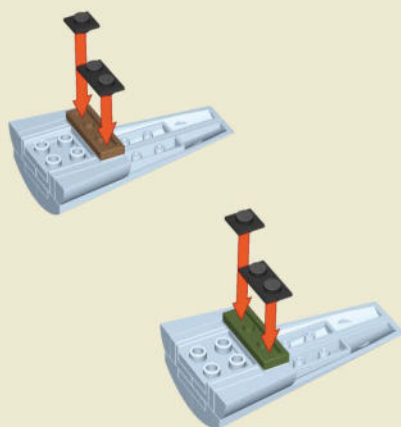

133

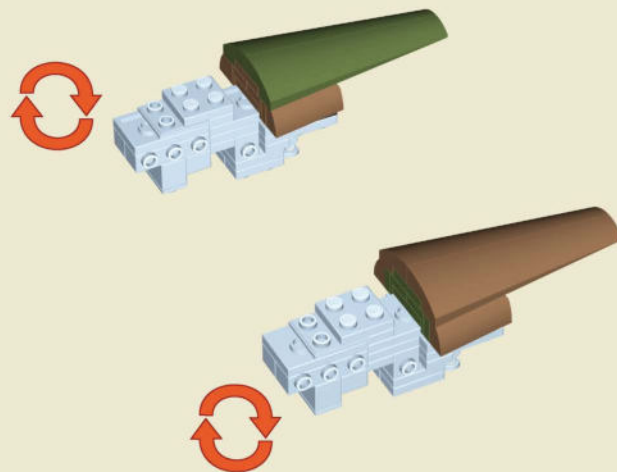

134

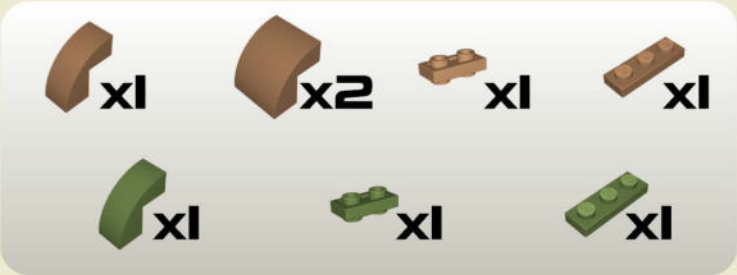
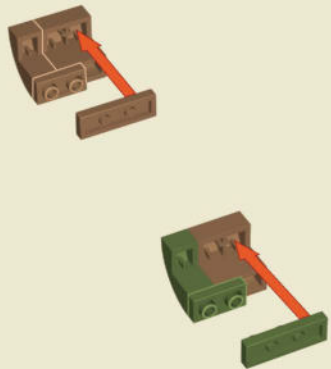

135

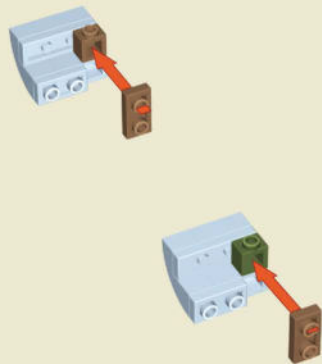

136

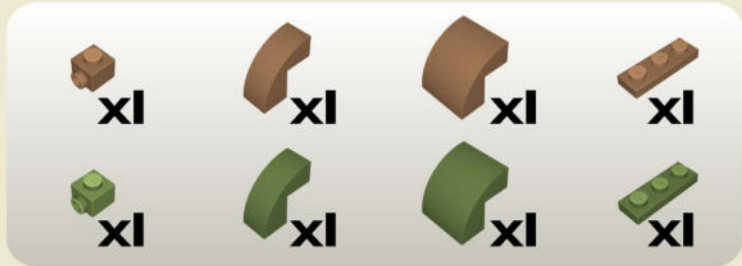
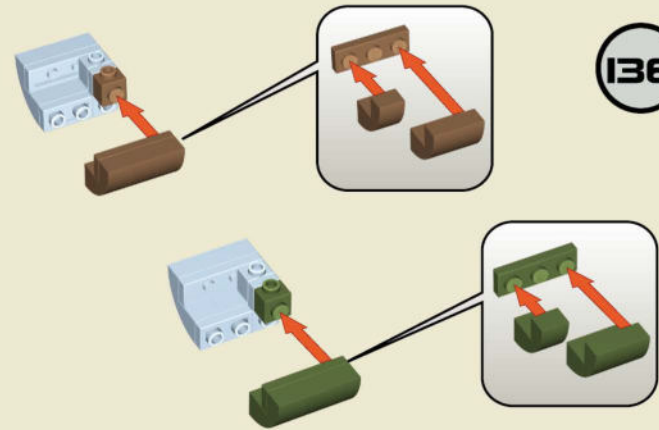

137

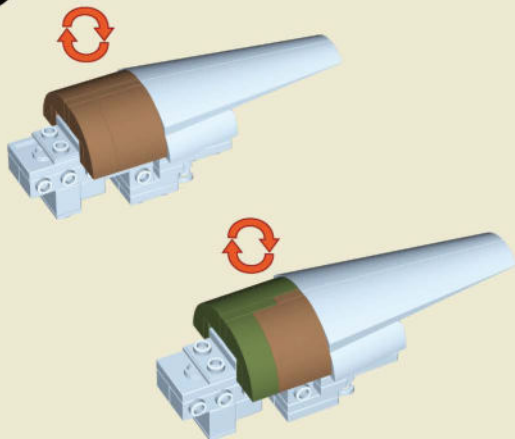

138

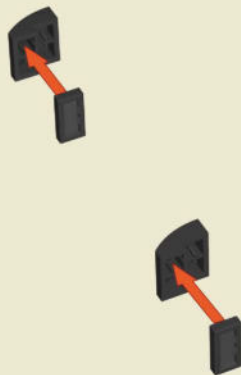

139

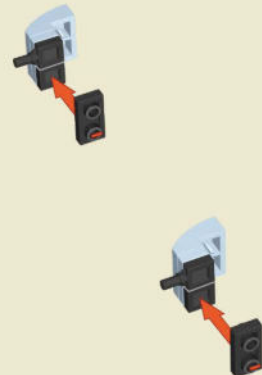

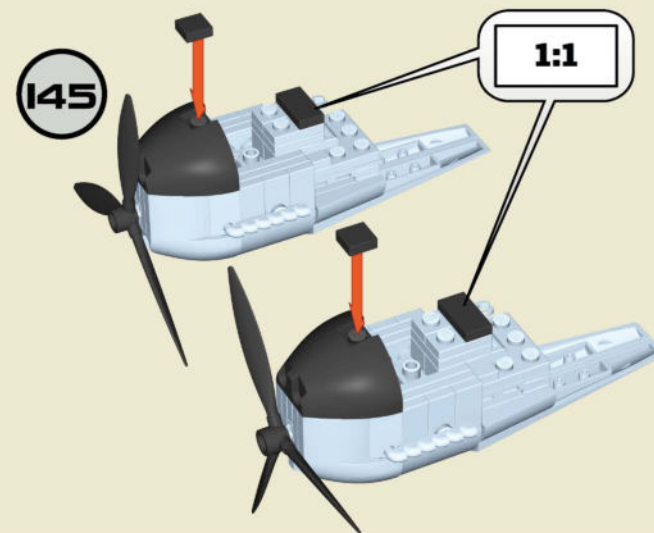
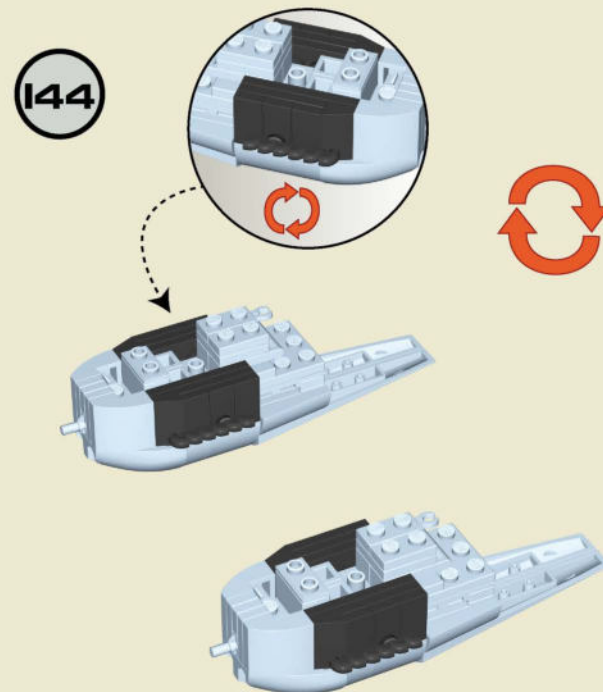
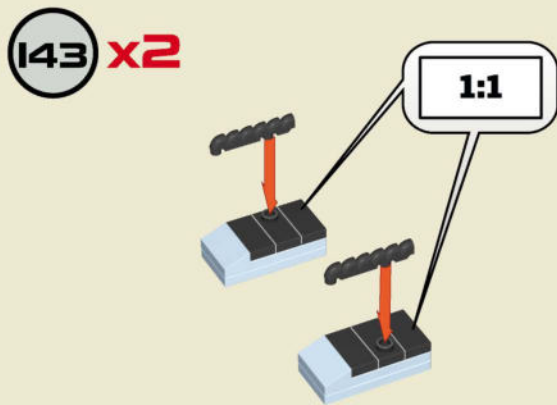
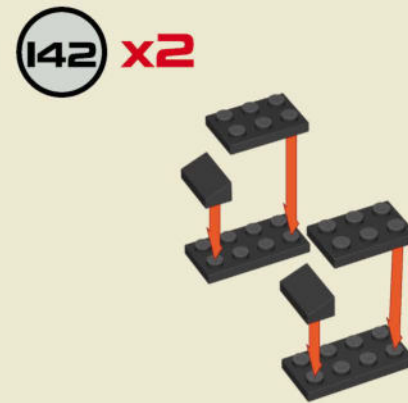
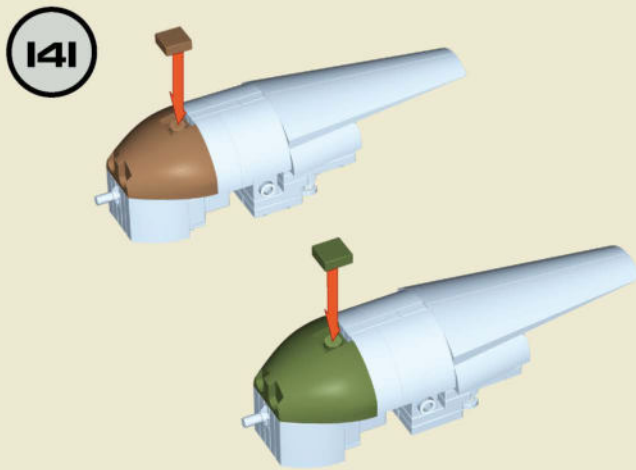
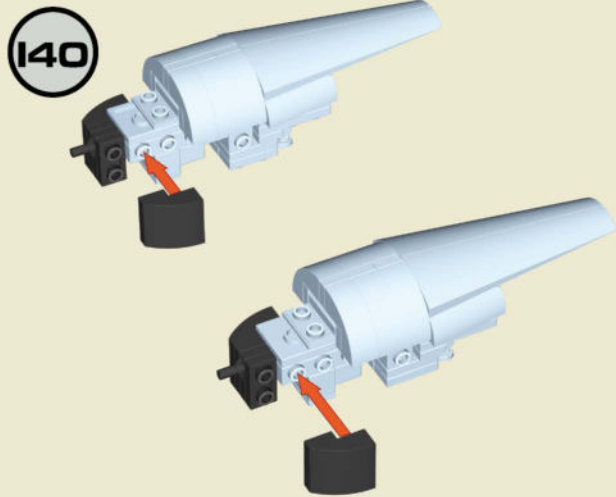

146

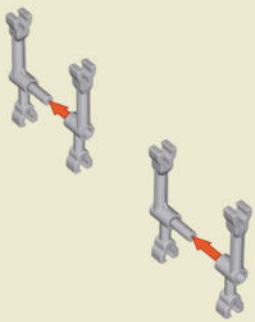

147

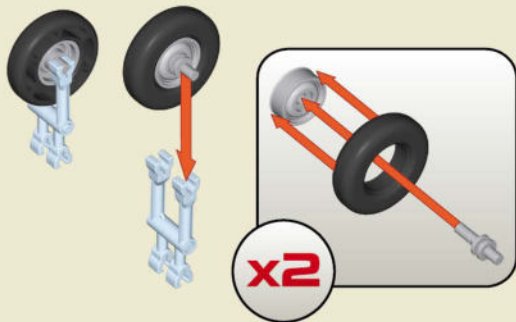

148

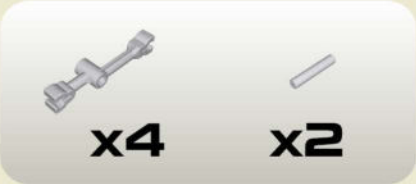
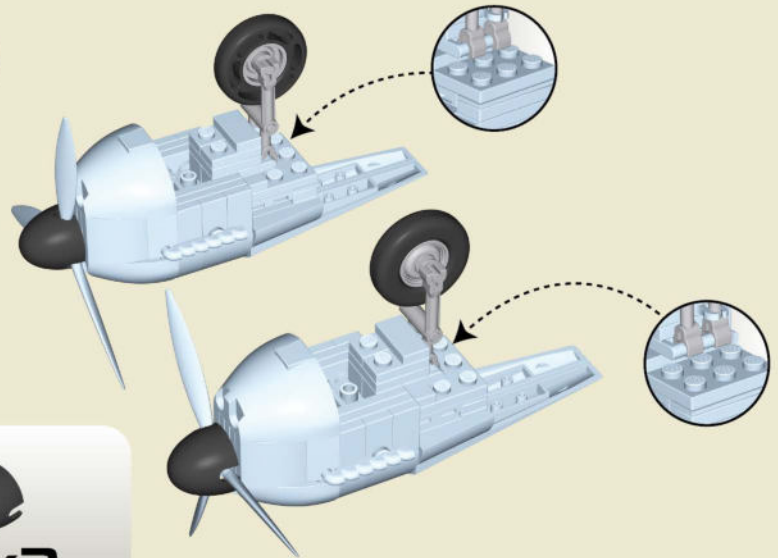

149

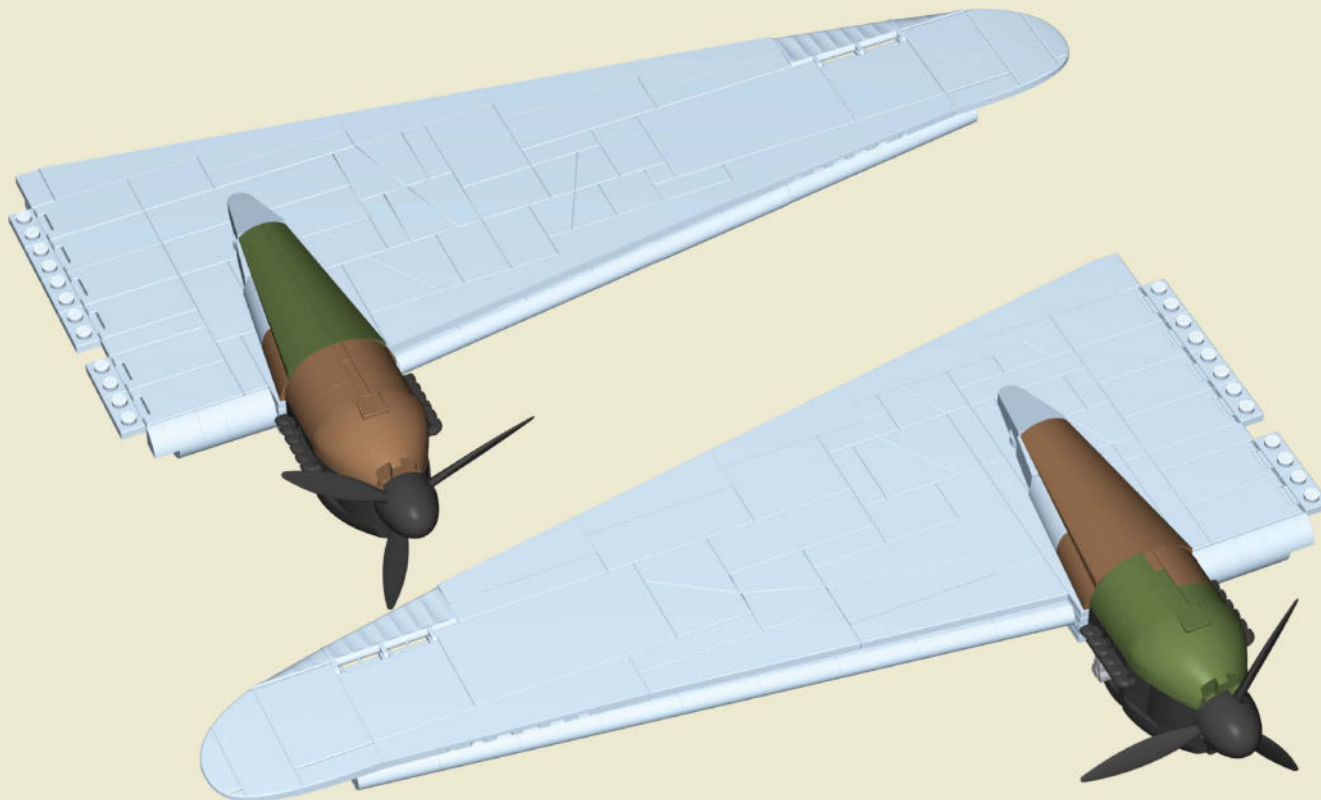

150 x2

x2

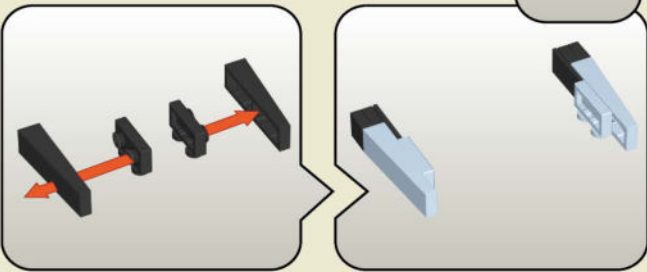

151

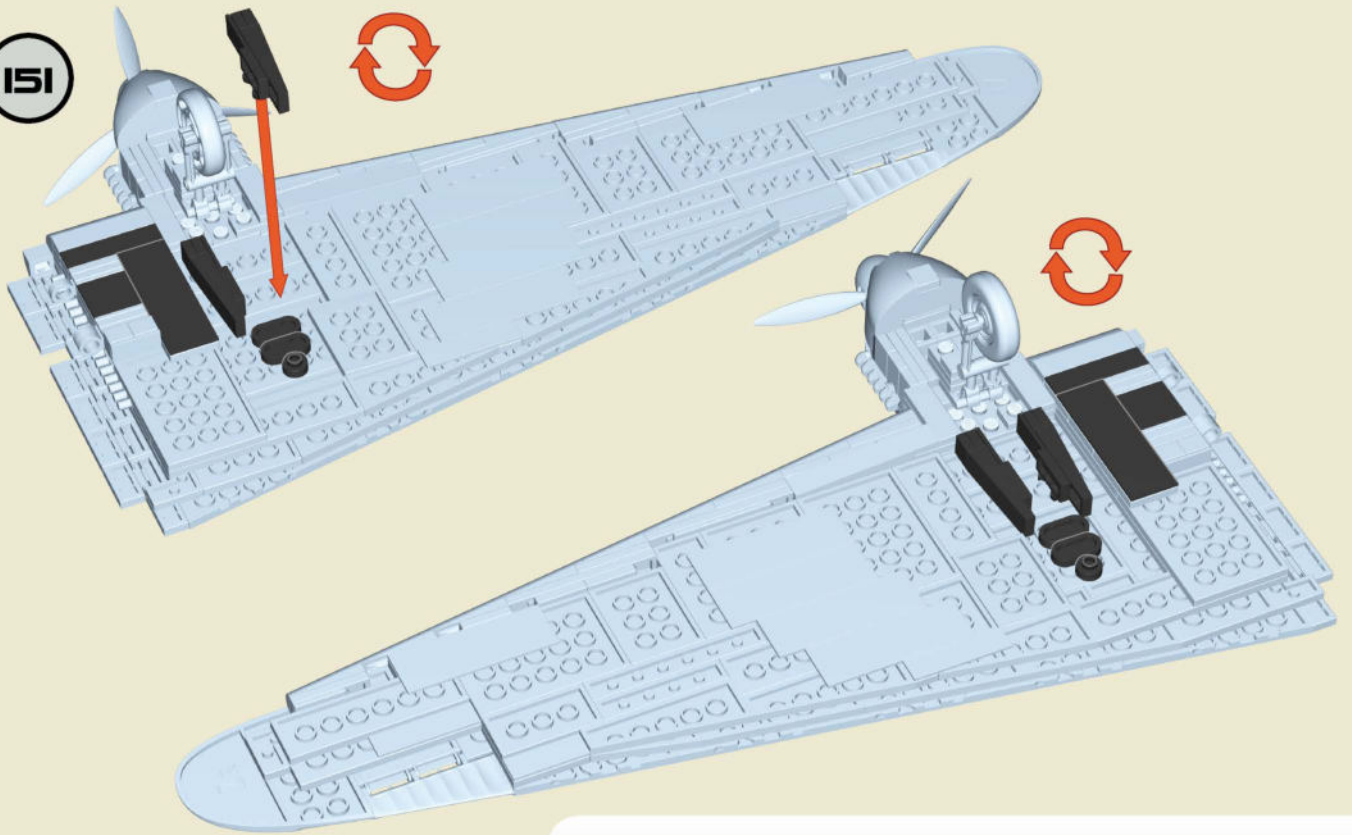

152

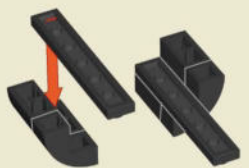

152 155 x2



153

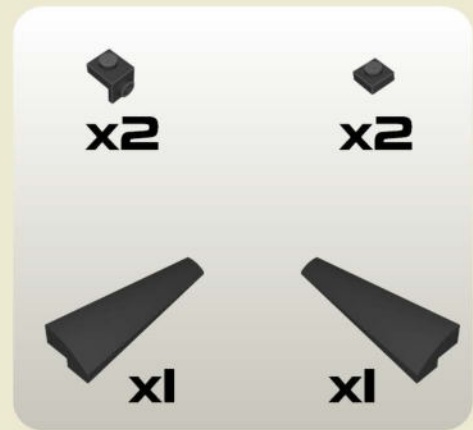
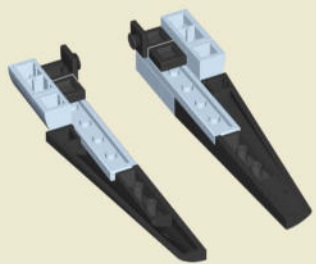

154

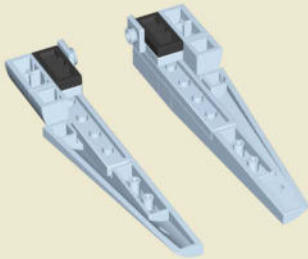

x2

155

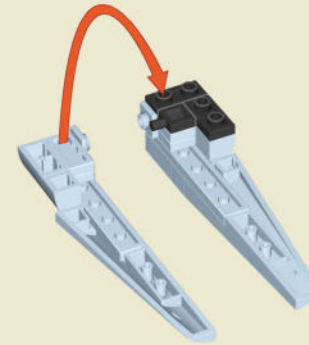

x1



x2

156

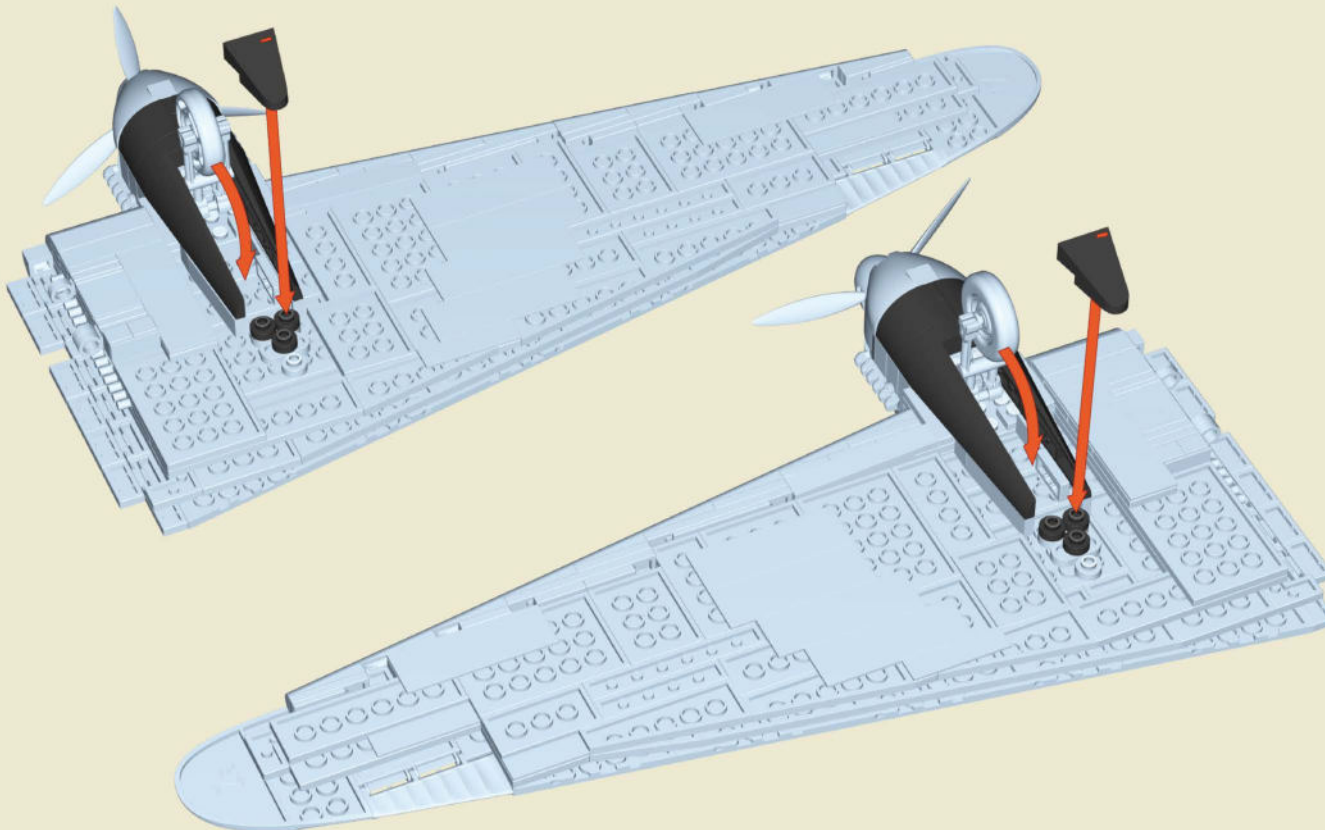

x6



x2

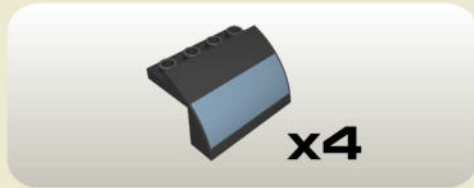
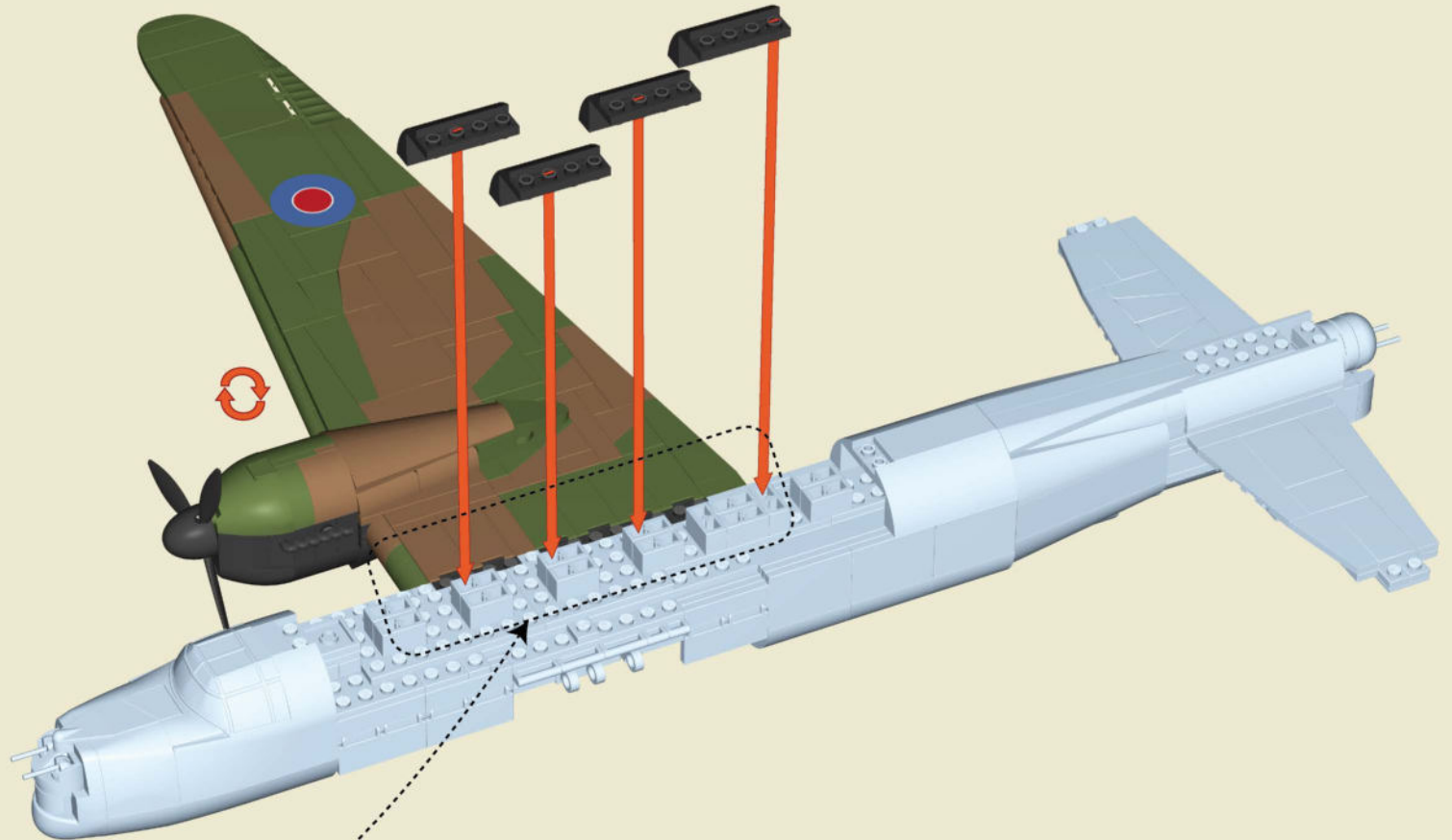
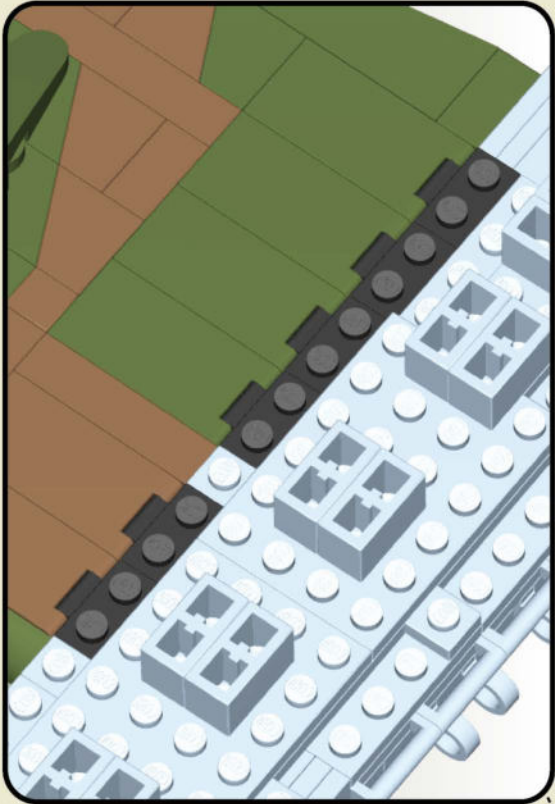

158

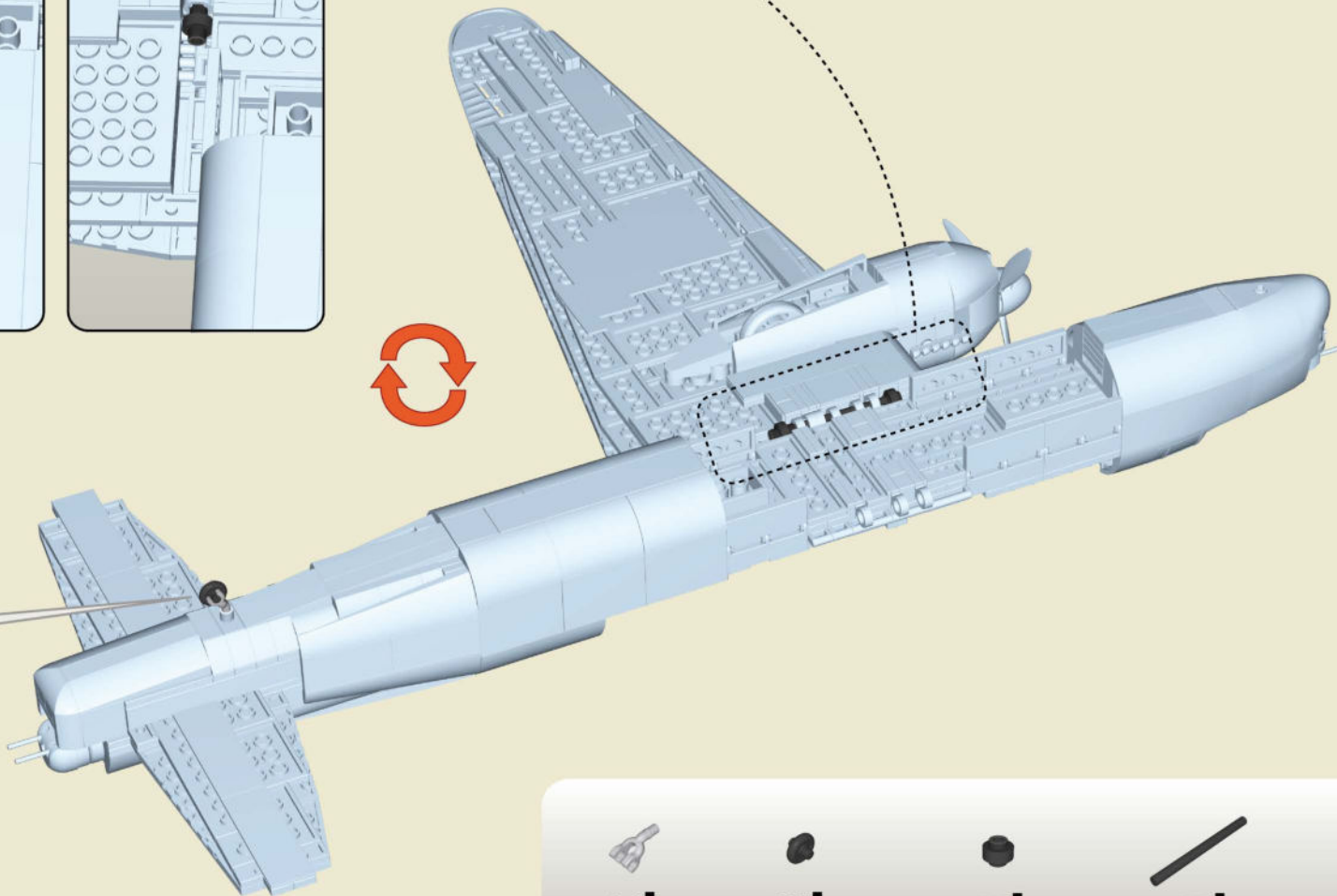
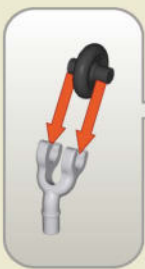
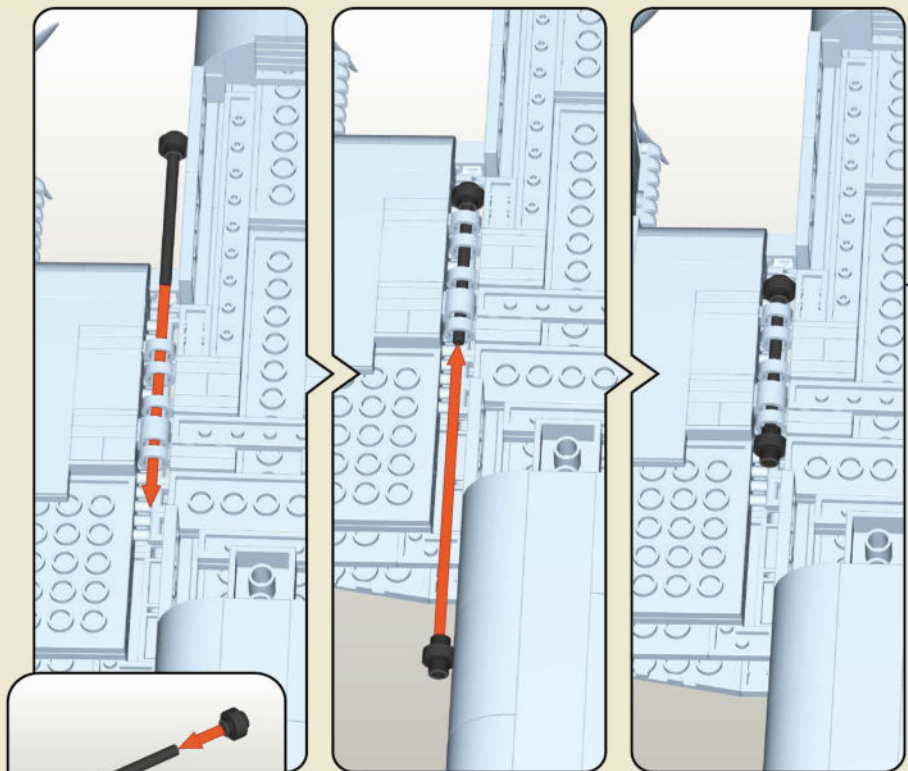

-  **x1**
-  **x1**
-  **x1**
-  **x1**
-  **x1**

159

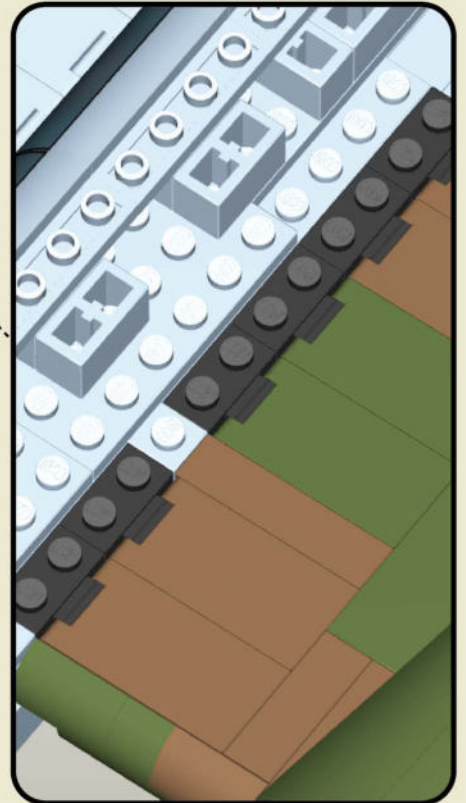
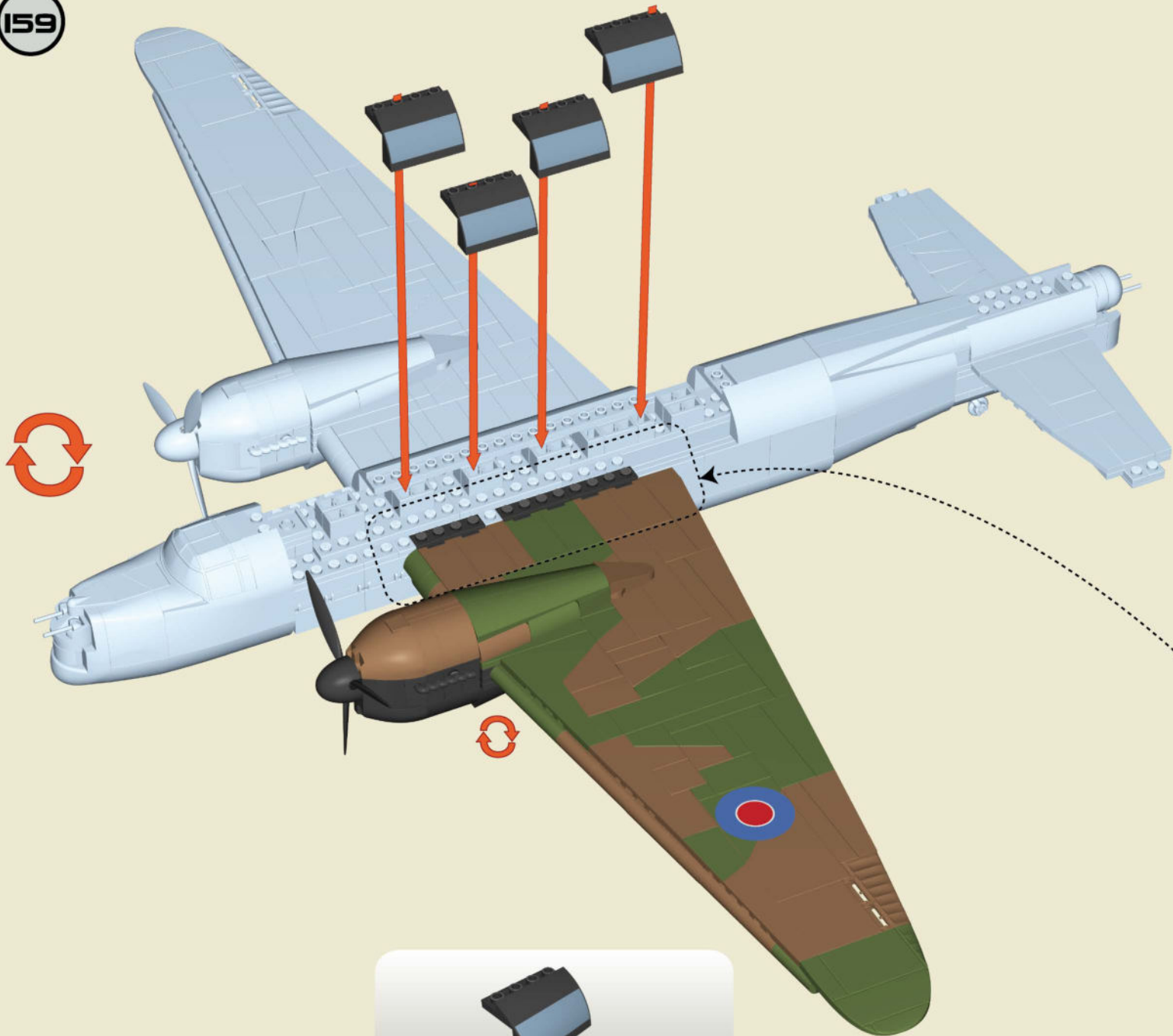

160

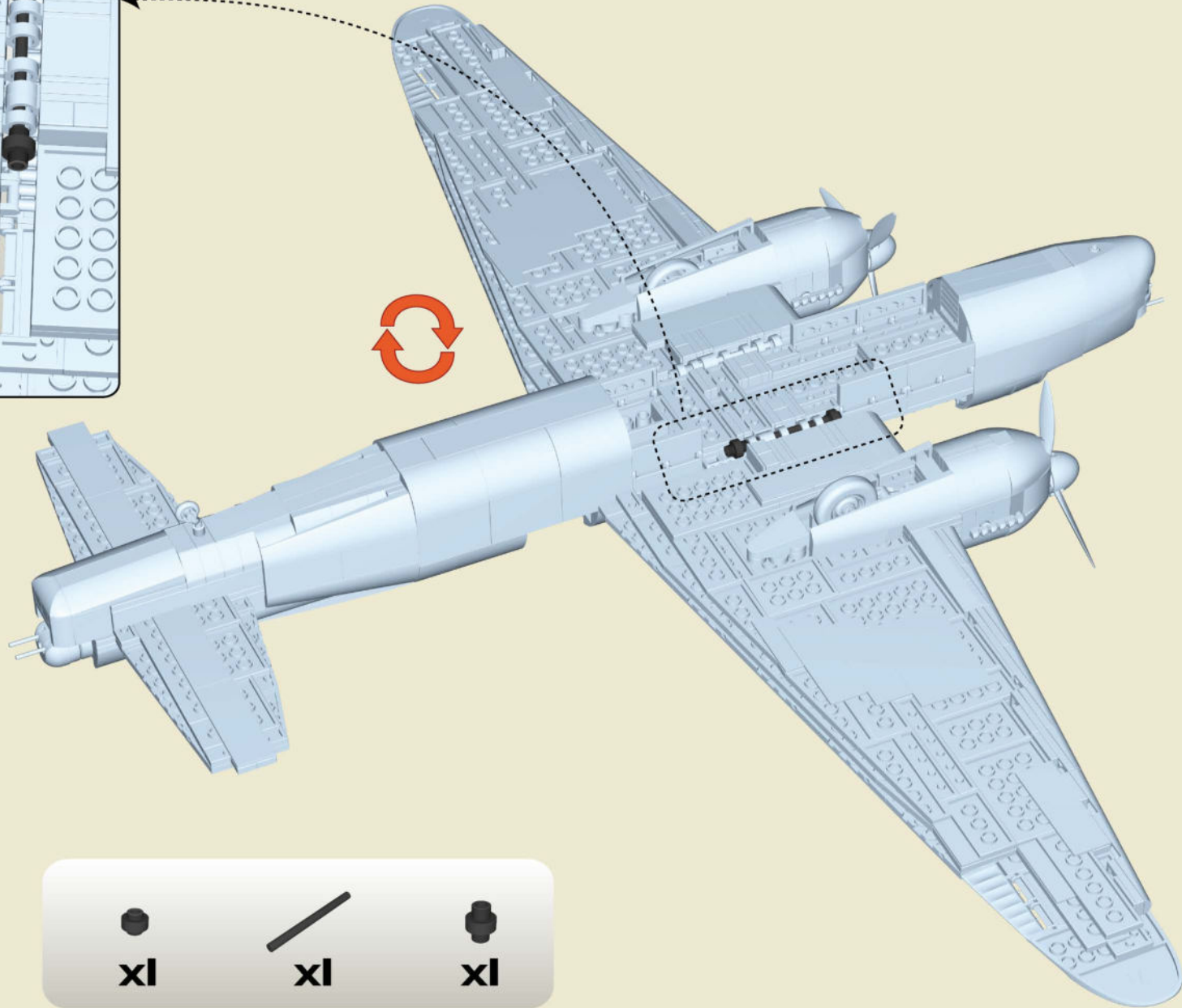
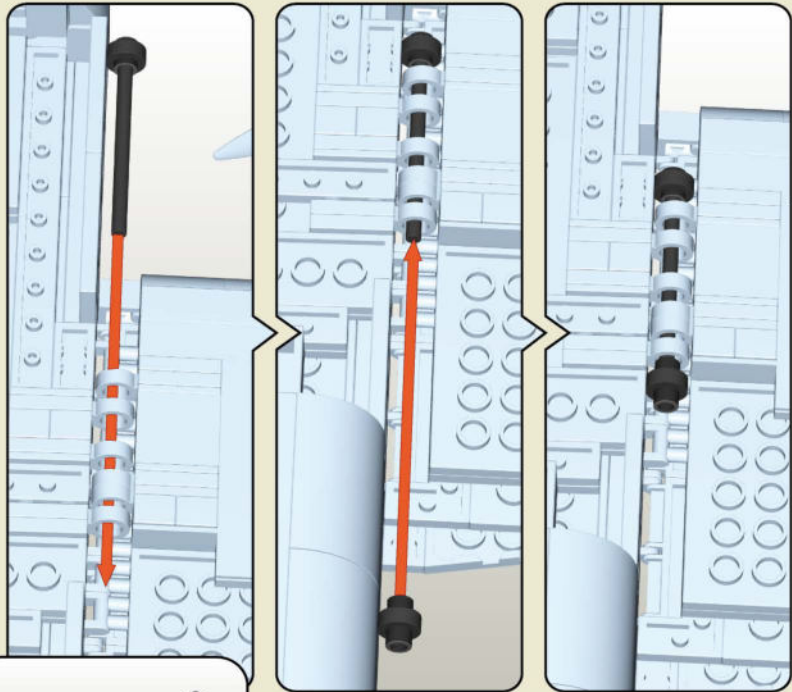

x1



x1



x1

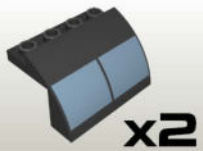
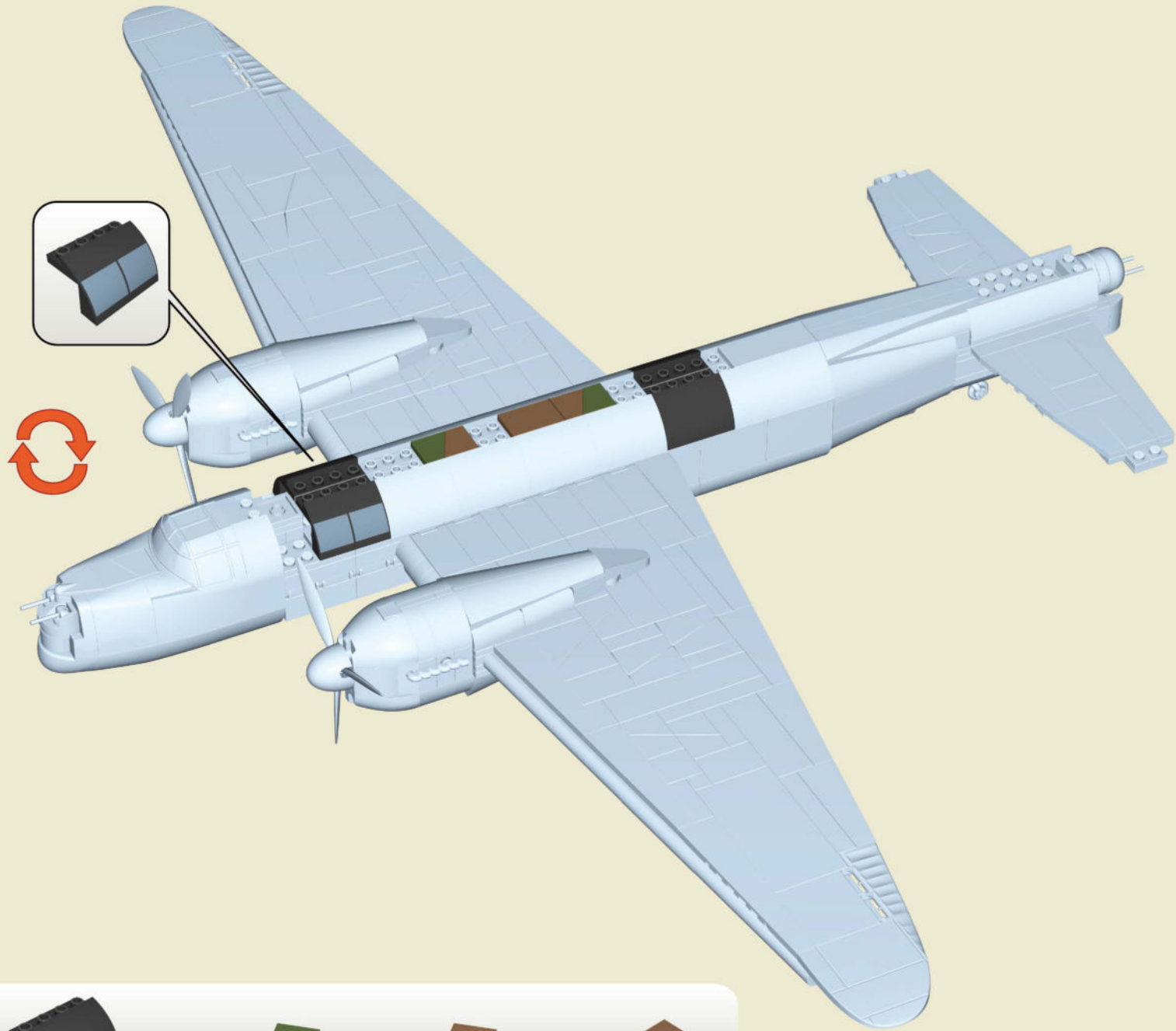



x2



x1



x1



x1



x1

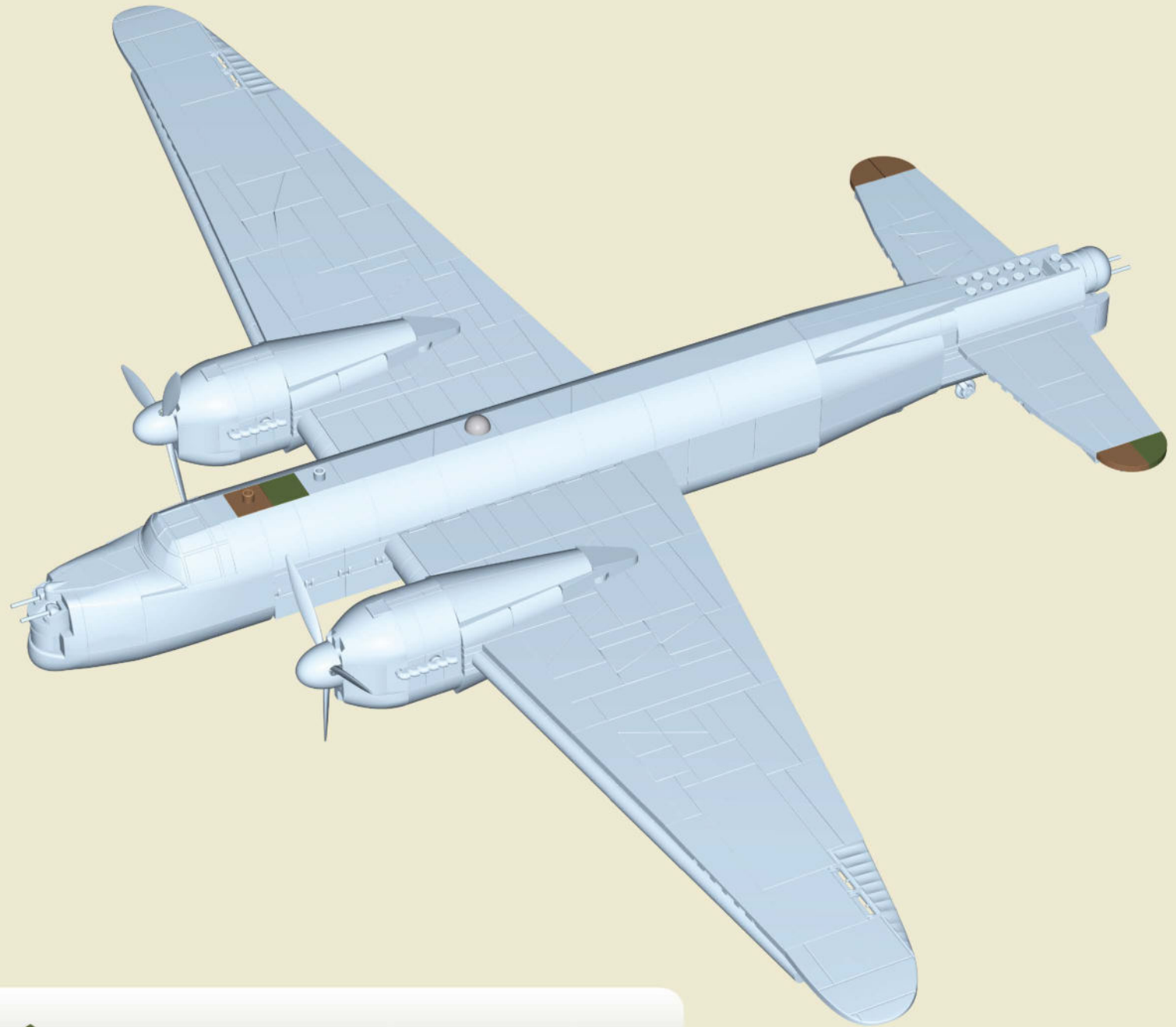

x1



x1



x1



x3



x1

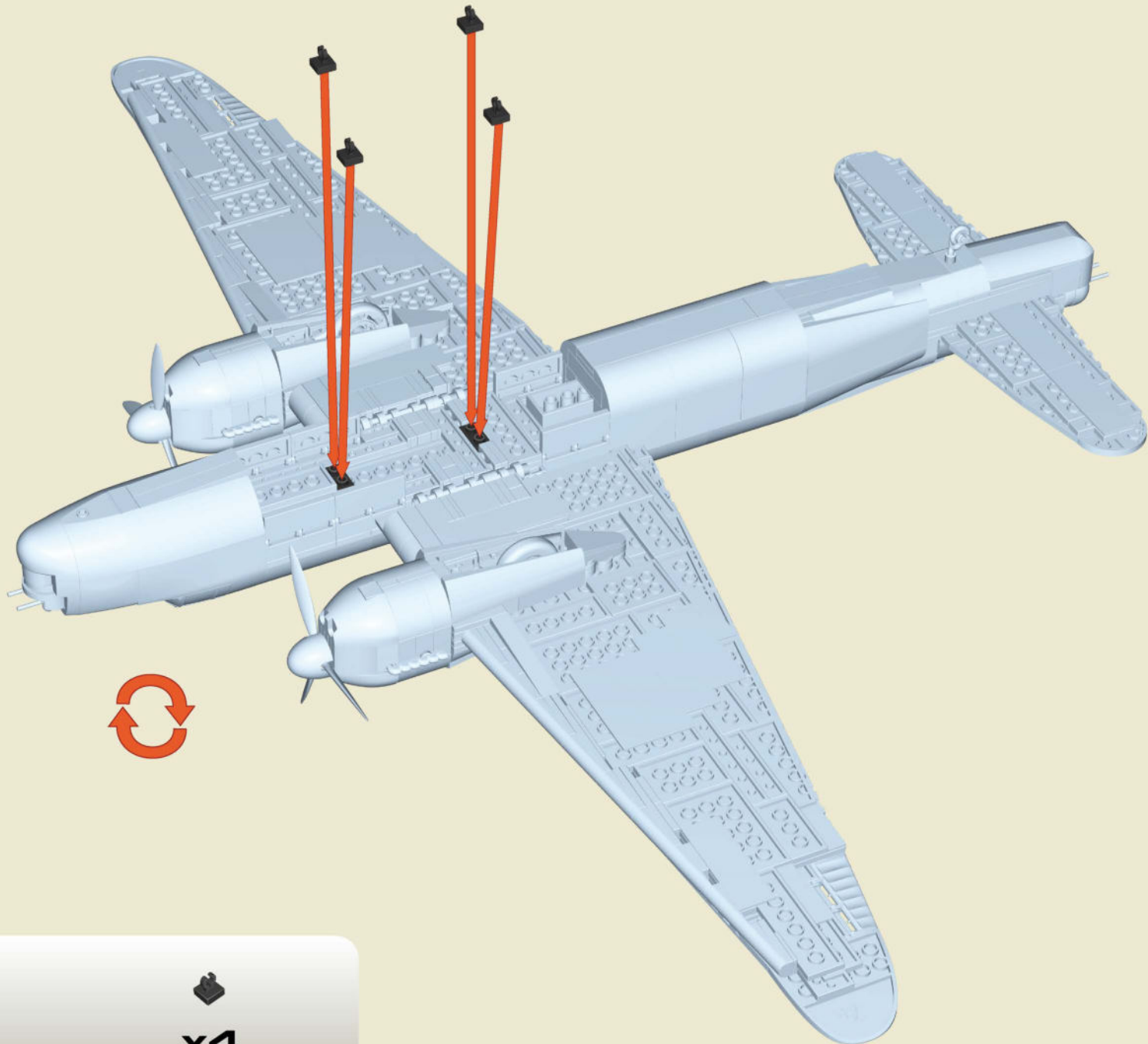

x2



x4

165

1:1

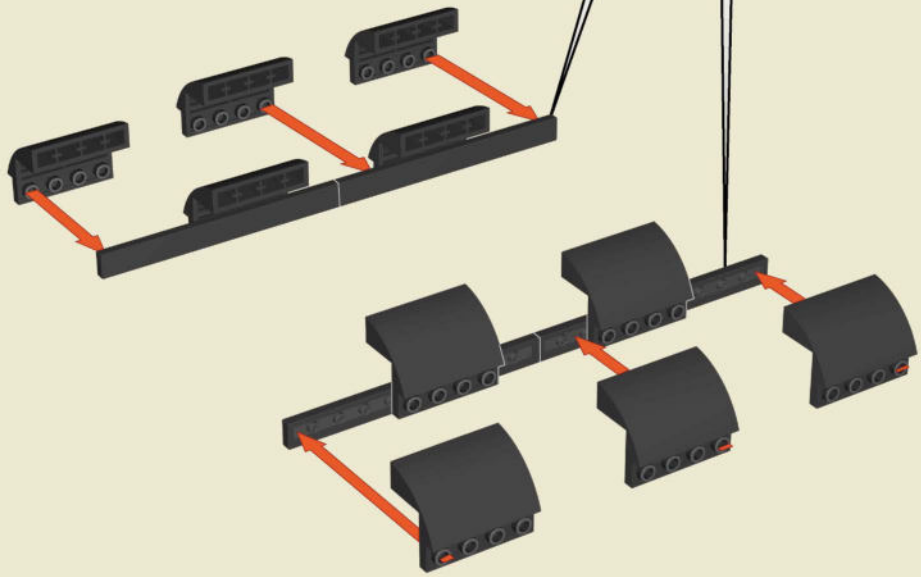

166

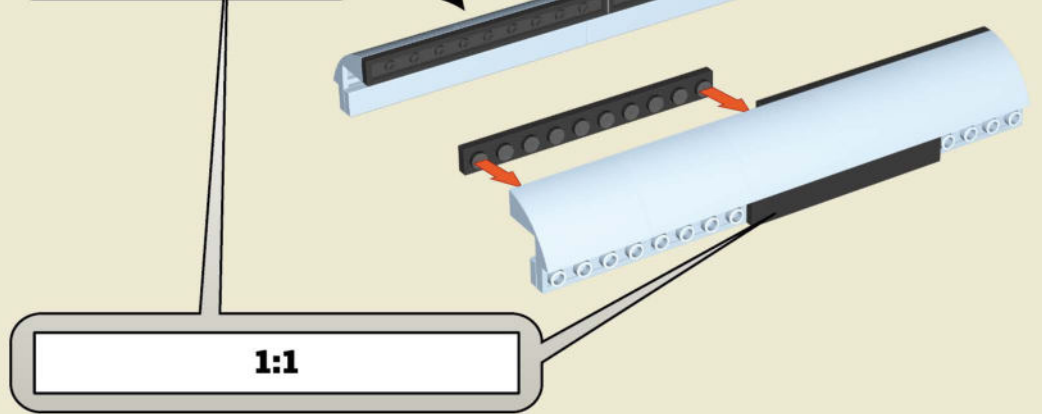
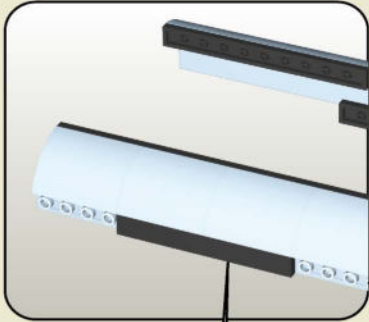

1:1

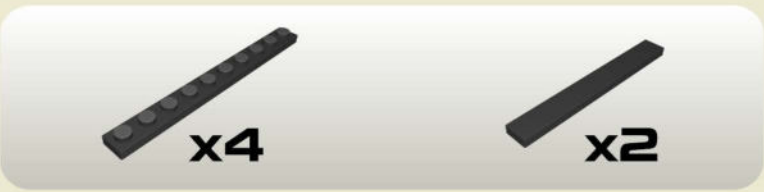

167

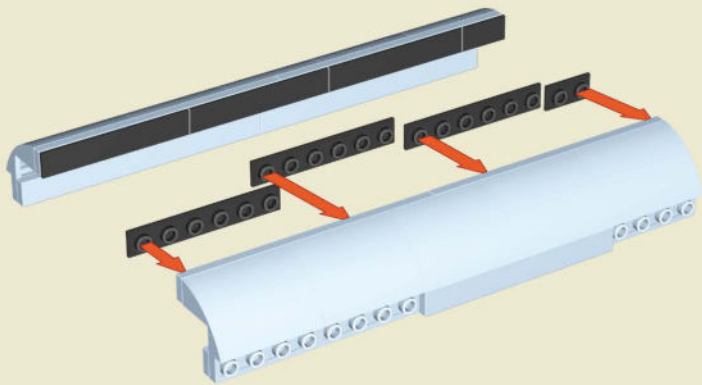

168

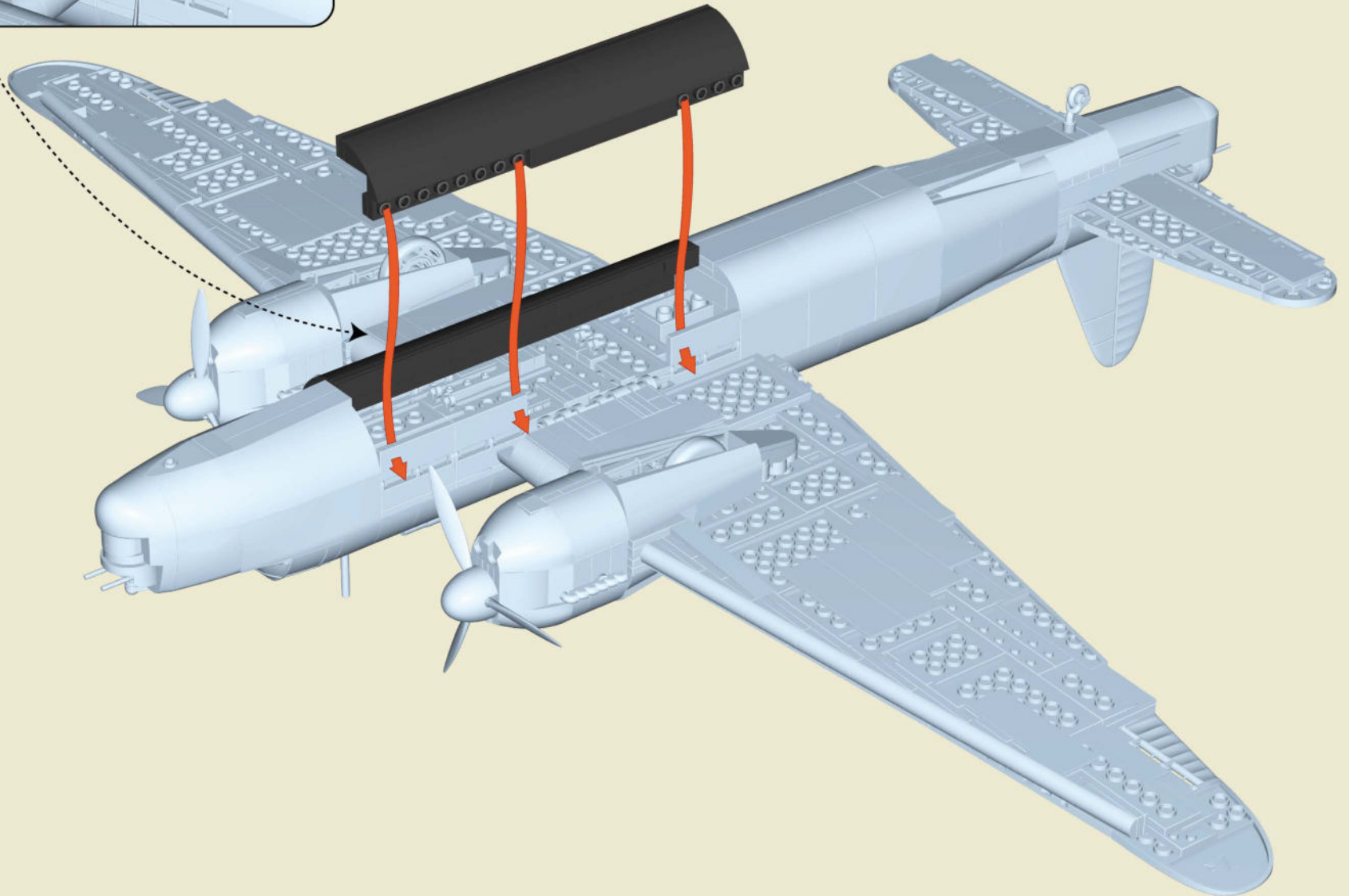
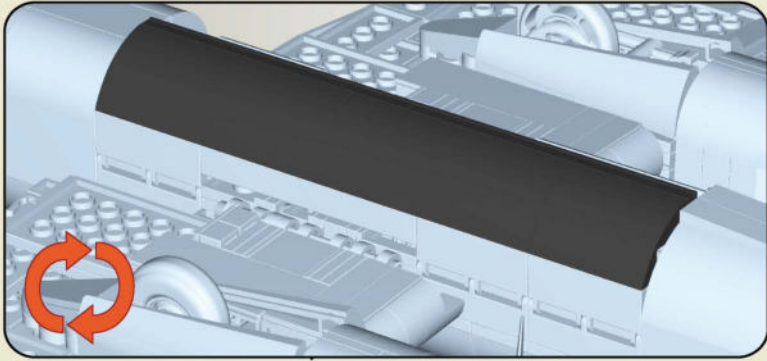

169

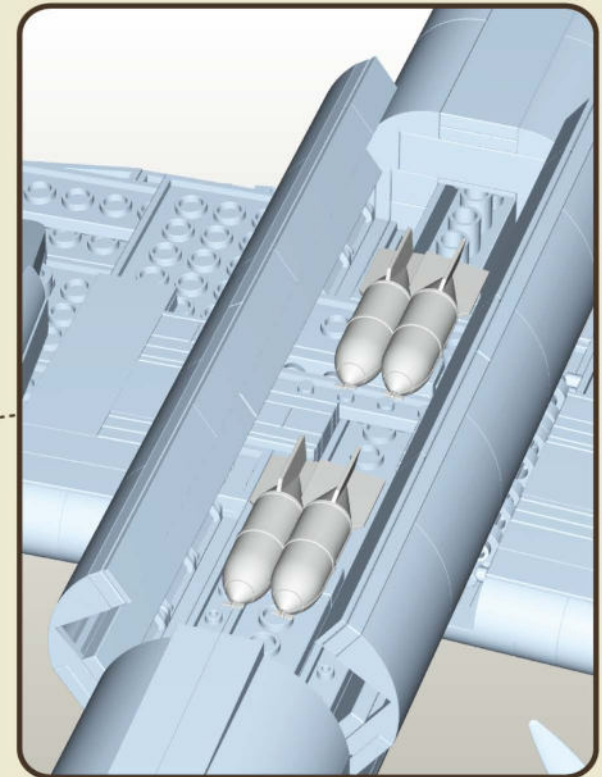
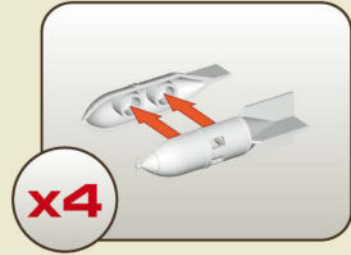
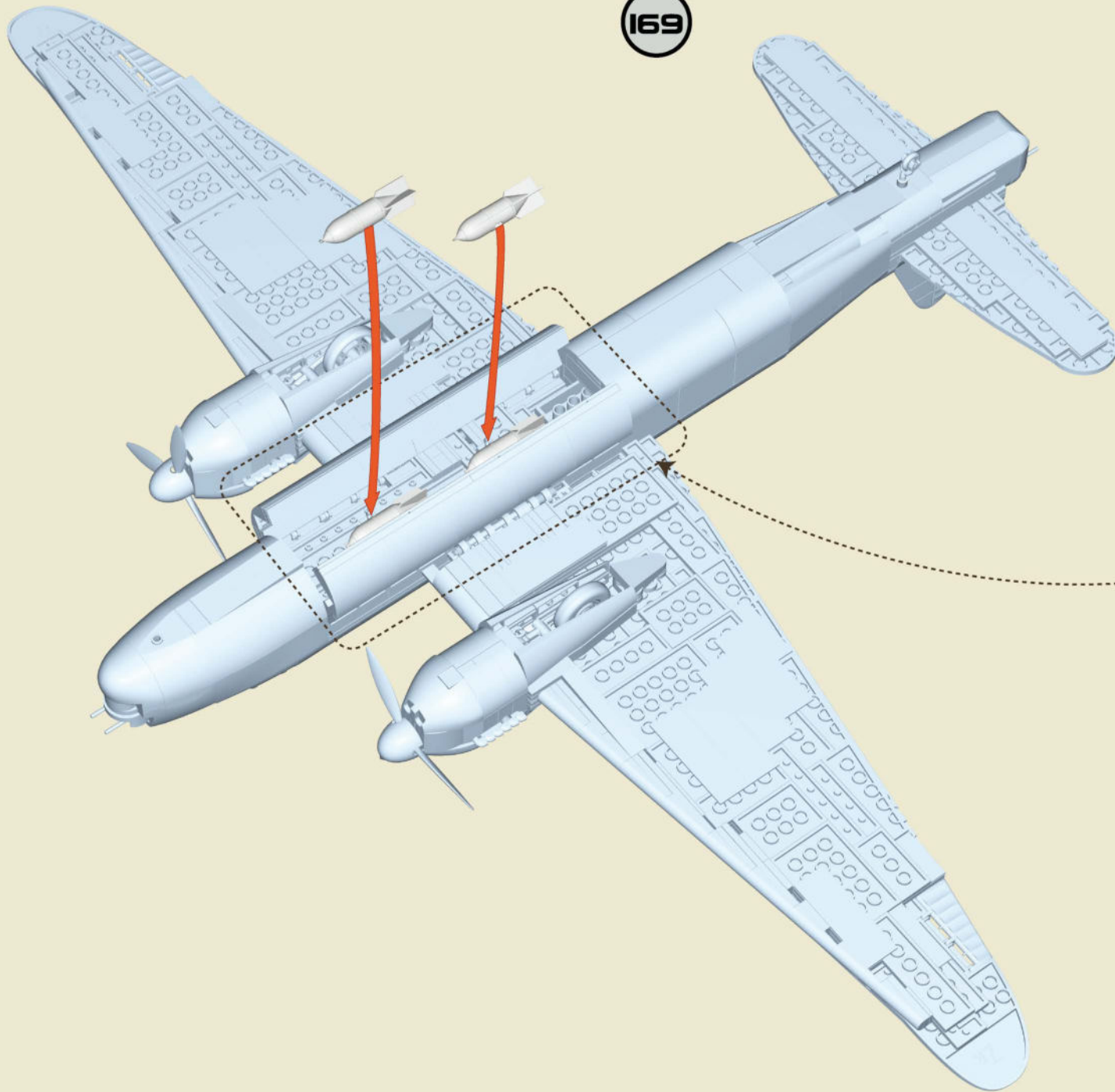

170

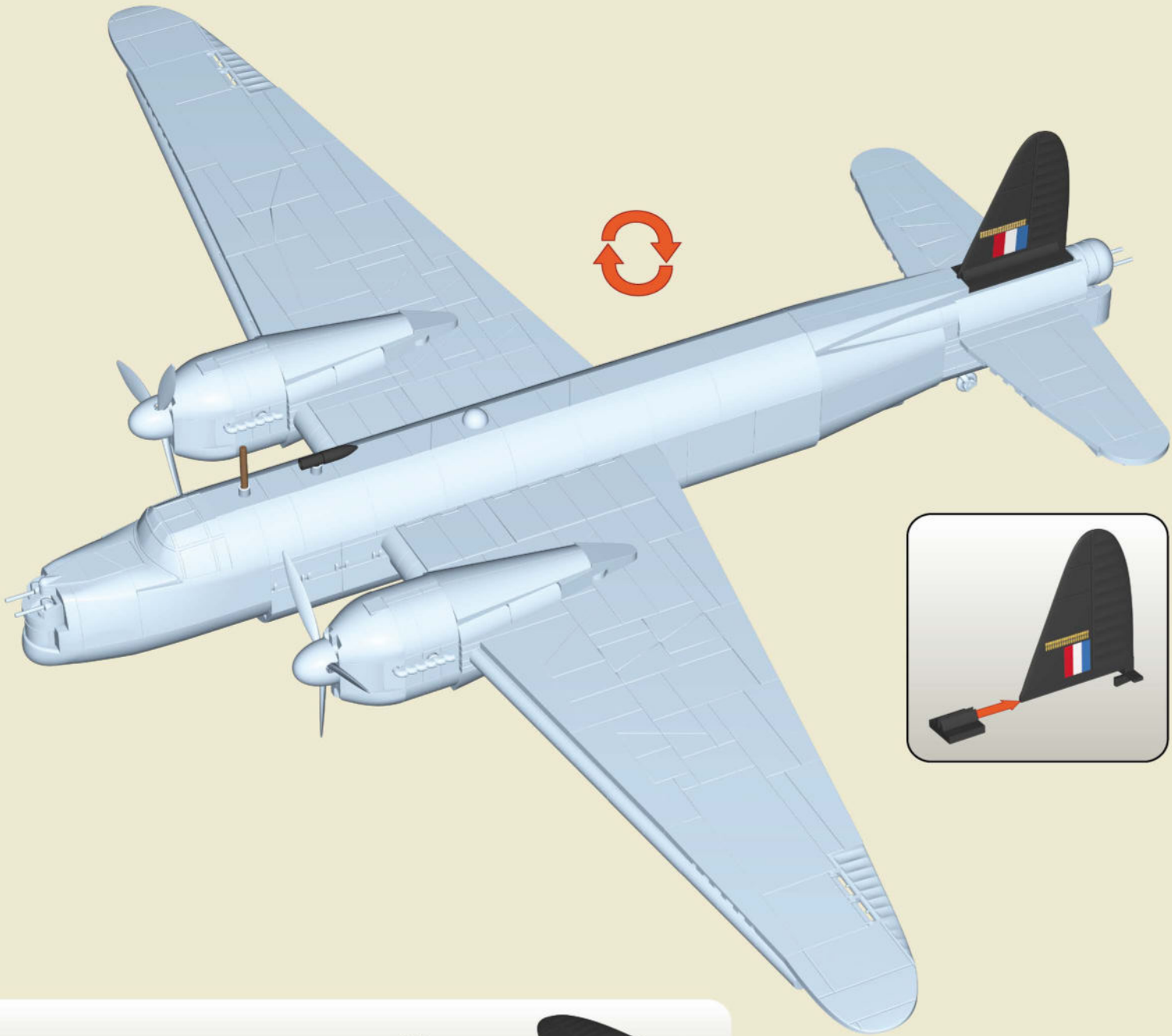
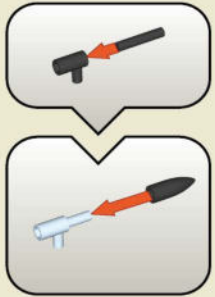

x1



x1



x1



x1



x3



x1

x4 131186	x2 109560	x6 138457	x14 43969	x11 42869	x2 67218	x16 112848	x2 109854	x4 106741	x4 118376	x2 42879
x6 42880	x3 42882	x2 44070	x6 44969	x4 90342	x16 90514	x4 93052	x2 115528	x2 111576	x4 76804	x2 90220
x2 92239	x8 117781	x10 139897	x2 42928	x34 42929	x2 42931	x4 42910	x12 42911	x2 42913	x4 42937	x2 42919
x10 42920	x2 42922	x2 103188	x2 106765	x10 106152	x2 104956	x12 85464	x1 128891	x1 115866	x4 129969	x3 45159
x17 45158	x4 45540	x6 107604	x12 129451	x3 100727	x2 42950	x6 111486	x12 45012	x1 42893	x24 42903	x2 140604
x4 139901	x2 132611	x8 111184	x3 101230	x5 98140	x4 95016	x4 81905	x8 109024	x2 140606	x16 133043	x2 132618
x5 42955	x9 42957	x7 42959	x5 95647	x6 98888	x4 93457	x4 124623	x2 115501	x4 115502	x2 108050	x8 98979
x2 99234	x3 117257	x1 120910	x3 122044	x1 120907	x10 140520	x8 117260	x2 109025	x14 42974	x3 42976	x8 42983
x8 42992	x3 62197	x2 61577	x6 131061	x6 74518	x1 140358	x4 110514	x6 134106	x2 64212	x2 86041	x2 85566
x1 43014	x21 43015	x1 43017	x3 85499	x2 83478	x7 127891	x6 136448	x2 65704	x2 107611	x6 43031	x1 69517
x2 72334	x2 43022	x3 43081	x8 43082	x3 43084	x3 140605	x1 129065	x1 43089	x5 43090	x1 43092	x1 100129
x3 98905	x20 43098	x1 43111	x3 43112	x1 43114	x12 83529	x7 45303	x6 45467	x1 45608	x4 45578	x4 45468
x2 96242	x1 90455	x1 101189	x1 43073	x3 136848	x4 118455	x1 112985	x4 129565	x2 117450	x1 136734	x6 124624
x1 121252	x1 43151	x18 43152	x1 43154	x5 89467	x3 86989	x6 86097	x6 74224	x3 43135	x1 43165	x19 43166

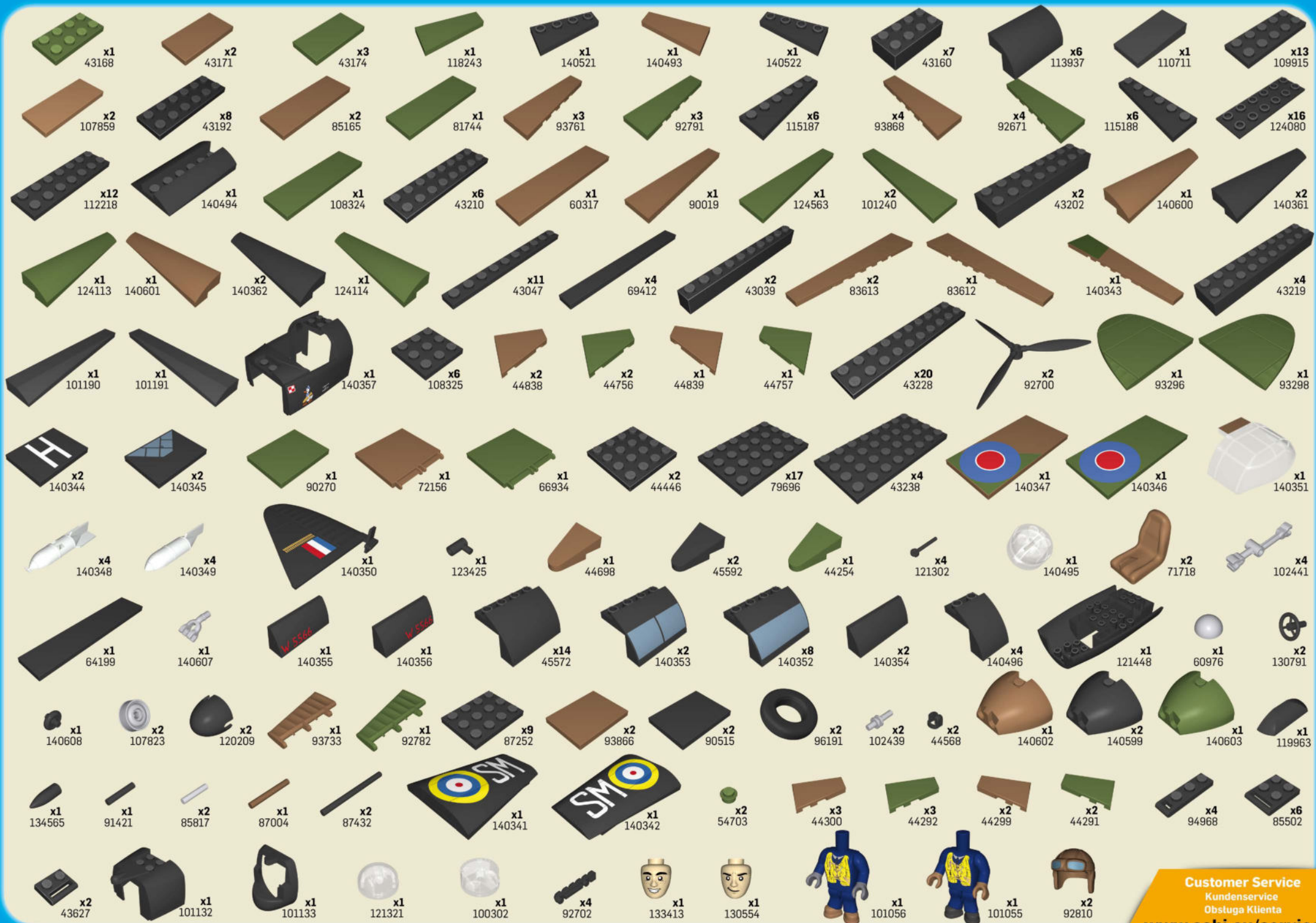



HISTORICAL COLLECTION



MORANE-SAULNIER MS.406
🇫🇷 5724



DE HAVILLAND MOSQUITO FB MK. VI
🇬🇧 5718



DEWOITINE D.520
🇫🇷 5720



LOCKHEED® P-38 LIGHTNING® (H)
🇺🇸 5726



WWW.COBI.EU

00-05723-1150

For news and special deals

Find us on:
f cobi.bricks
i cobi.klocki
y COBI SA