

HISTORICAL COLLECTION

WORLD WAR II



DEWOITINE D.520

PLACE OF ORIGIN - FRANCE
 IN SERVICE - 1939 - 1953
 ROLE - FIGHTER
 CREW - 1
 WINGSPAN - 10,2M (33'6")
 LENGTH - 8,6M (28'3")
 HEIGHT - 2,57M (8'5")
 WEIGHT - 2680KG (5,902LB)
 ENGINE - HISPANO-SUIZA 12Y-49, 950HP (710KW)
 RANGE - 1250KM (780MI)
 RATE OF CLIMB - 14,3M/S (2,810FT/MIN)
 MAXIMUM FLIGHT LEVEL - 10000M (33,000FT)
 ARMAMENT - 1x 20MM (.787") HS.404 CANNON,
 4x 7.5MM (.295") MAC 1934 MACHINE GUNS
 MAXIMUM SPEED - 560KM/H (350MPH)



PAD PRINTED
NO STICKERS

5734

Printed in EU



WARNING: CHOKING HAZARD-
 Toy contains small parts.
 Not for children under 3 years.

335 **1**

DEWOITINE D.520

SCALE 1:32

1

BE CAREFUL: NOTICE THE DIFFERENCE

(A) (B) (C) (D)

UWAGA: RÓŻNE KLOCKI

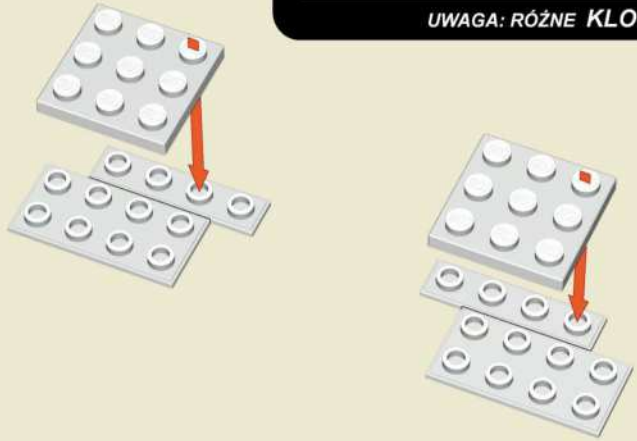

x2



x2



x2

2

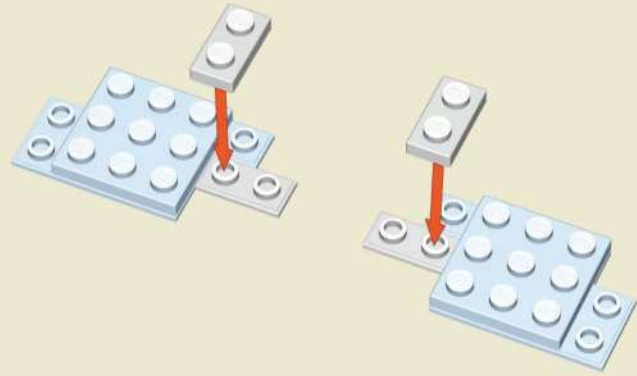

x2



x2

3

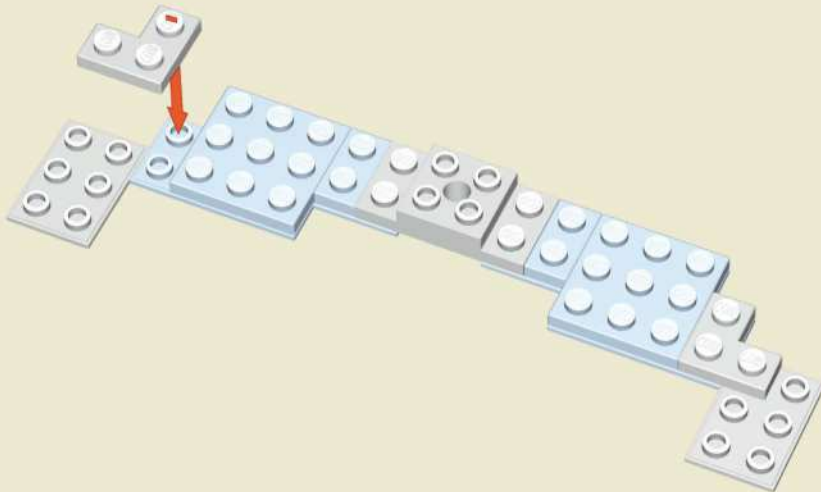

x2



x2



x1

4

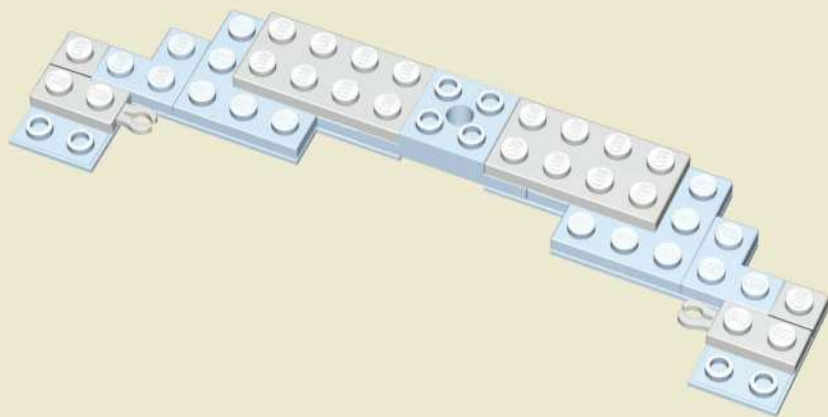

x2



x2



x2

5

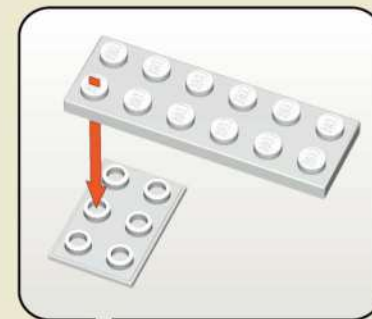
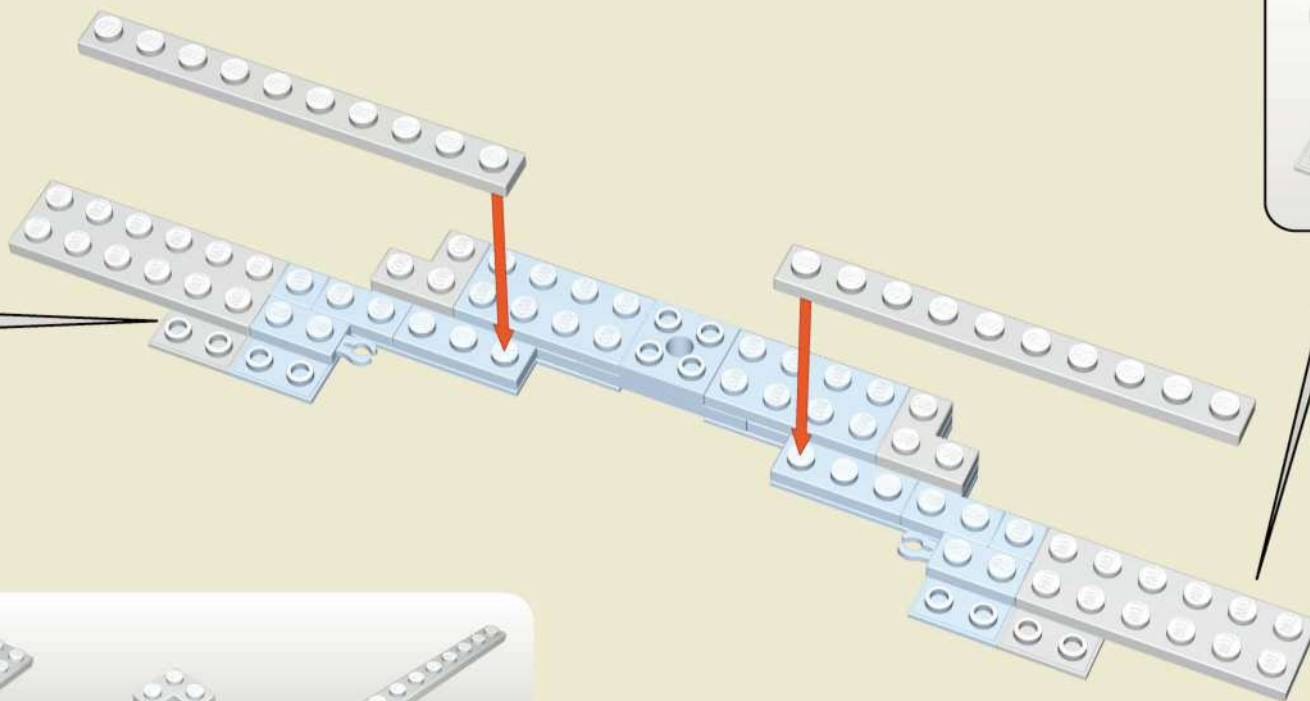

x2



x2



x2



x2

6

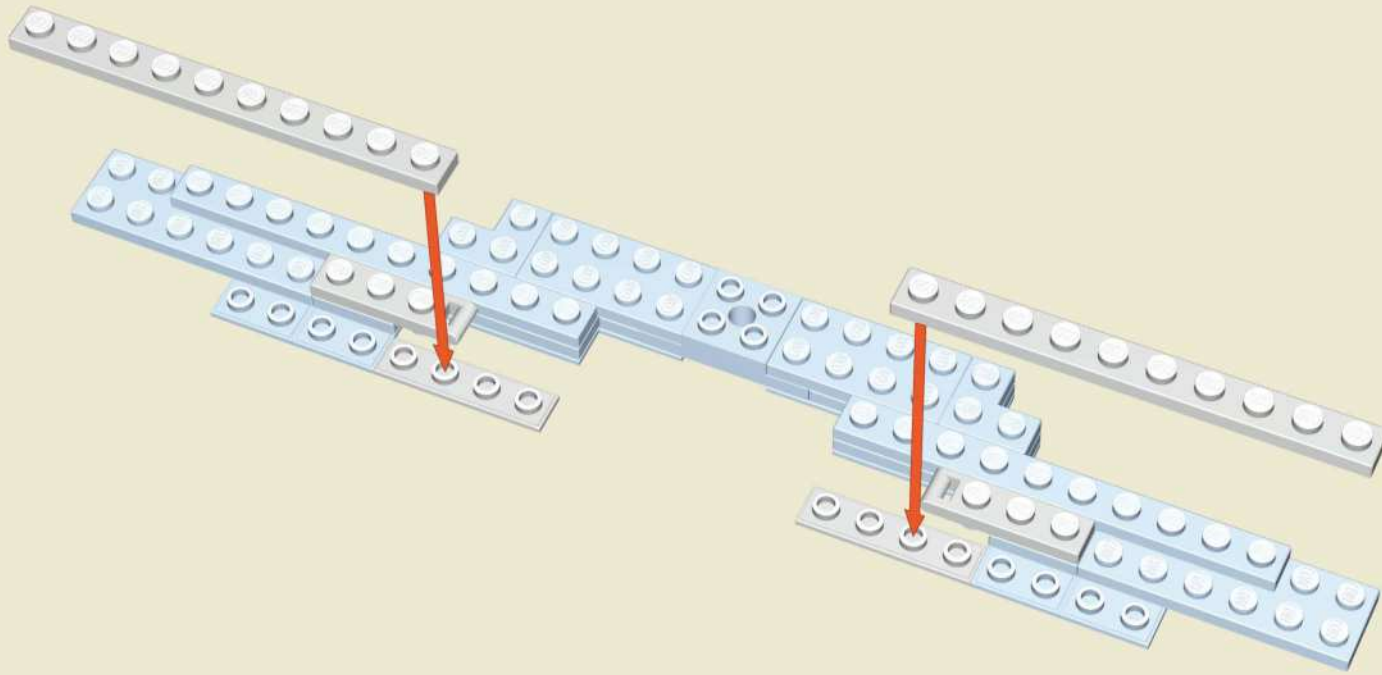

x2



x2



x2

7

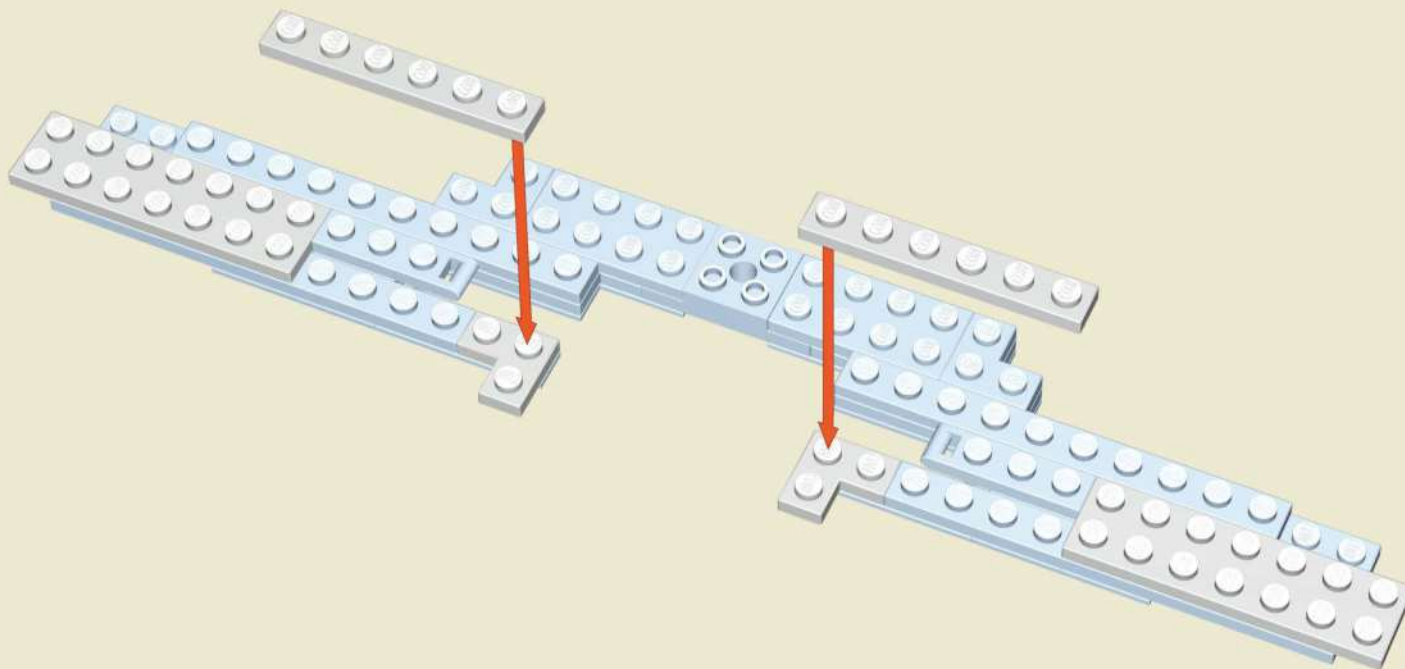

x2







x2

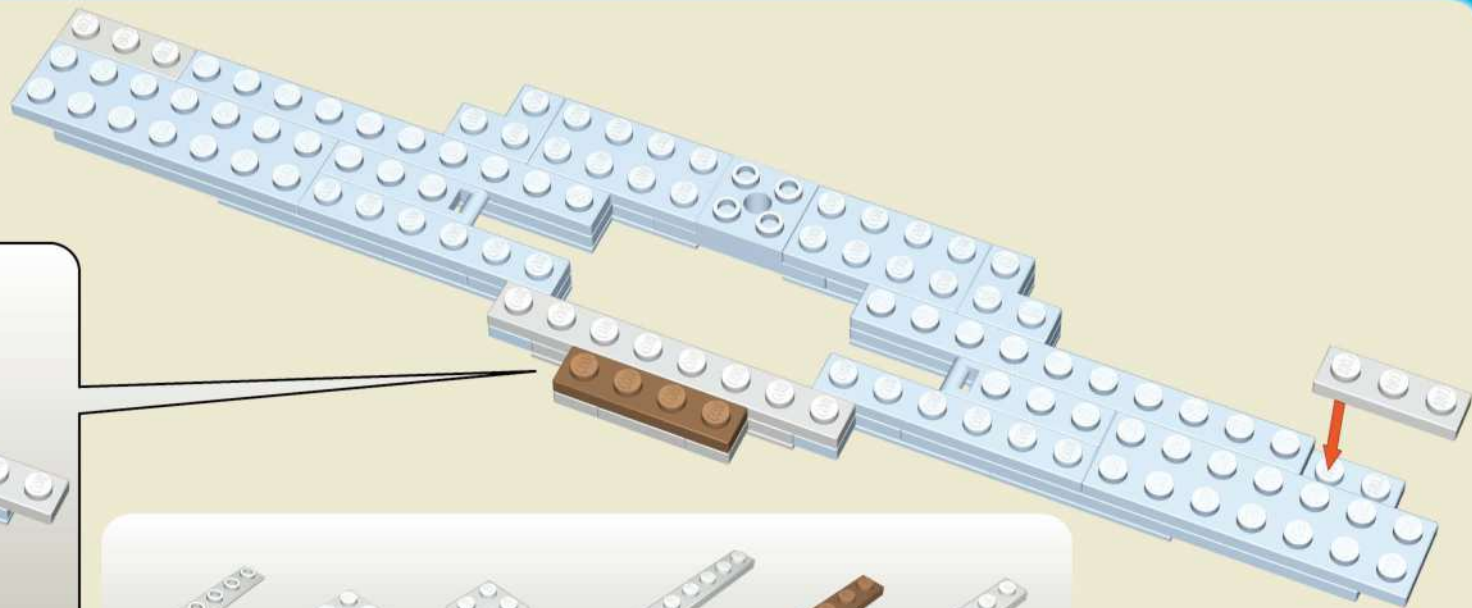
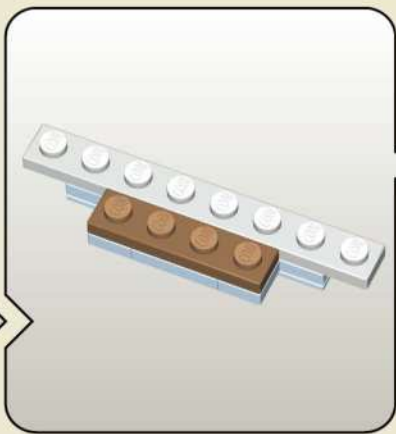
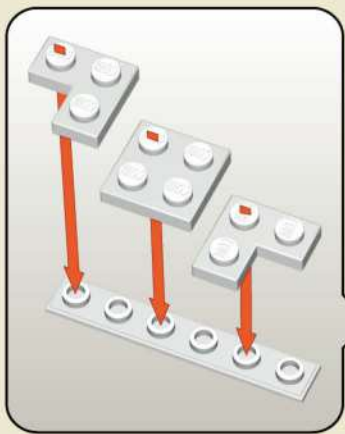

x2





8

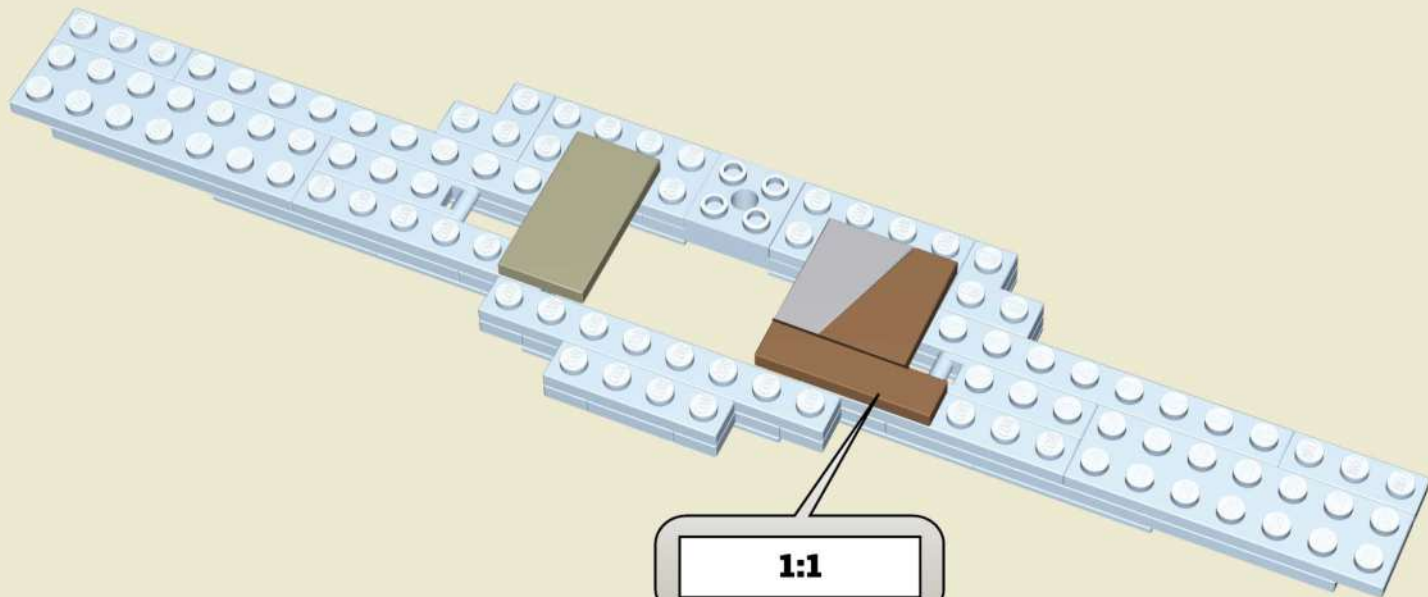

-  x1
-  x2
-  x1
-  x1
-  x1
-  x2

9



-  x1
-  x1
-  x1
-  x1

10

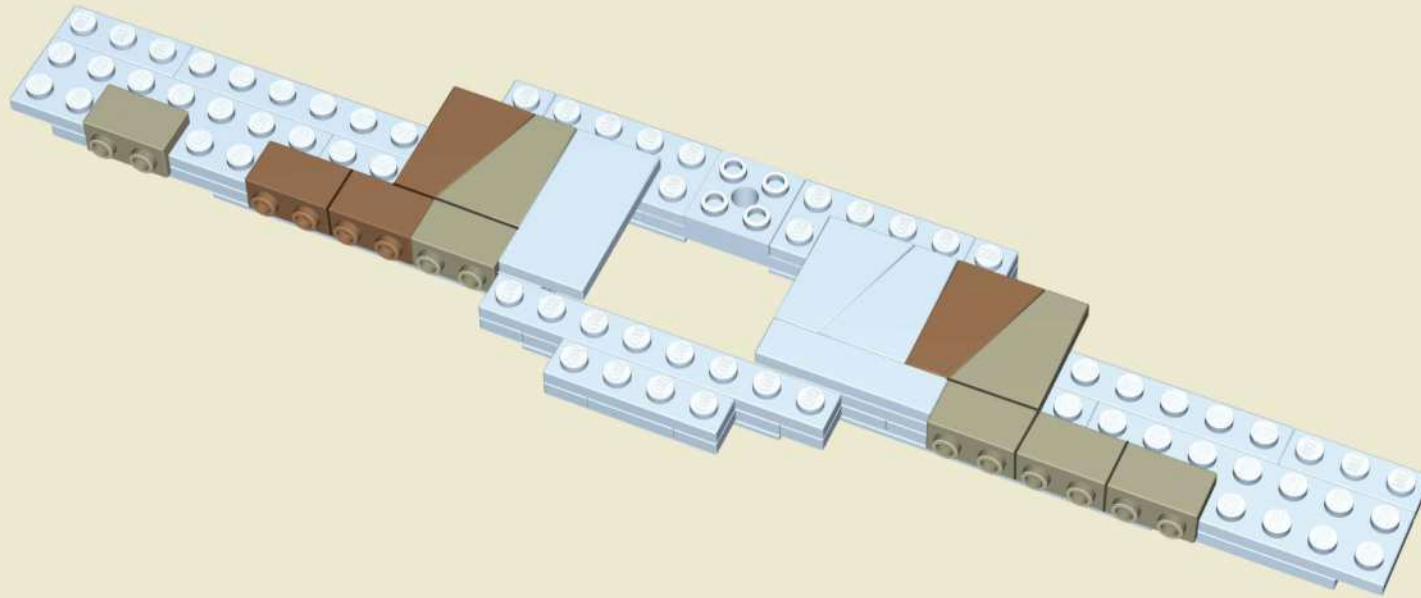

 x5

 x2

 x2

 x2

11

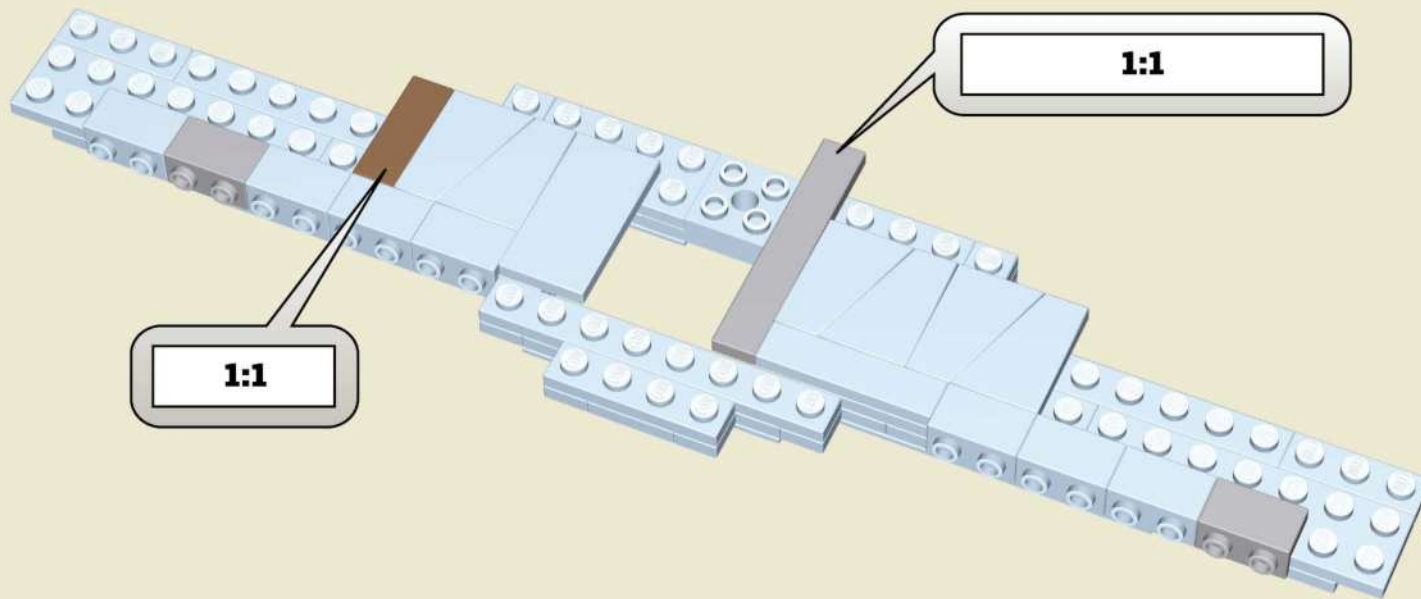





 x2

 x1

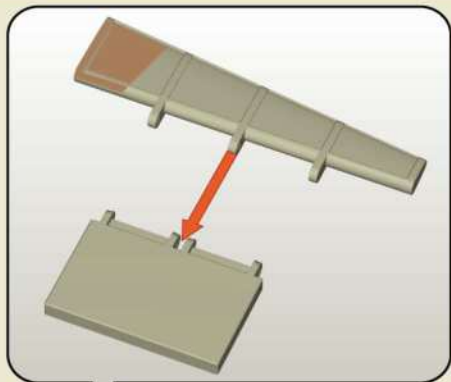
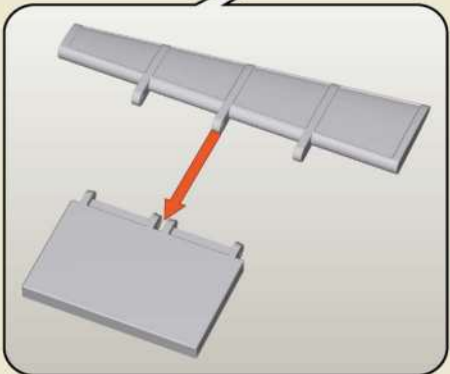
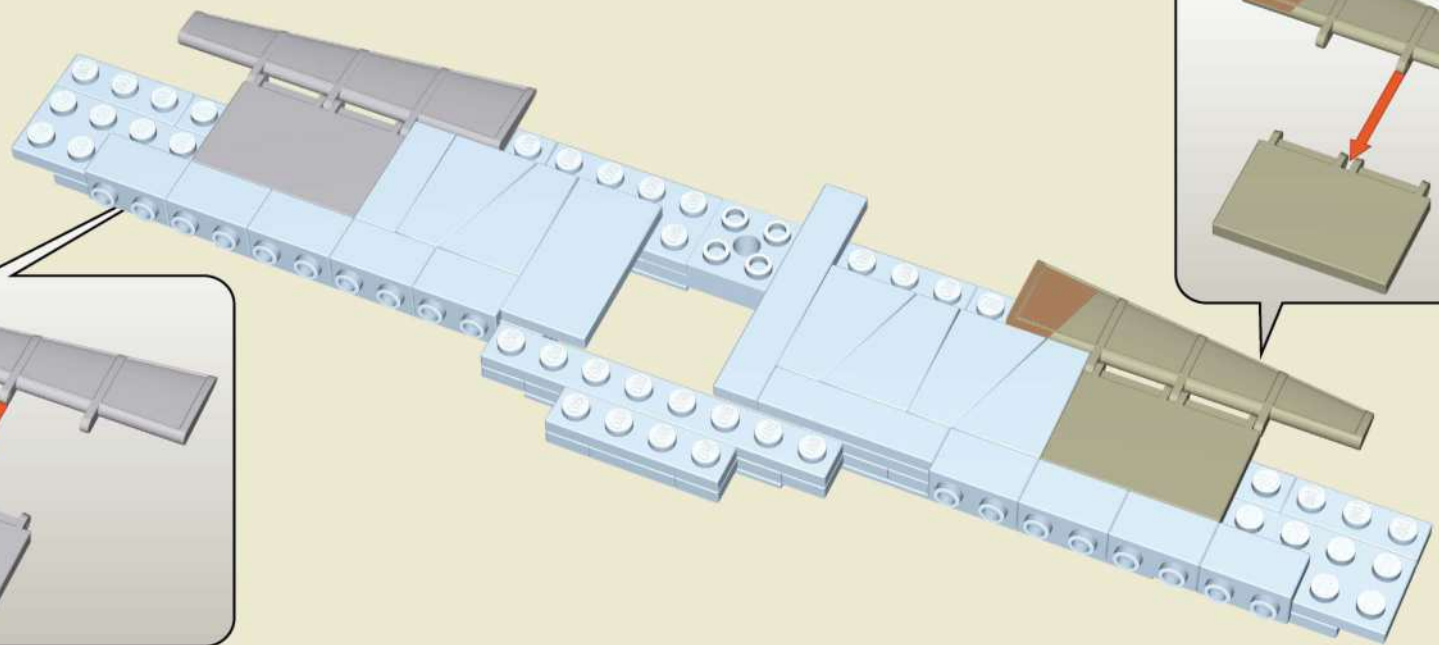
 x1

12

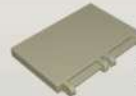



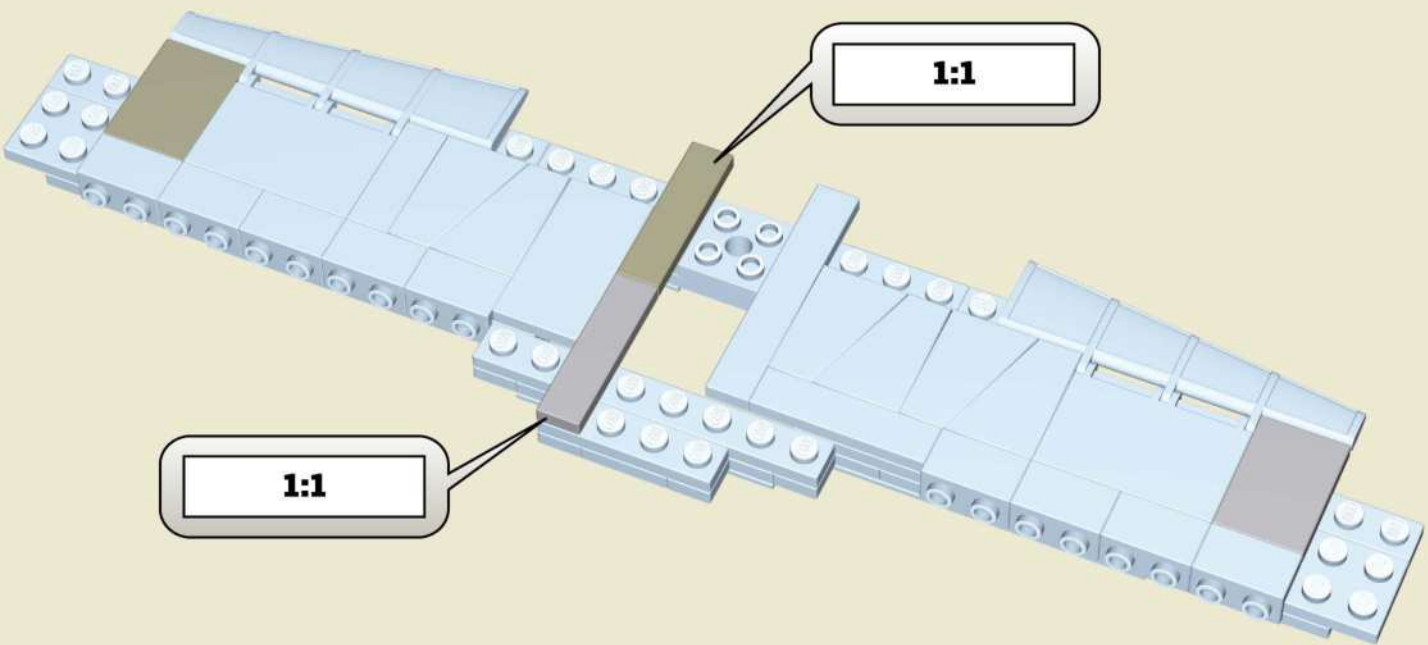

-  xl
-  xl
-  xl
-  xl

13

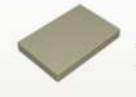

1:1

1:1

-  xl
-  xl
-  xl
-  xl

14

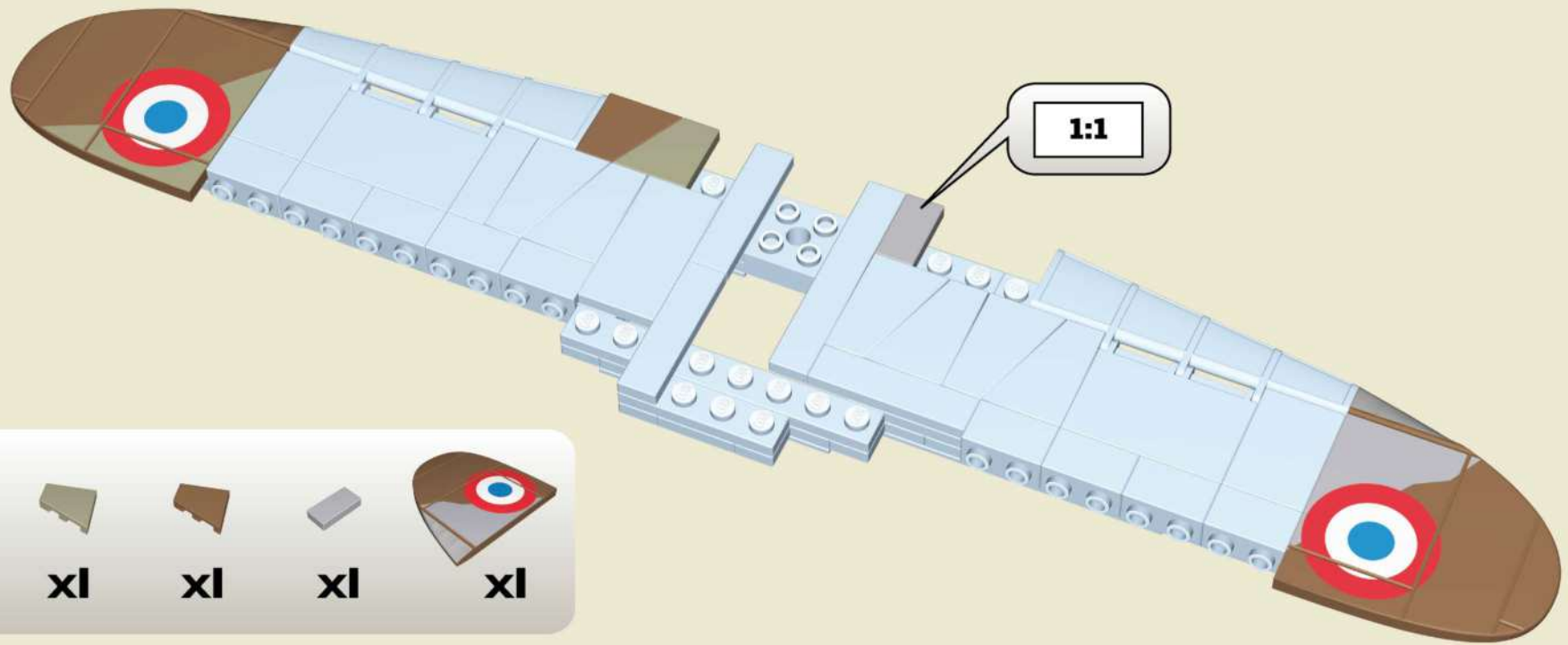

15

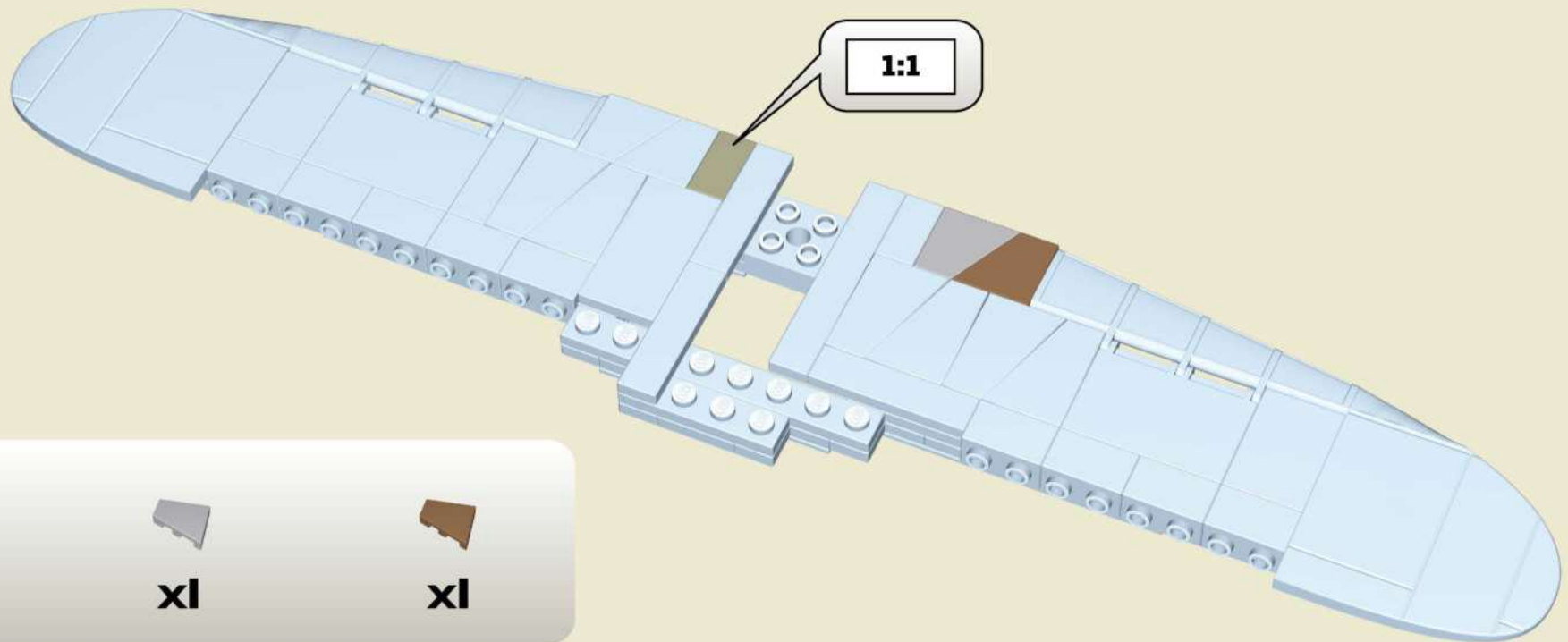

16

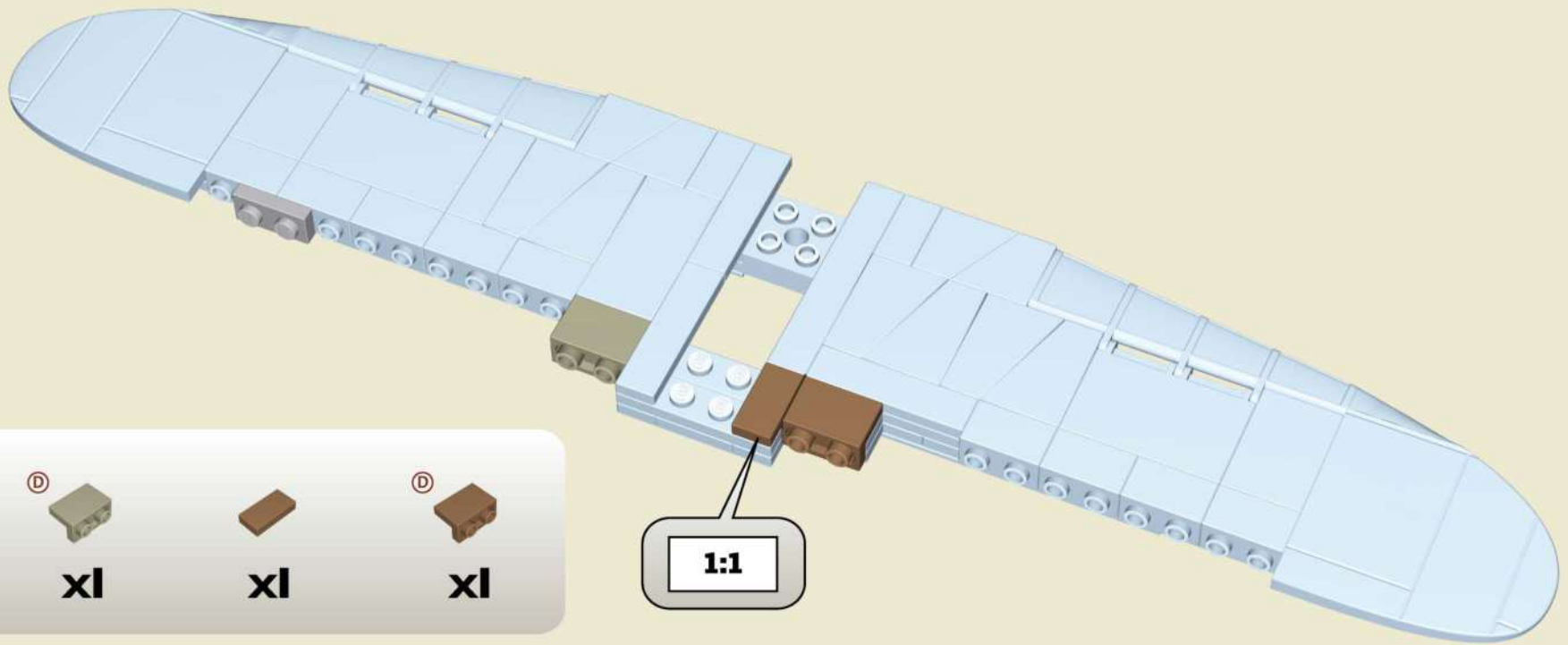

x1



x1



x1



x1

17

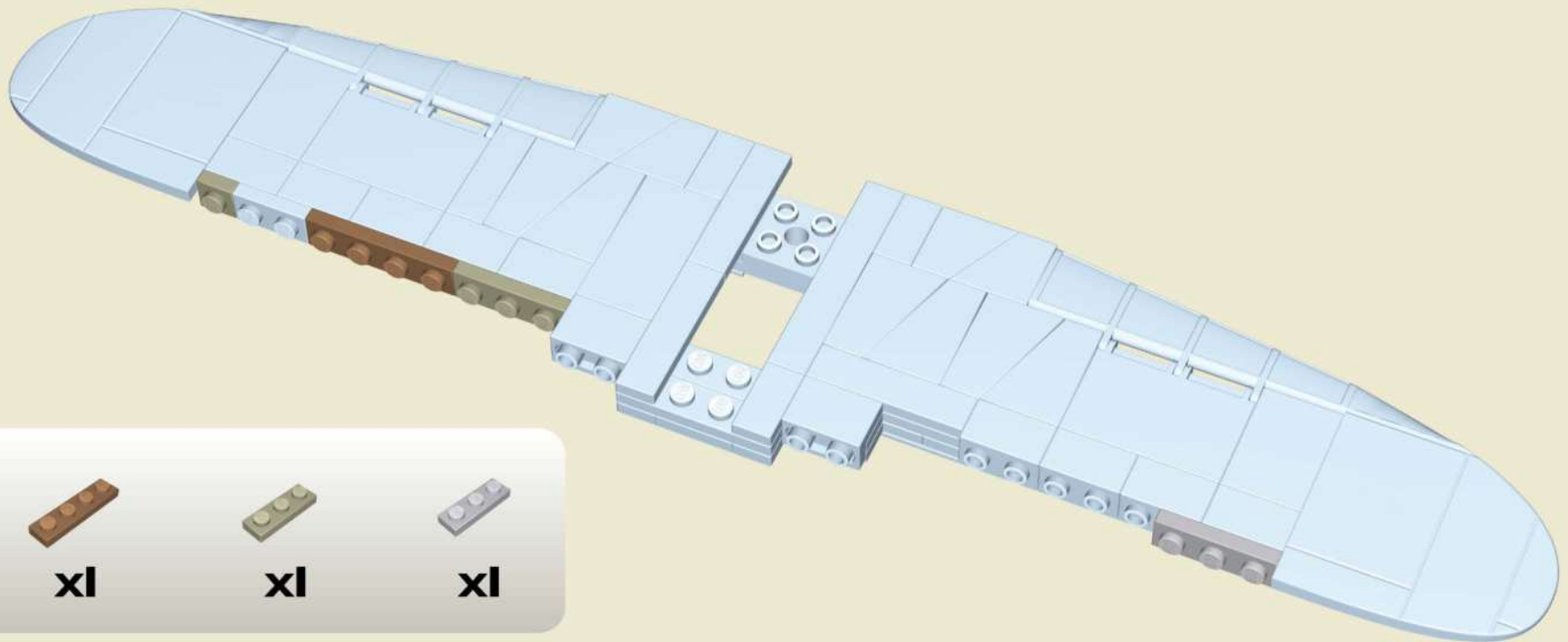

x1



x1



x1



x1

18

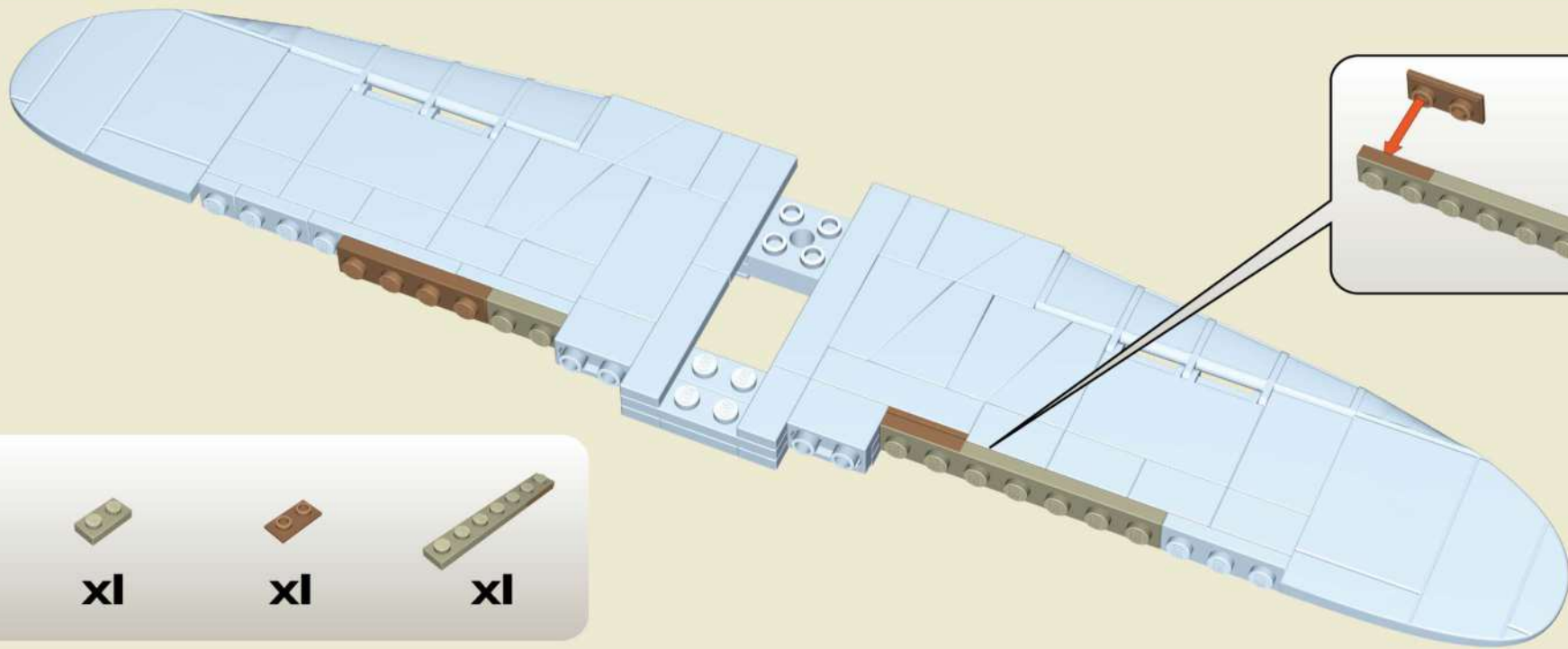

x1



x1



x1



x1

19

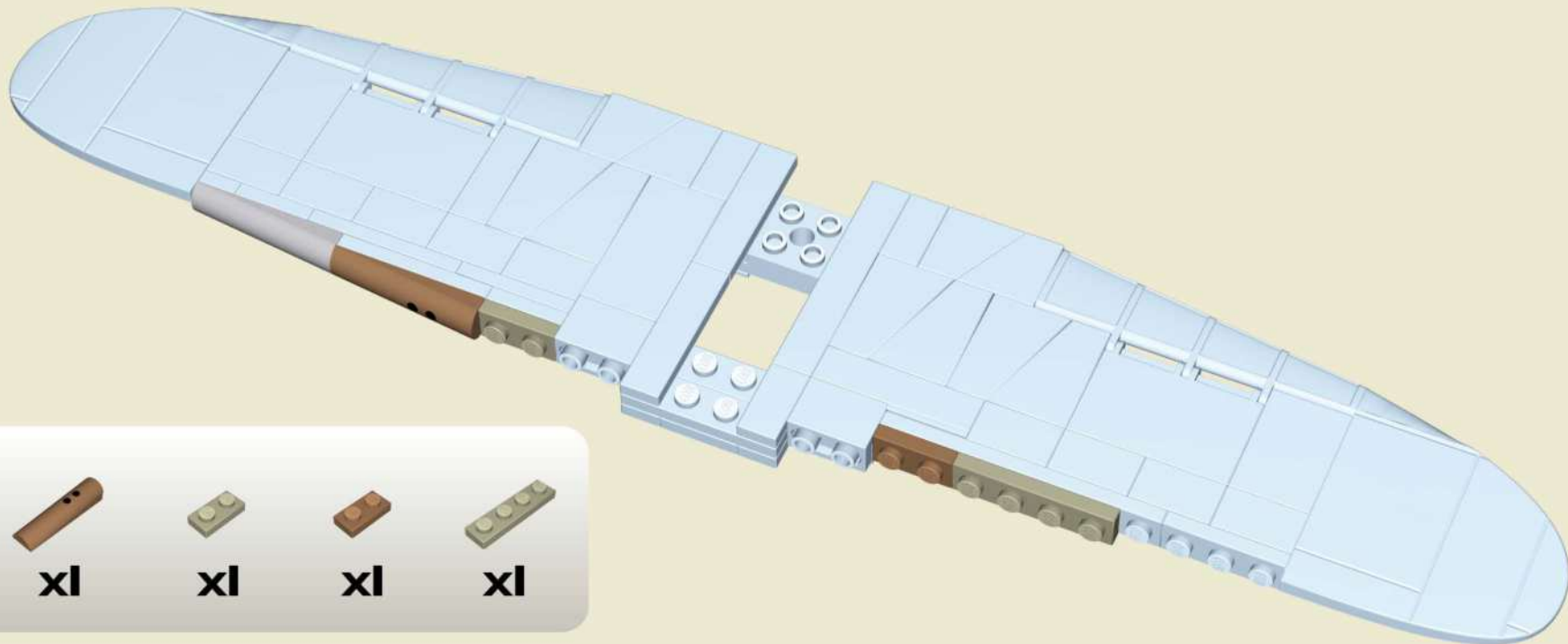

x1



x1



x1



x1



x1

20

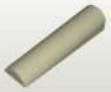
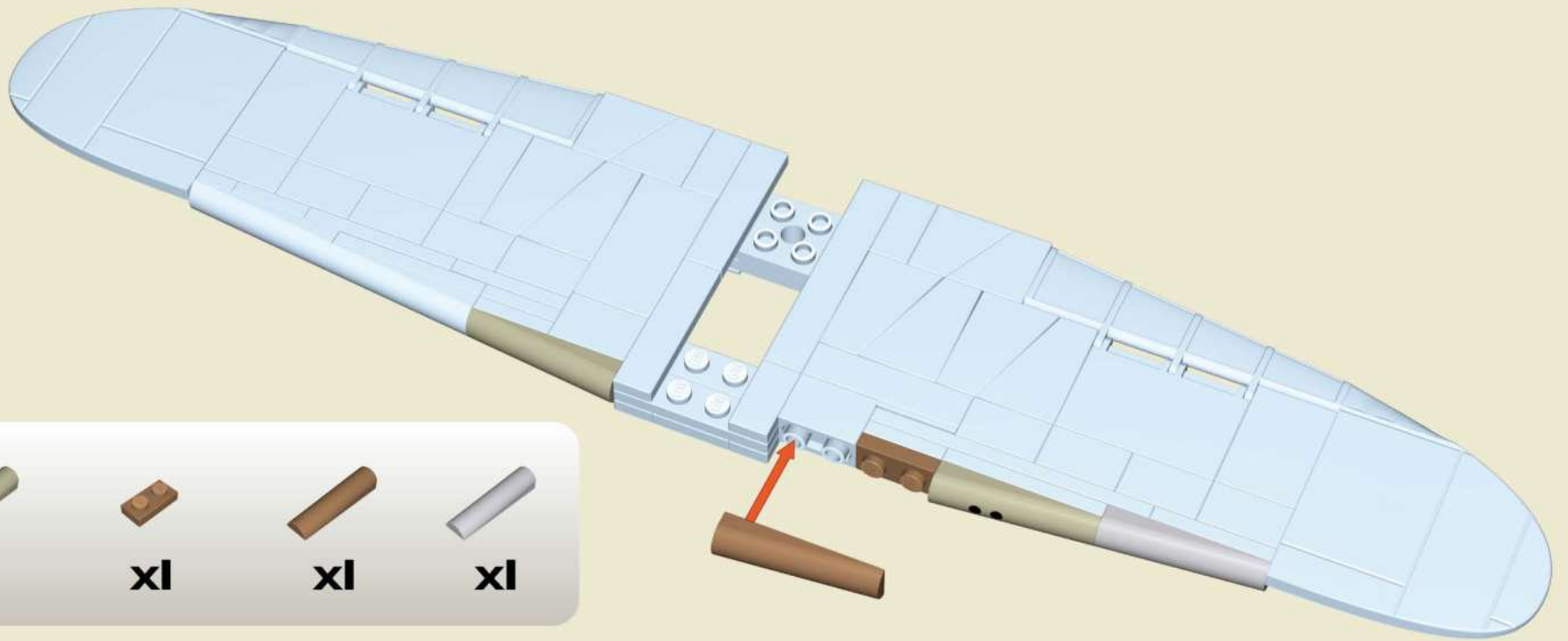

x1



x1



x1



x1



x1

21

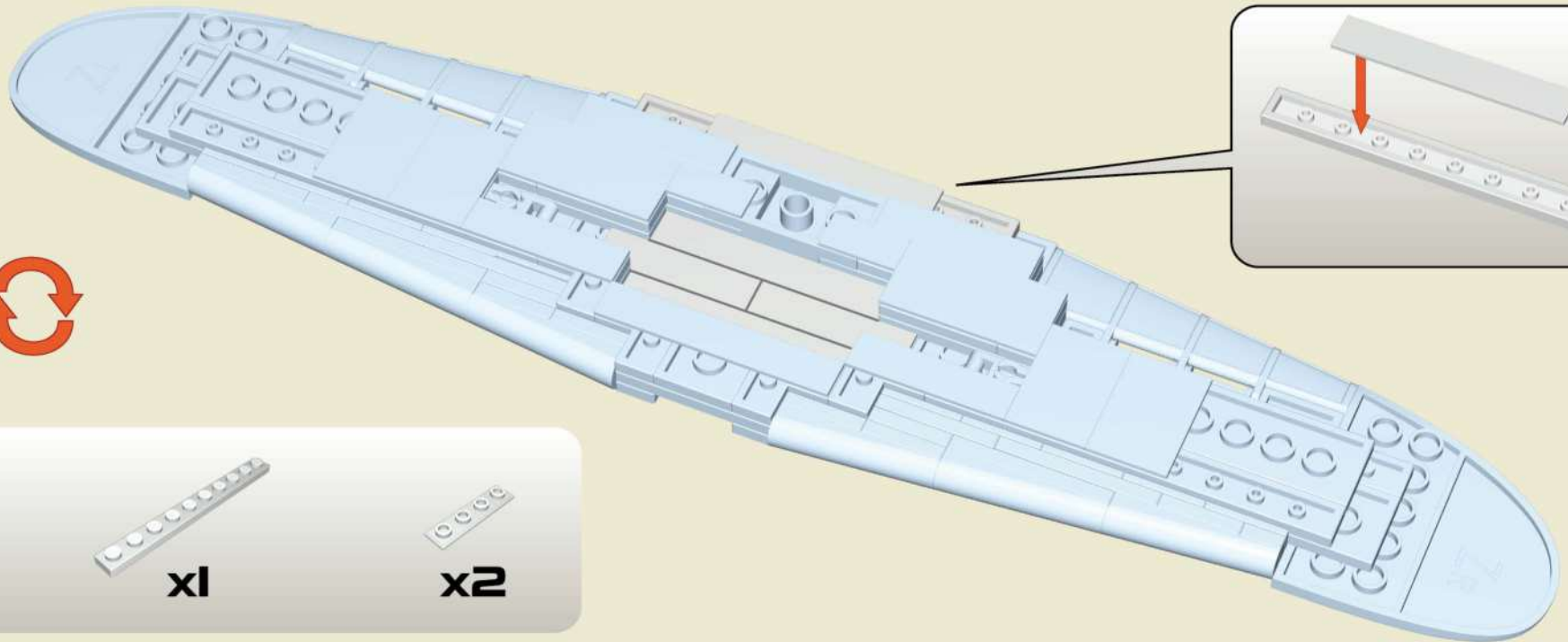

x3



x1



x2

22



-  x2
-  x2
-  x2
-  x2
-  x2
-  x2

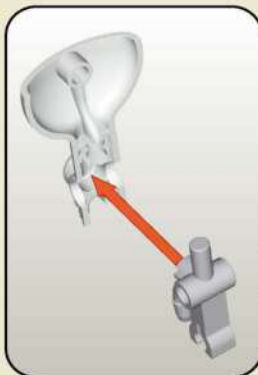
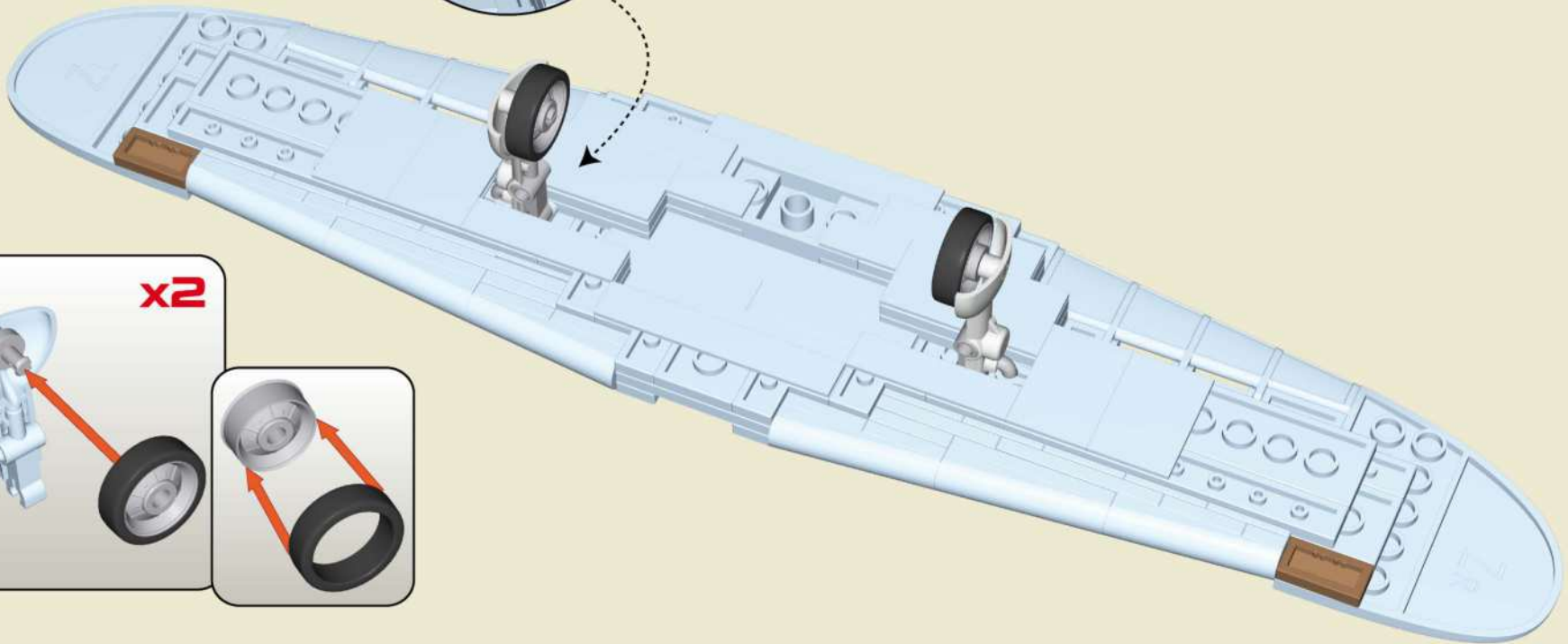

23

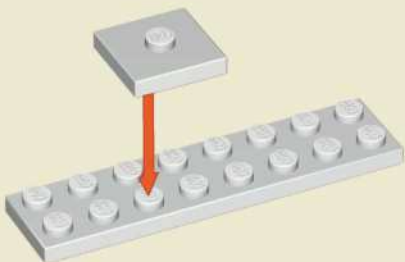

-  x1
-  x1

24

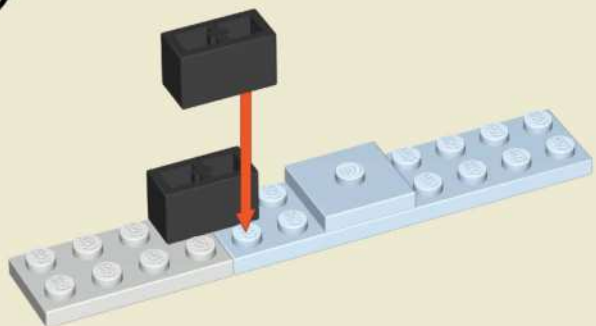

-  x1
-  x2

25

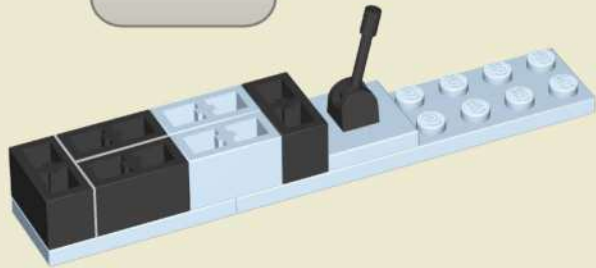

x4



x1



x1

26

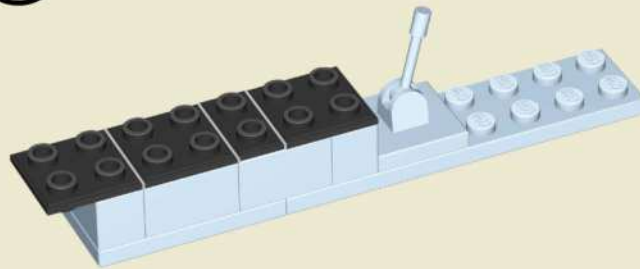

x1



x3

27

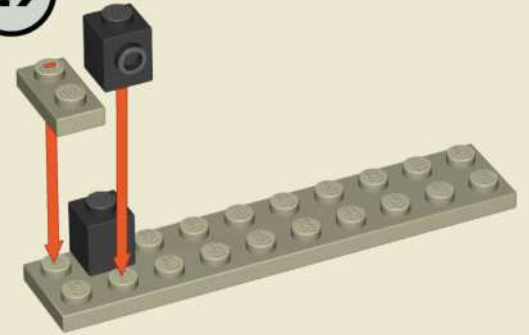

x1



x1



x2

28

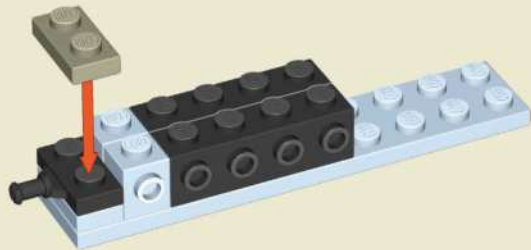

x1



x1



x2

29

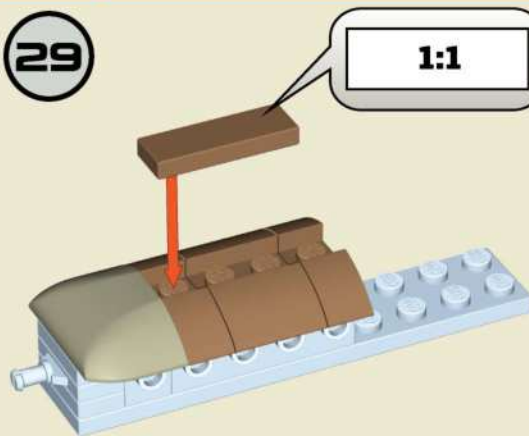

1:1



x1



x2



x1



x1

30



x1

31

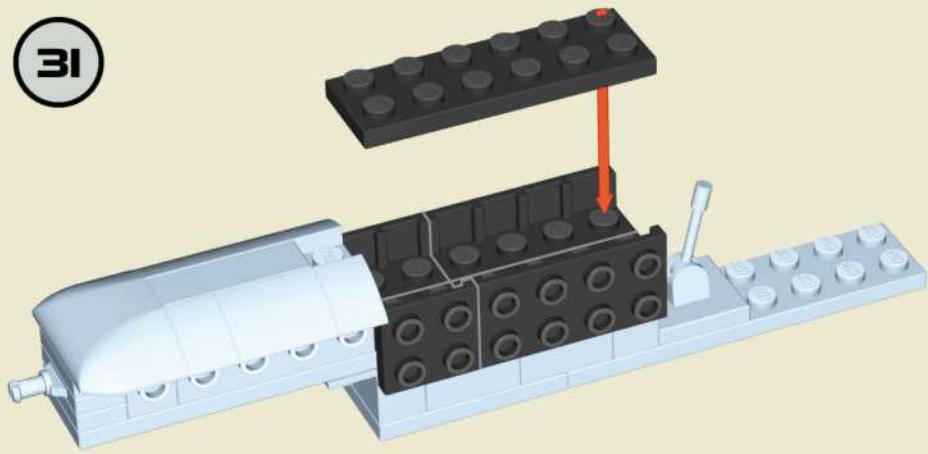

x2



x2



x1

32

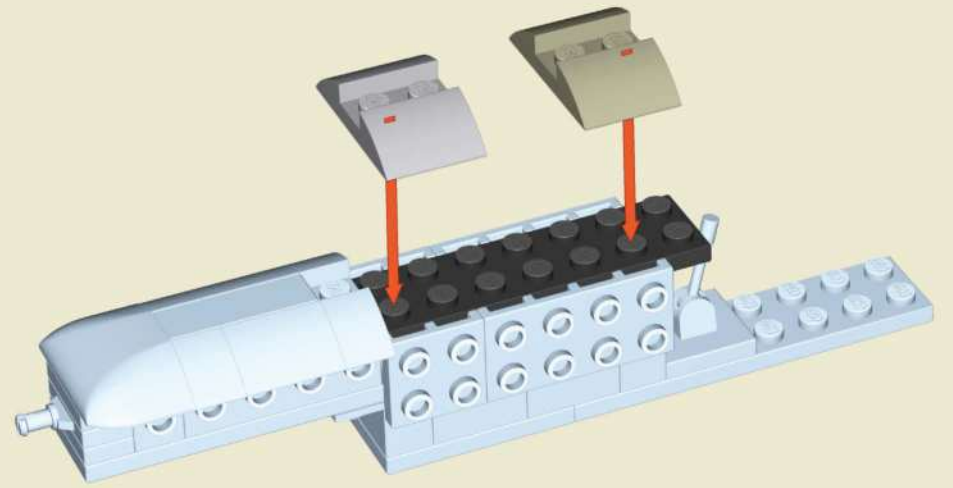

x1



x1



x1

33

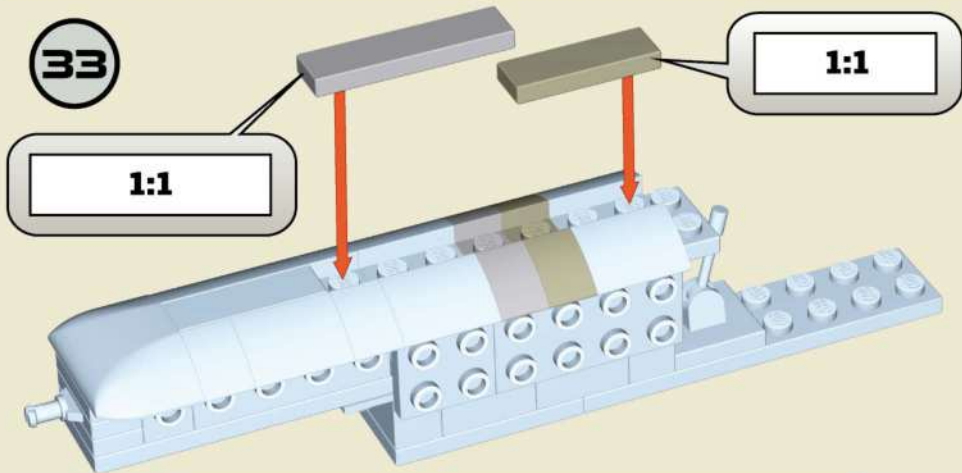

1:1

1:1



x1



x1



x1



x1

34

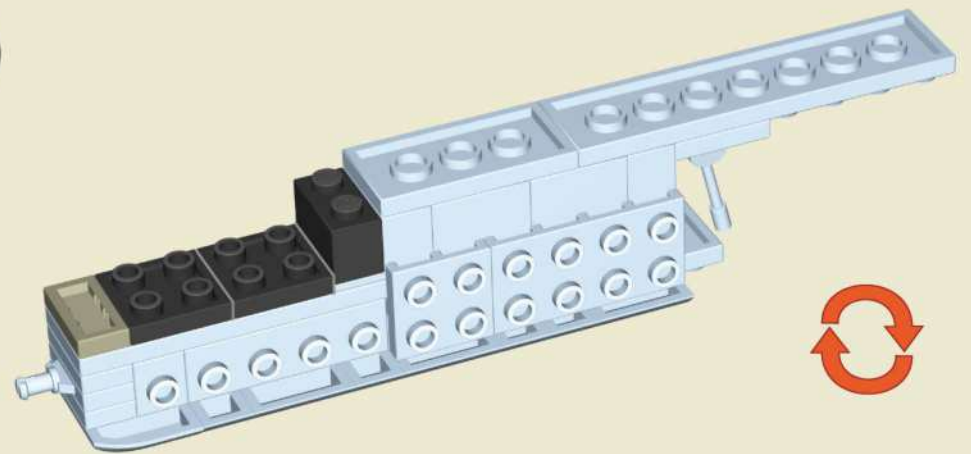

x1



x2



x1

35

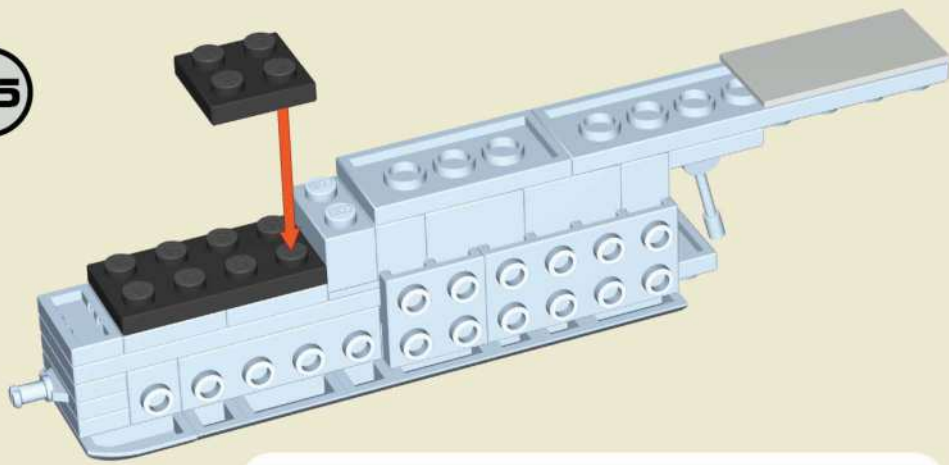

x1



x1



x1

36

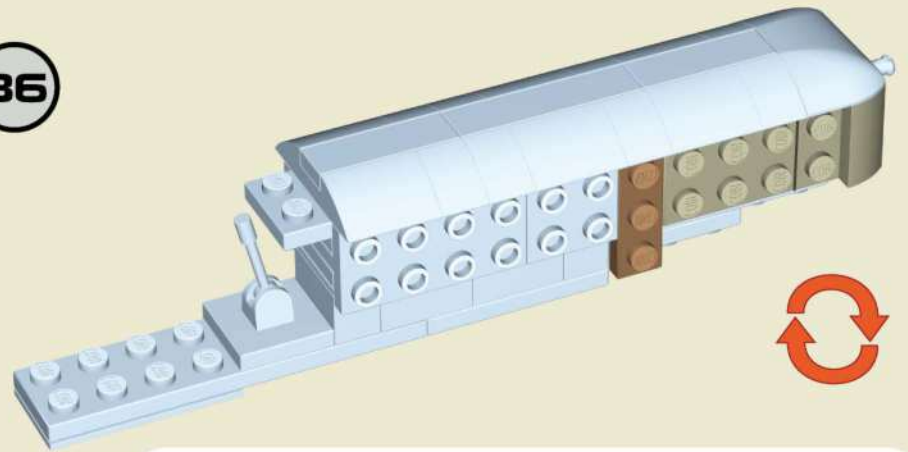

x1



x1



x1

37

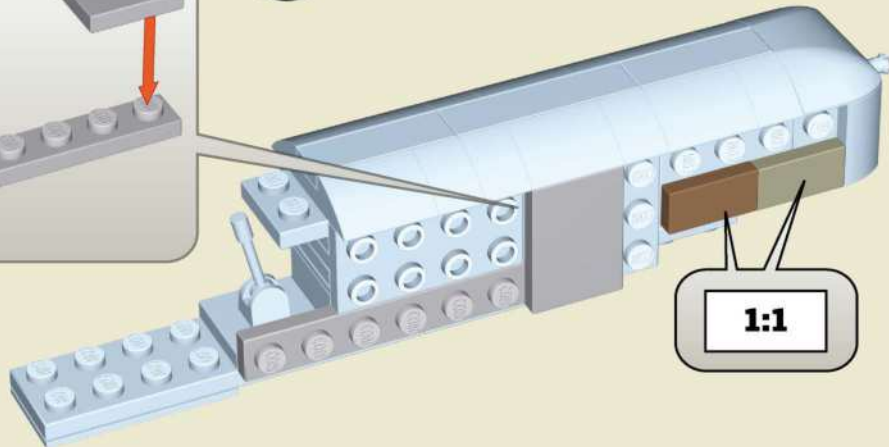
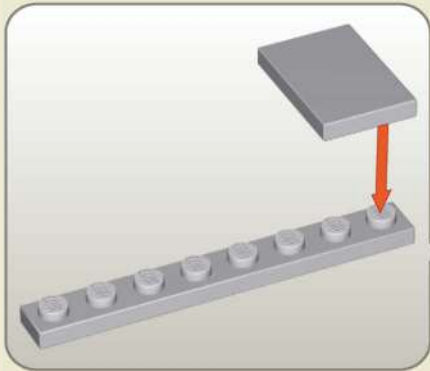

1:1



x1

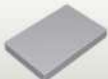

x1



x1



x1

38

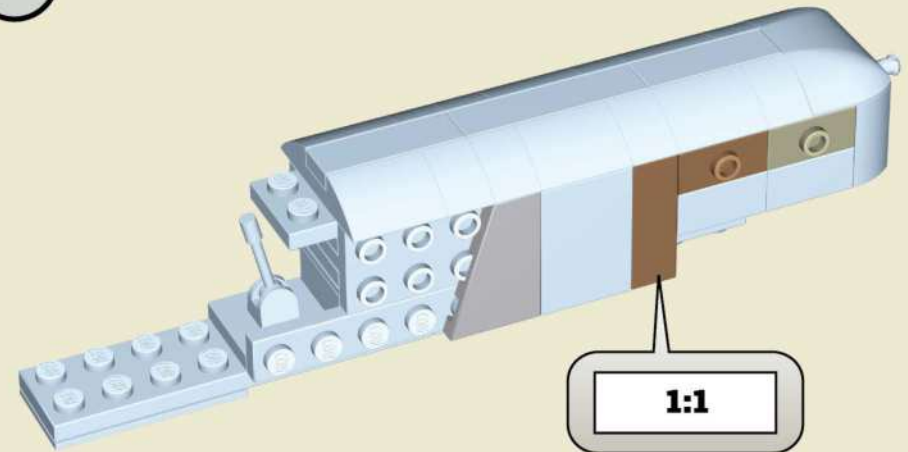

1:1



x1



x1



x1



x1

39

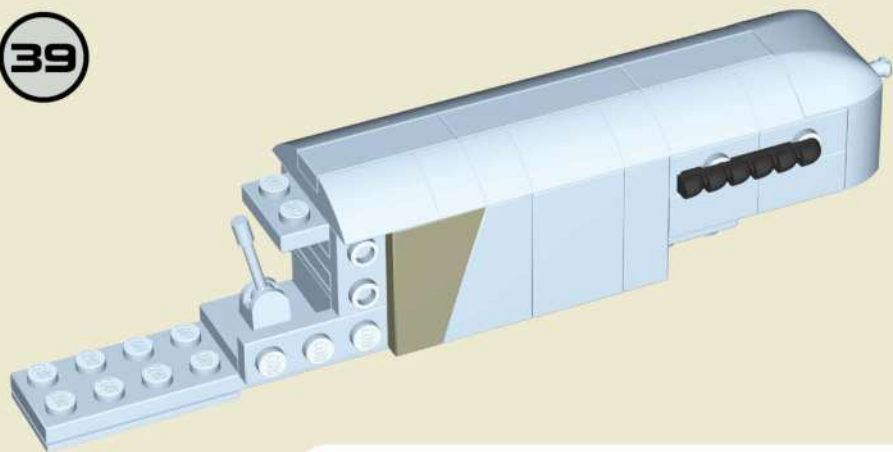

x1



x1

40

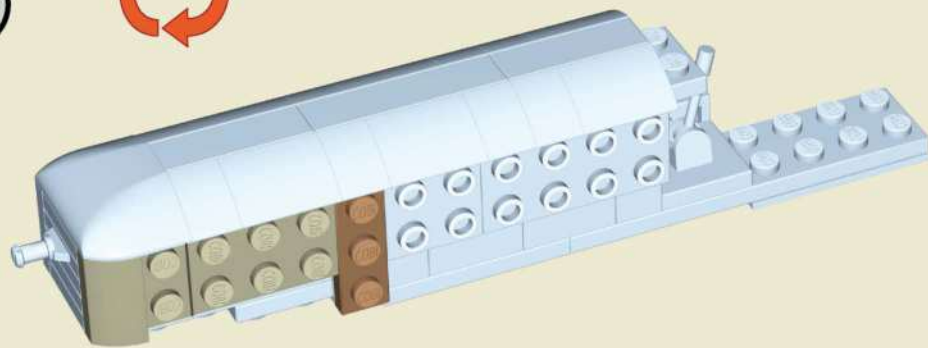

x1



x1



x1

41

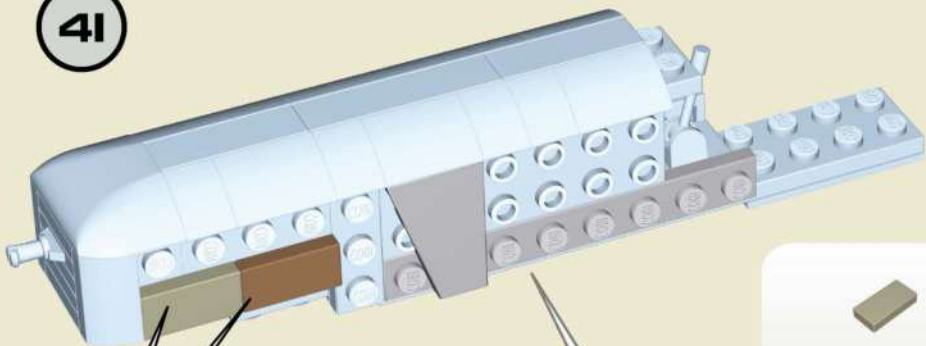

1:1

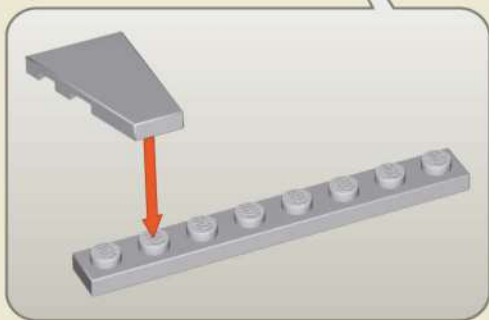

x1



x1



x1



x1

42

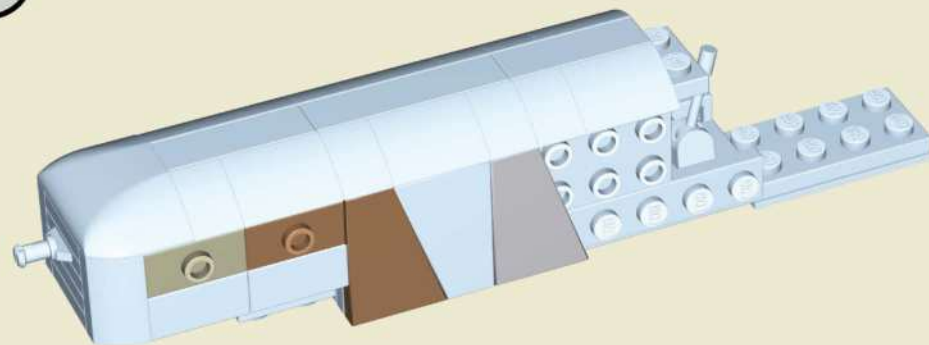

x1



x1



x1

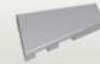

x1

43

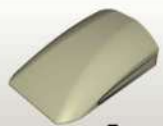
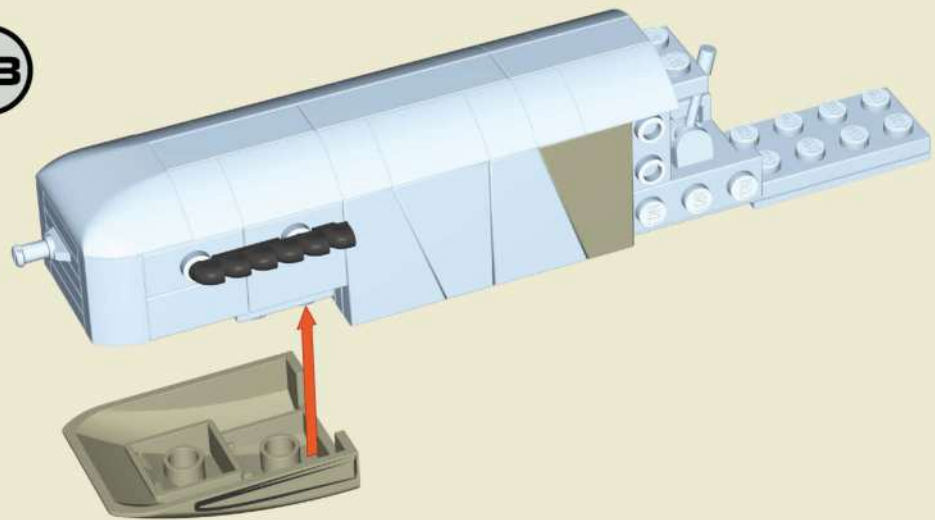

x1



x1



x1

44

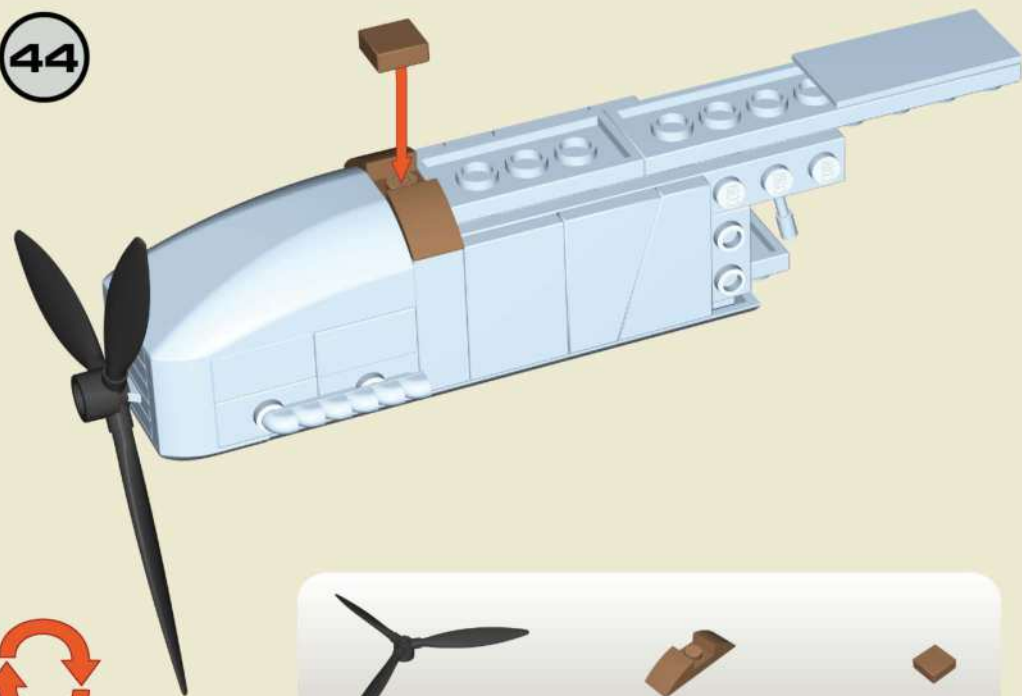

x1



x1



x1

45

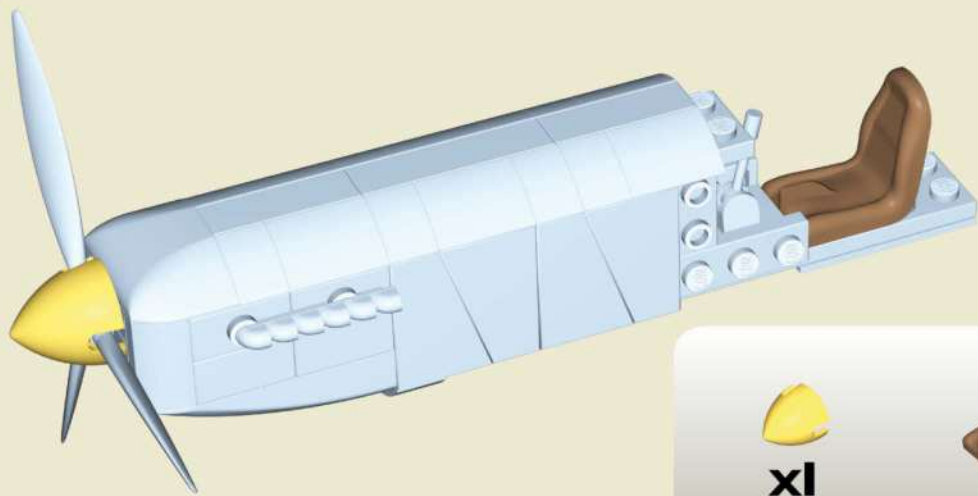

x1



x1

46

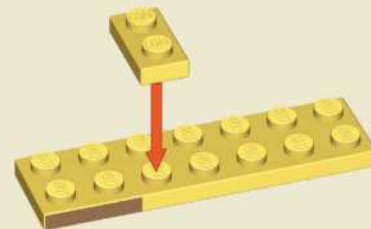

x1



x1

47



48



49

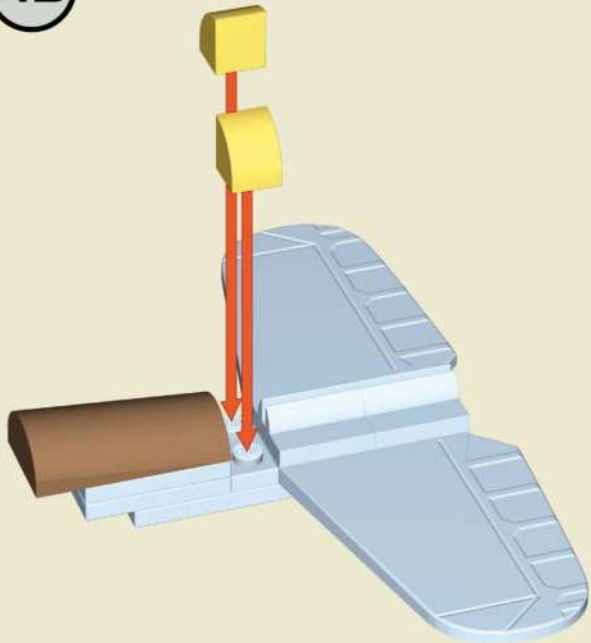

50



51

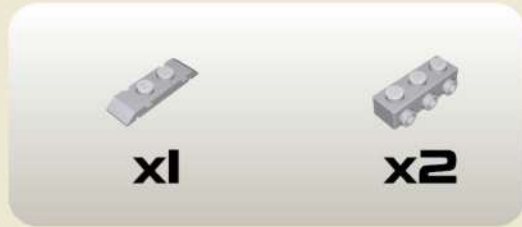
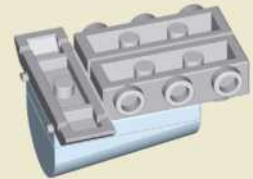

52

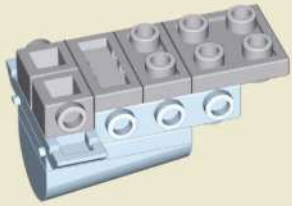

x2



x1



x1



x1

53

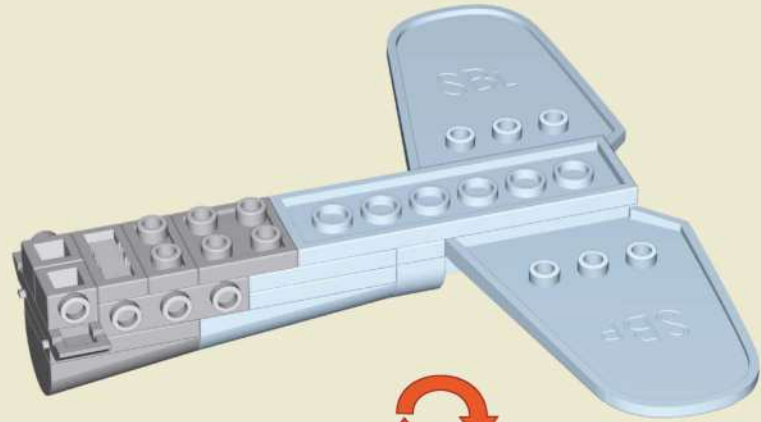

54

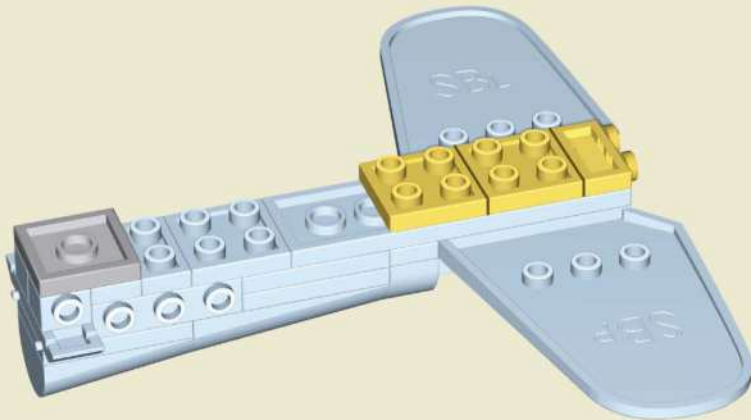

x1



x2



x1

55

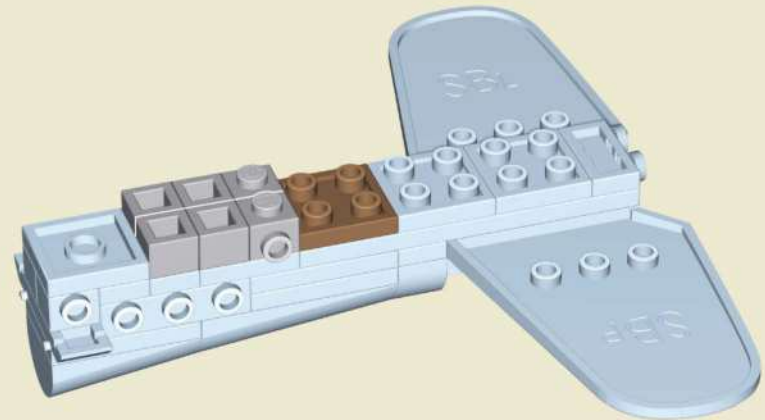

x4



x2



x1

56

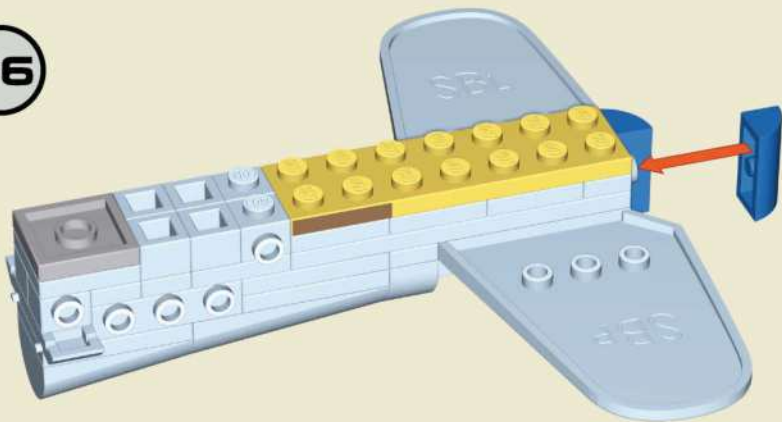

x1



x1



x2

57

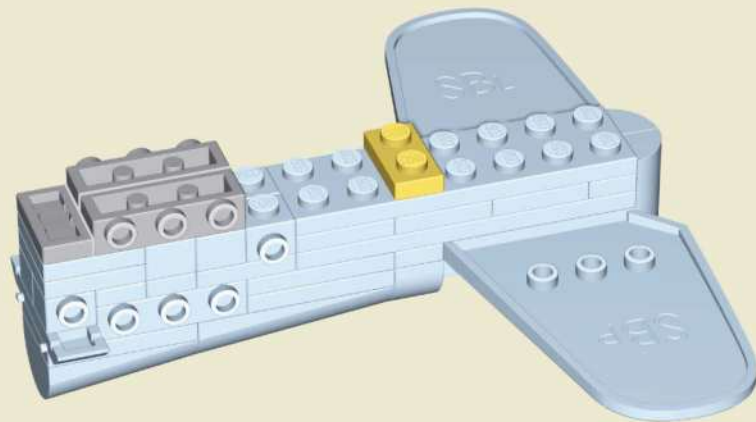

x1



x2



x1

58

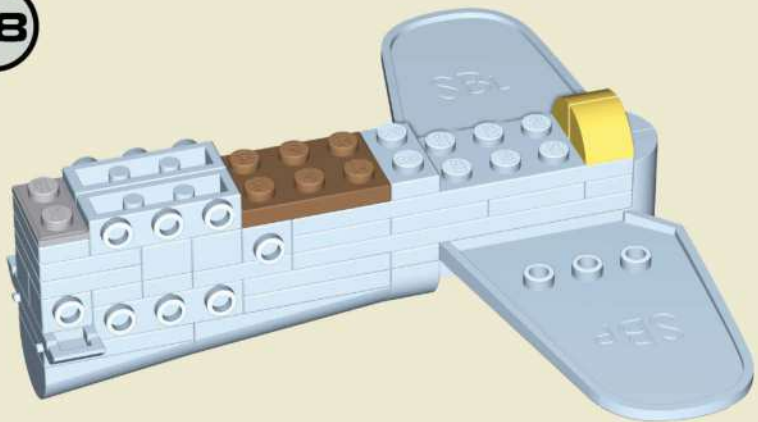

x1



x1



x2

59

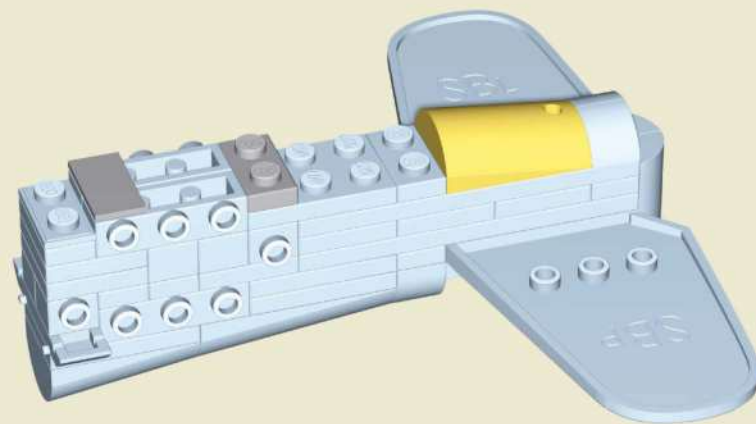

x1



x1



x1

60

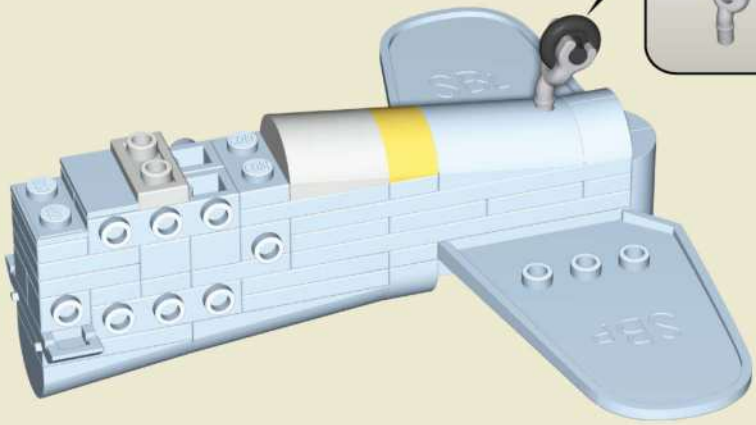

x1



x1



x1



x1

61

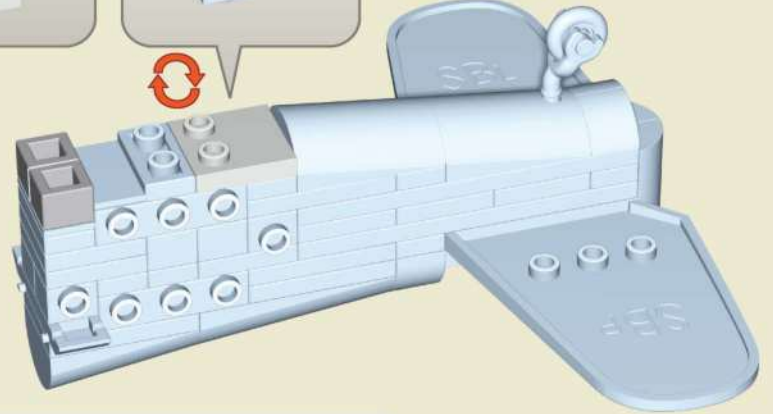
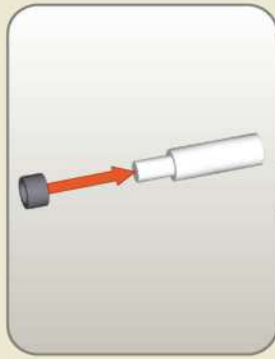

x2



x2



x1

62



x1



x1



x1



x1

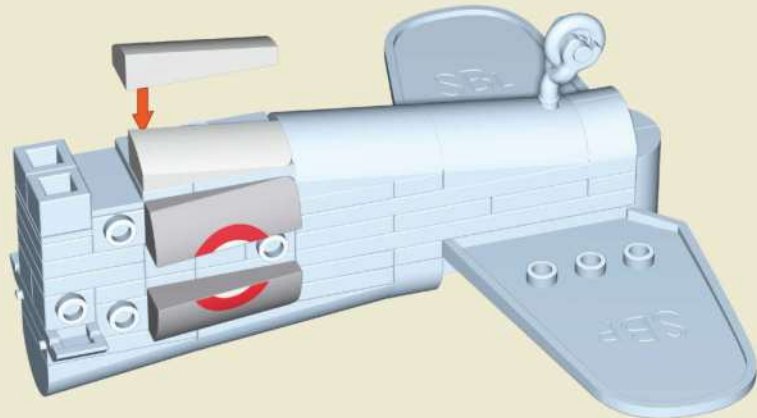

63

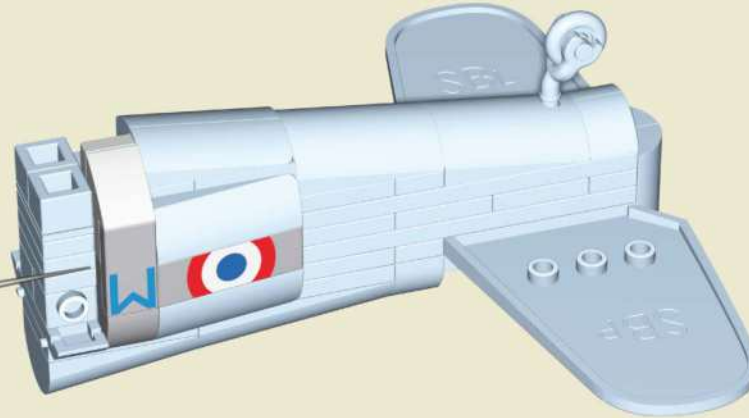
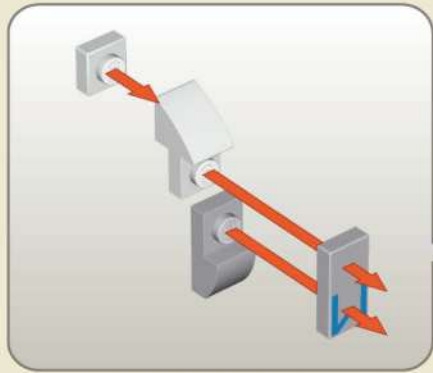

-  **x1**
-  **x1**
-  **x1**
-  **x1**
-  **x1**

64

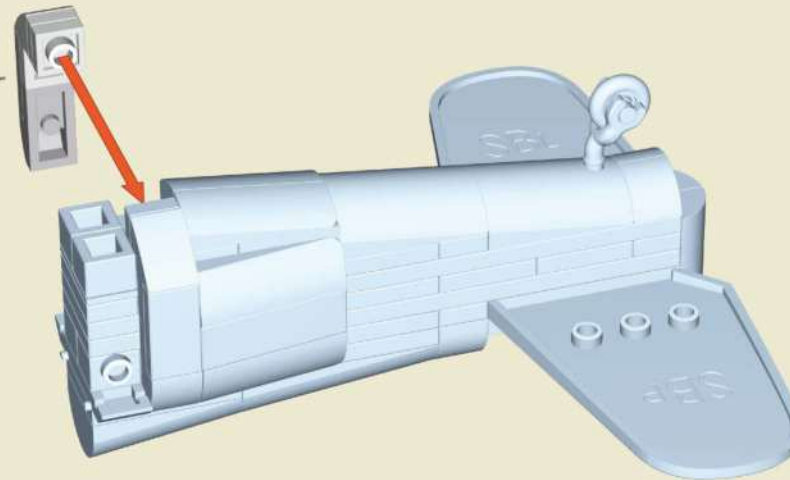
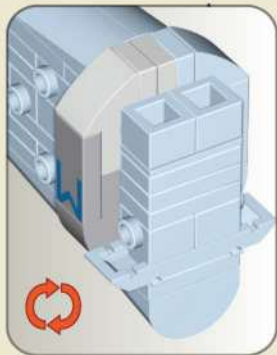
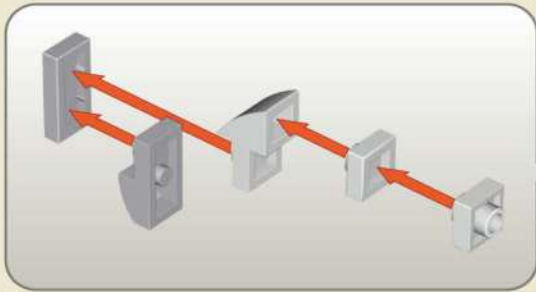

-  **x1**
-  **x1**
-  **x1**
-  **x1**
-  **x1**

65

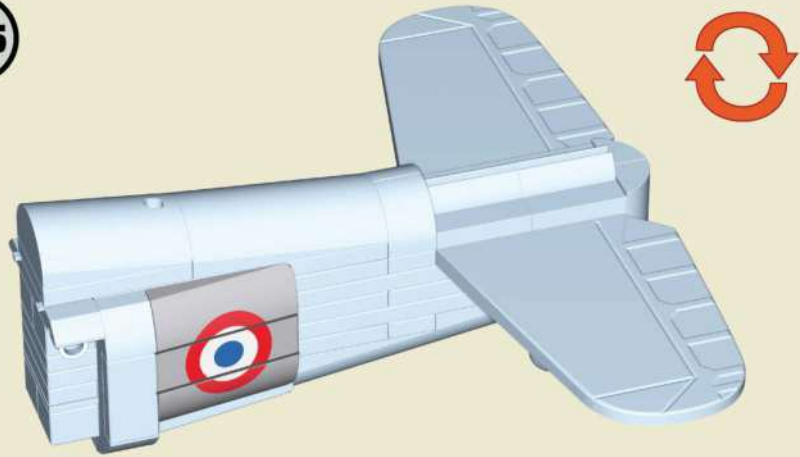

66

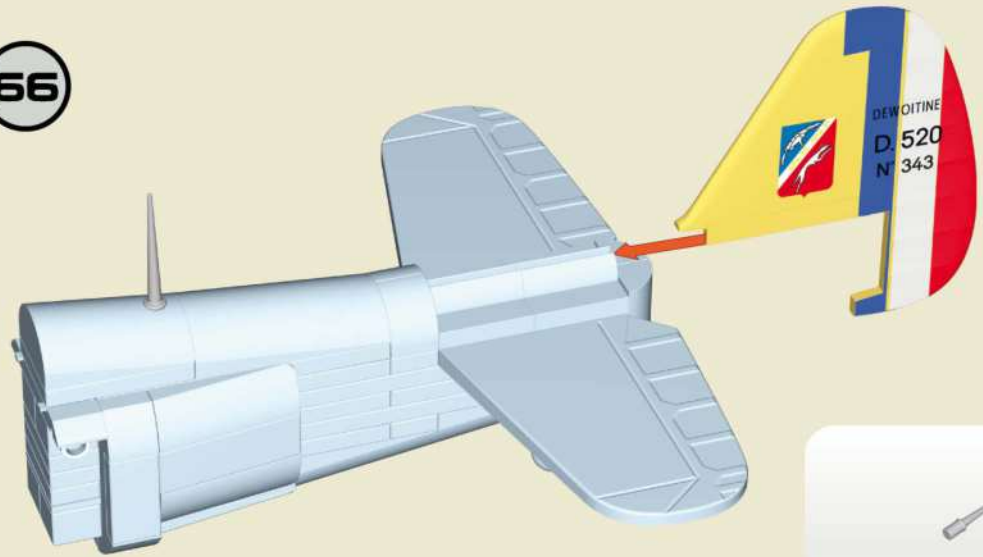

67

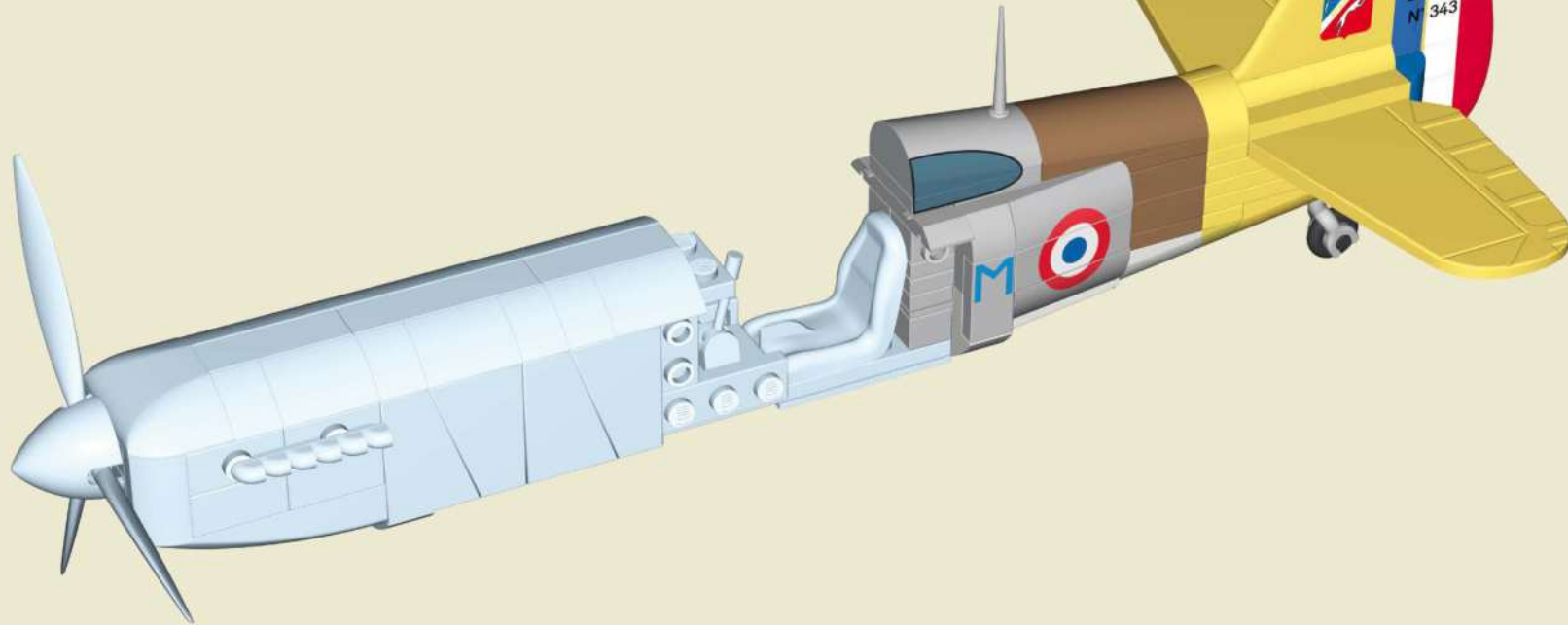

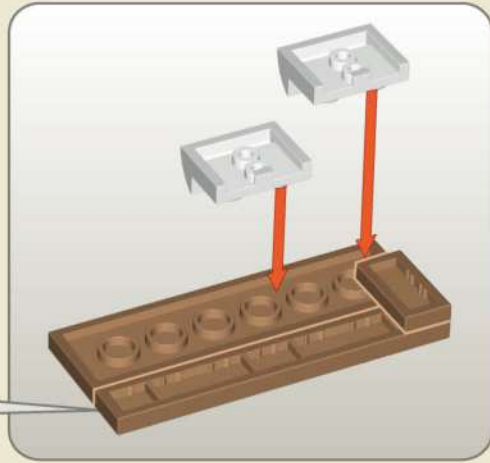

1:1

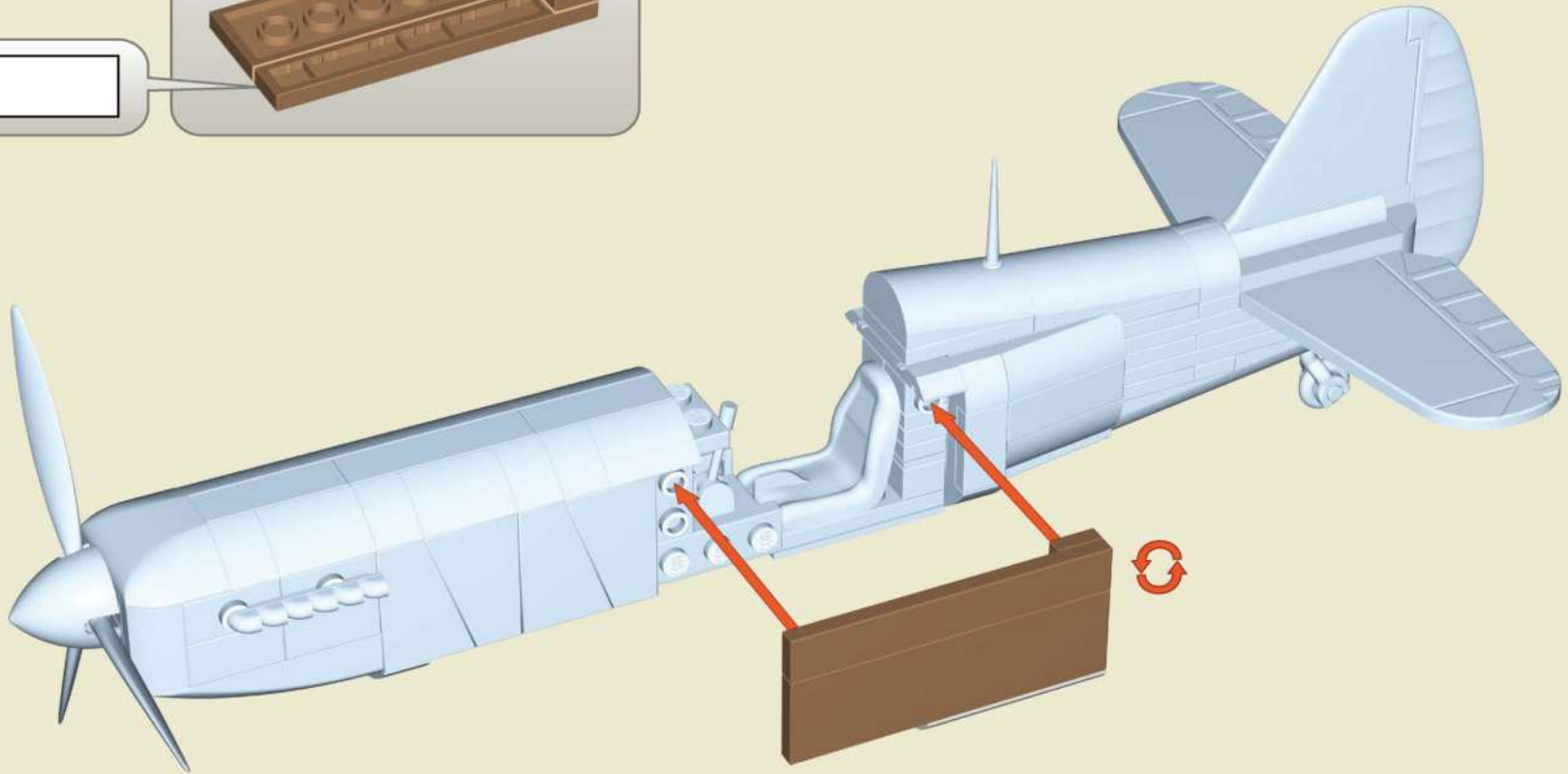

-  x1
-  x1
-  x1
-  x2

69

1:1

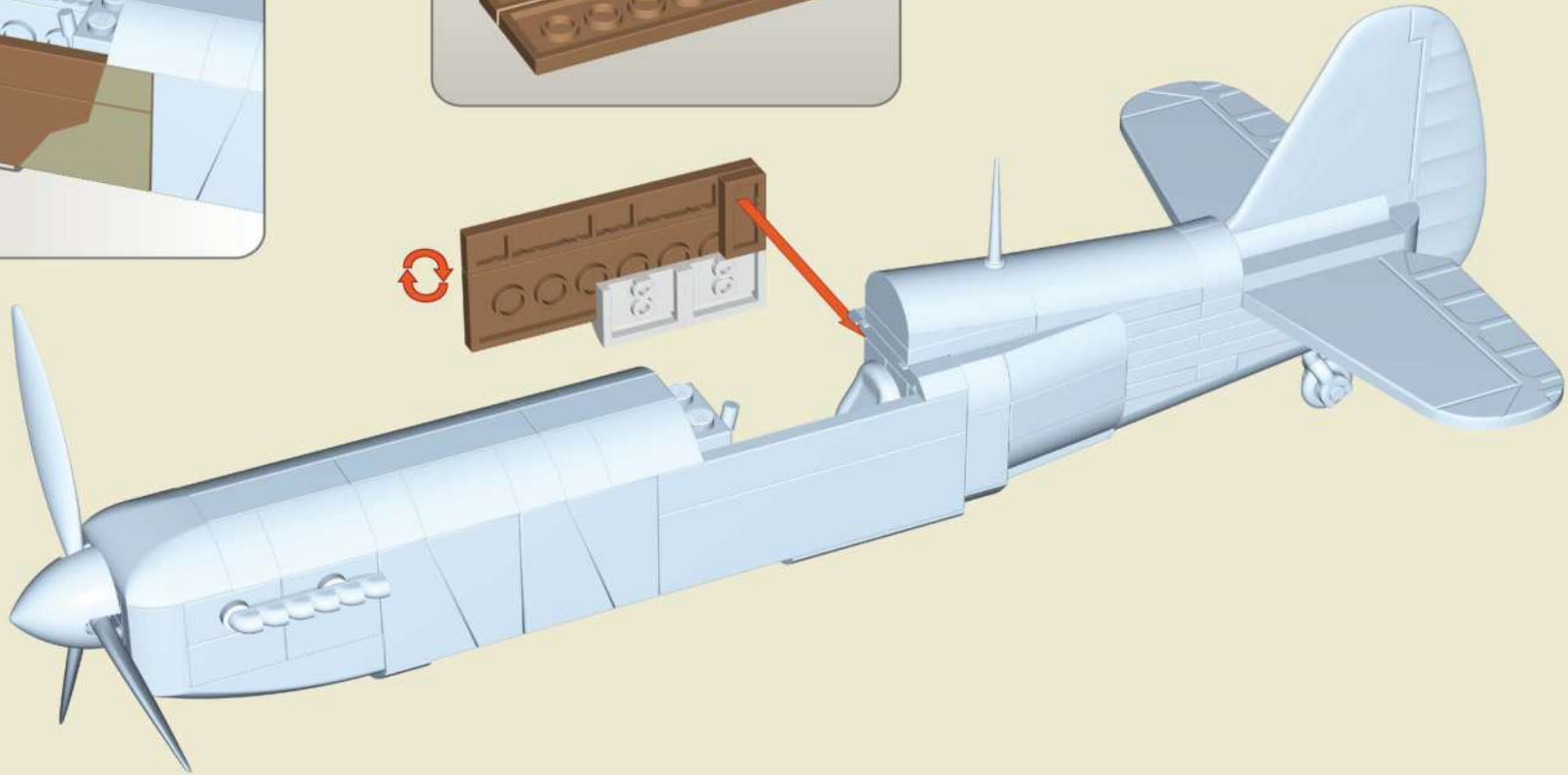
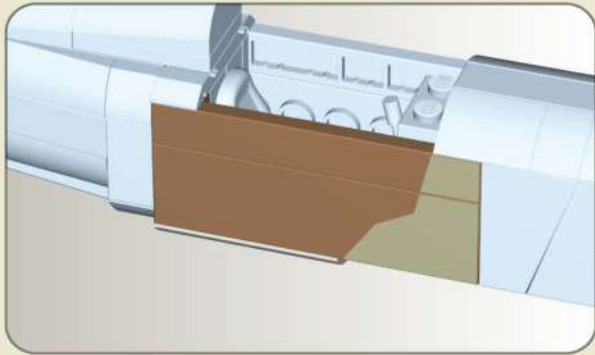
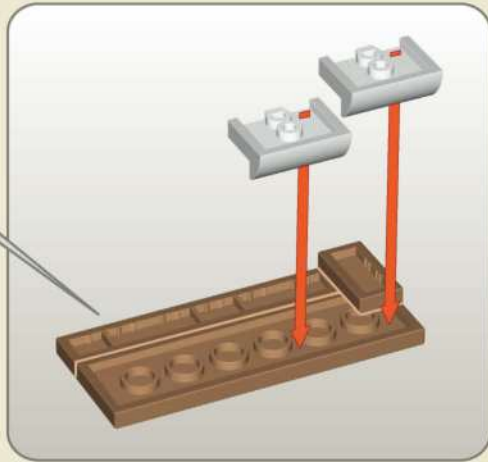

70

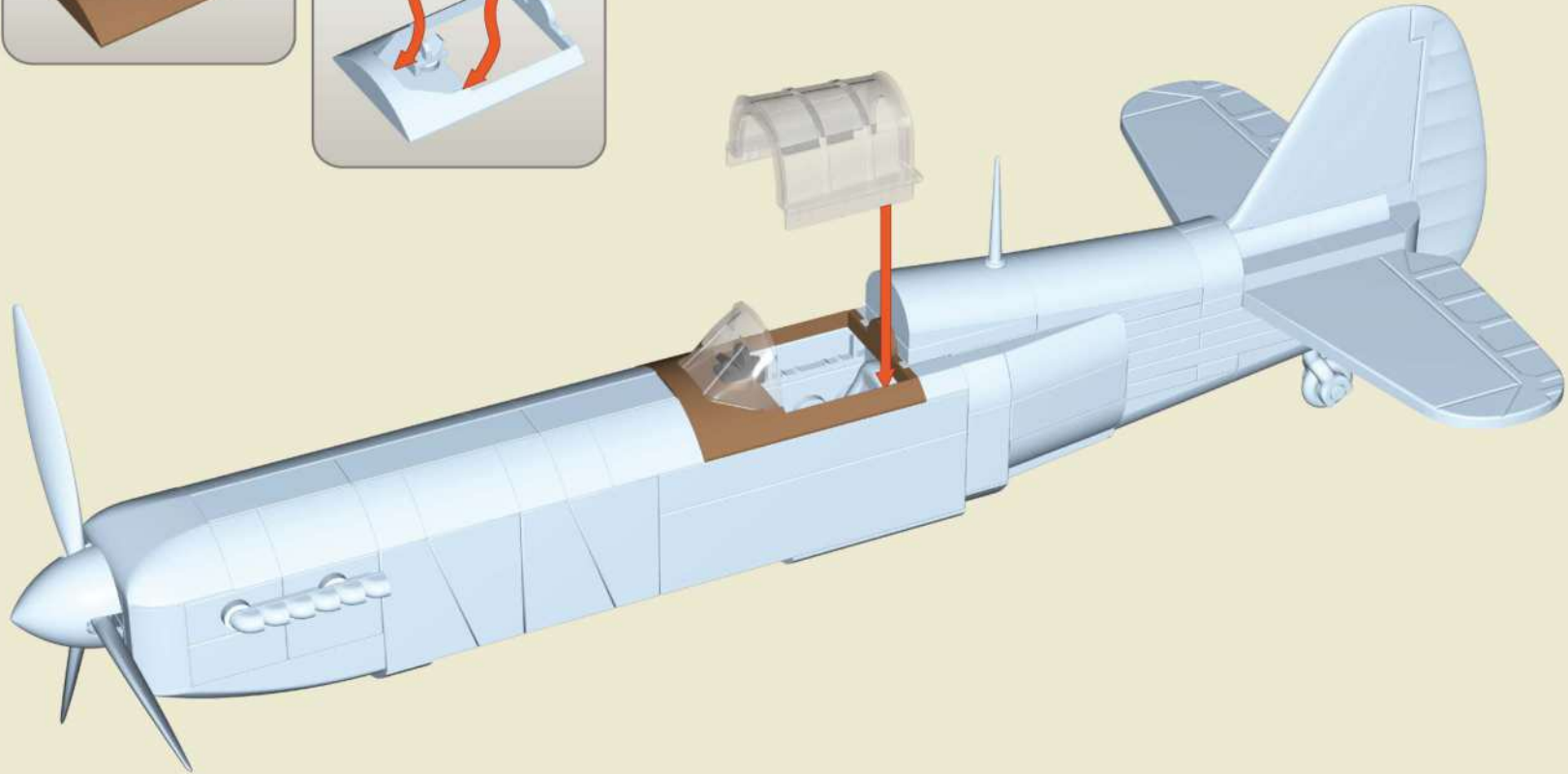

x1



x1



x1



x1

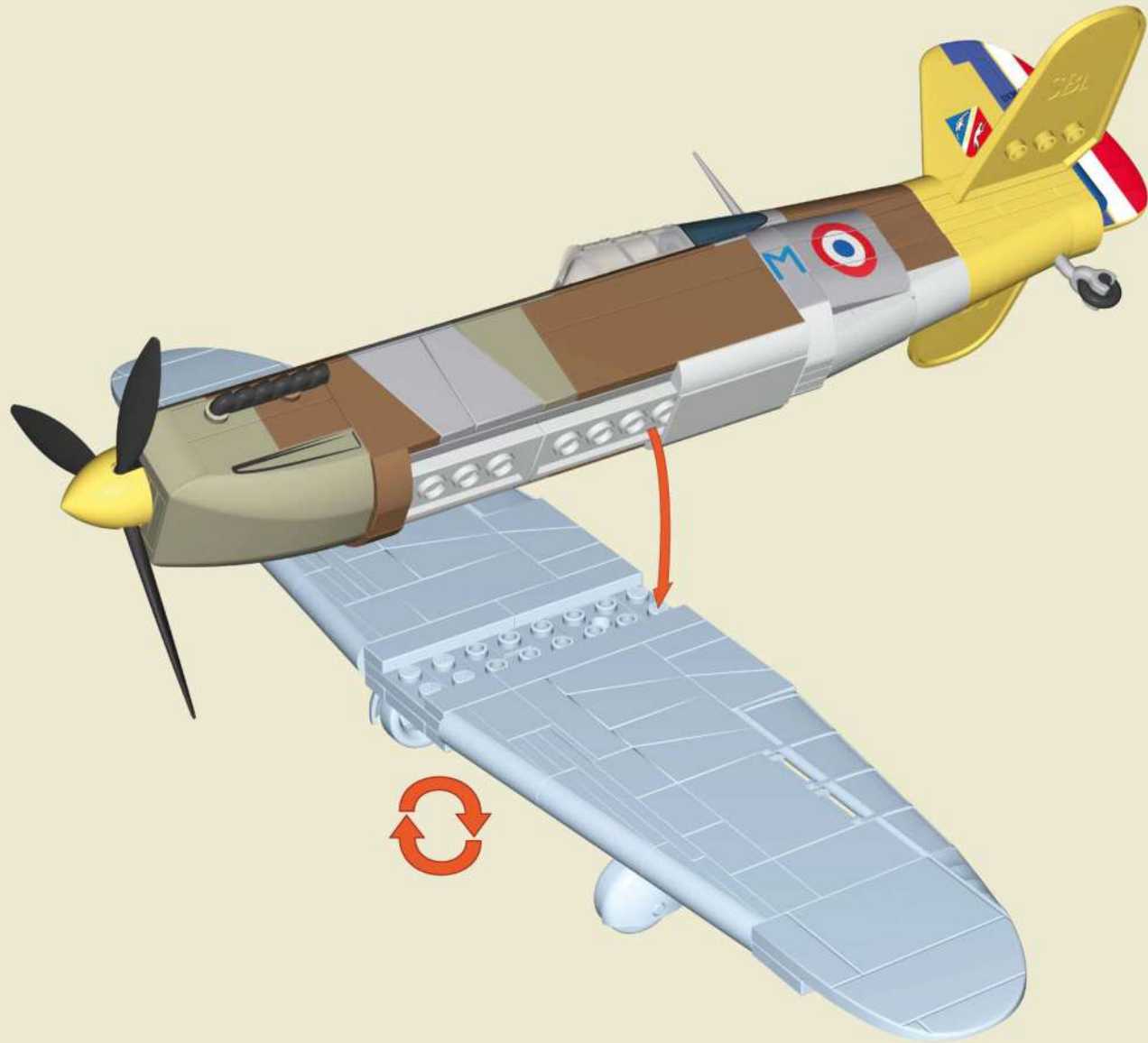

72

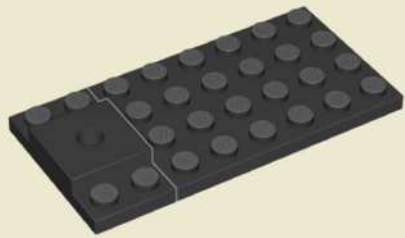

73

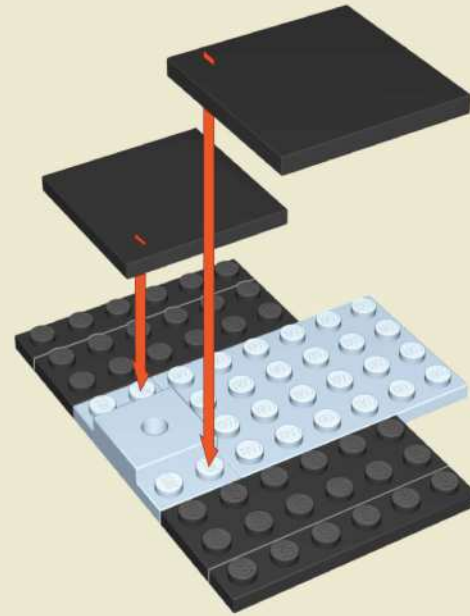

74

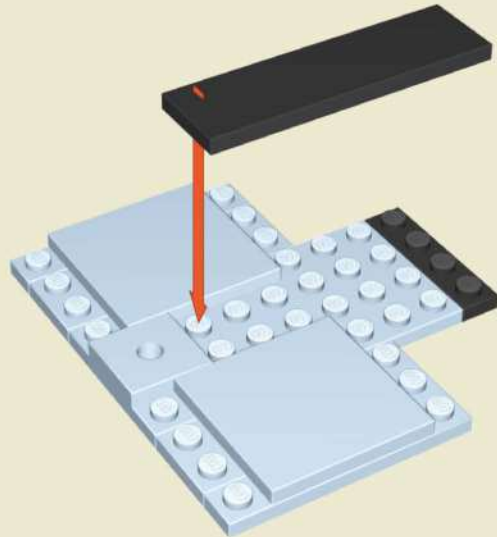

x1

x1

75

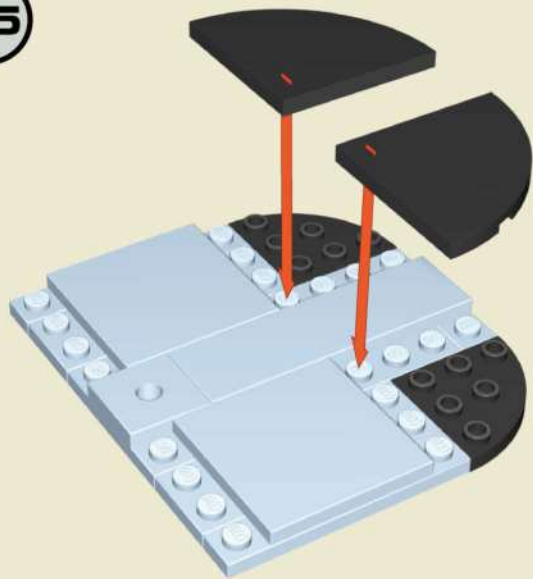

76

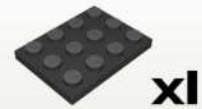
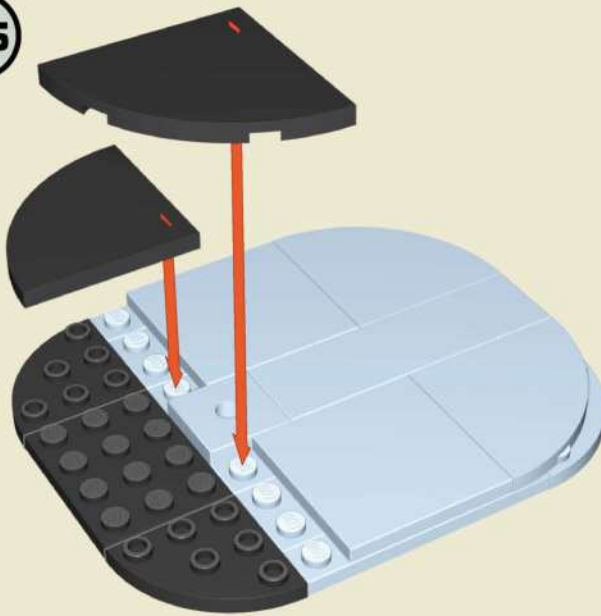

77

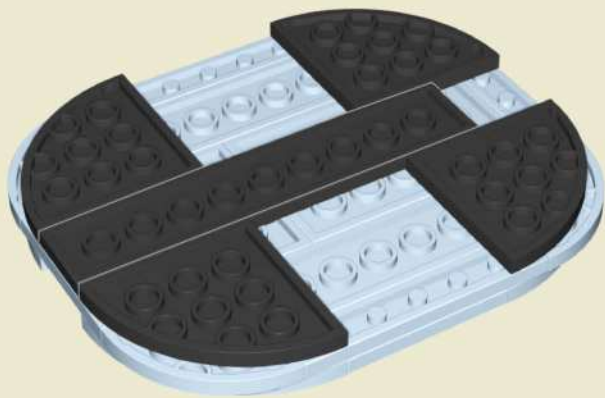

78



1:1

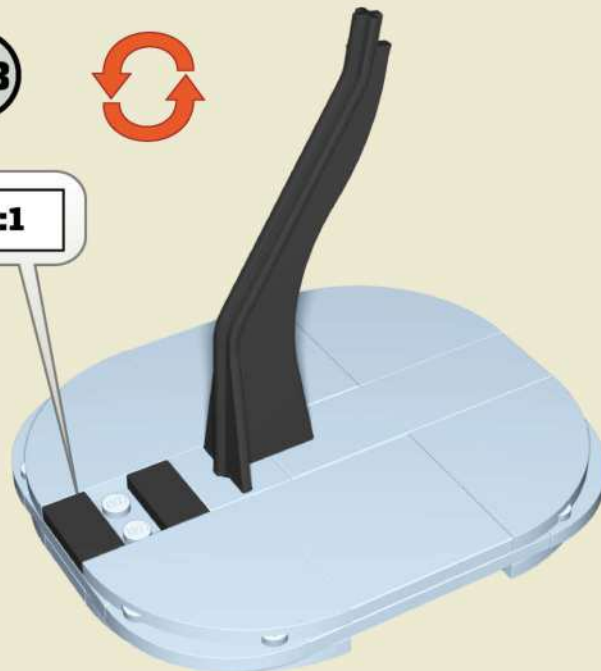

79

x2

x1

x1

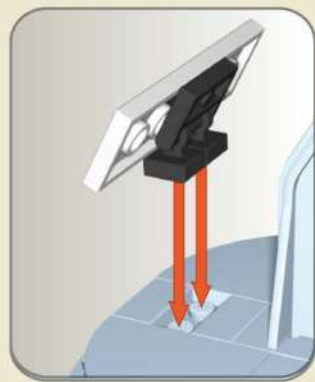
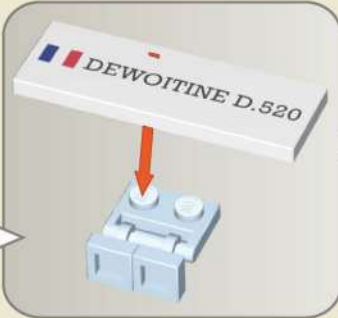
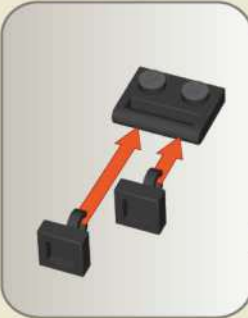
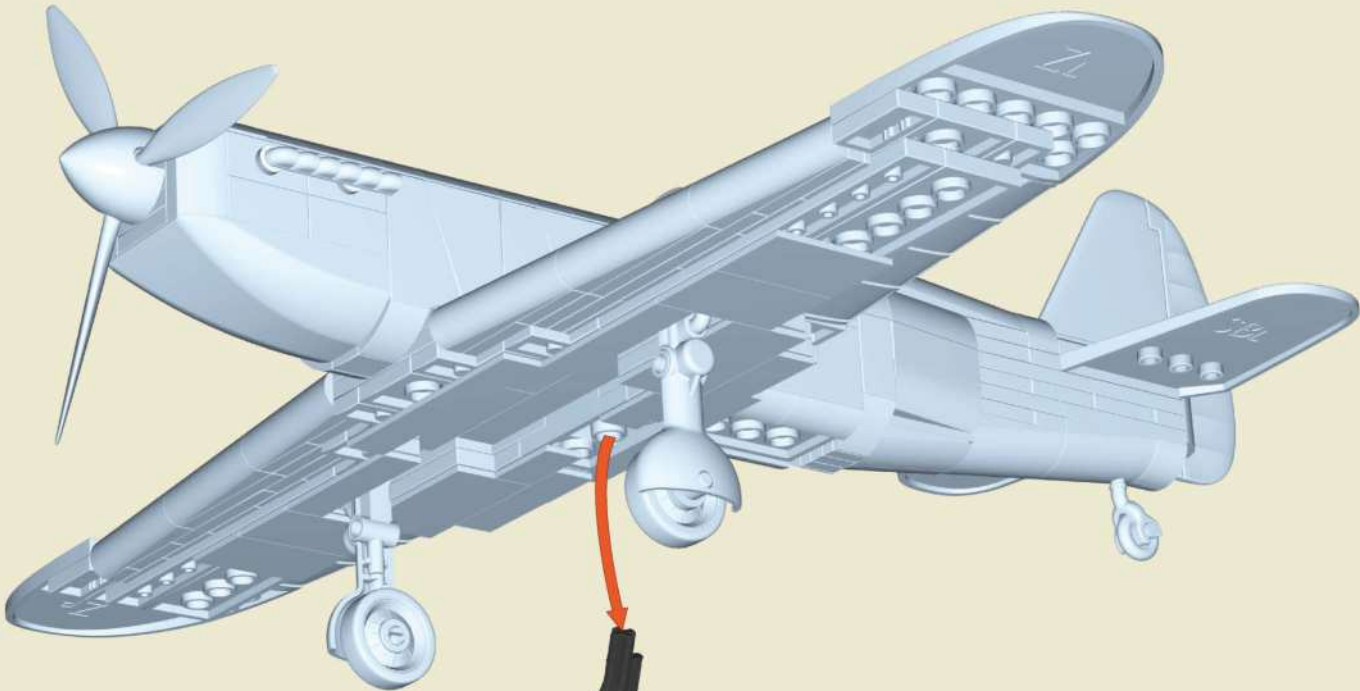

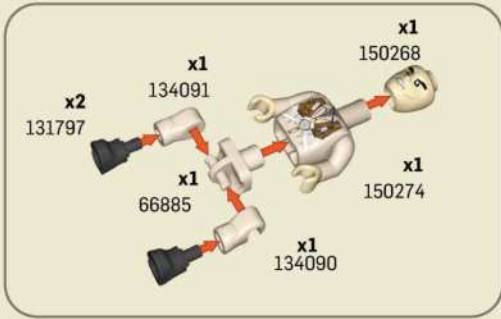

x4 115177	x4 92879	x1 129722	x1 114598	x1 42879	x2 44969	x6 97658	x4 112793	x2 76804			
x2 93563	x2 66722	x2 124565	x6 42928	x2 92647	x5 129744	x4 43671	x2 52999	x1 92649			
x1 43922	x4 92648	x2 138335	x5 142142	x1 150429	x1 142144	x3 45159	x2 45158	x3 129749			
x2 150504	x1 45448	x1 79704	x2 104836	x1 145001	x2 42949	x2 129753	x1 42893	x6 42903	x2 115766	x1 115185	x2 114622
x1 108368	x1 133043	x1 127200	x2 42955	x2 92652	x1 129763	x1 43674	x3 95647	x1 129765	x4 99112	x2 150505	x2 150505
x2 150505	x1 120905	x1 120906	x3 42973	x1 42974	x1 129771	x1 105840	x1 62197	x1 129775	x2 60522	x3 122045	x1 142145
x1 126334	x2 74518	x1 150506	x1 150507	x1 147427	x1 139595	x2 145292	x6 134795	x2 43015	x2 92654	x1 83573	x4 134794
x1 150508	x1 107611	x1 150509	x1 92656	x2 43680	x2 43082	x1 92658	x2 43685	x1 43089	x2 43090	x1 44140	x2 66626
x2 44684	x2 109016	x8 92884	x2 129796	x2 45578	x1 136055	x1 44915	x1 94078	x1 131754	x3 124624	x3 43151	x2 129800
x1 129716	x2 86068	x1 150510	x1 150511	x1 150631	x4 120917	x1 43166	x3 92898	x2 44690	x1 129805	x1 93451	x1 136059





HISTORICAL COLLECTION



MIG-17 NATO "FRESCO"
★ 5823



MITSUBISHI A6M2 "ZERO-SEN"
🇯🇵 5729



meMESSERSCHMITT BF 109 E-3
✚ 5727



LIM-5 (MIG-17F) EAST GERMAN AIR FORCE
🇩🇪 5825



HISTORICAL COLLECTION



STURMPANZERWAGEN A7V

2989



RENAULT FT

2991



VICKERS A1E1 INDEPENDENT

2990



MARK V (Male)

2984



RENAULT FT „VICTORY TANK 1920“

2992



ROLLS ROYCE ARMoured CAR

2988





HISTORICAL COLLECTION



M4A3 SHERMAN
★ 2570



CHURCHILL MK. IV
SCALE 1:48
🇬🇧 2717



Sd.Kfz. 10 DEMAG D7
+ 2273



Sd.Kfz. 7 HALF-TRACK
+ 2275



PANZER II AUSF. A
SCALE 1:48
+ 2718



PANZER III AUSF. J
+ 2562



PzKpfw V PANTHER „PUDEL”
🇵🇱 2568



HISTORICAL COLLECTION



NORTHROP GRUMMAN

F4F Wildcat® is a registered trademark of Northrop Grumman Systems Corporation and is used under license by "Cobi".

F4F WILDCAT®
★ 5731



HAWKER HURRICANE MK. I

🇬🇧 5728



JUNKERS JU-88

✚ 5733



JUNKERS JU 87 B STUKA

✚ 5730



For news and special deals

WWW.COBI.EU

00-05734-324

Find us on:



cobi.bricks
cobi.klocki

COBI SA