

HISTORICAL COLLECTION

WORLD WAR II

LOCKHEED MARTIN

LOCKHEED MARTIN®, P-38 Lightning®, associated emblems and logos, and body designs of vehicles are either registered trademarks or trademarks of Lockheed Martin Corporation in the USA and/or other jurisdictions, used under license by COBI.



LOCKHEED® P-38 LIGHTNING® (H)

IN SERVICE - 1941 - 1965
 PLACE OF ORIGIN - UNITED STATES
 ROLE - FIGHTER
 WINGSPAN - 15,85 m (52' 0")
 LENGTH - 11,53 m (37' 10")
 HEIGHT - 3,91 m (12' 10")
 GROSS WEIGHT - 7938kg (17,500Lb)
 ENGINE - 2x V-12, ALLISON V-1710-89/91,
 1405HP (1048kW)
 RANGE - 2000KM (1,243Mi)
 RATE OF CLIMB - 24,1M/S (4,724FT/MIN)
 MAXIMUM FLIGHT LEVEL - 13400m (43,963FT)
 ARMAMENT - 4x 12,7MM (.50") MACHINE GUN,
 1x 20MM (.787") GUN HISPANO M-2C ,
 2x 736kg (1622Lb) BOMBS
 SPEED - 665KM/H (413.2MPH)
 CREW - 1

5726

PAD PRINTED
NO STICKERS



Printed in EU



WARNING: CHOKING HAZARD-
Toy contains small parts.
Not for children under 3 years.

545 1  

LOCKHEED® P-38 LIGHTNING® (H)

SCALE 1:32



1

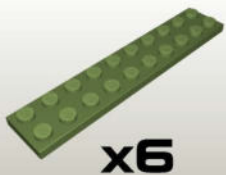
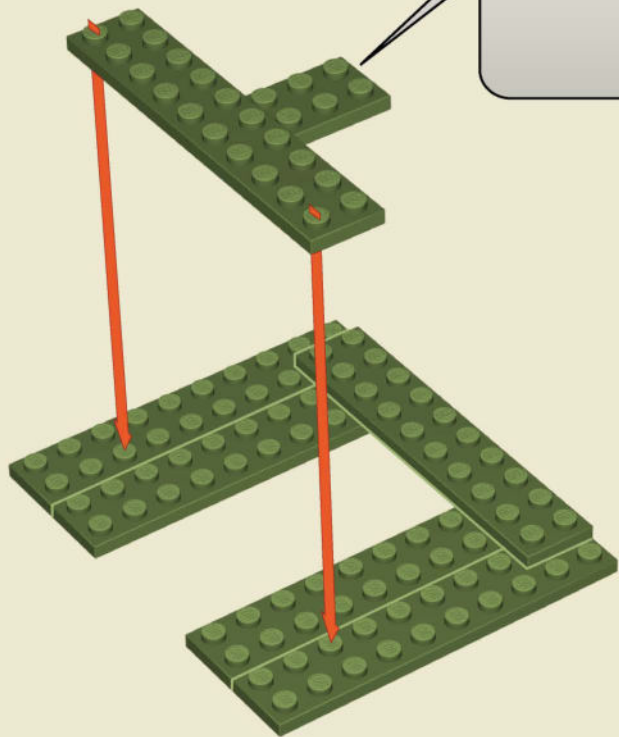

2

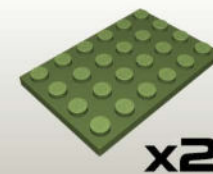
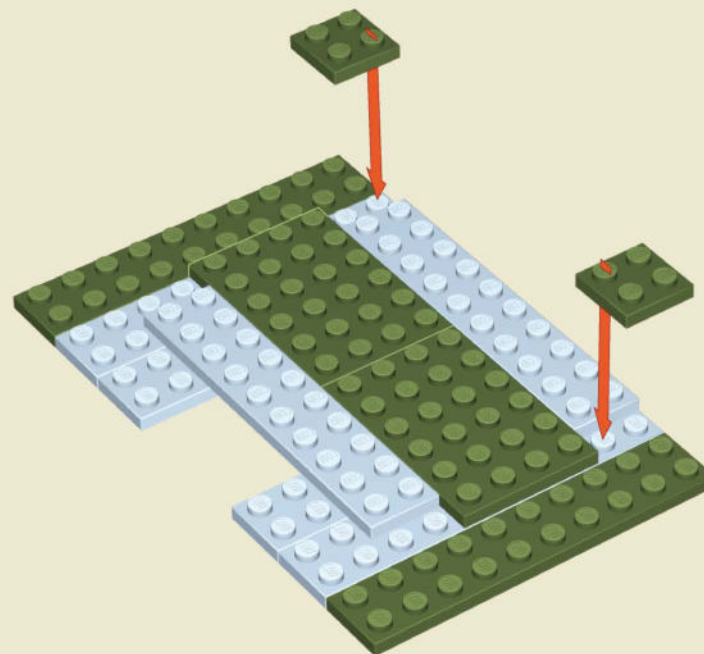

5

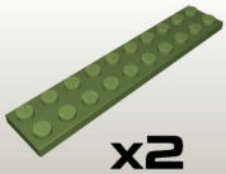
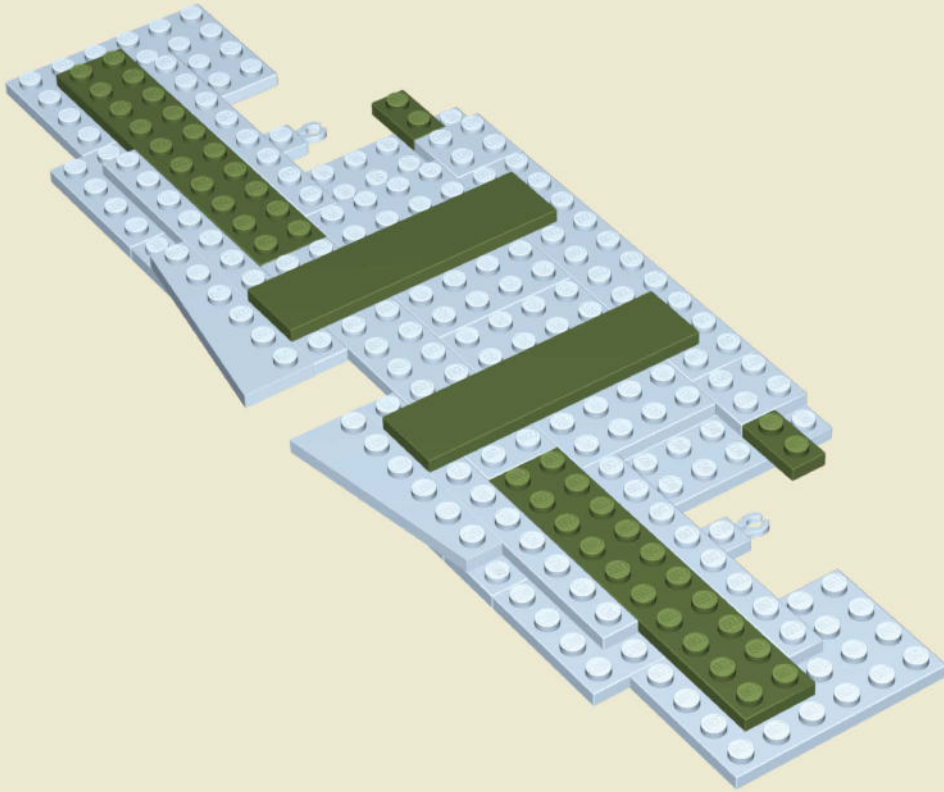

6

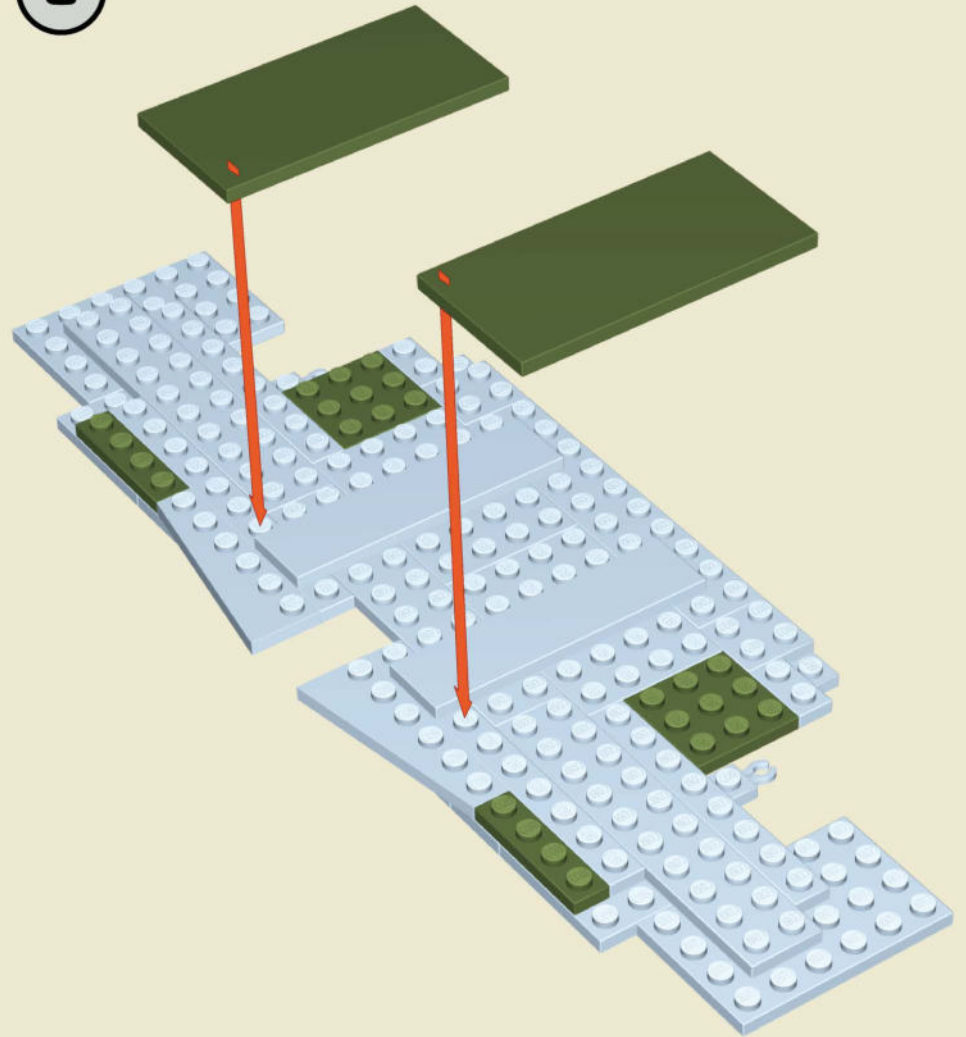

9

10

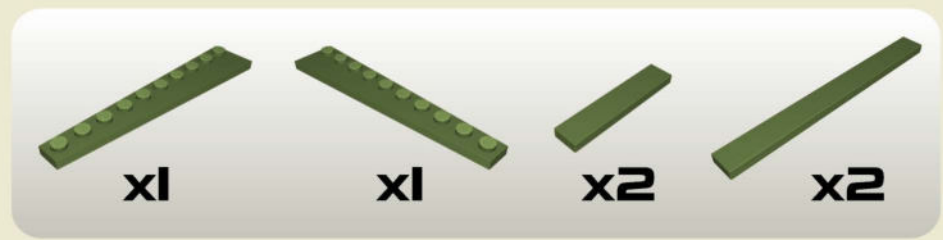
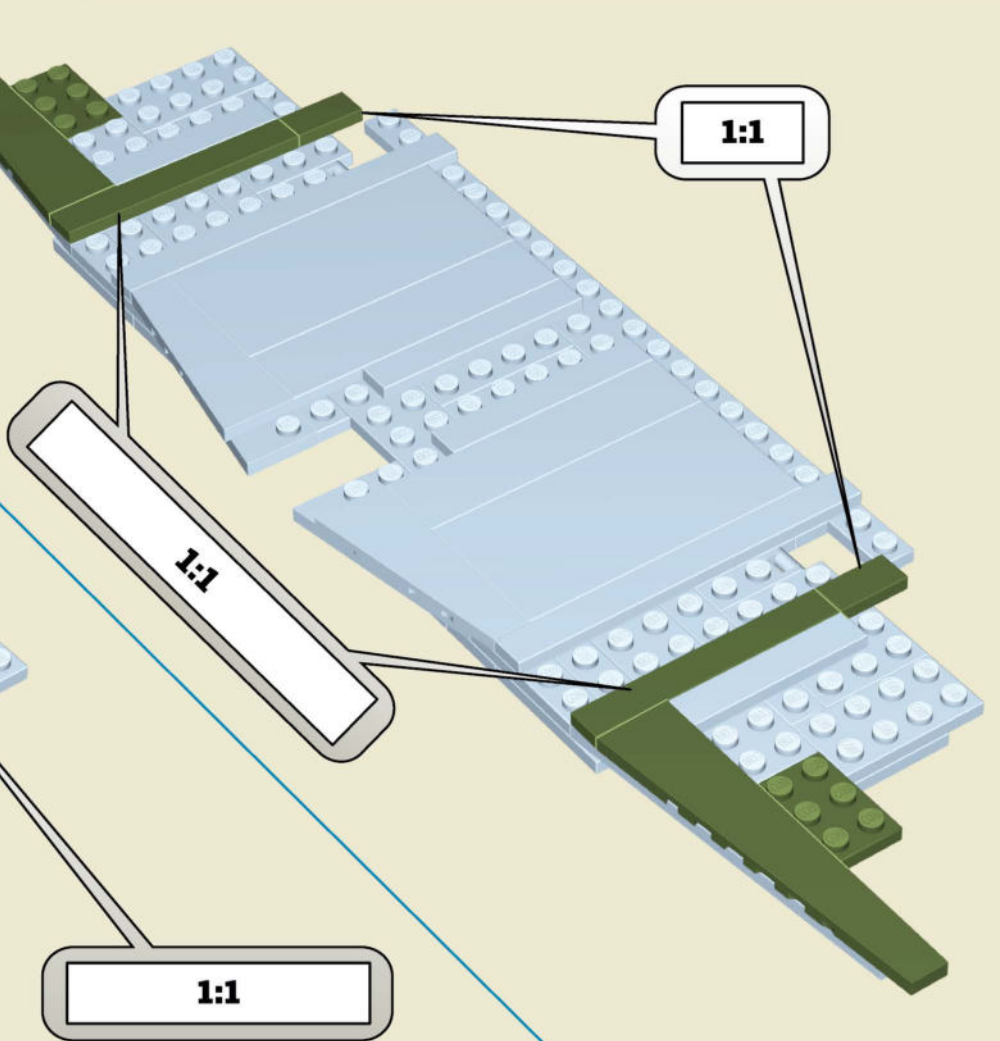
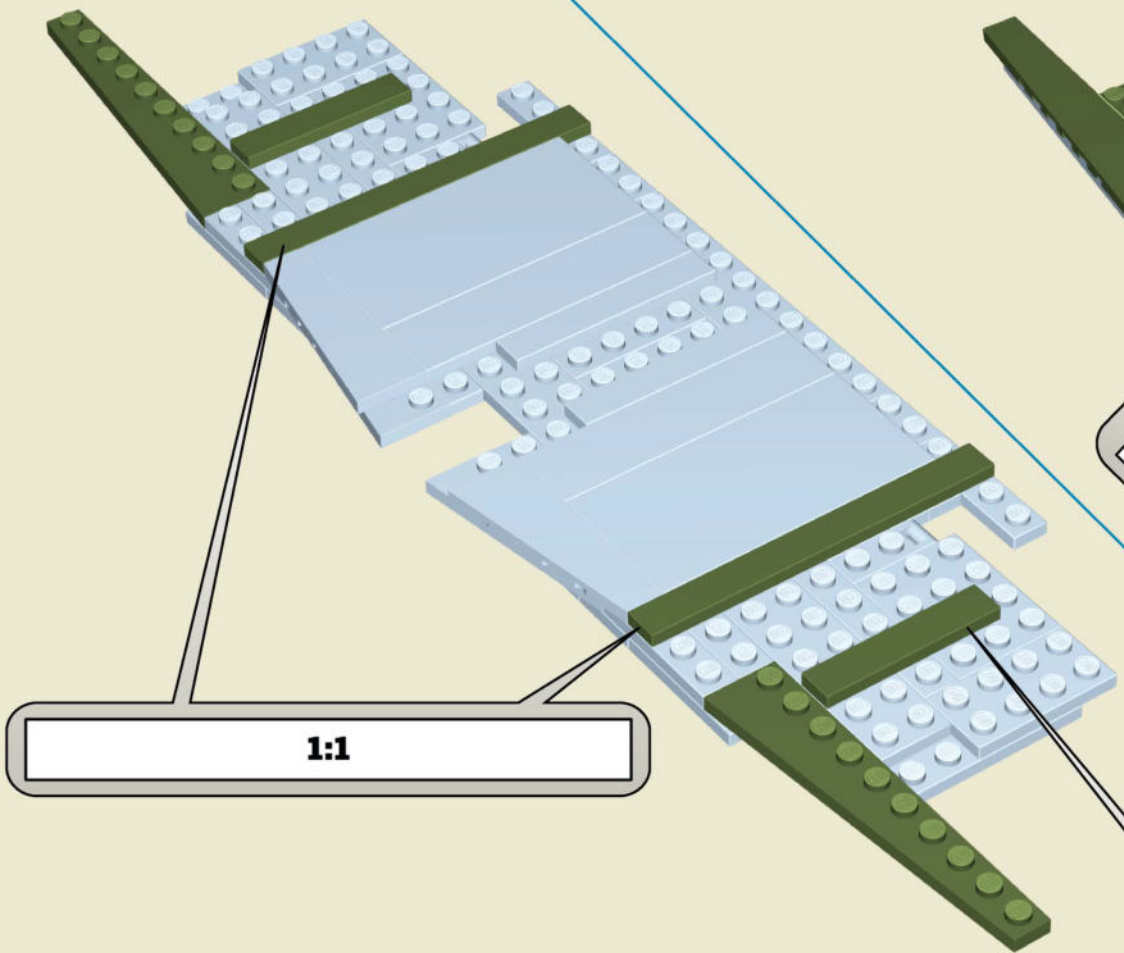

11



12



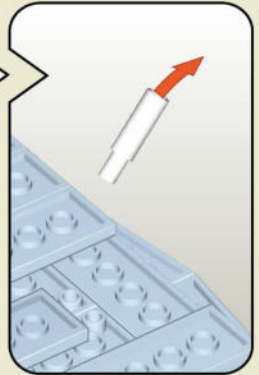
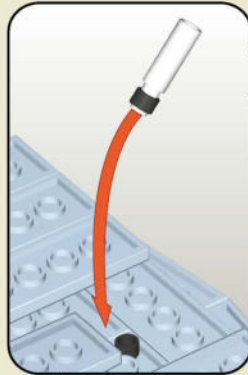

 **x2**
 **x8**

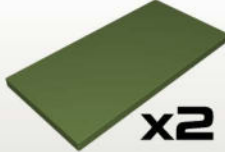

1:1

 **x2**
 **x2**

 **x2**
 **x2**

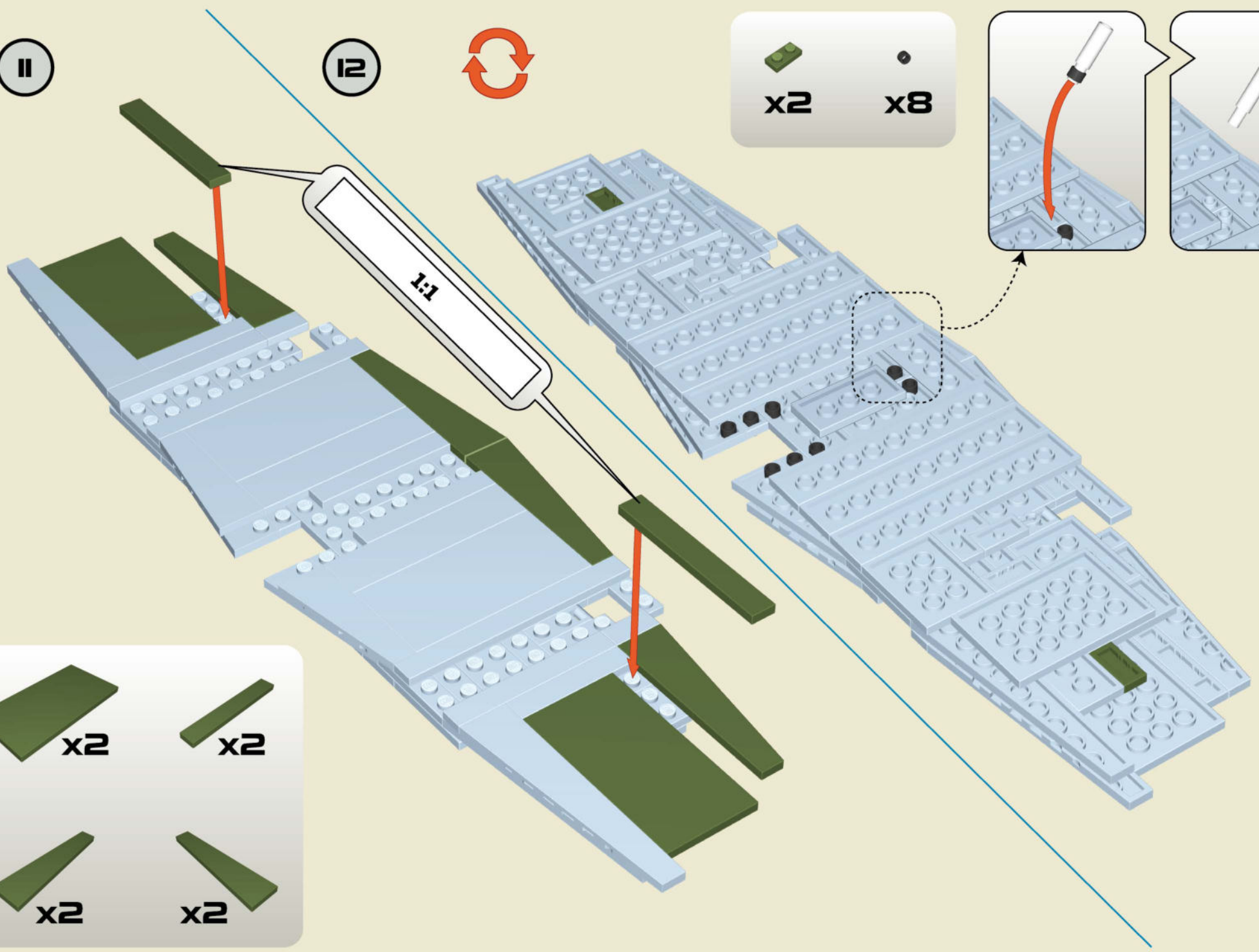

13

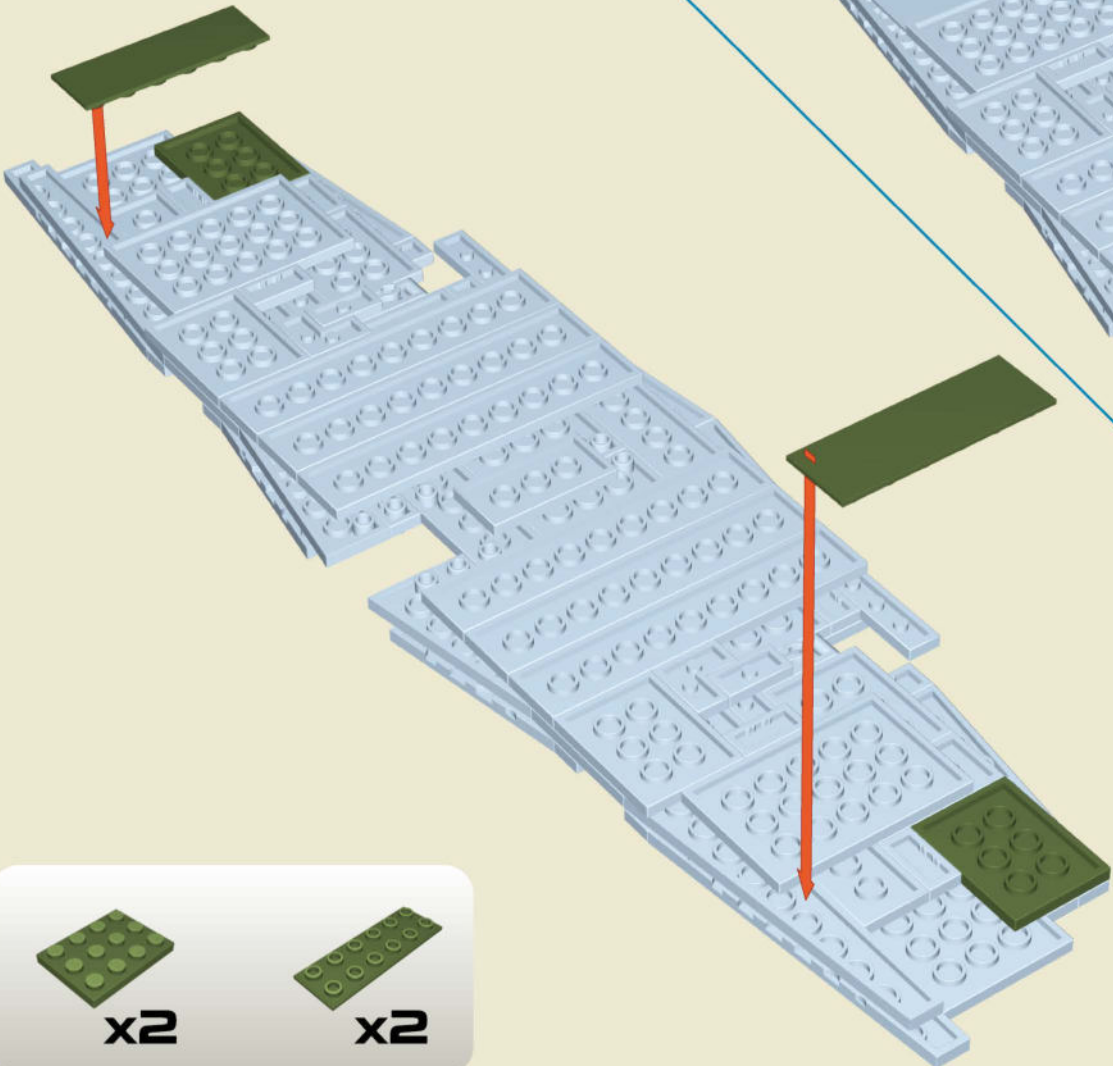

14

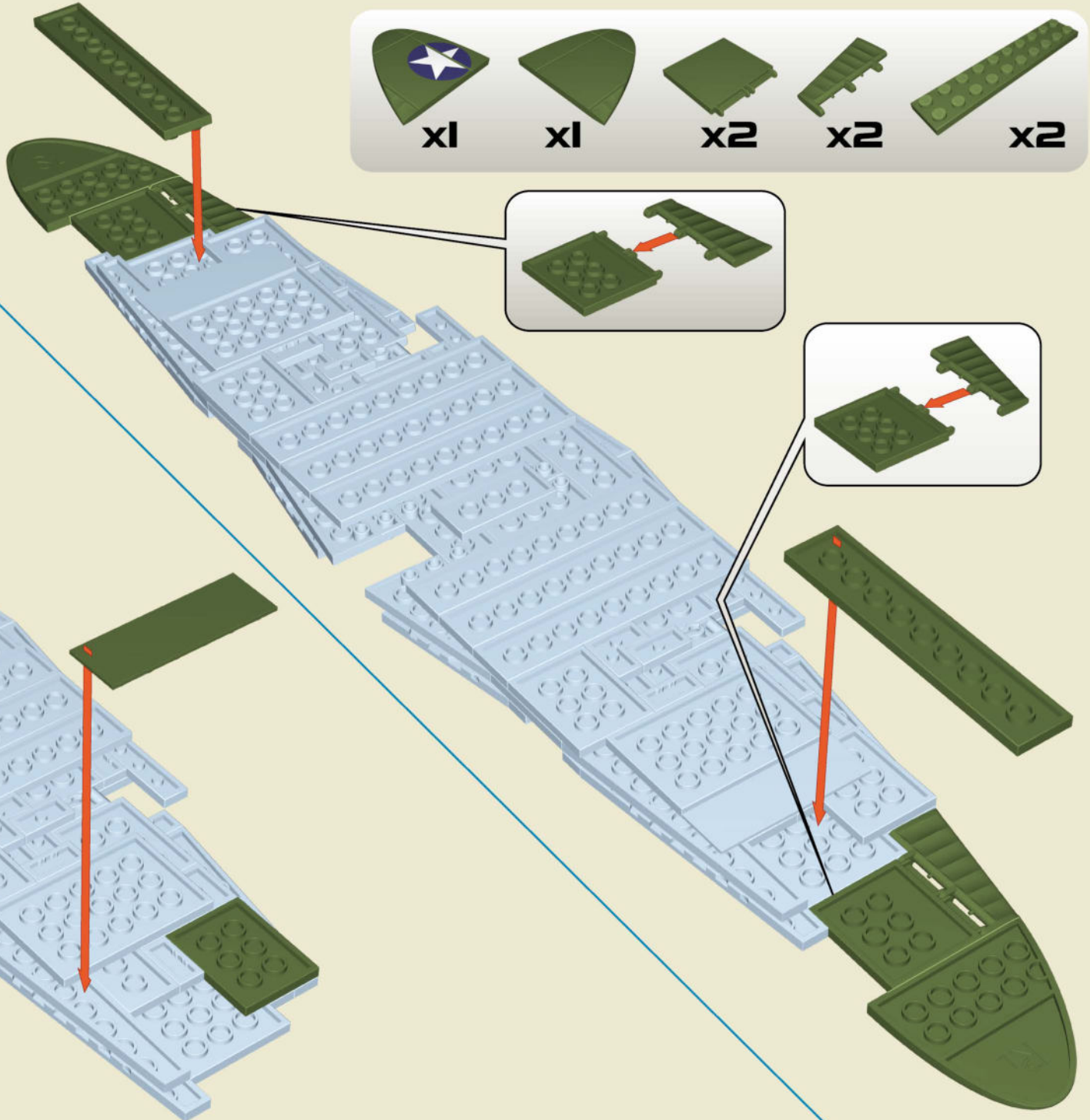

 **x1**
 **x1**
 **x2**
 **x2**
 **x2**

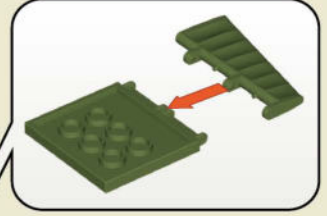
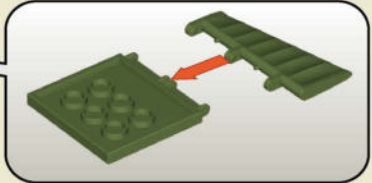





 **x2**
 **x2**

17

18

1:1



-  x14
-  x2
-  x1
-  x1

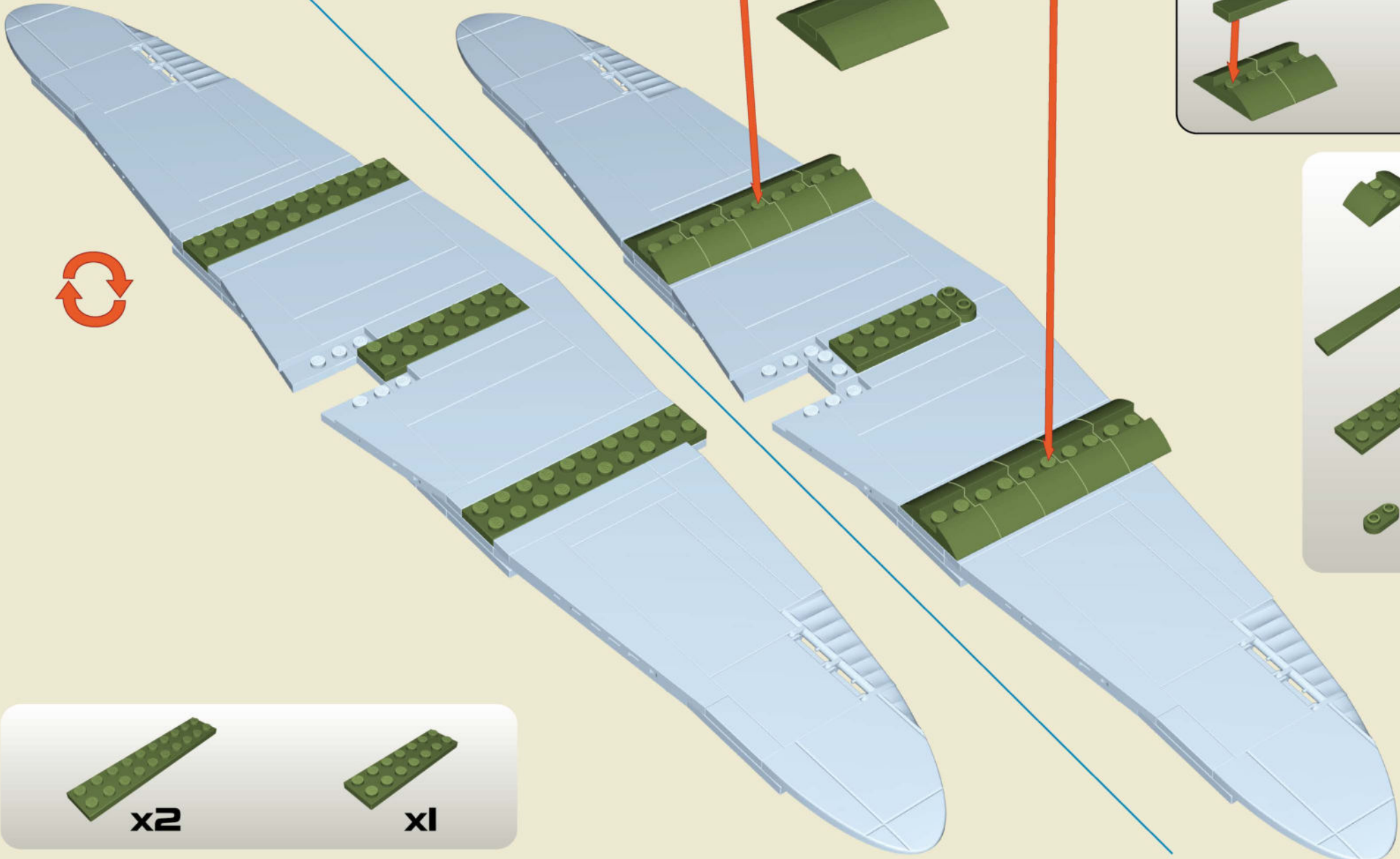

-  x2
-  x1

19

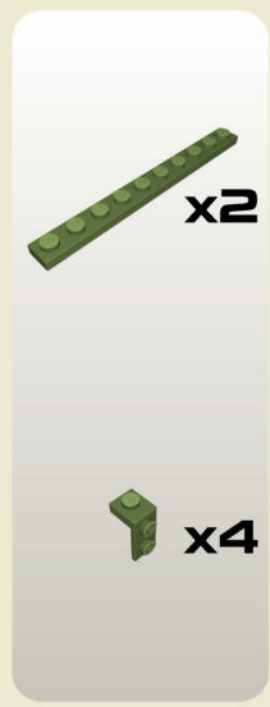
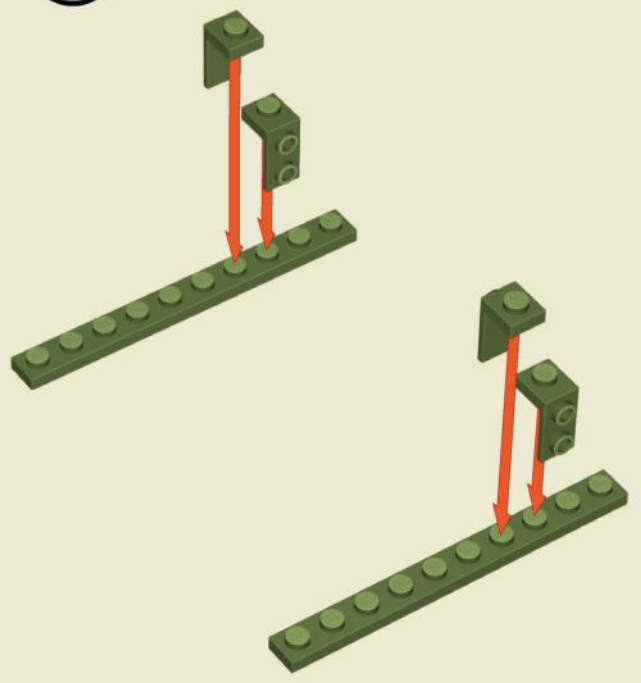

20

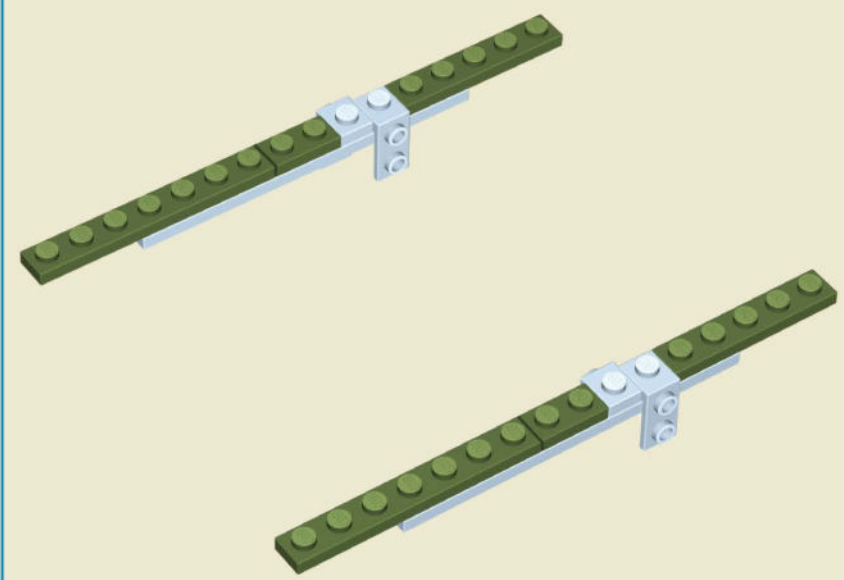

21

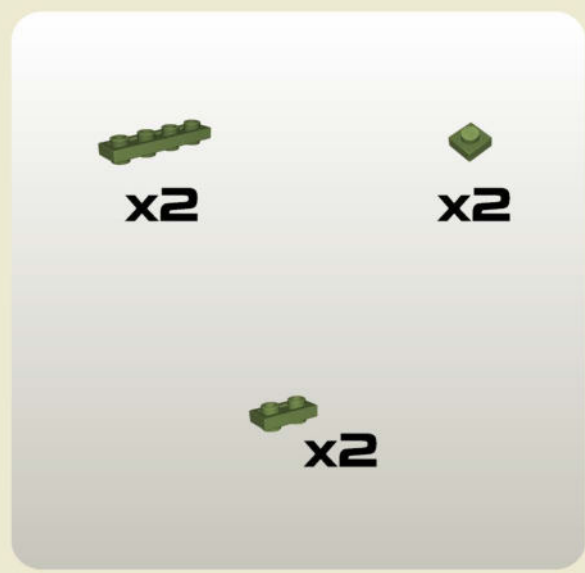
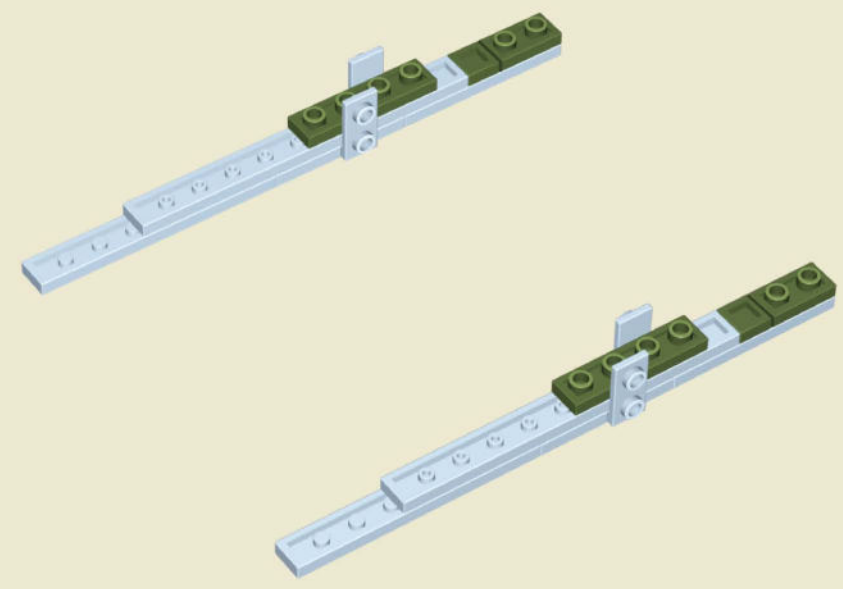

22

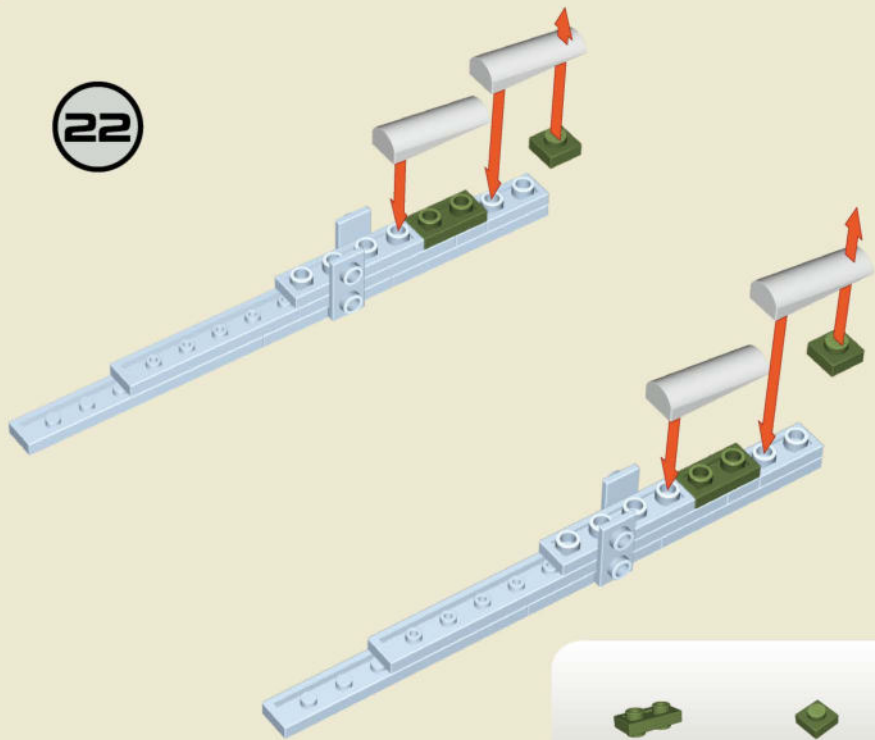

23

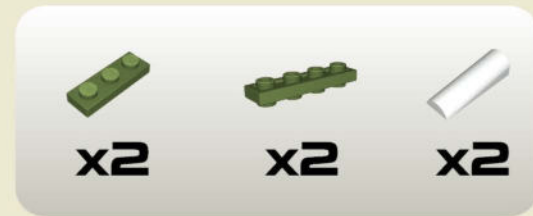
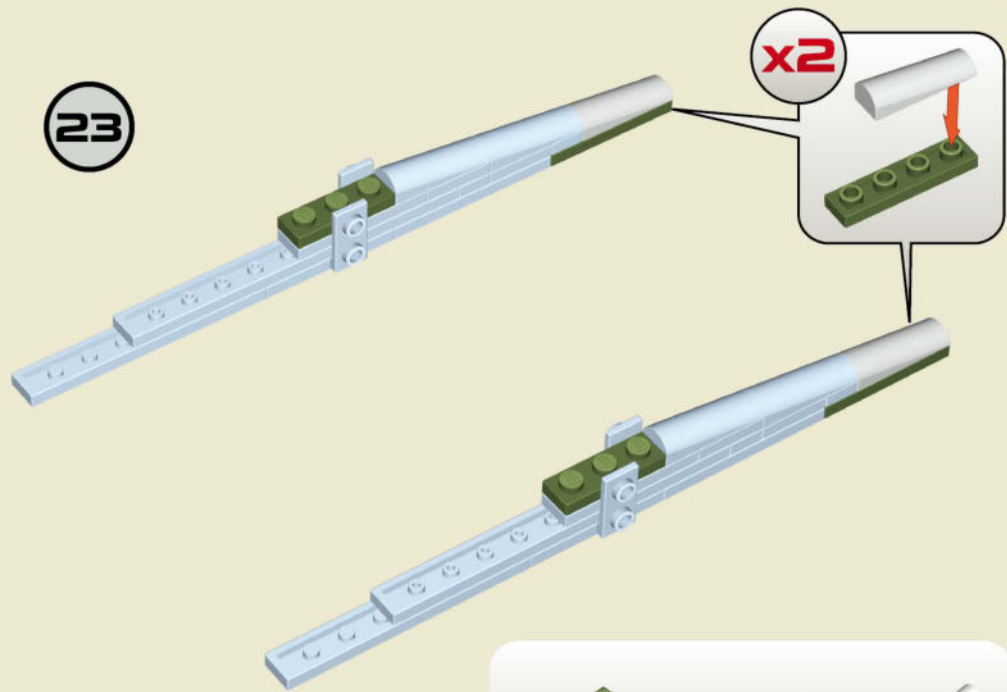

24

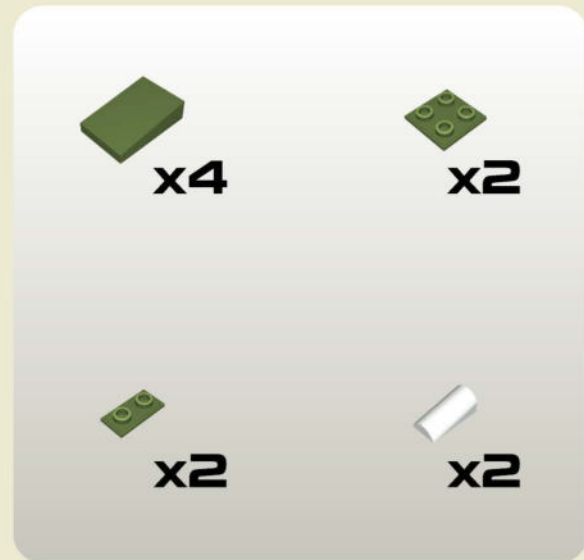
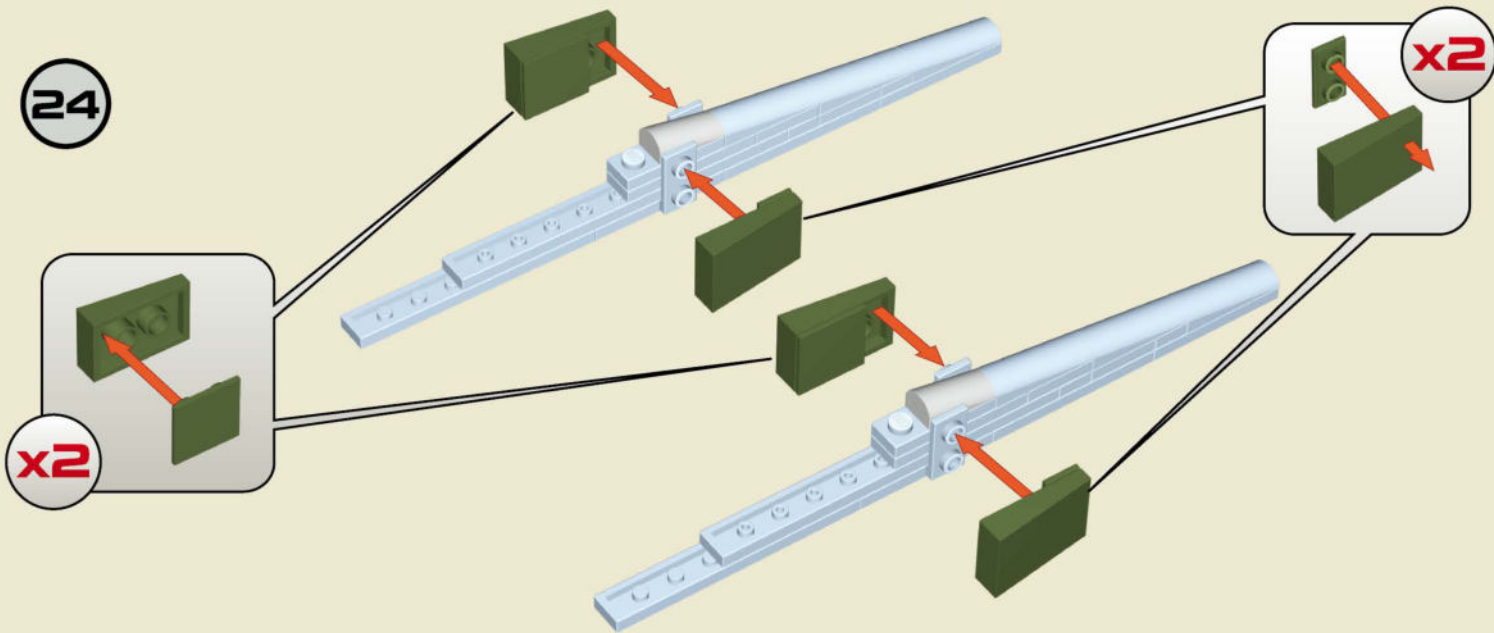

25

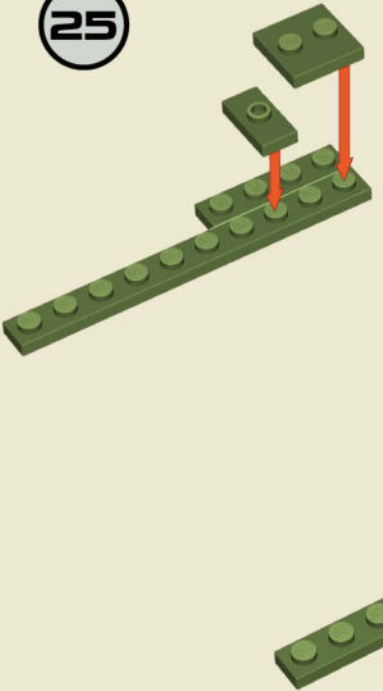

-  x2
-  x2
-  x2
-  x2

26

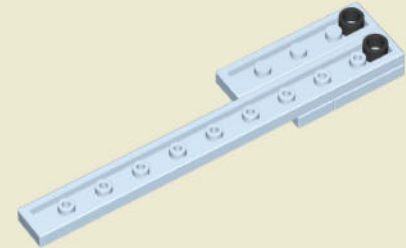
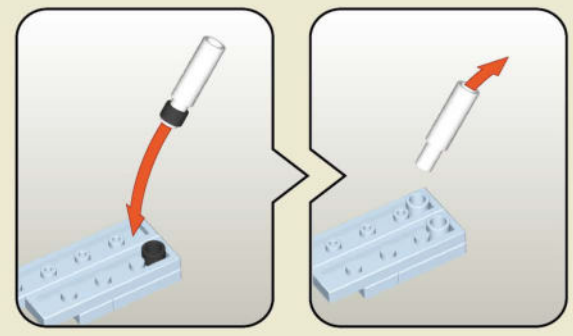
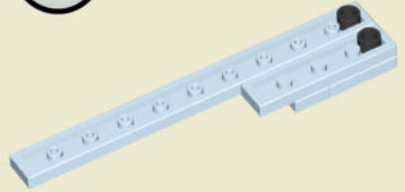

-  x4

27

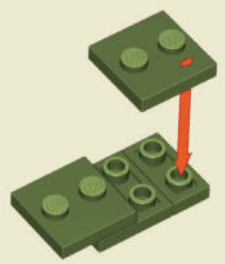
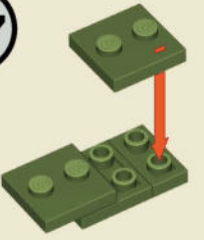

-  x4
-  x2
-  x2

28

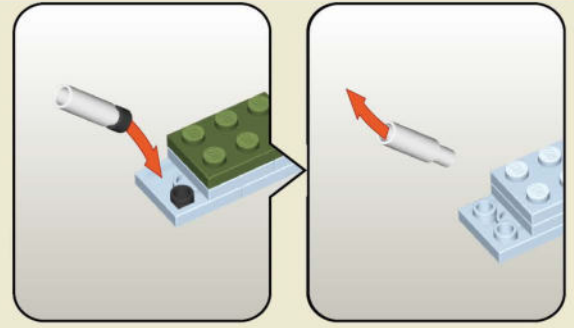

-  x4
-  x2

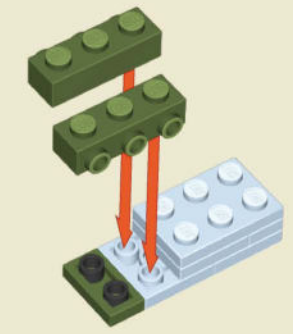
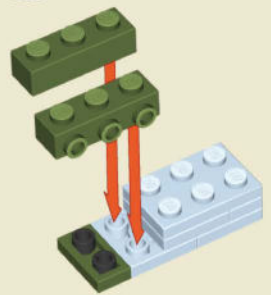

29



-  x2
-  x4
-  x4

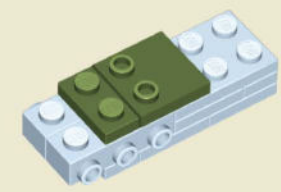
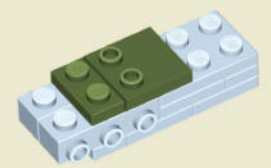

30

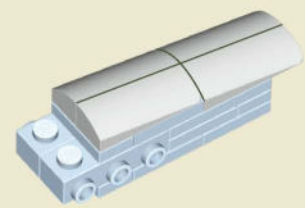

-  x2
-  x2

31



-  x4
-  x4

32

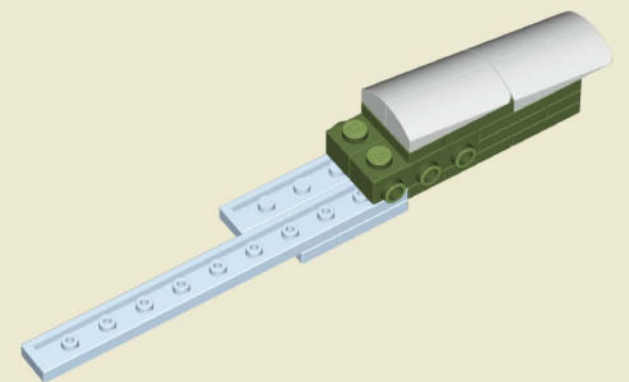
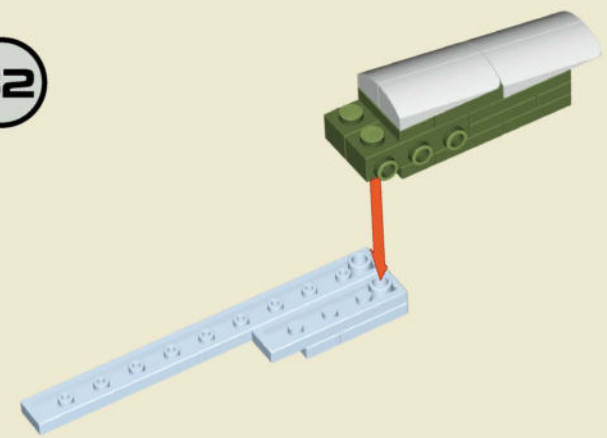

33

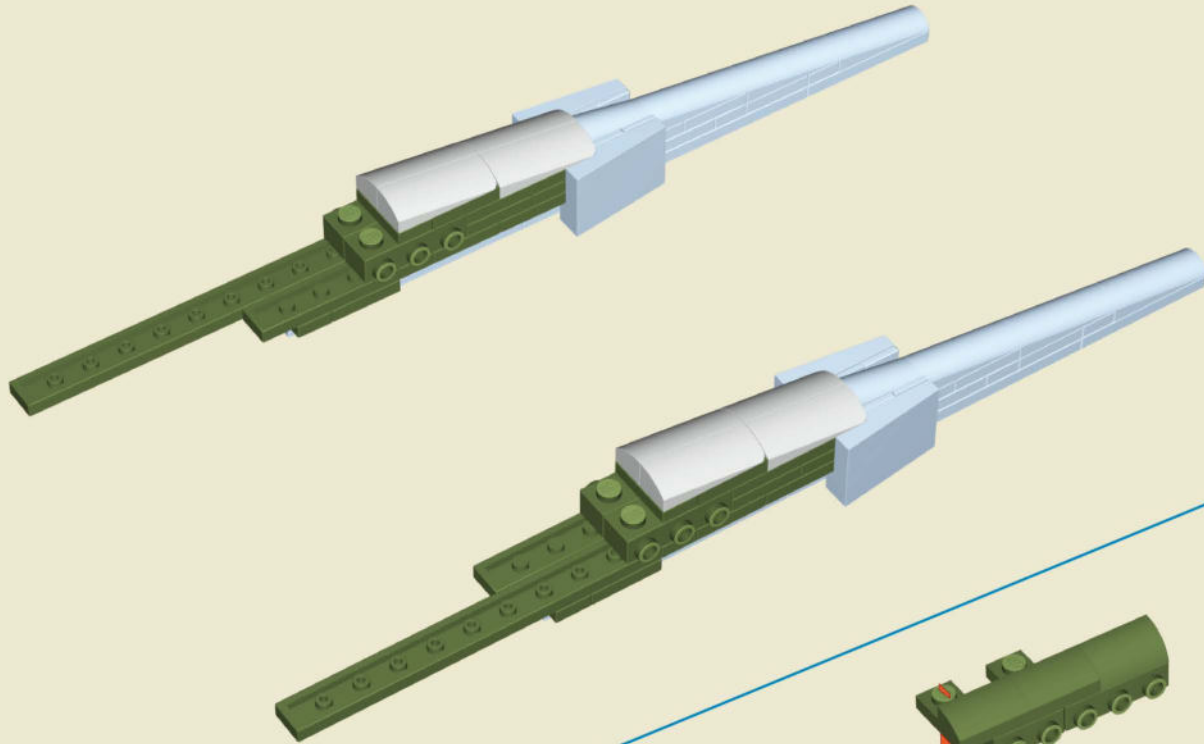

34

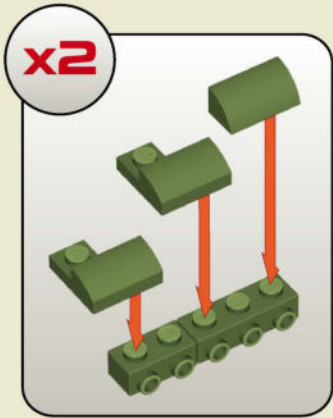
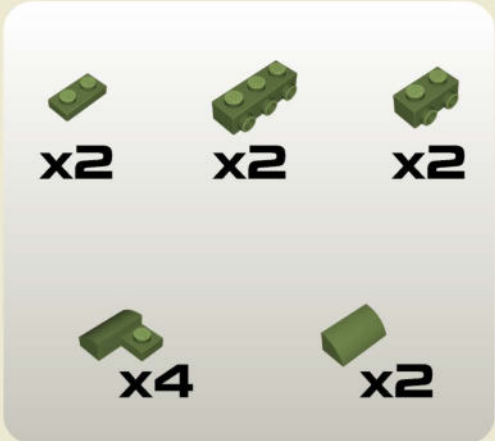
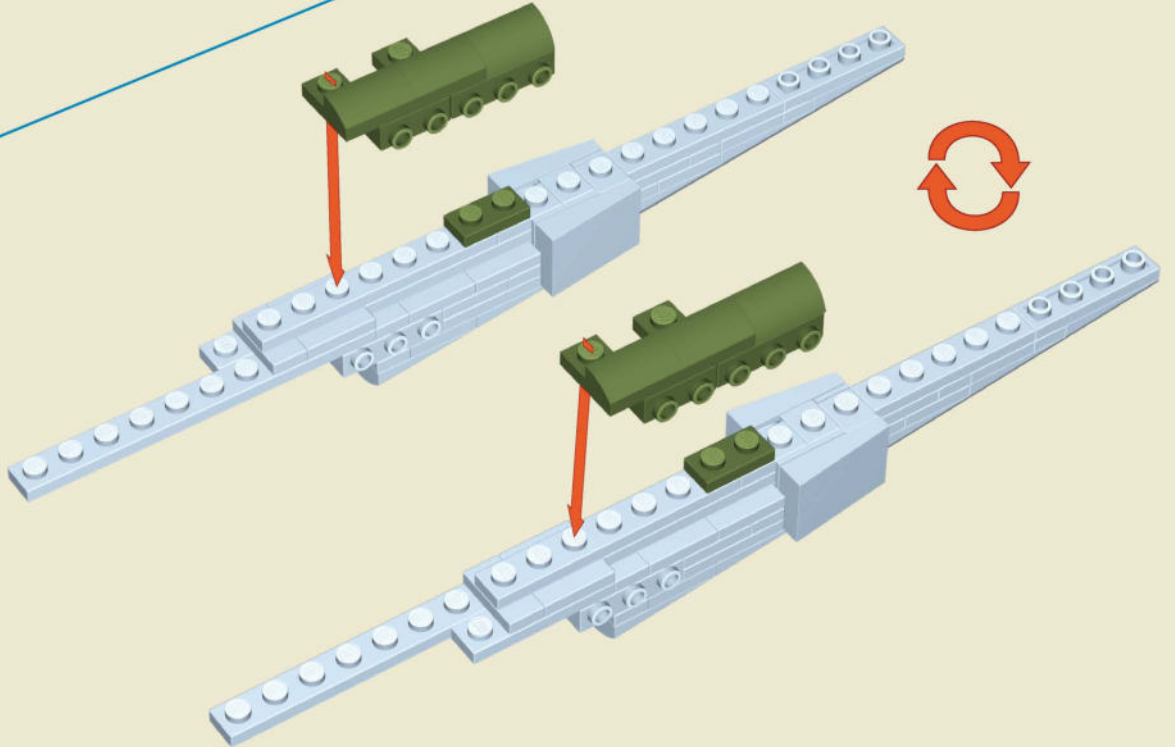

35

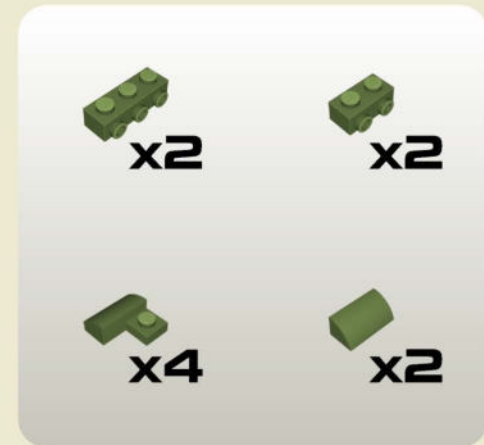
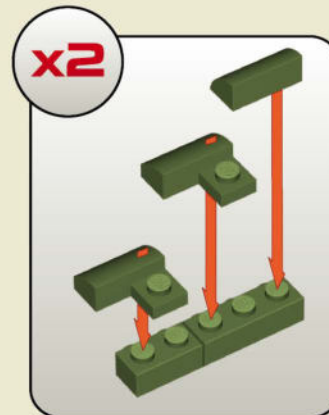
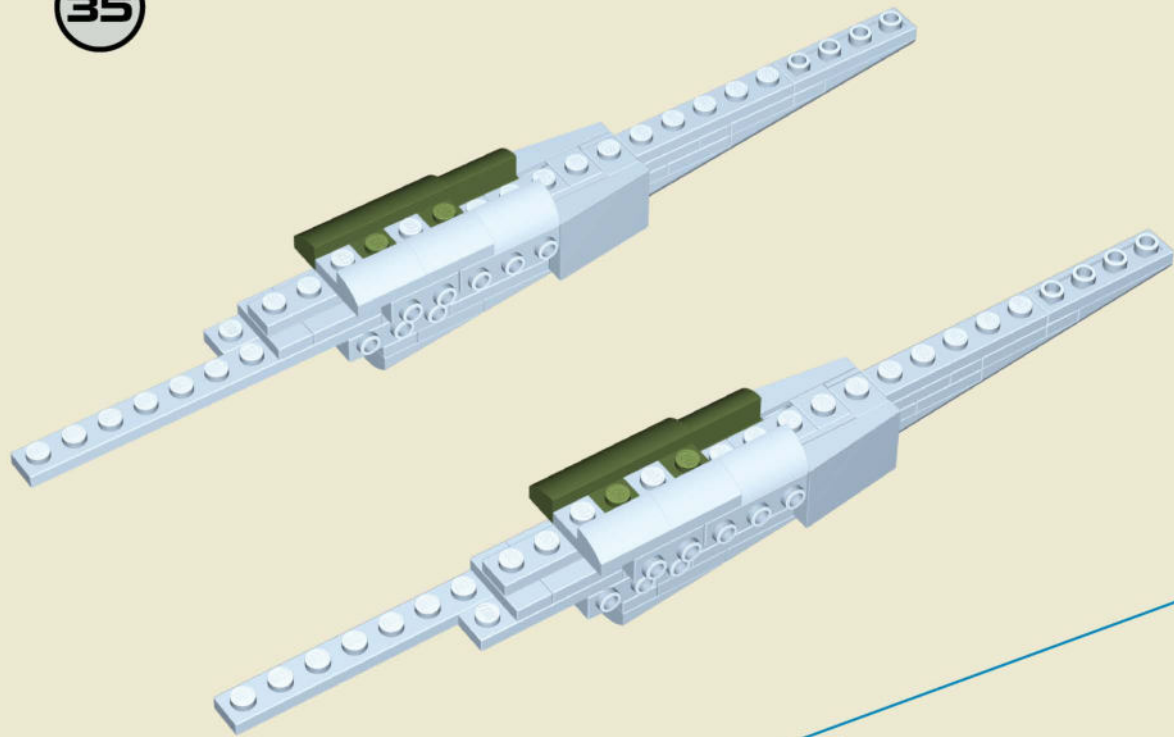

36

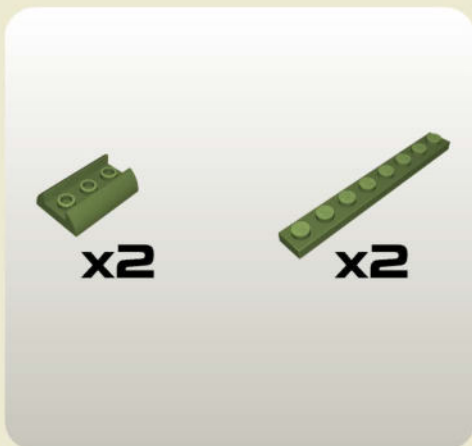
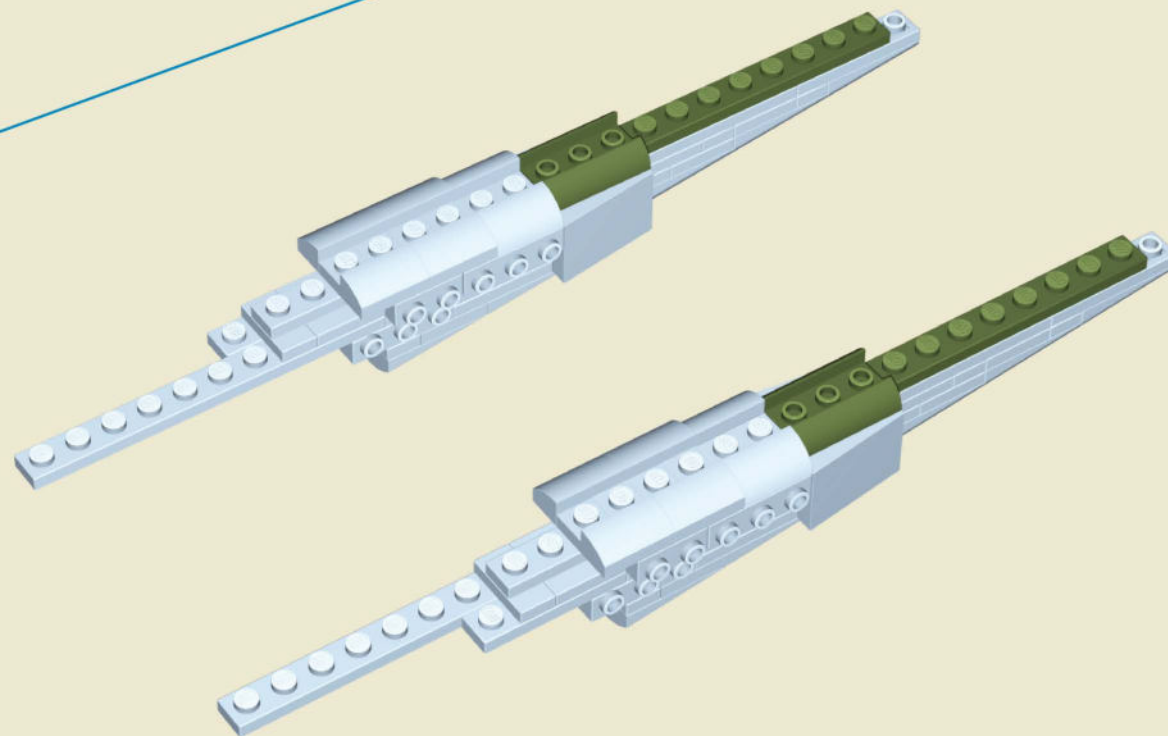

37

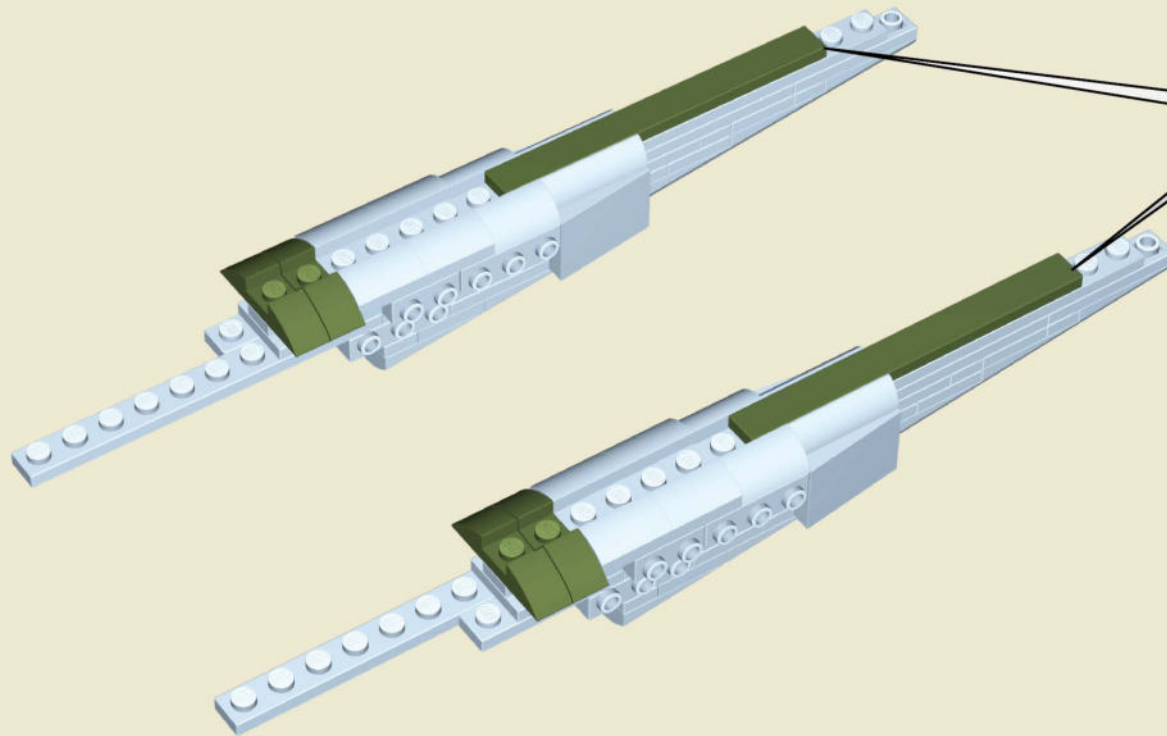

1:1

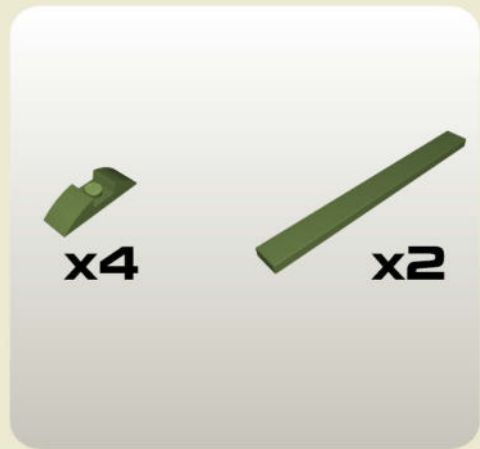

38

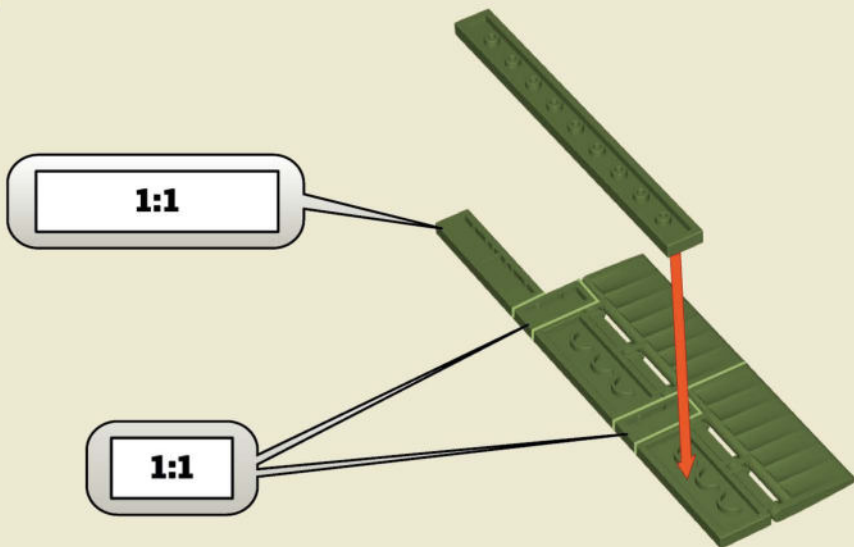

1:1

1:1

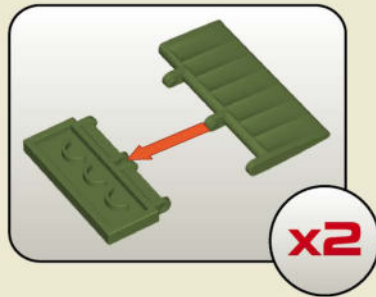

x2

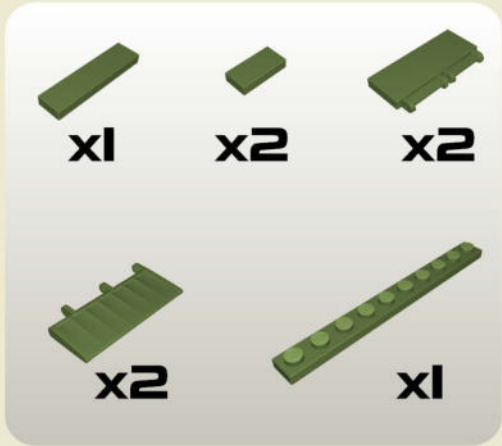

39

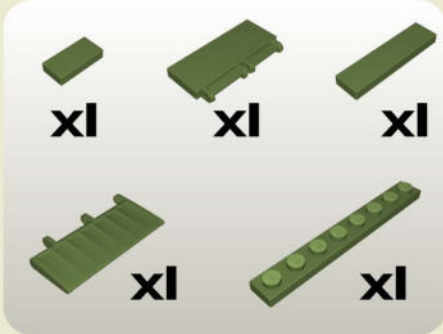
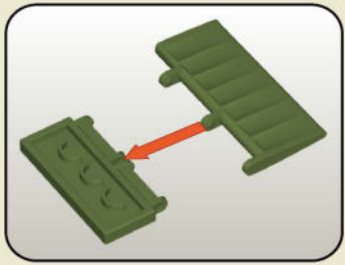
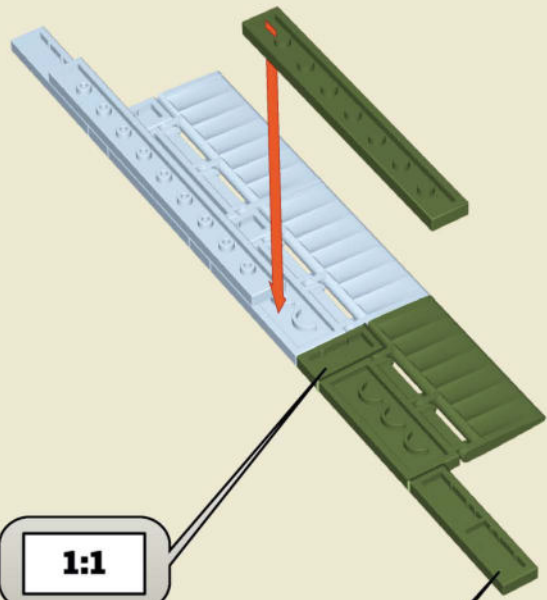

40

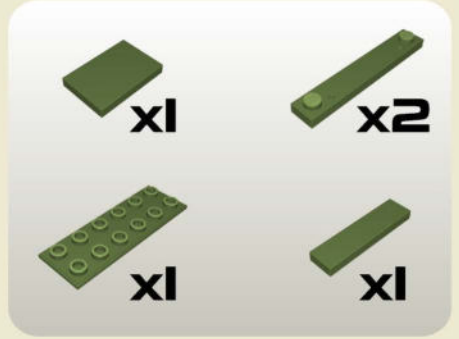
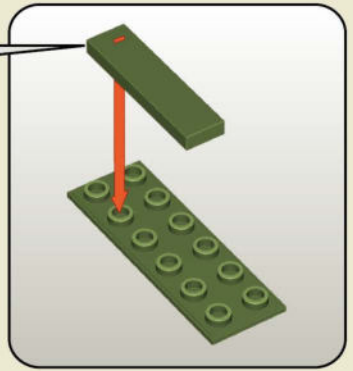
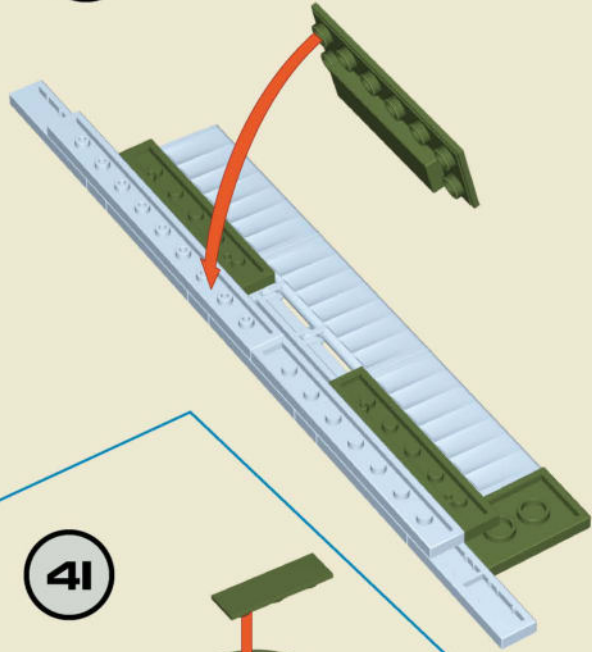

41

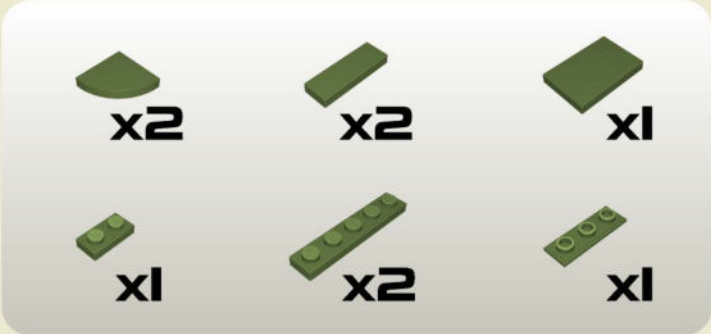
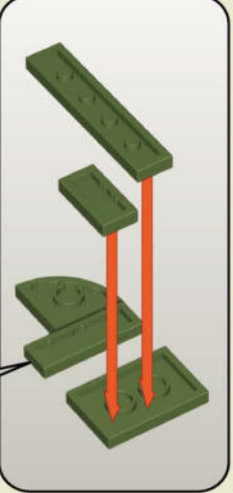
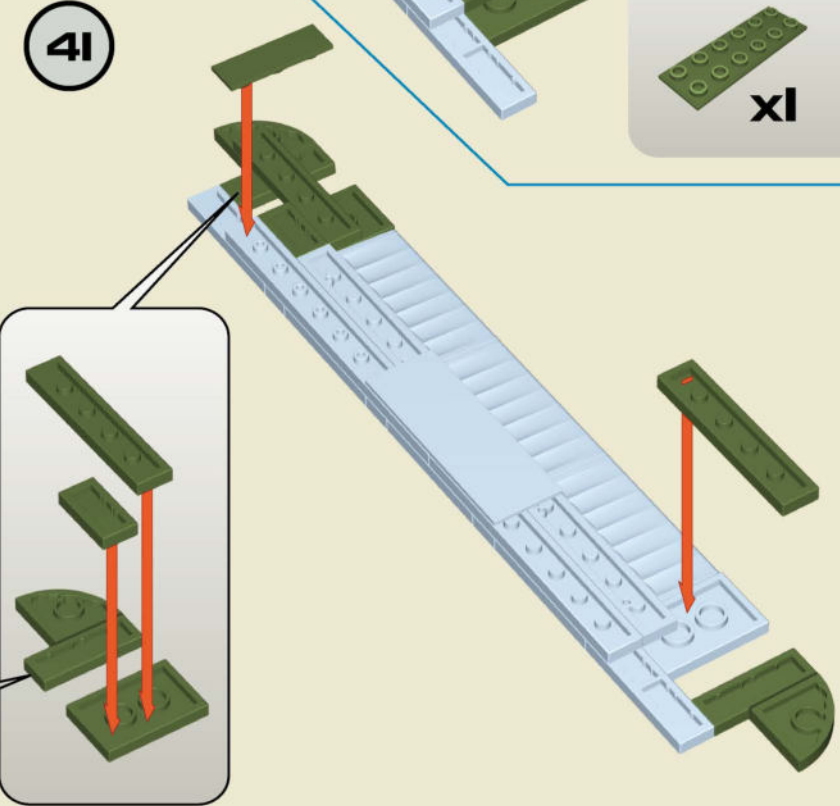

1:1

42

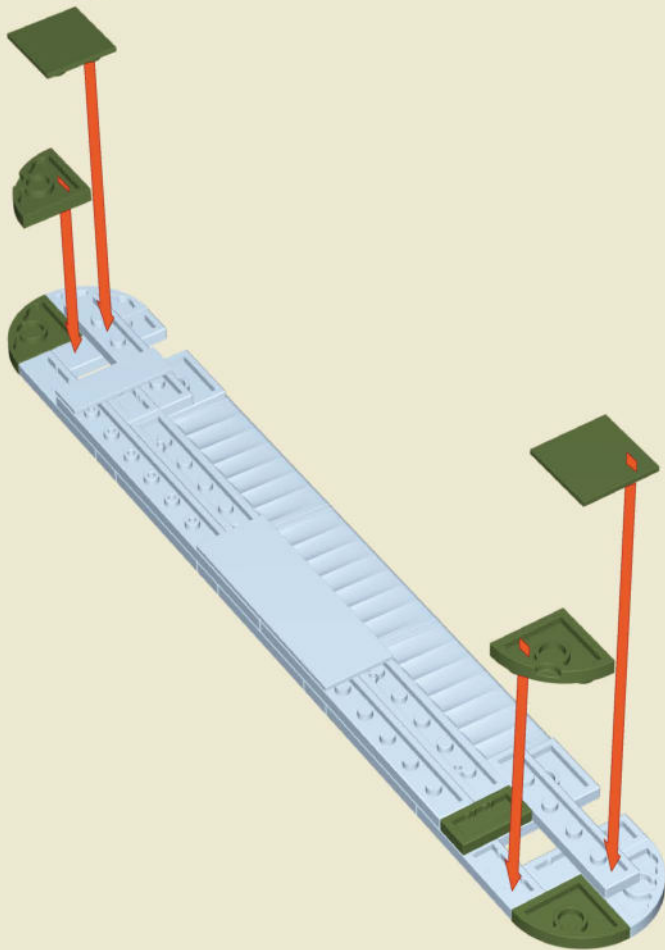

x2



x2



x2



x1

43

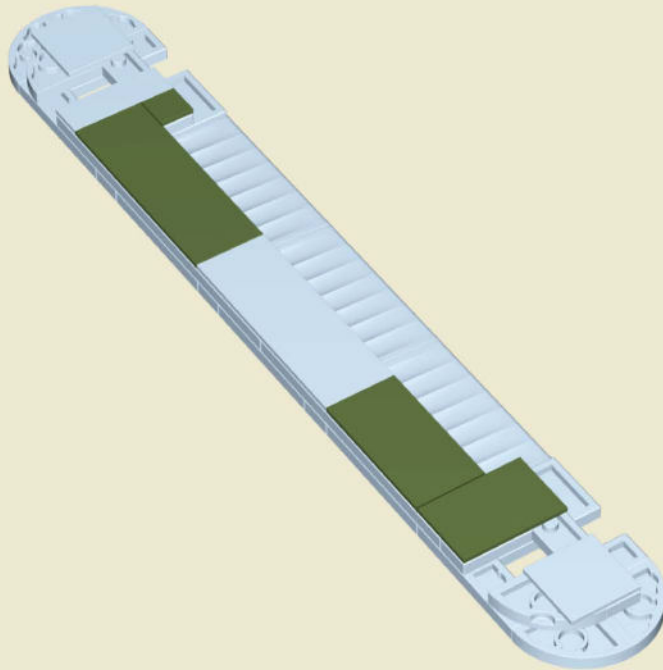

x1



x1



x1



x1

44

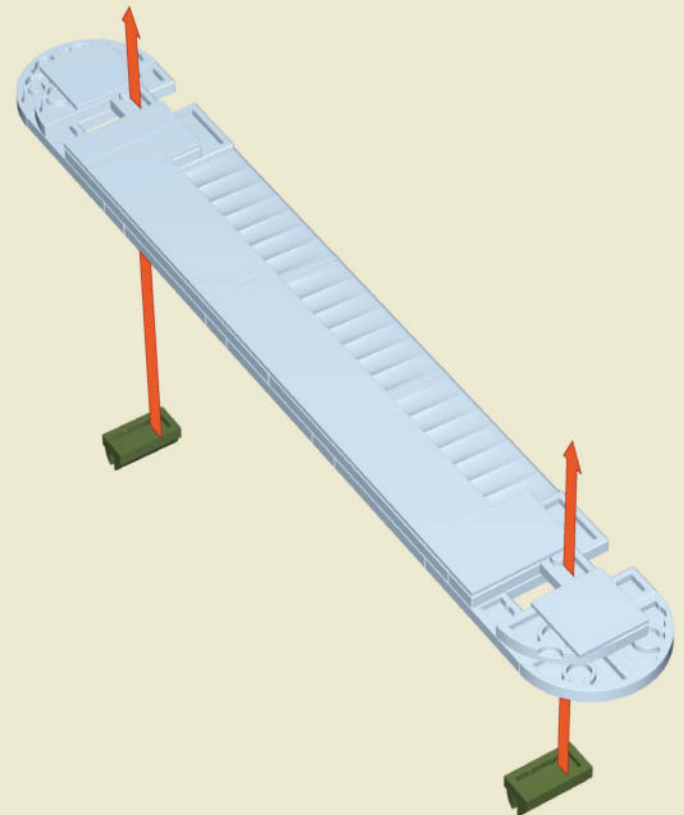

x2

45

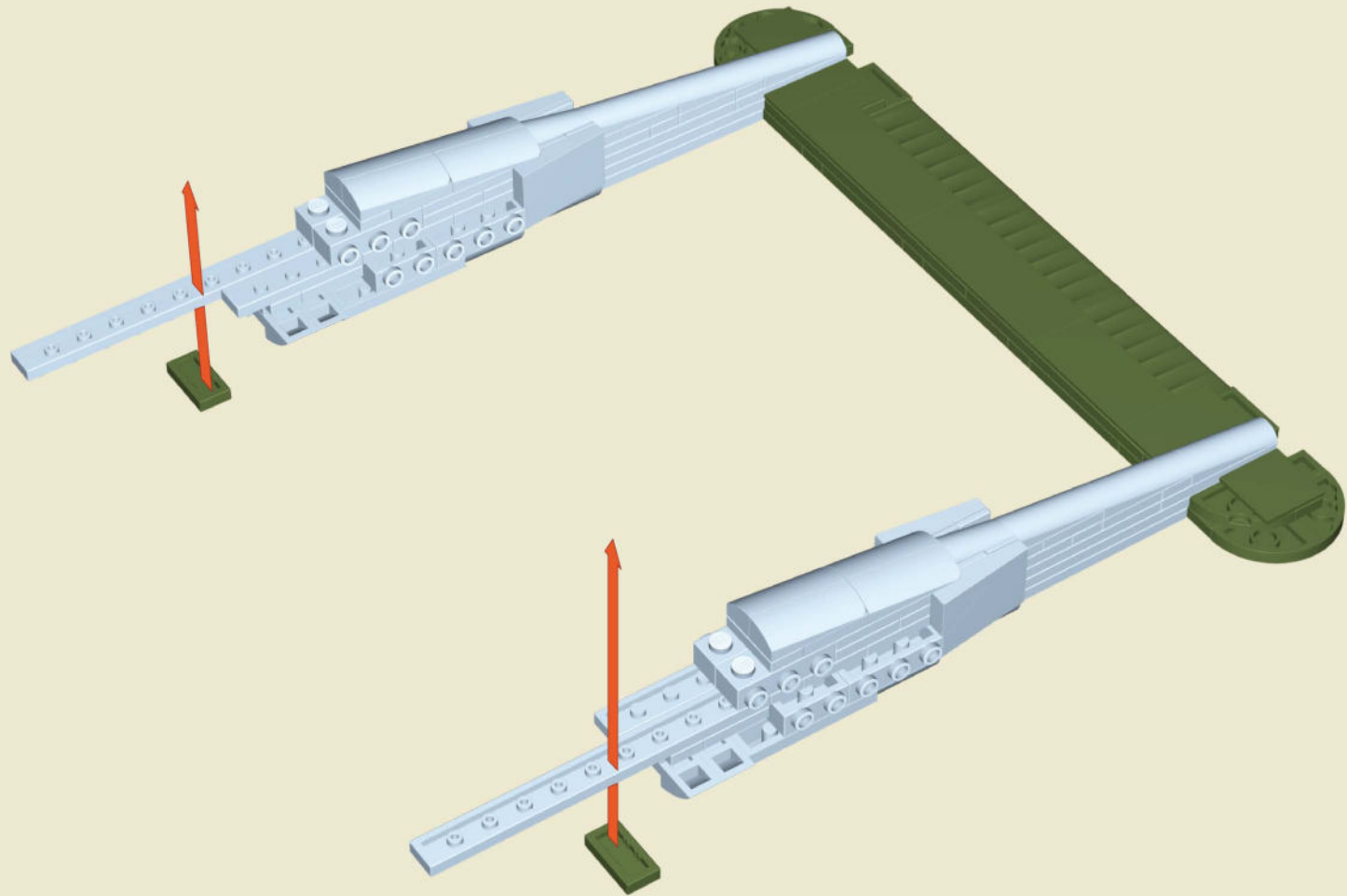

46

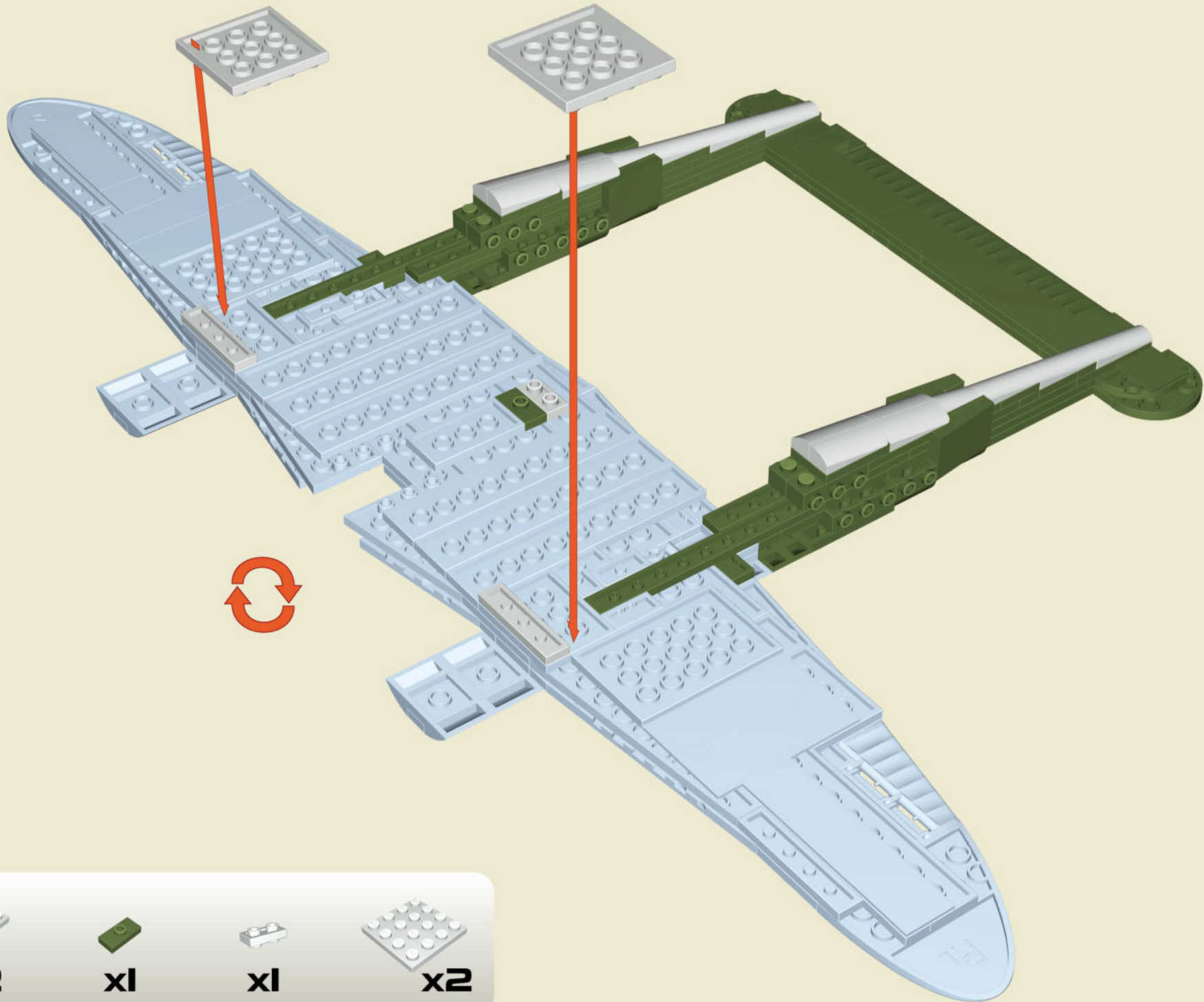

x2



x1



x1



x2



47

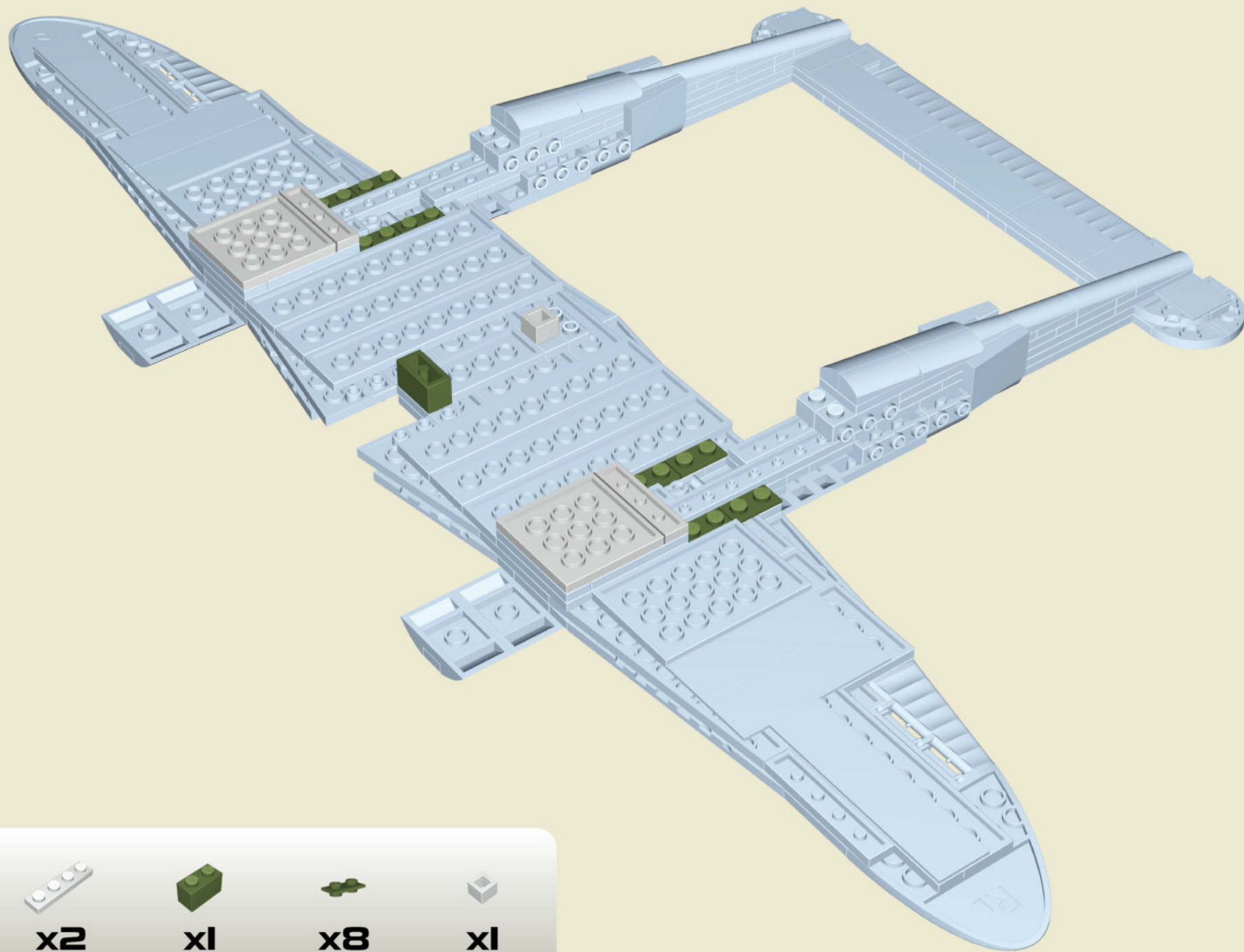

x2



x2



x1



x8



x1

48

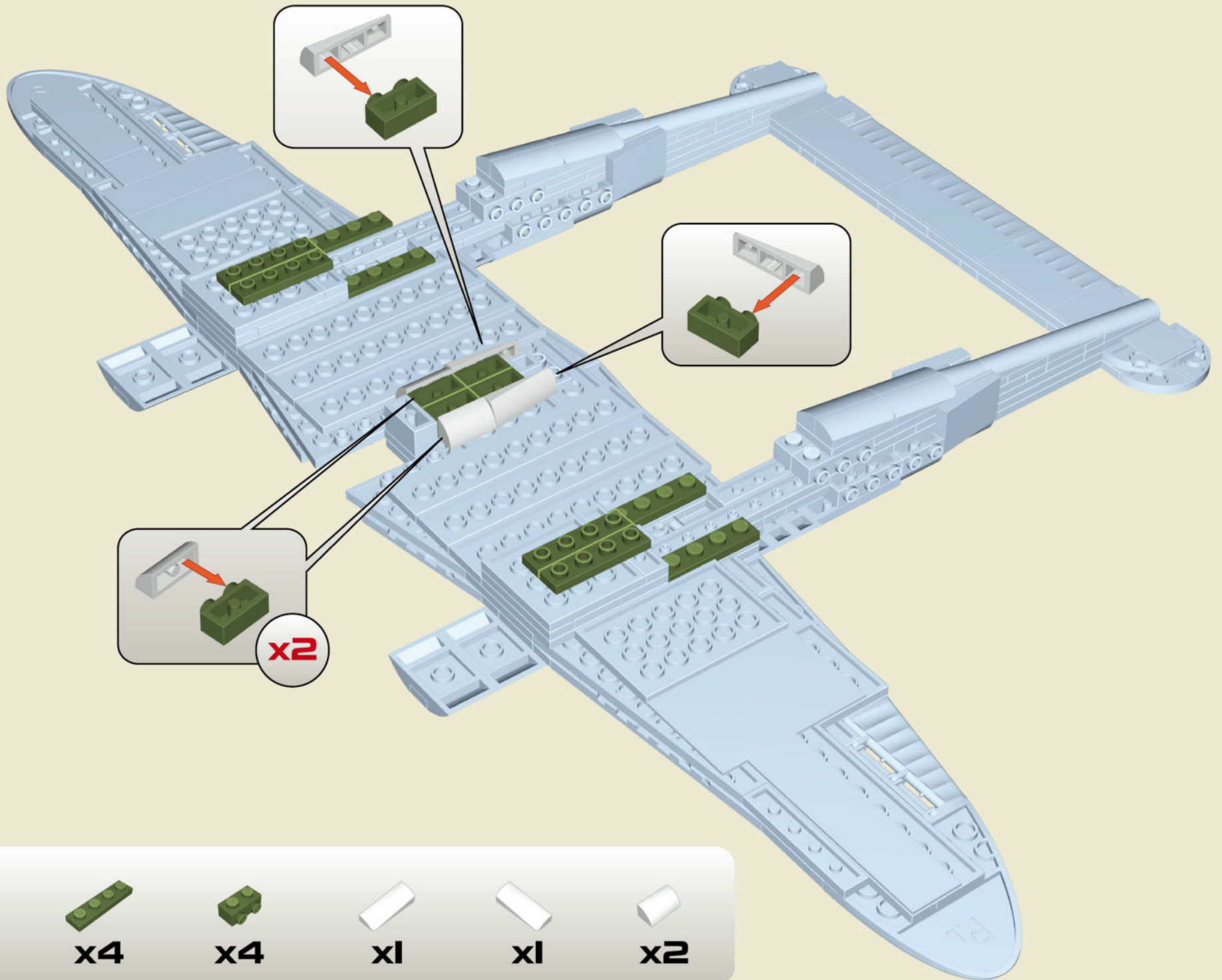

x4



x4



x4



x1



x1



x2

49

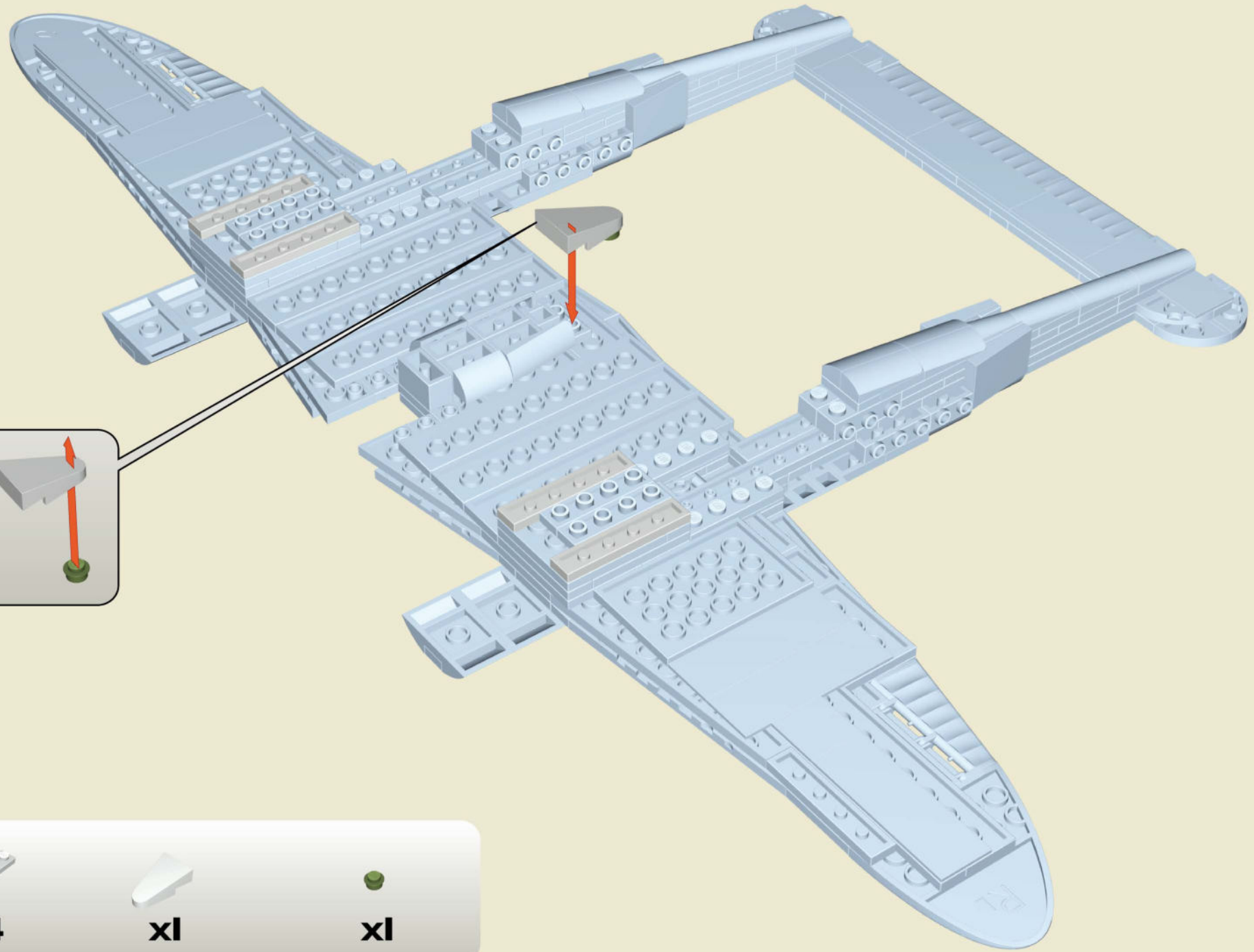

x4



x1



x1

50

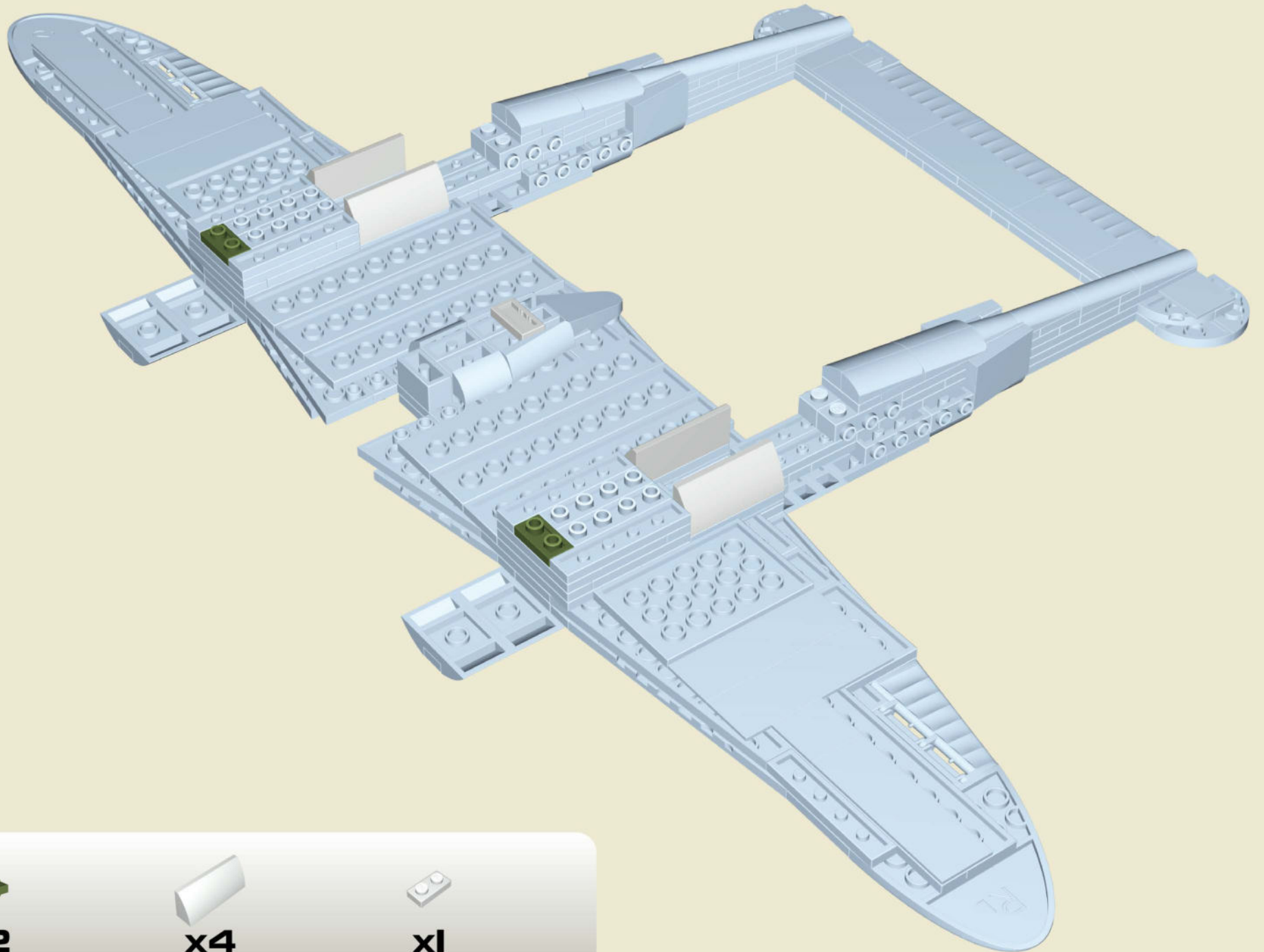

x2

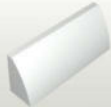

x4



x1

51

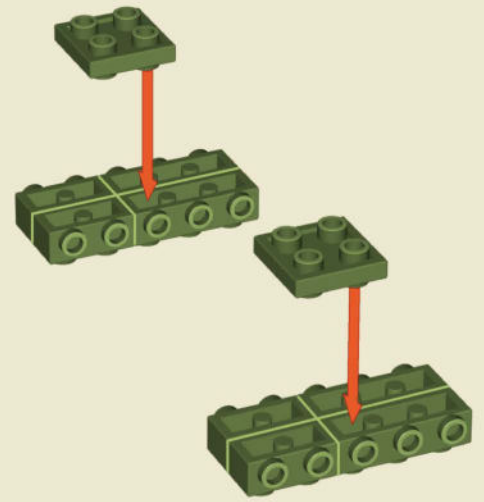

-  x4
-  x4
-  x2

52

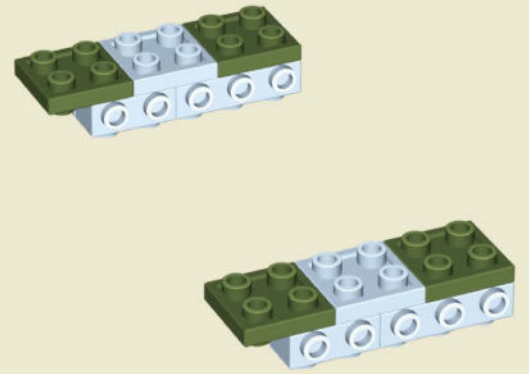

-  x4

53

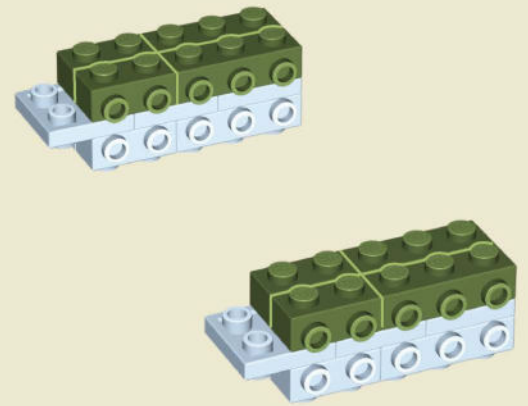

-  x4
-  x4

54

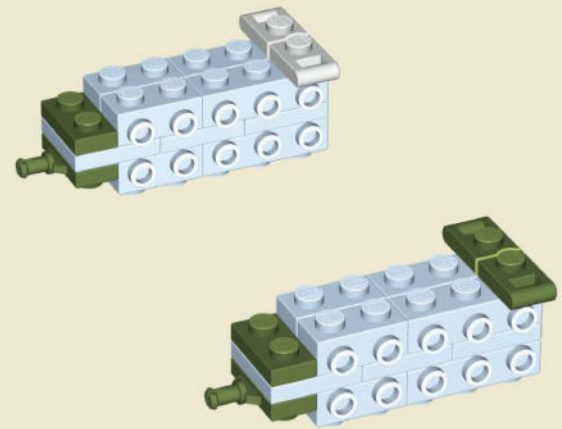

-  x2
-  x2
-  x2
-  x2

55

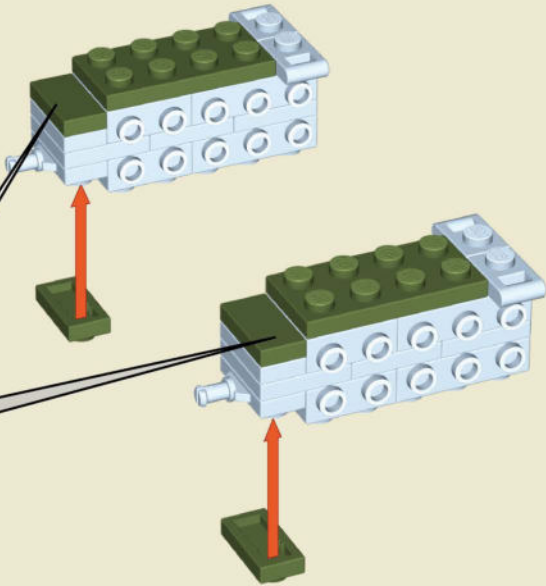

1:1

 x2

 x2

 x2

56

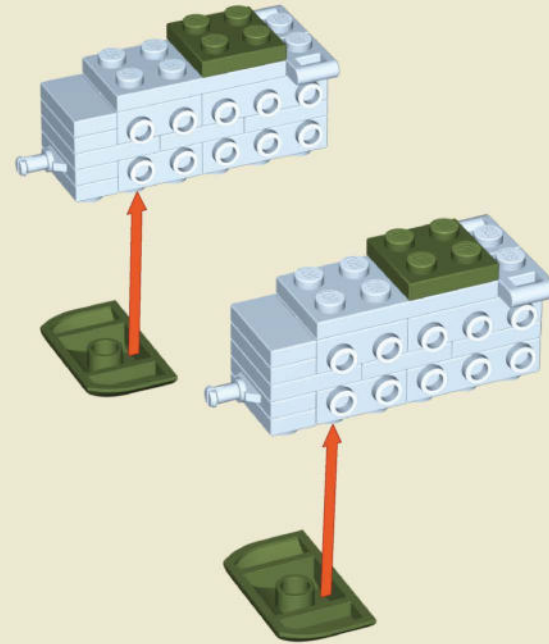

 x2

 x2

57

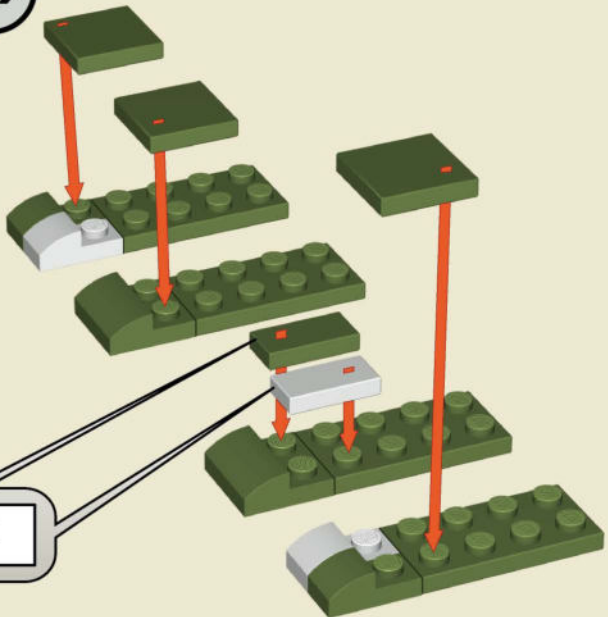

1:1

 x2

 x2

 x2

 x4

 x3

 x1

 x1

58

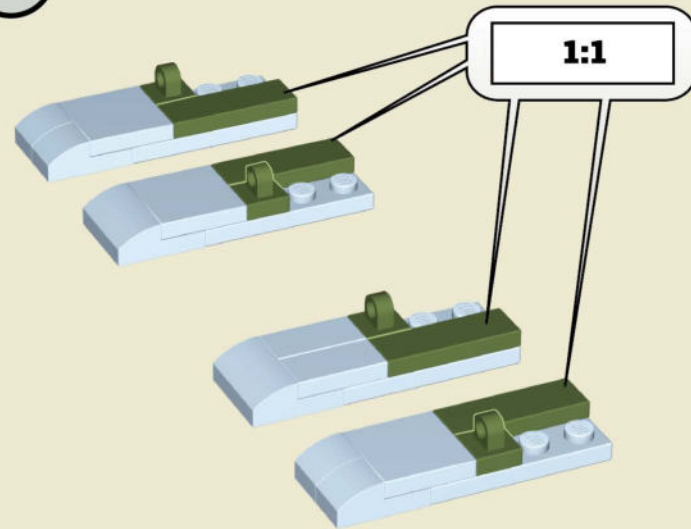

1:1

 x4

 x4

59

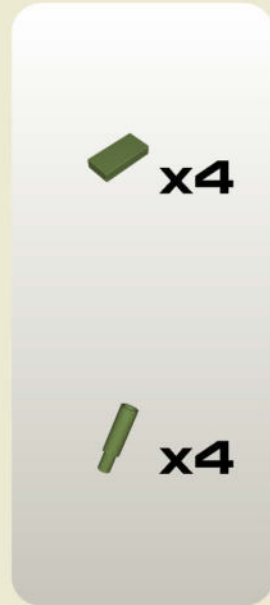
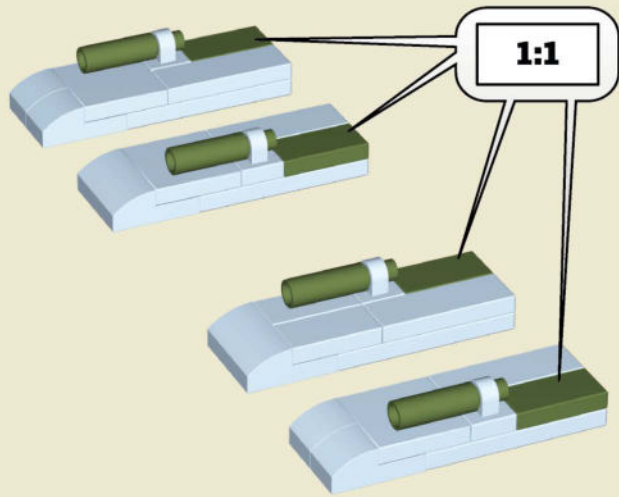

60

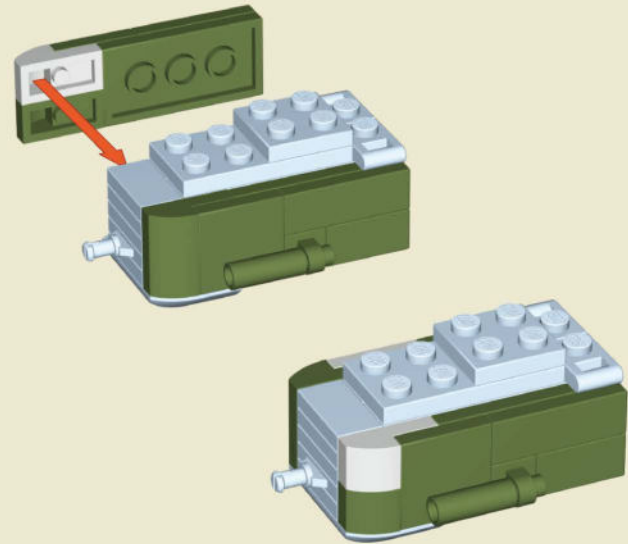

61

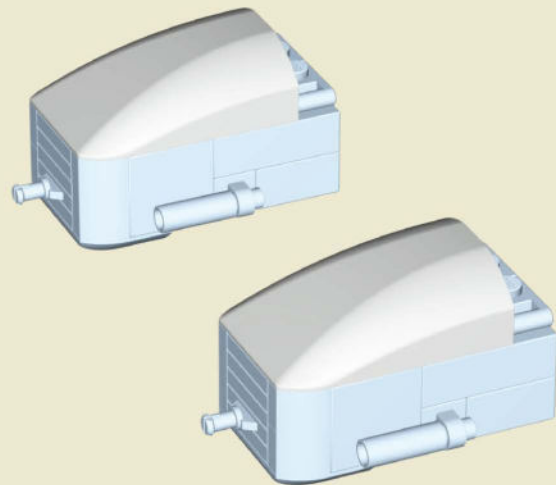

62

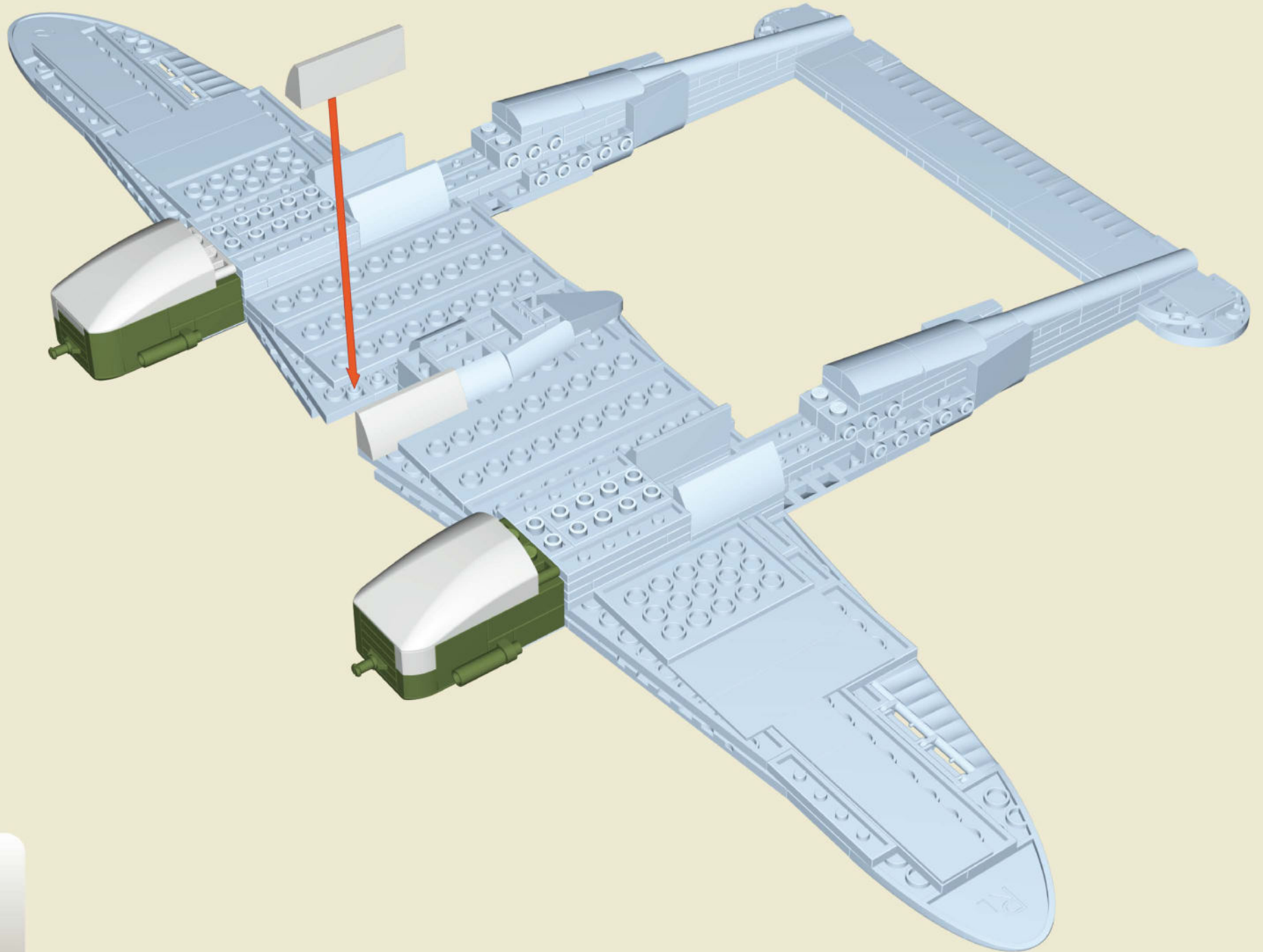

63

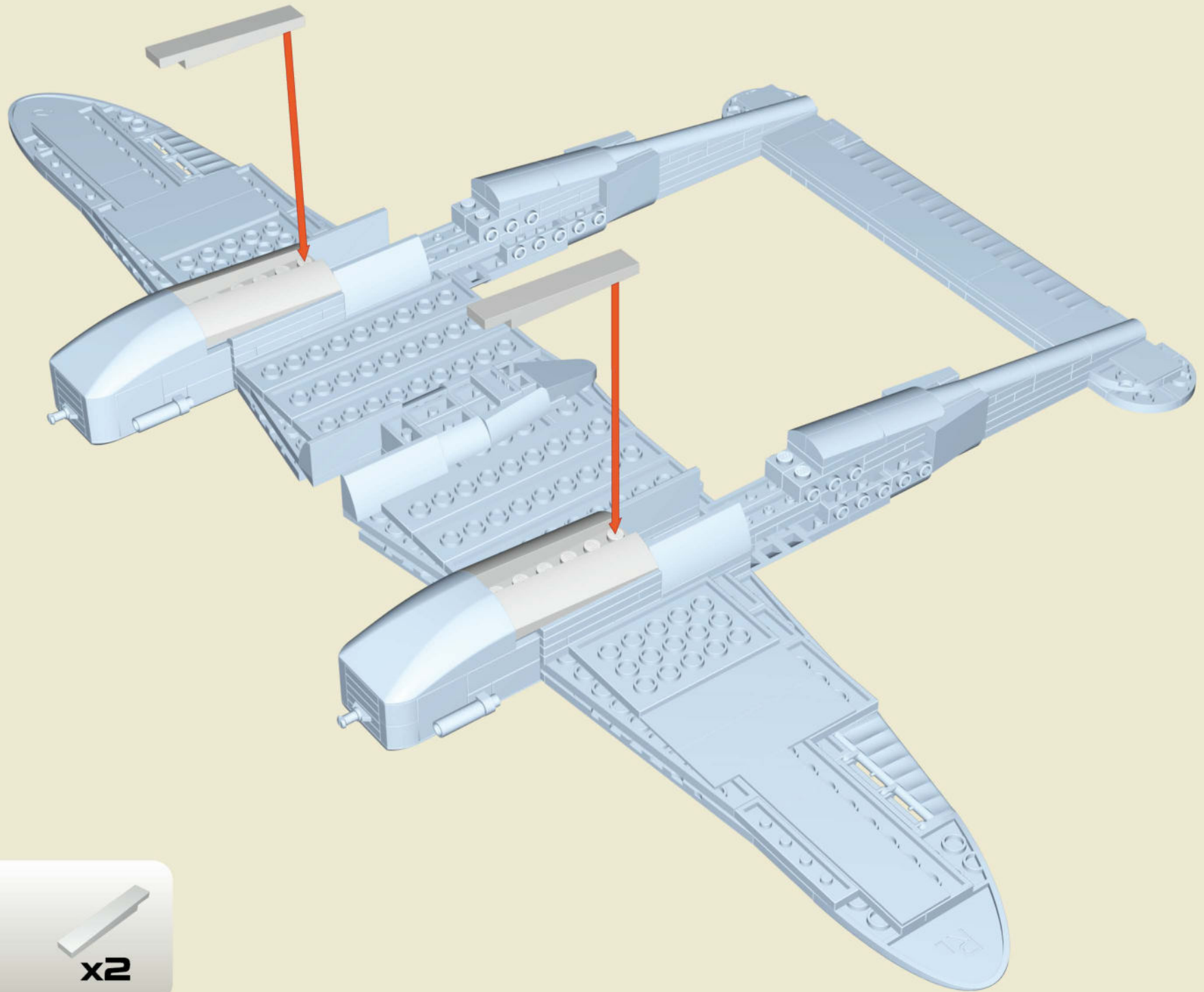

64

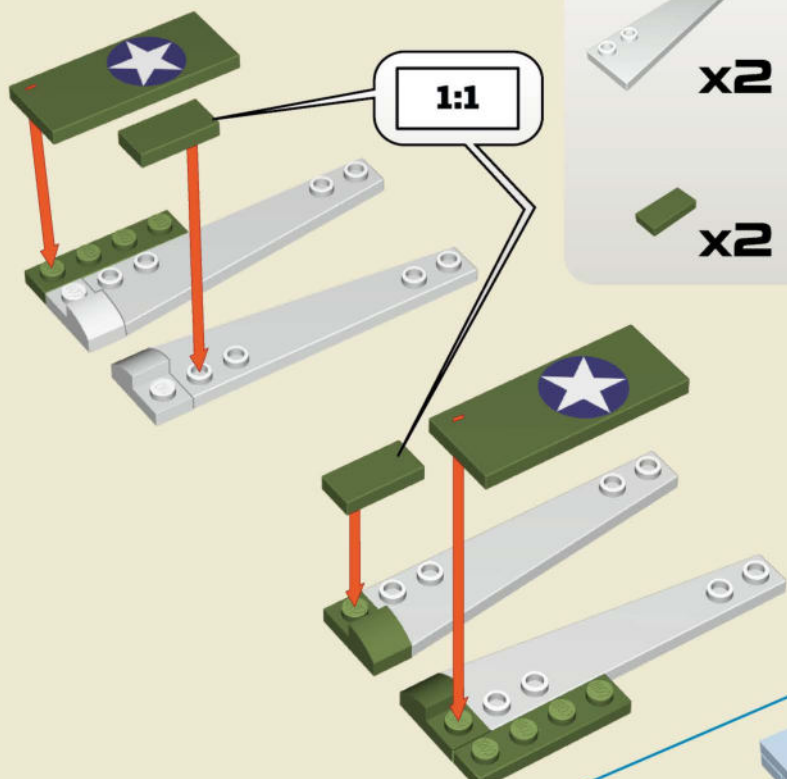

1:1

- x2
- x2
- x2
- x2
- x2
- x1
- x1
- x2

65

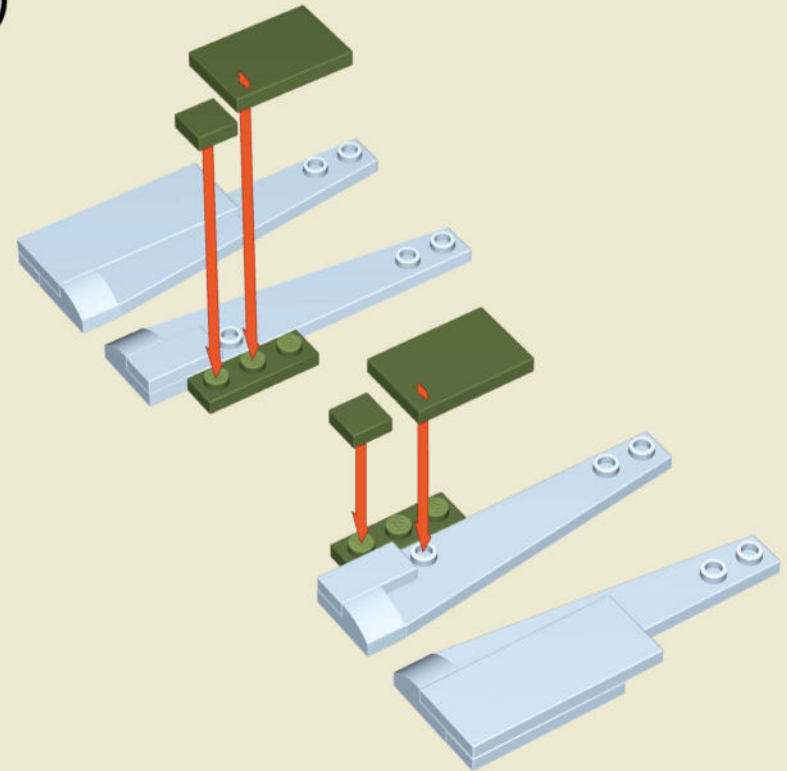

66

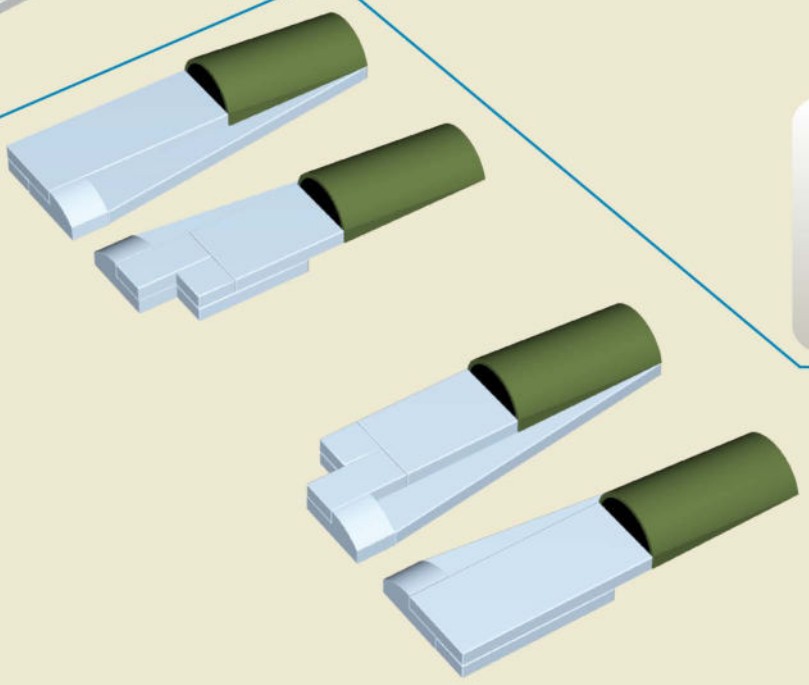

- x2
- x2
- x2

- x4

67

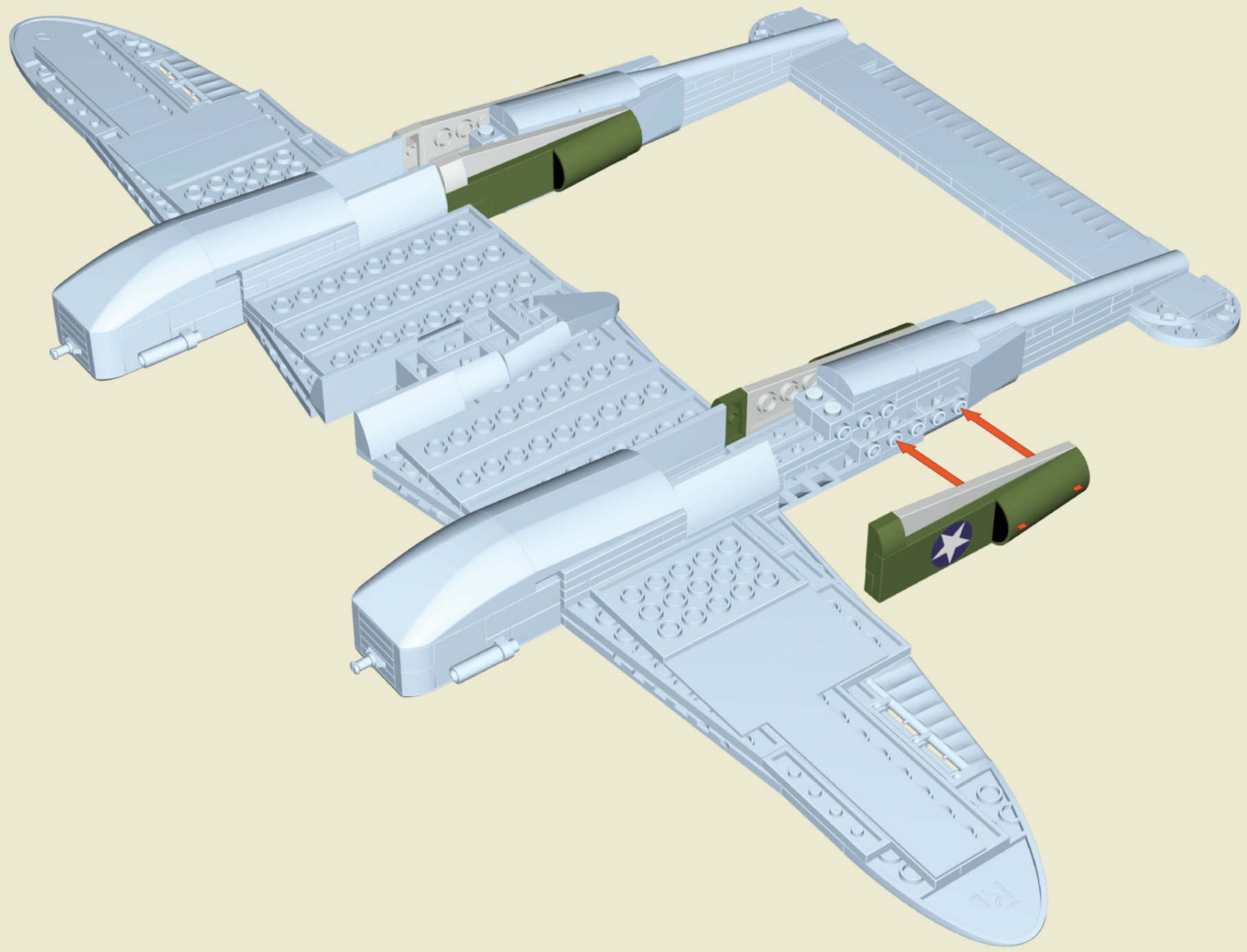

68

1:1

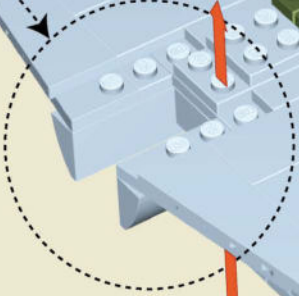
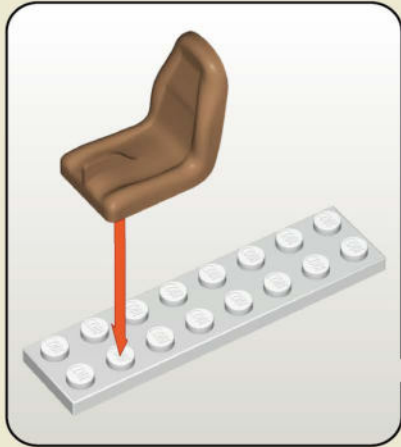
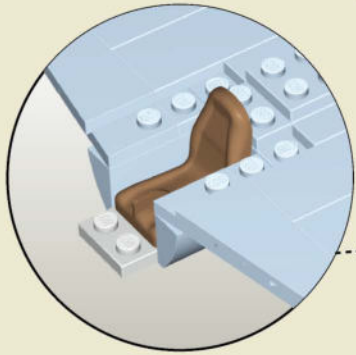

- x1
- x1
- x2
- x2
- x1
- x1

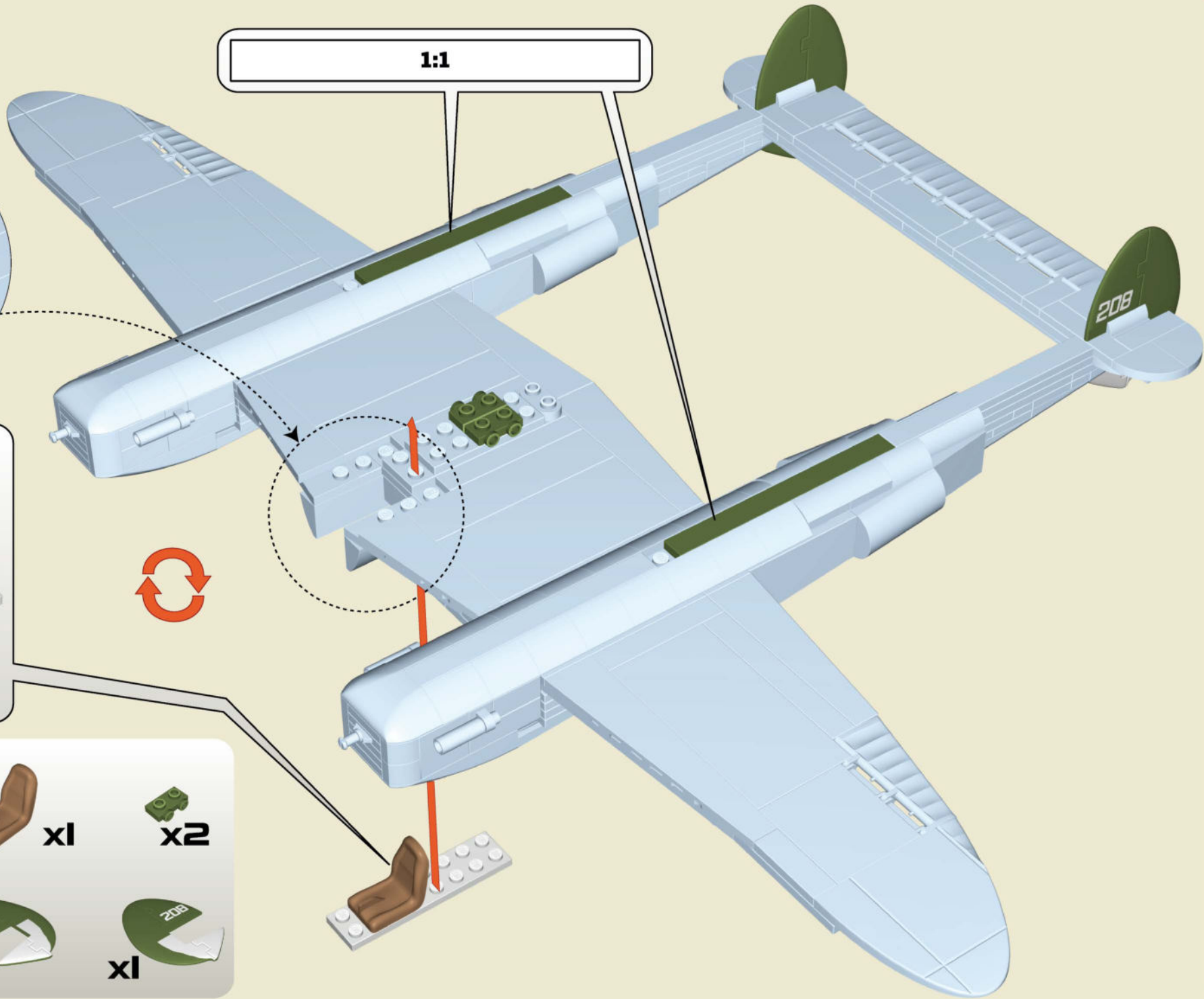

69

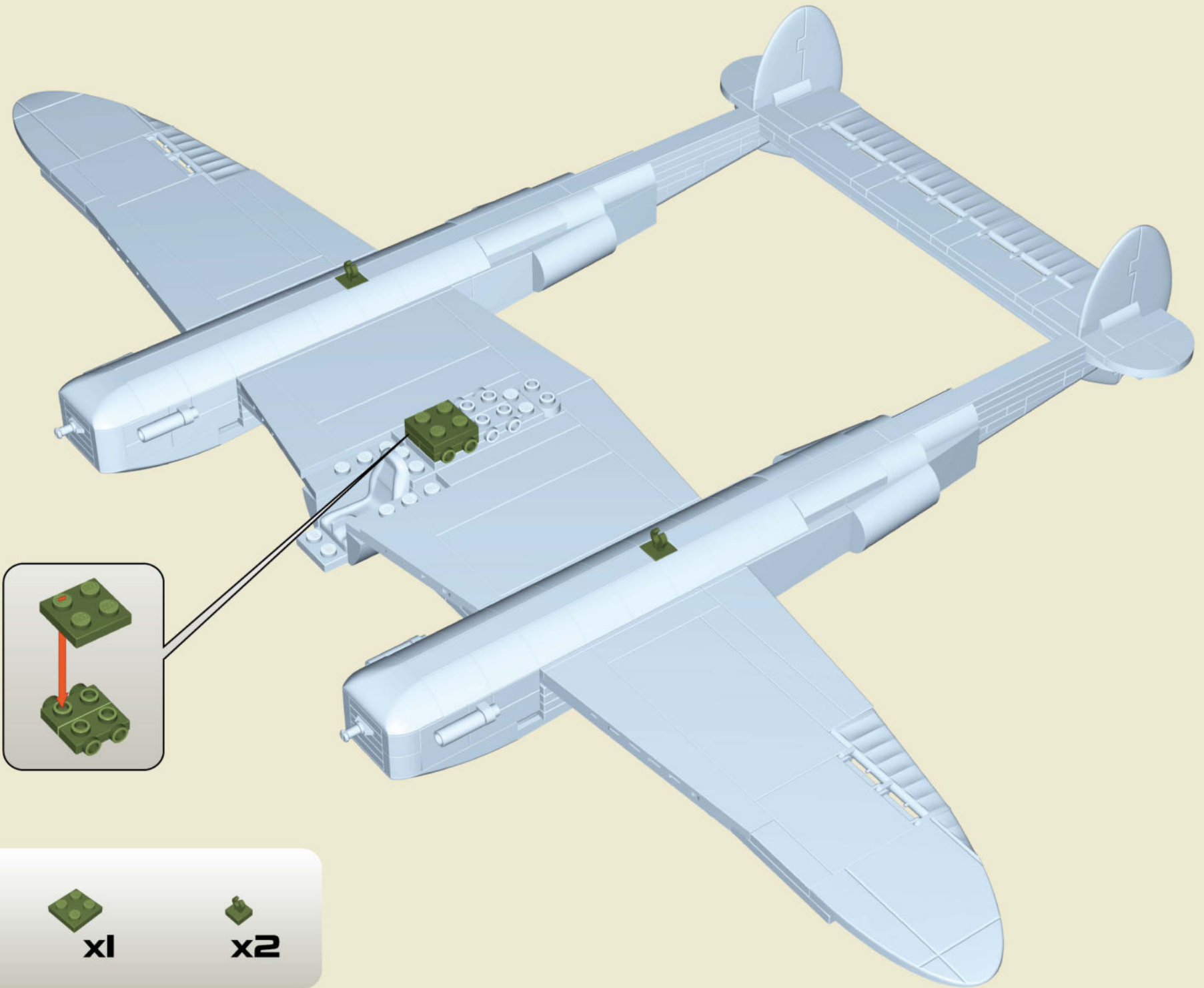



x2

x1

x2

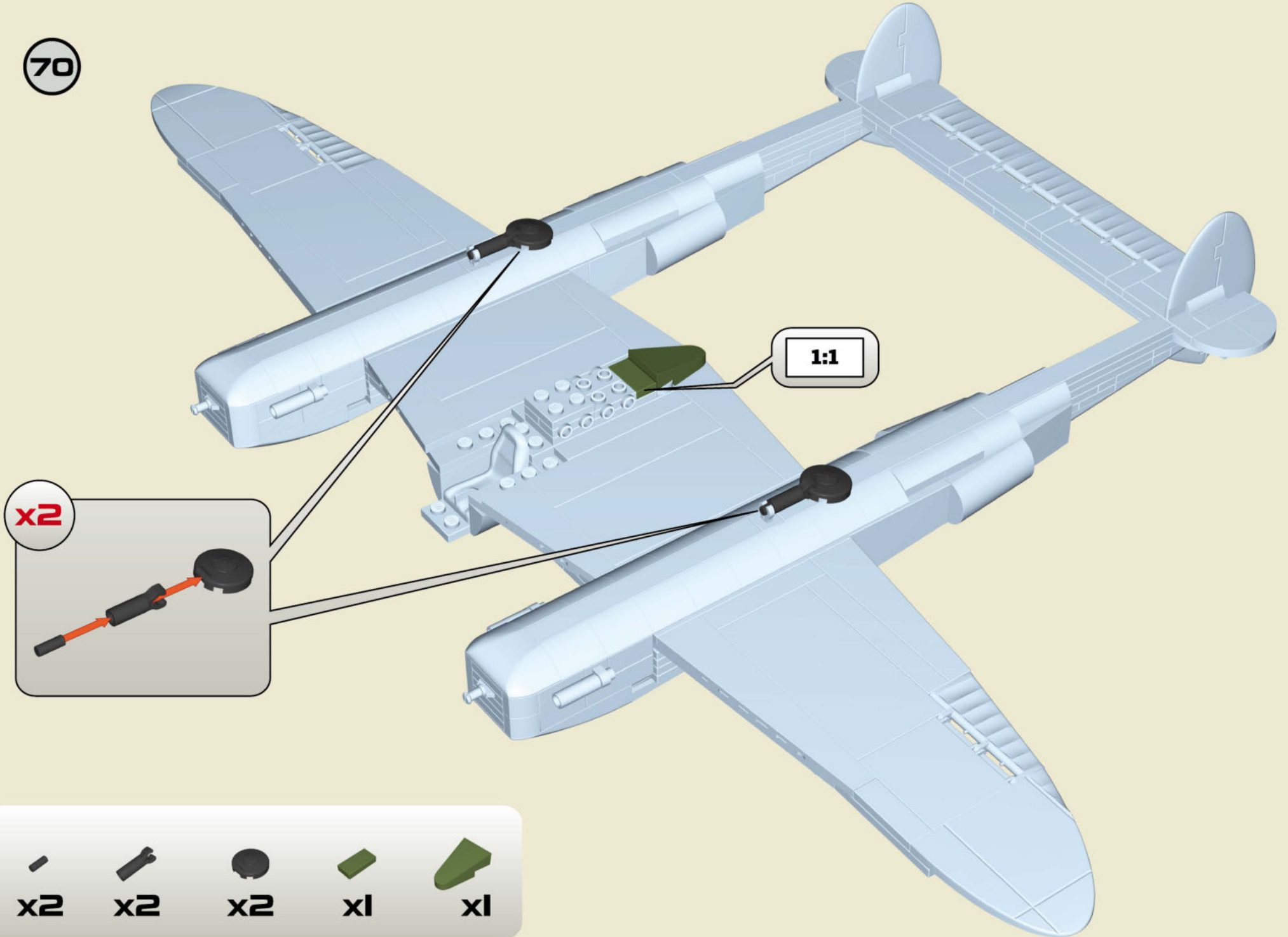
70



x2

1:1

x2

x2

x2

x1

x1

71

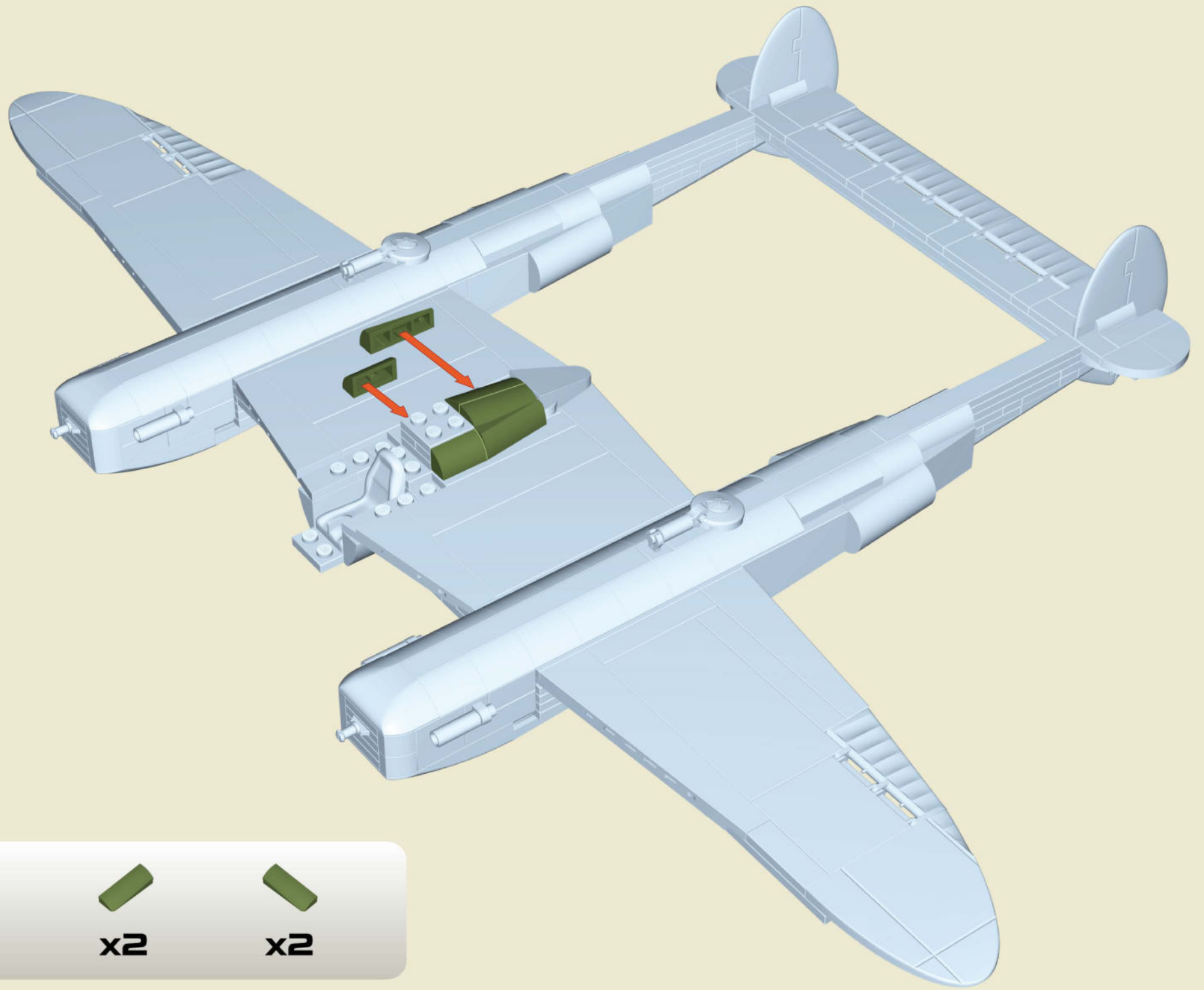

x2



x2



x2

72

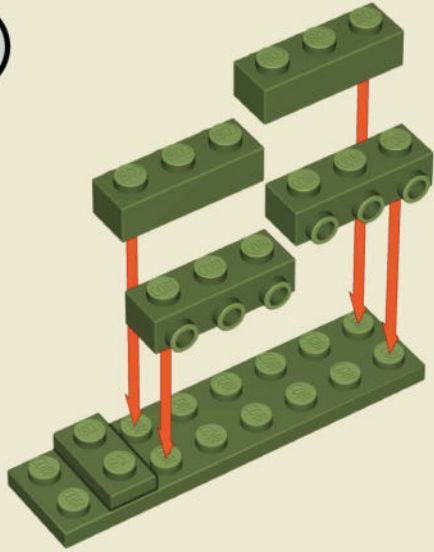

x1



x1



x4

73

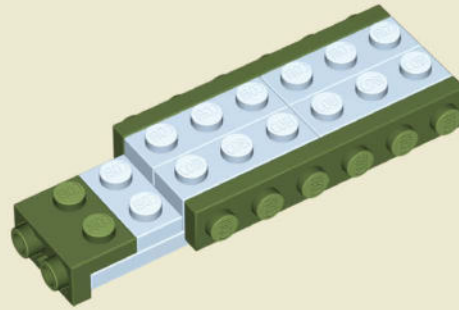

x1



x2

74

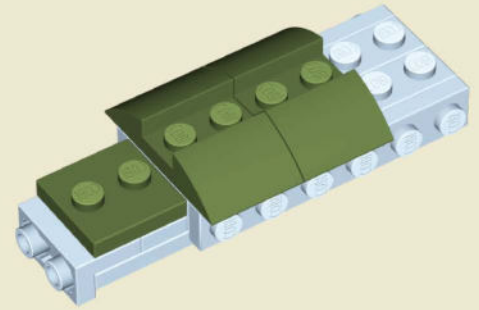

x1



x2

75

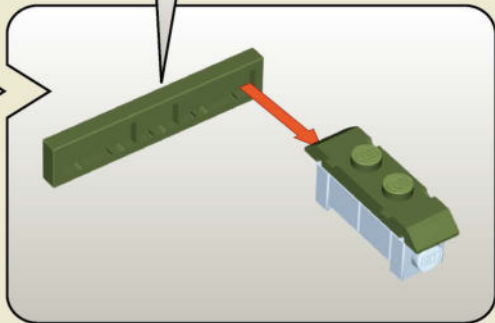
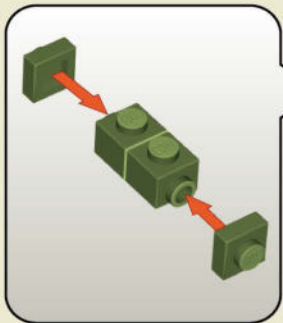

1:1

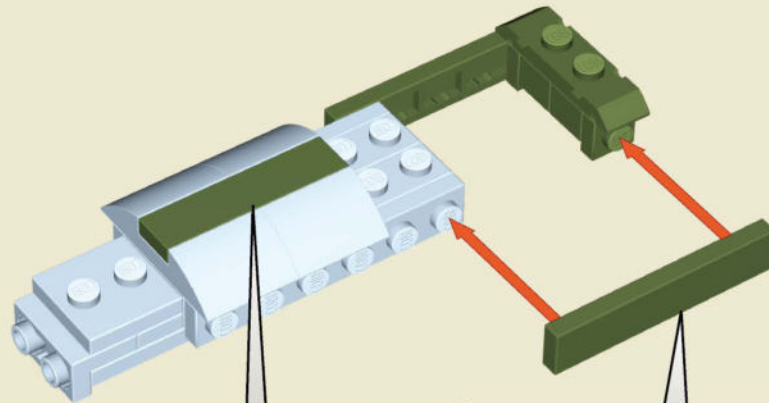

1:1

1:1



x2



x2



x1



x2

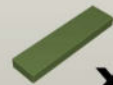

x1

76

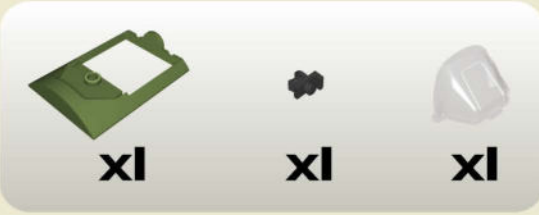
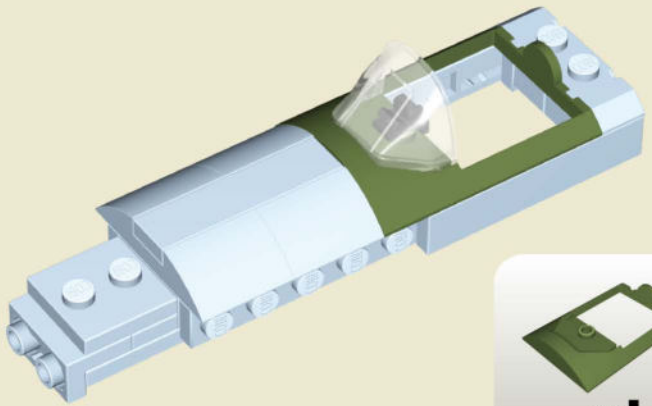
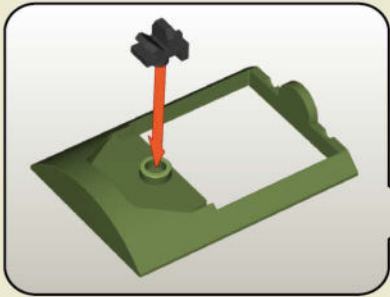

77

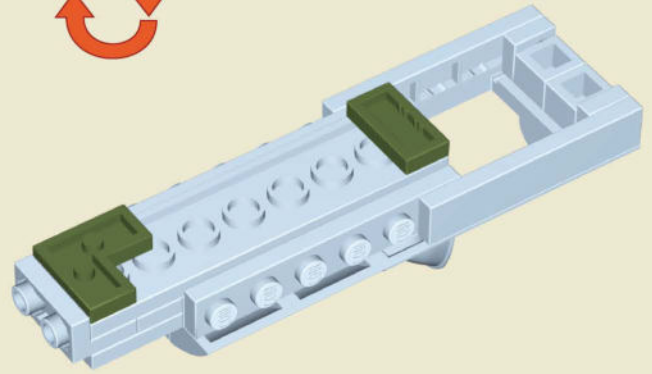

78

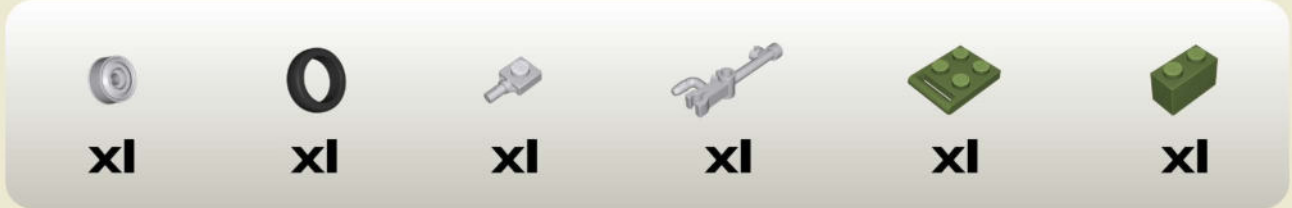
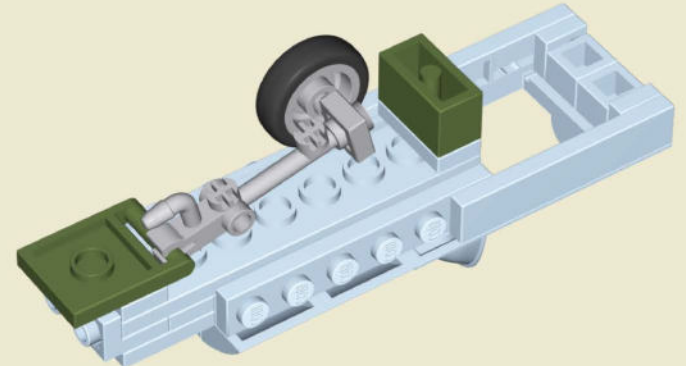
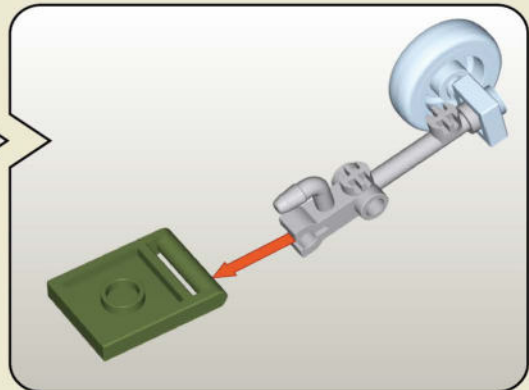
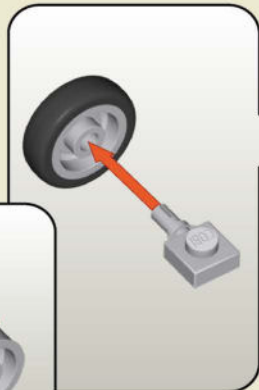

79

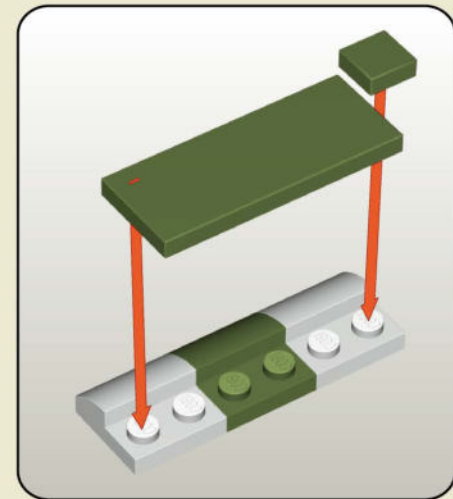
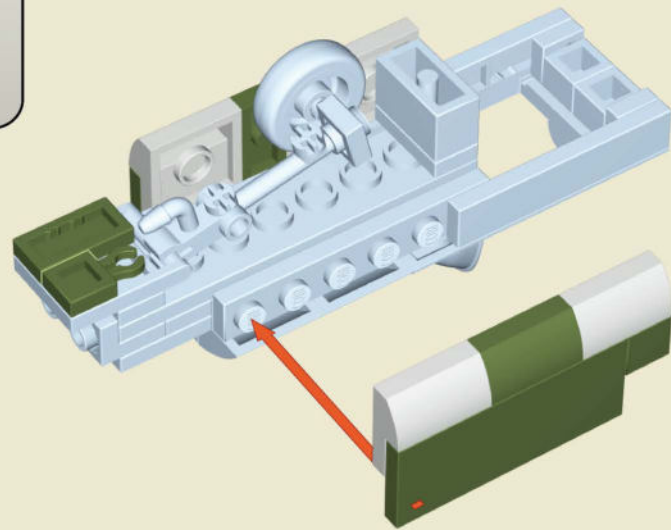
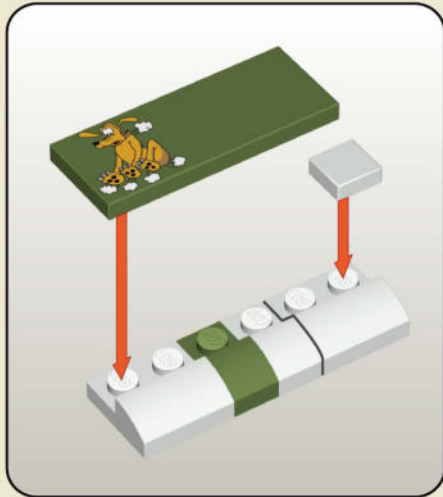

x1



x1



x4



x1



x1



x1



x1



x1



x1





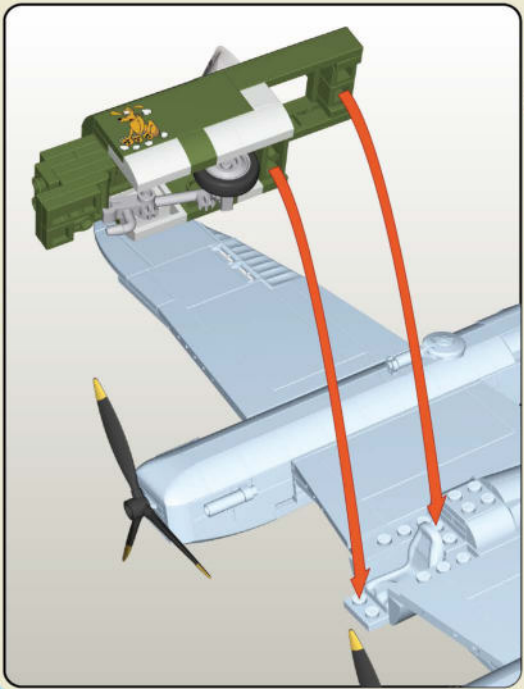
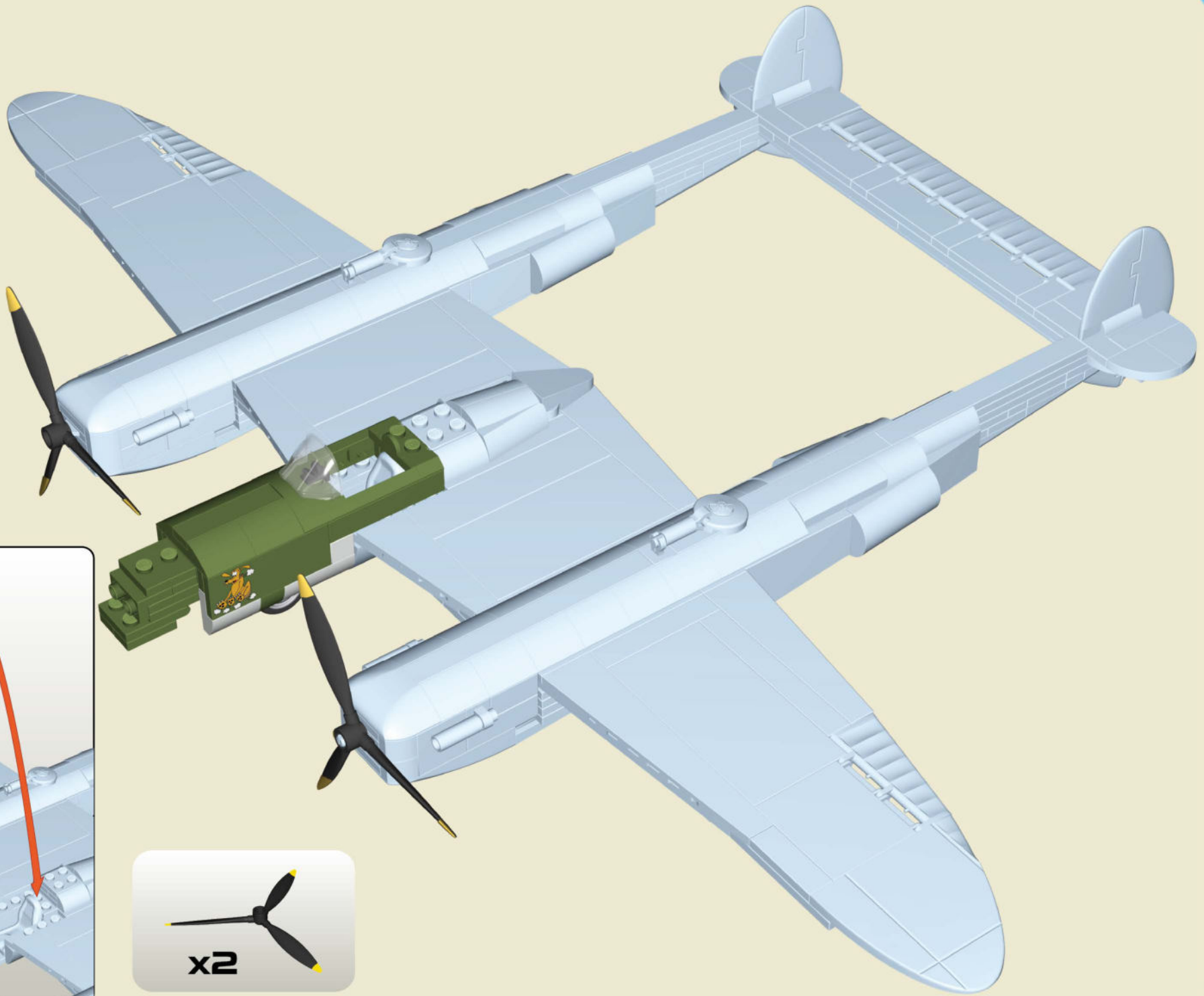

x1

80

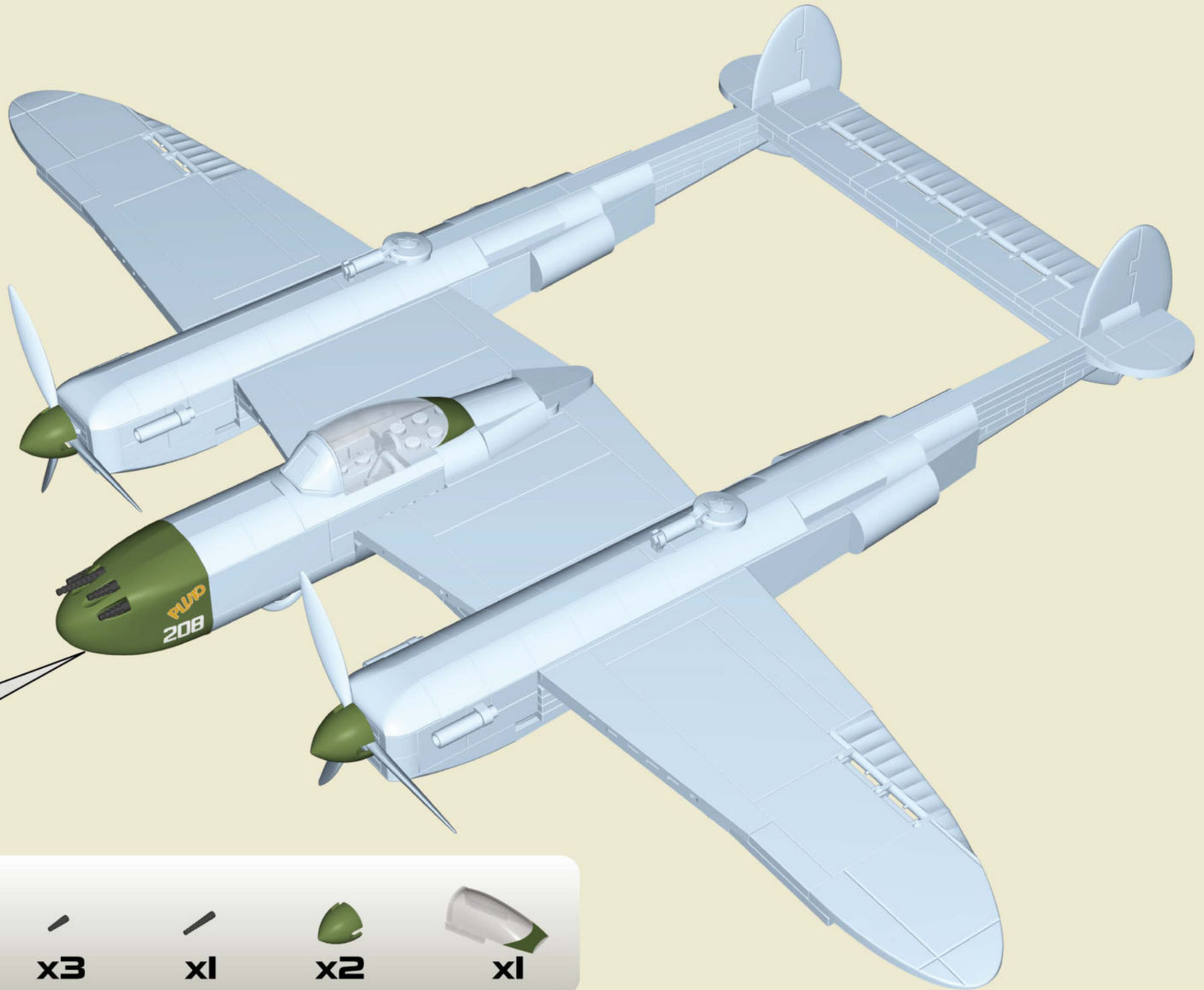









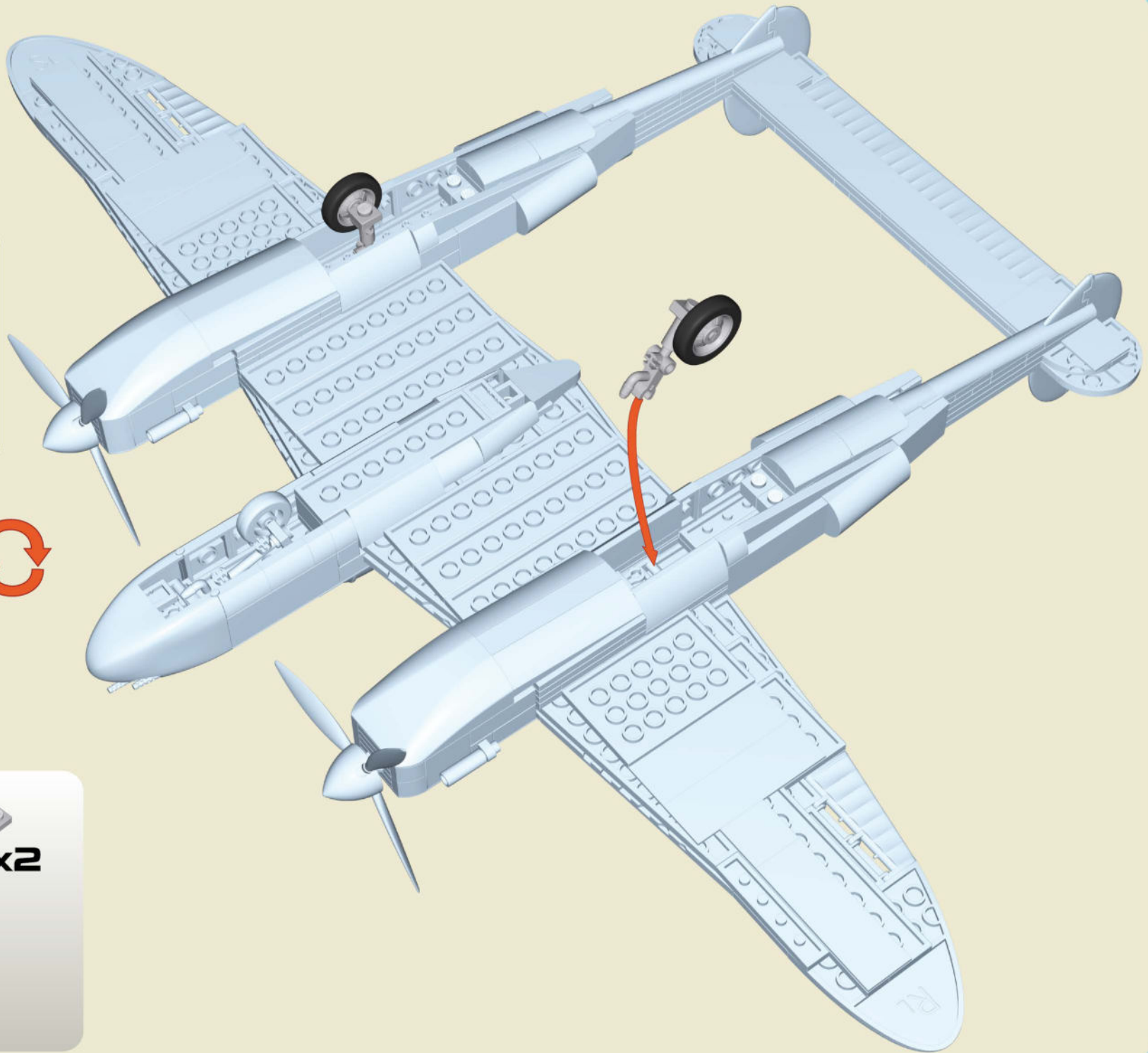
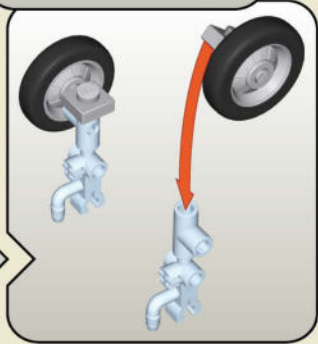
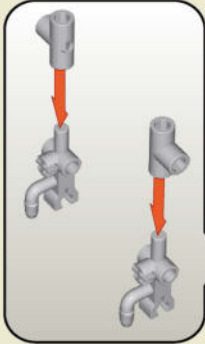







































81



-  x1
-  x3
-  x1
-  x2
-  x1

82



 x3 122319	 x6 44014	 x1 42875	 x4 105094	 x3 42882	 x1 92880	 x4 121246	 x3 45494	 x2 44879	 x1 124777	 x2 111576
 x1 132984	 x23 42931	 x1 92647	 x8 42913	 x1 92649	 x4 42939	 x1 104956	 x1 115866	 x15 45540	 x1 92882	 x2 98244
 x5 104428	 x5 104720	 x2 117265	 x4 132329	 x5 42952	 x2 42895	 x16 113534	 x6 98140	 x2 99036	 x2 140308	 x2 111481
 x8 132618	 x4 42959	 x8 93457	 x20 99234	 x2 120910	 x5 120905	 x2 120907	 x5 120906	 x6 122007	 x1 109733	 x12 42976
 x4 92653	 x8 42985	 x1 135085	 x4 64202	 x4 108698	 x1 140252	 x6 67985	 x4 92887	 x4 85566	 x2 43017	 x2 83478
 x2 66613	 x2 131770	 x2 74222	 x4 106603	 x5 43033	 x5 43084	 x4 129065	 x2 134353	 x8 43092	 x3 43100	 x8 92915
 x3 43114	 x3 80920	 x4 94079	 x7 77515	 x2 124559	 x6 117451	 x4 43154	 x4 86989	 x4 60501	 x1 117835	 x2 140307
 x9 43168	 x16 92668	 x4 140241	 x1 124981	 x1 107858	 x1 140242	 x1 140243	 x1 140244	 x1 113535	 x1 92791	 x1 140306
 x1 92671	 x1 122049	 x8 124602	 x2 109913	 x6 89462	 x2 66934	 x4 93865	 x4 80003	 x4 62887	 x1 140246	 x1 140248
 x1 140249	 x2 87952	 x20 93960	 x1 44254	 x1 92890	 x1 103181	 x3 103180	 x1 71718	 x2 96384	 x6 121303	 x2 60889



x1
99247



x2
138135



x1
135953



x1
113555

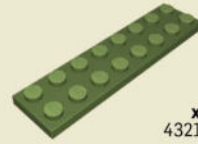

x1
43212



x1
92672

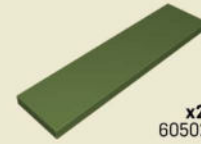

x2
60502



x2
124563



x2
126715



x2
101240

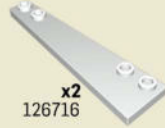

x2
126716



x1
140250



x2
140251



x1
92685



x1
95670



x2
121340



x2
104724



x2
92782



x1
92693

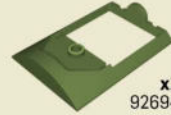

x1
92694

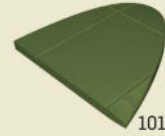

x1
101946



x2
92679



x1
99249



x1
58332



x4
80919



x2
98981



x2
140336



x2
140337



x2
133021



x3
100407



x2
54703



x2
85932



x2
93921



x2
92772



x1
85577

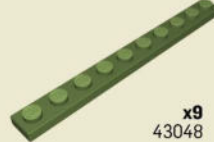

x9
43048

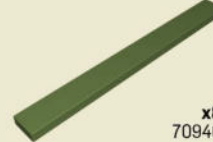

x8
70940



x14
43230

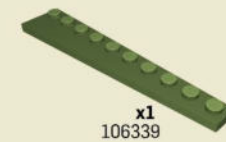

x1
106339

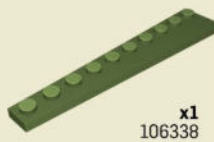

x1
106338



x1
80462



x1
80463



x1
92810



x1
122087



x1
139612



HISTORICAL COLLECTION



HMS HOOD
🇬🇧 4830

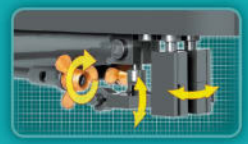
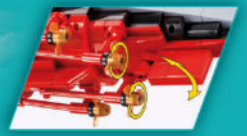

U-BOOT U-47 (TYP VII B)
⊕ 4828



HISTORICAL COLLECTION



HORCH830BK CABRIOLET
🇵🇱 🇩🇪 2262



CITROËN TRACTION 7A
🇫🇷 2263



POLISH ARMY 1939
🇵🇱 2049



RENAULT R35
🇫🇷 2553



CITROËN TRACTION 7C
🇫🇷 2264



JAGDPANZER 38(t) "HETZER"
+ 2558



BLITZ 3,6-365
+ 2259



PzKpfw VI TIGER „131”
+ 2556



DE GAULLE'S HORCH 830 BL
🇫🇷 🇩🇪 2261



DEUTSCHES
PANZERMUSEUM
MUNSTER



LEOPARD 2A5 TVM

2620



LOCKHEED MARTIN®, F-16®C Fighting Falcon®, associated emblems and logos, and body designs of vehicles are either registered trademarks or trademarks of Lockheed Martin Corporation in the USA and/or other jurisdictions, used under license by COBI.



F-16®C FIGHTING FALCON®

5814

NORTHROP
GRUMMAN

A10-THUNDERBOLT II™ WARTHOG® are trademarks of Northrop Grumman Systems Corporation and are used under license by „Cobi“.



A-10 THUNDERBOLT II™
WARTHOG®

5812



Produced under license from Boeing. Boeing, AV-8B Harrier II PLUS, the distinctive Boeing logos, product markings and trade dress are trademarks of The Boeing Company.



AV-8B HARRIER II™ PLUS

5809



HISTORICAL COLLECTION



MORANE-SAULNIER MS.406
🇫🇷 5724



DE HAVILLAND MOSQUITO FB MK. VI
🇬🇧 5718



DEWOITINE D.520
🇫🇷 5720



VICKERS WELLINGTON MK II
🇬🇧 5723



WWW.COBI.EU

01-05726-537

For news and special deals

Find us on:
f cobr.bricks
i cobr.klocki
y COBI SA