

HISTORICAL COLLECTION

WORLD WAR II



KAWASAKI KI-61-I HIEN (TONY)
PLACE OF ORIGIN - JAPAN
IN SERVICE - 1943 - 1945
ROLE - FIGHTER
CREW - 1
WINGSPAN - 12M (39' 4")
LENGTH - 8,9M (29' 4")
HEIGHT - 3,7M (12' 2")
WEIGHT - 2 630KG (5 800LB)
ENGINE - KAWASAKI HA40 V-12, 864KW (1 159HP)
RANGE - 580KM (360MI)
RATE OF CLIMB - 15,2M/S (2 990FT/MIN)
MAXIMUM FLIGHT LEVEL - 10 000M (32 800FT)
ARMAMENT - 2x 20MM (.787") MG 151 CANNONS
2x 12,7MM (.50") HO-103 MG,
BOMBS / EXTERNAL FUEL TANK
SPEED - 560KM/H (348MPH)

5740

PAD PRINTED
NO STICKERS

Printed in EU



WARNING: CHOKING HAZARD-
Toy contains small parts.
Not for children under 3 years.

324 1

KAWASAKI KI-61-I HIEN (TONY)

SCALE 1:32

1



x2



x2



x2

2

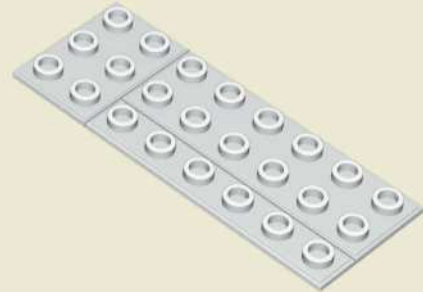
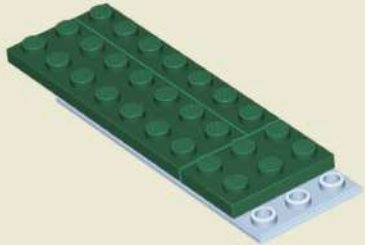

x2



x2



x2

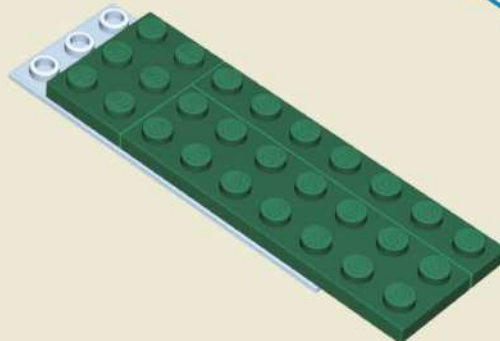

3

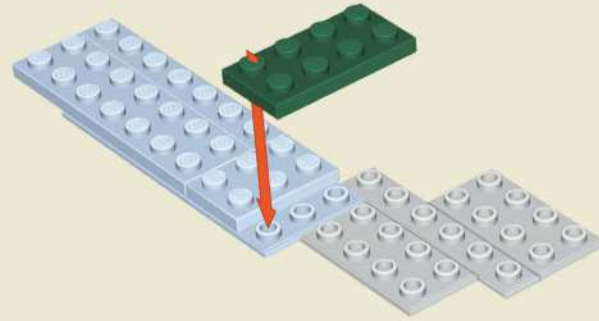

4

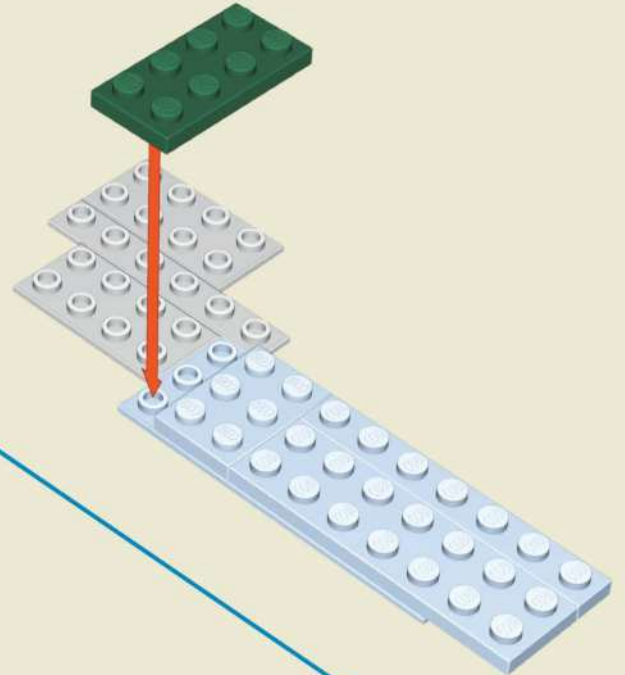
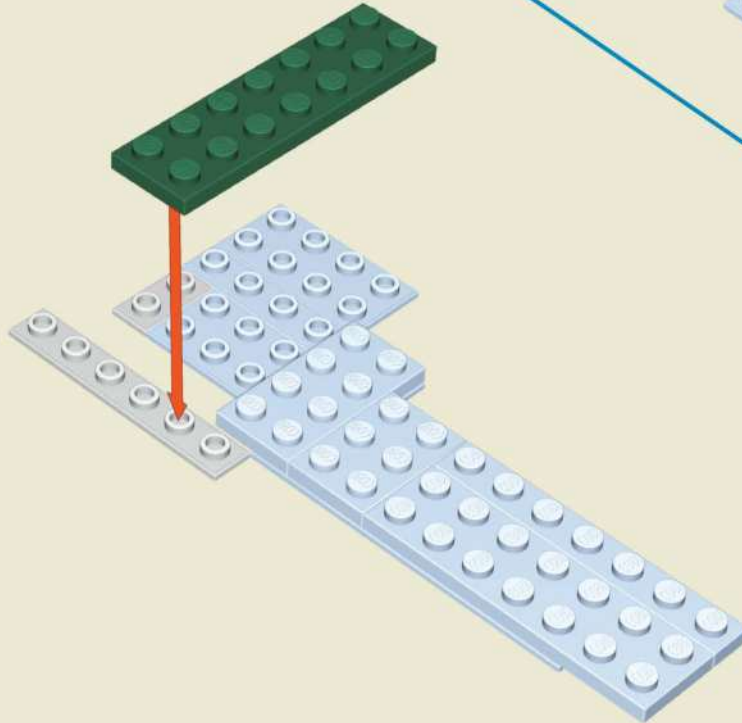
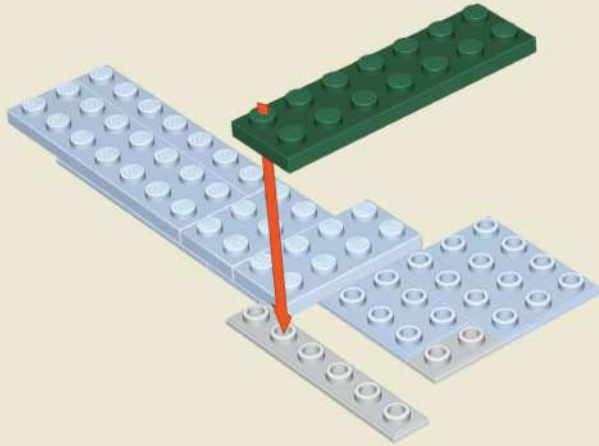

5

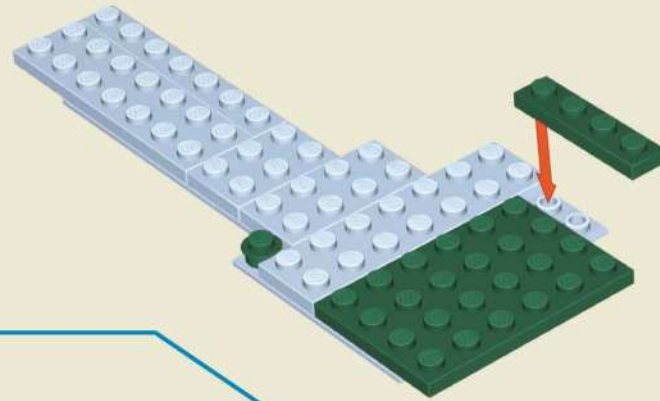

6

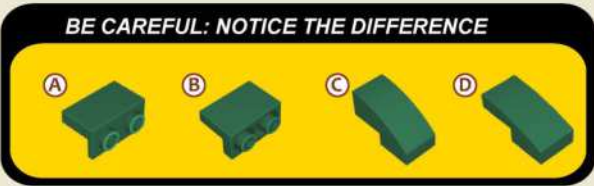
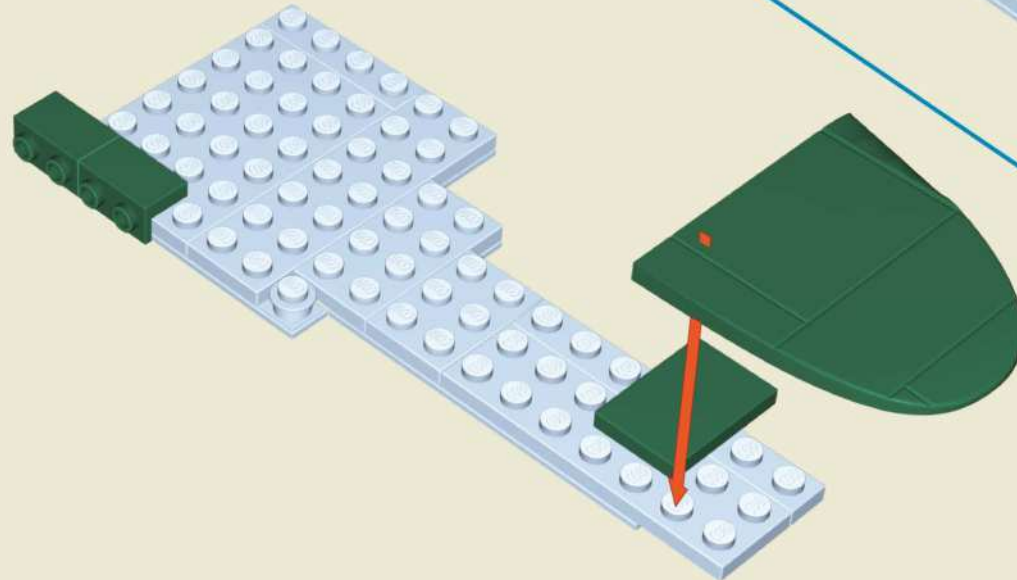
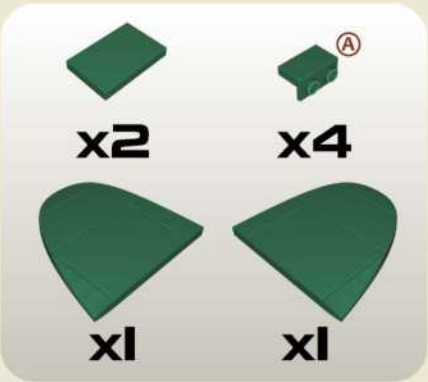
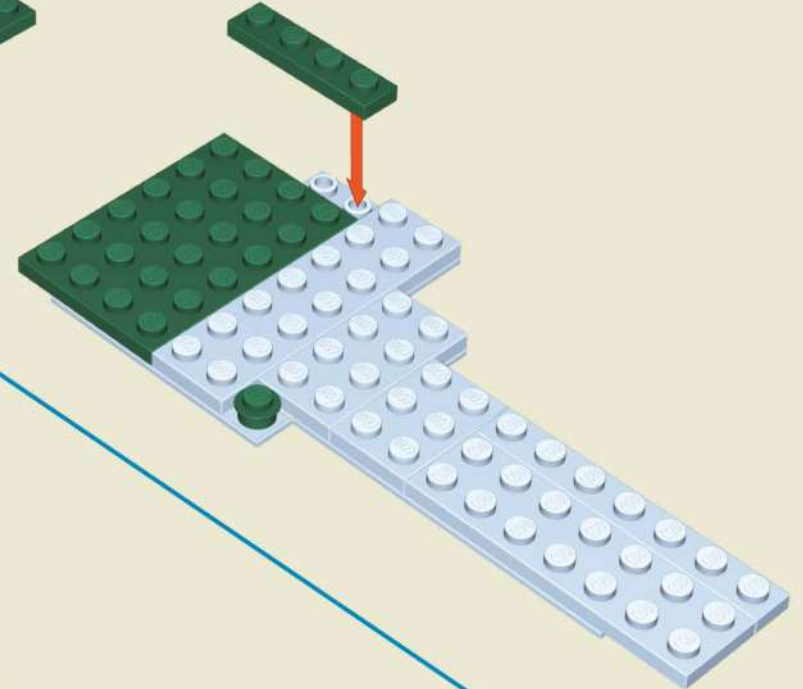
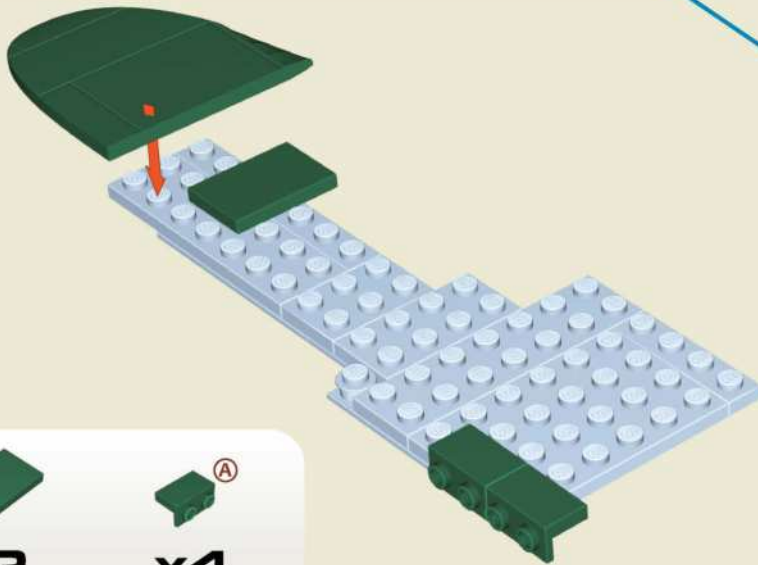

7

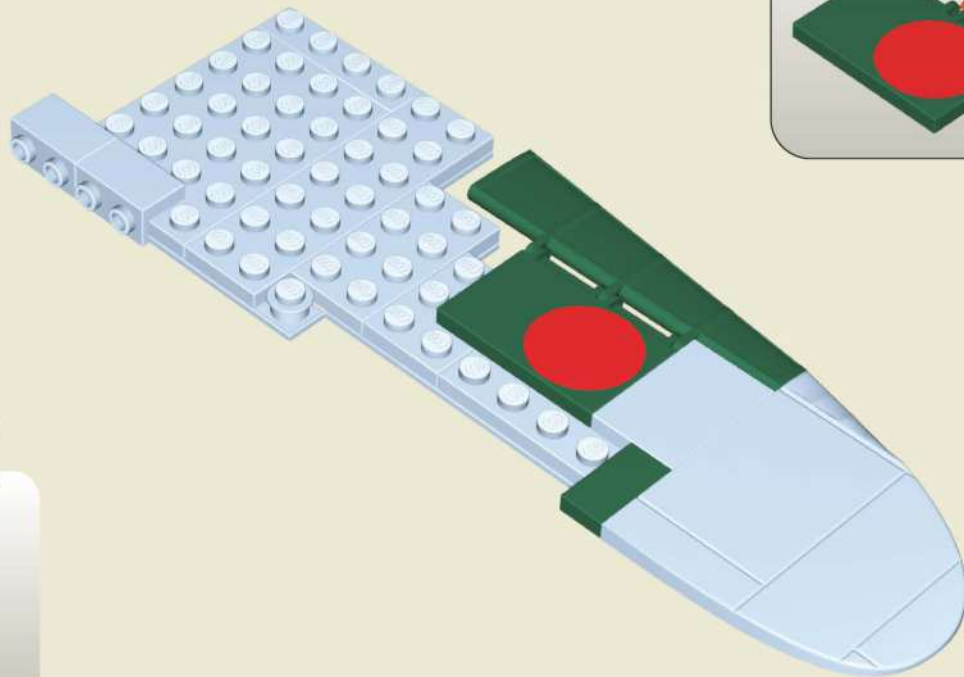
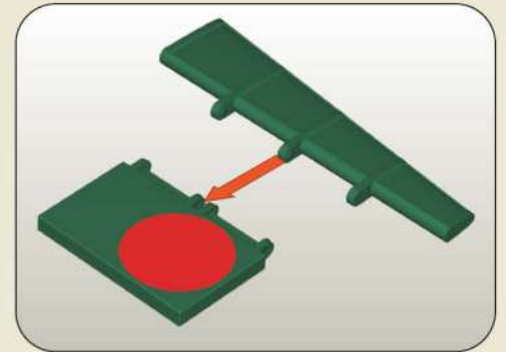
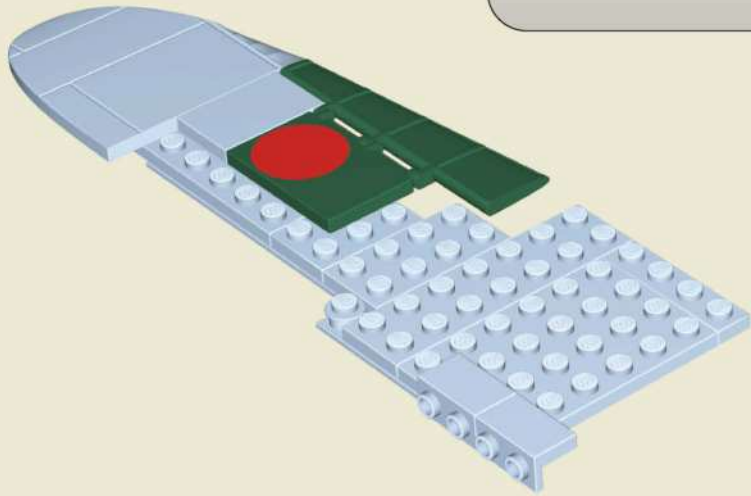
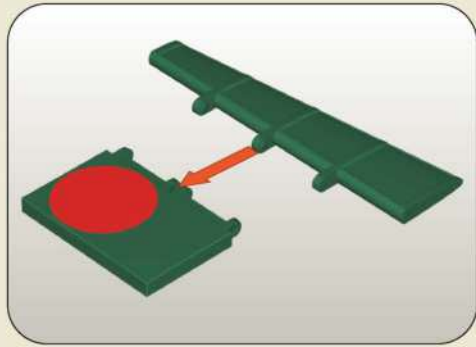

1:1



x1



x1







x2

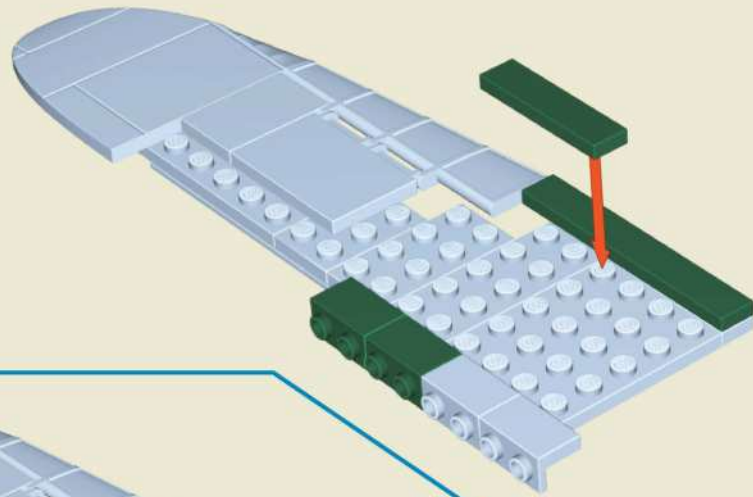

x1

8





 **x4**
 **x1**
 **x2**
 **x2**

1:1

1:1

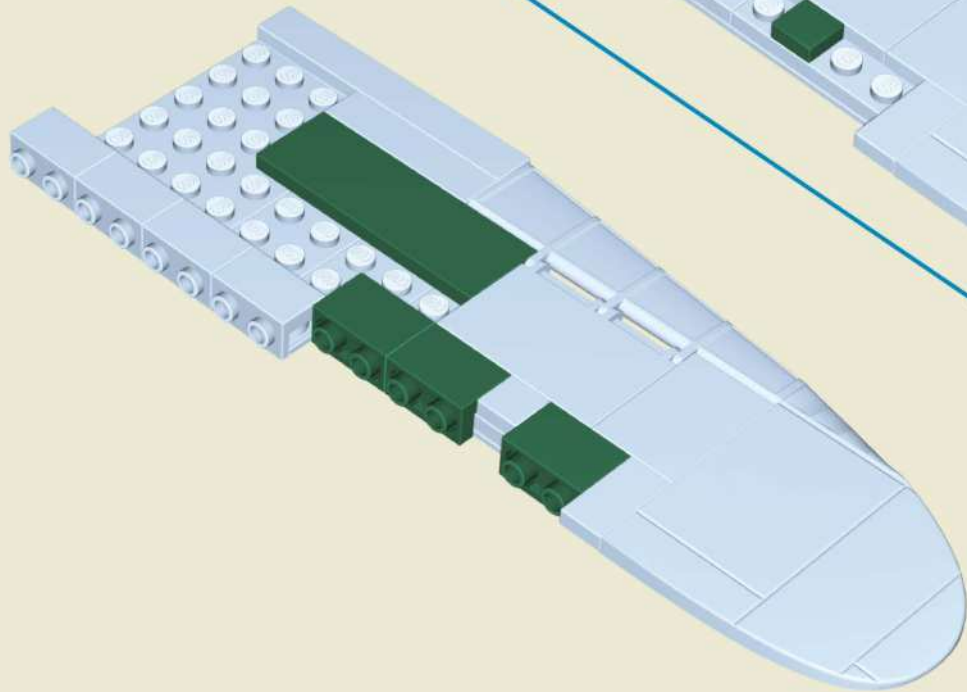
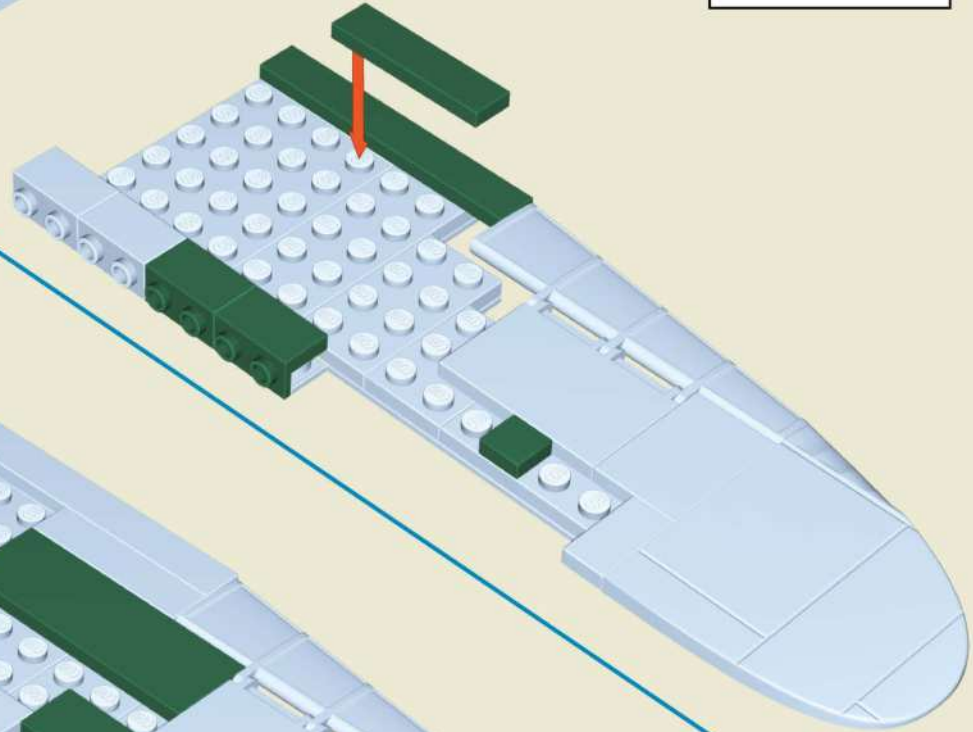
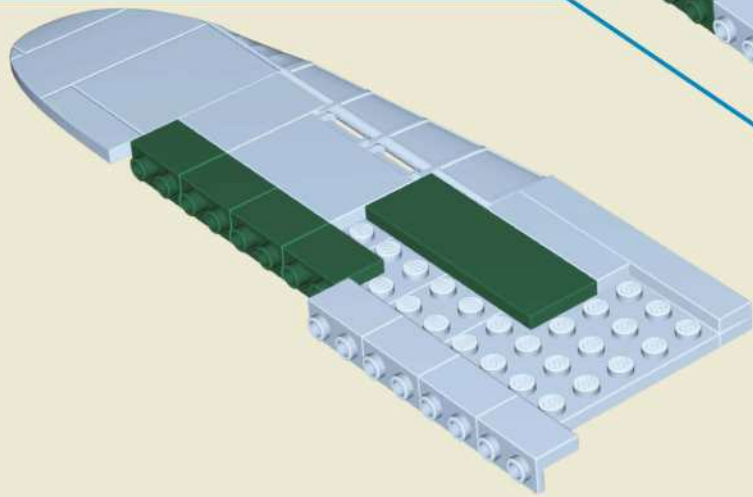

9

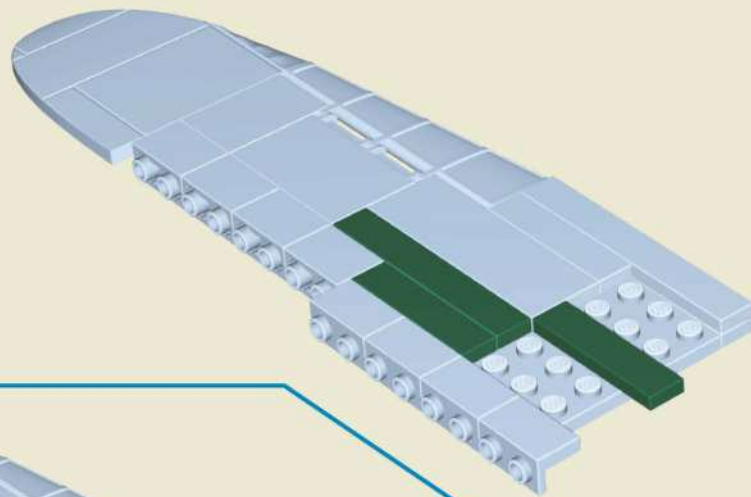

 **x7**
 **x2**

10





 **x4**  **x2**

1:1

1:1

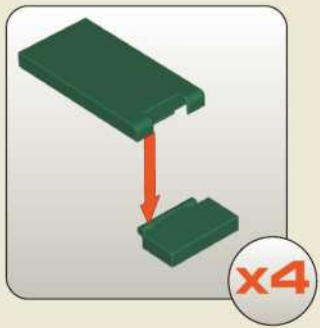
11



 **x2**  **x4**  **x4**



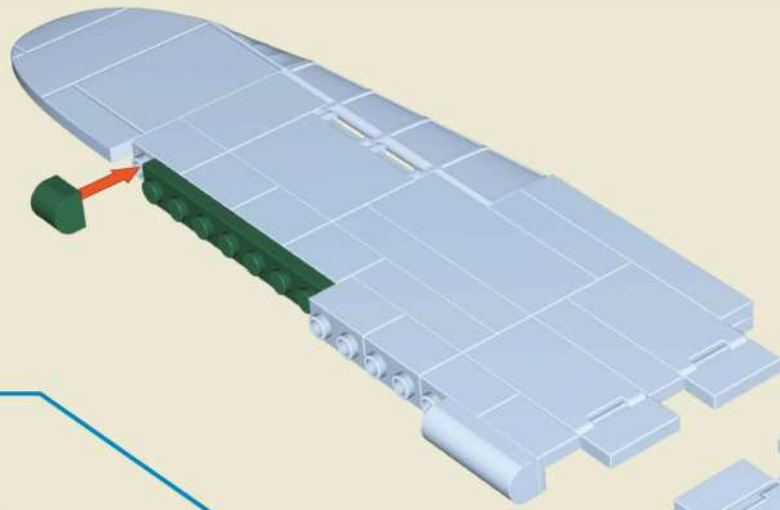

12

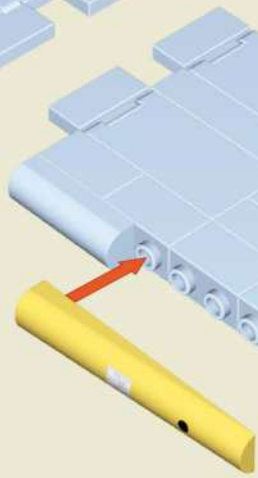
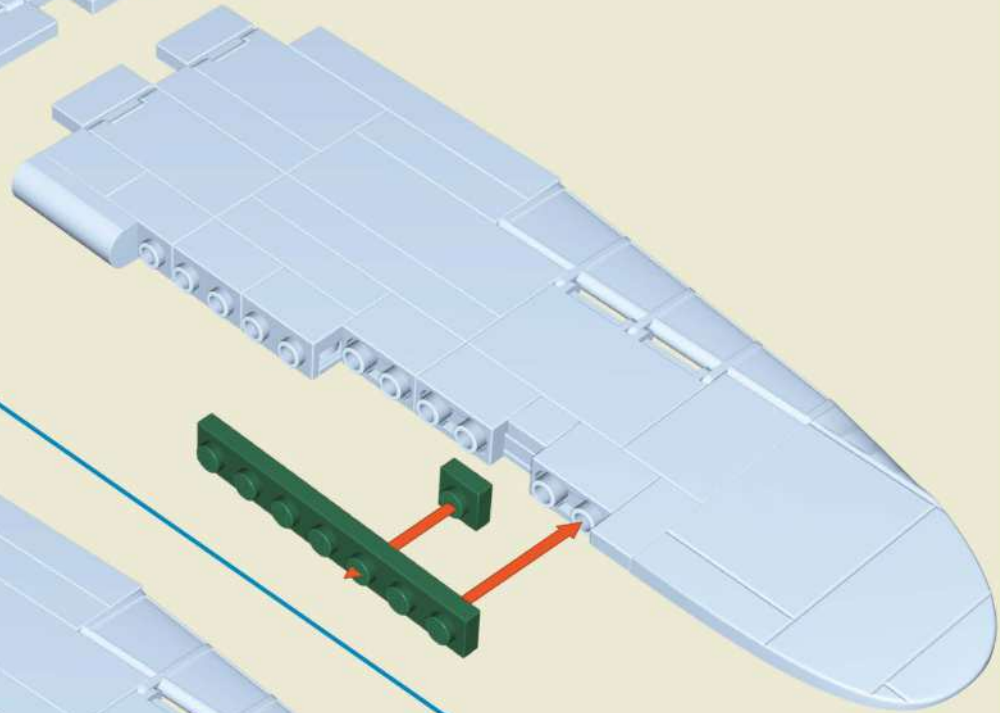
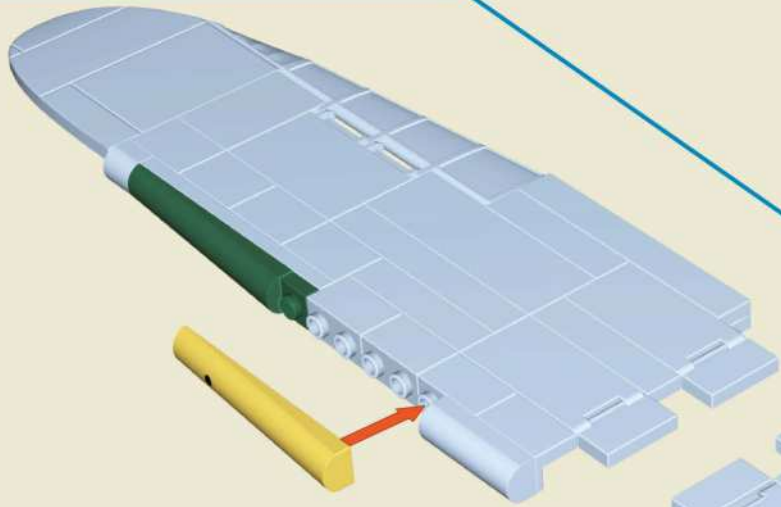

 **x1**
  **x2**
  **x1**





13

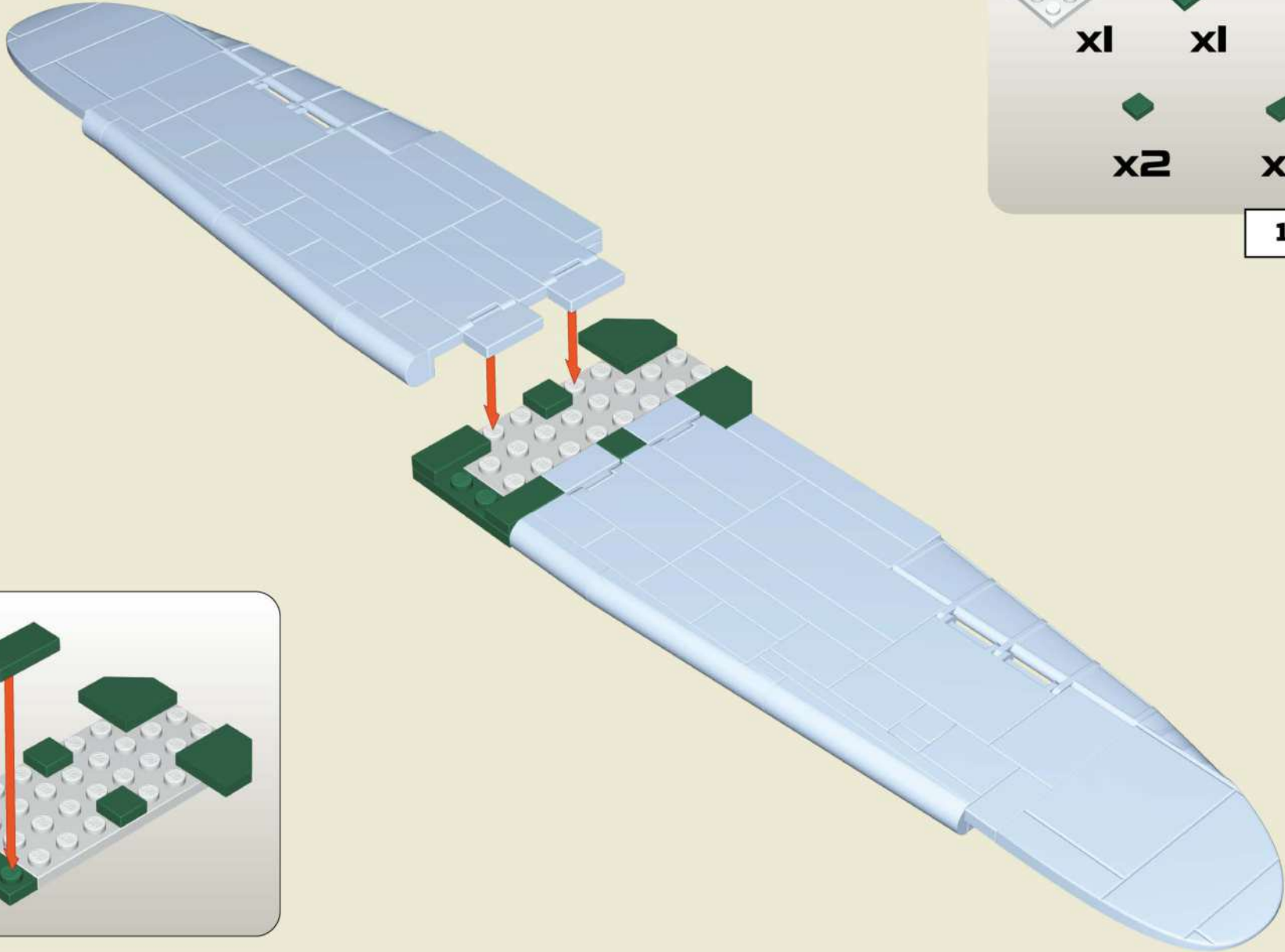

 **x2**
  **x2**
  **x1**
  **x1**

14



		
x1	x1	x2
		
x2	x2	

1:1

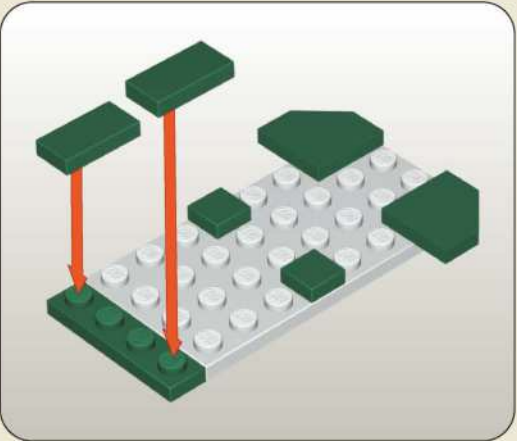

15

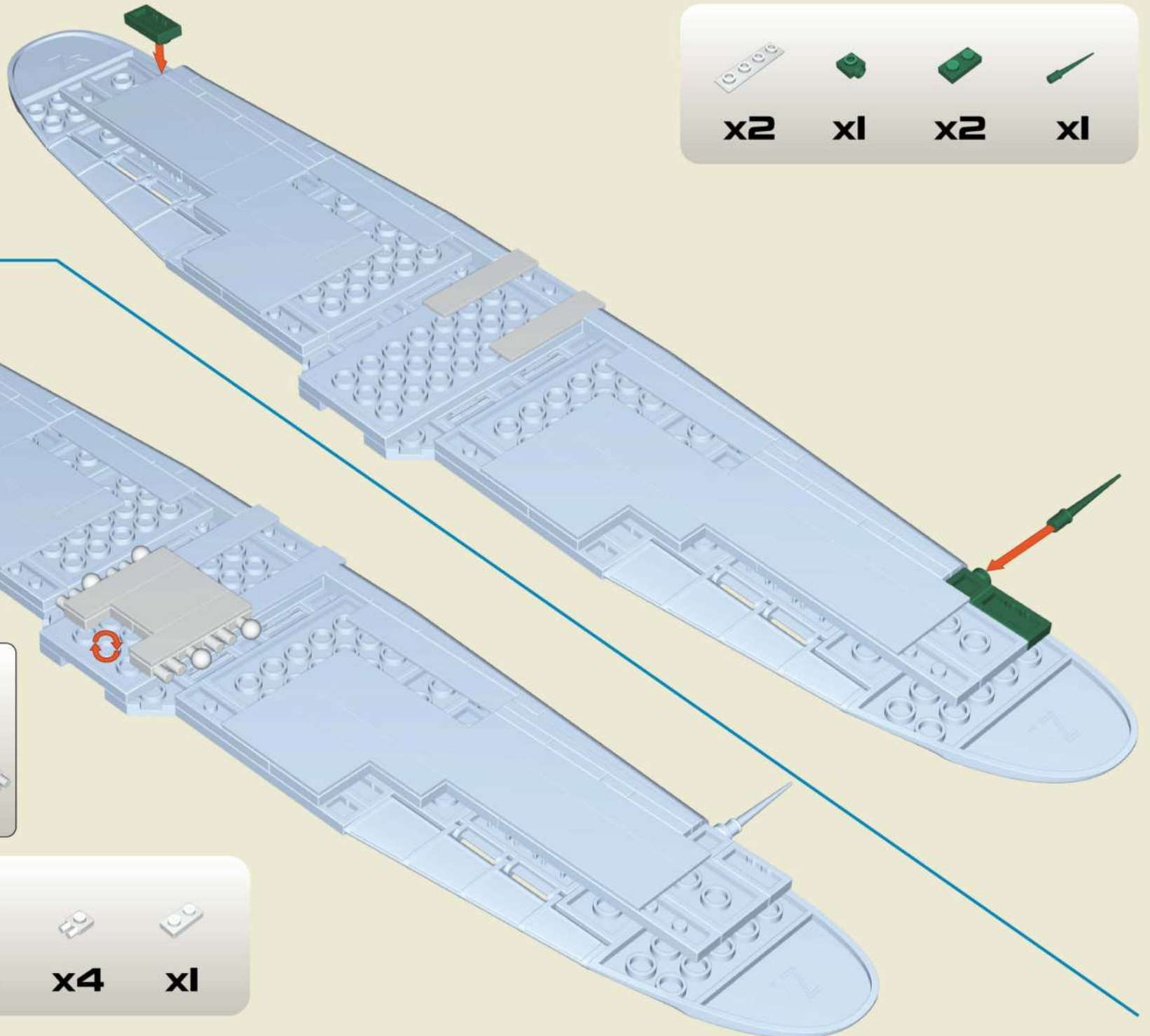





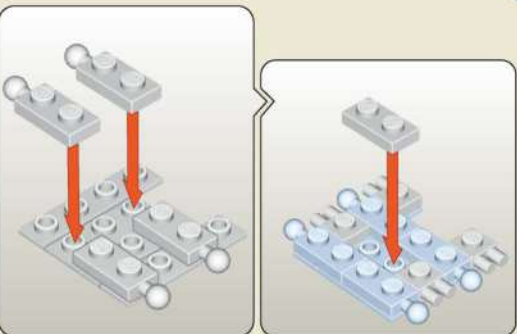

x2	x1	x2	x1

16



x1	x2	x4	x4	x1

17

					
x2	x4	x1	x3	x1	x1
1:1					

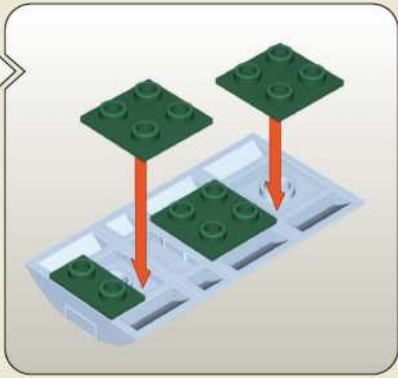
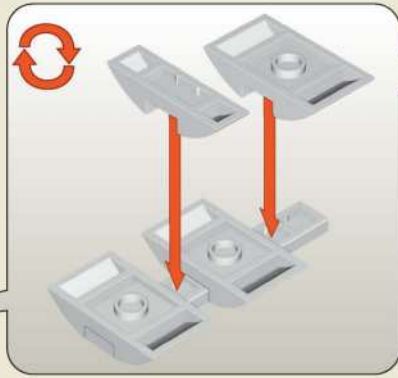
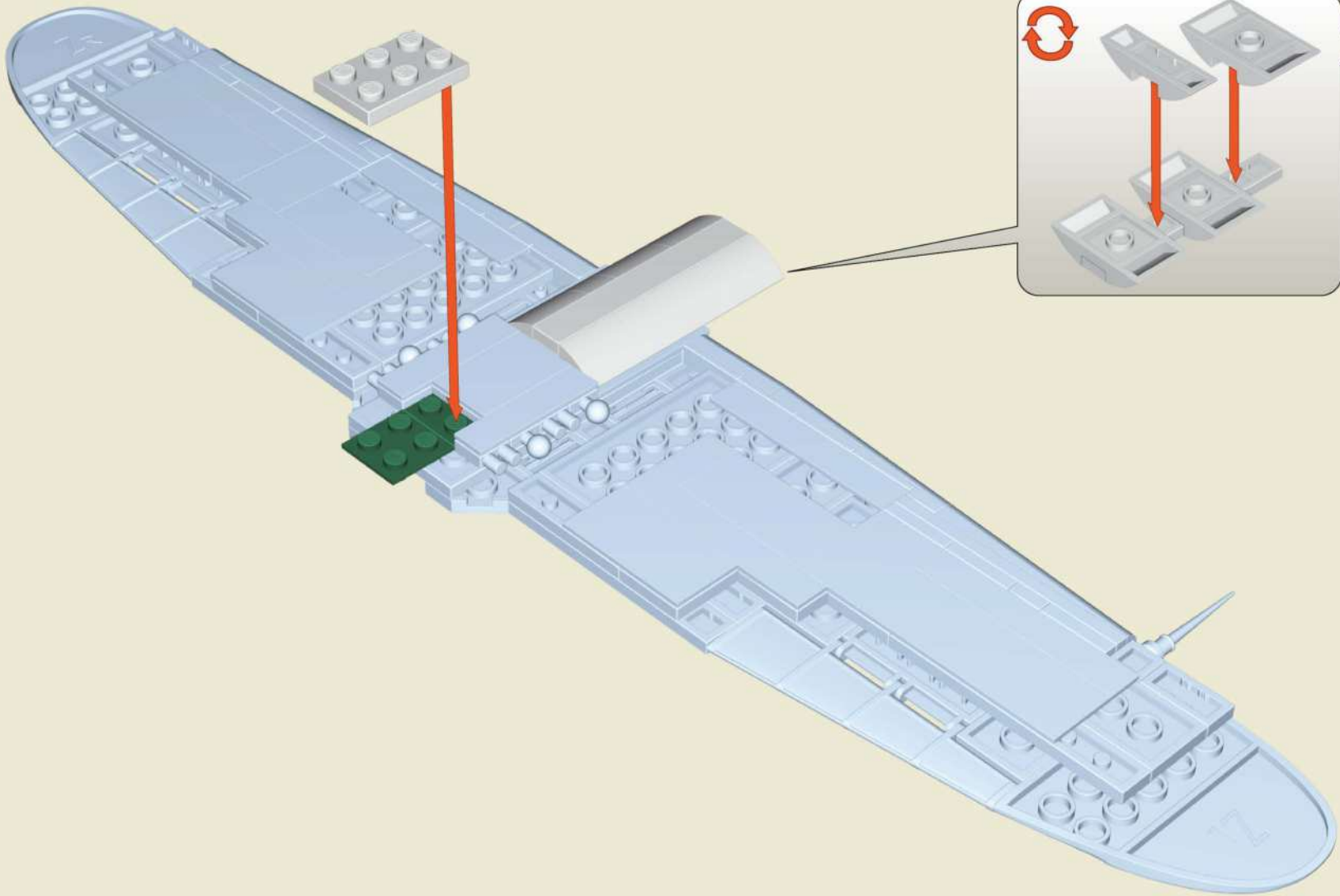

18

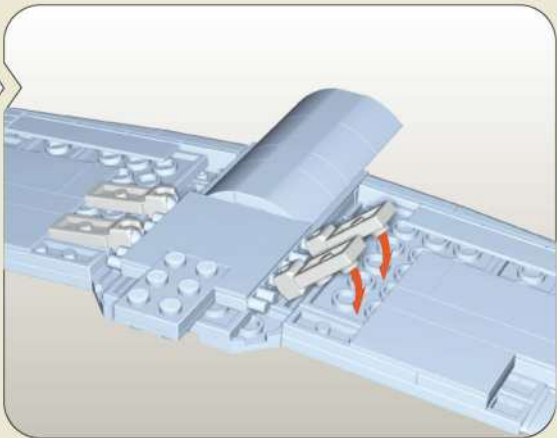
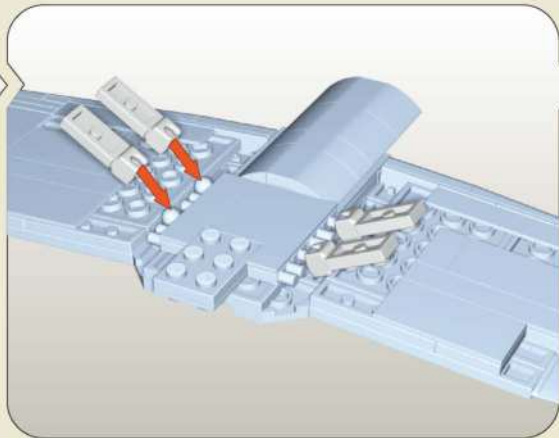
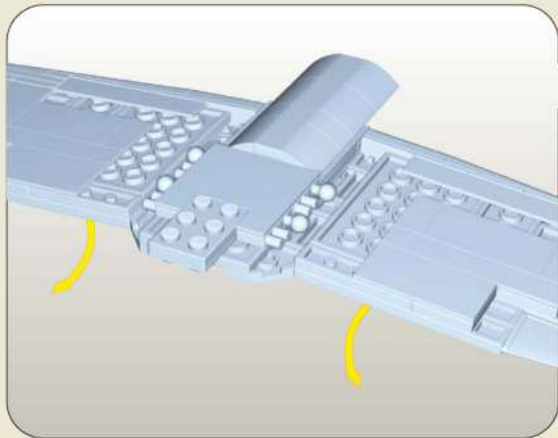

-  x4
-  x4
-  x2

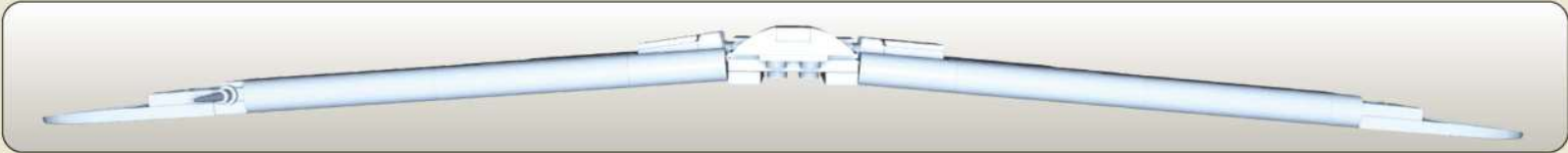
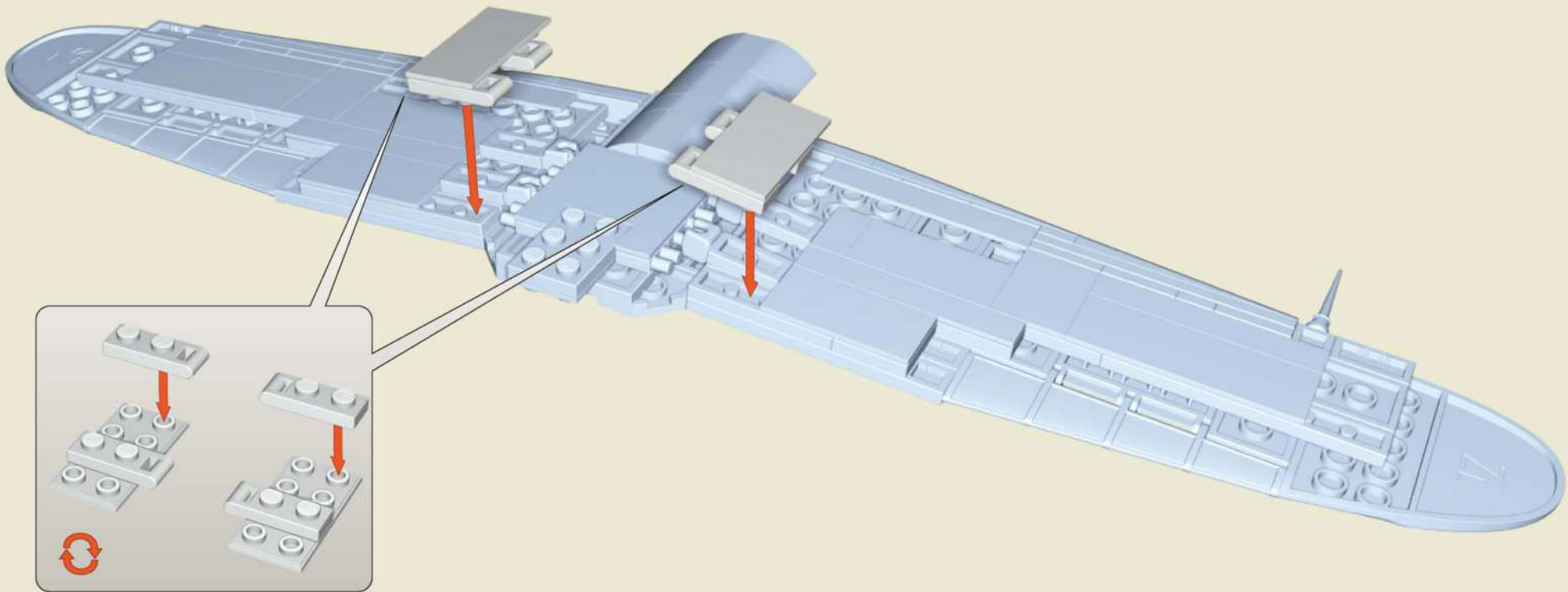

19

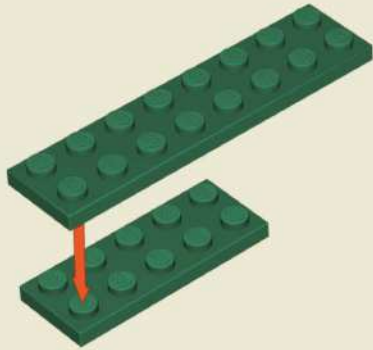

x1



x1

20

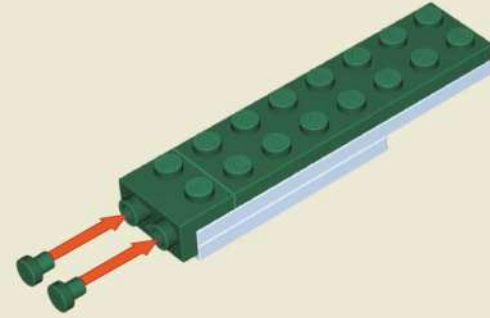

x1



x1



x2

21

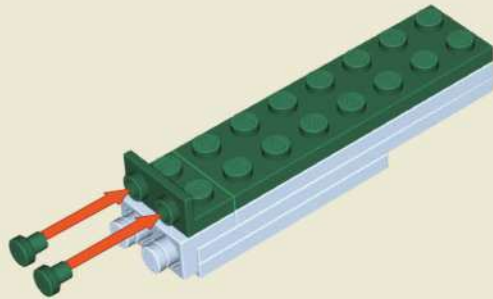

x1



x1



x2

22

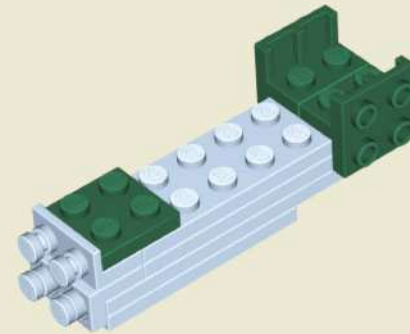



x2







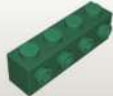

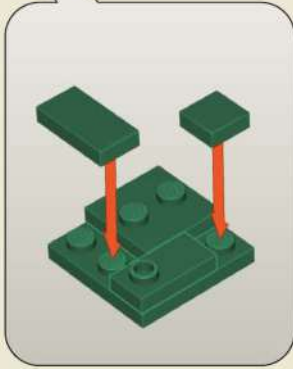
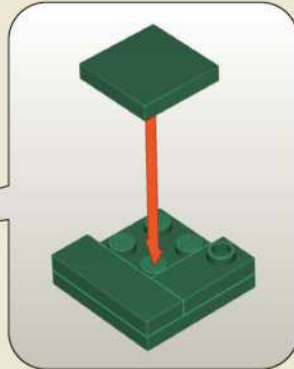
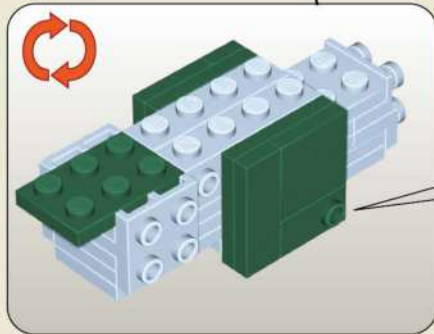
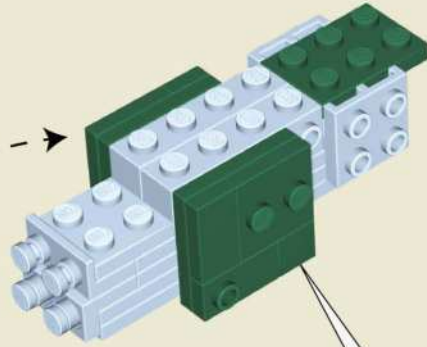
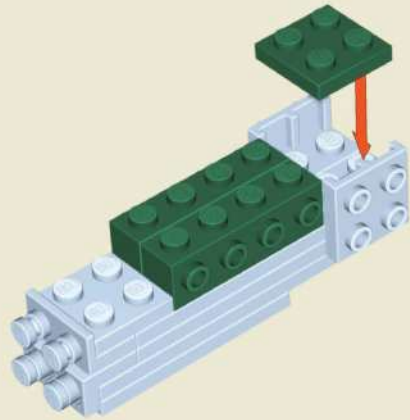

x1

23

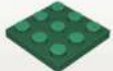
24



x2 **x1**



			
x1	x2	x2	x1
			
x1	x1	x1	x1

1:1

1:1

25

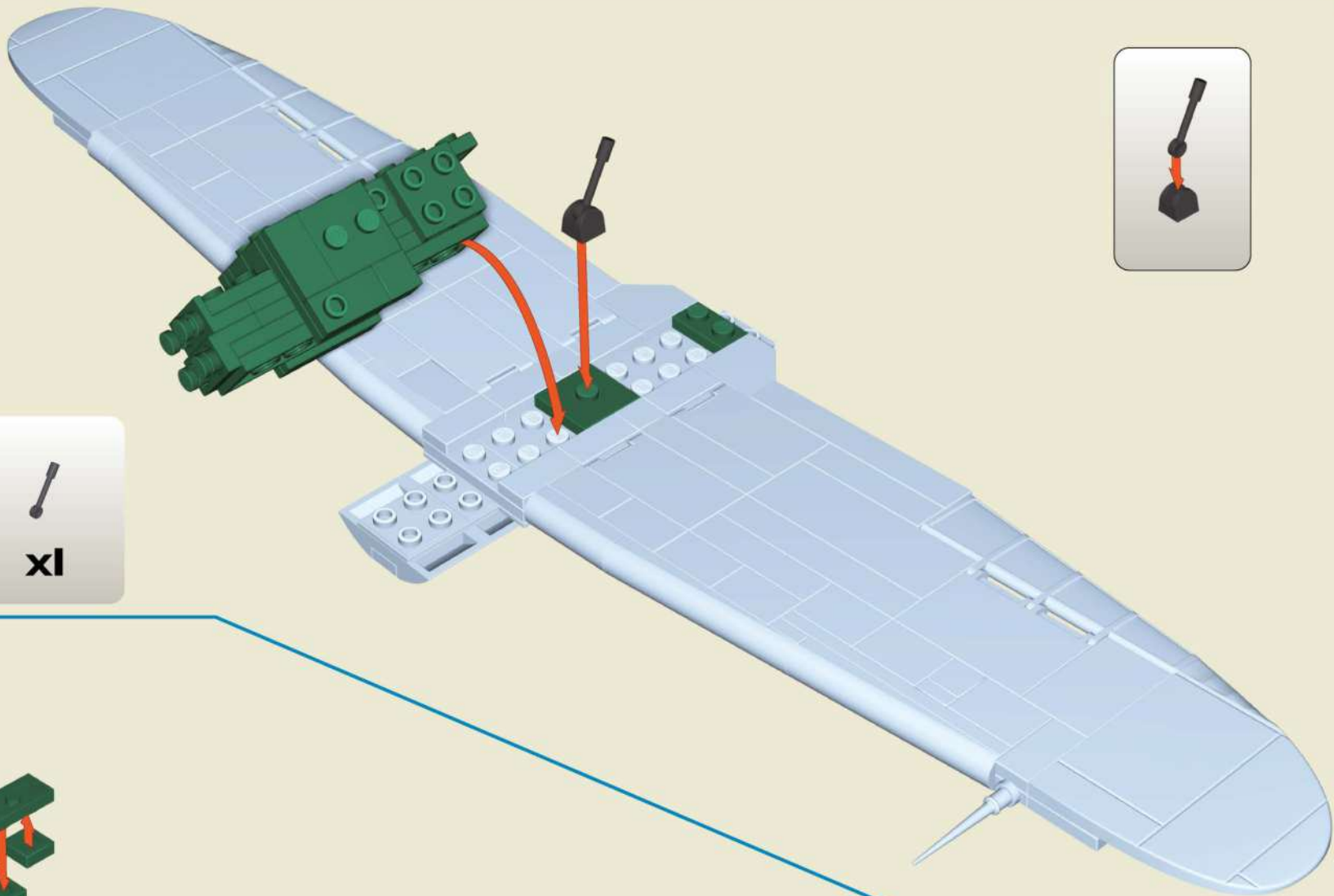

x1	x1	x1	x1

26

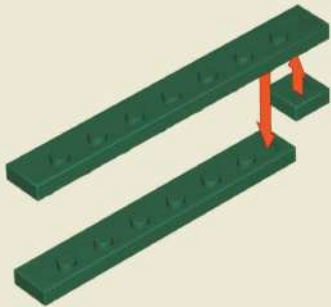

x1	x1	x1

27

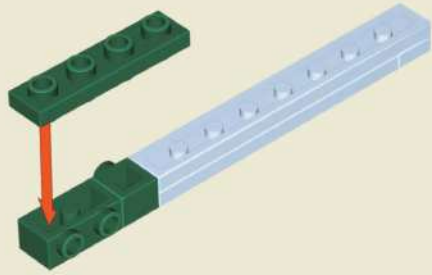

28

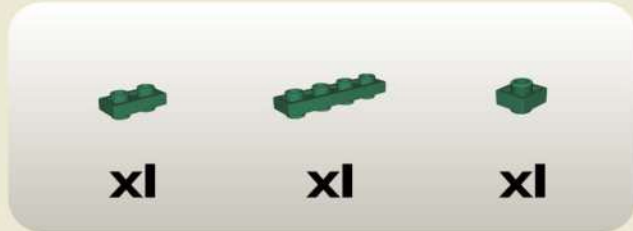
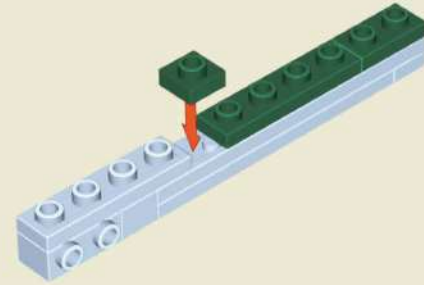

29

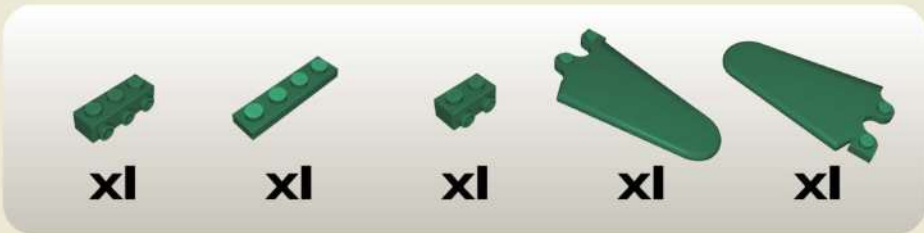
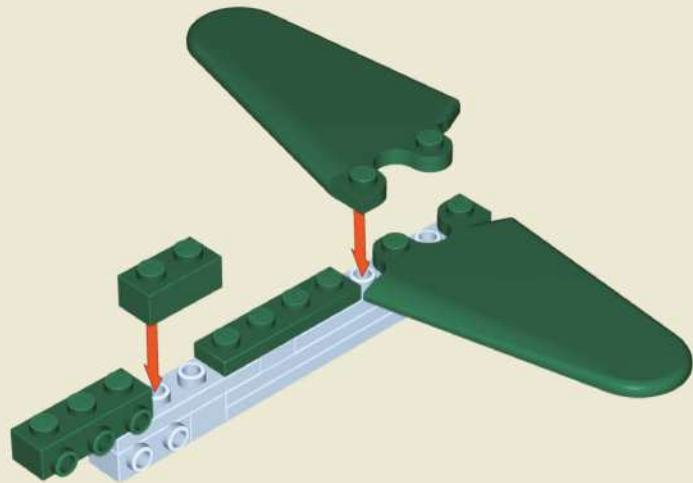

30

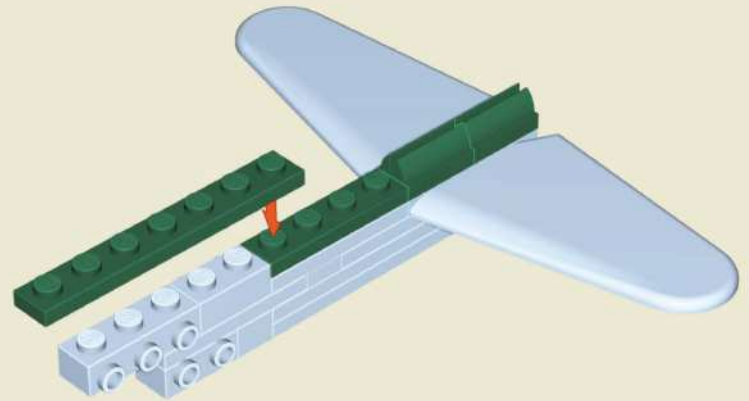

31

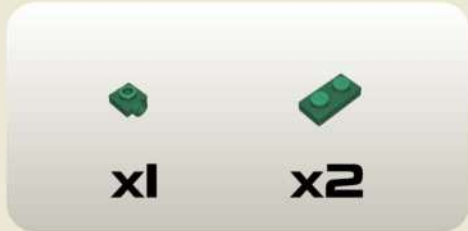
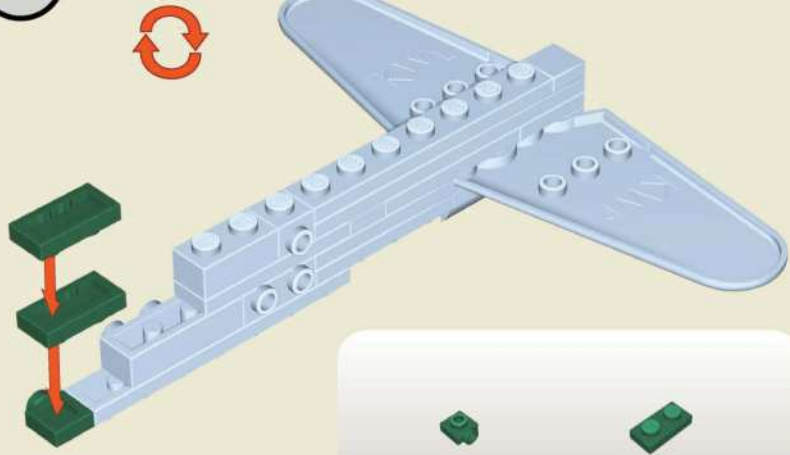

32

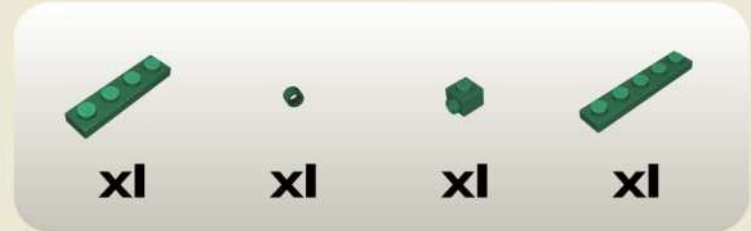
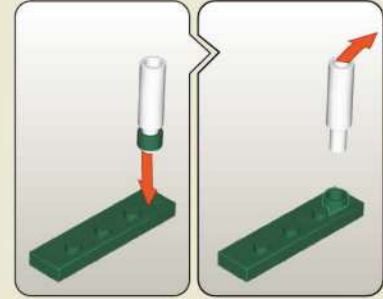
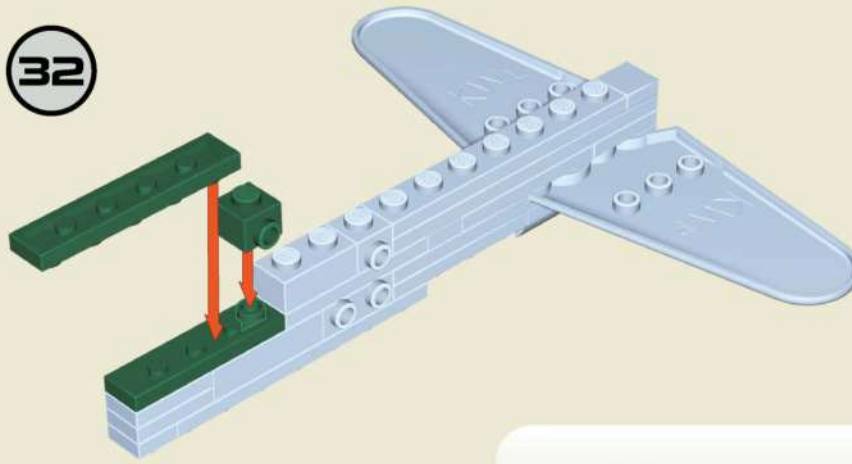

33

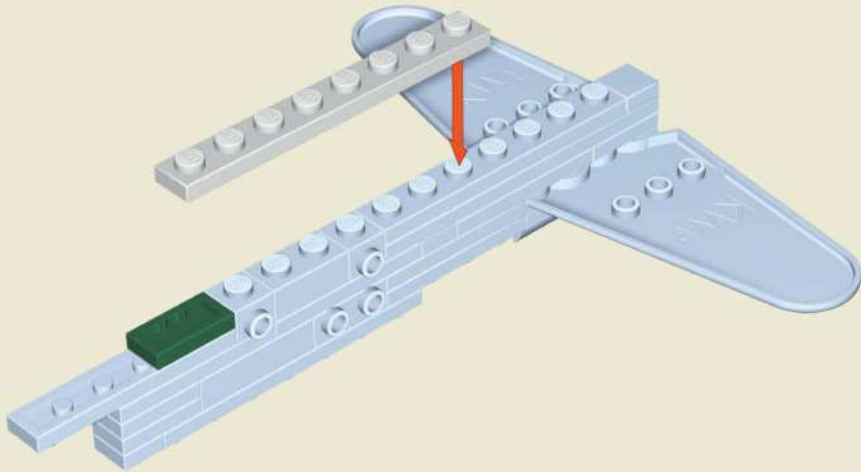

34

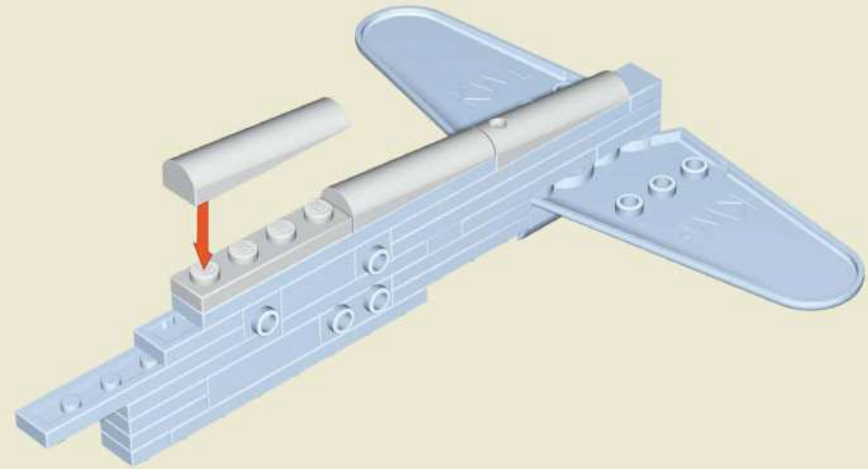

35

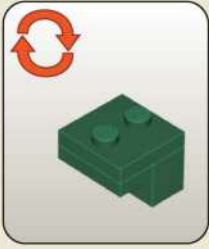
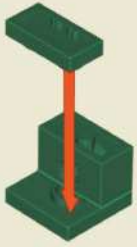

x1



x1



x1

36

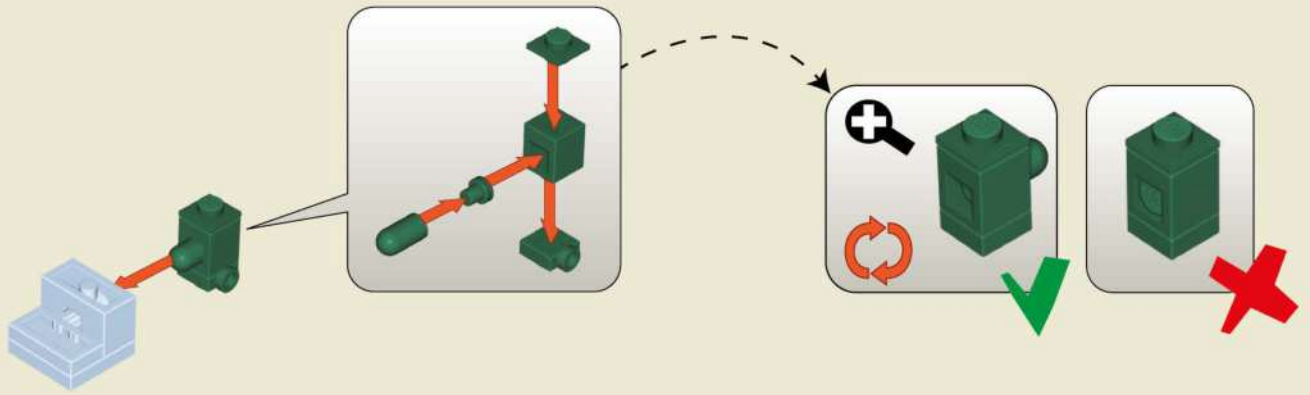

x1



x1



x1



x1



x1

37

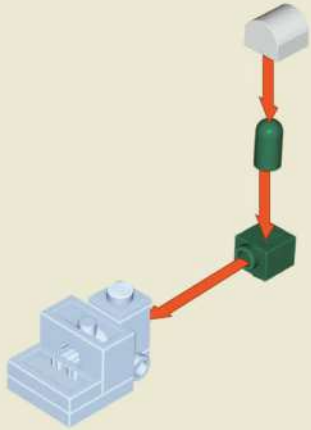

x1



x1



x1

38

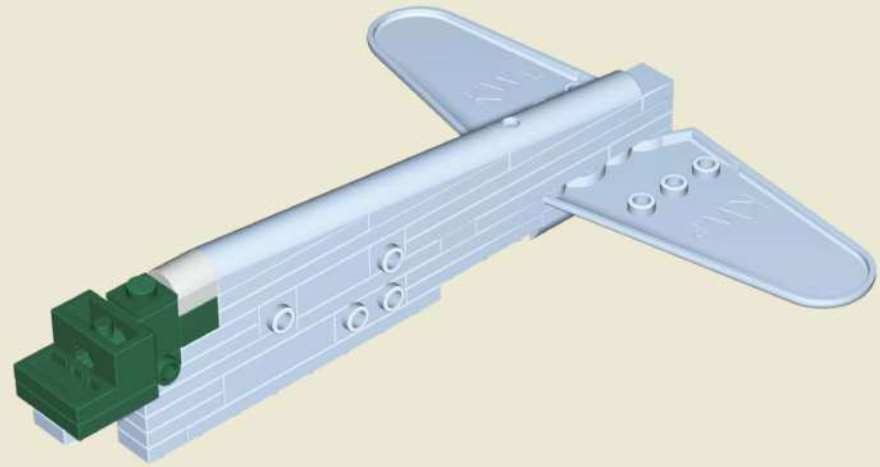

39

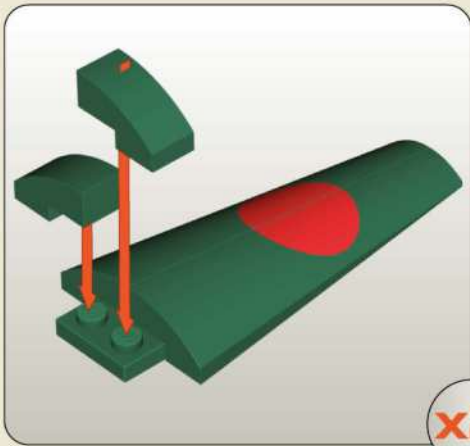

x2

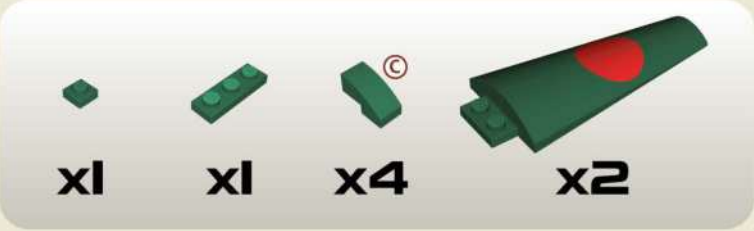
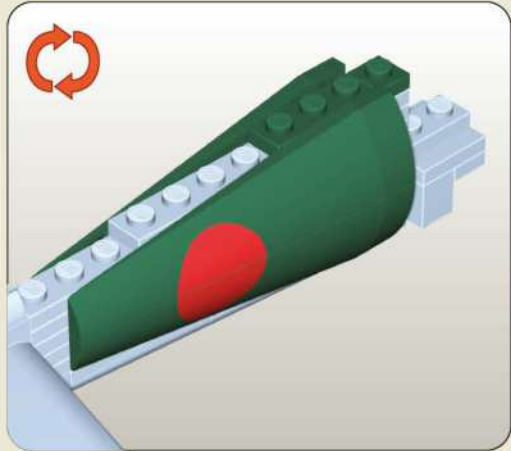
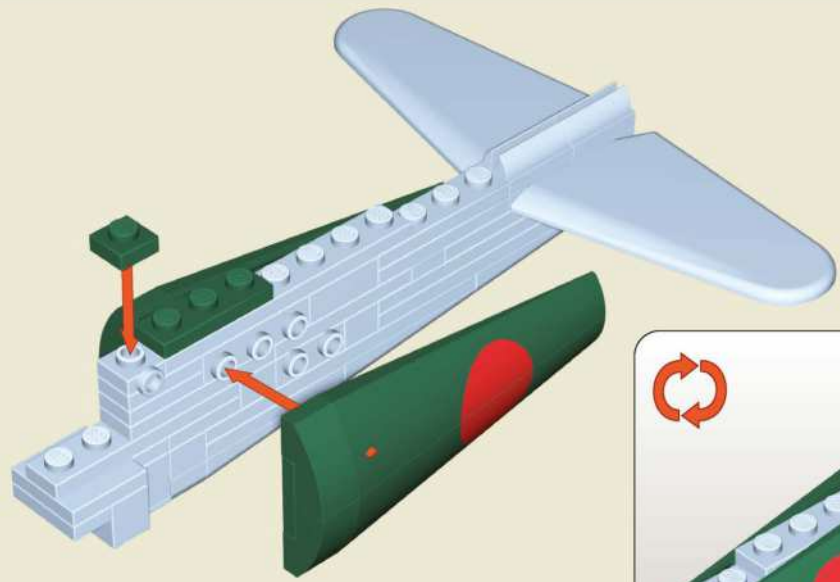

40

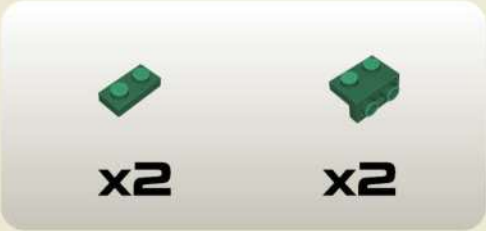
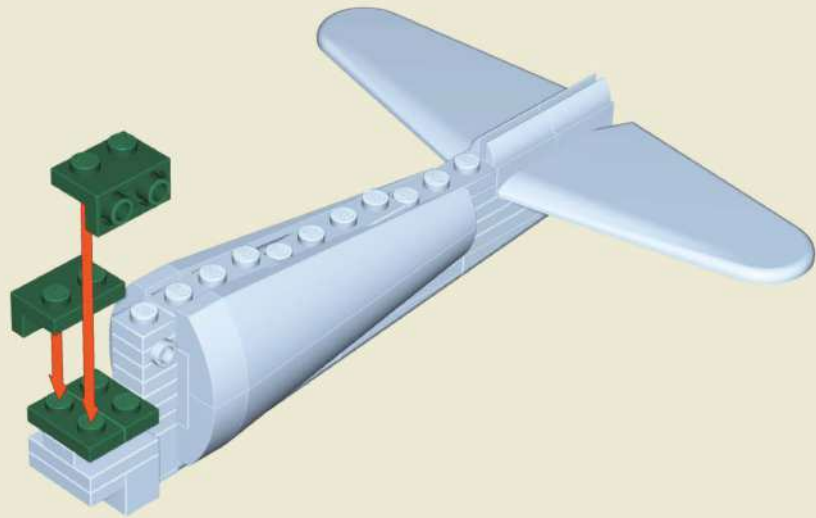

41

42

- | | |
|---|---|
|  |  |
| x2 | x2 |
|  |  |
| x4 | x2 |

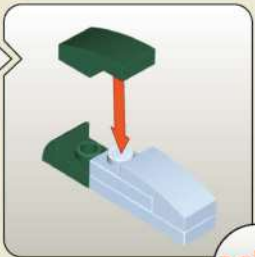
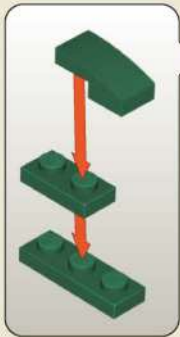
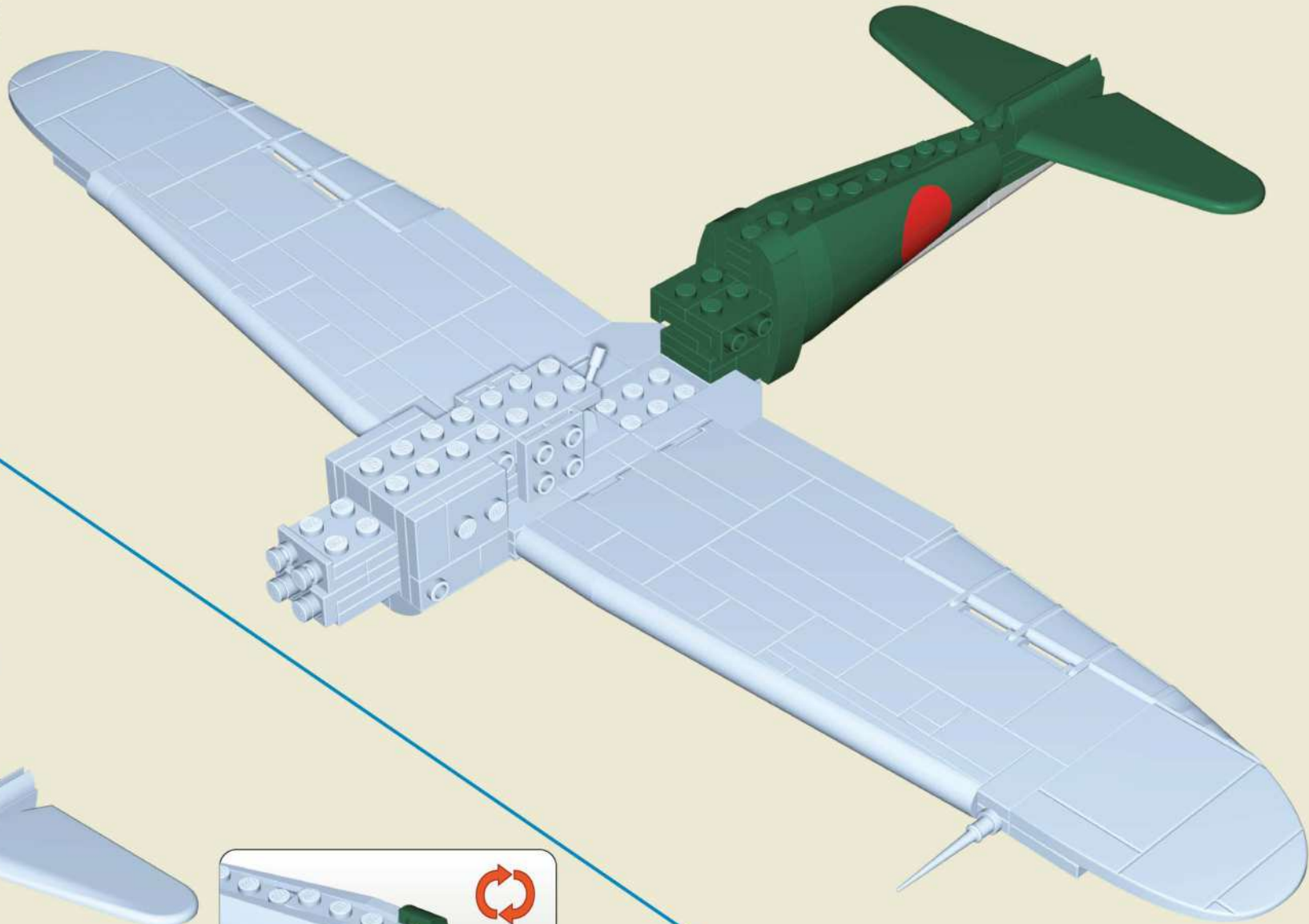

x2

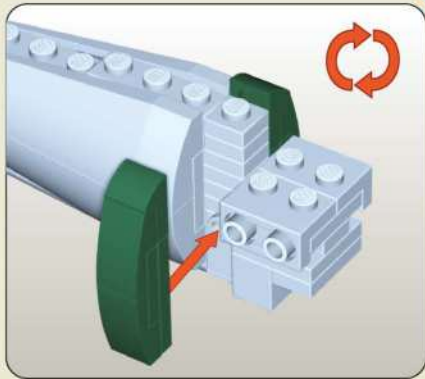
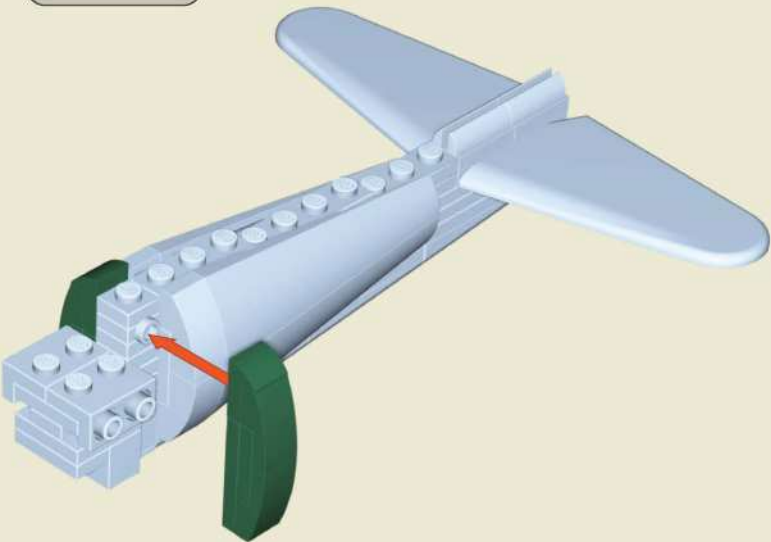

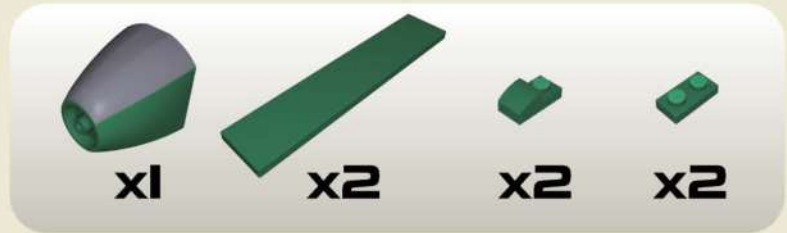
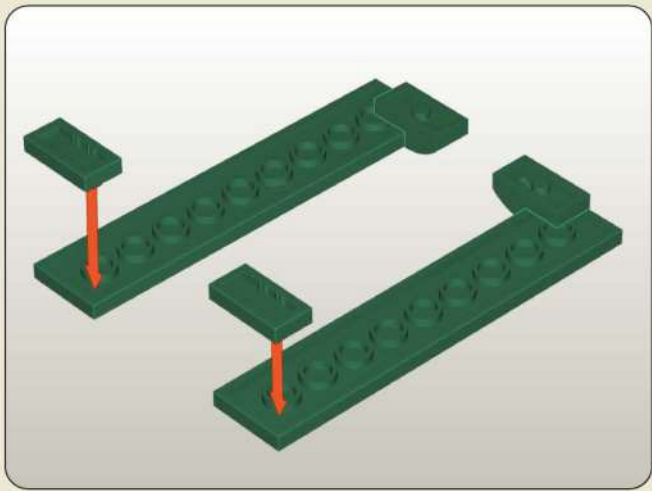
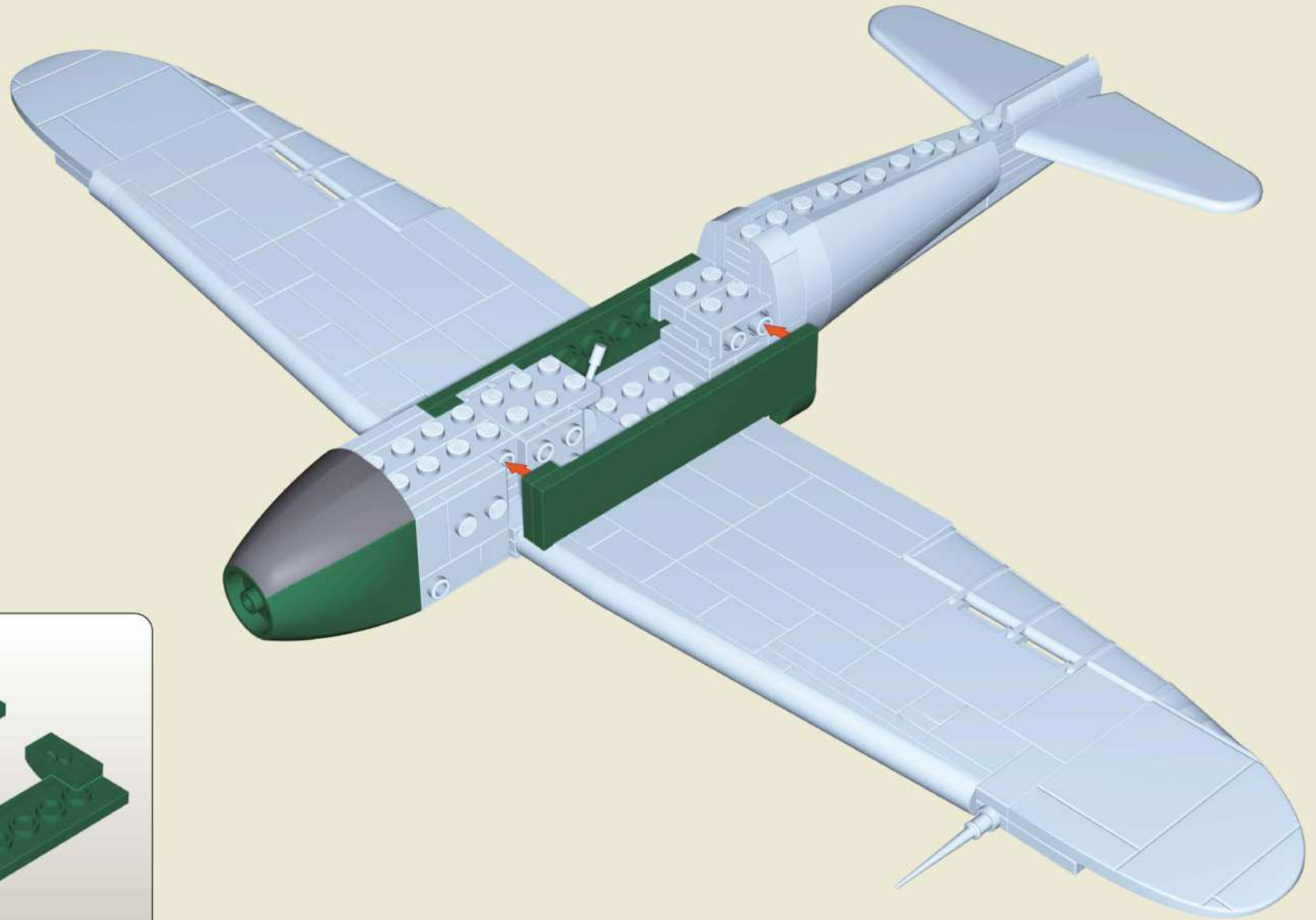



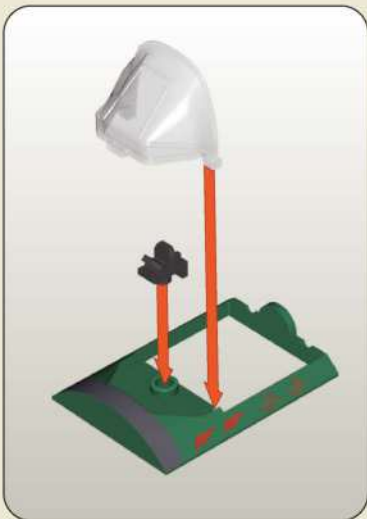
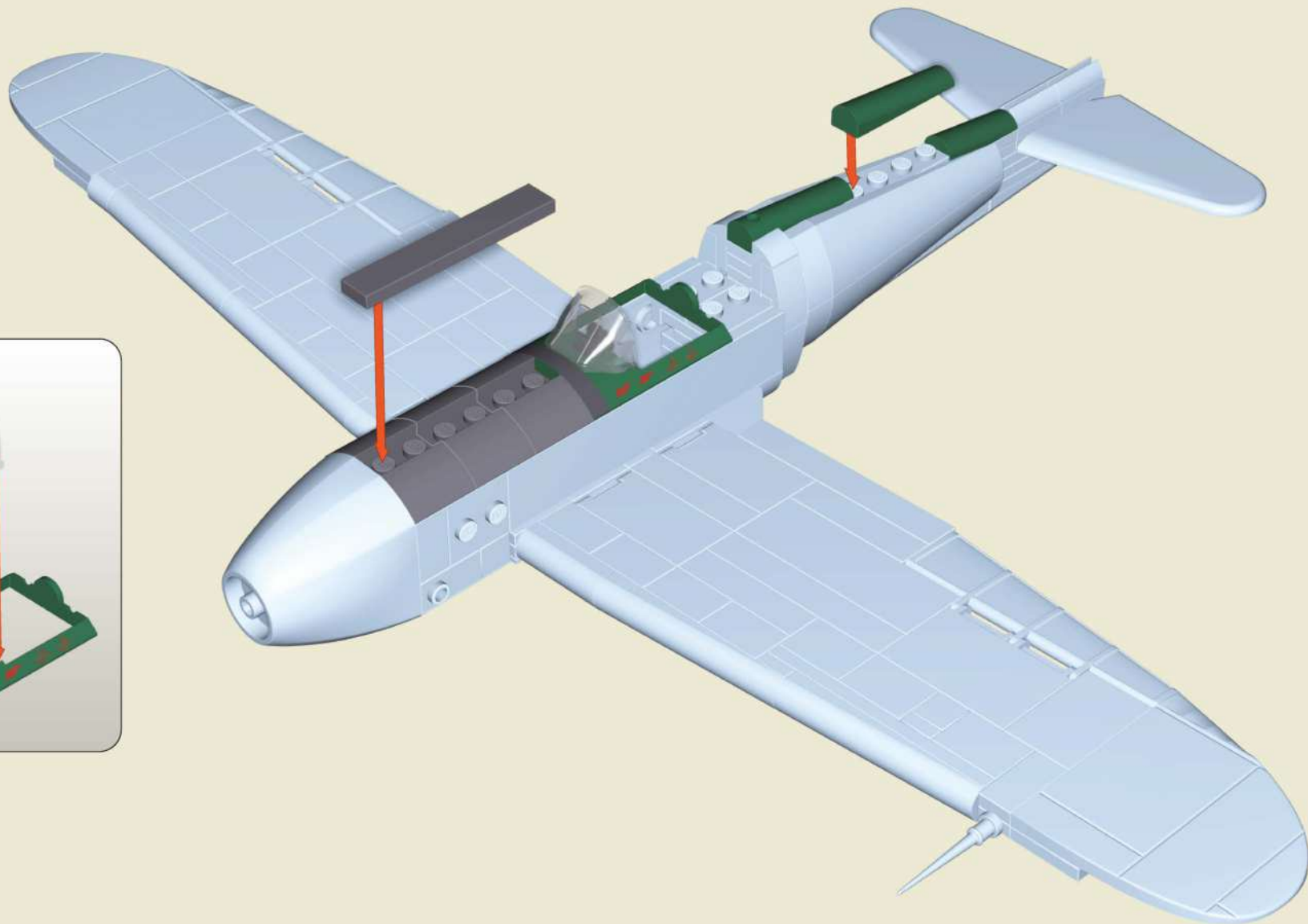



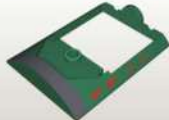

44



1:1

-  **x1**
-  **x1**
-  **x1**
-  **x3**
-  **x1**
-  **x1**
-  **x1**
-  **x1**

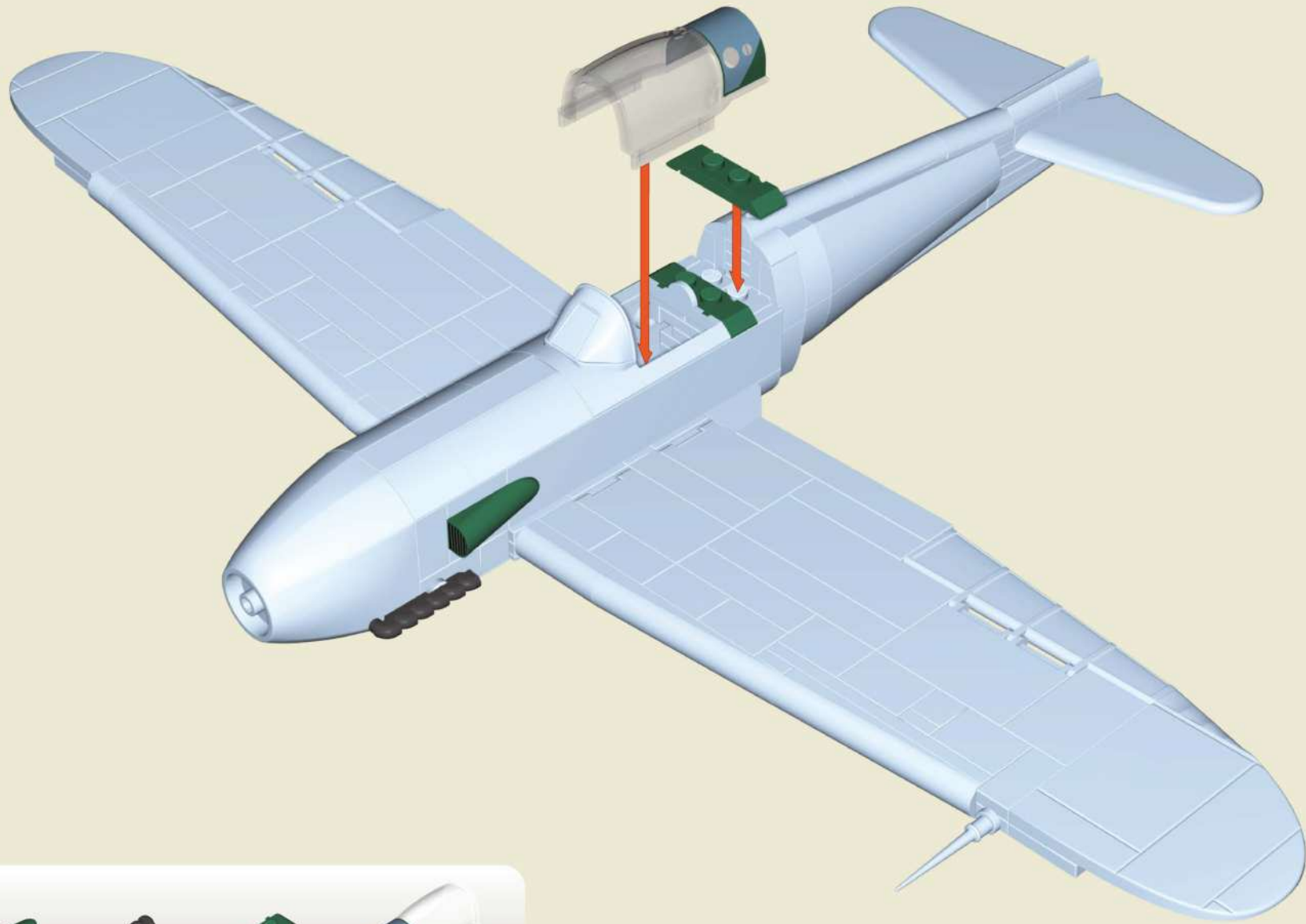

x1



x1



x2



x1

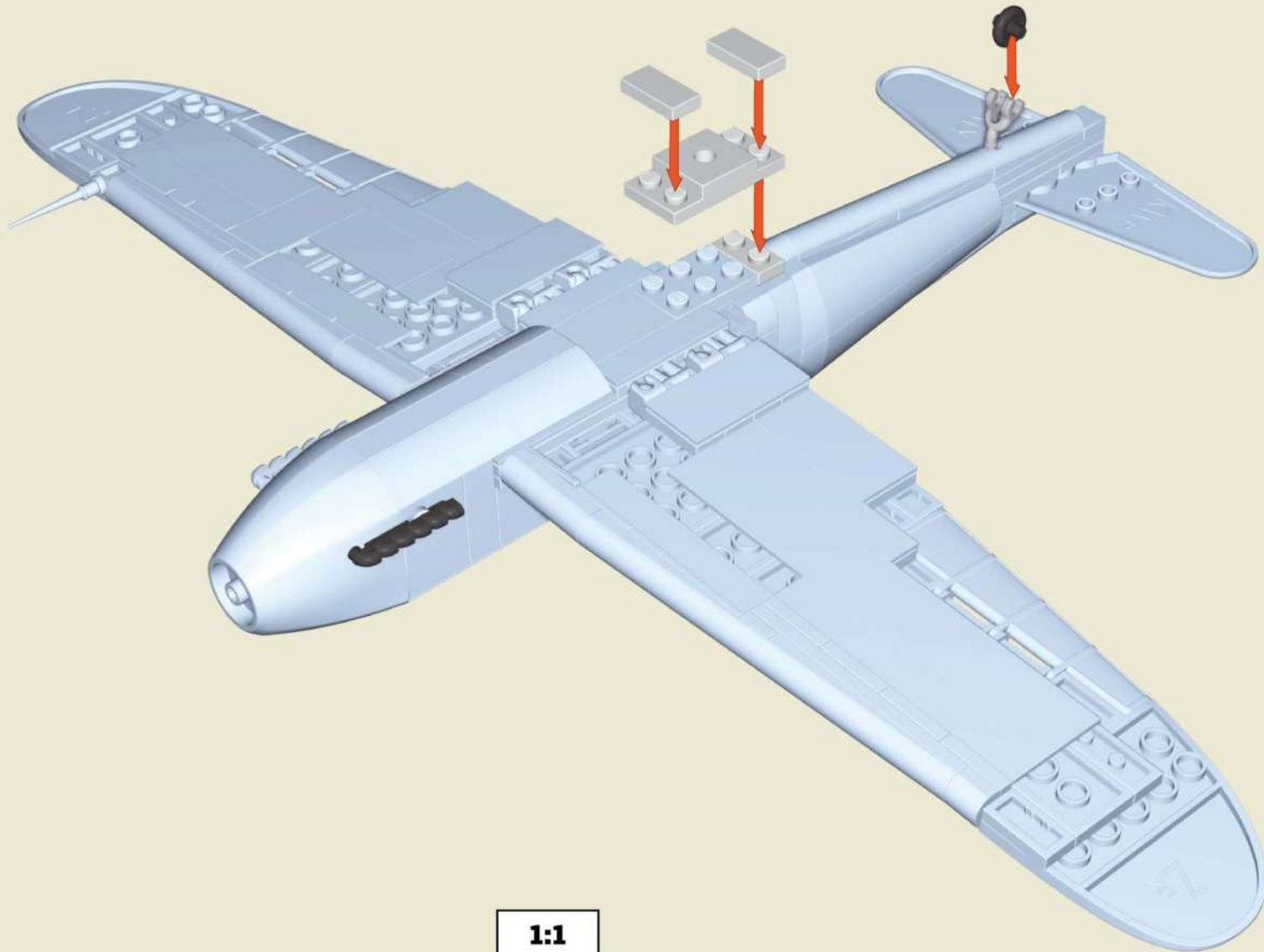

1:1



x1



x1



x1



x1



x1



x2

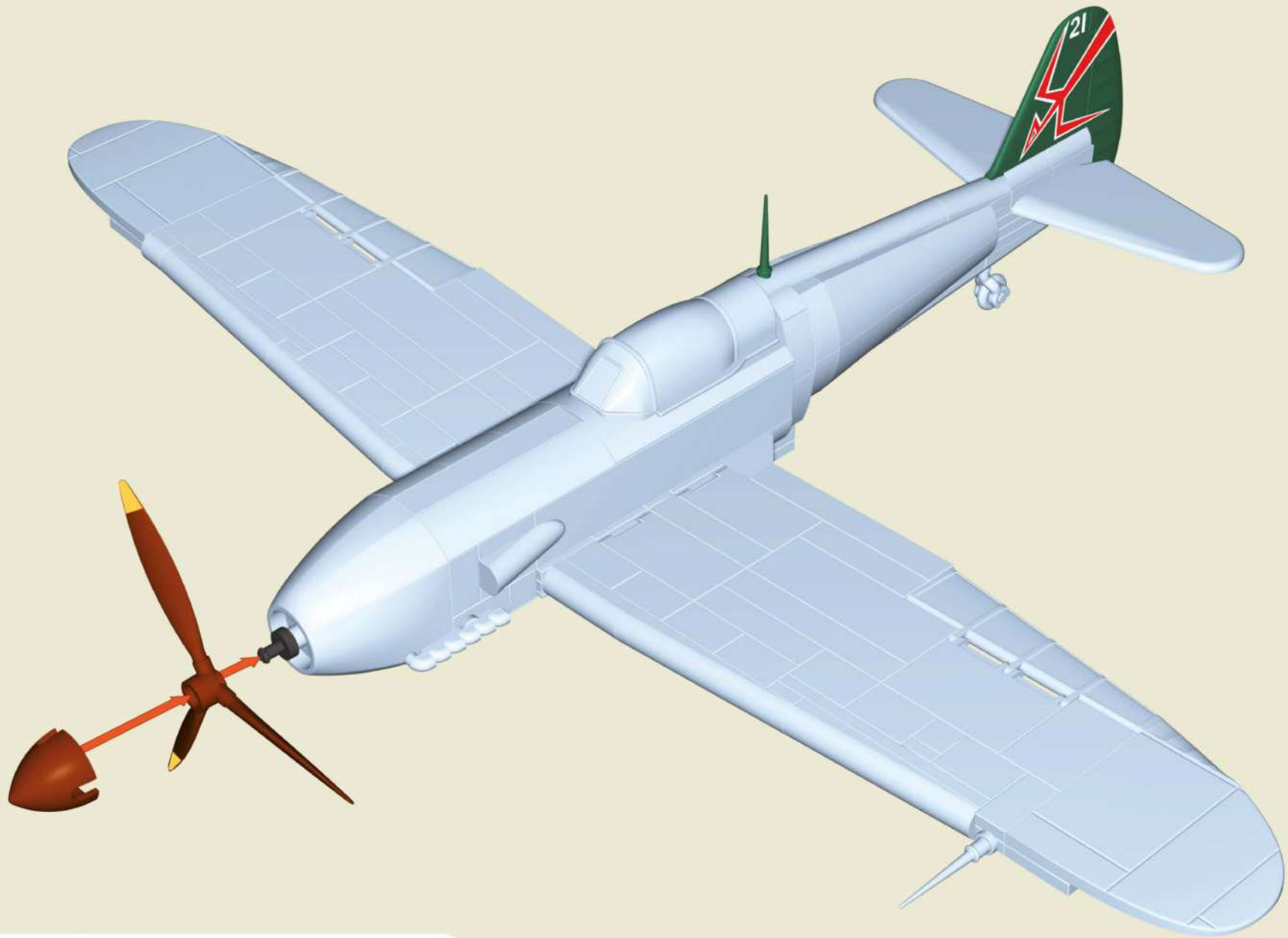

				
xl	xl	xl	xl	xl

49

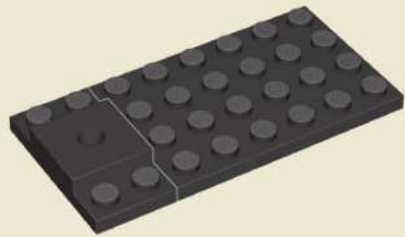

50

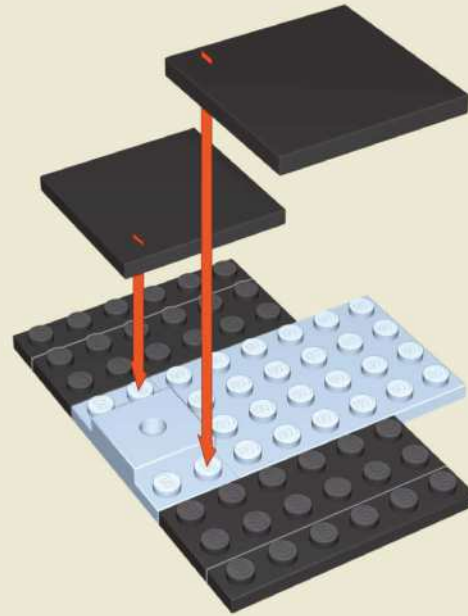

51

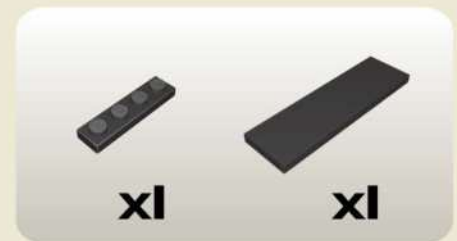
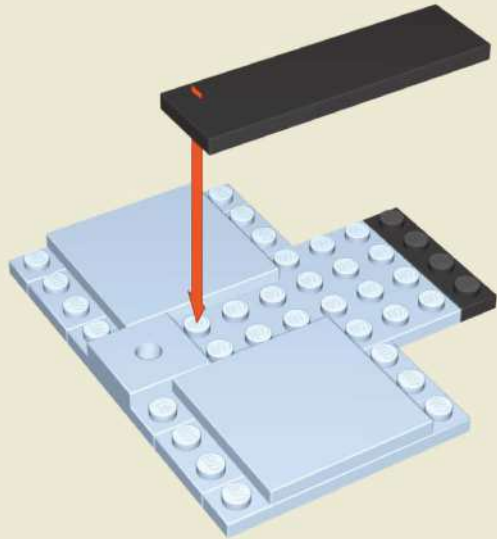

52

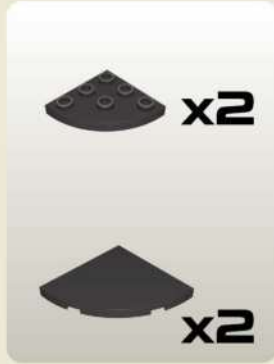
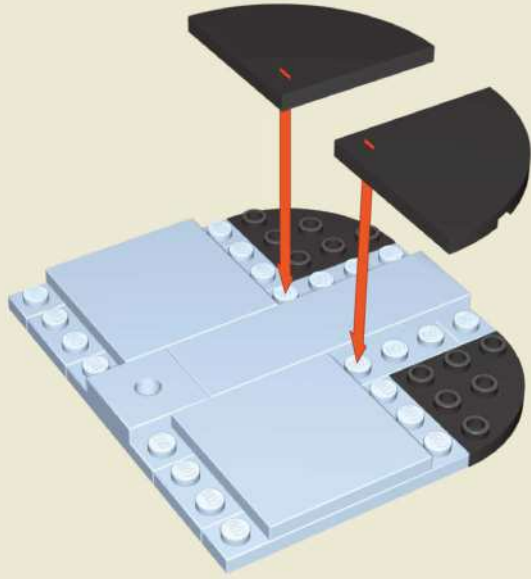

53

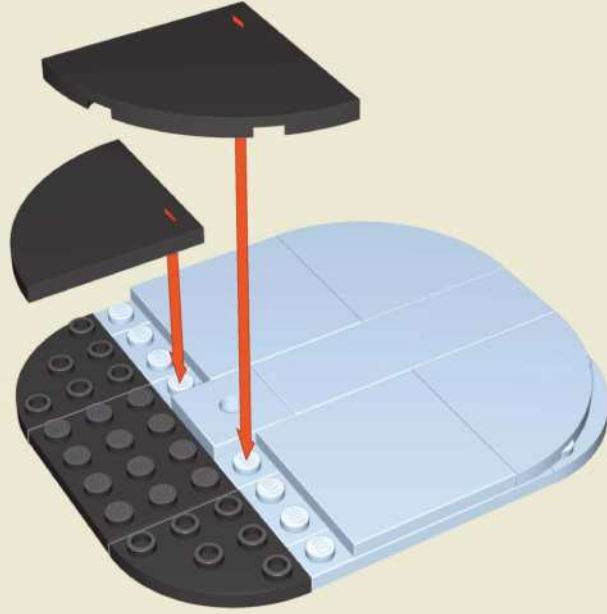

54

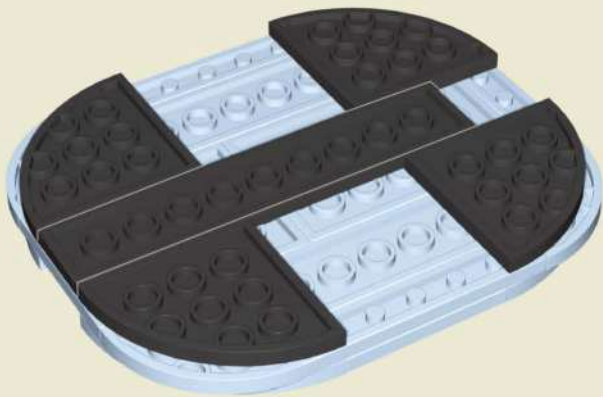

55



1:1

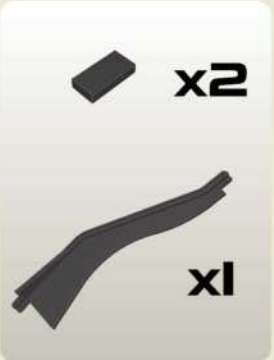
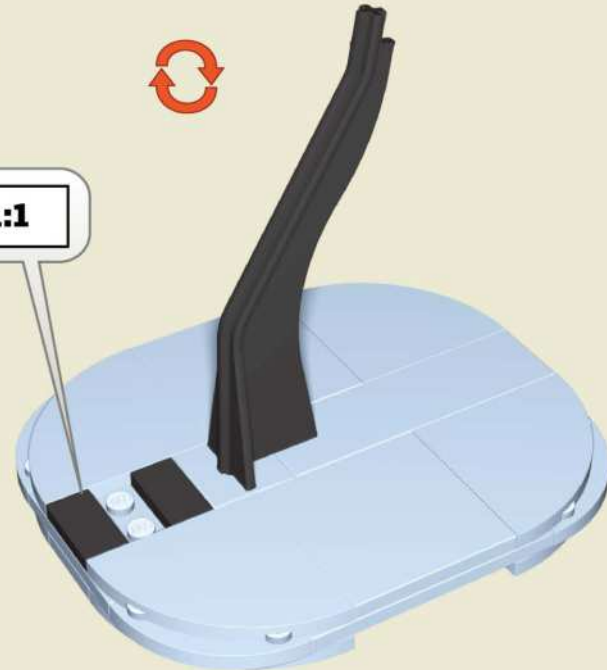

x2 **x1** **x1**



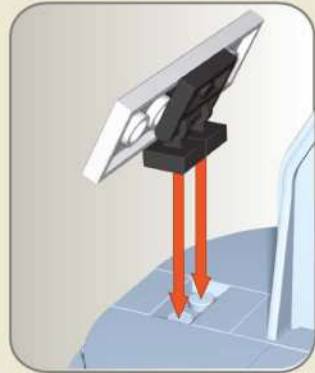
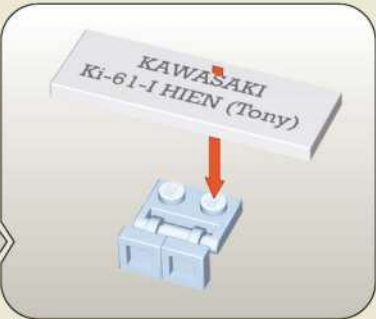
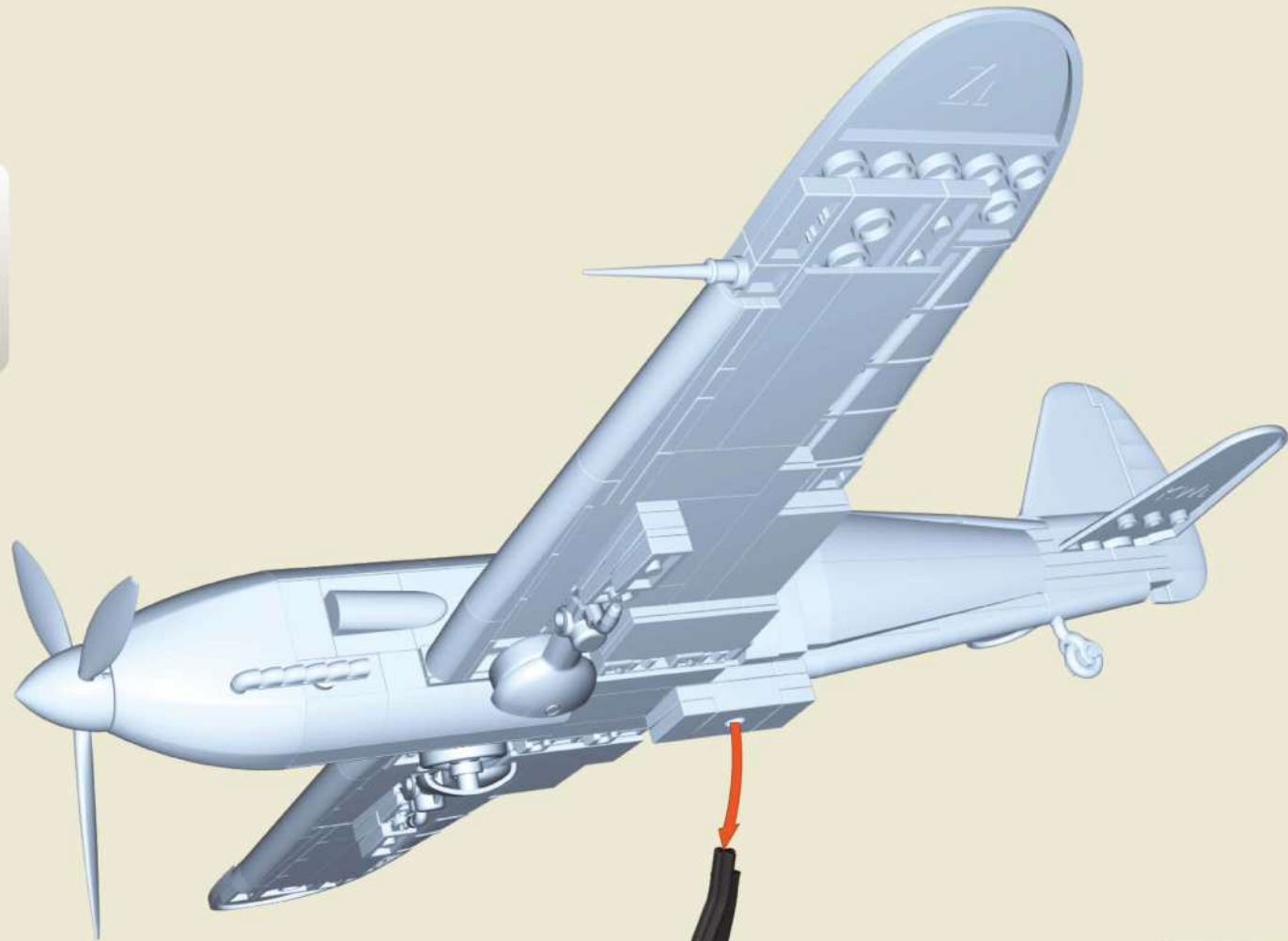

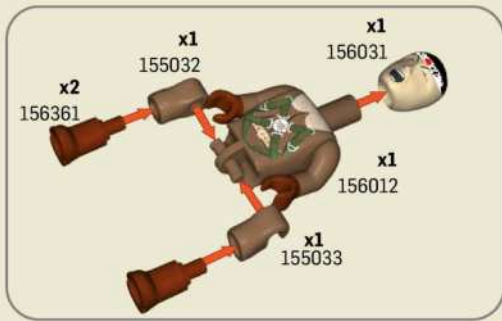



HISTORICAL COLLECTION



FOCKE-WULF FW 190 A-3
+ 5741



FOCKE-WULF FW 190 A5
+ 5722



PZL P.11c
+ 5742



P-47 THUNDERBOLT™
+ 5737

NORTHROP GRUMMAN

For news and special deals

Find us on:
f cobr.bricks
i cobr.klocki
y COBI SA

WWW.COBIBRICKS.COM

18-05740-314