

# HISTORICAL COLLECTION

## WORLD WAR II



**FOCKE-WULF FW 190 A-3**  
 PLACE OF ORIGIN - GERMANY  
 IN GERMAN SERVICE - 1942 - 1945  
 ROLE - FIGHTER-BOMBER  
 CREW - 1  
 WINGSPAN - 10,5m (34' 6")  
 LENGTH - 8,95m (29' 4")  
 HEIGHT - 3,9m (12' 9")  
 WEIGHT - 3 470kg (7 650lb)  
 ENGINE - BMW 801 C-2, 1 147kw (1 539hp)  
 RANGE - 800km (500mi)  
 RATE OF CLIMB - 15m/s (3 000ft/min)  
 MAXIMUM FLIGHT LEVEL - 11 400m (37 400ft)  
 ARMAMENT - 4x 20mm (.787") MG 151  
 2x 7,92mm (.312") MG 17  
 BOMBS OR EXTERNAL FUEL TANK  
 SPEED - 610km/h (379mph)



**PAD PRINTED**  
**NO STICKERS**

**Printed in EU**

5741



**WARNING: CHOKING HAZARD-**  
 Toy contains small parts.  
 Not for children under 3 years.

382 1

**FOCKE-WULF FW 190 A-3**

**SCALE 1:32**

1

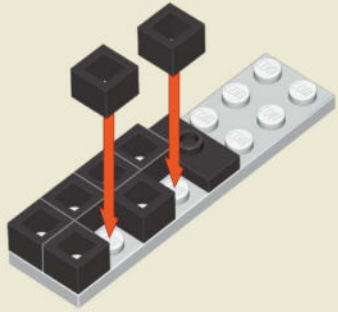

2

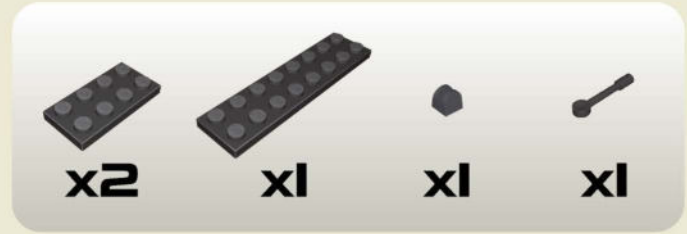
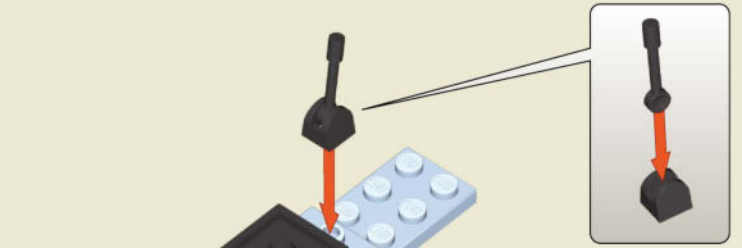
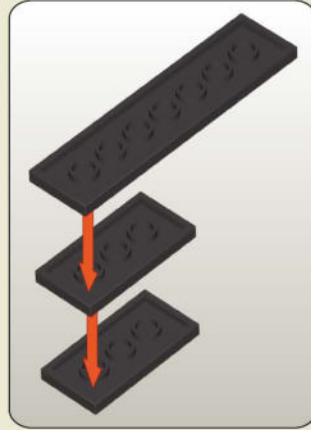

3

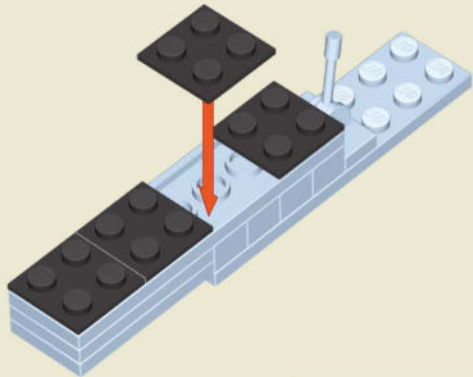

4

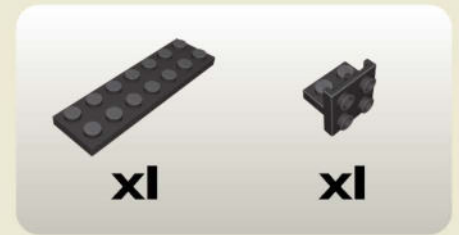
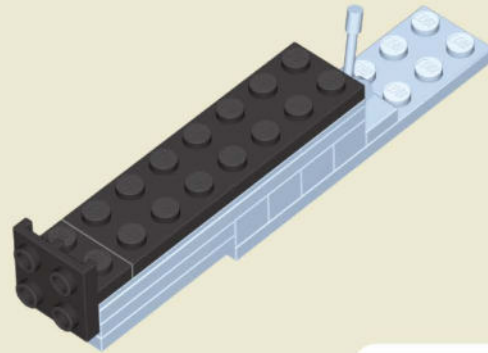

5

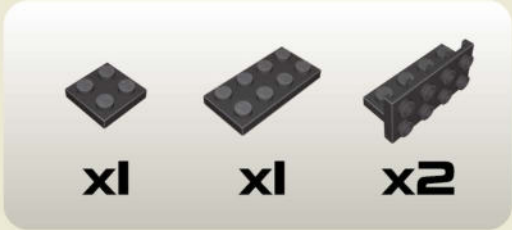
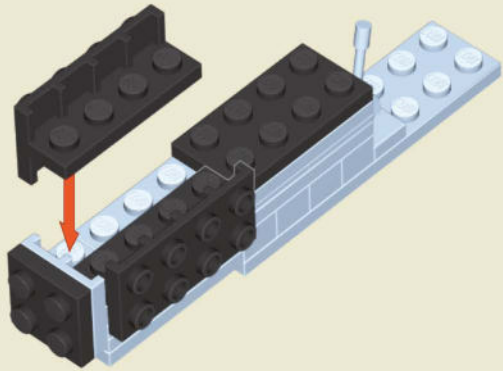

6

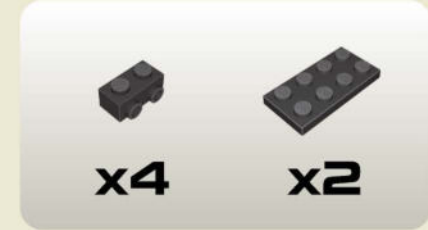
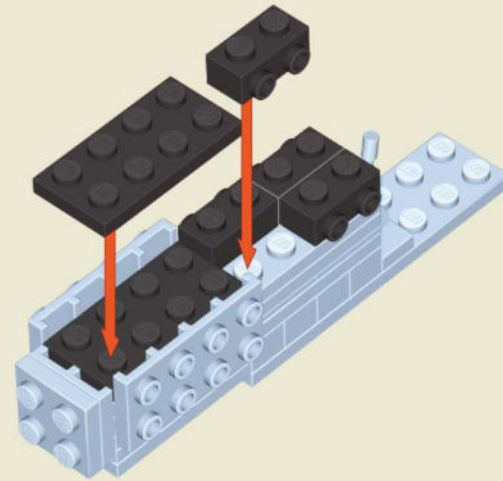

7

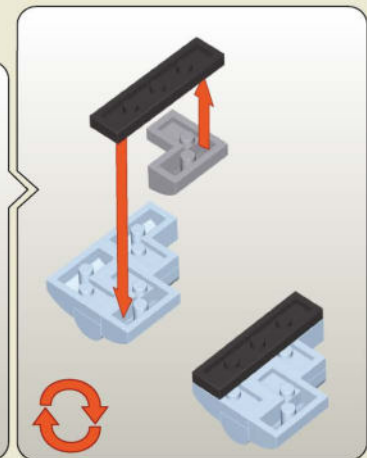
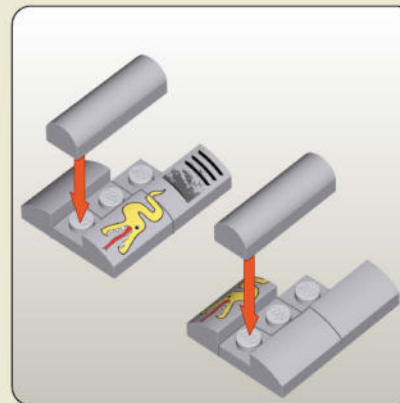
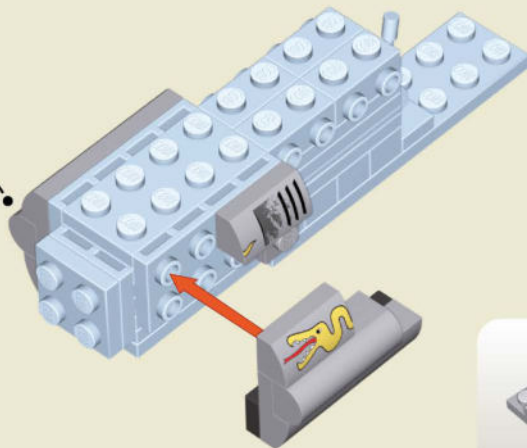
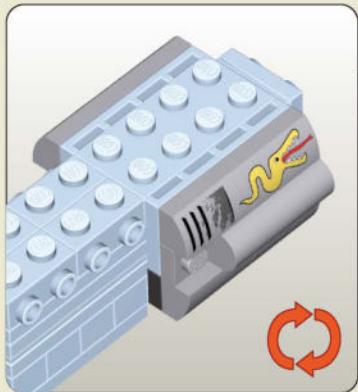



8

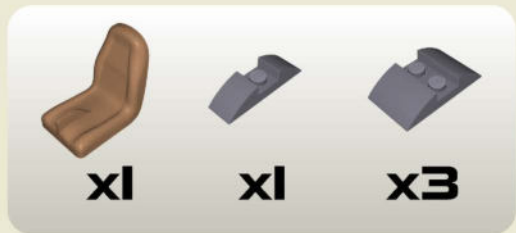
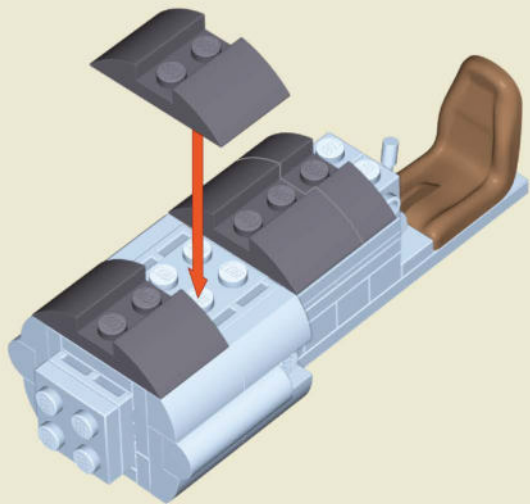

9

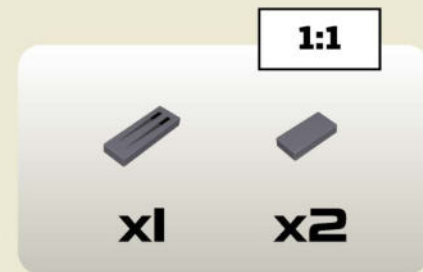
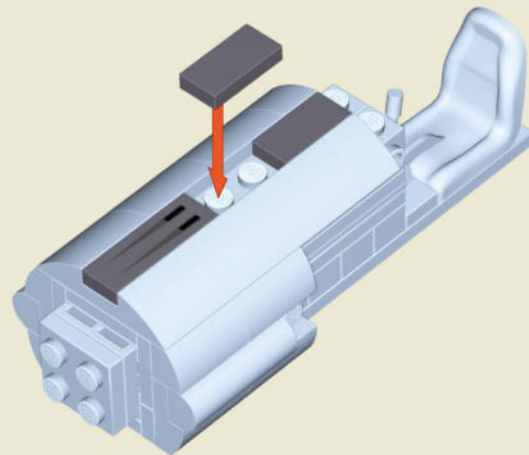

10

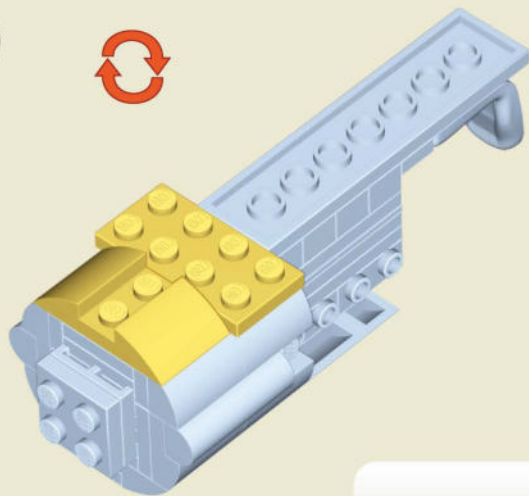

11

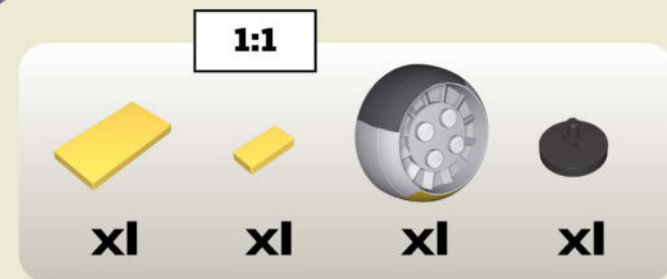
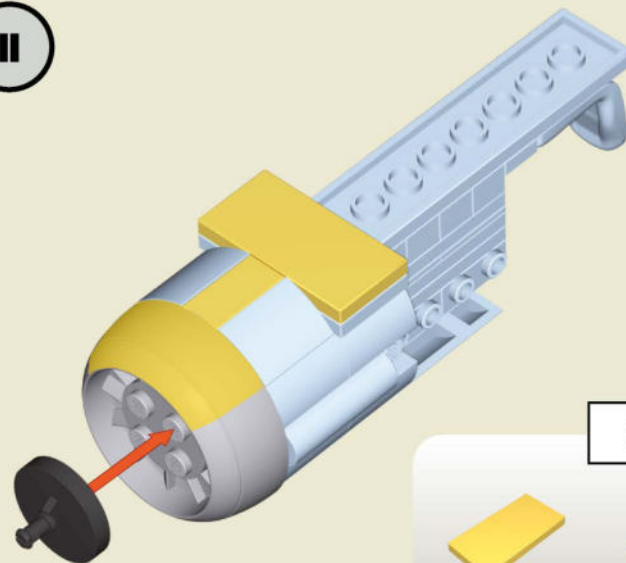

12

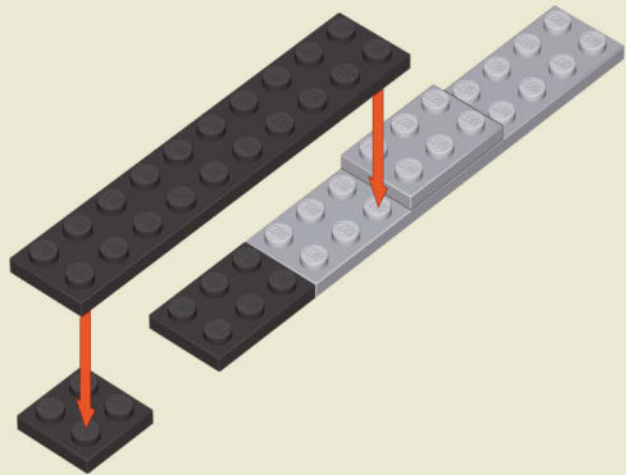

13

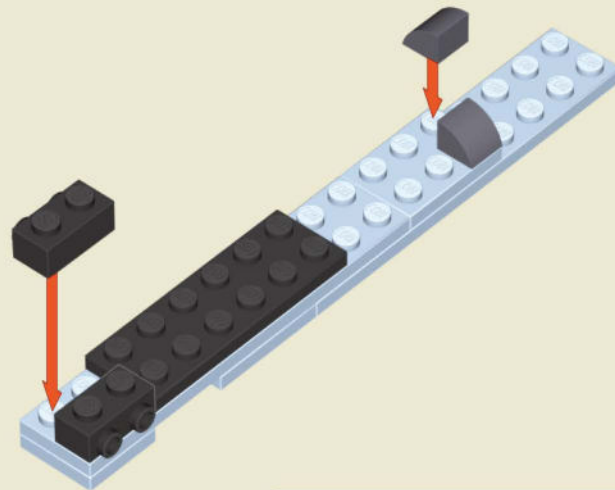

14

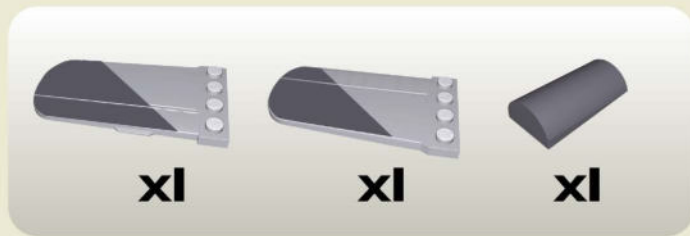
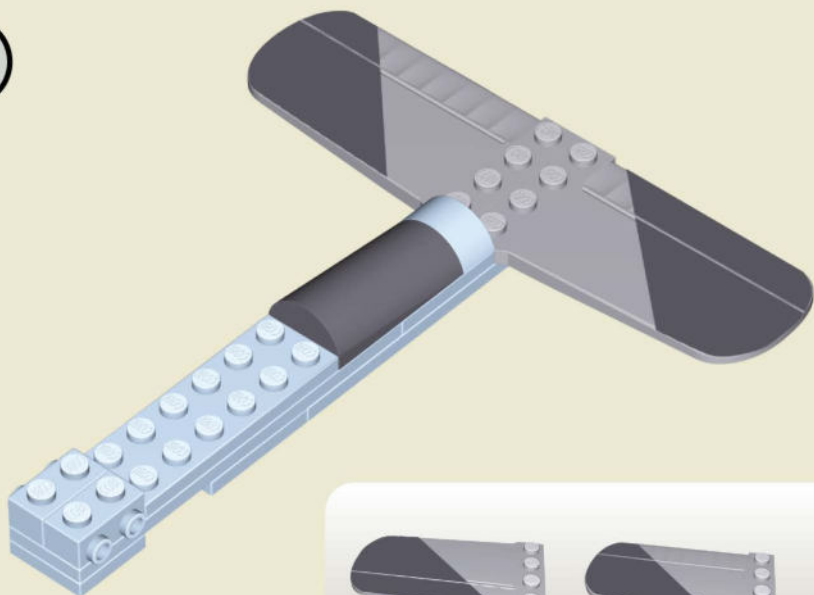

15

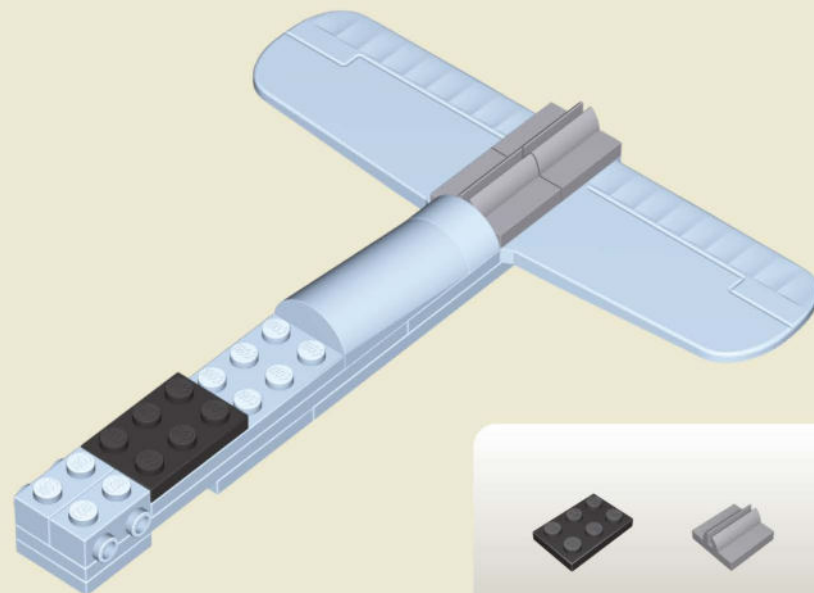

16

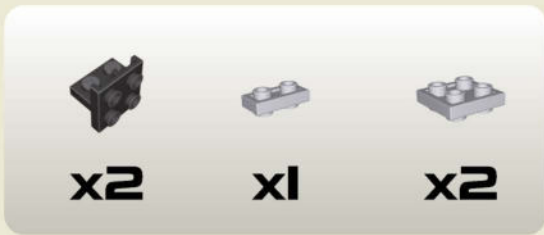
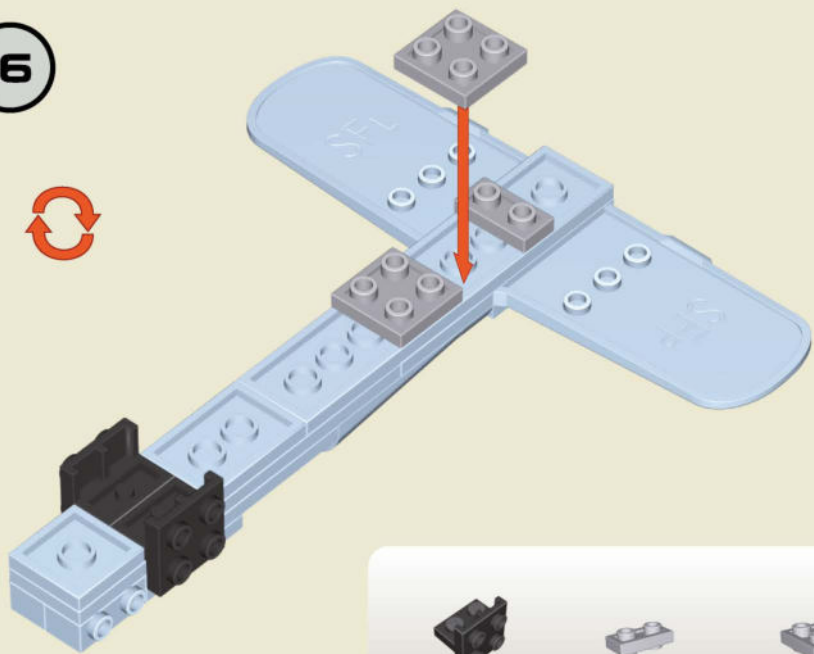

17

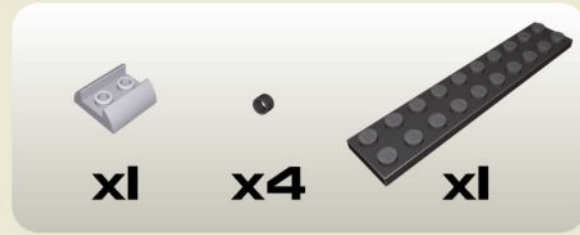
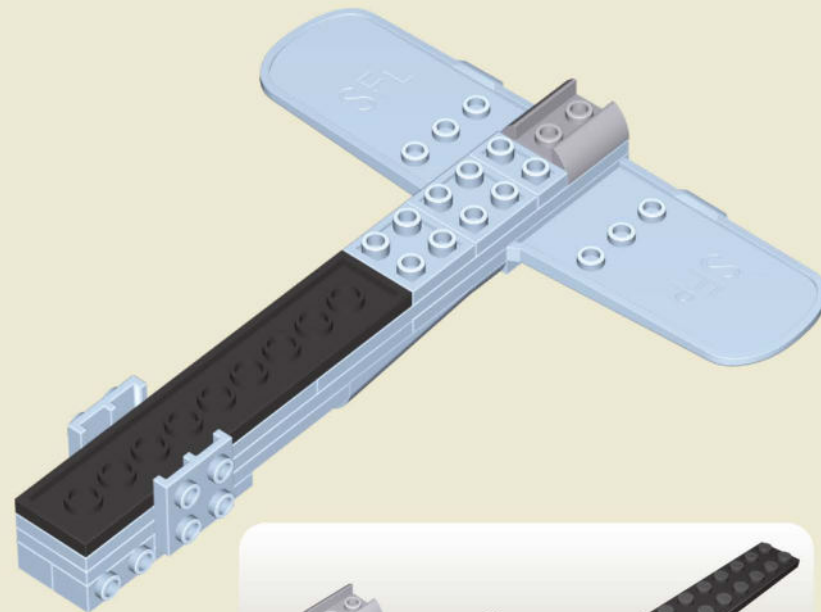

18

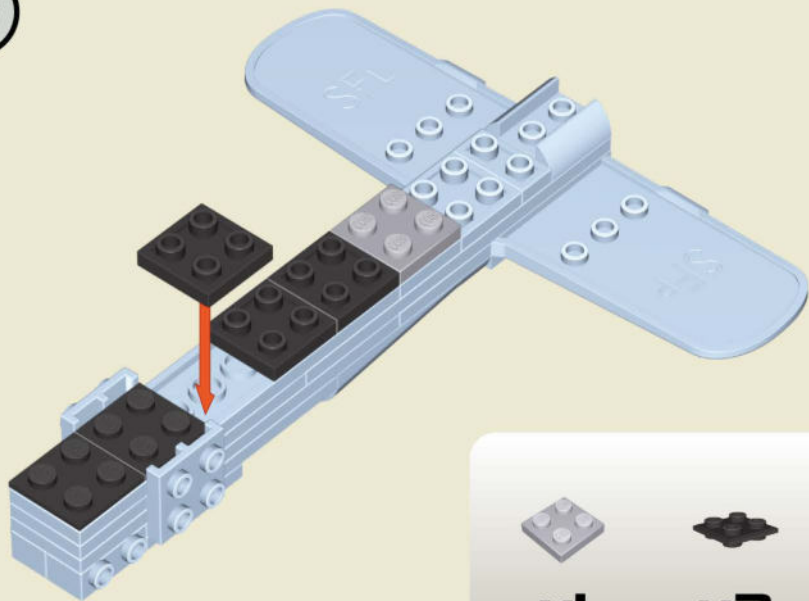

19

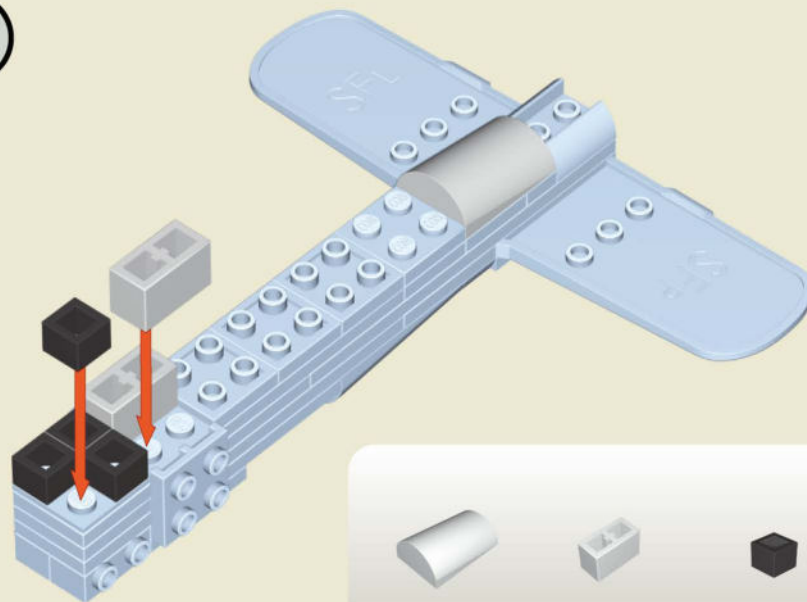

20

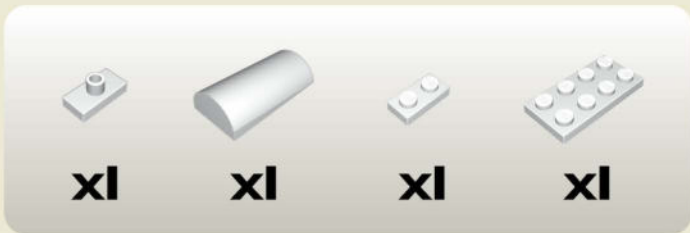
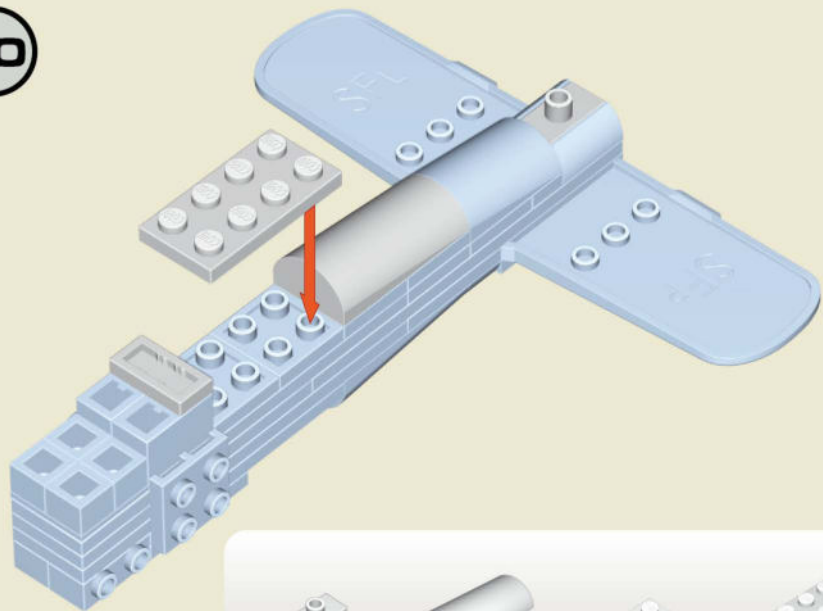

21

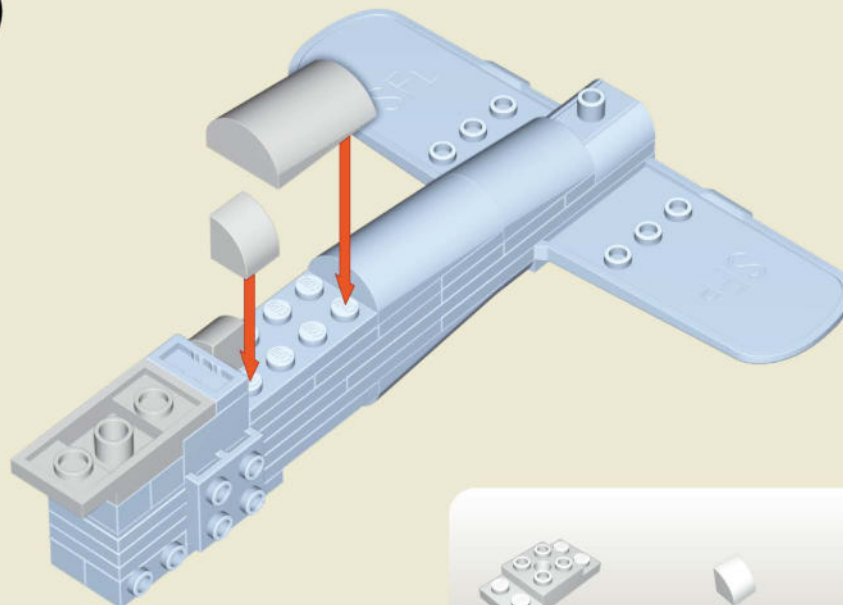

22

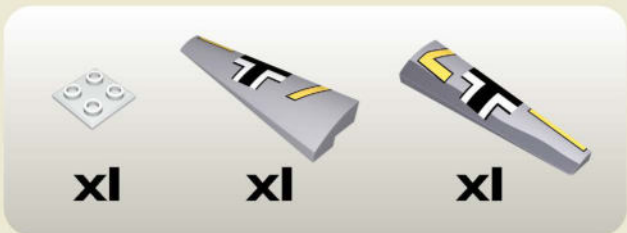
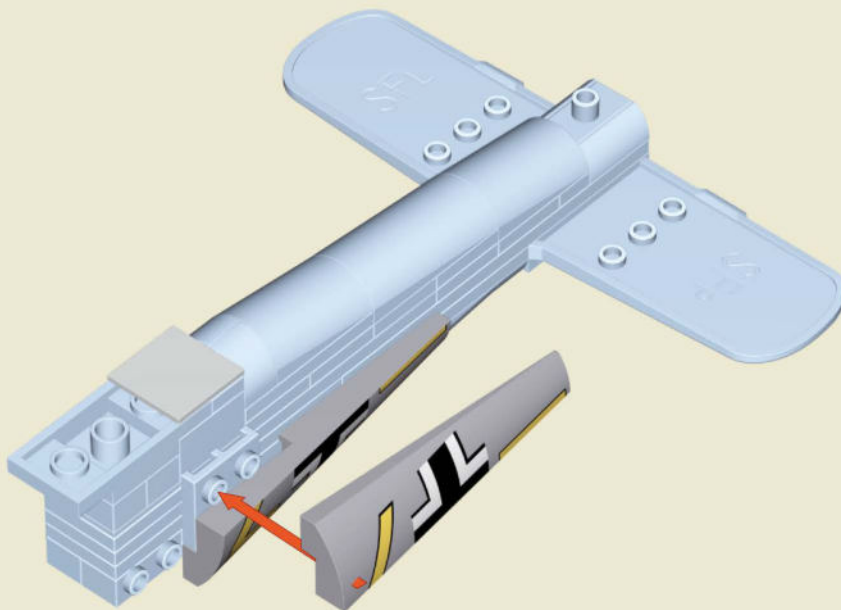



23

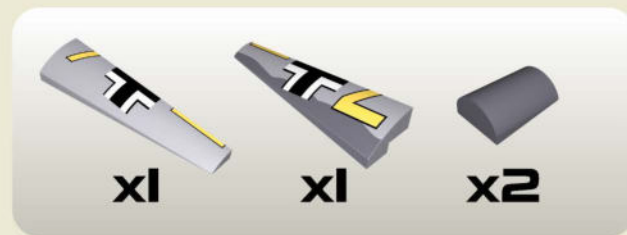
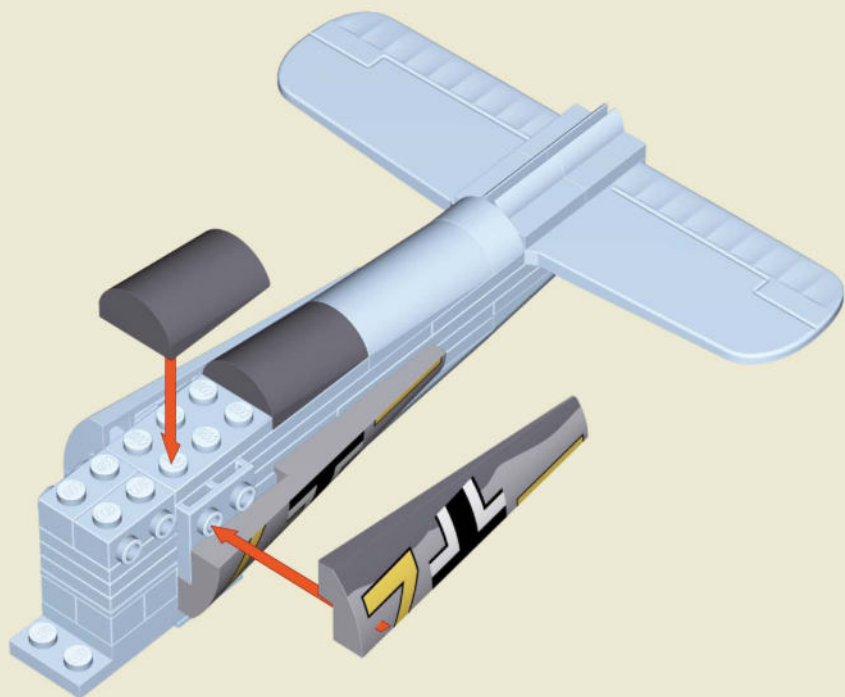

24

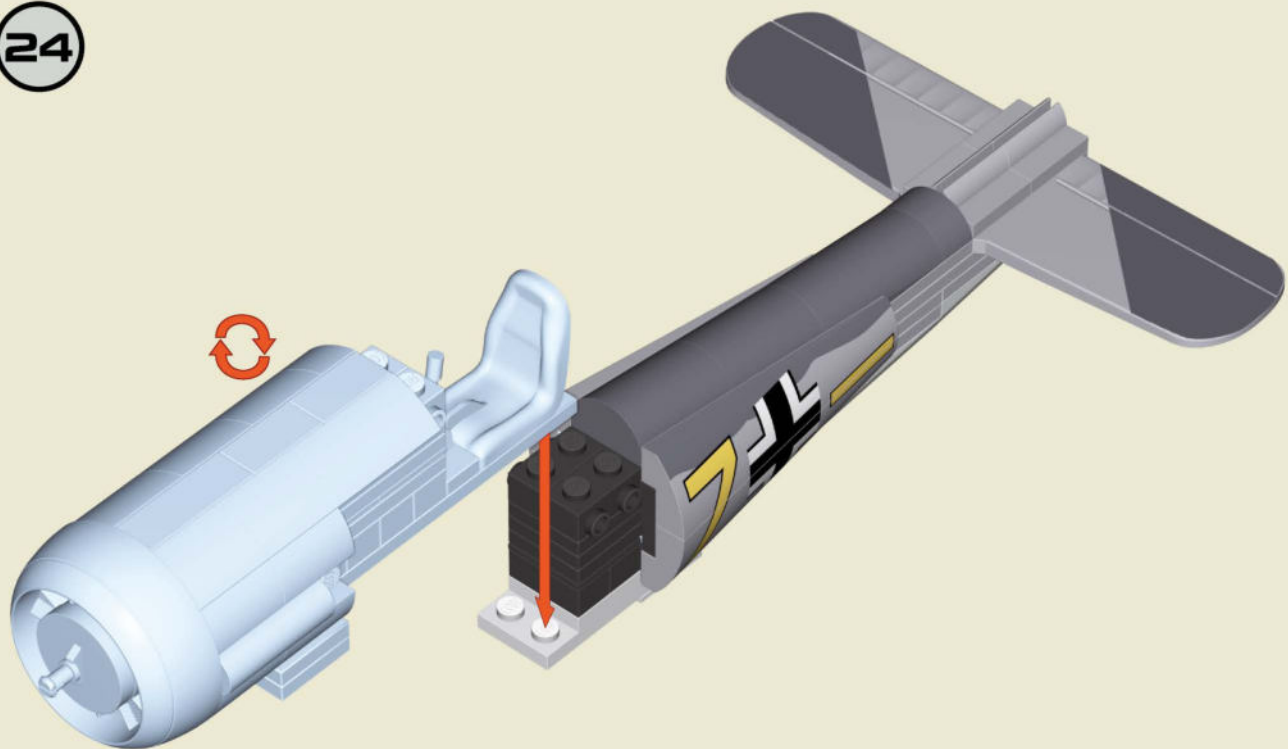

25

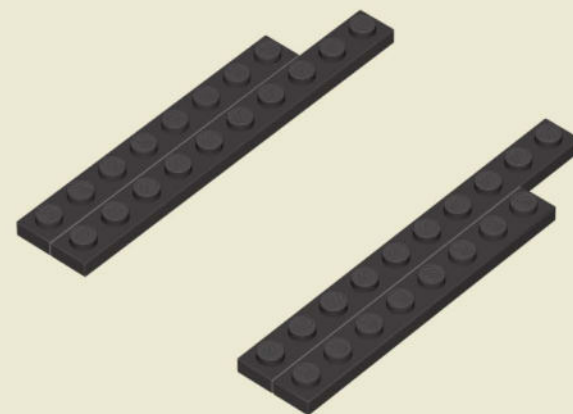



26

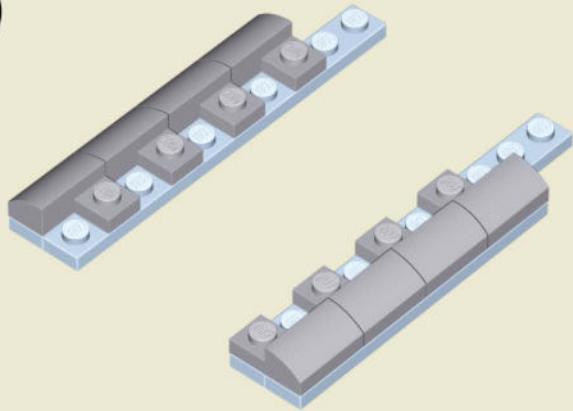

27

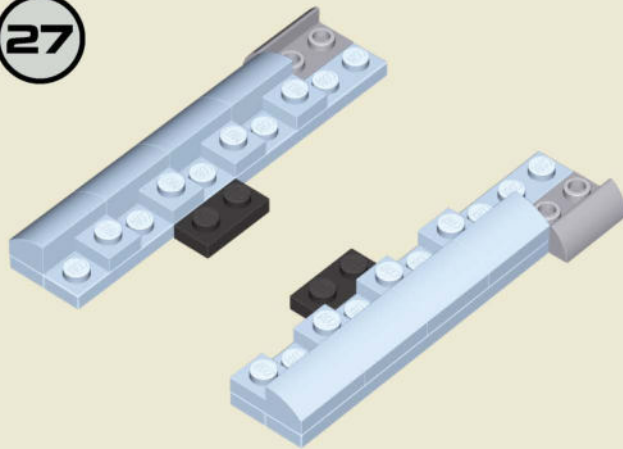

28

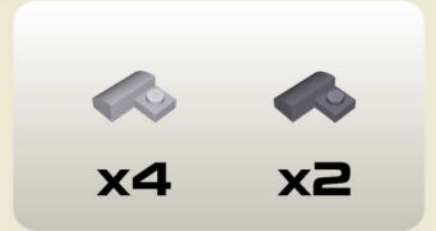
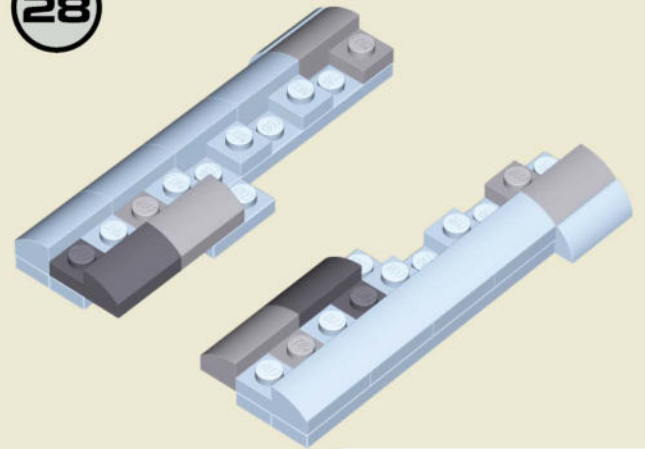

29



30

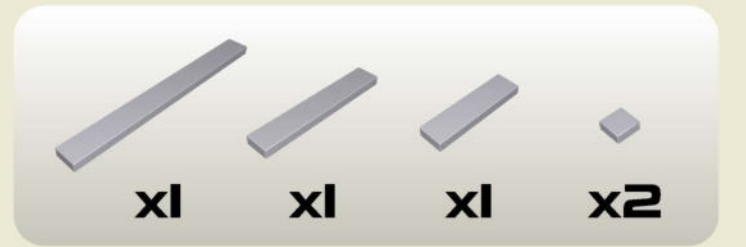
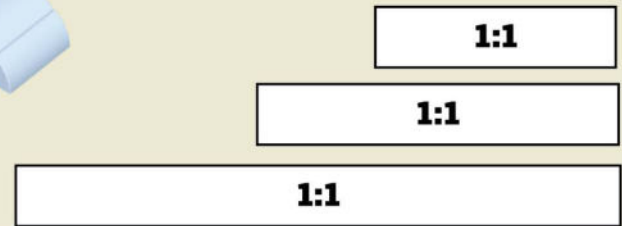
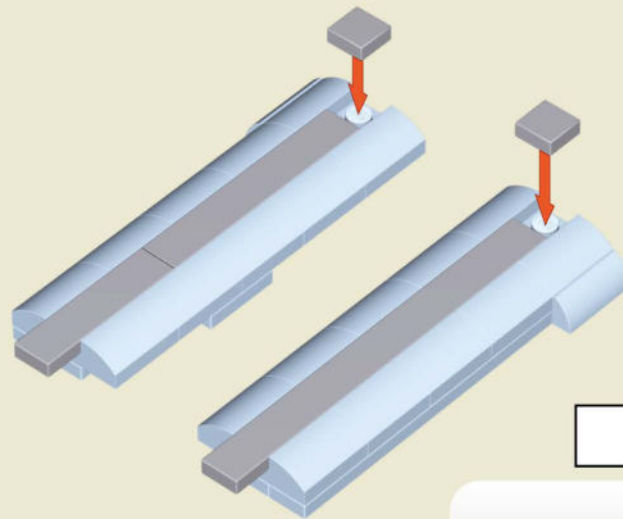

31

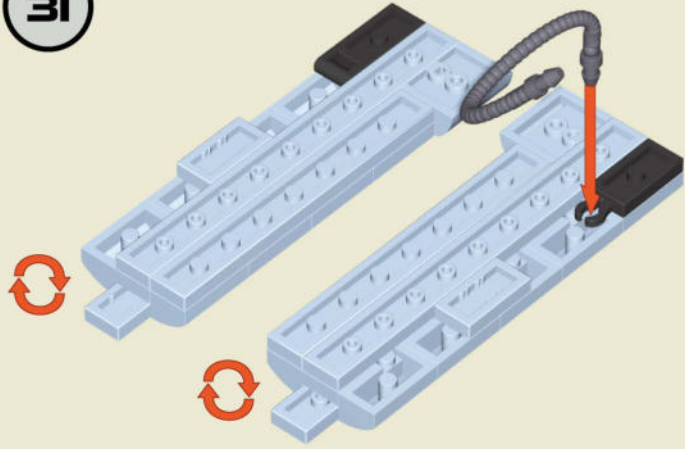

32

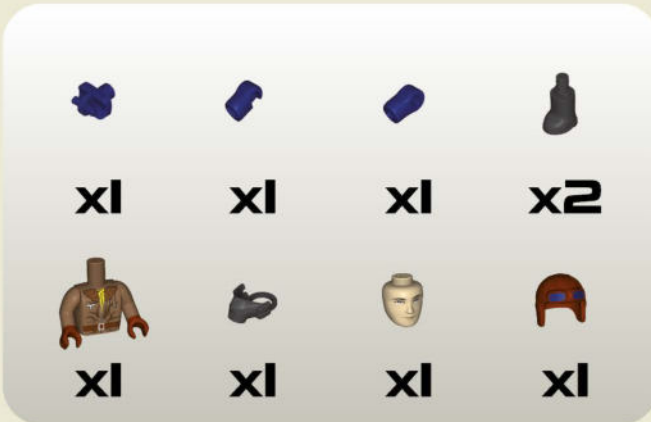
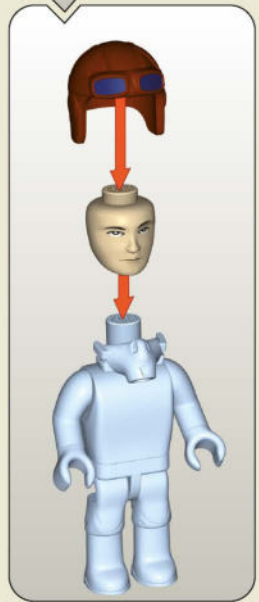
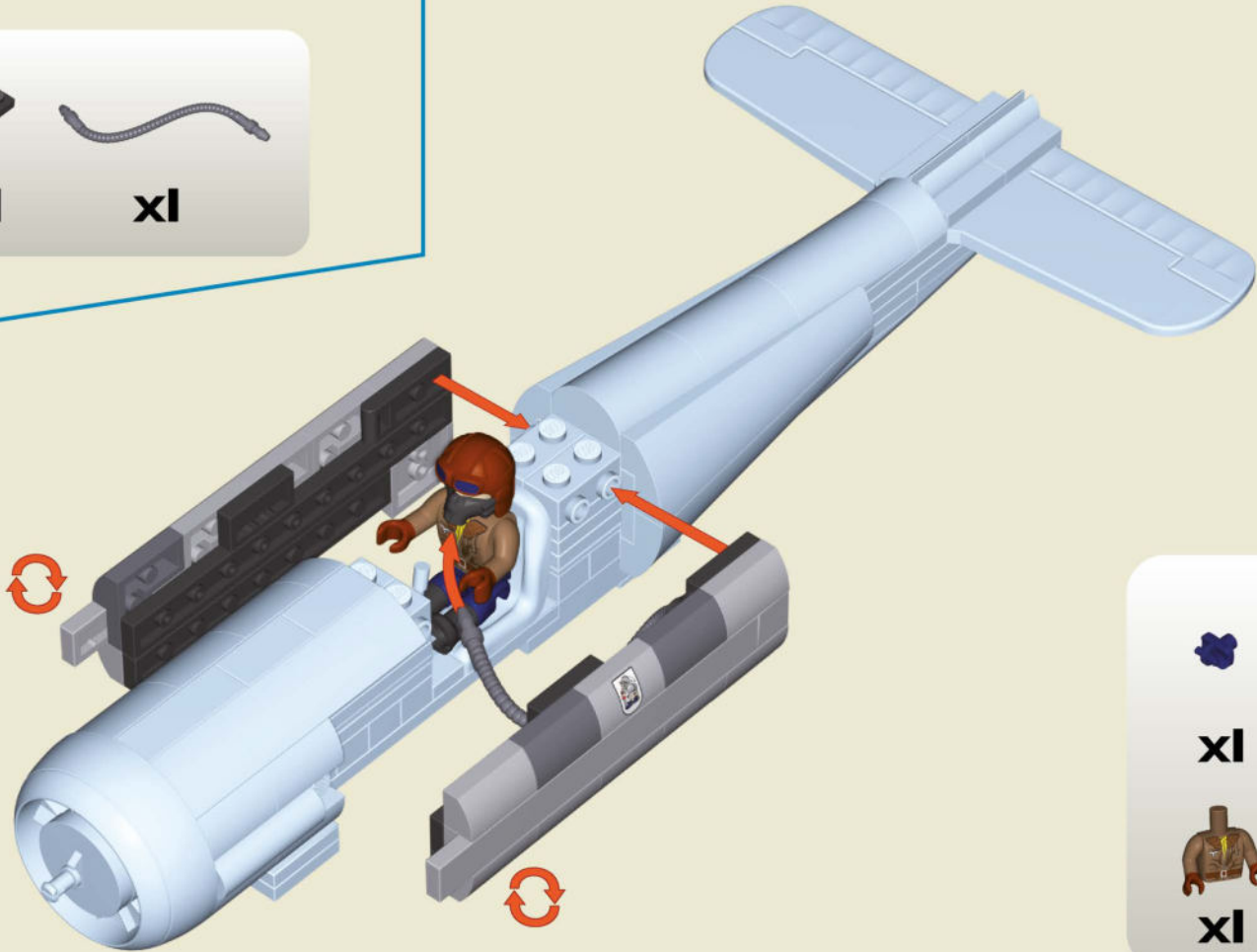
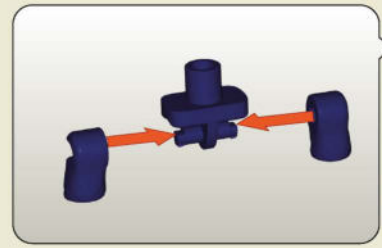
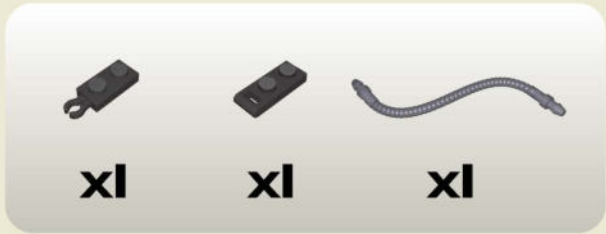

33

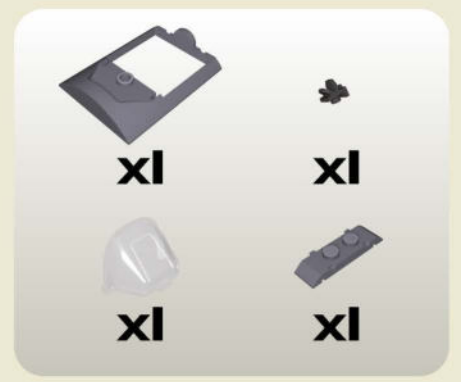
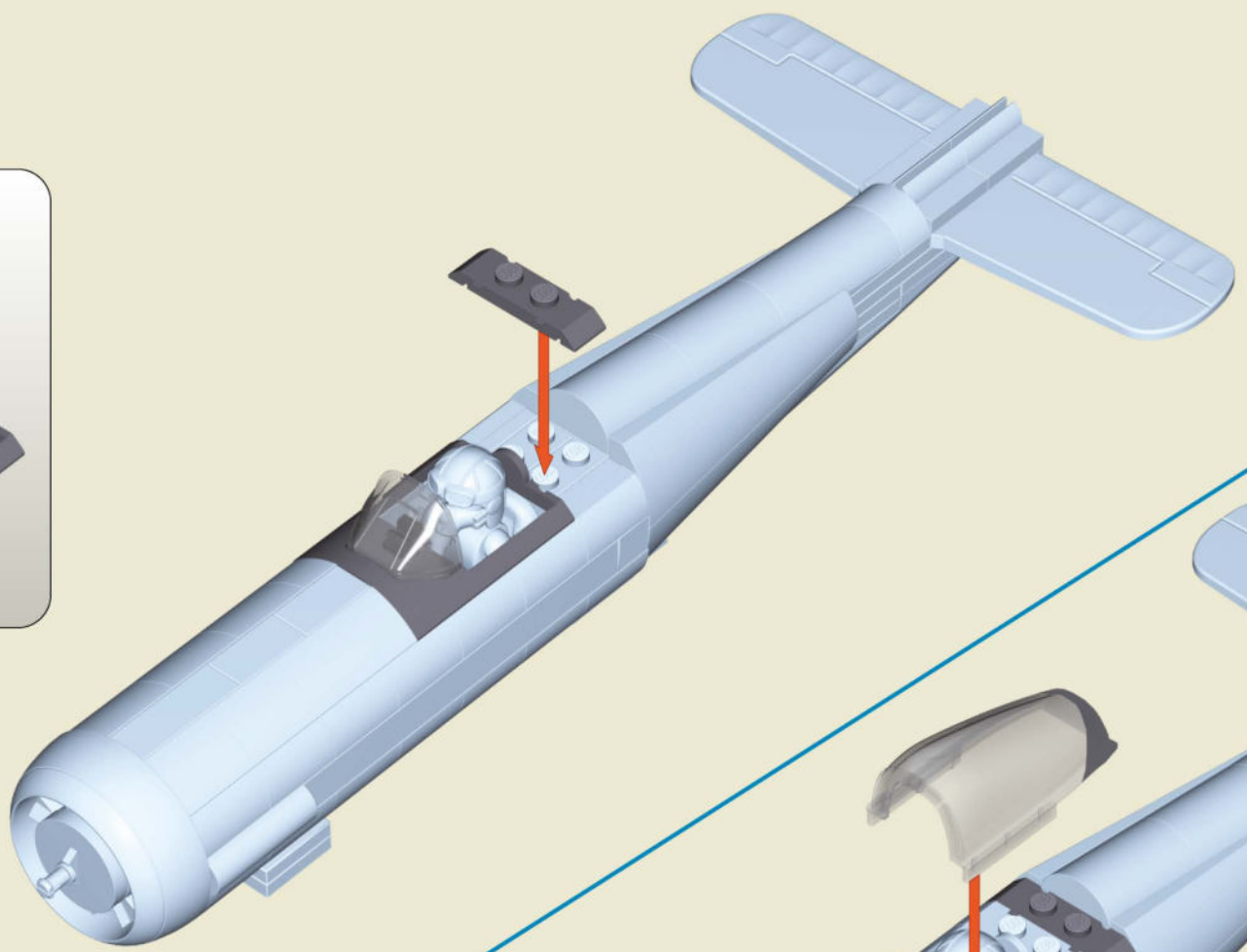
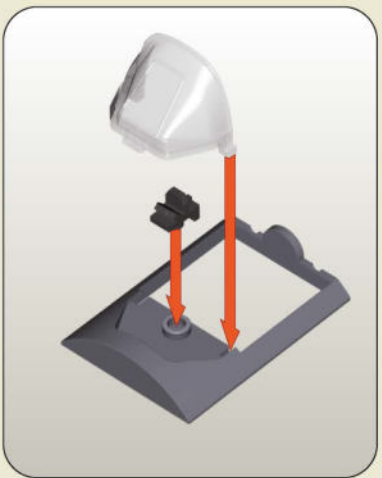

34

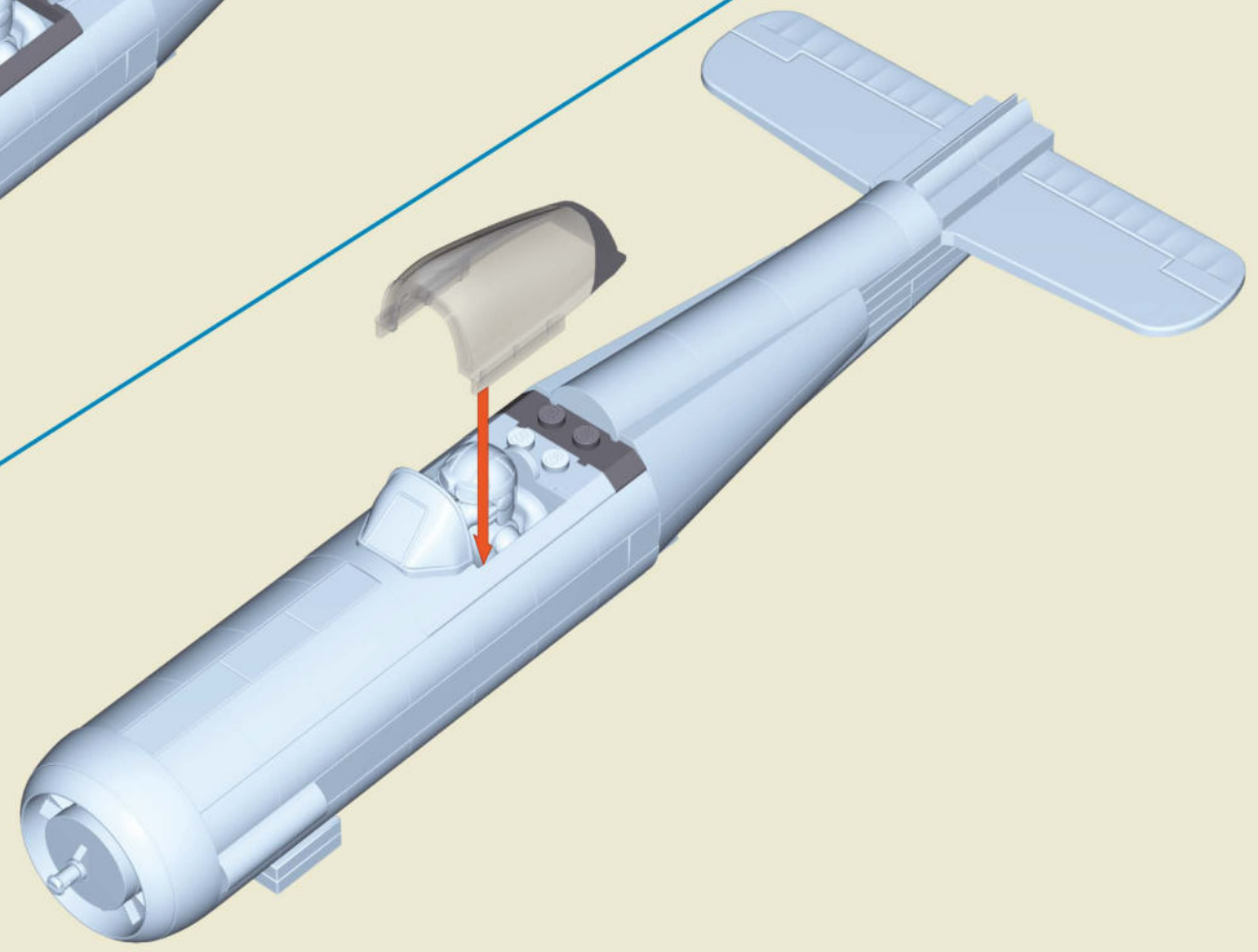
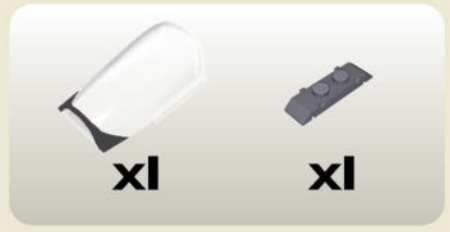



35

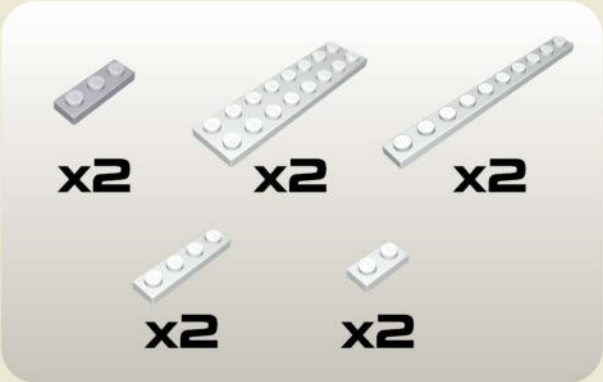

36

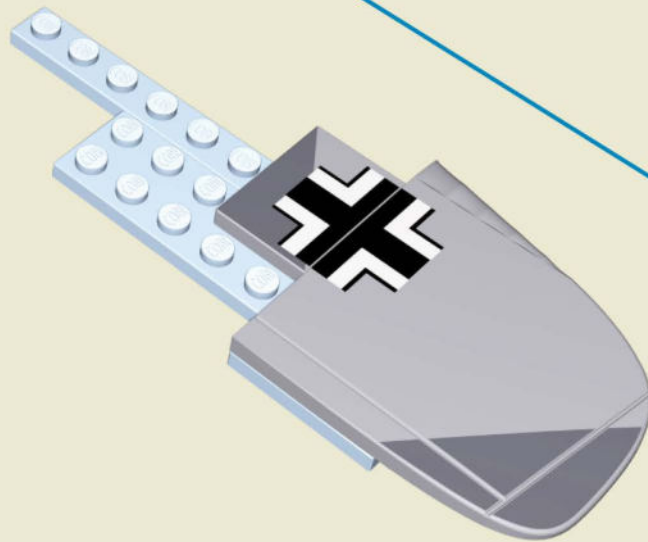
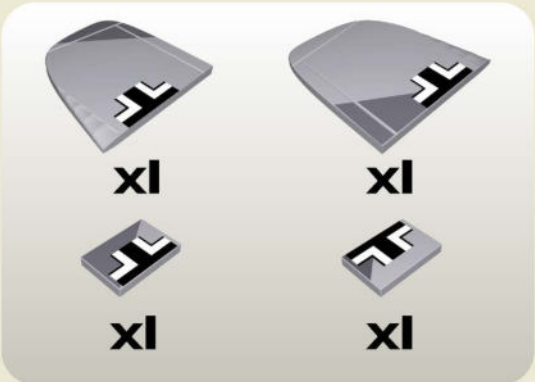
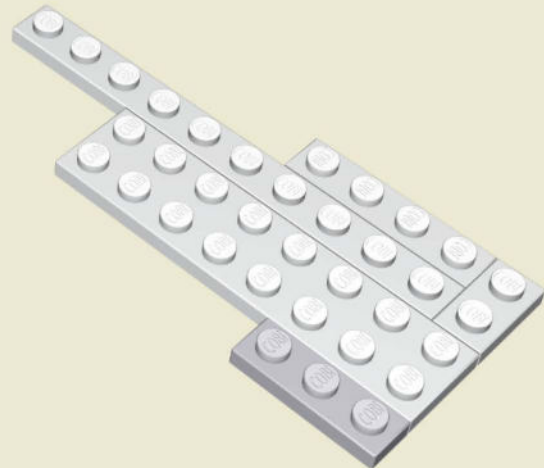

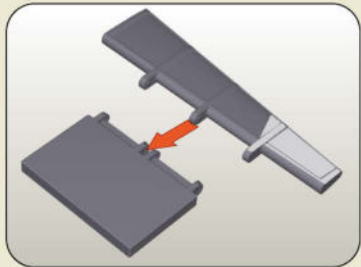
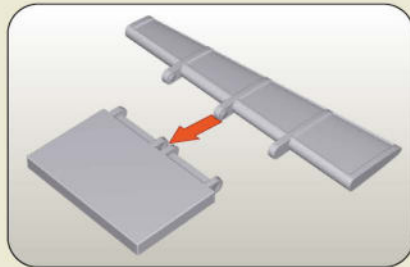
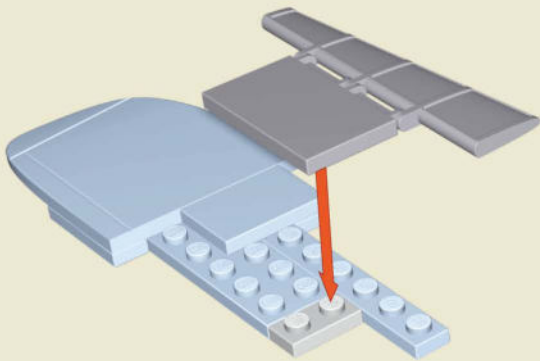
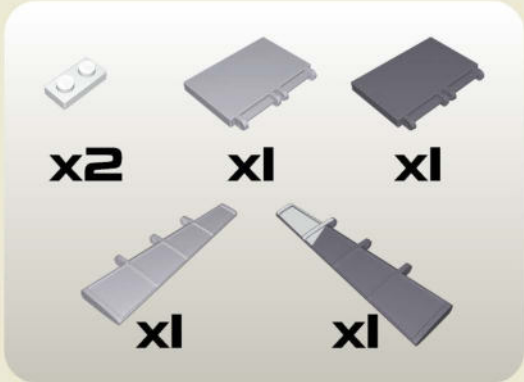

37

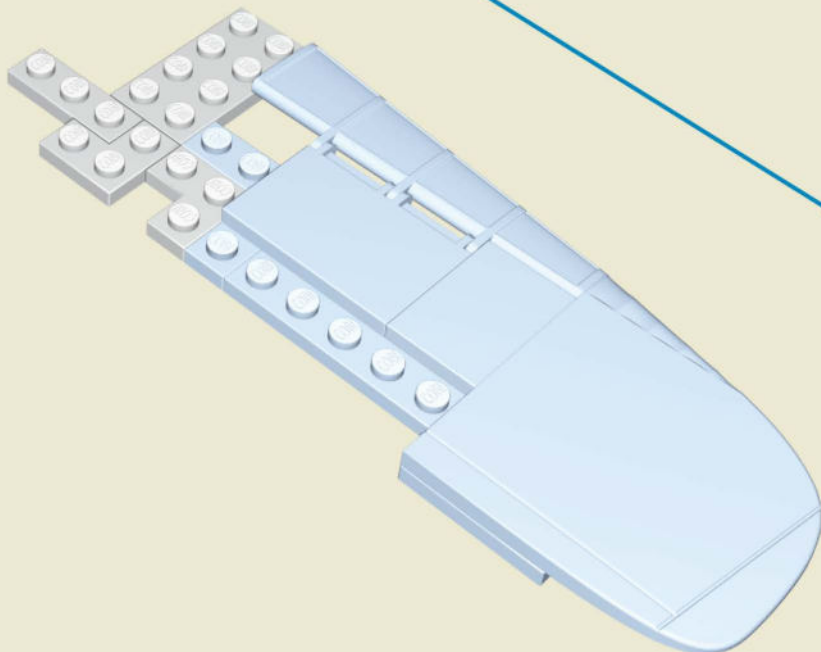
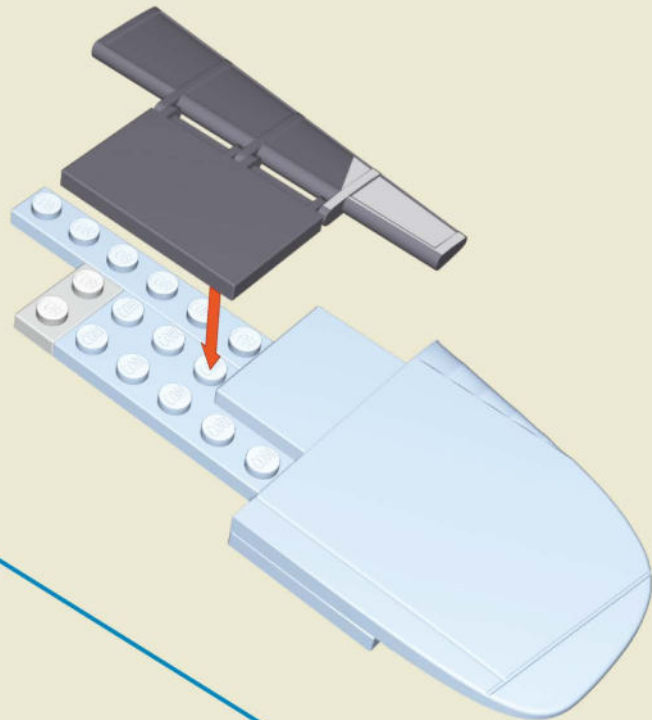
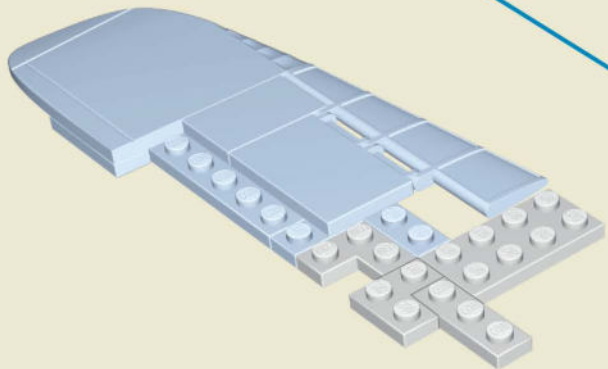

38





39

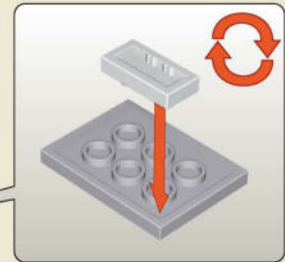
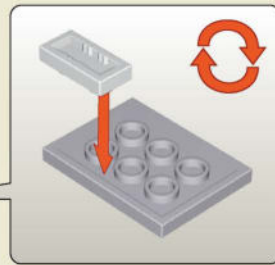
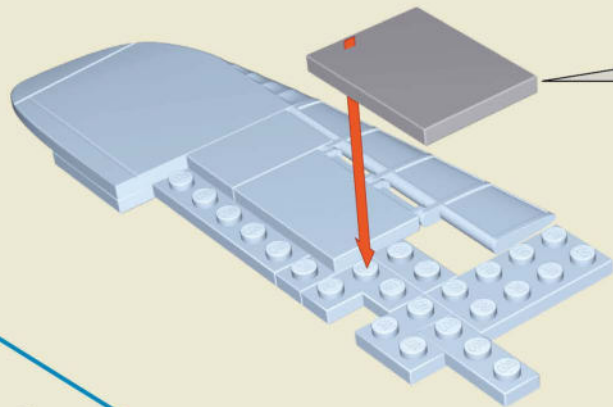

  
**x2**     **x1**     **x1**

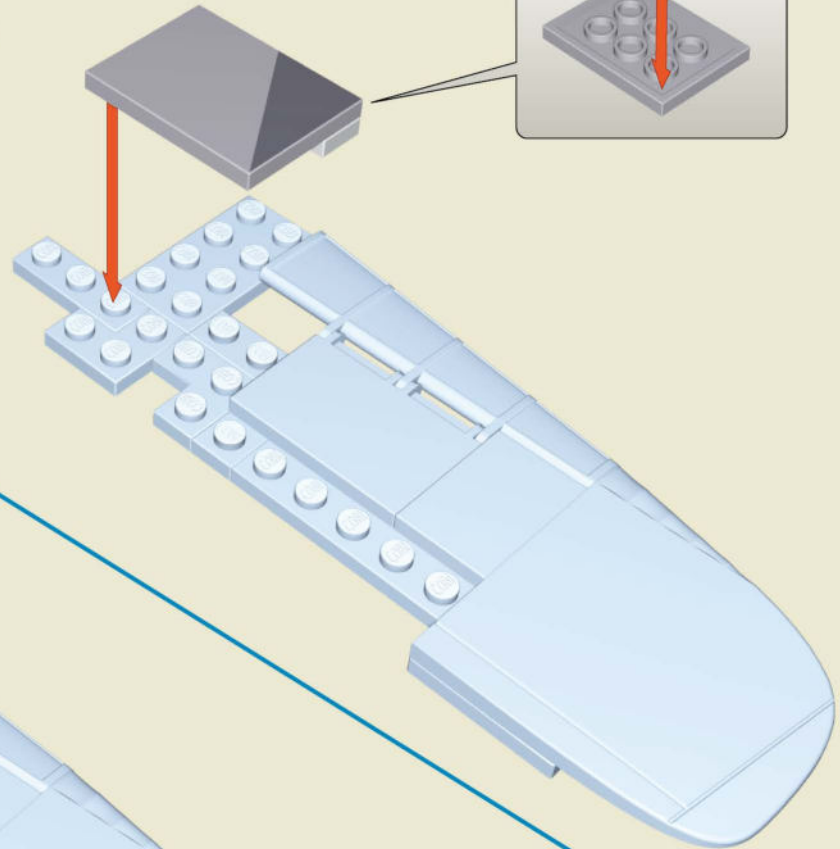
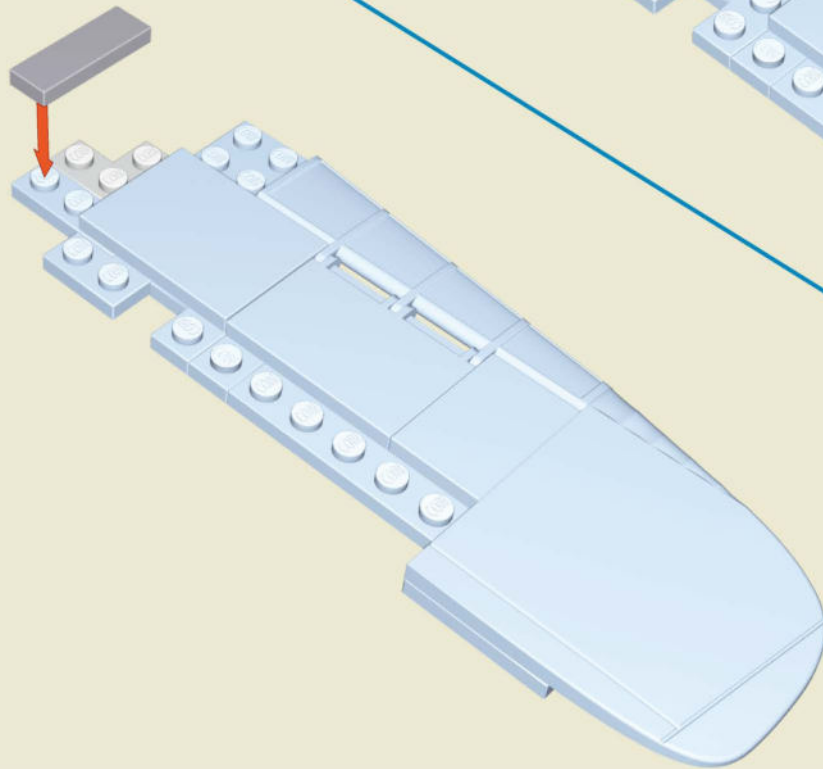
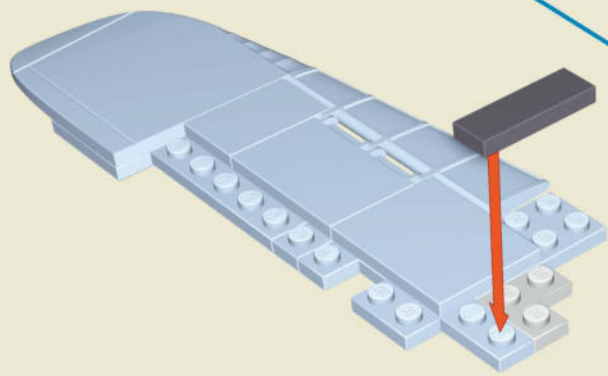

40

1:1  

  
**x2**     **x1**     **x1**



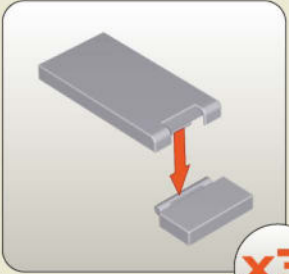
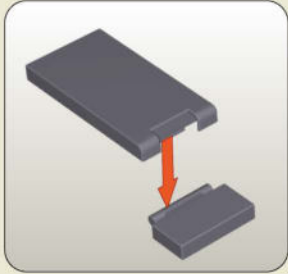
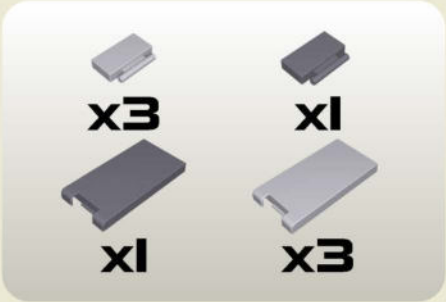

41



x3

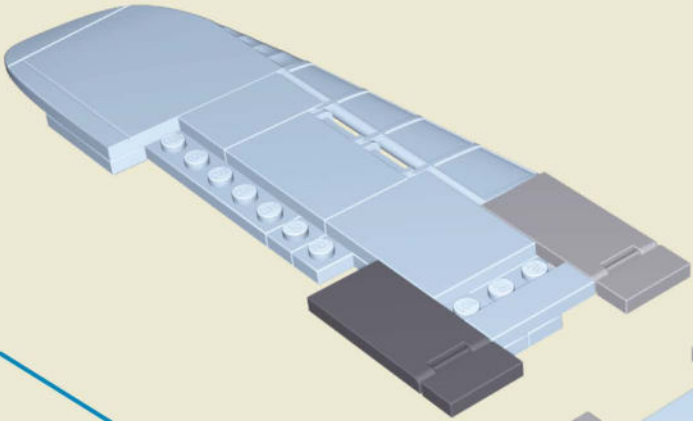

42

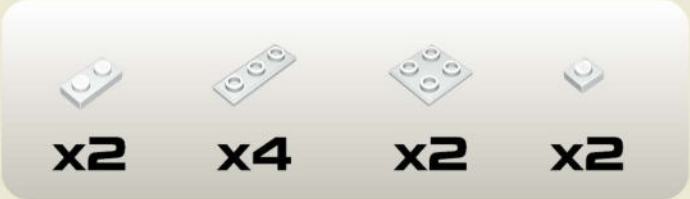
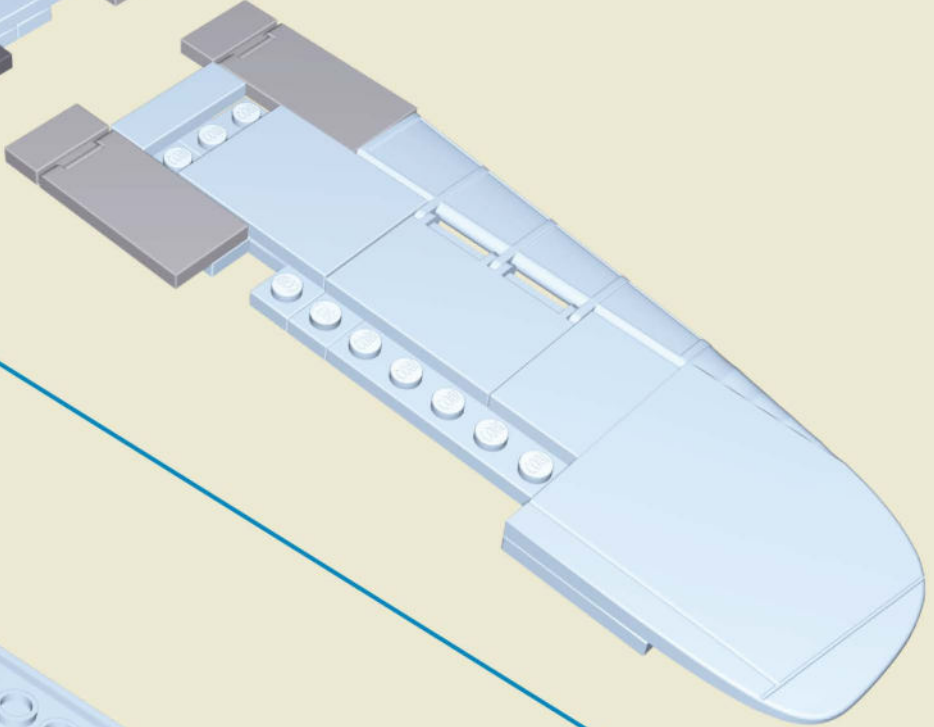
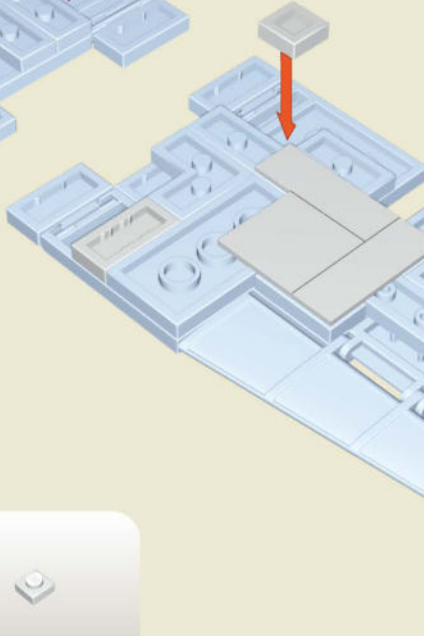
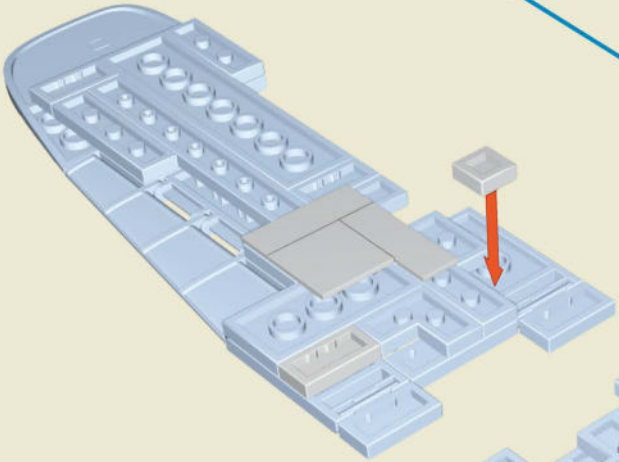

43

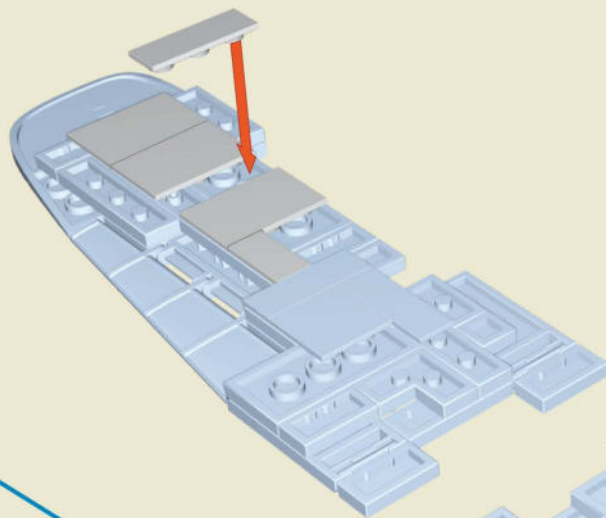





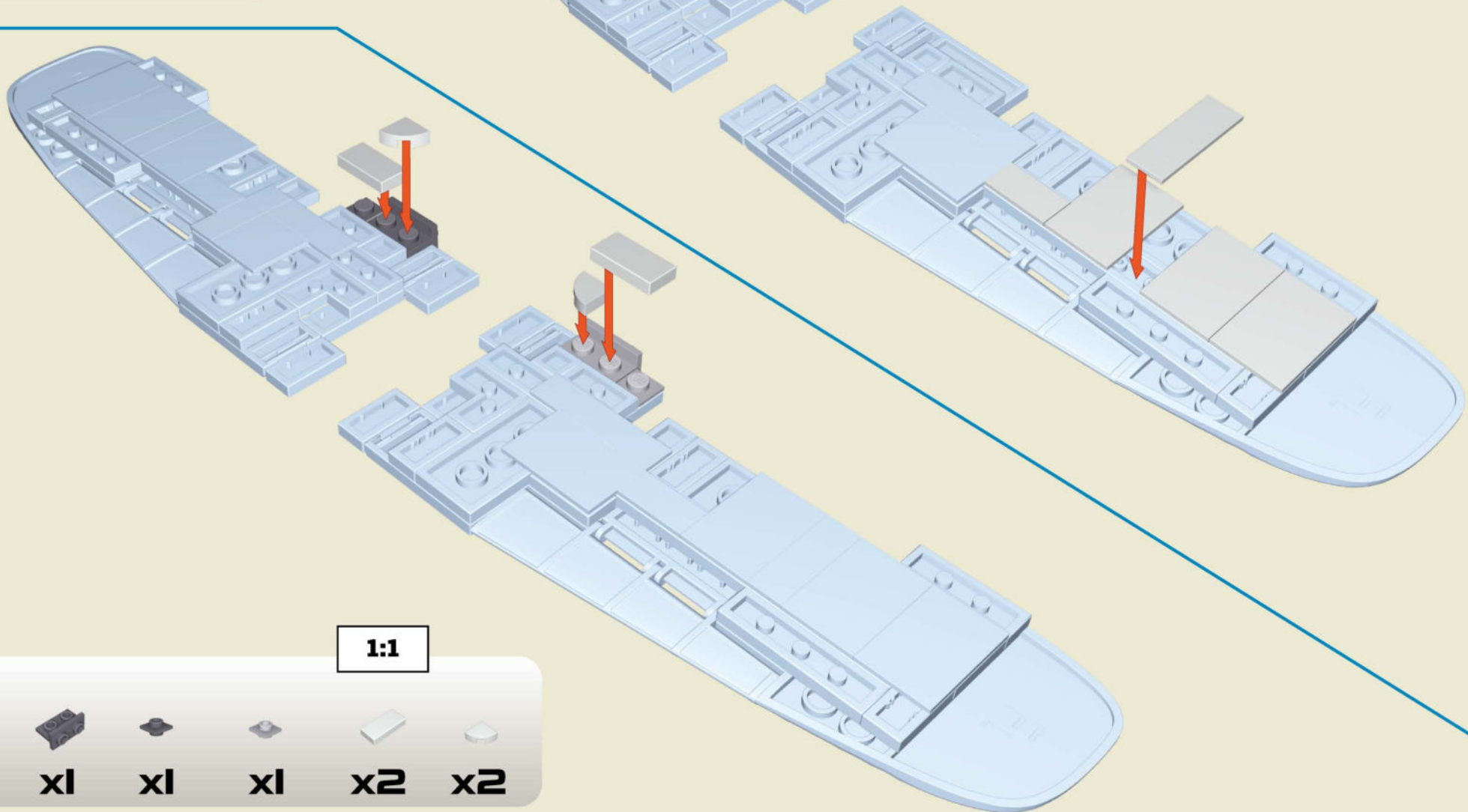

 **x6**  
  **x2**  
  **x2**

44



1:1

 **x1**  
  **x1**  
  **x1**  
  **x1**  
  **x2**  
  **x2**

45



x4



x4

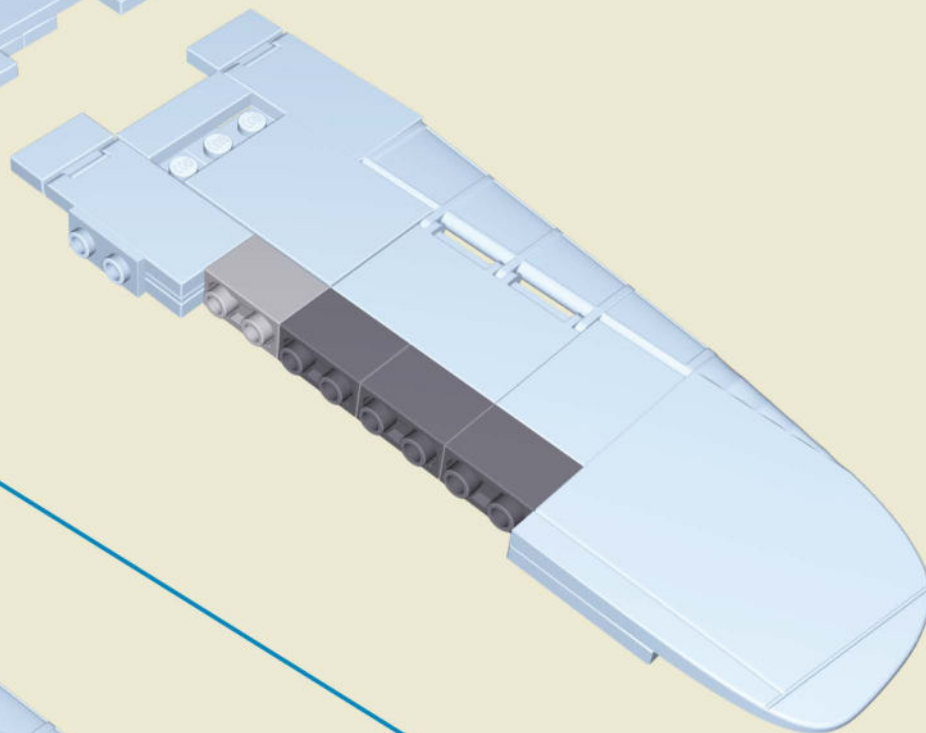
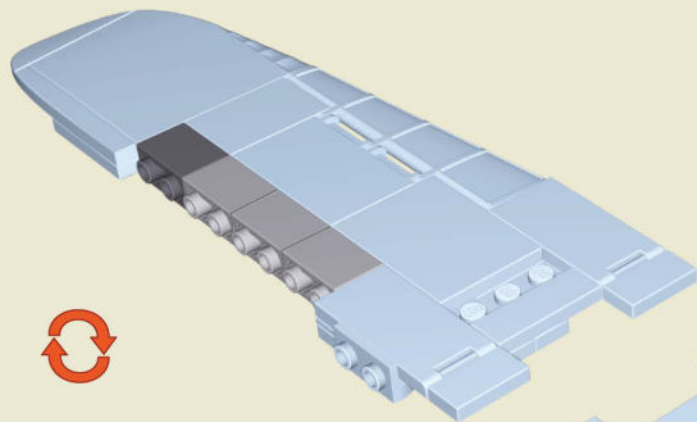

46

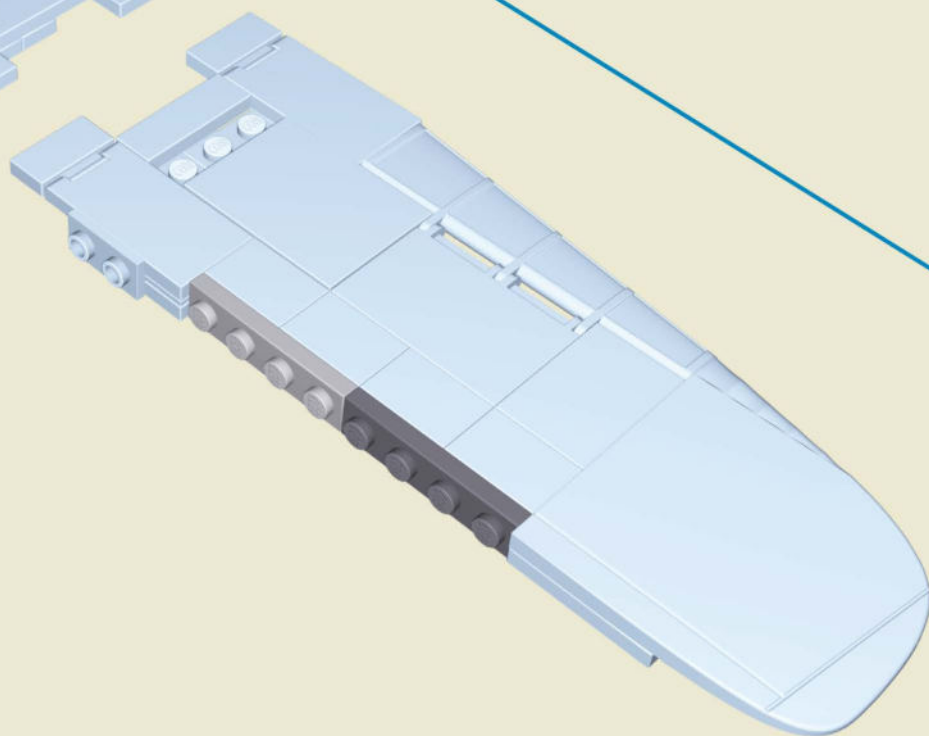
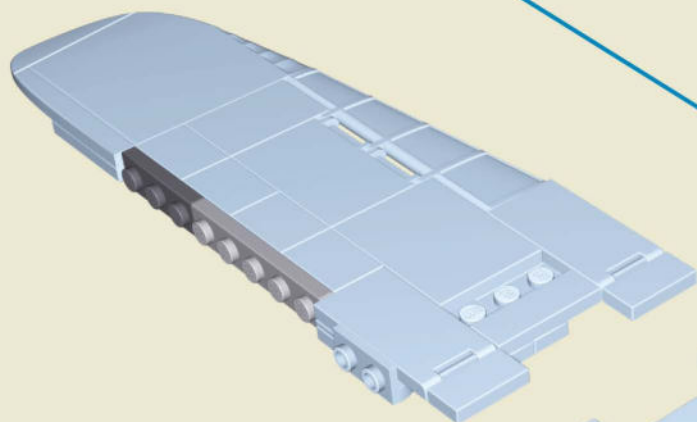

x1



x1



x1



x1





47

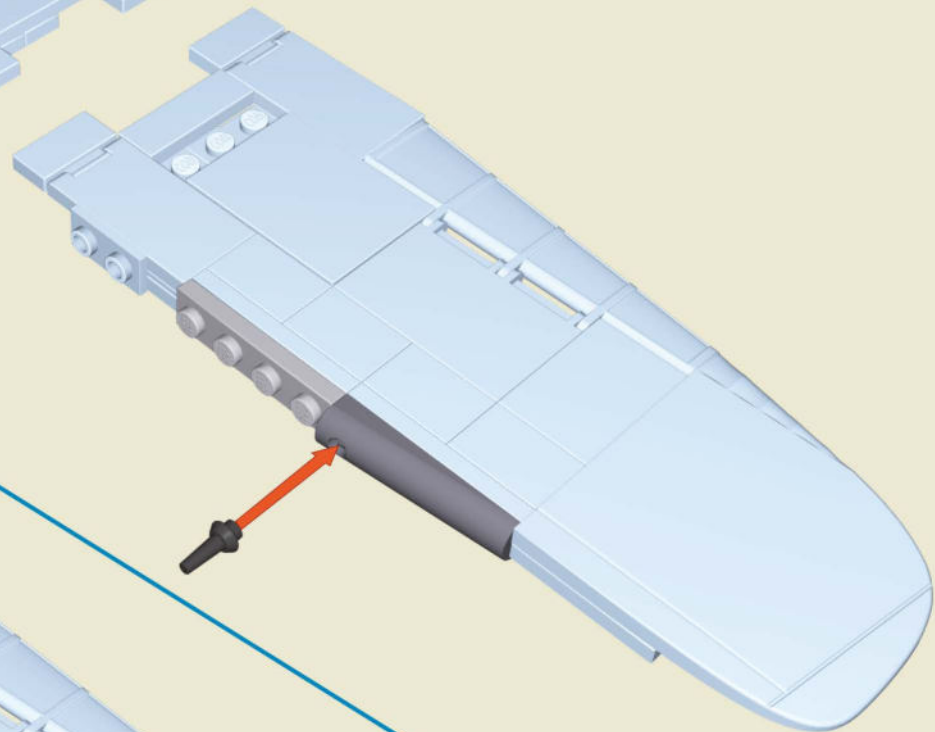
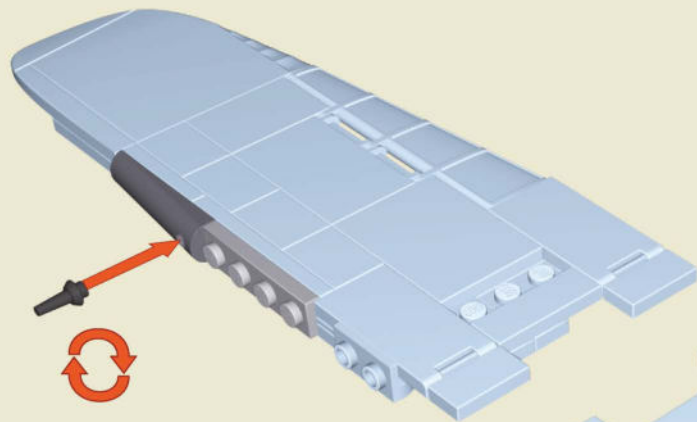

BE CAREFUL: NOTICE THE DIFFERENCE  
A B

 **x2**   
  **x2**   
  **x2** <sup>A</sup>



48

 **x2**   
  **x1**   
  **x1**

 **x2**   
  **x2**

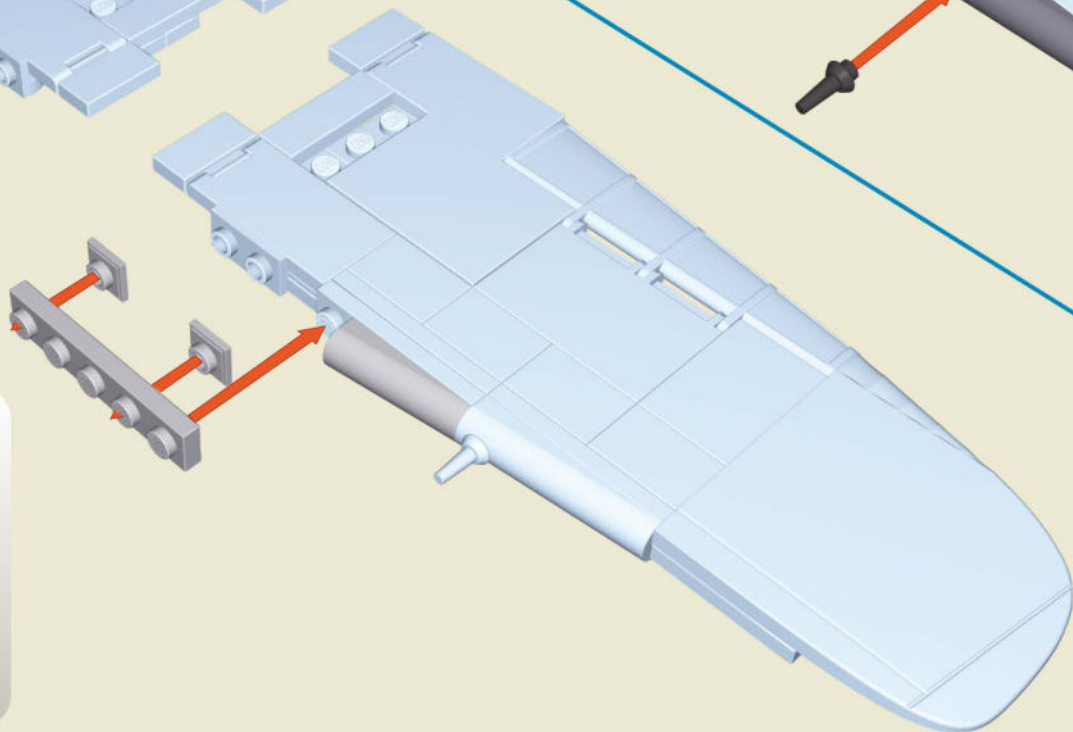
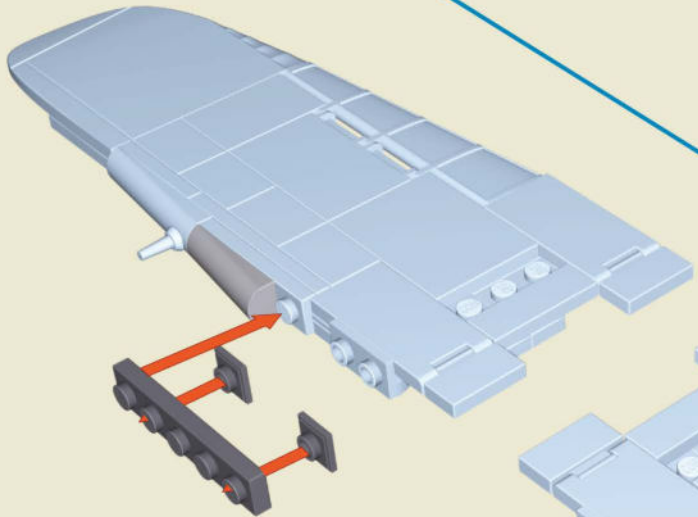

49

xi xi xi xi

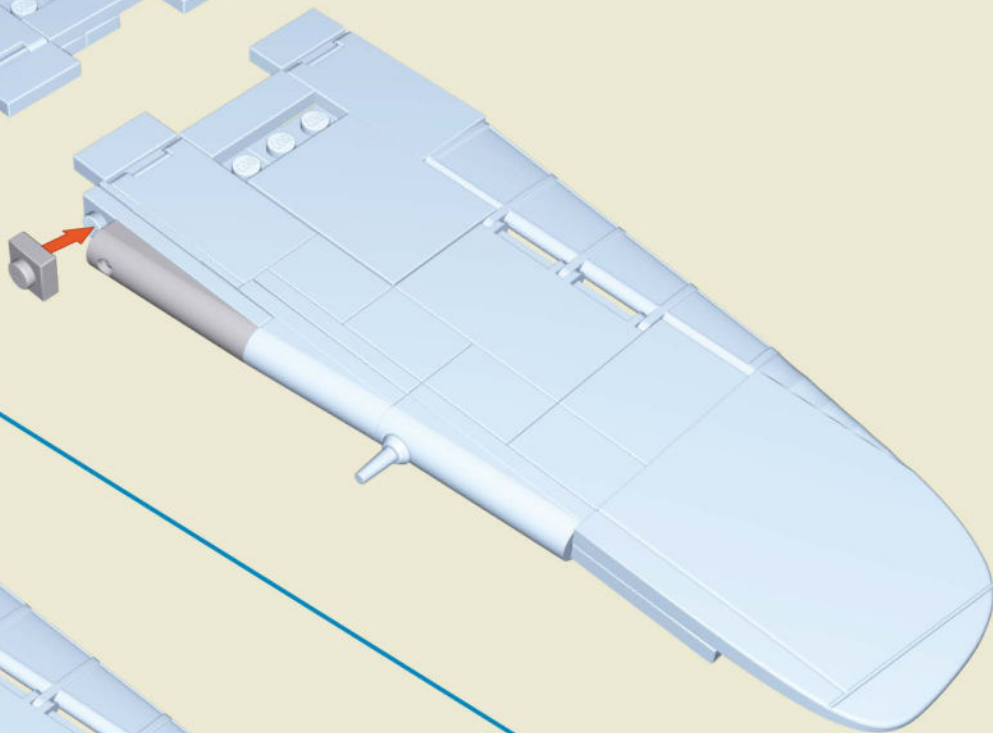
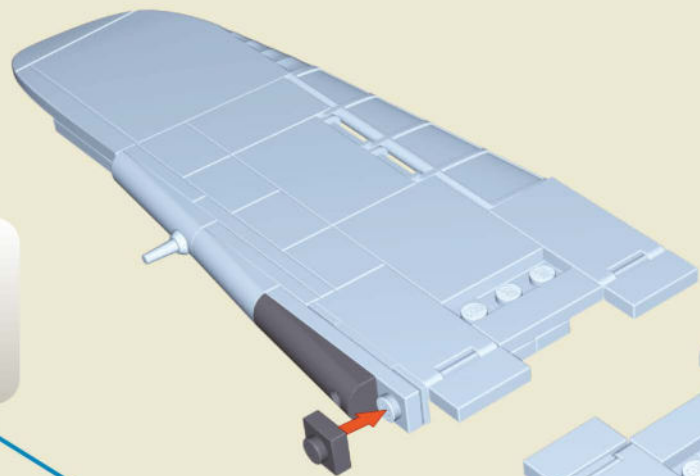

50

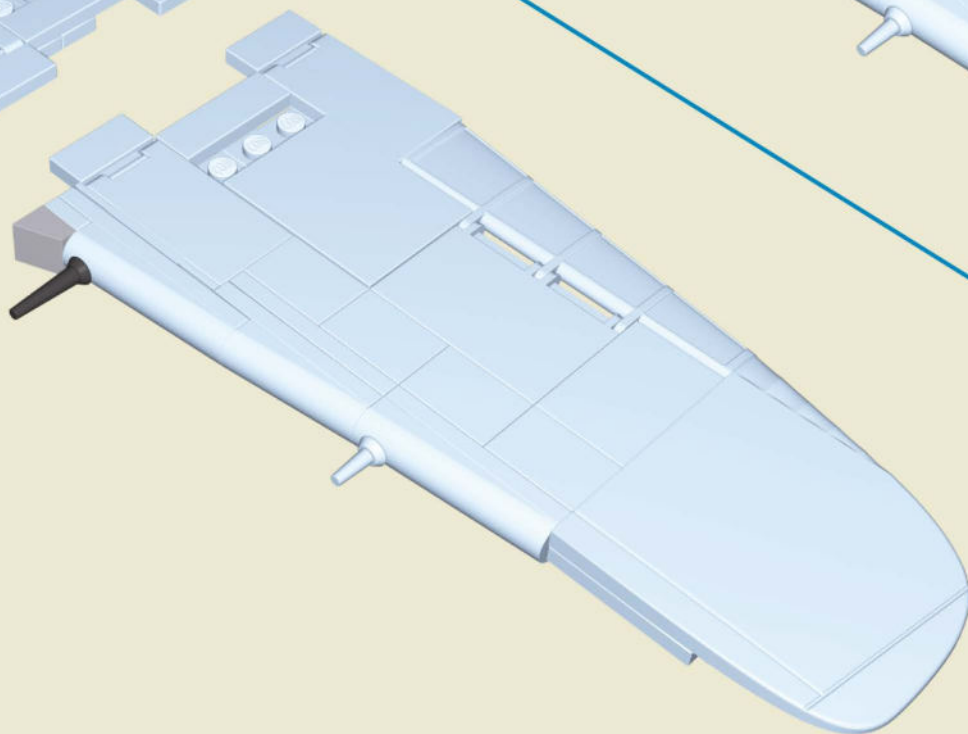
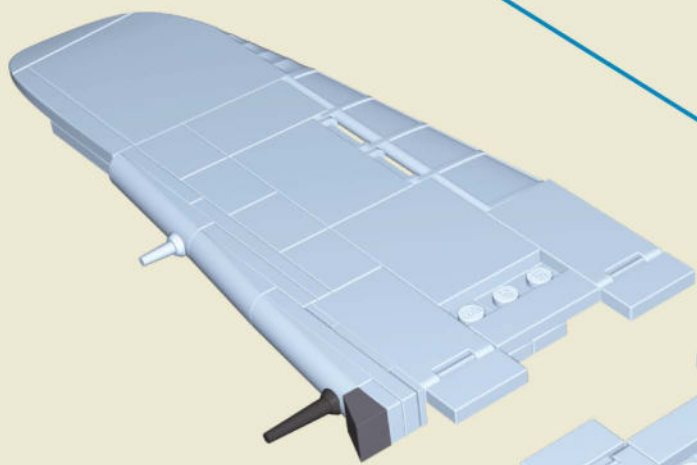

x2 xi xi

51

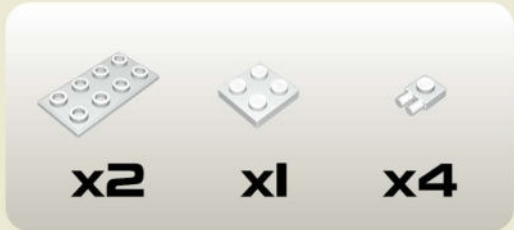
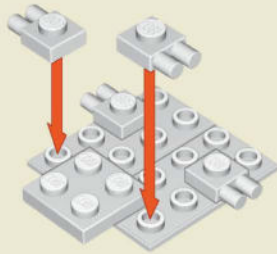

52

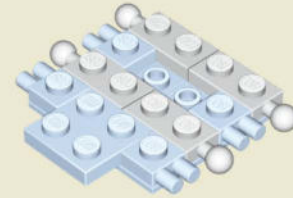

53

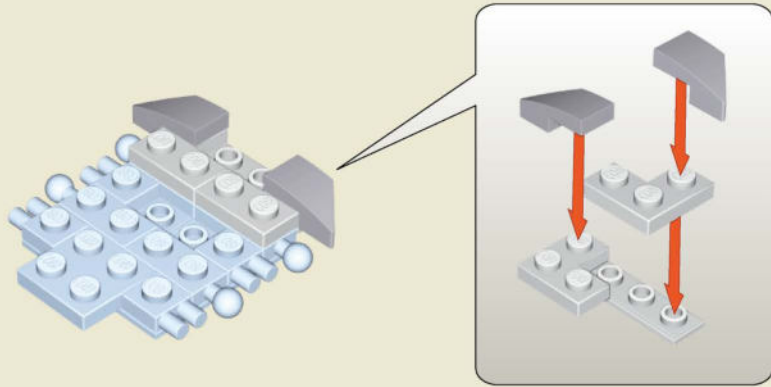

54

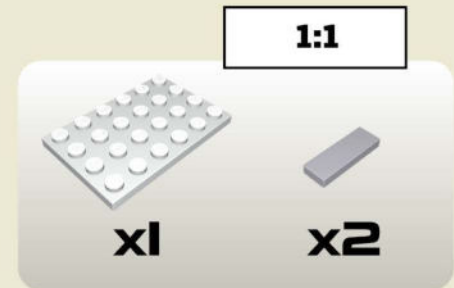
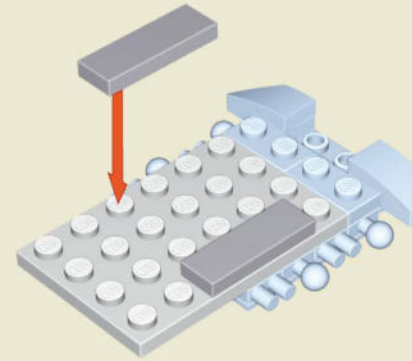



55

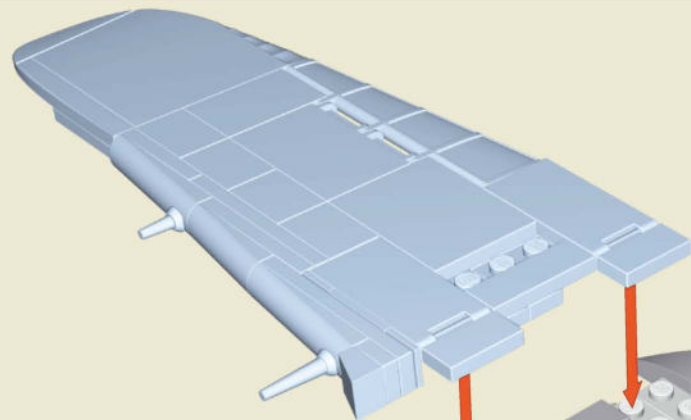

56

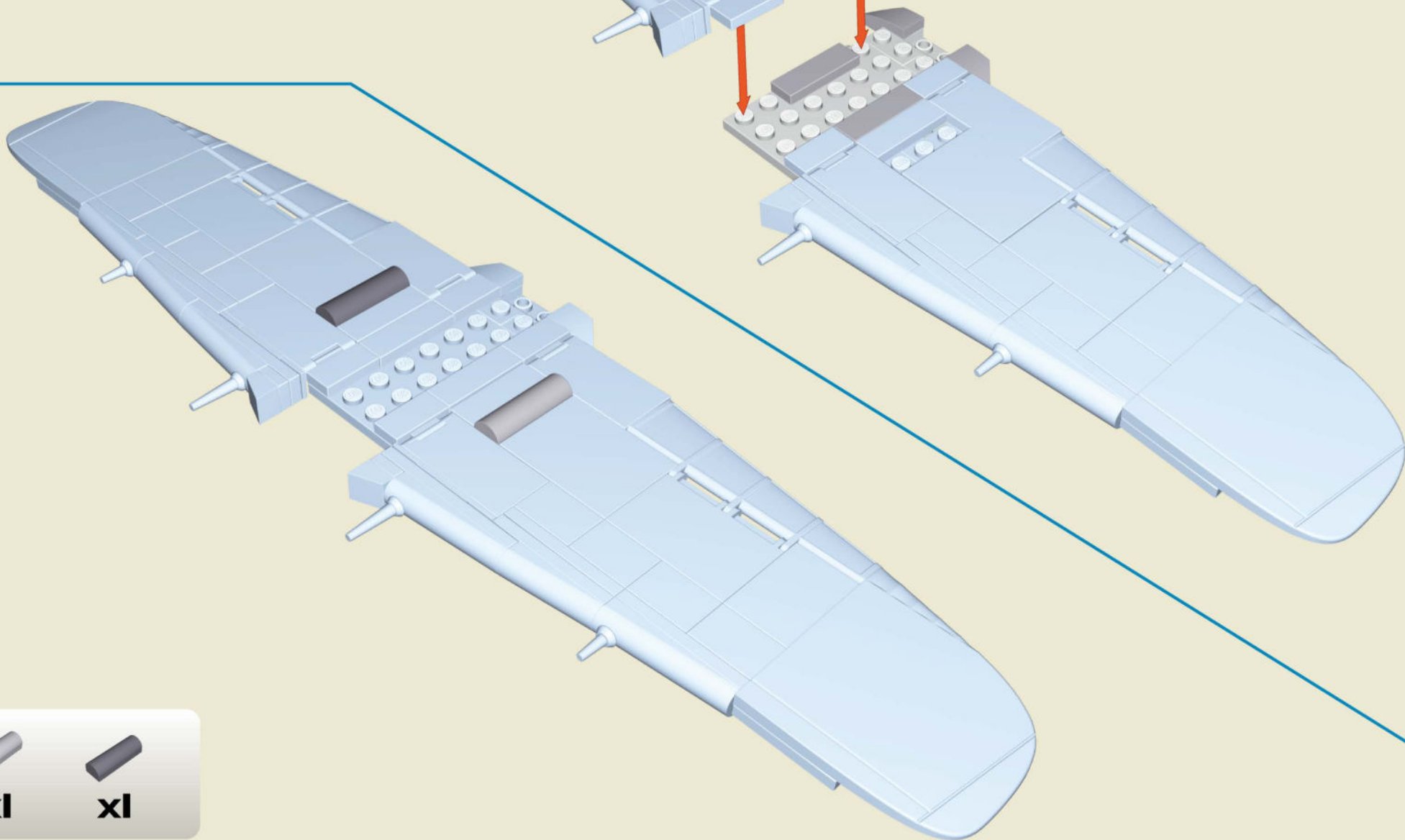

x1



x1

57

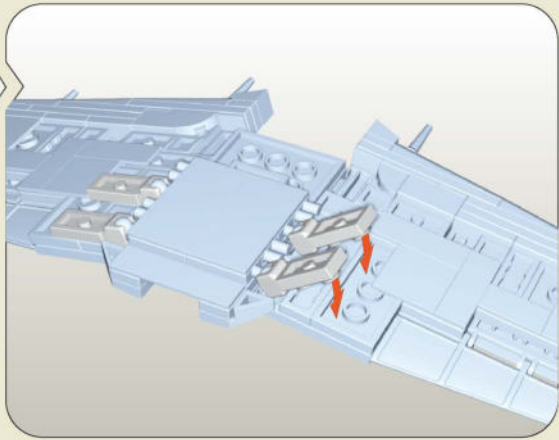
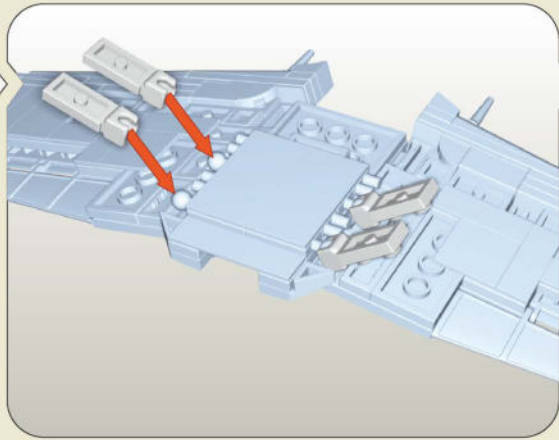
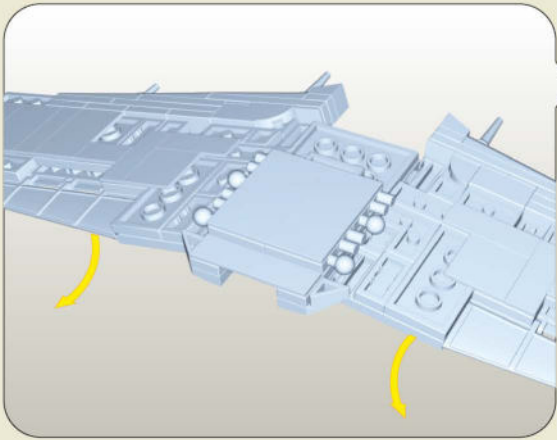

-  x4
-  x4
-  x2

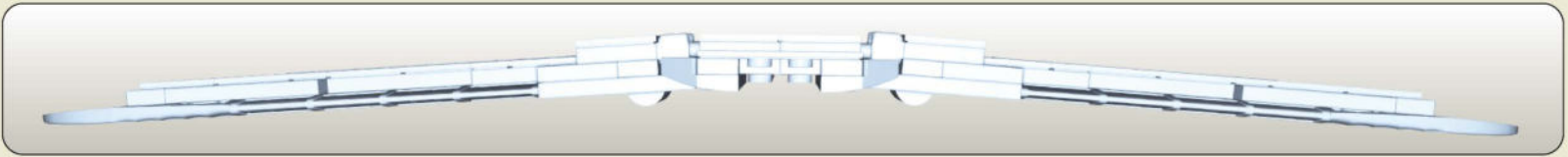
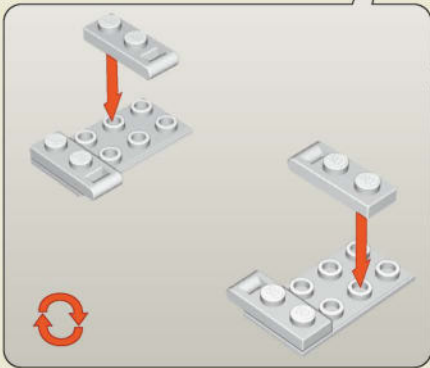
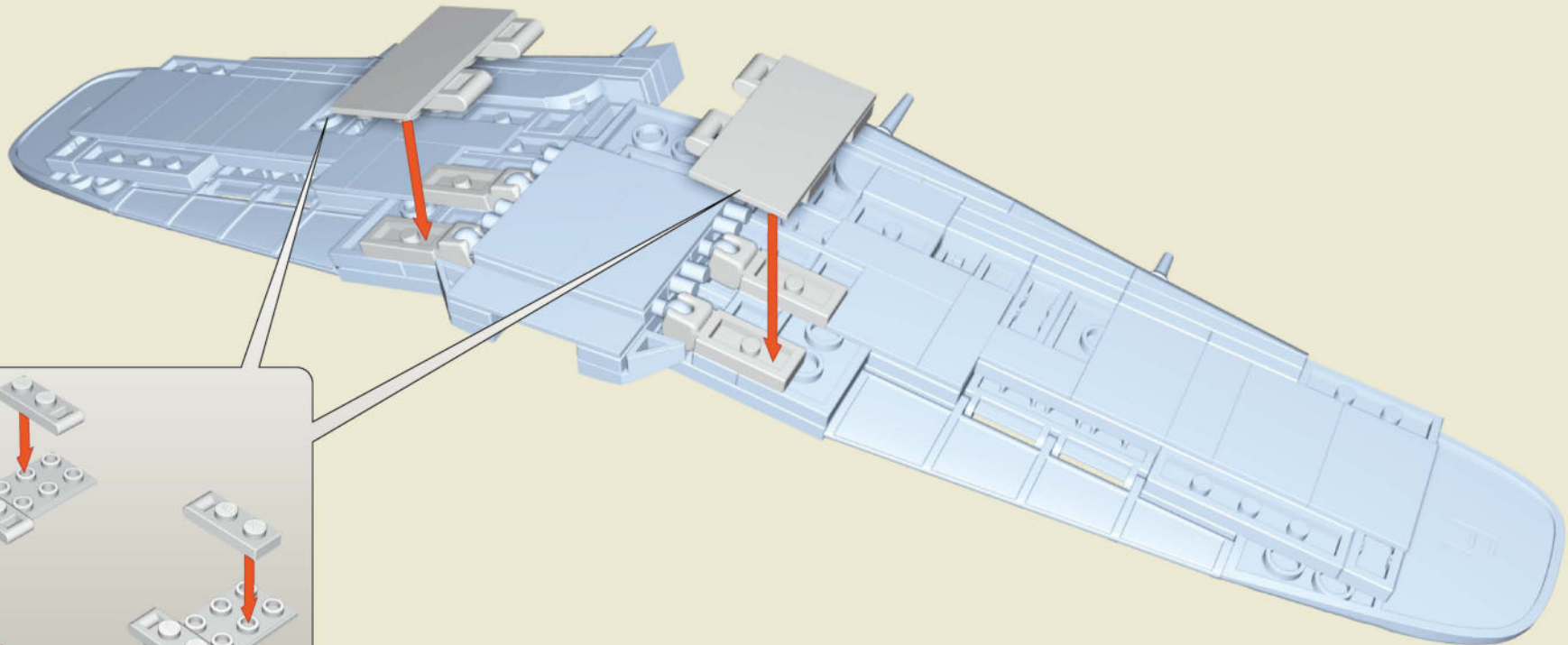

58

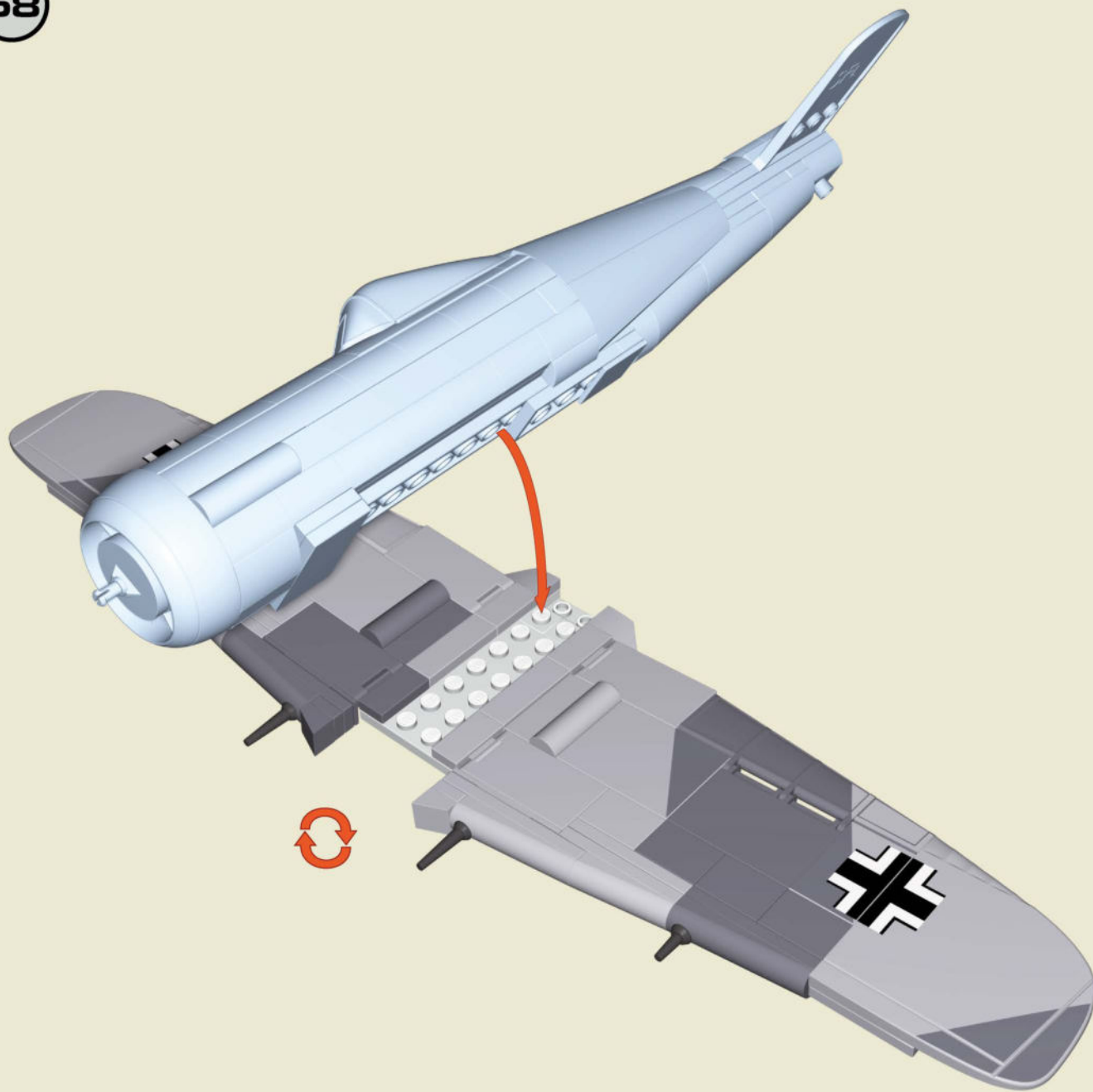

59

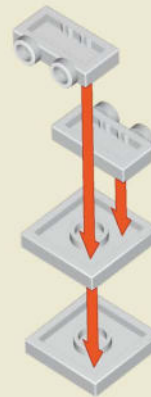

 x2

 x2

60

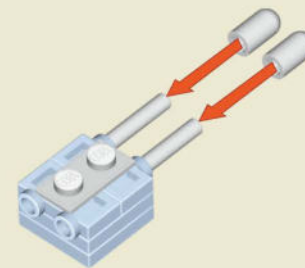

 x1

 x2

 x2

61

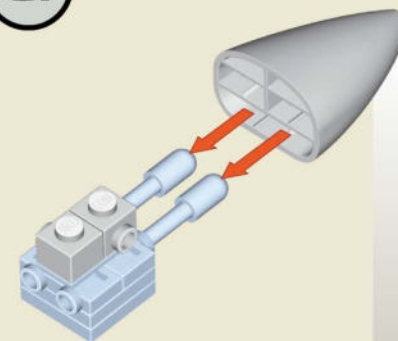

 x2

 x1



62

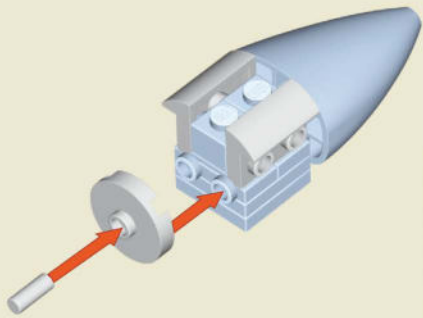

<b>x2</b>	<b>x1</b>	<b>x1</b>

63

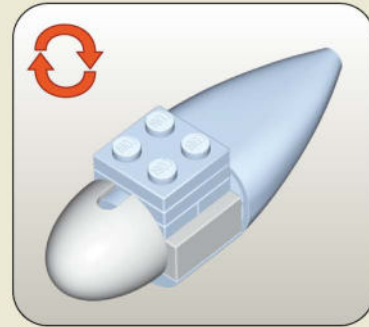
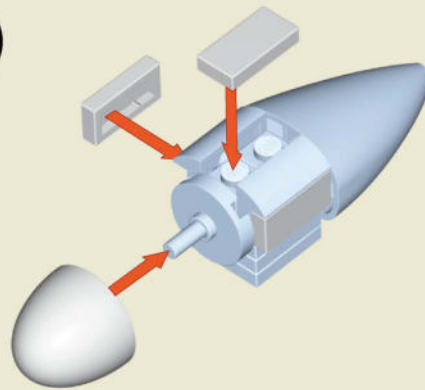

64

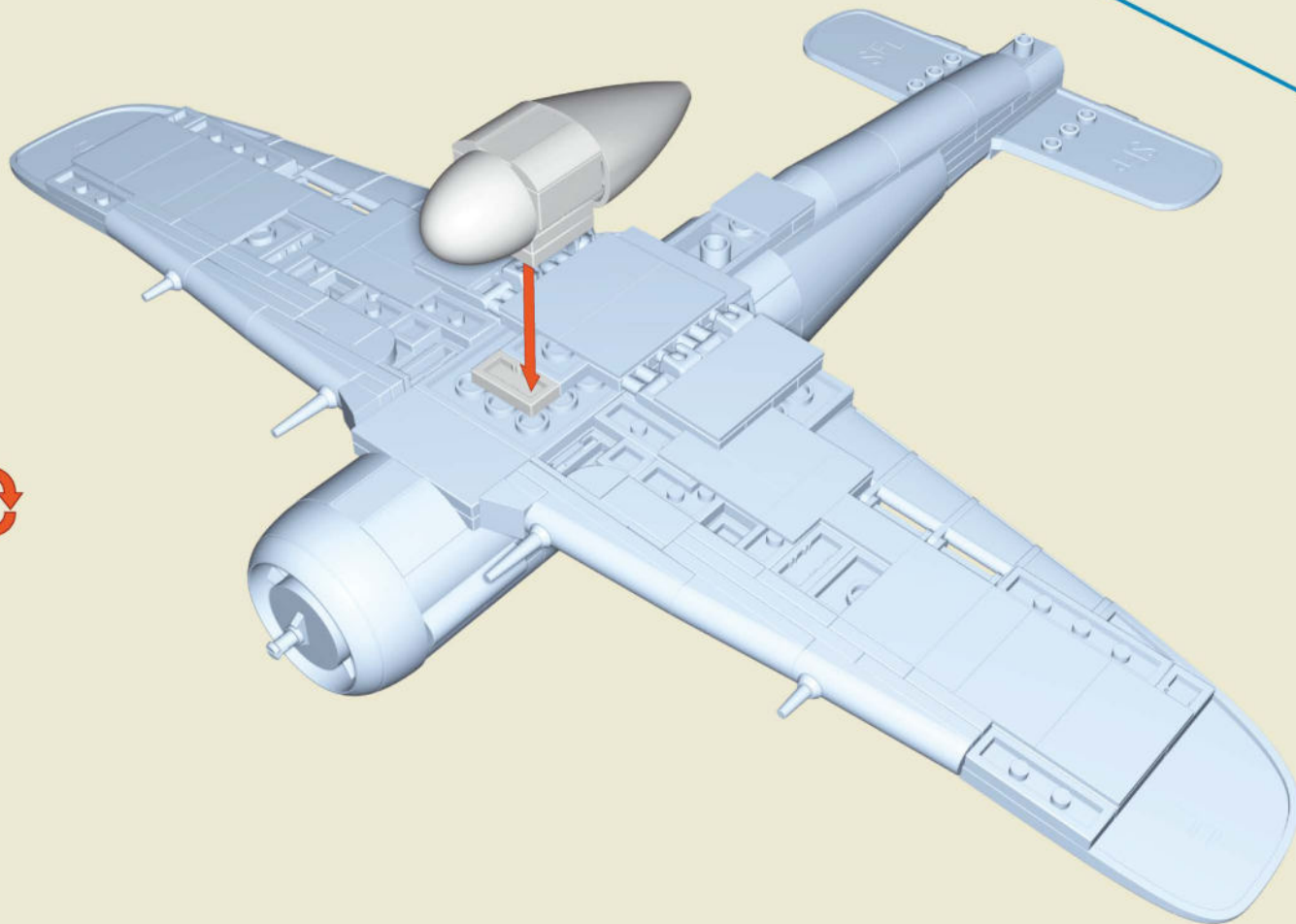

1:1

<b>x3</b>	<b>x1</b>



<b>x1</b>

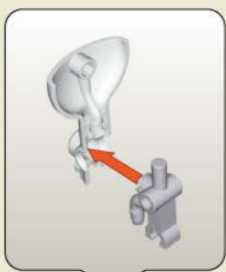
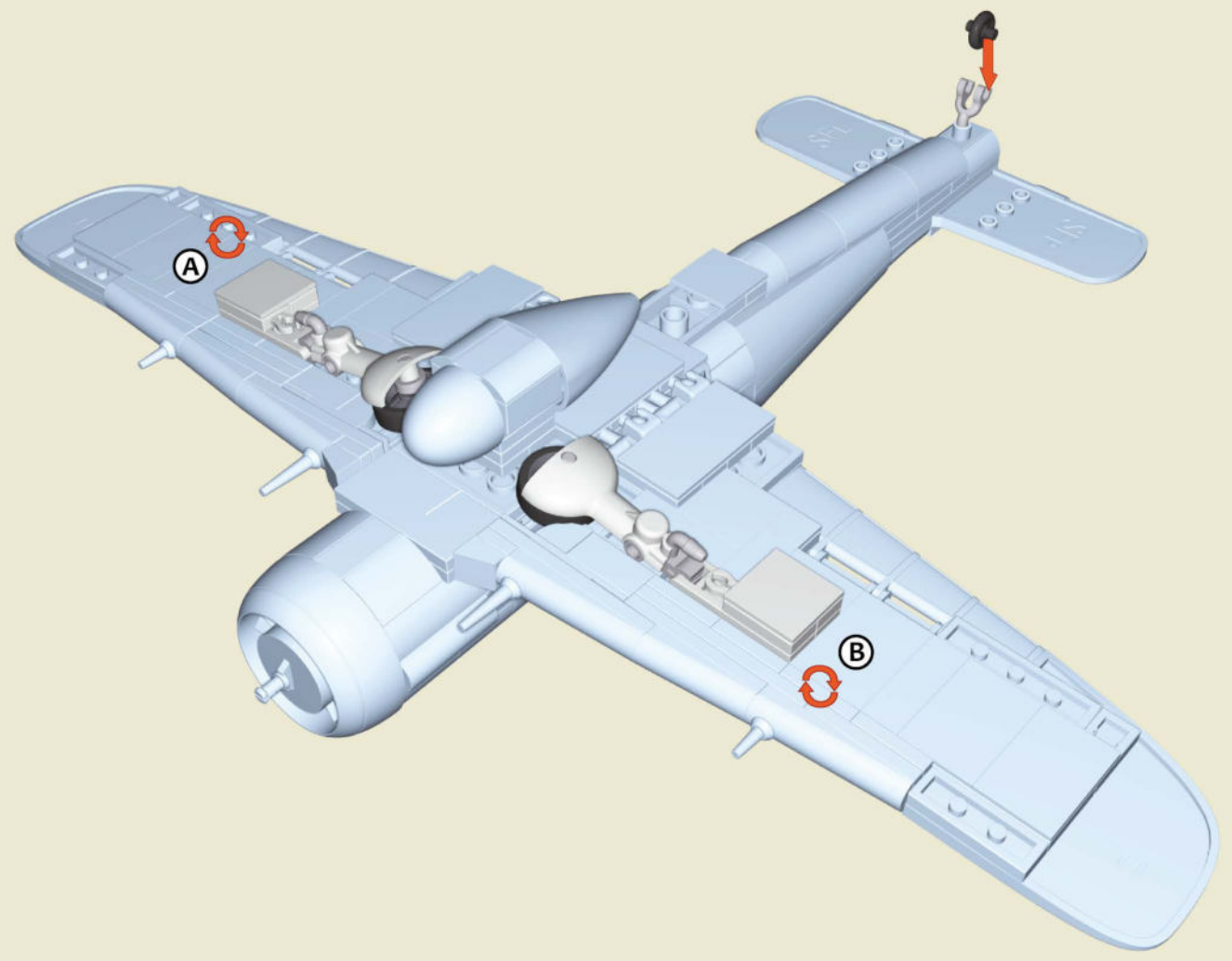

x2

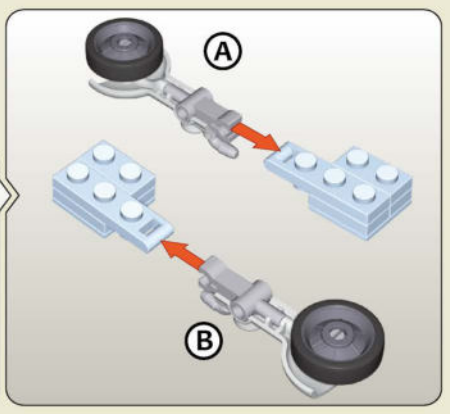
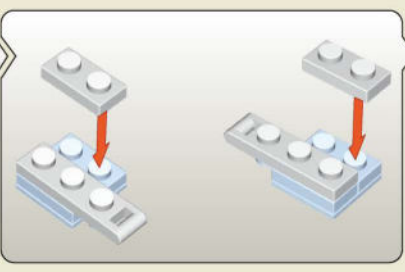
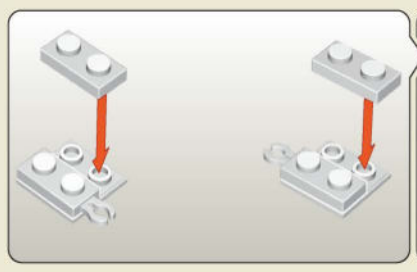

- |           |           |           |           |           |           |
|-----------|-----------|-----------|-----------|-----------|-----------|
|           |           |           |           |           |           |
| <b>x2</b> | <b>x2</b> | <b>x4</b> | <b>x2</b> | <b>x2</b> | <b>x2</b> |
|           |           |           |           |           |           |
| <b>x2</b> | <b>x2</b> | <b>x2</b> | <b>x1</b> | <b>x1</b> |           |

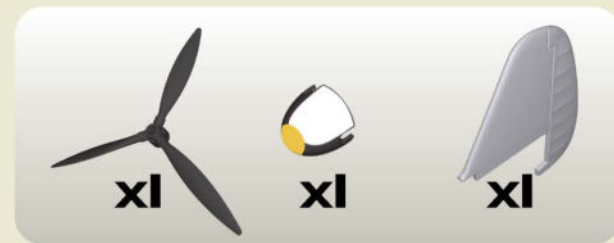
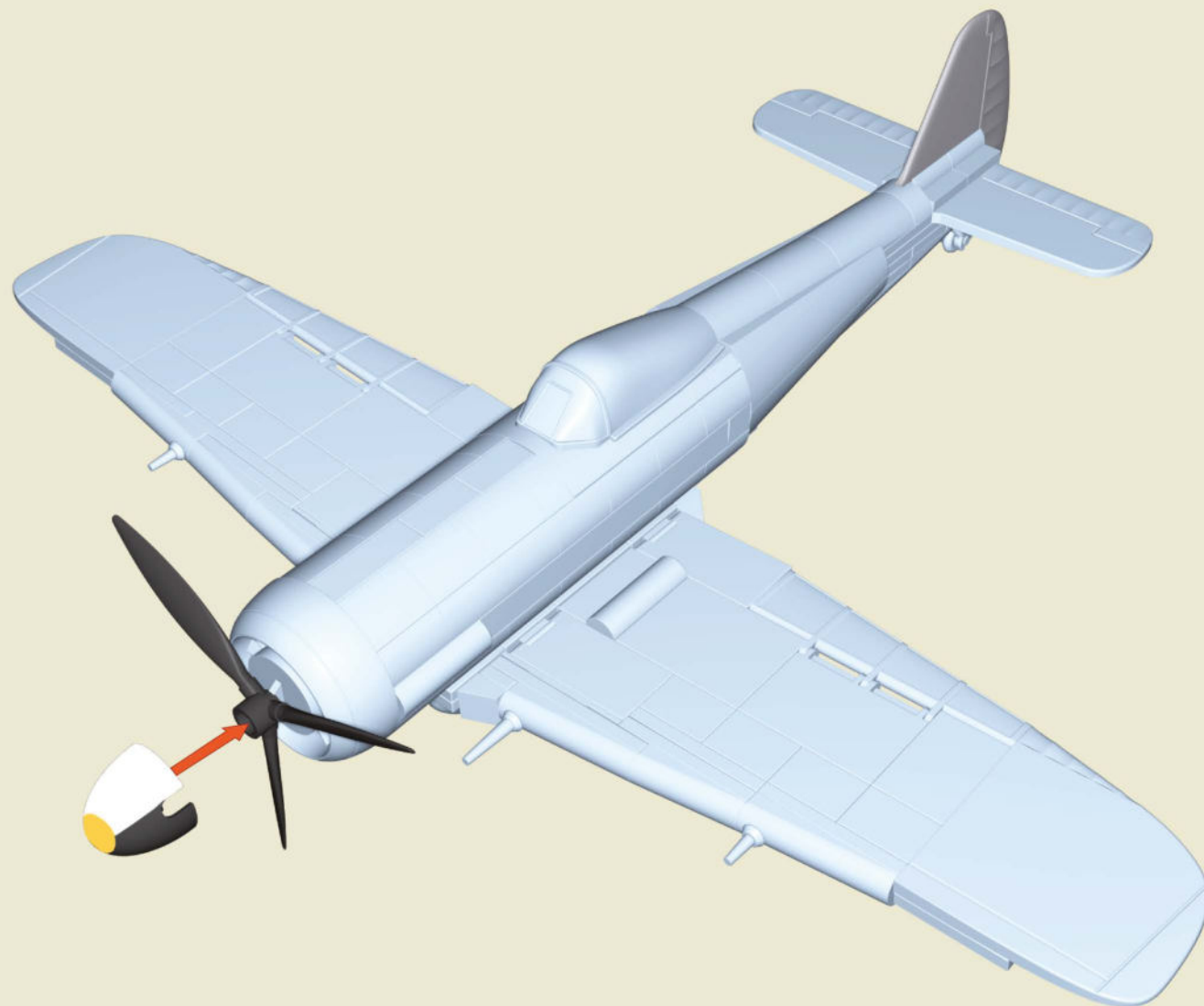



67

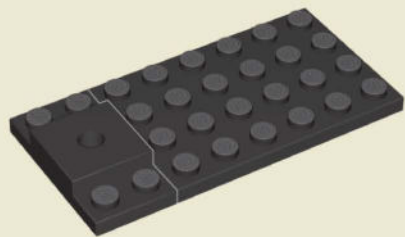

68

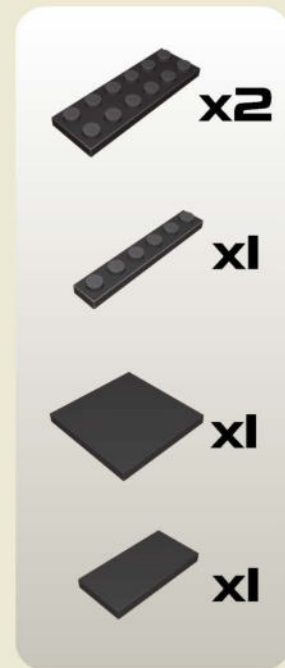
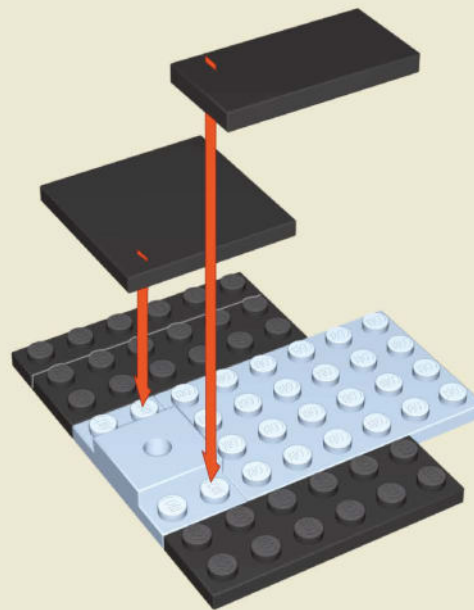

69

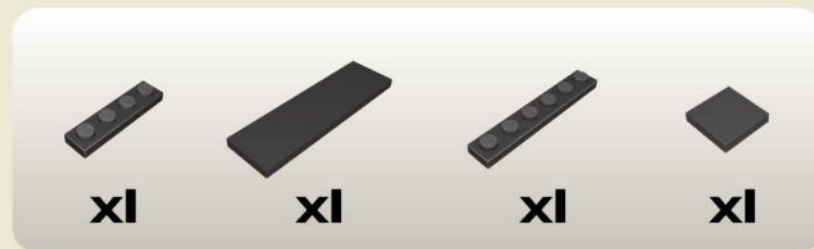
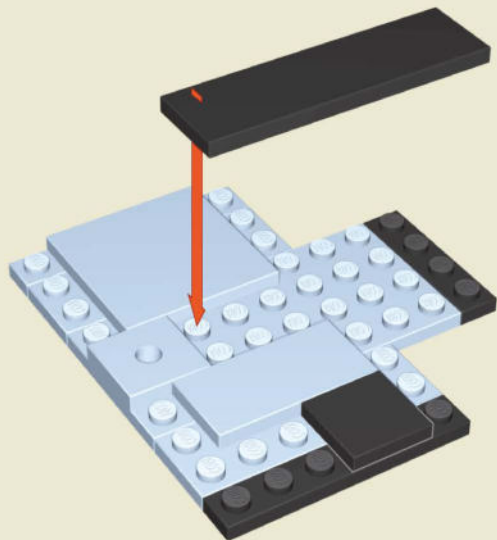

70

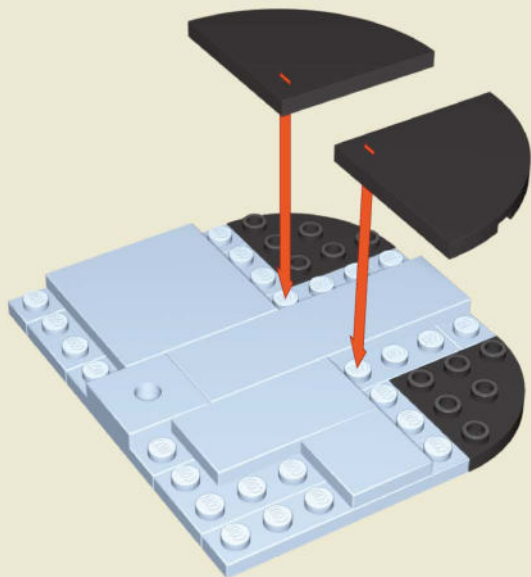

71

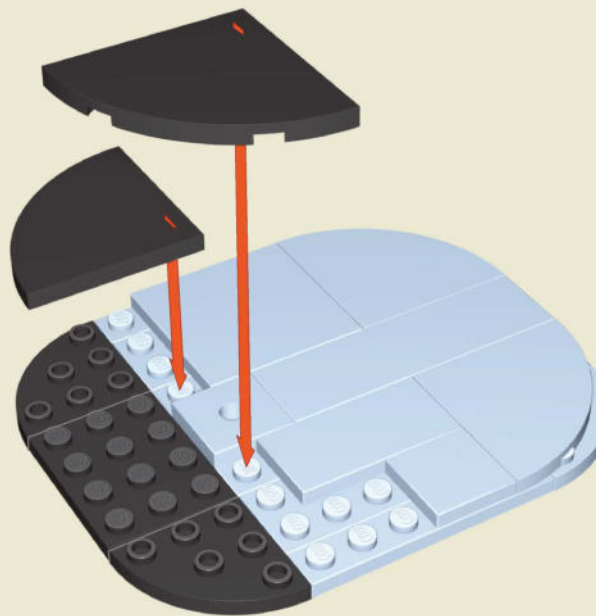

72

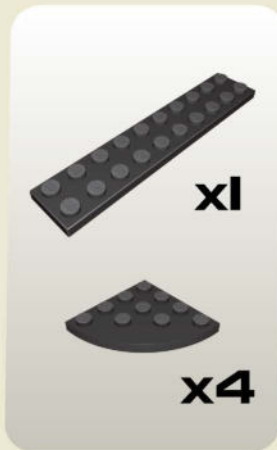
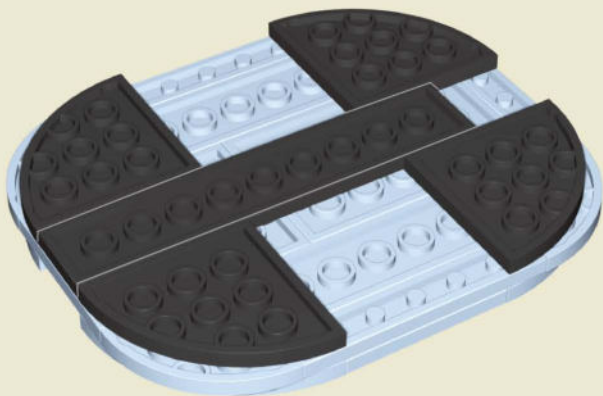

73



1:1

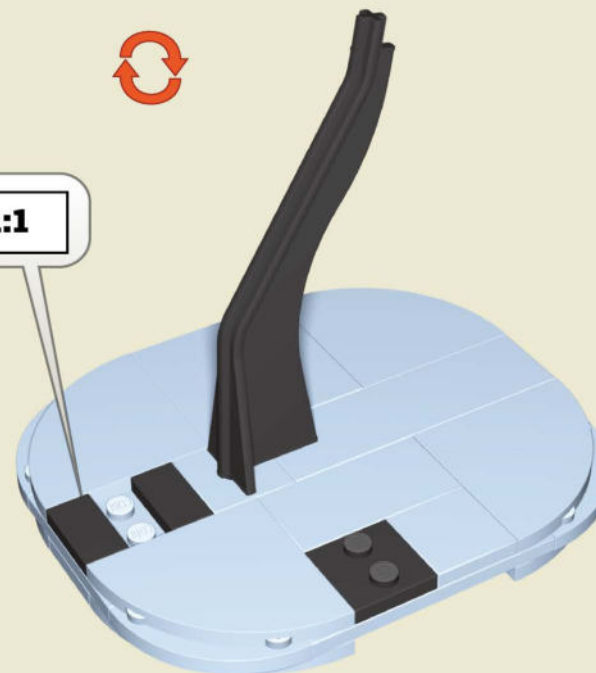

		
<b>x2</b>	<b>x1</b>	<b>x1</b>

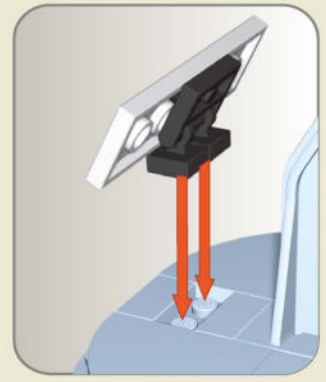
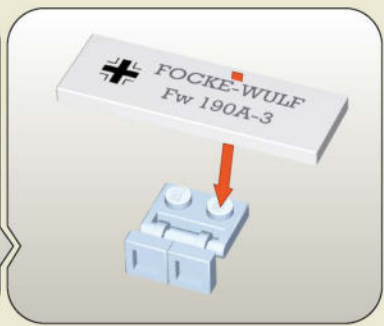
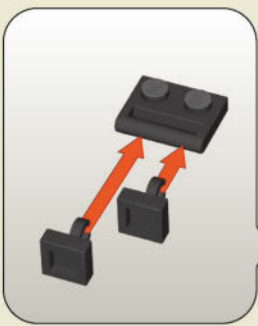
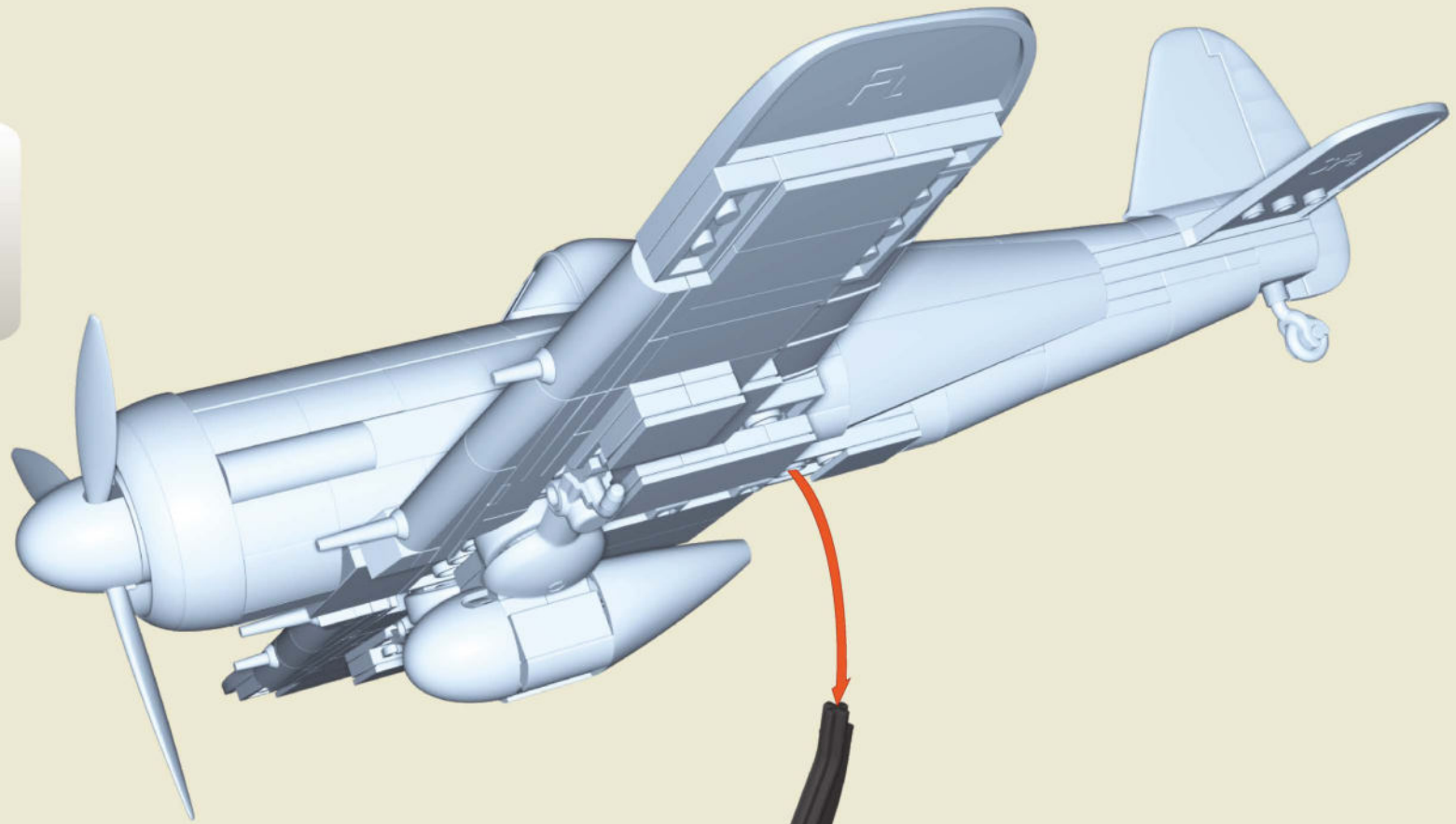



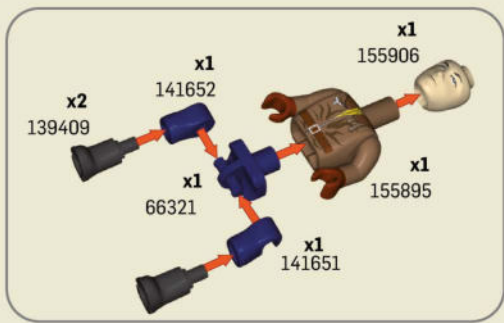

- |           |           |           |           |          |           |           |           |           |           |           |           |
|-----------|-----------|-----------|-----------|----------|-----------|-----------|-----------|-----------|-----------|-----------|-----------|
| x2 115177 | x2 108651 | x1 54631  | x2 92879  | x1 43971 | x2 144077 | x4 134796 | x2 43668  | x2 44969  |           |           |           |
| x12 90514 | x2 118296 | x2 98243  | x2 94080  | x1 85912 | x1 85894  | x2 132727 | x2 132144 | x1 141745 |           |           |           |
| x1 132145 | x2 42929  | x14 92647 | x1 43922  | x1 42937 | x3 92648  | x4 140734 | x4 142370 | x2 45158  | x2 51590  | x5 92882  | x1 53000  |
| x4 146280 | x2 131381 | x1 124779 | x4 146290 | x1 42950 | x1 127064 | x3 83925  | x1 139594 | x1 139593 | x2 93550  | x6 111184 | x2 114622 |
| x1 138718 | x1 155849 | x1 149710 | x1 57130  | x2 92652 | x2 43674  | x1 94600  | x1 155809 | x3 93456  | x1 108037 | x3 104561 | x2 123954 |
| x6 120912 | x3 42974  | x1 51558  | x2 92653  | x3 43676 | x2 124773 | x1 60522  | x1 118995 | x3 142499 | x1 142500 | x1 134795 | x1 67314  |
| x2 64204  | x2 43015  | x1 83573  | x2 43031  | x2 43047 | x2 92646  | x1 67220  | x2 43082  | x3 92658  | x1 43685  | x3 43090  | x2 44140  |
| x3 44684  | x2 92659  | x1 155813 | x1 155812 | x8 92884 | x3 106154 | x19 98305 | x1 142148 | x1 43112  | x1 77542  | x1 94510  | x5 122048 |
| x6 124624 | x1 132149 | x2 43152  | x1 43690  | x1 81103 | x3 77547  | x2 155213 | x2 135091 | x6 120917 | x5 43166  | x3 92898  | x1 53161  |
| x2 44690  | x1 43172  | x1 53025  | x3 98307  | x1 93452 | x1 100658 | x1 98868  | x1 106156 | x1 98983  | x4 119721 | x3 43192  | x1 155816 |





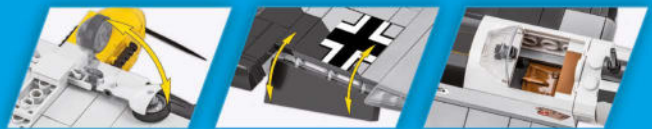

# HISTORICAL COLLECTION



MESSERSCHMITT BF 109 E-3  
+ 5727



FOCKE-WULF FW 190 A5  
+ 5722



**NORTHROP GRUMMAN**



P-47 THUNDERBOLT™  
⊙ 5737



PZL P.11c  
⊙ 5742

For news and special deals

Find us on:  
f cobibricks  
i cobiklocki  
y COBI SA

WWW.COBIBRICKS.COM

03-05741-379