

ARMED FORCES



Produced under license from Boeing. Boeing and F/A-18 Hornet are trademarks of The Boeing Company.



F/A-18C HORNET™
 IN US SERVICE - 1983 - PRESENT
 PLACE OF ORIGIN - USA
 ROLE - FIGHTER
 WINGSPAN - 11,7m (38' 5")
 LENGTH - 17,1m (56' 1")
 HEIGHT - 4,7m (15' 5")
 ENGINE - 2x GENERAL ELECTRIC F404-GE-402
 RANGE - 2000km (1070nm)
 RATE OF CLIMB - 250m/s (50000ft/min)
 MAXIMUM FLIGHT LEVEL - 16000m (52493ft)
 MAXIMUM SPEED - 1,8MACH
 ARMAMENT - 1x 20mm M61A1 GATLING CANNON,
 2x AIM-9X, 4x AIM-120B AMRAAM
 OR AIM-120C-7 AIR-TO-AIR MISSILES
 CREW - 1 PILOT

PAD PRINTED
 NO STICKERS

Printed in EU

5819



WARNING: CHOKING HAZARD-
 Toy contains small parts.
 Not for children under 3 years.

540

F/A-18C HORNET™

SCALE 1:48

1



2

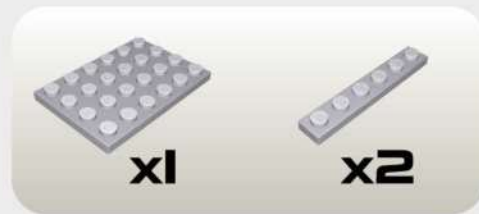
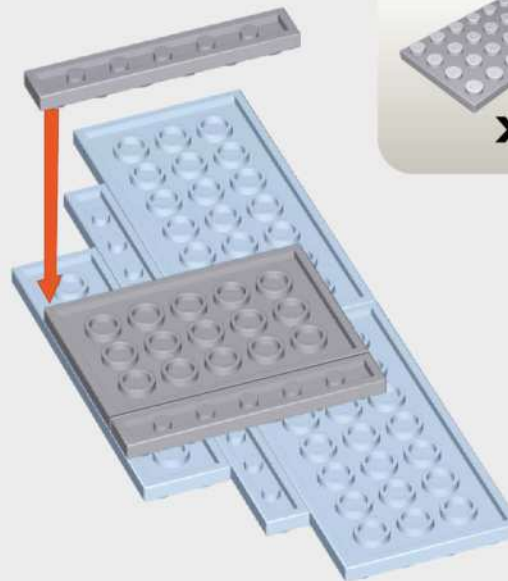

3

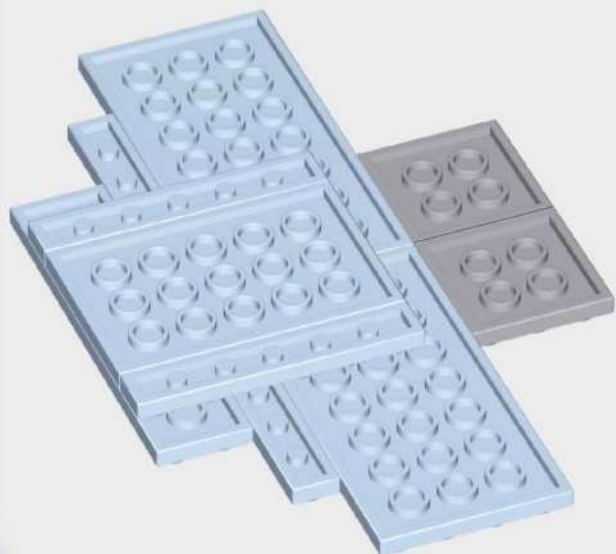

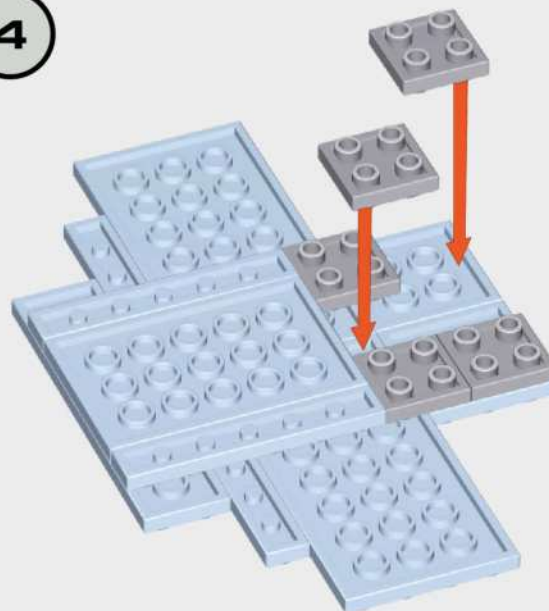

4

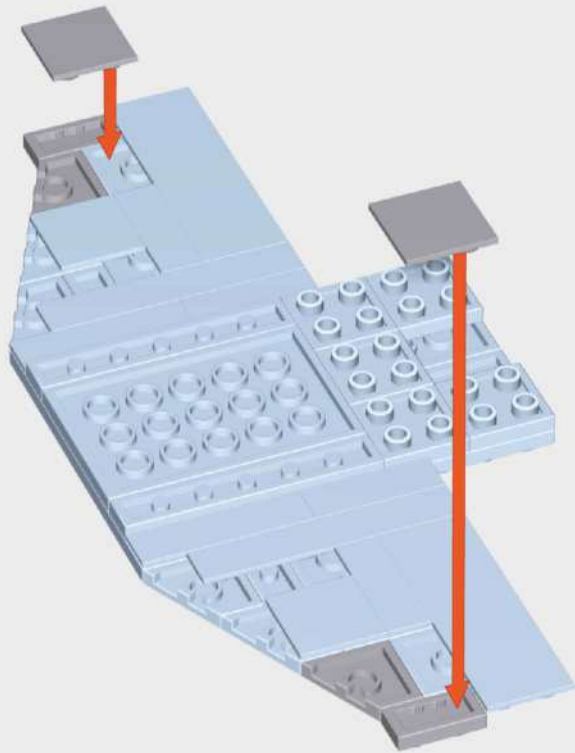

8



	
x1	x1
	
x2	x2

9

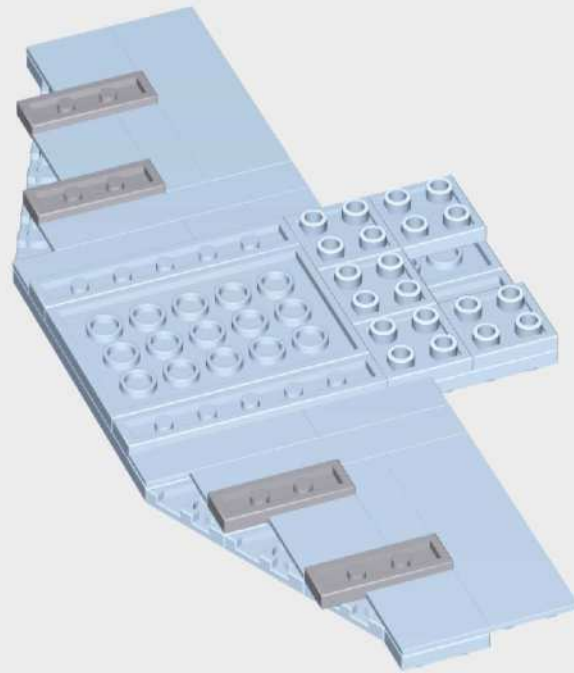



x4

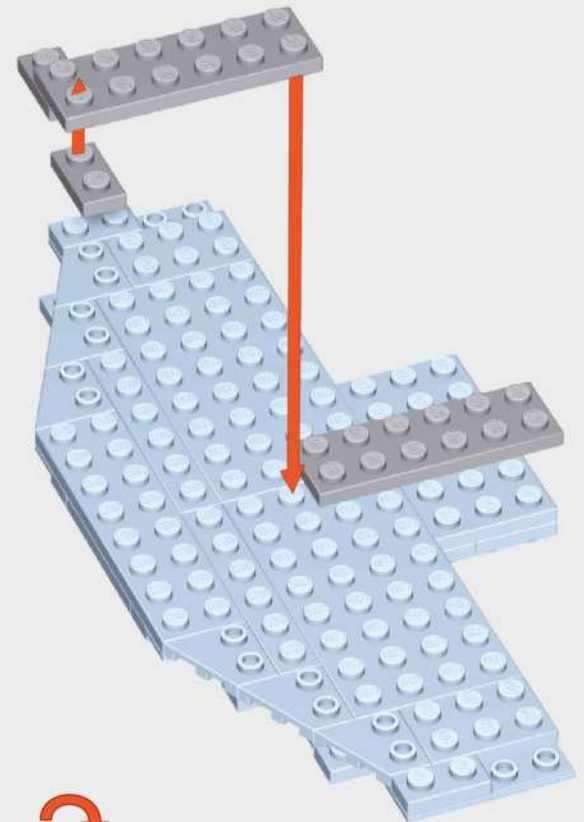

10

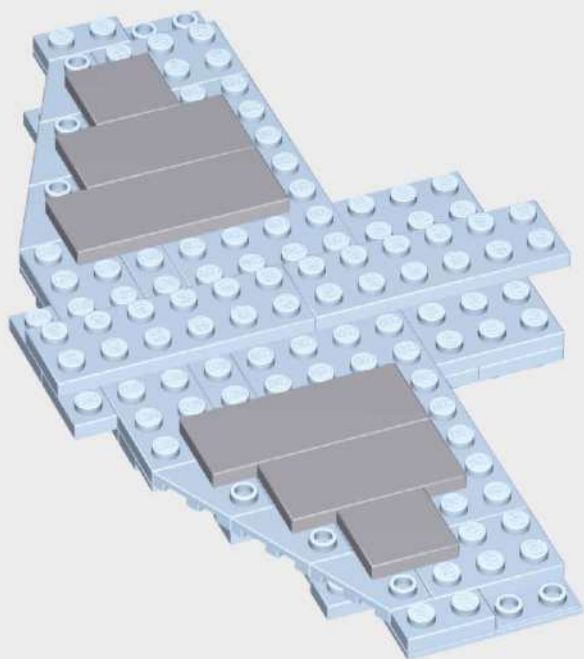

	
x2	x2



11

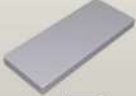

 **x2**  **x2**
 **x2**

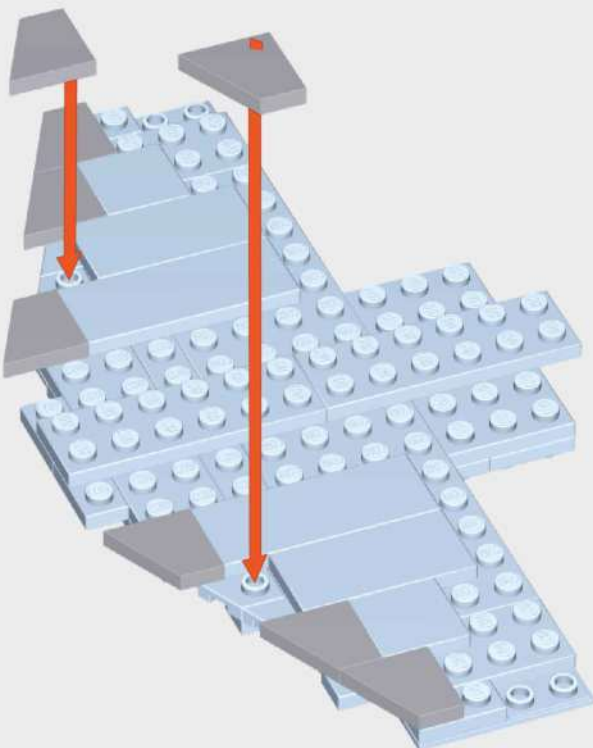



12

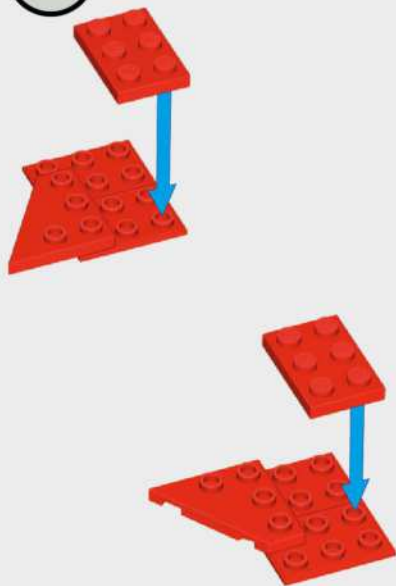

 **x4**  **x4**



13



 **x4**
 **x1**
 **x1**
 **x2**

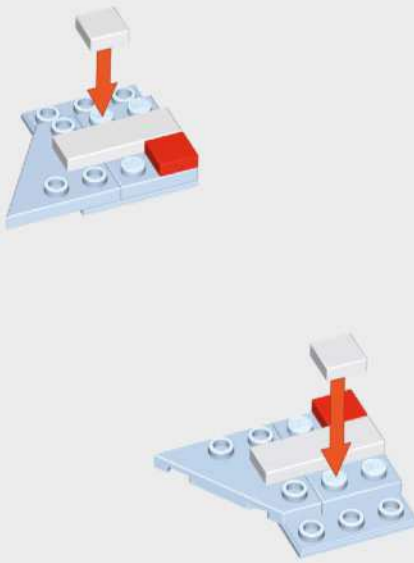



14

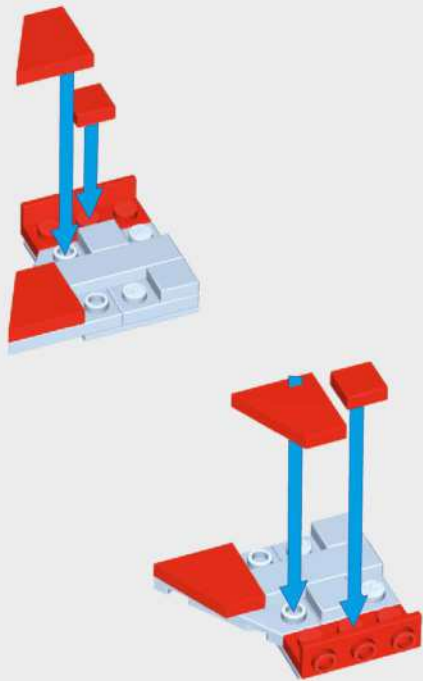

1:1
 **x2**
 **x2**
 **x2**

15



	
x2	x2
	
x2	x2

16

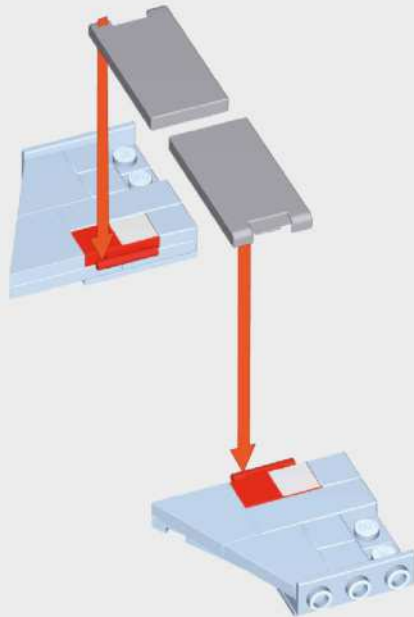

		
x1	x1	x2

17

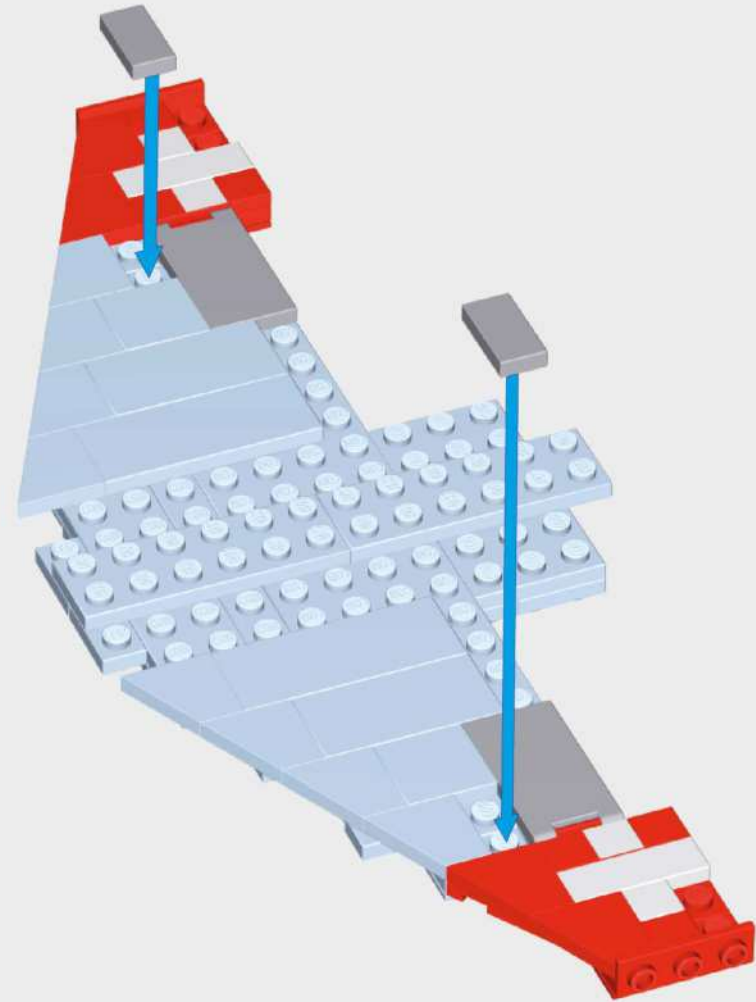

1:1

x2

18

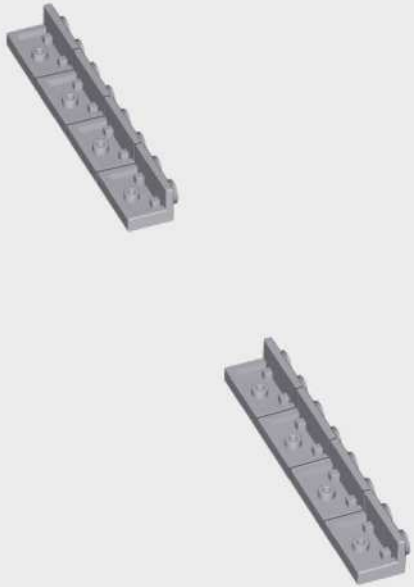

19

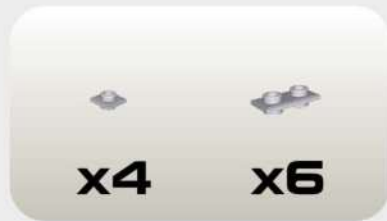
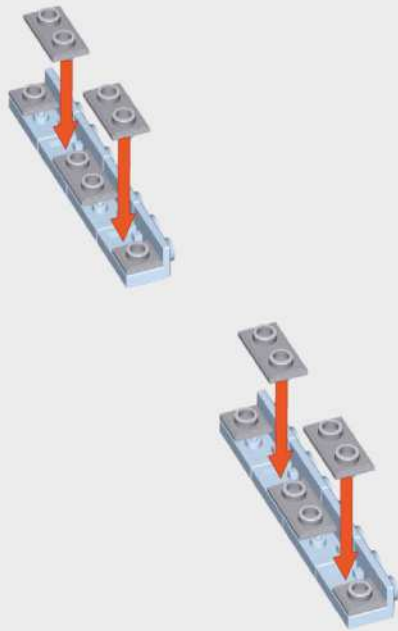

20

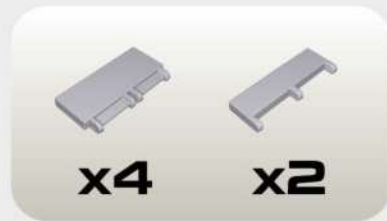
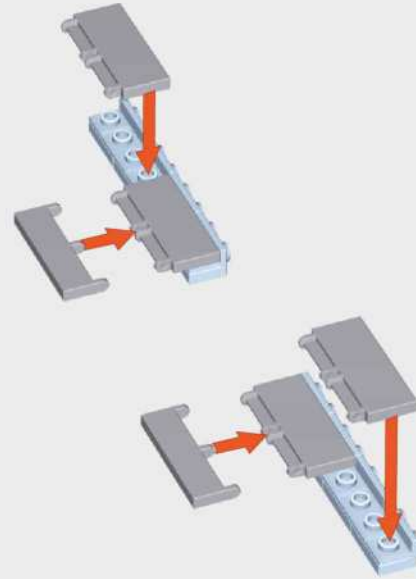

21

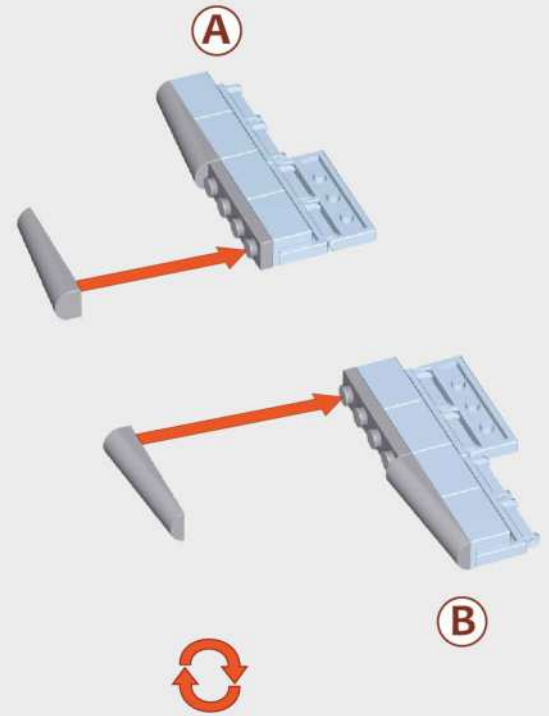

22

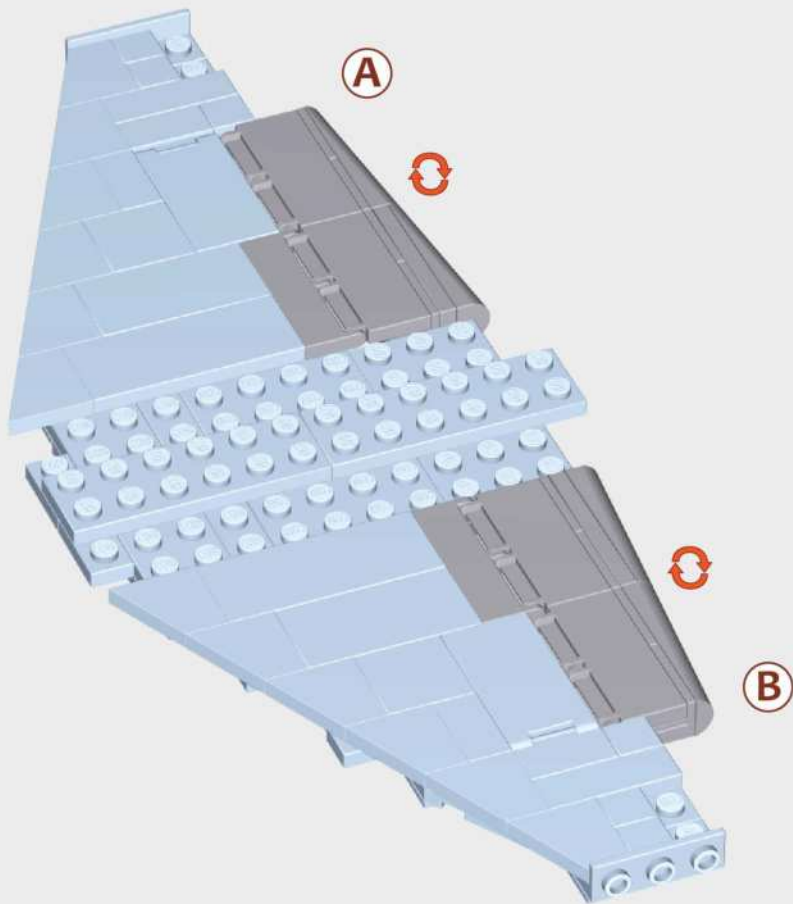

23

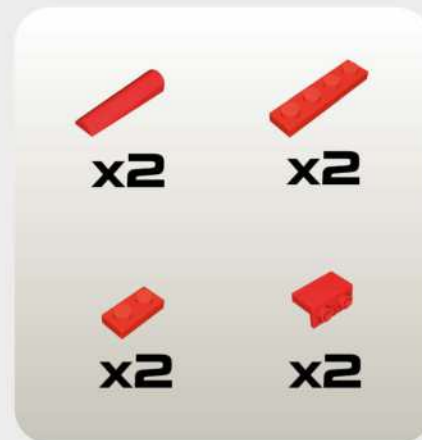
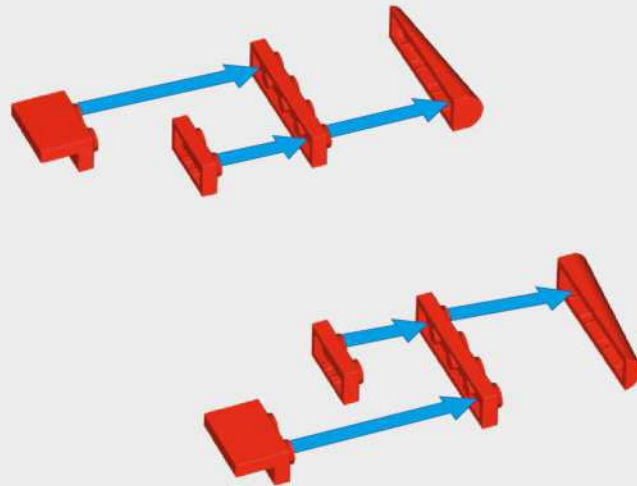

24

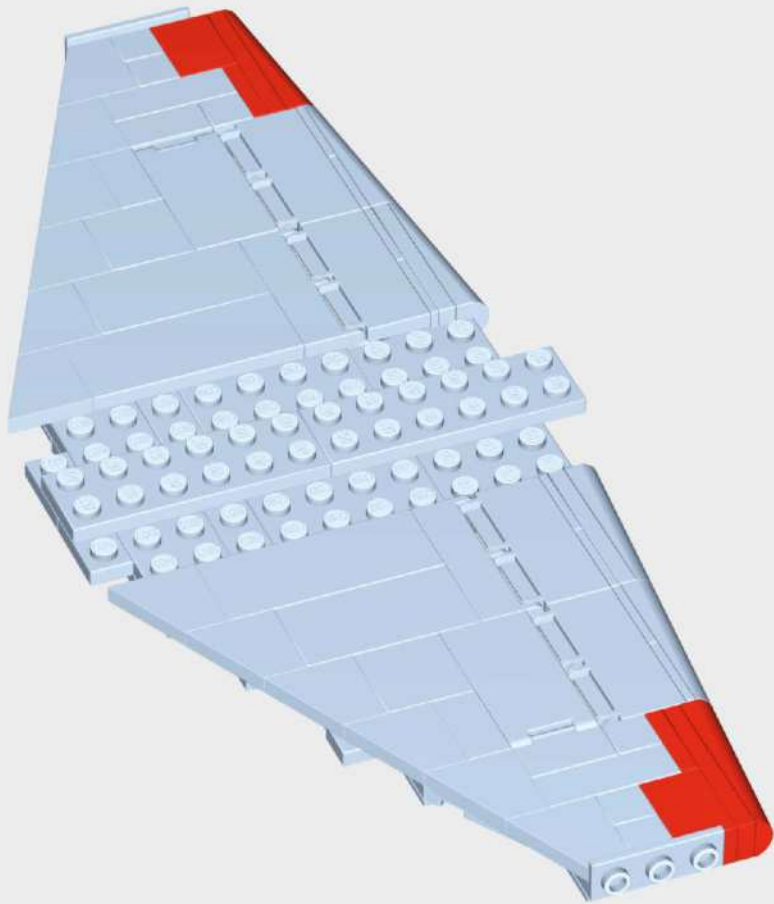

25

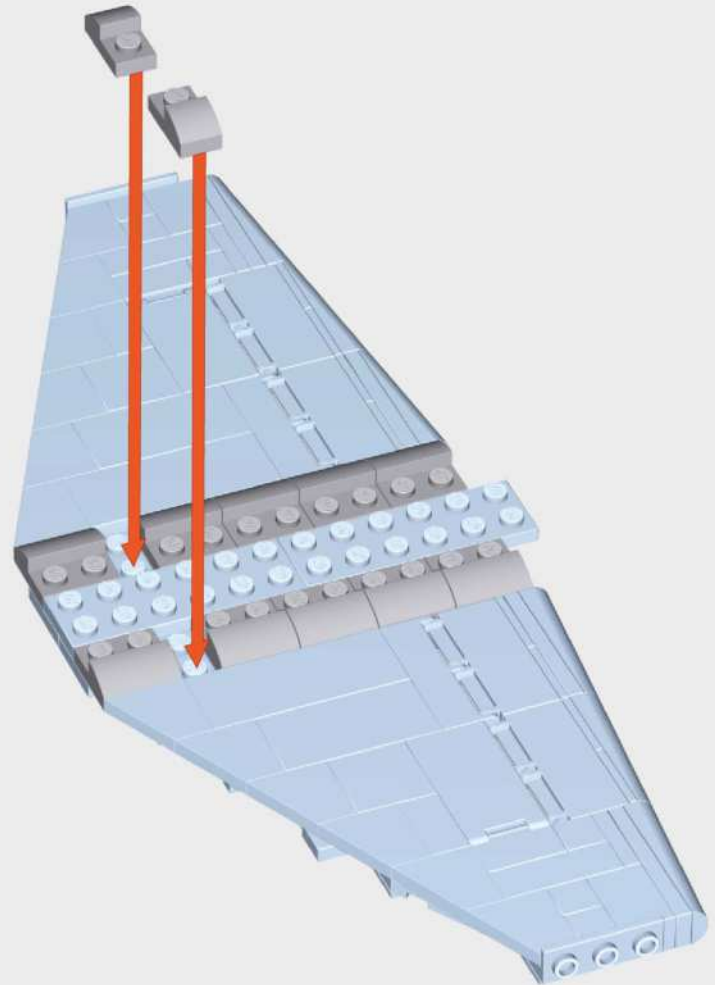

x2



x10

26

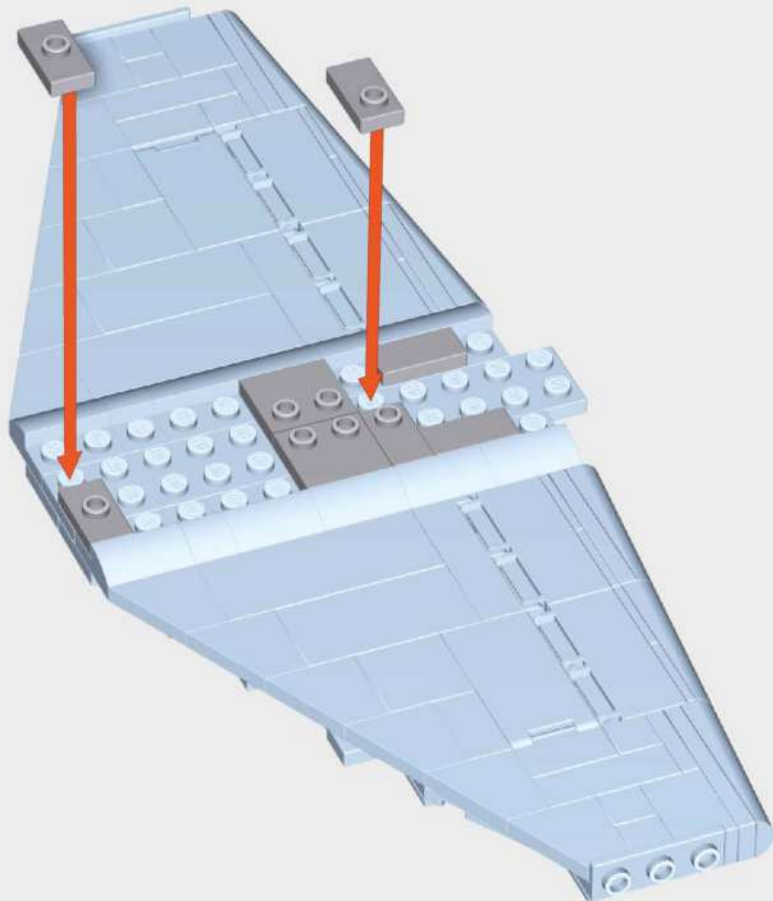

1:1



x2



x2



x2



x2

27

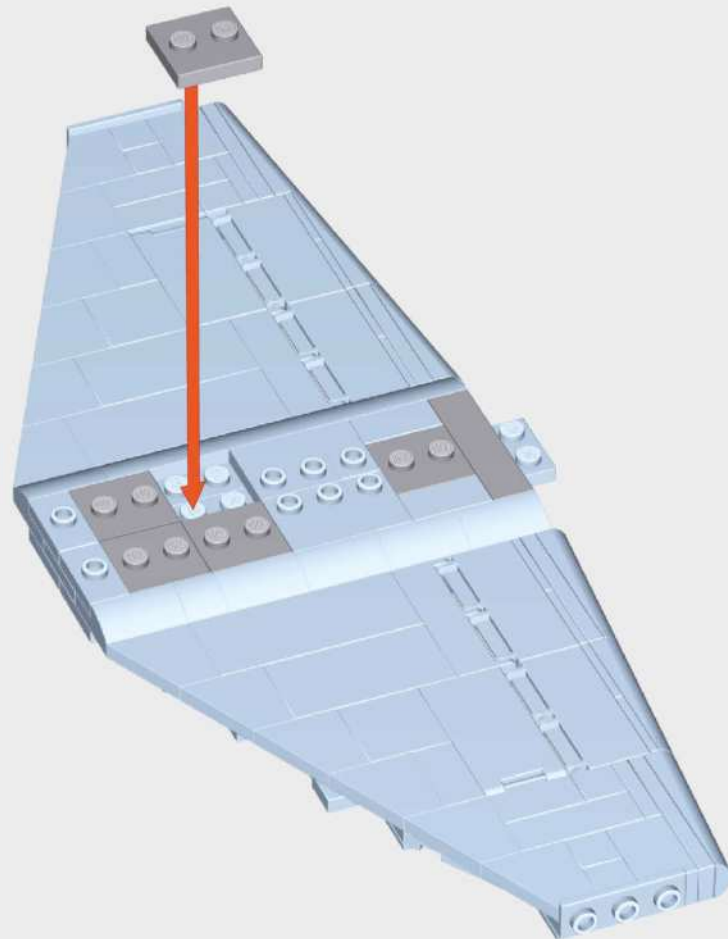

1:1



x1



x5

28

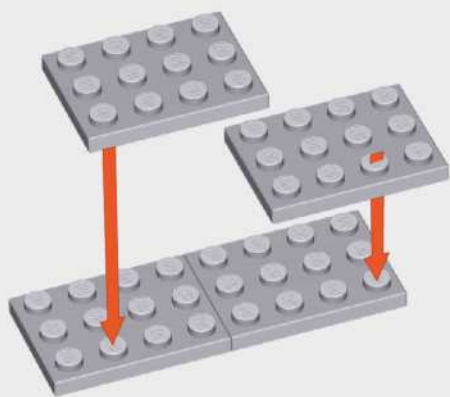

29



30



31

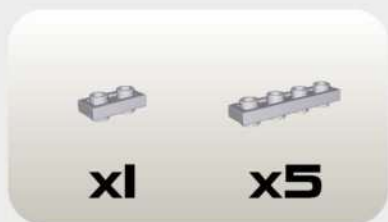
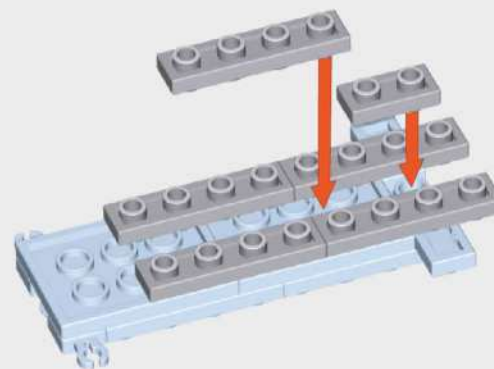

32

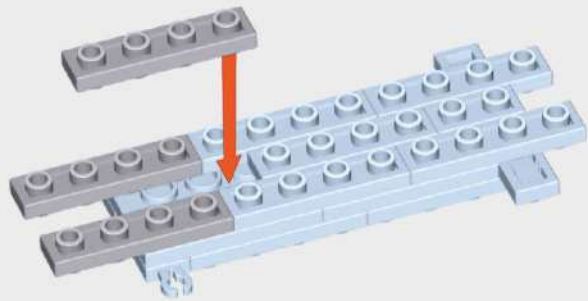

33

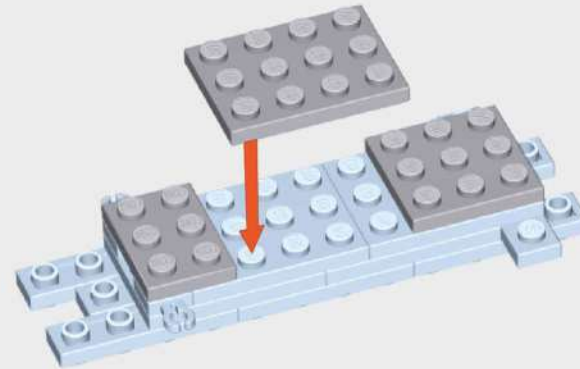

34

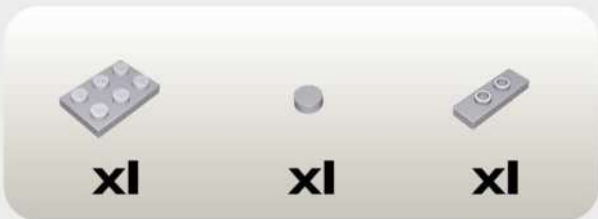
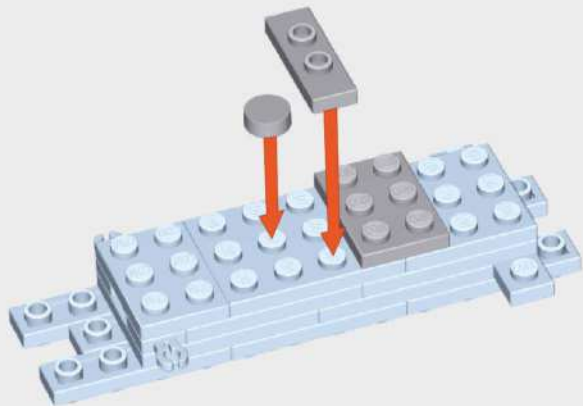

35

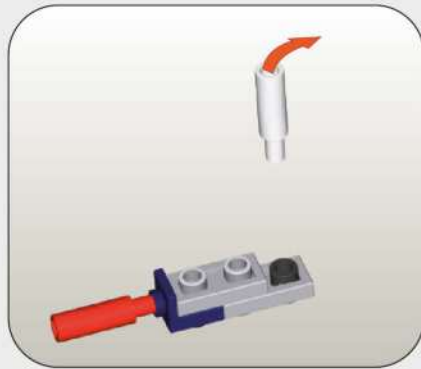
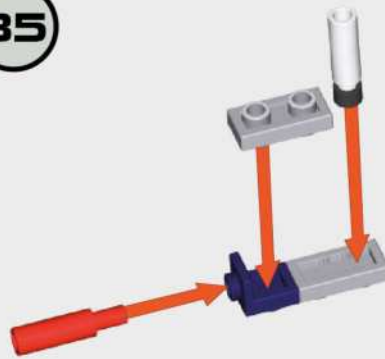

36



x1

37

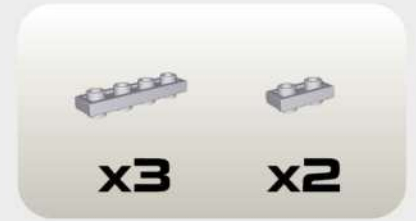
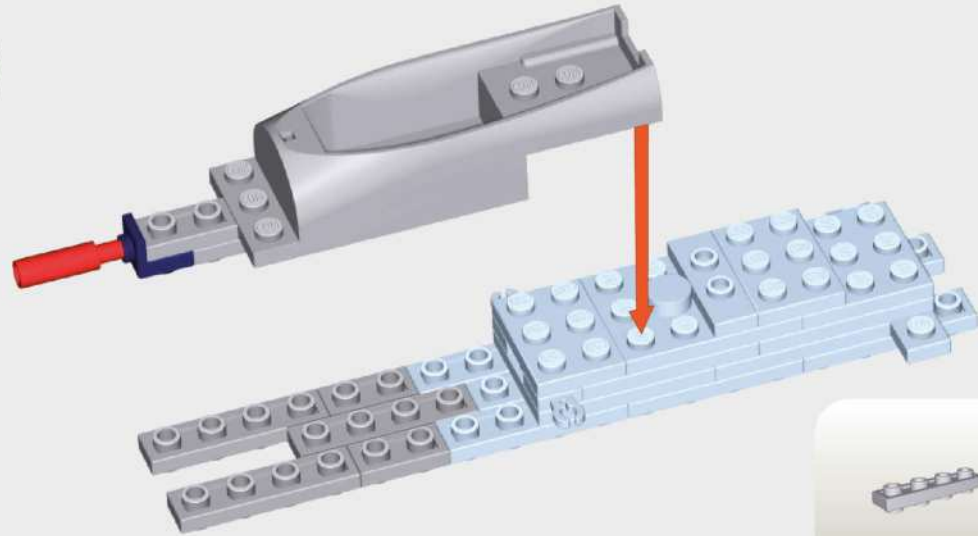

x3

x2

38

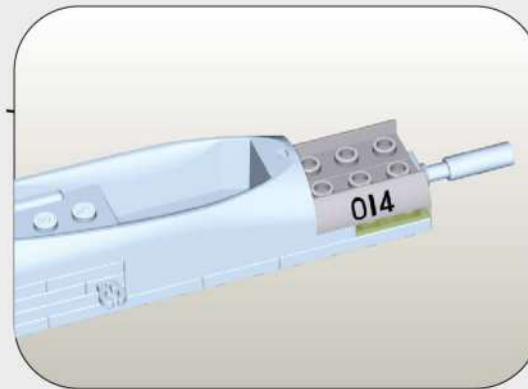
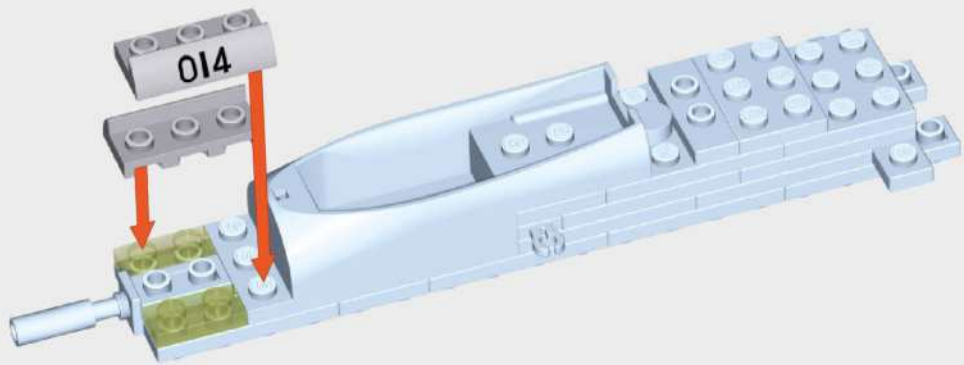

x2

x2

39

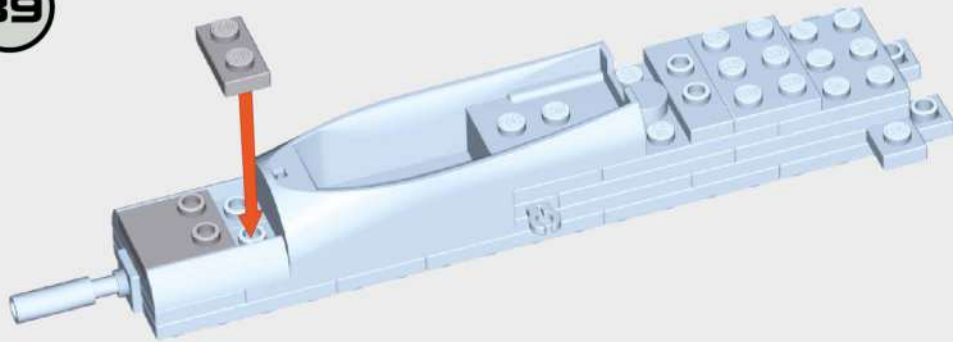

40

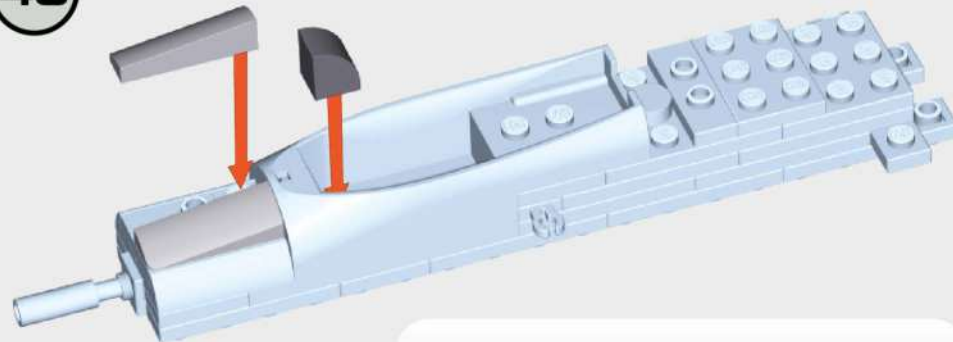

41

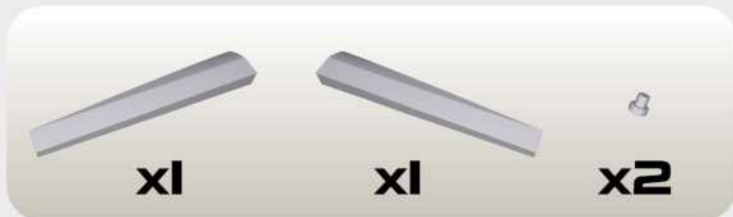

42

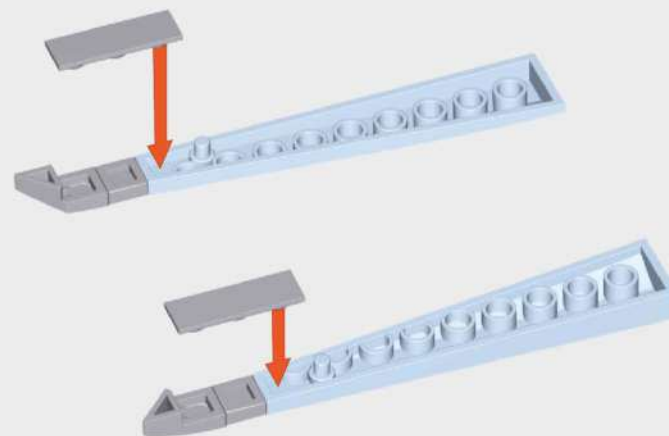

43

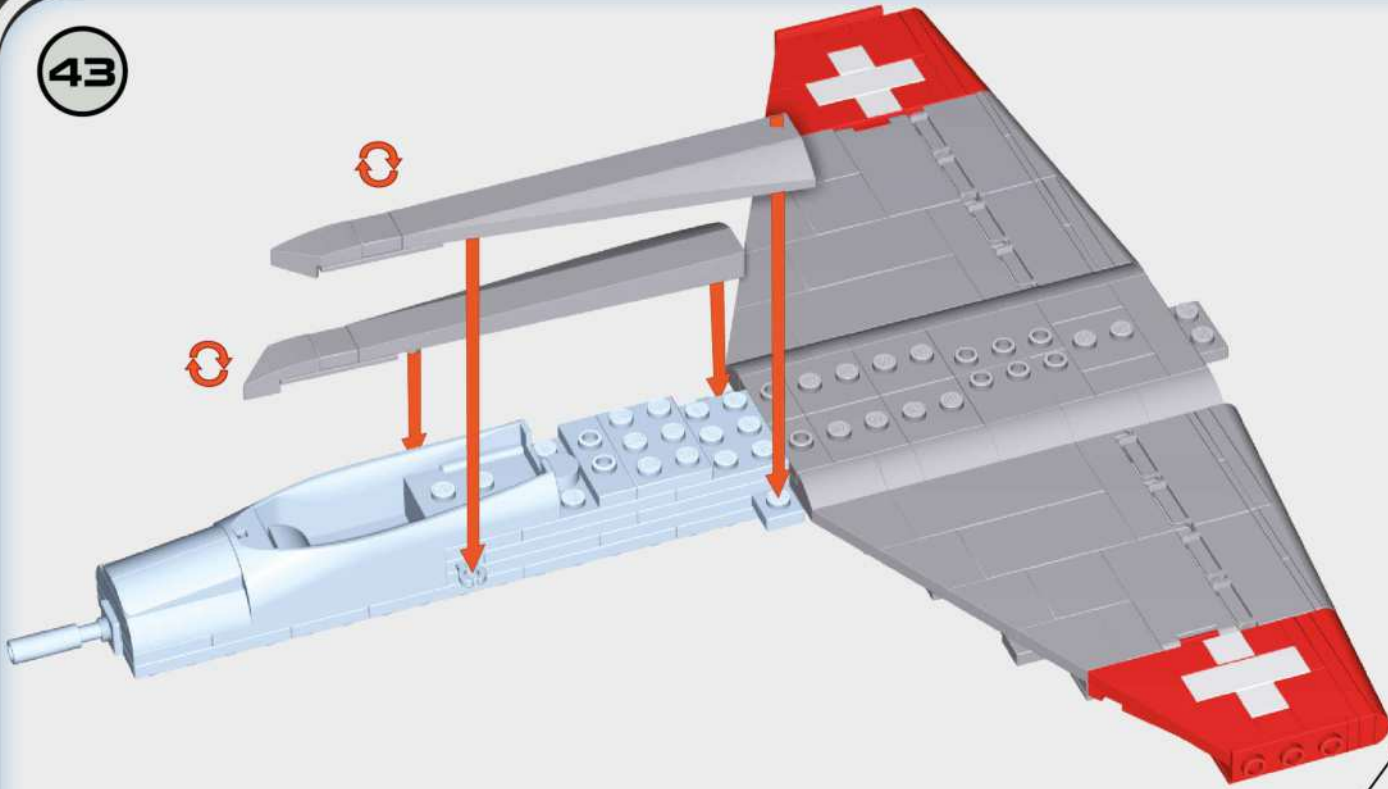

44

- | | |
|---|---|
|  |  |
| x2 | x1 |
|  |  |
| x2 | x2 |

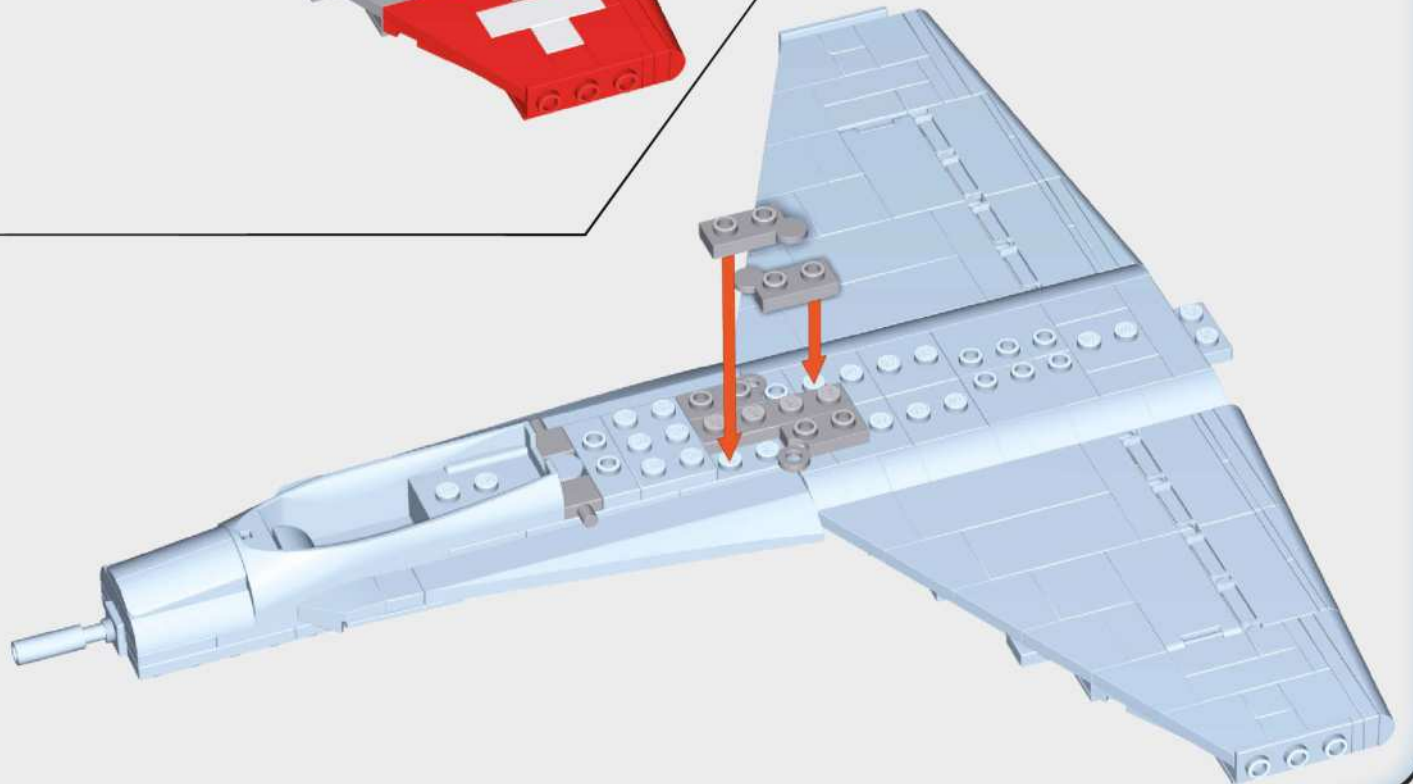

45

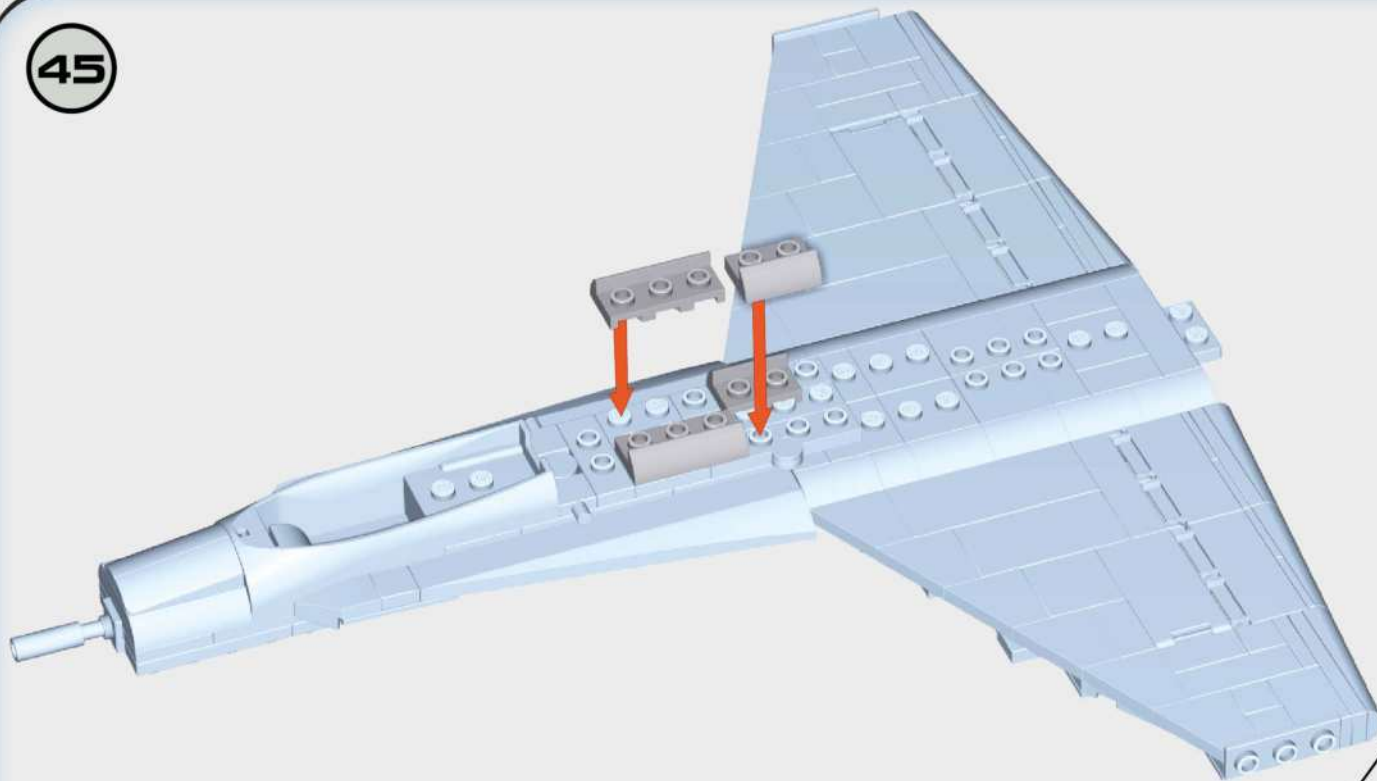



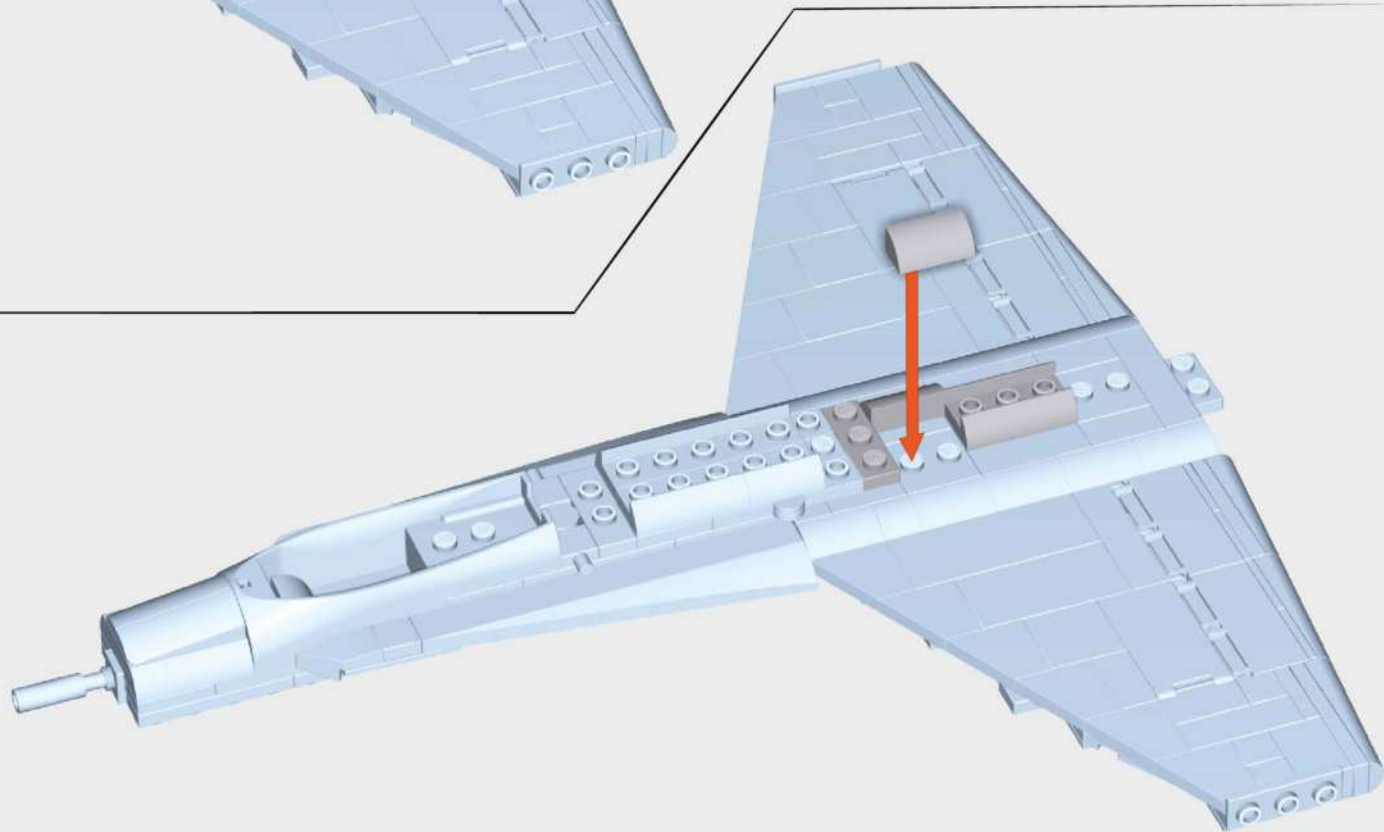

46

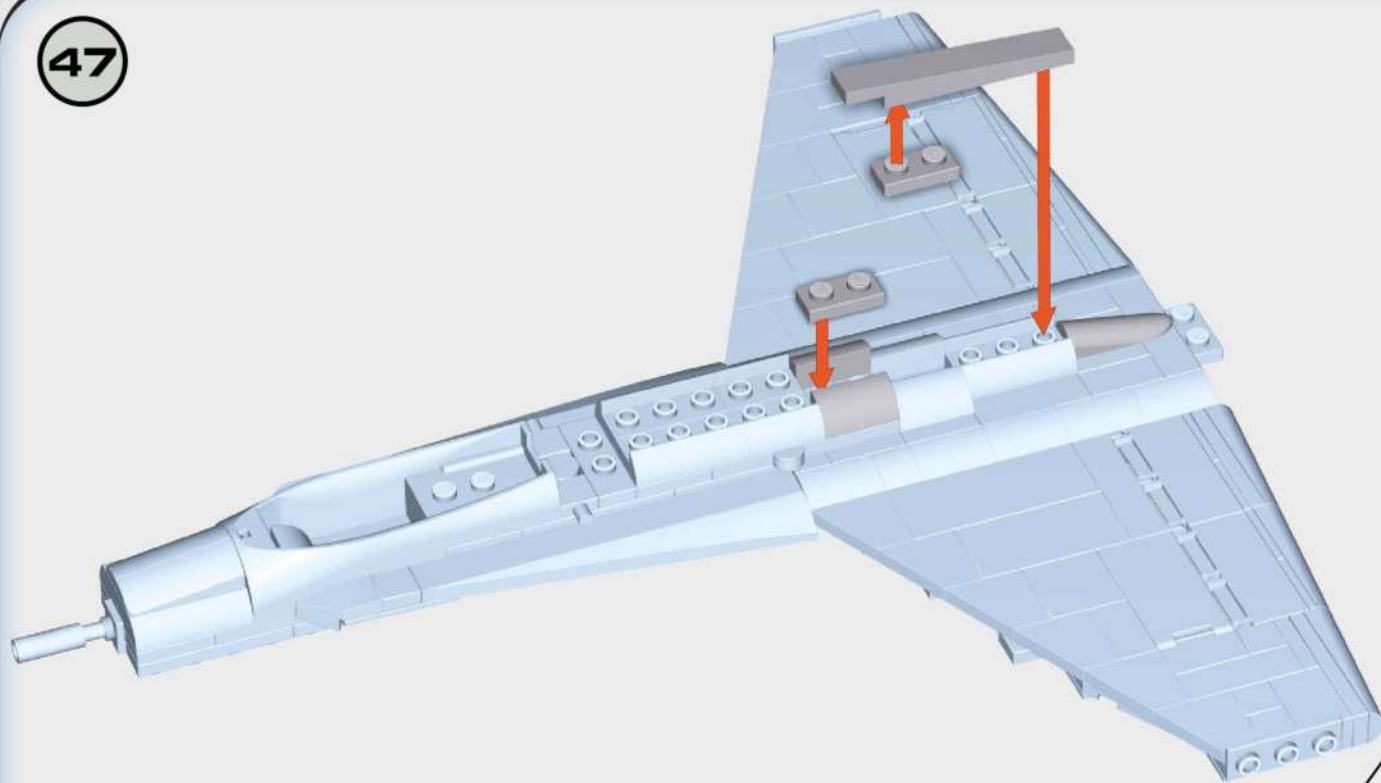



47

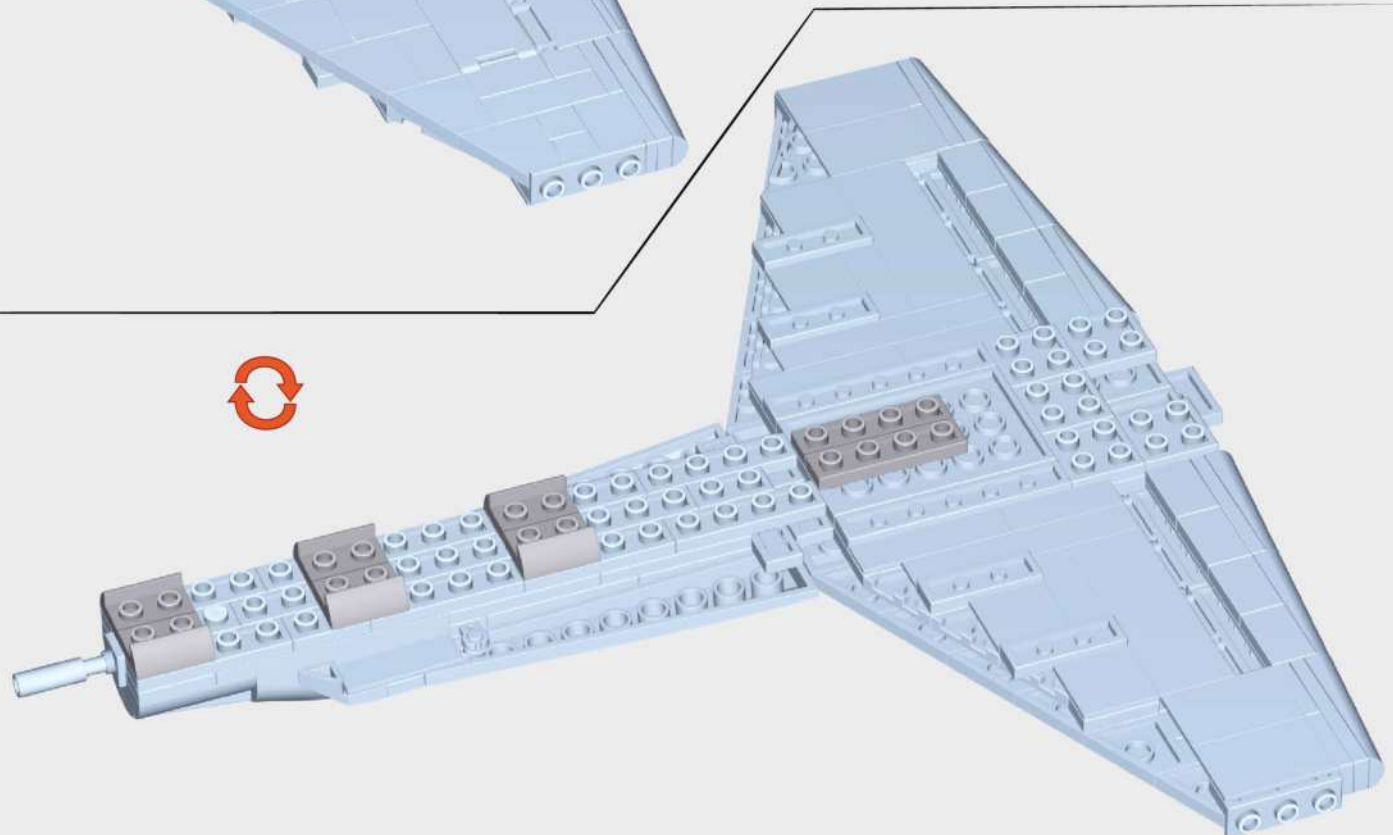

-  **x2**
-  **x1**
-  **x2**
-  **x1**

48



-  **x6**
-  **x2**

49

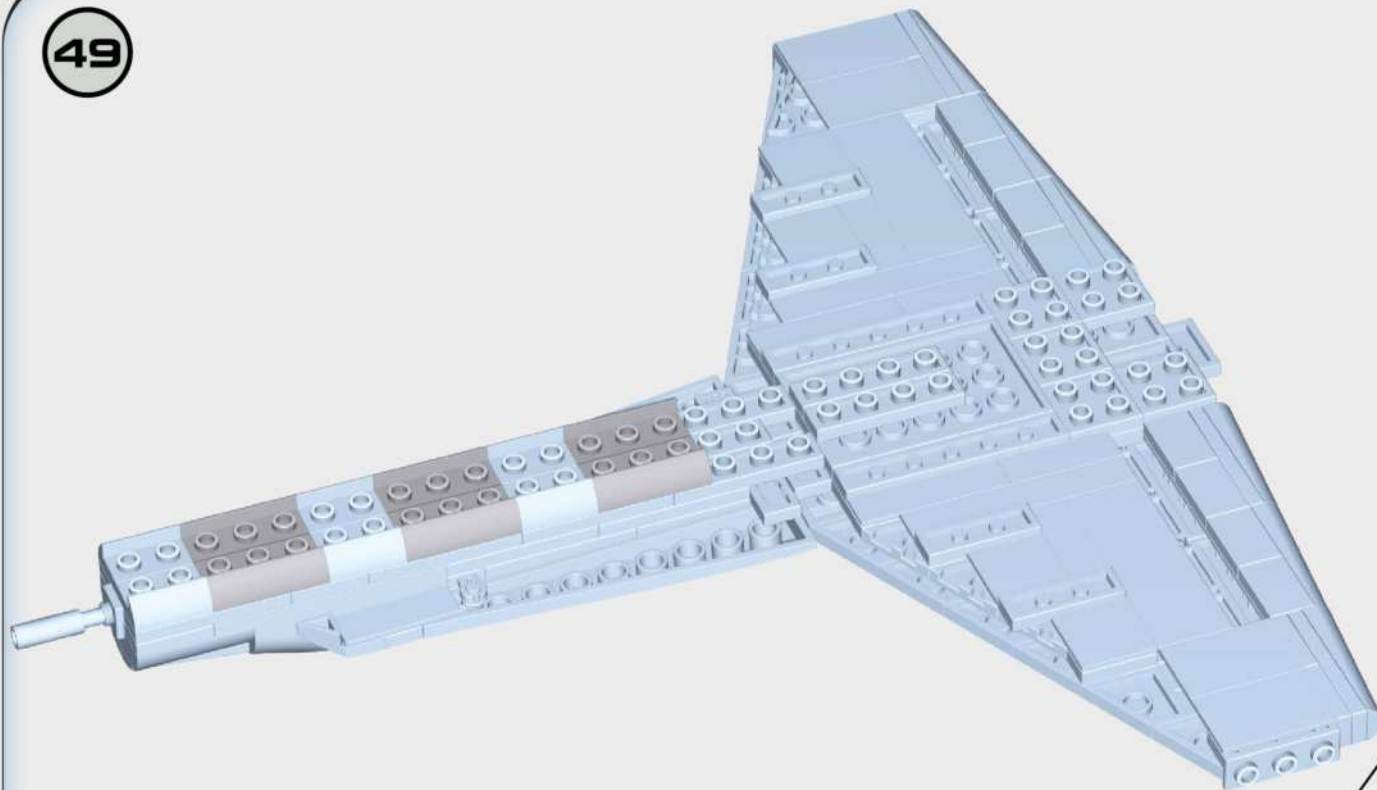

50

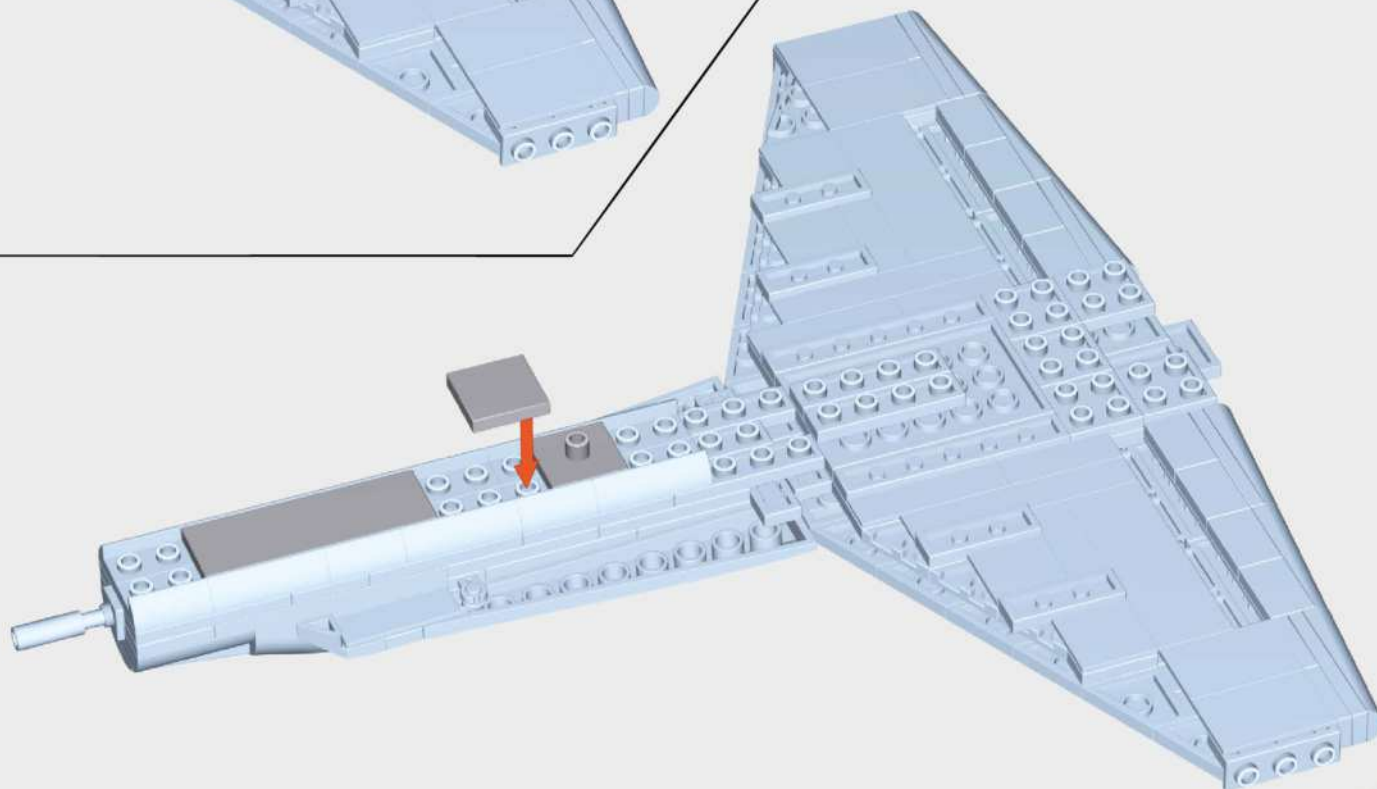

51

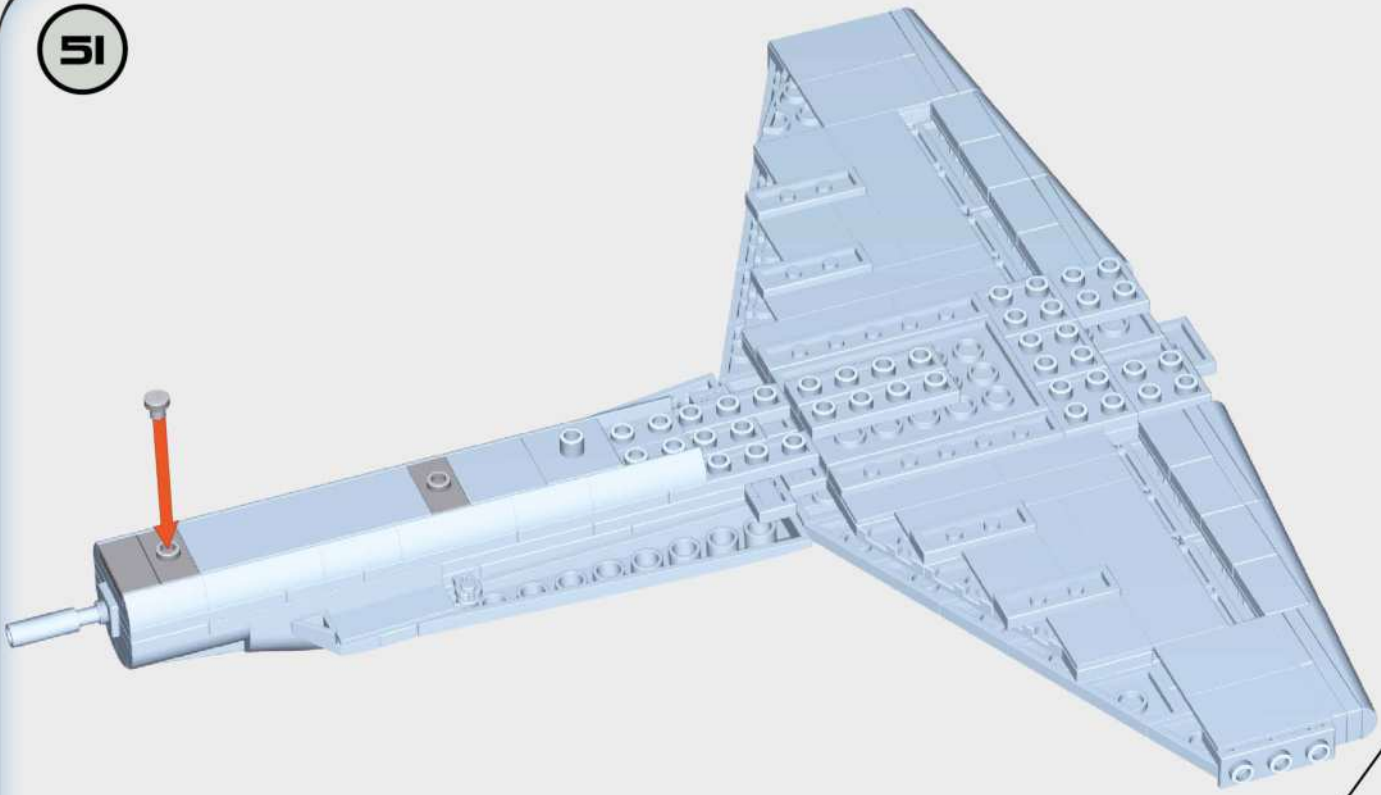

1:1



52

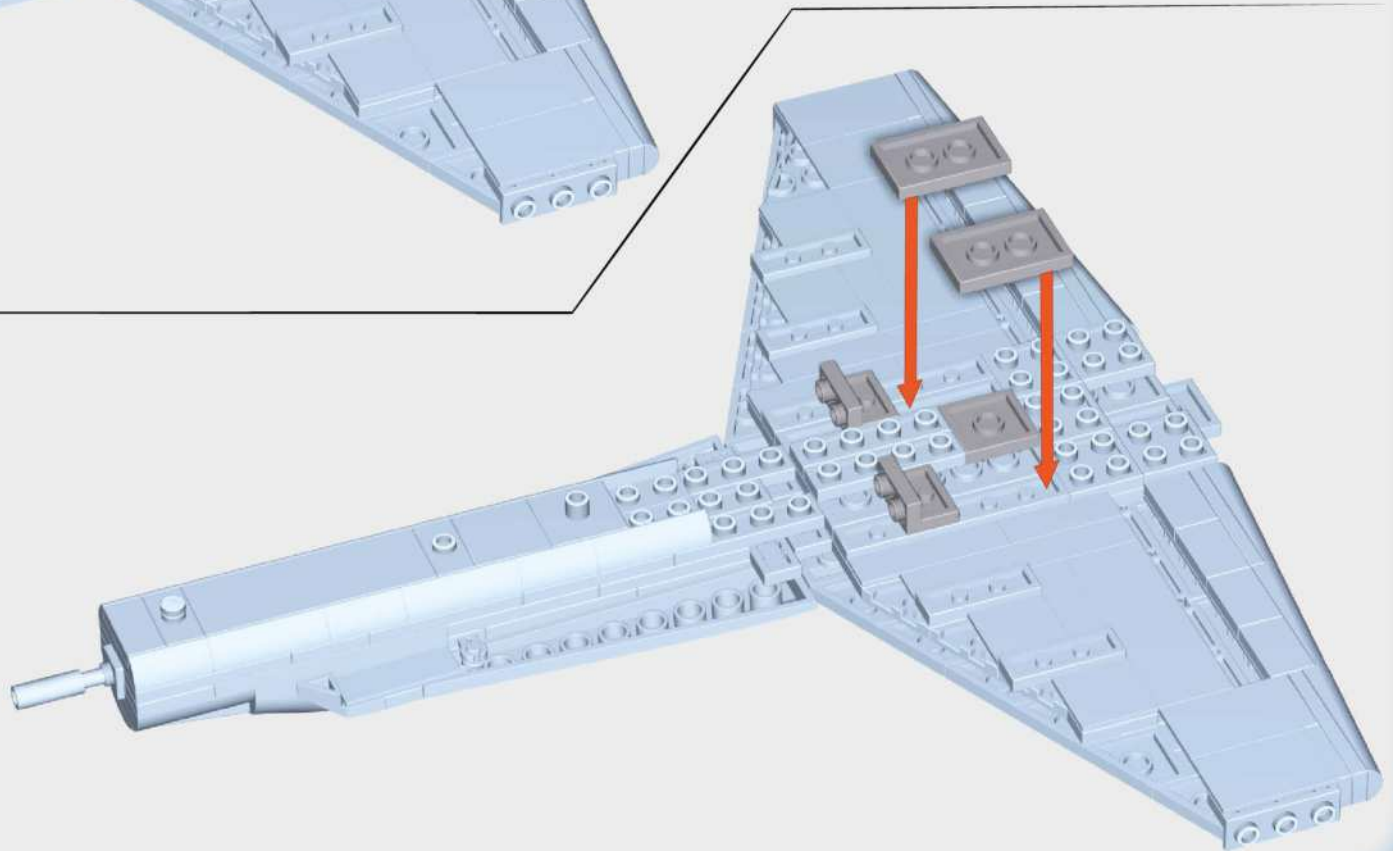

53

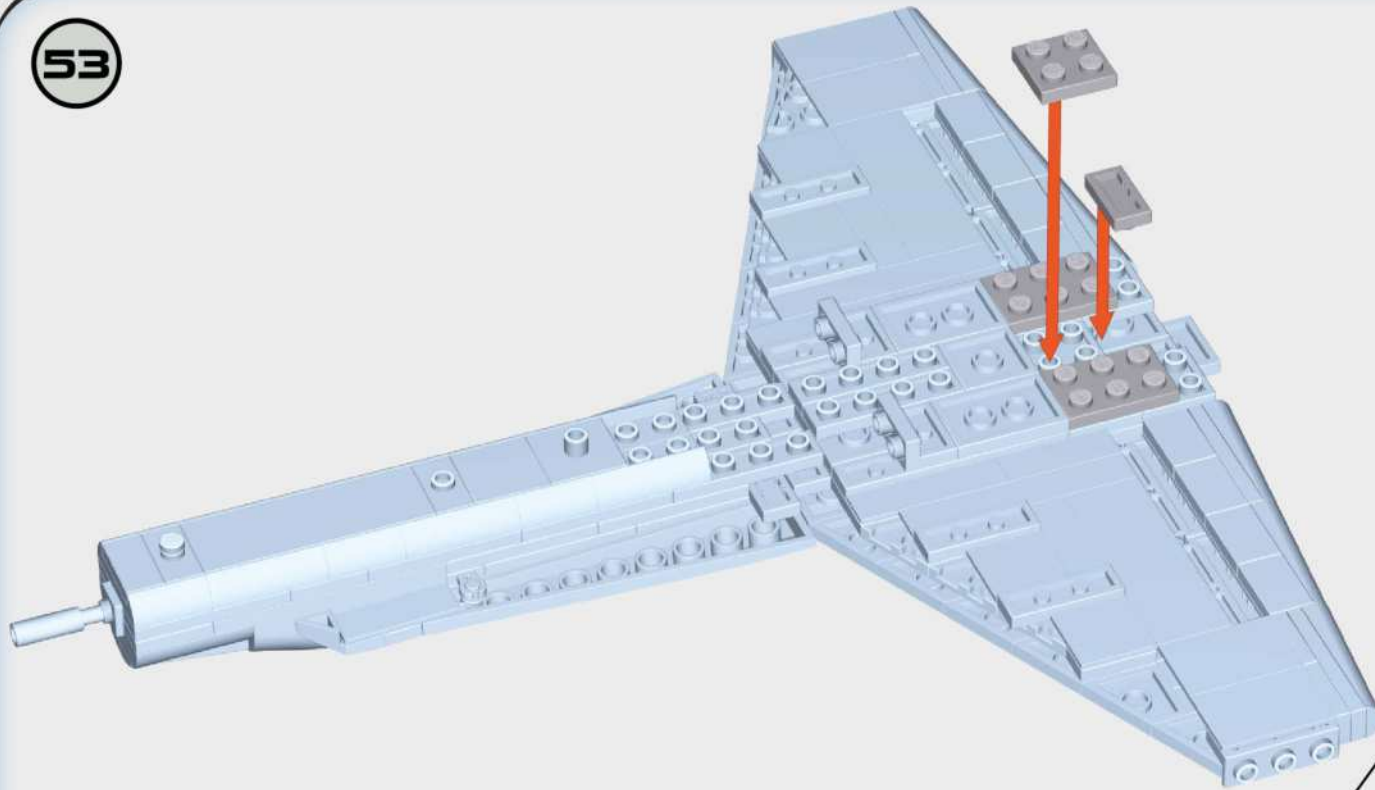

54

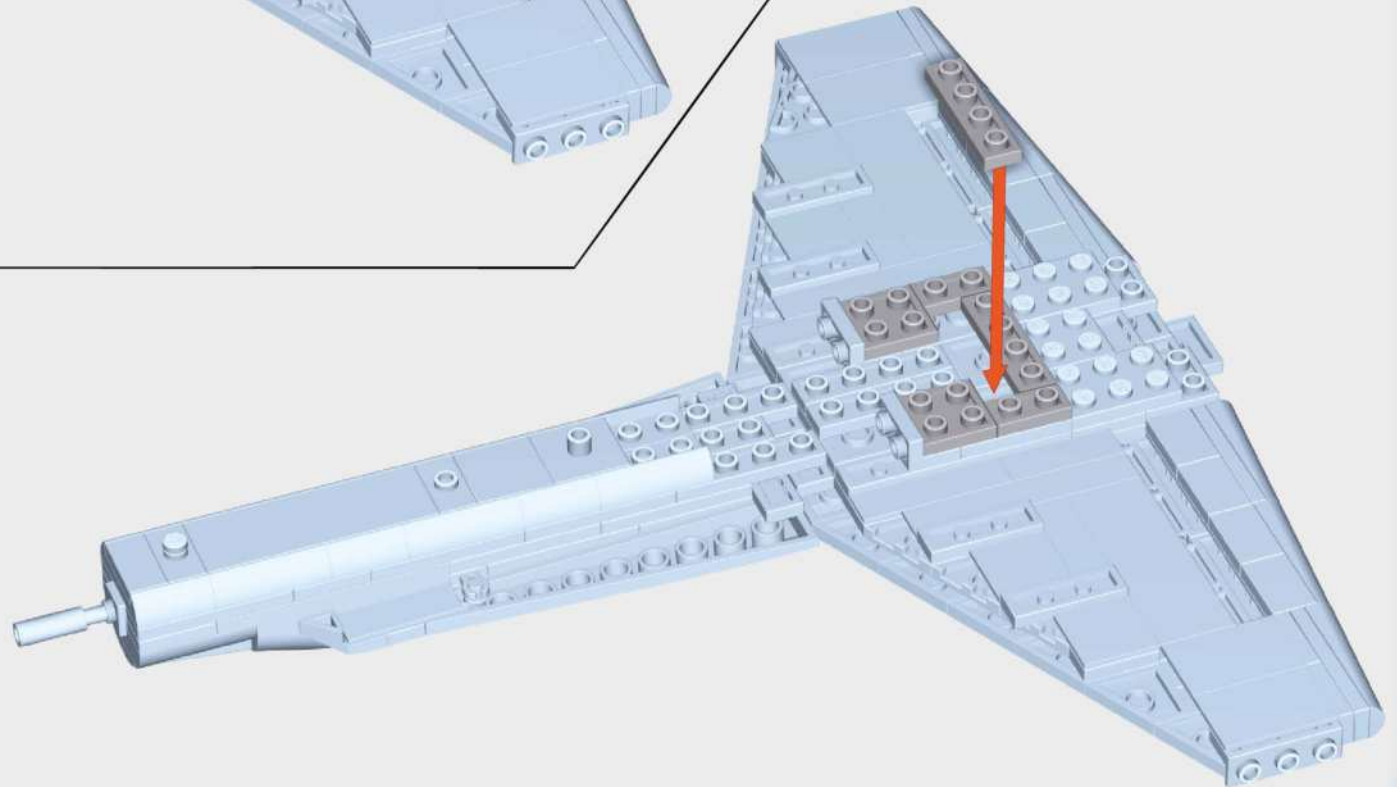

55



x1



x2



x2

56

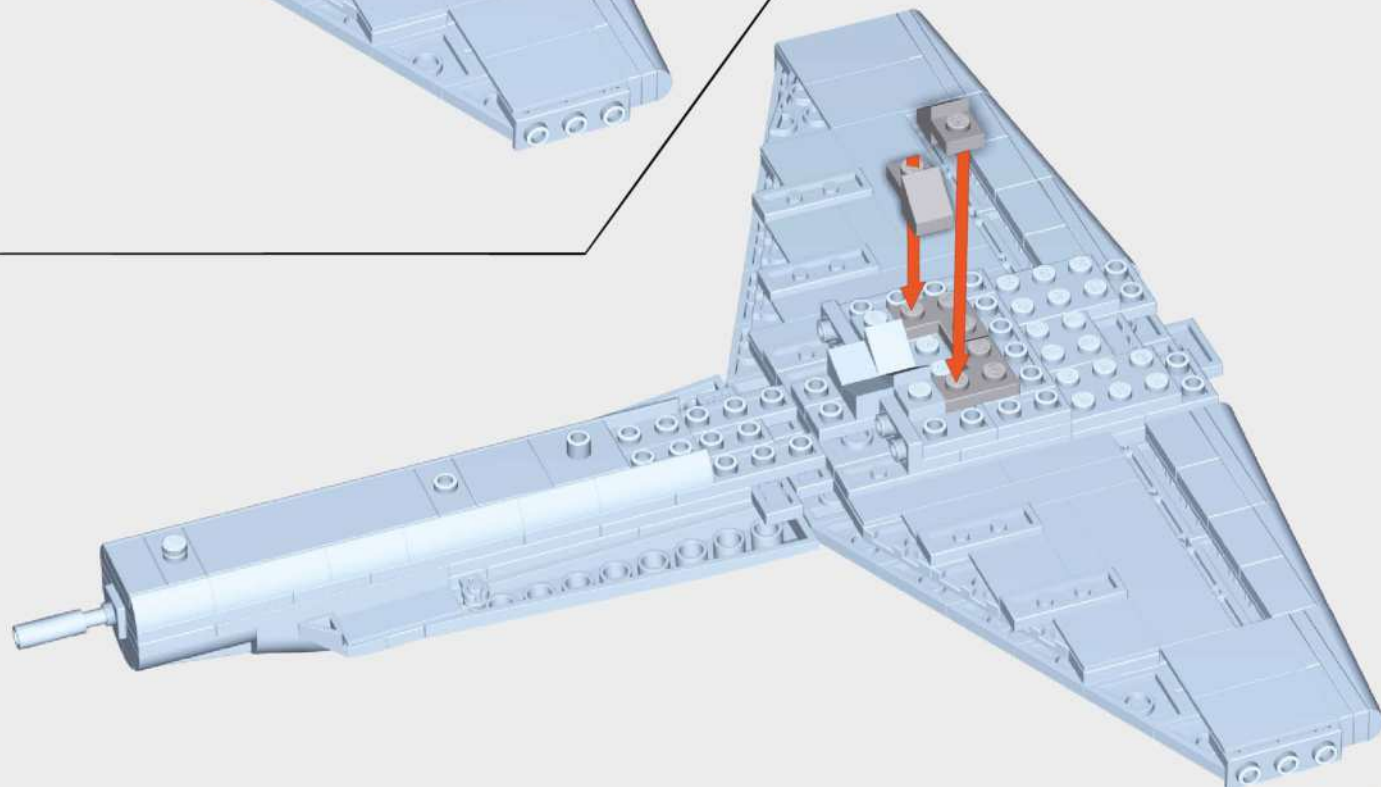

x2



x2

57



x1



x1



x1



x1

58



x3

59

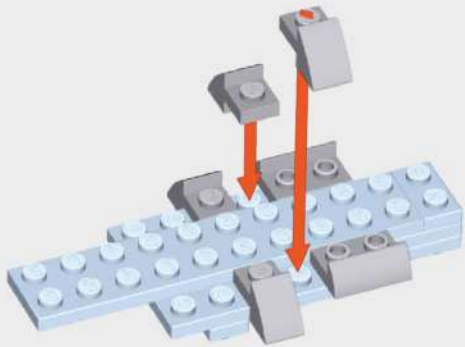

x2



x4

60

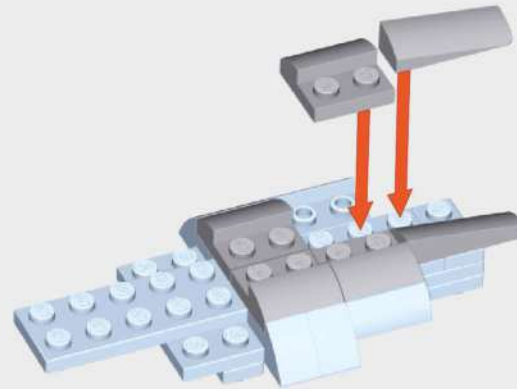

x1



x1



x4

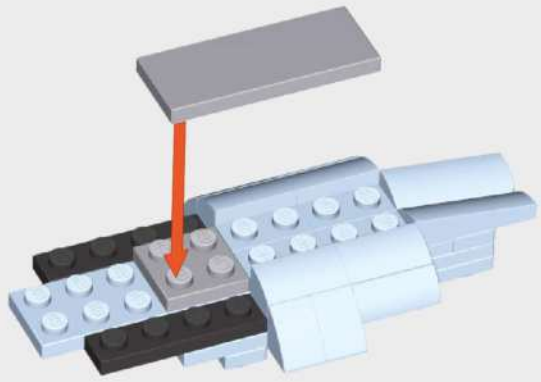

61

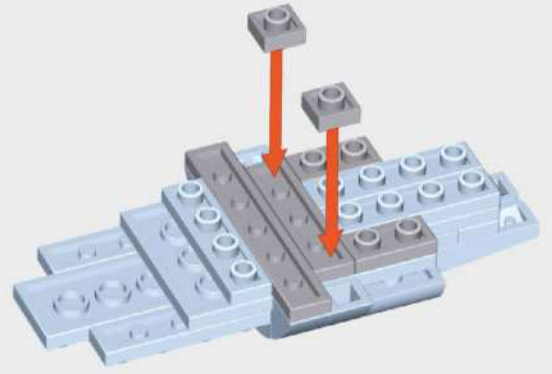

 **x2**
 **x1**
 **x1**

62



 **x1**
 **x1**
 **x2**
 **x2**

63

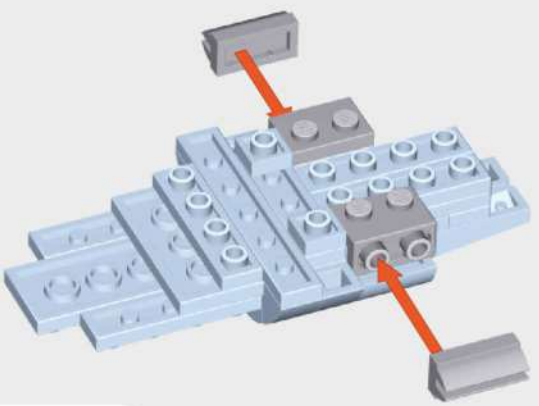

 **x2**
 **x2**

64

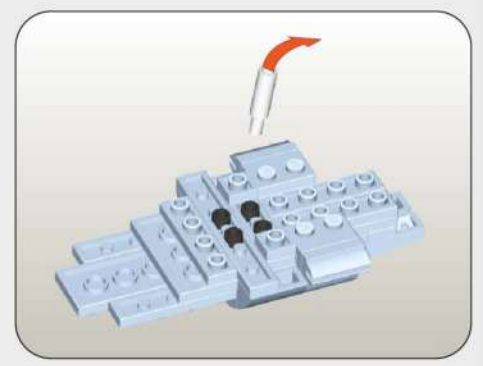
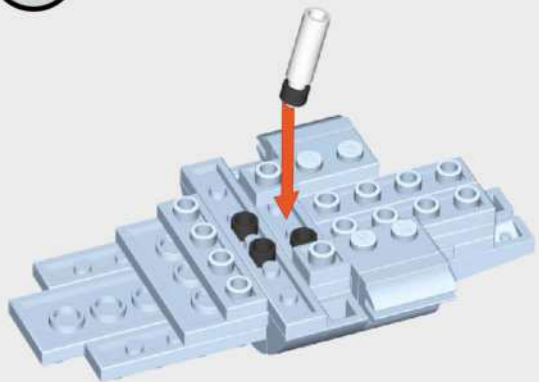

 **x4**

65

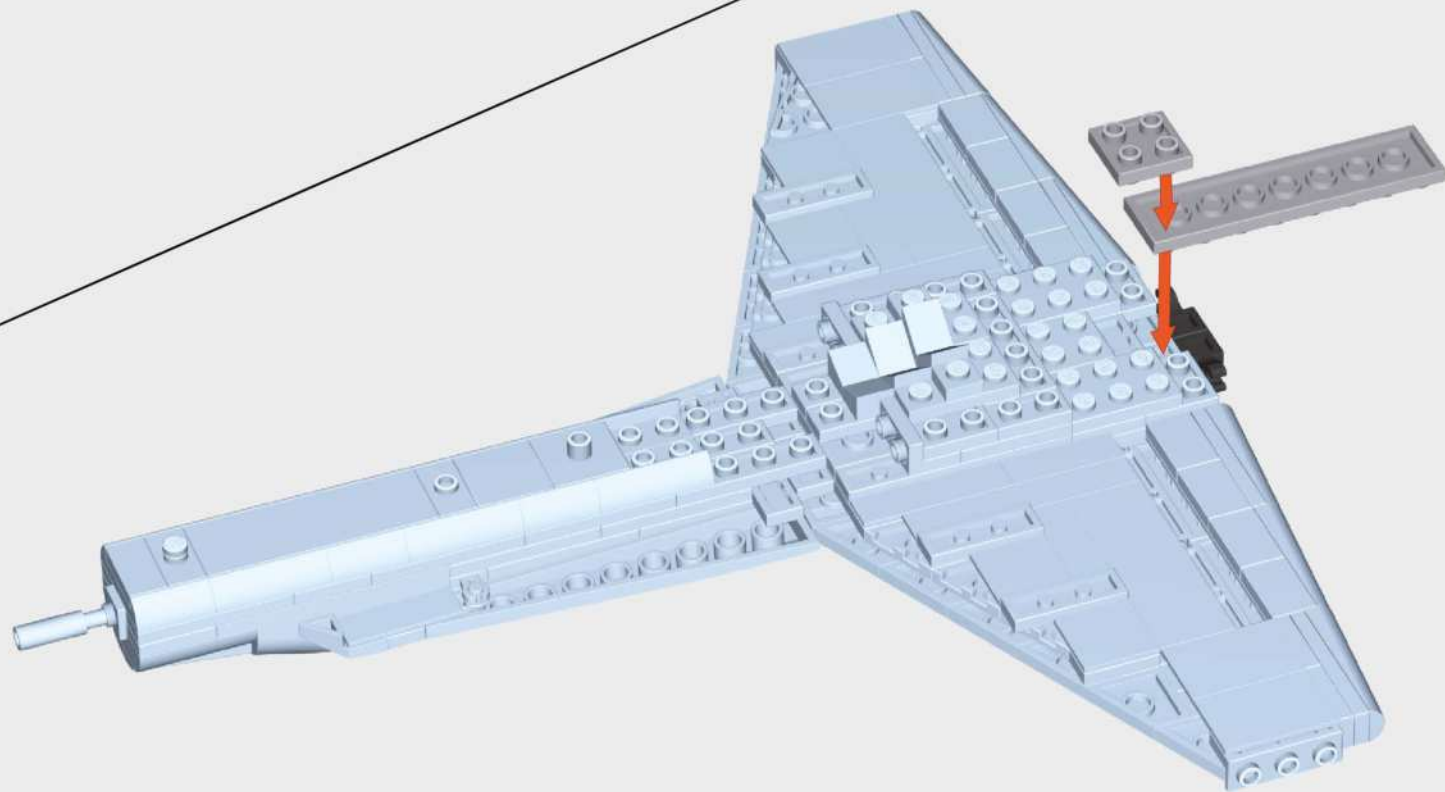

66



67

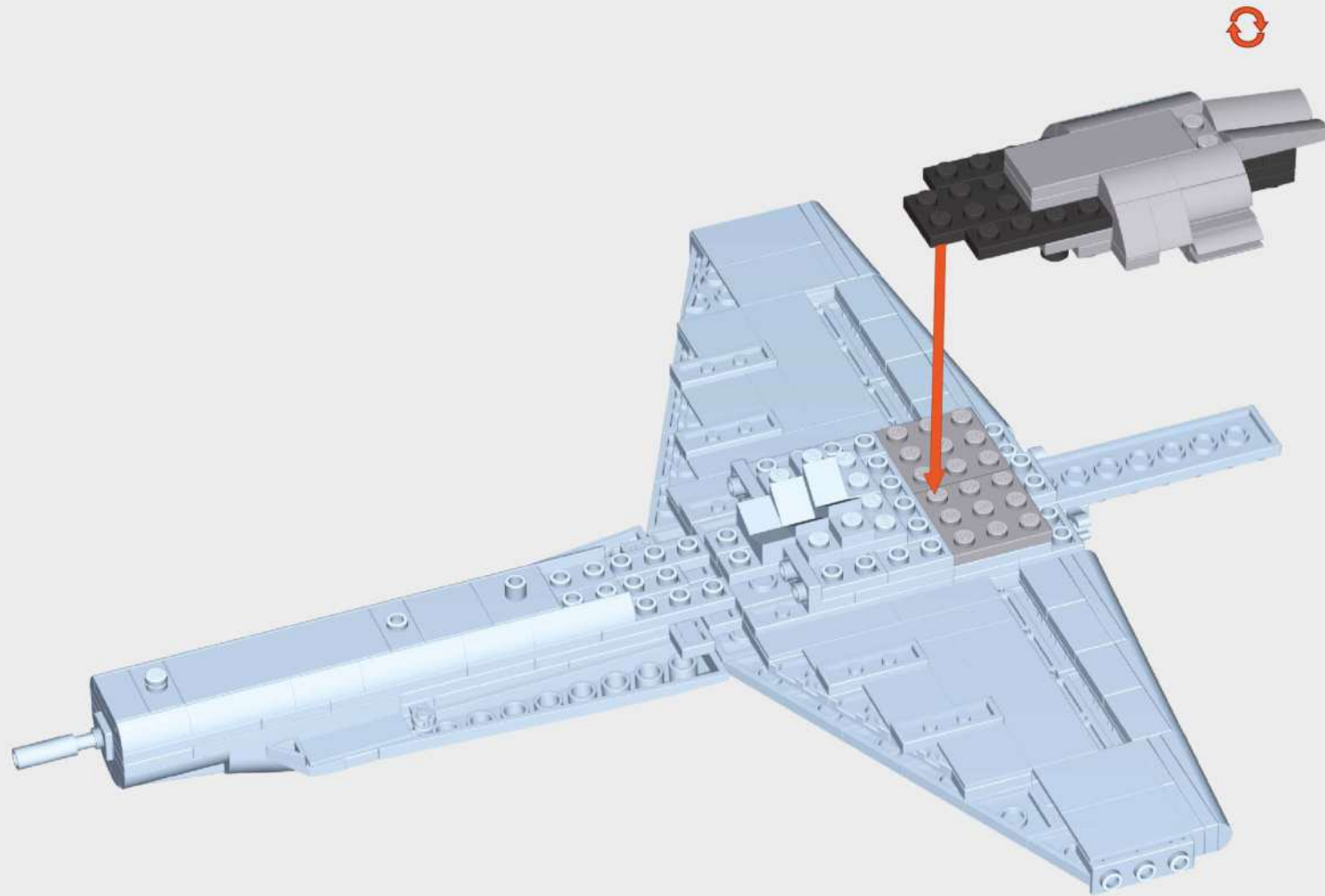

68

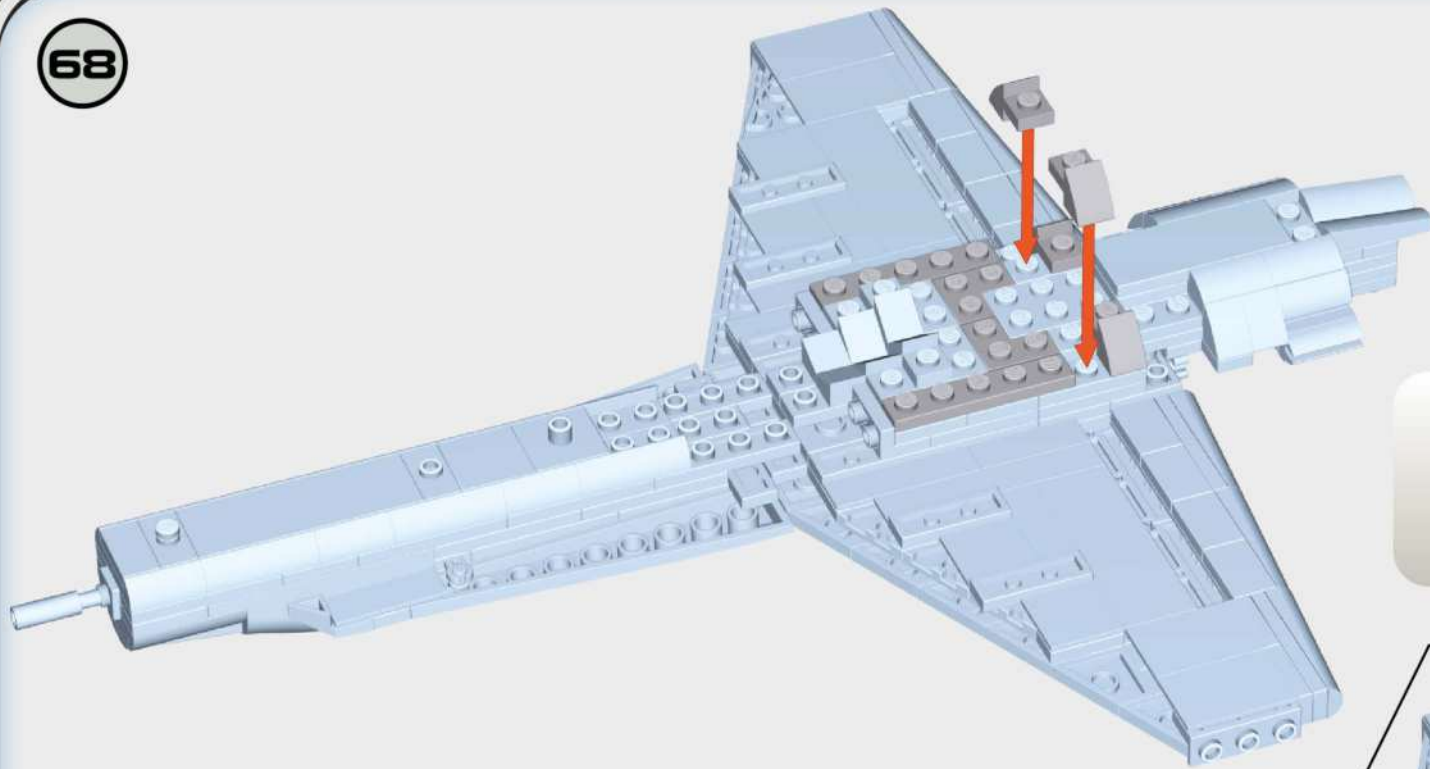

x2



x2



x4

69

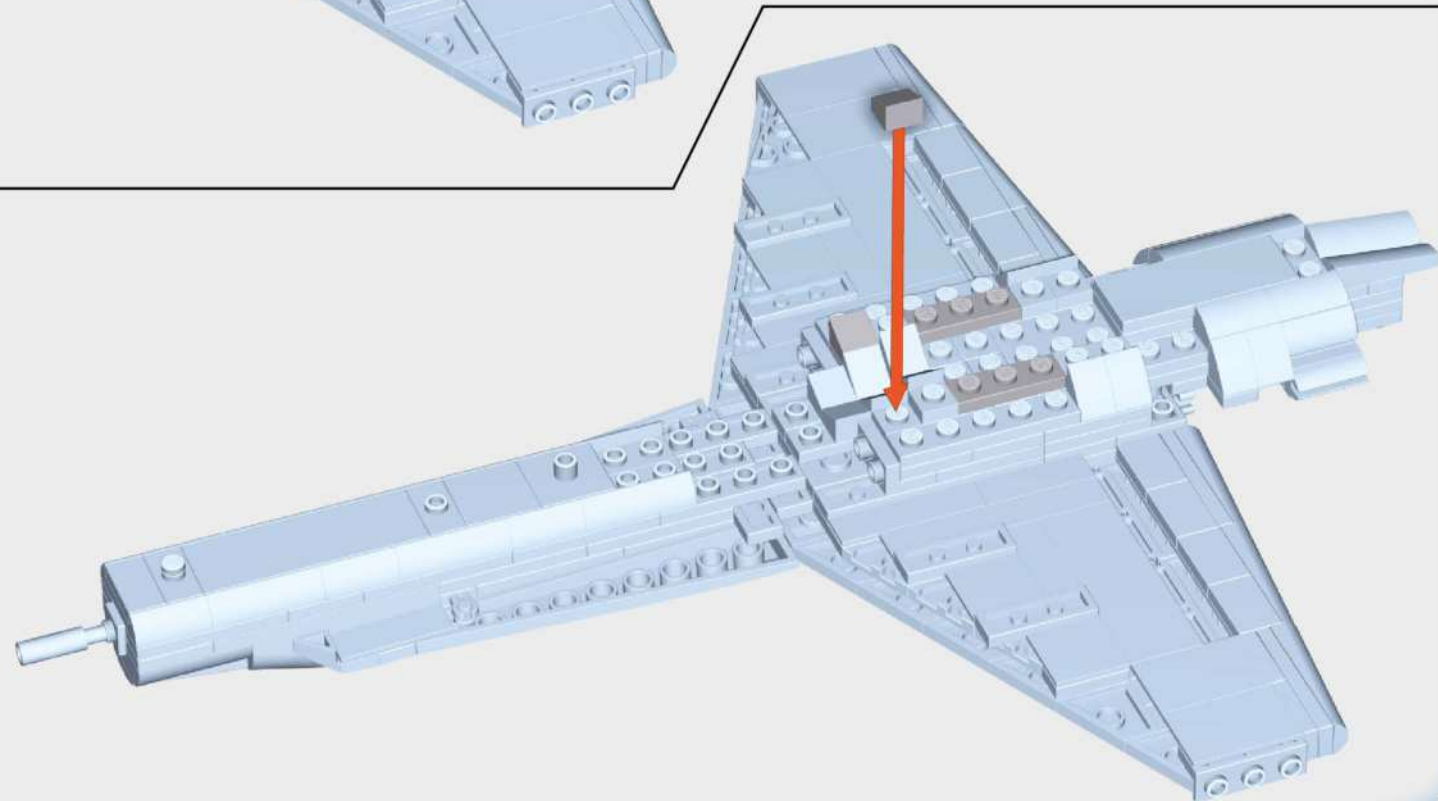

x2



x2

70

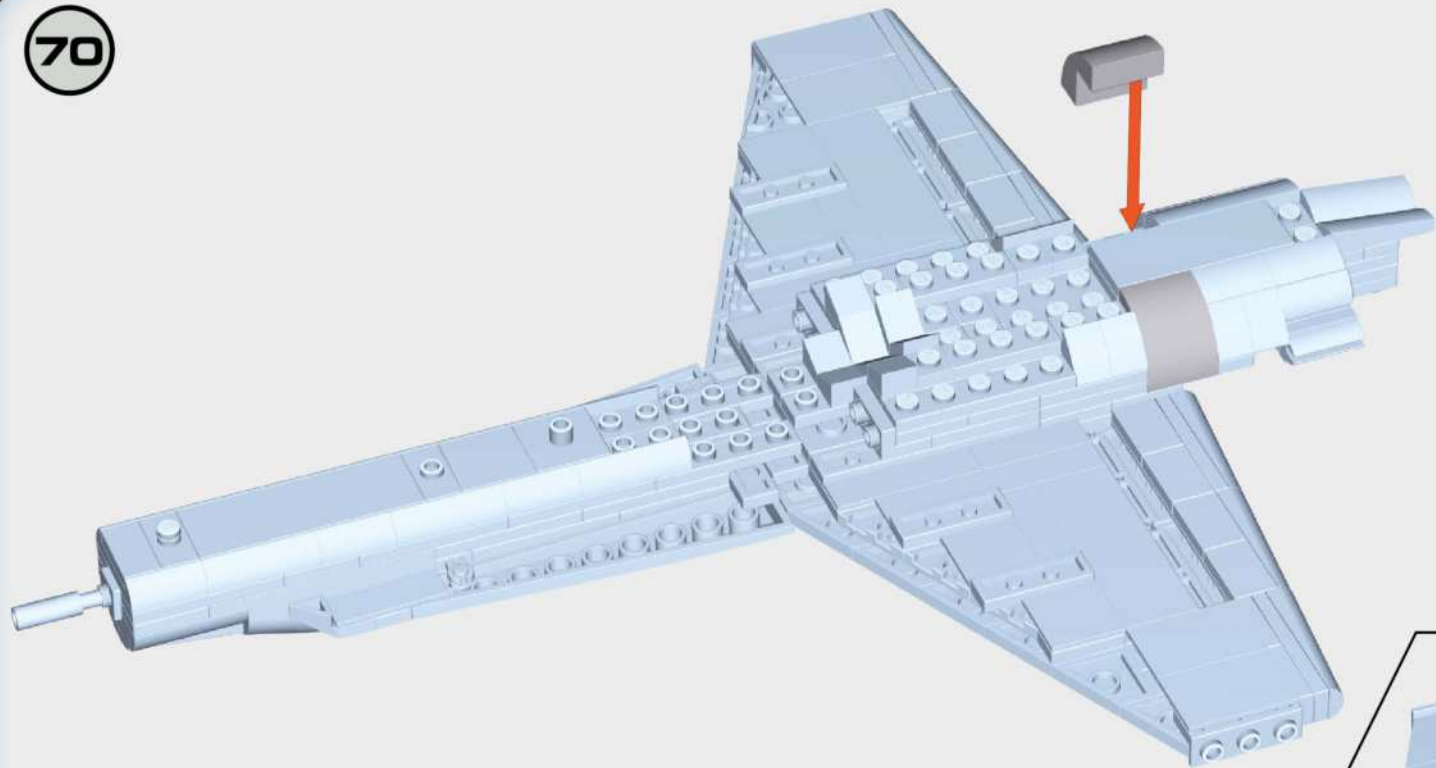

71

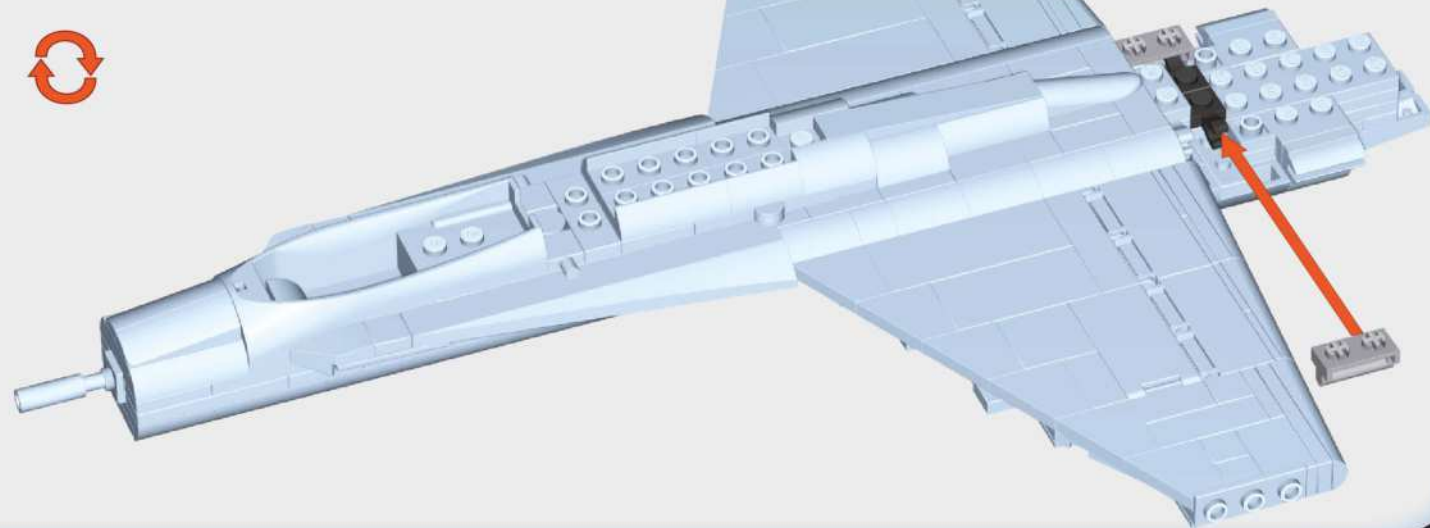

72

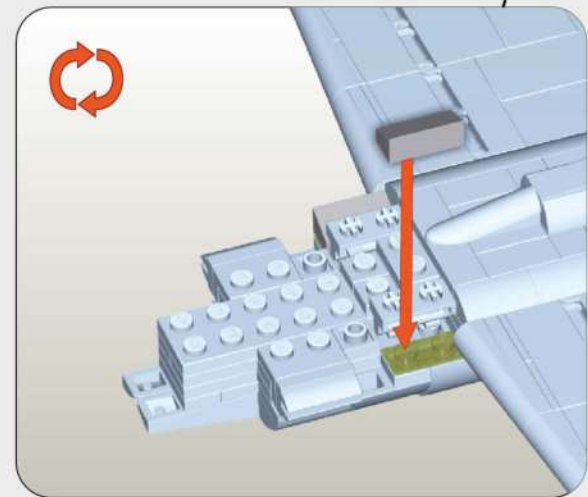
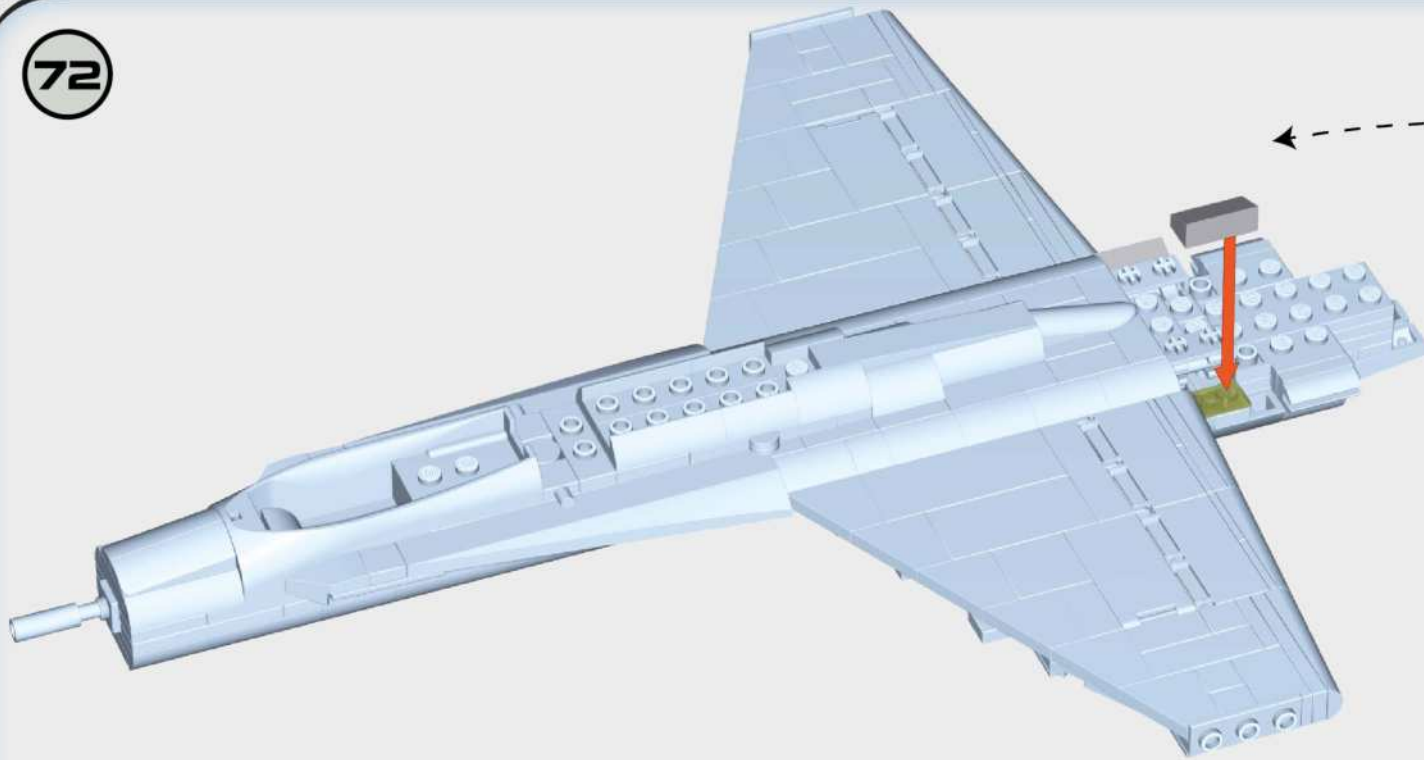

x2



x2

73

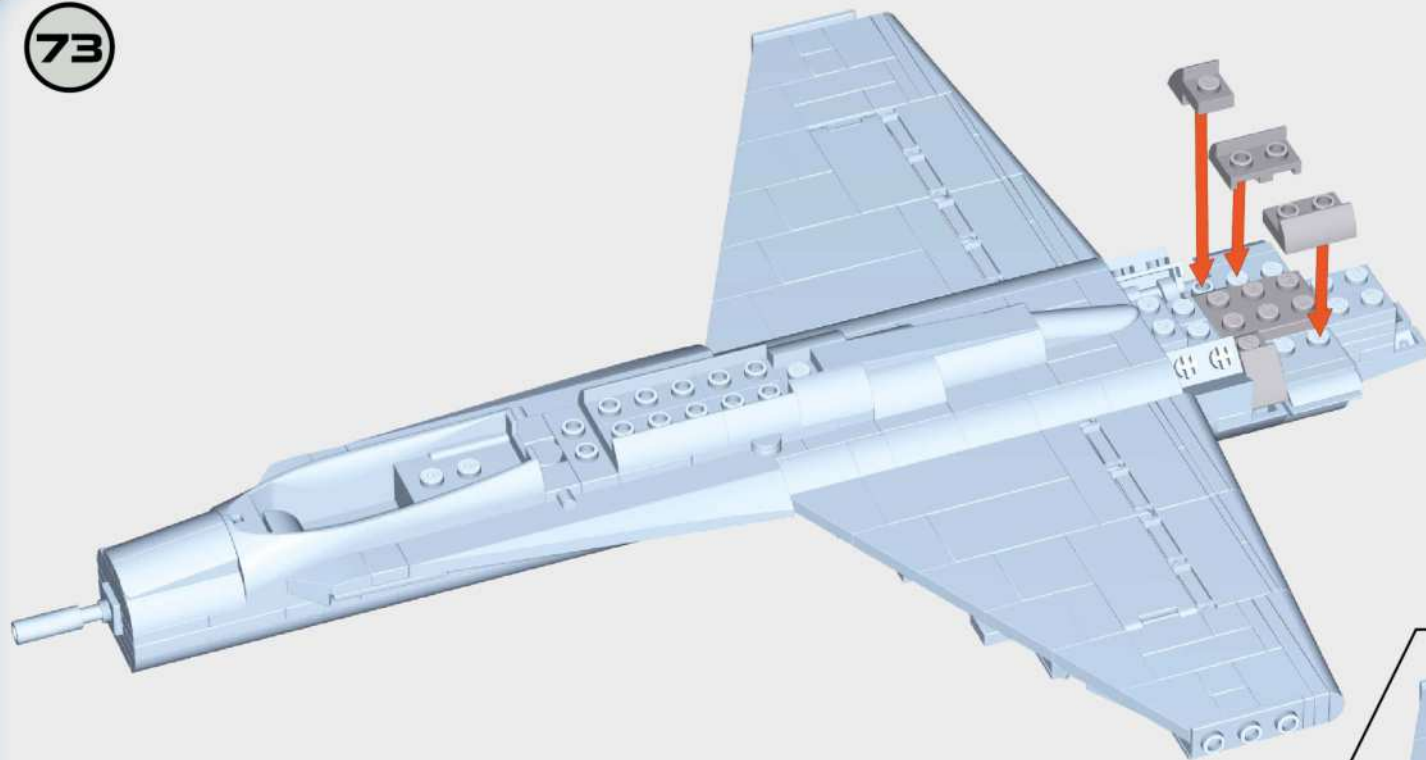

74

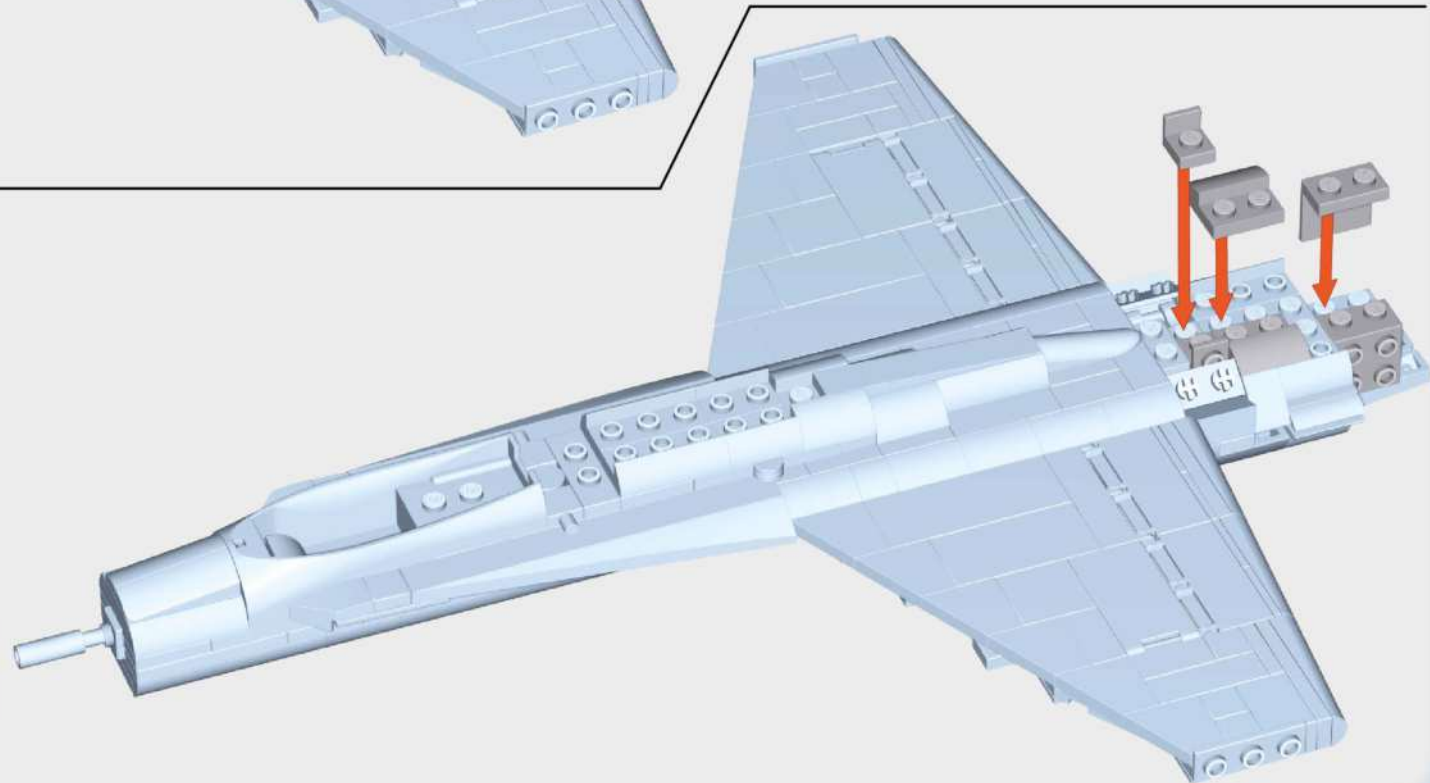

75

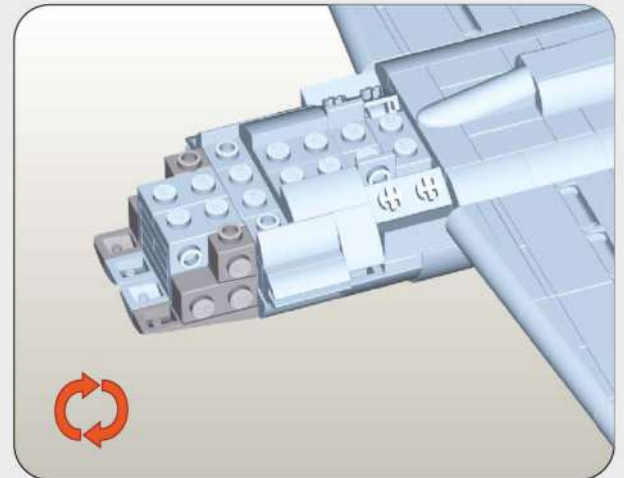
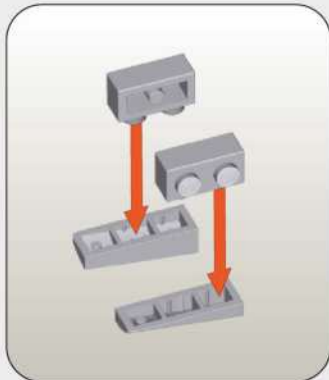
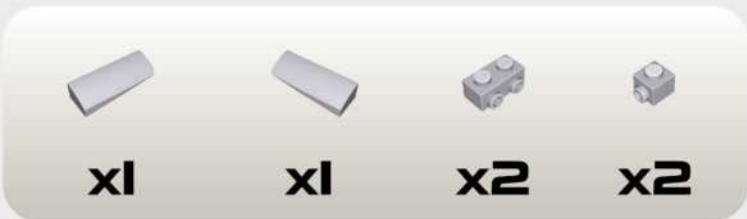
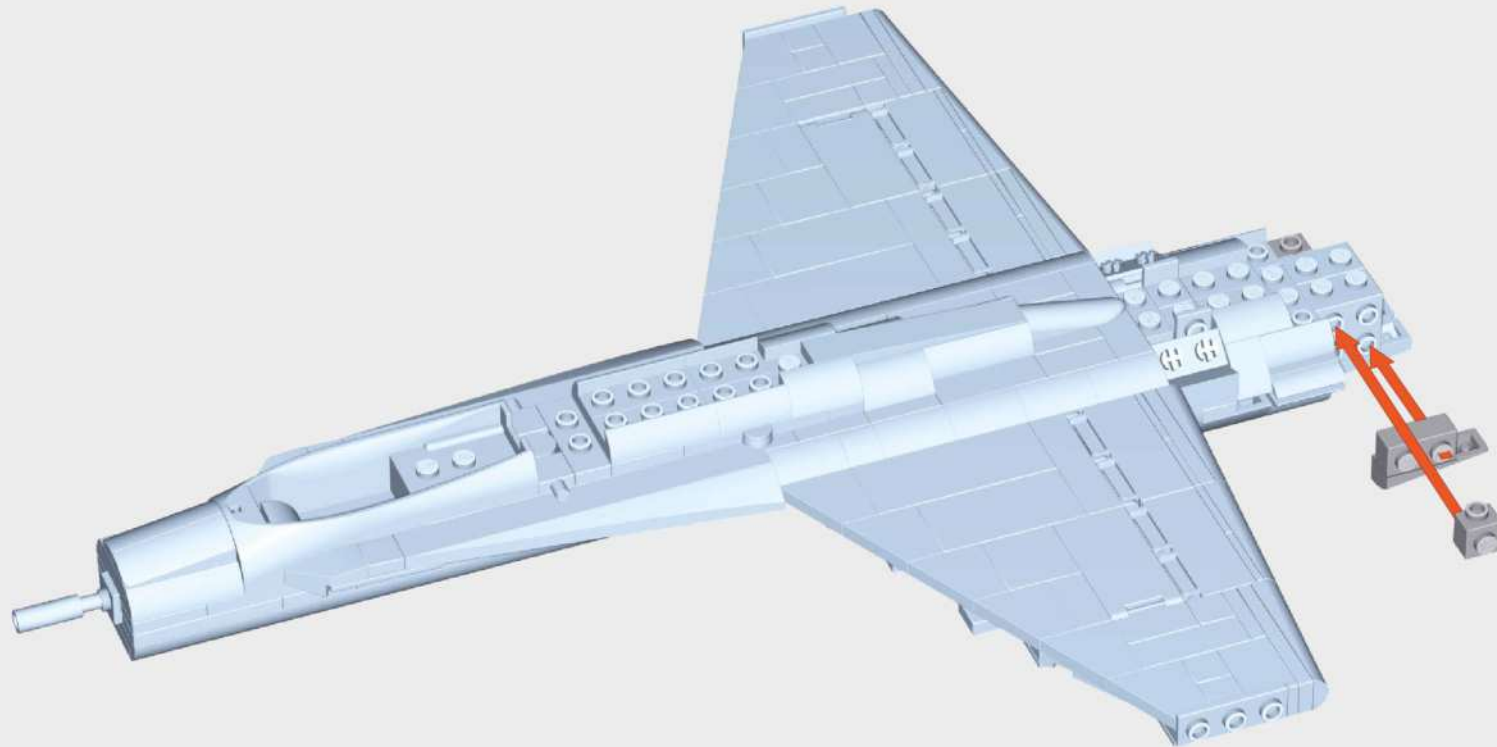

76

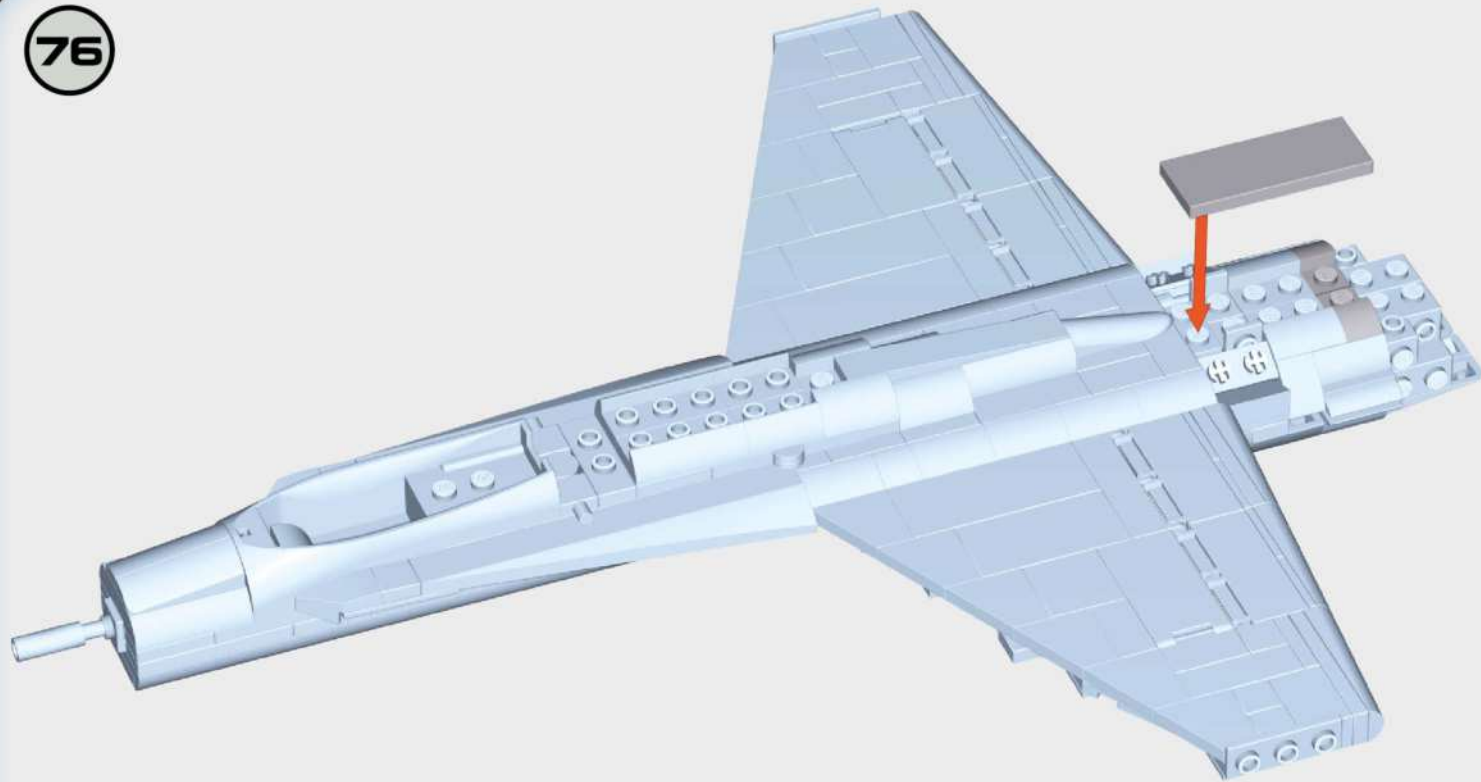

77

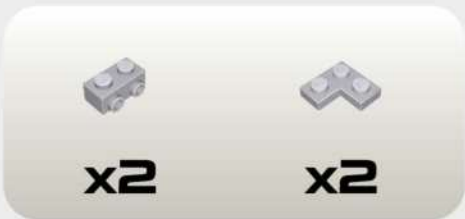
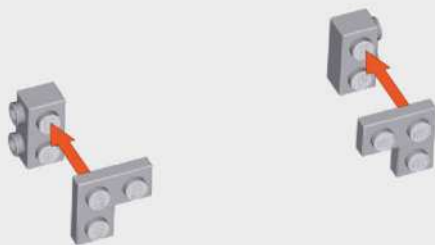

78

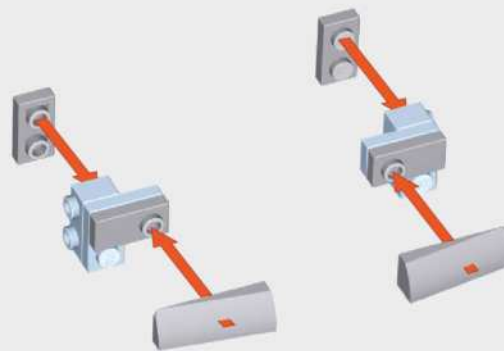

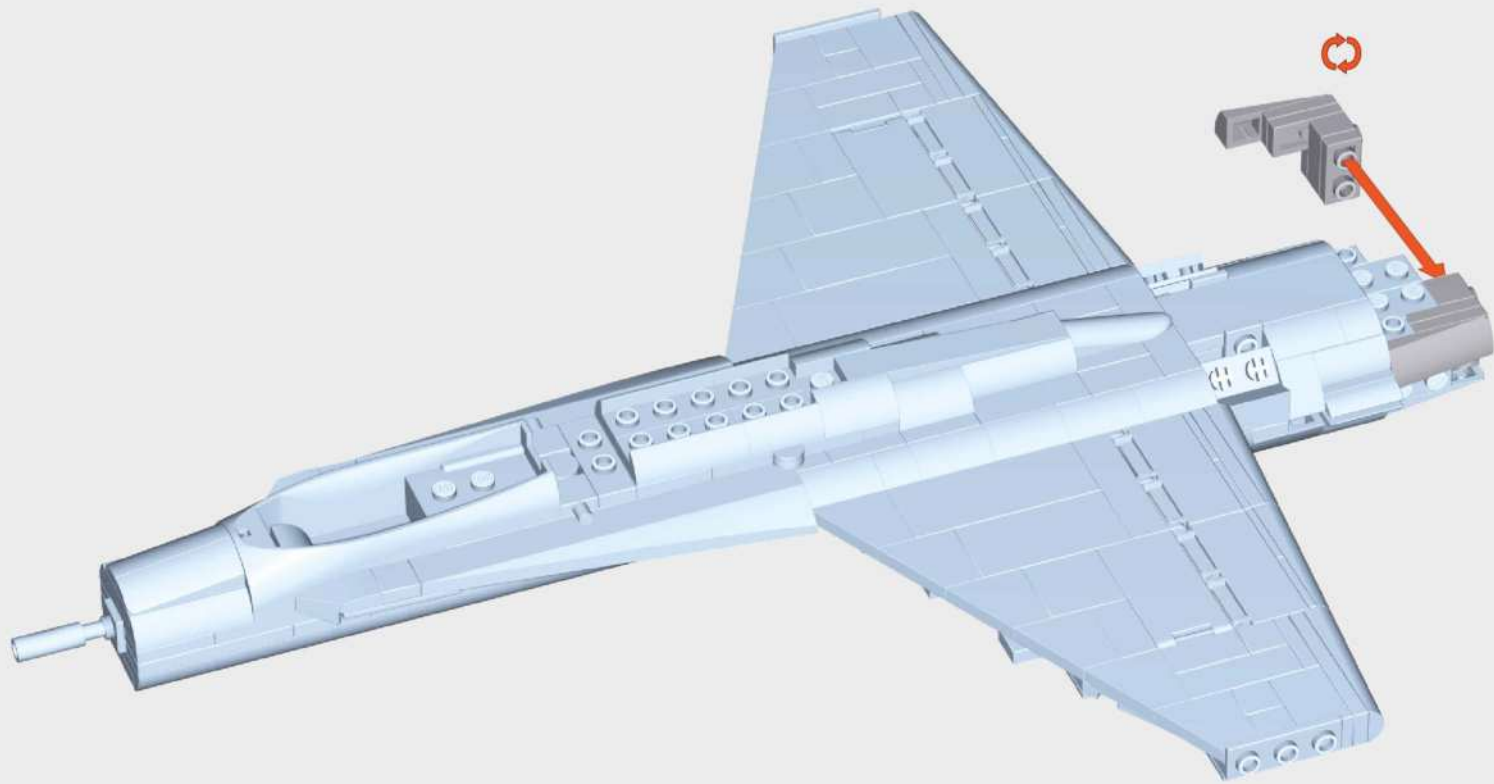

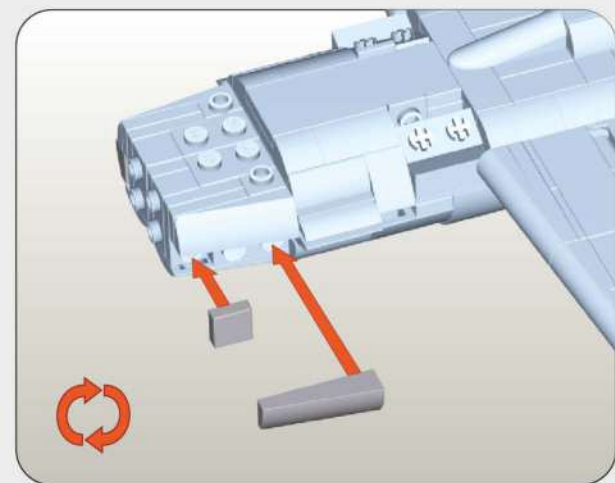
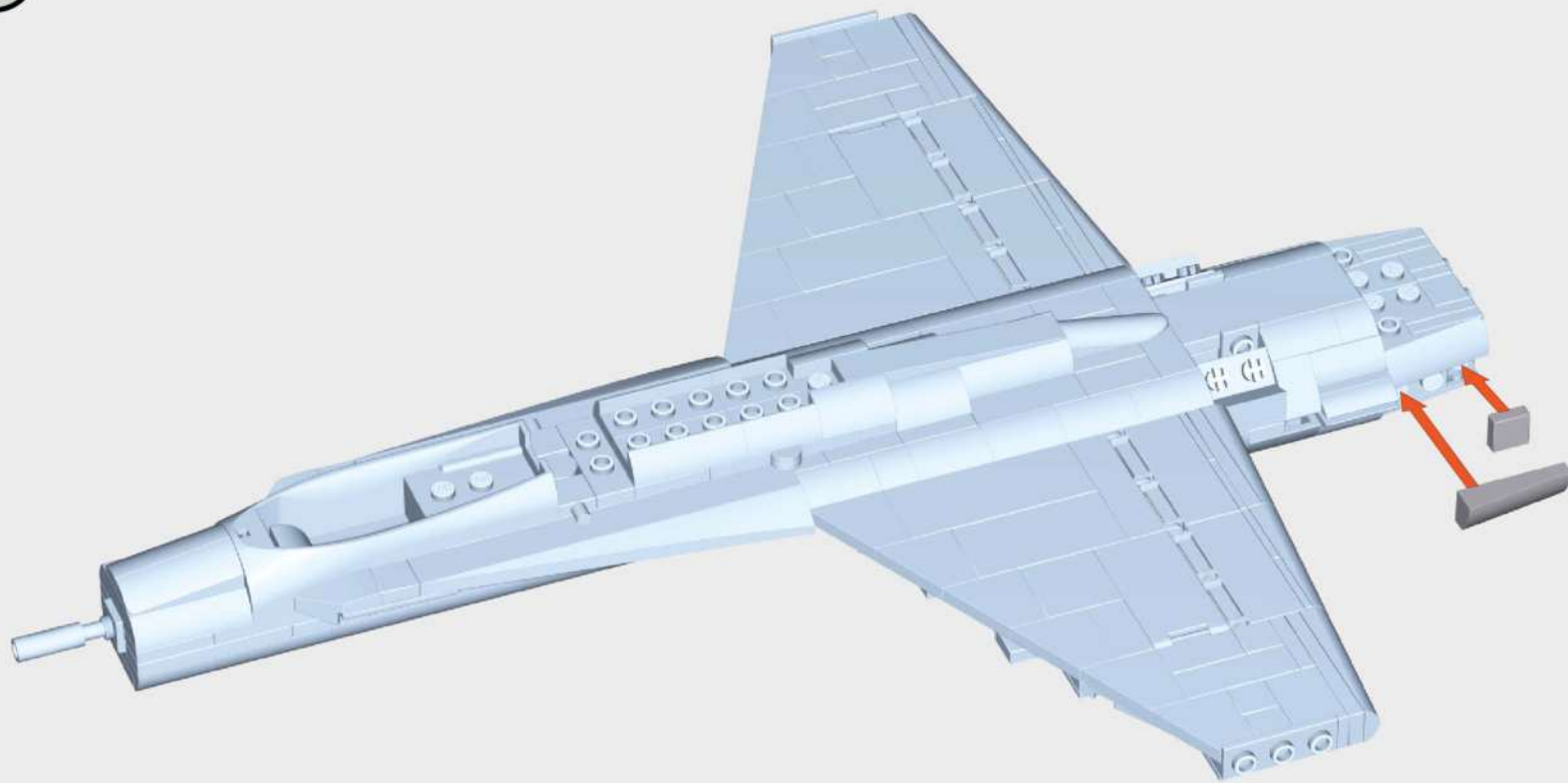

x1 x1 x2

81

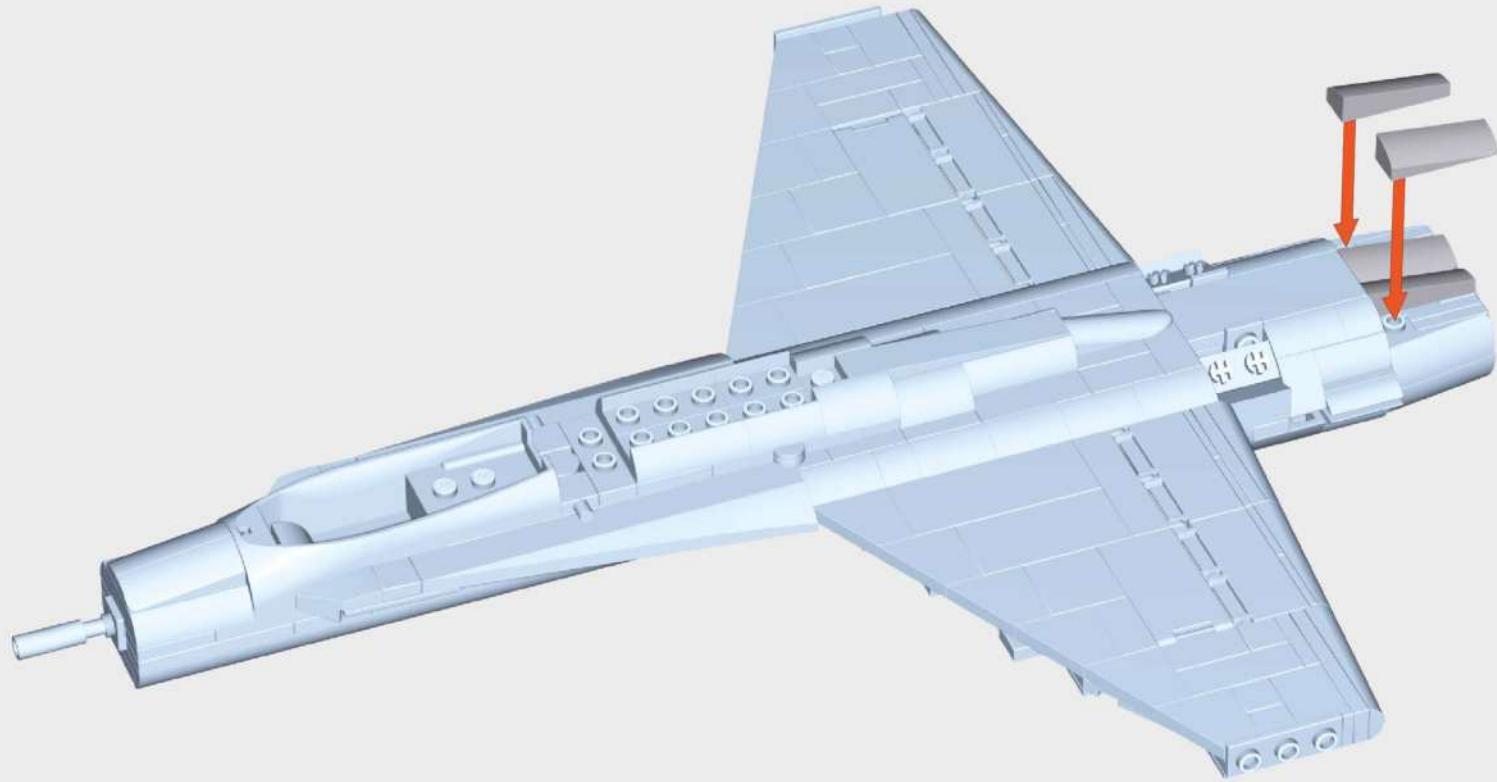

x2



x2

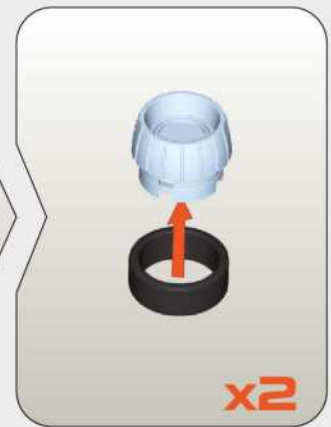

x4

x2

x2

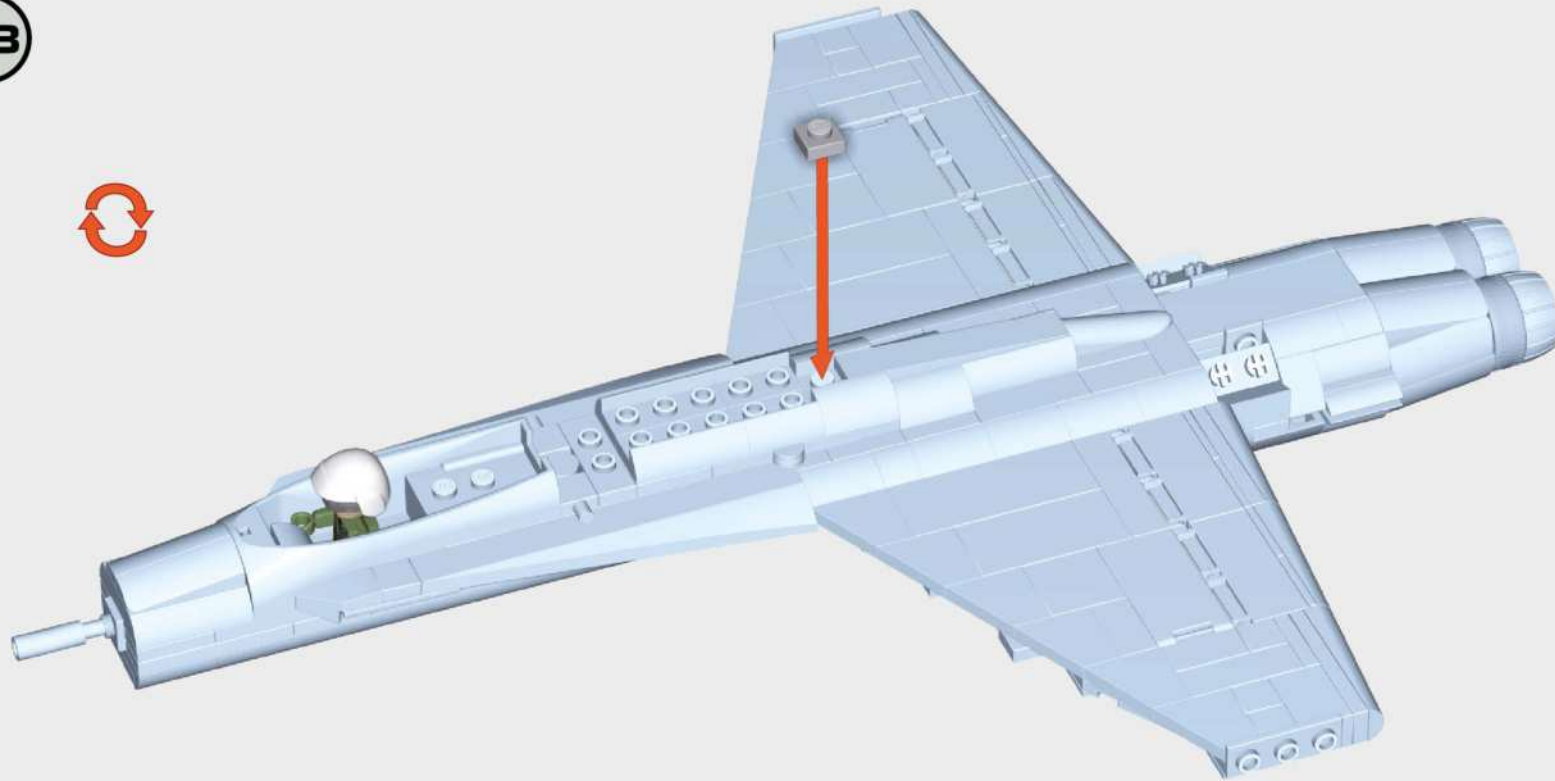

x1



x1



x1



x1



x1



x1

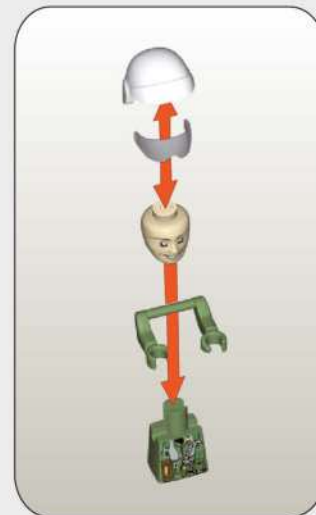

84

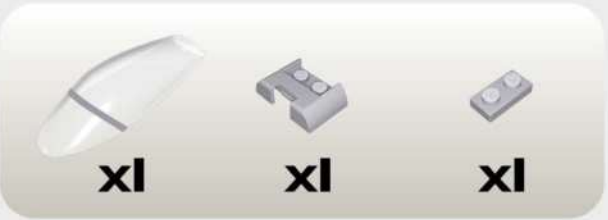
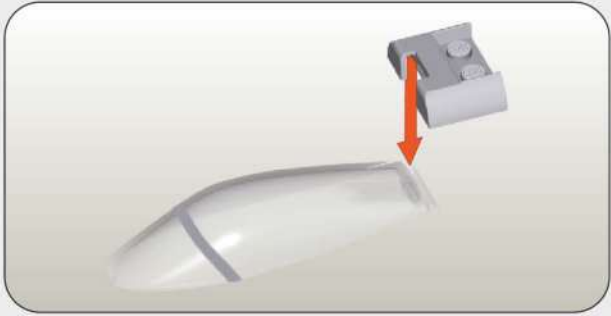
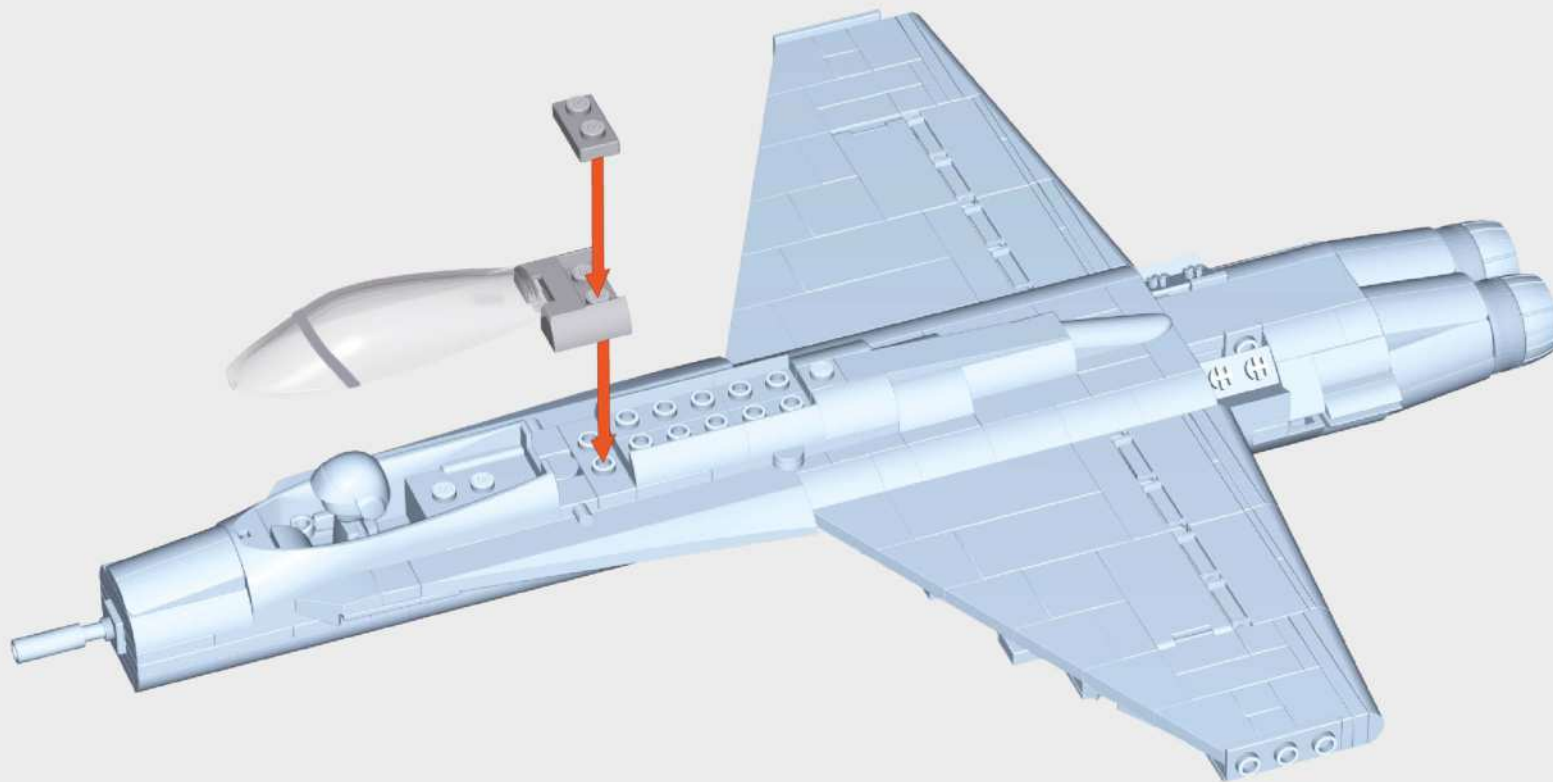

85

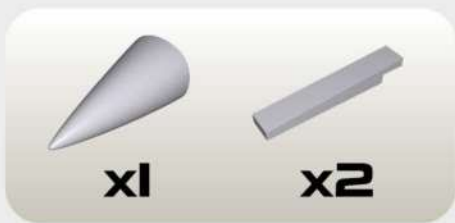
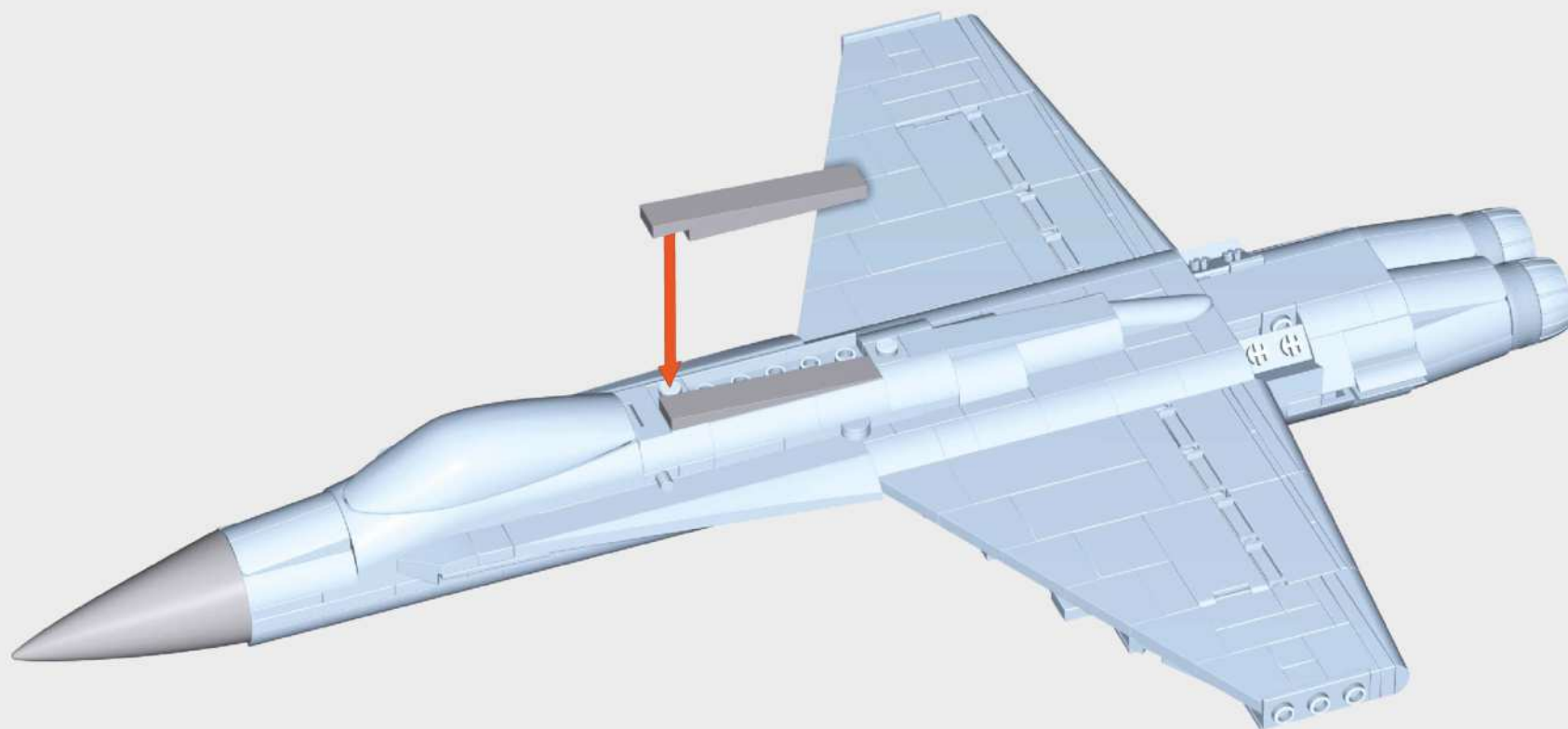

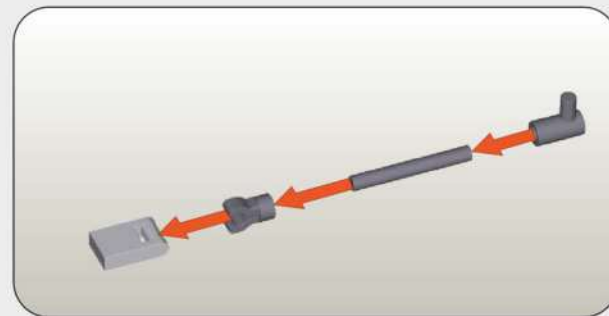
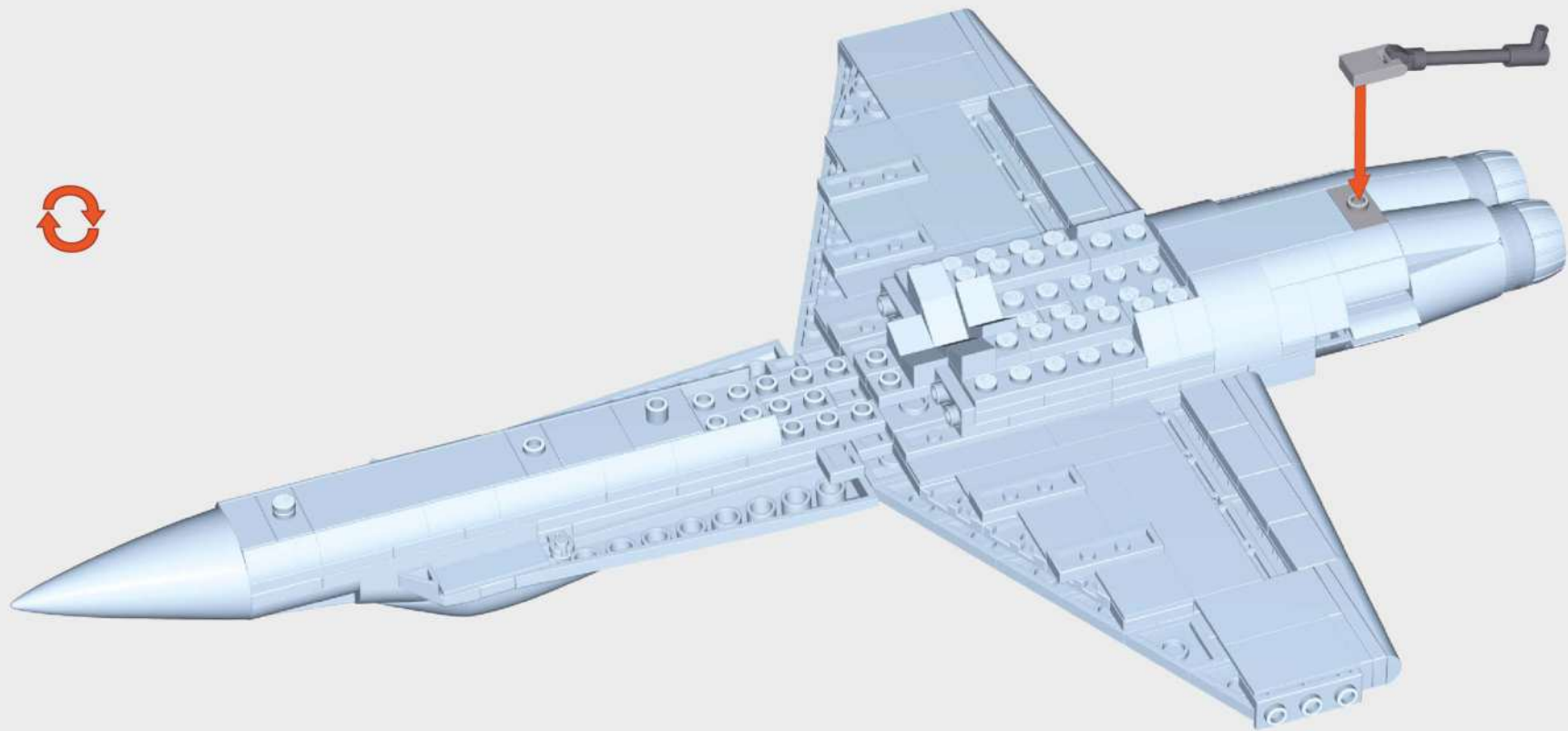

x1



x1



x1



x1



x1

87

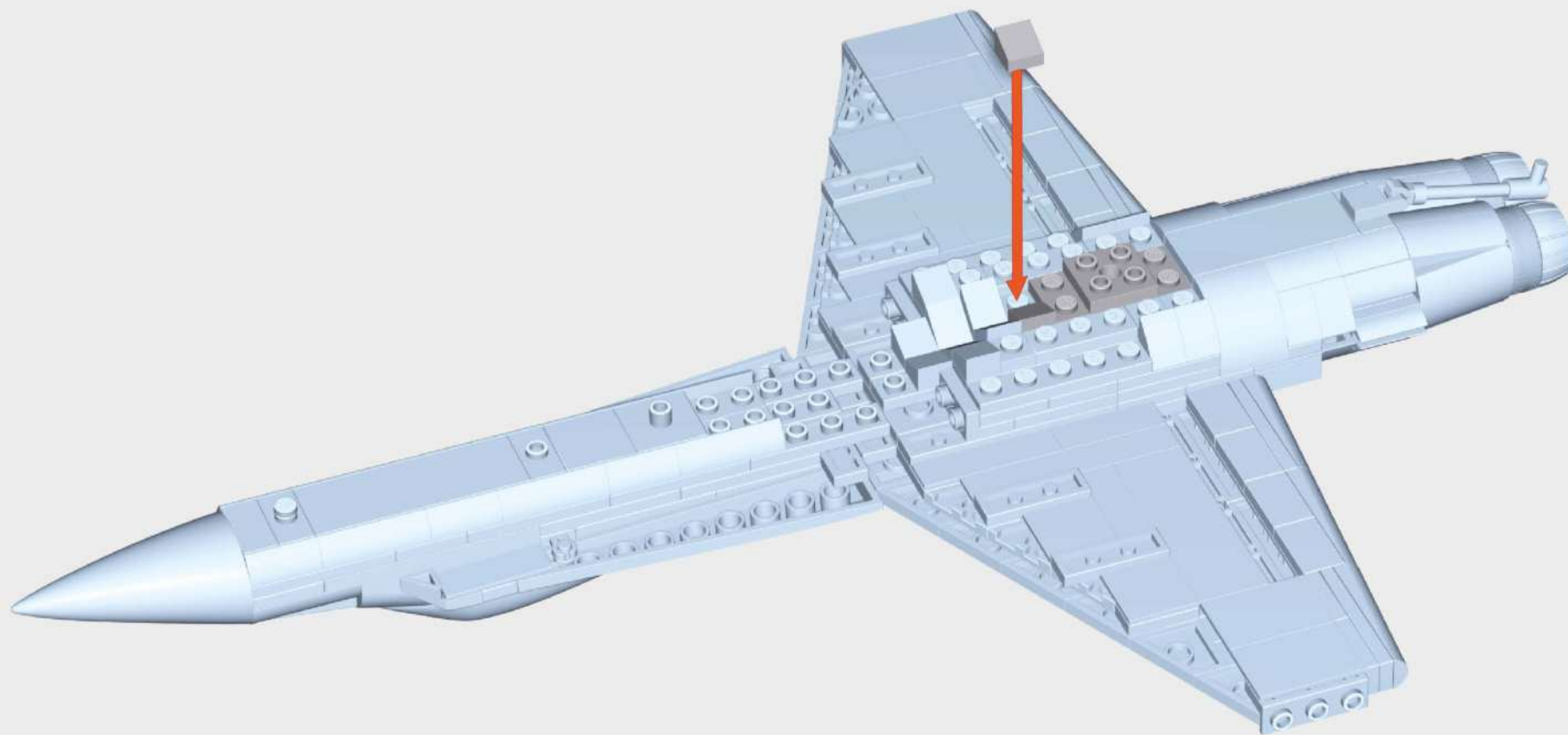

x2



x1

88

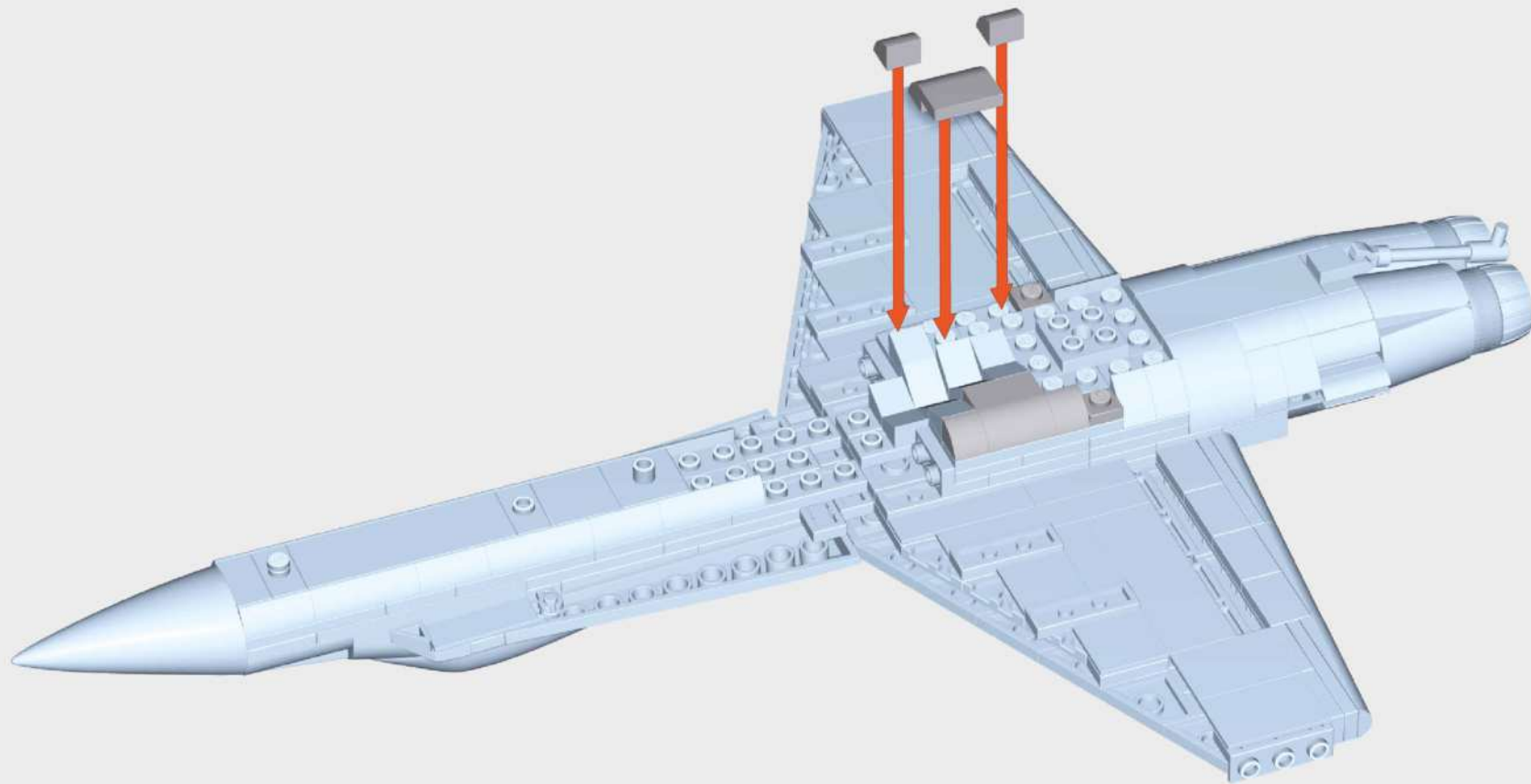

x2



x2



x4

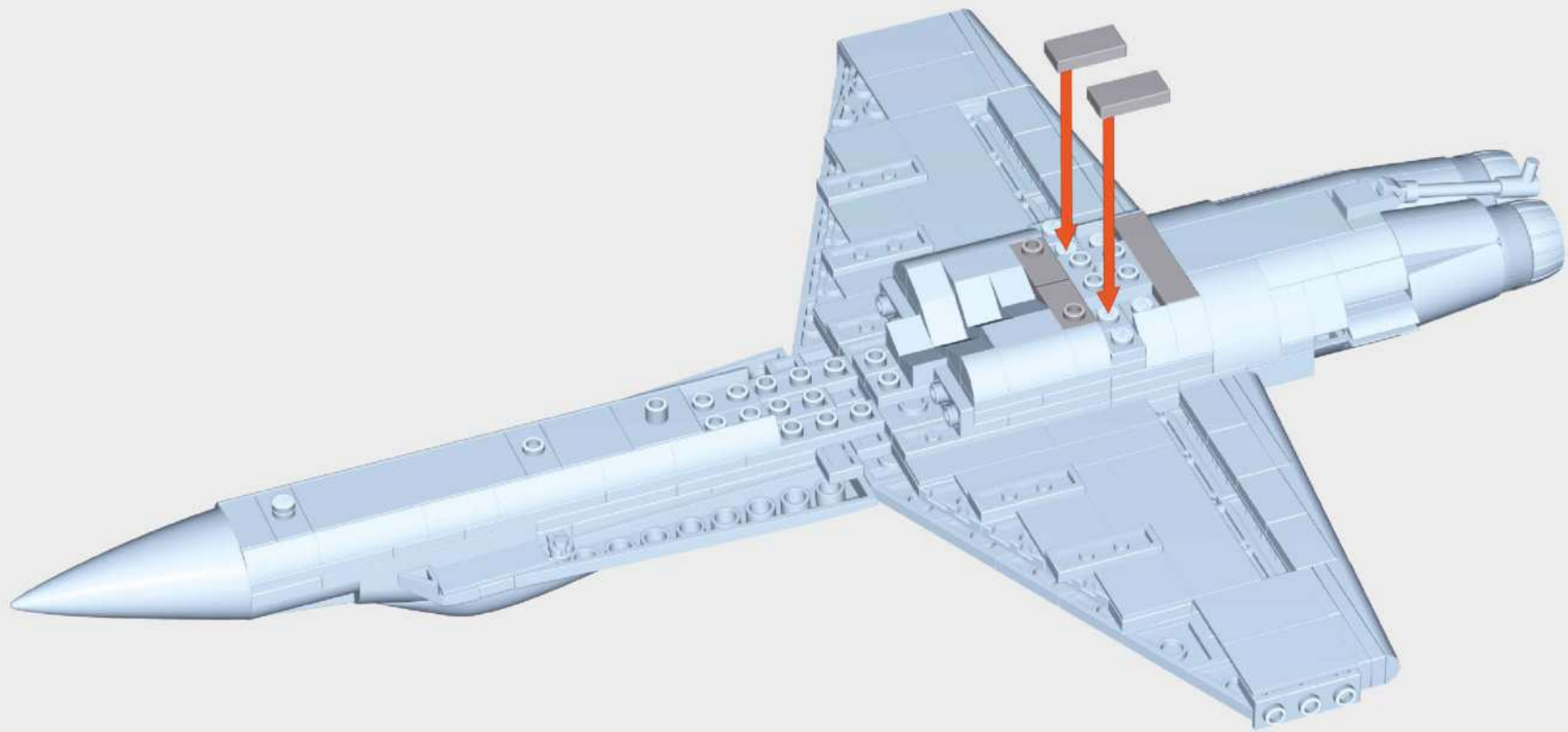

1:1

1:1



x2



x1



x2

90

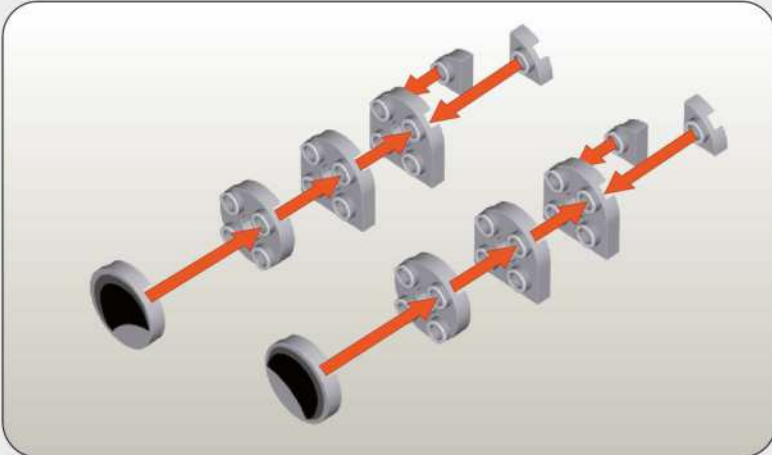
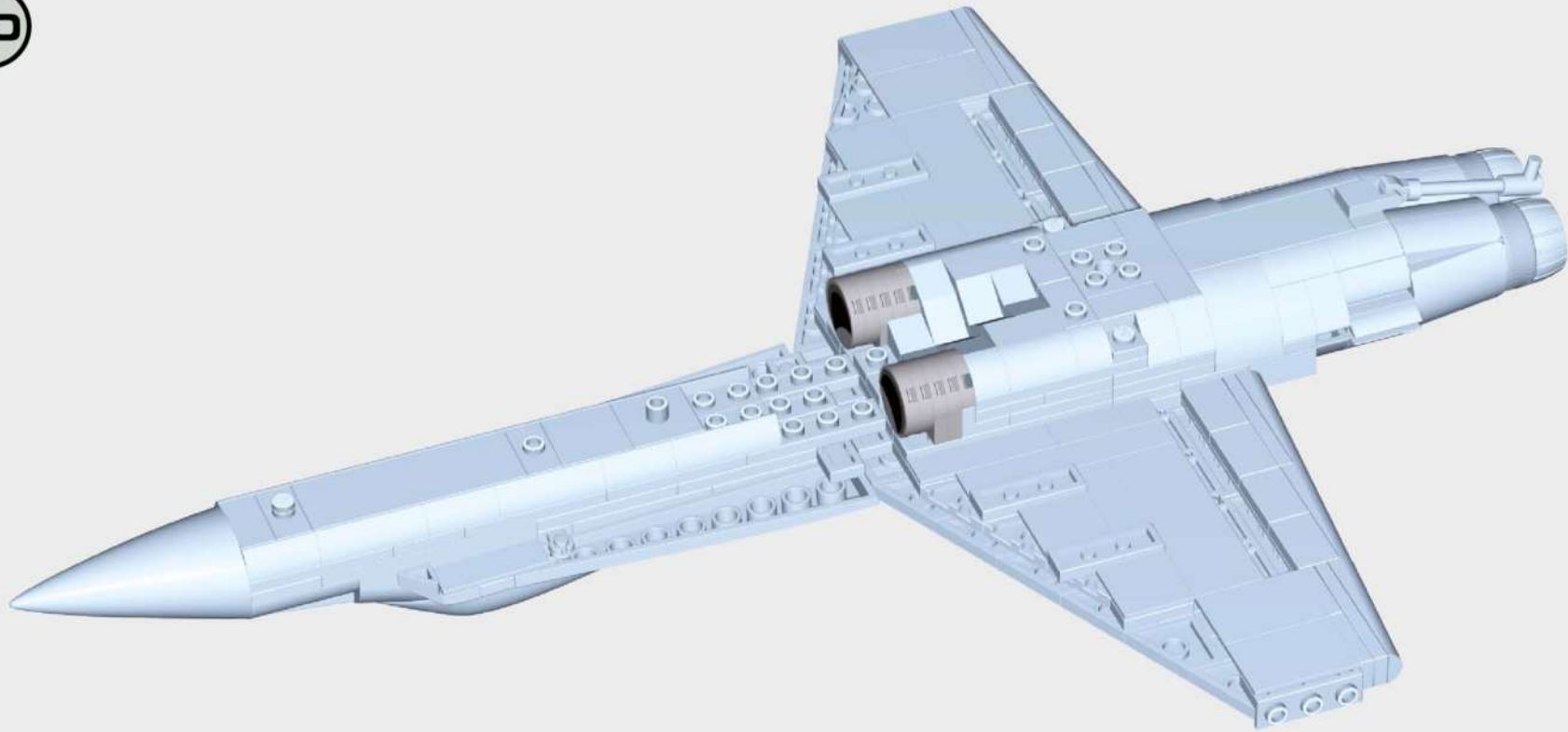

x2



x2



x4



x4

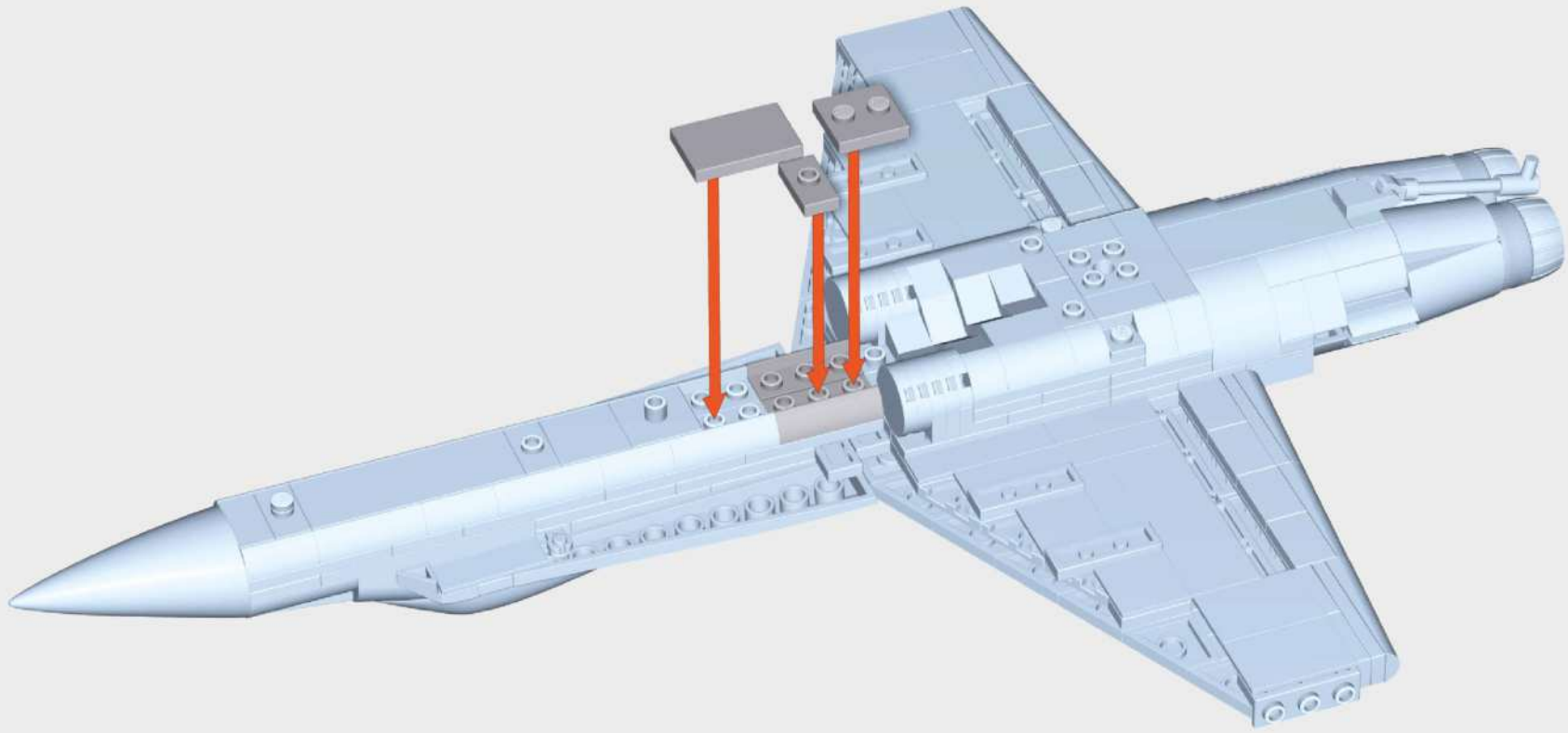

x2



x1



x1



x1

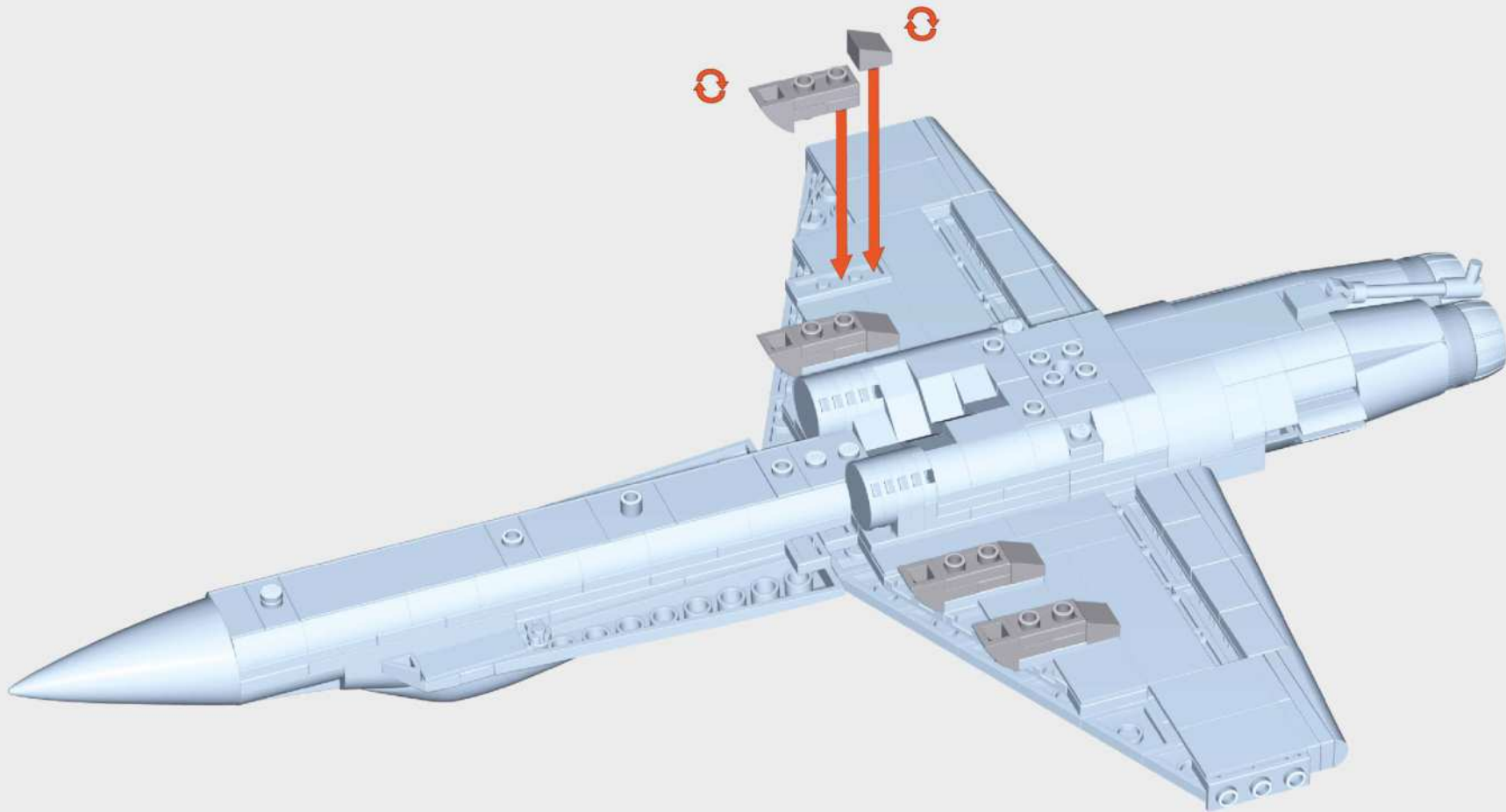

-  x4
-  x4
-  x4
-  x4
-  x4

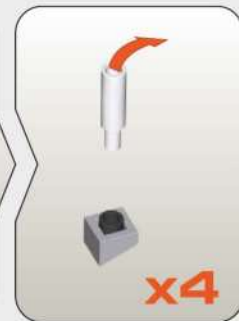
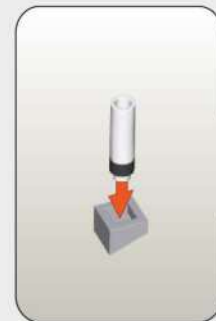
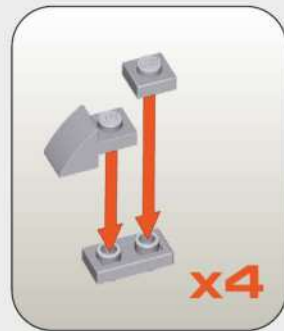

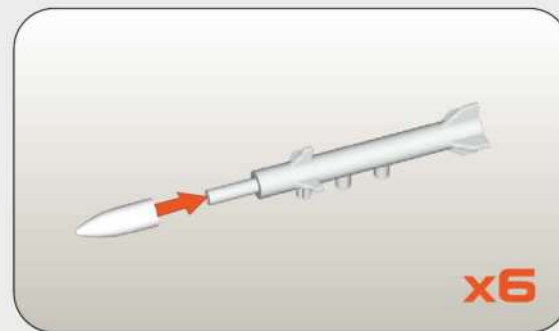
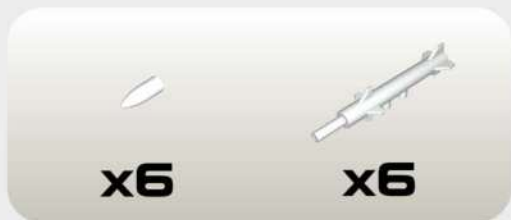
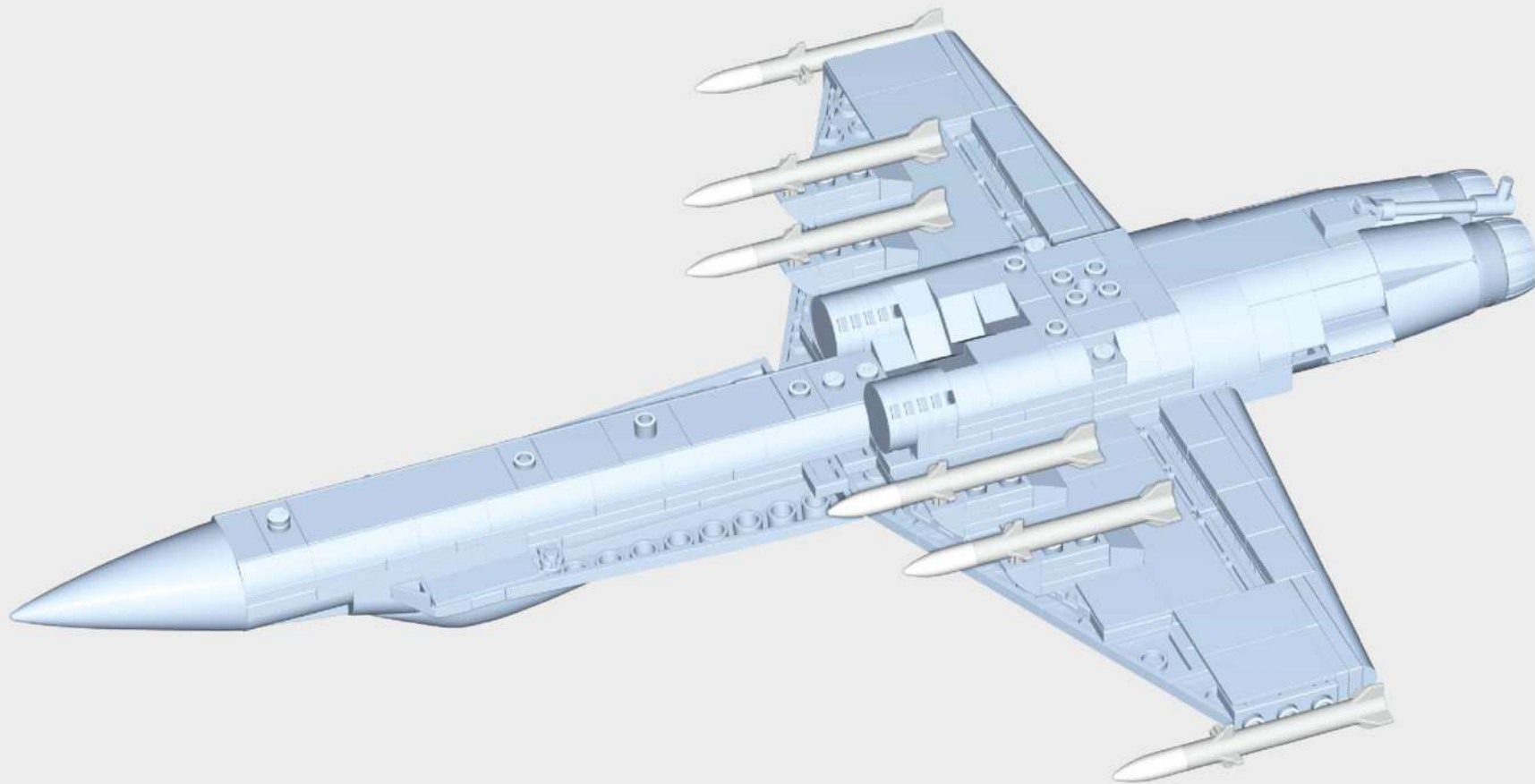

94



x1



x1



x1

95

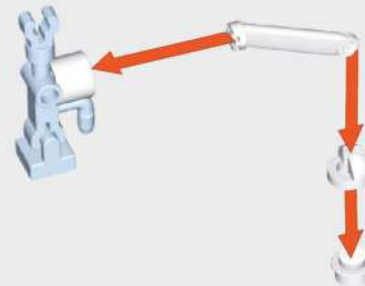

x1



x1



x1



x1

96



x2



x2



x1

97

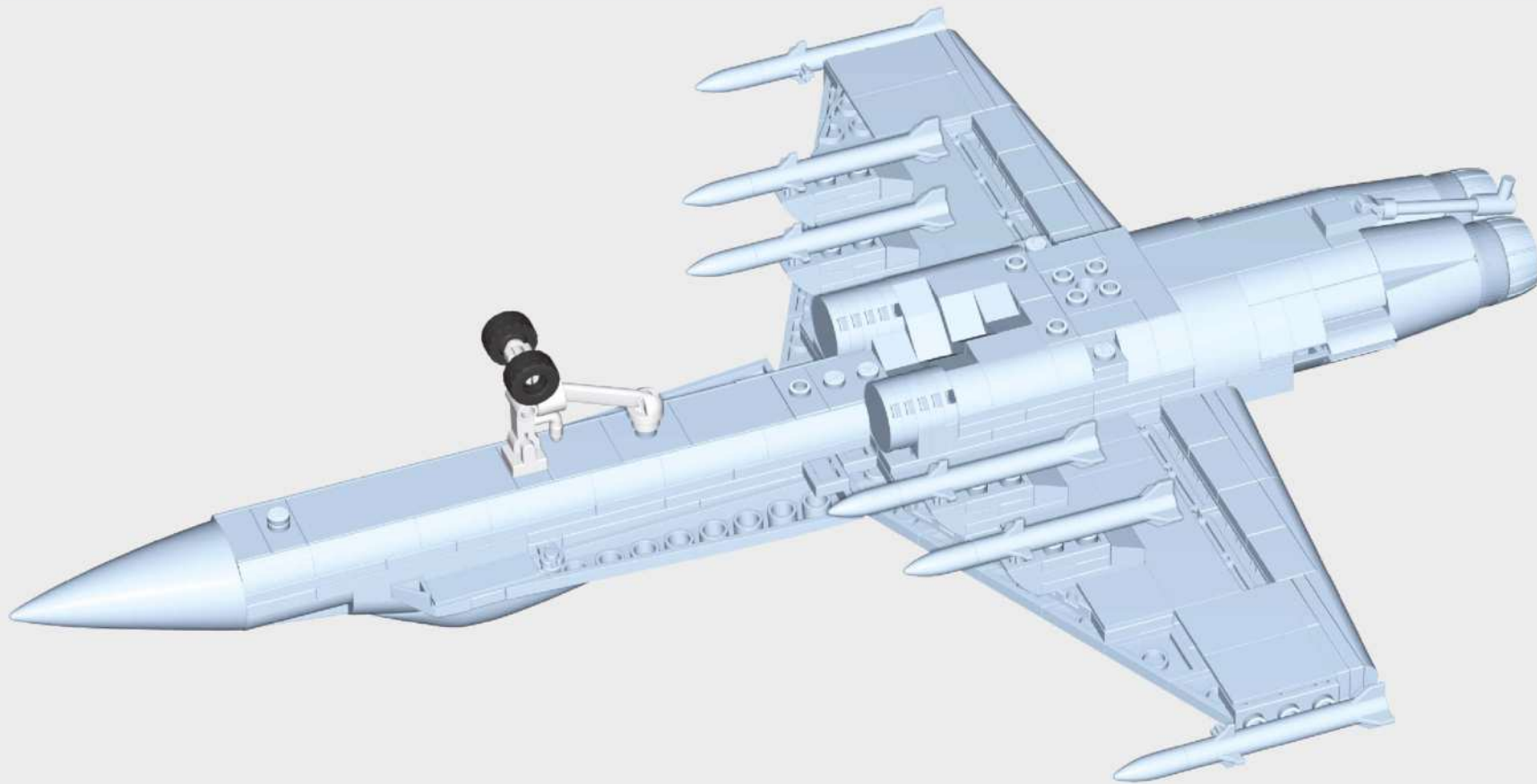

98

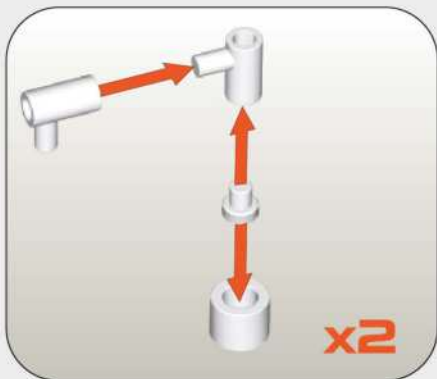

99



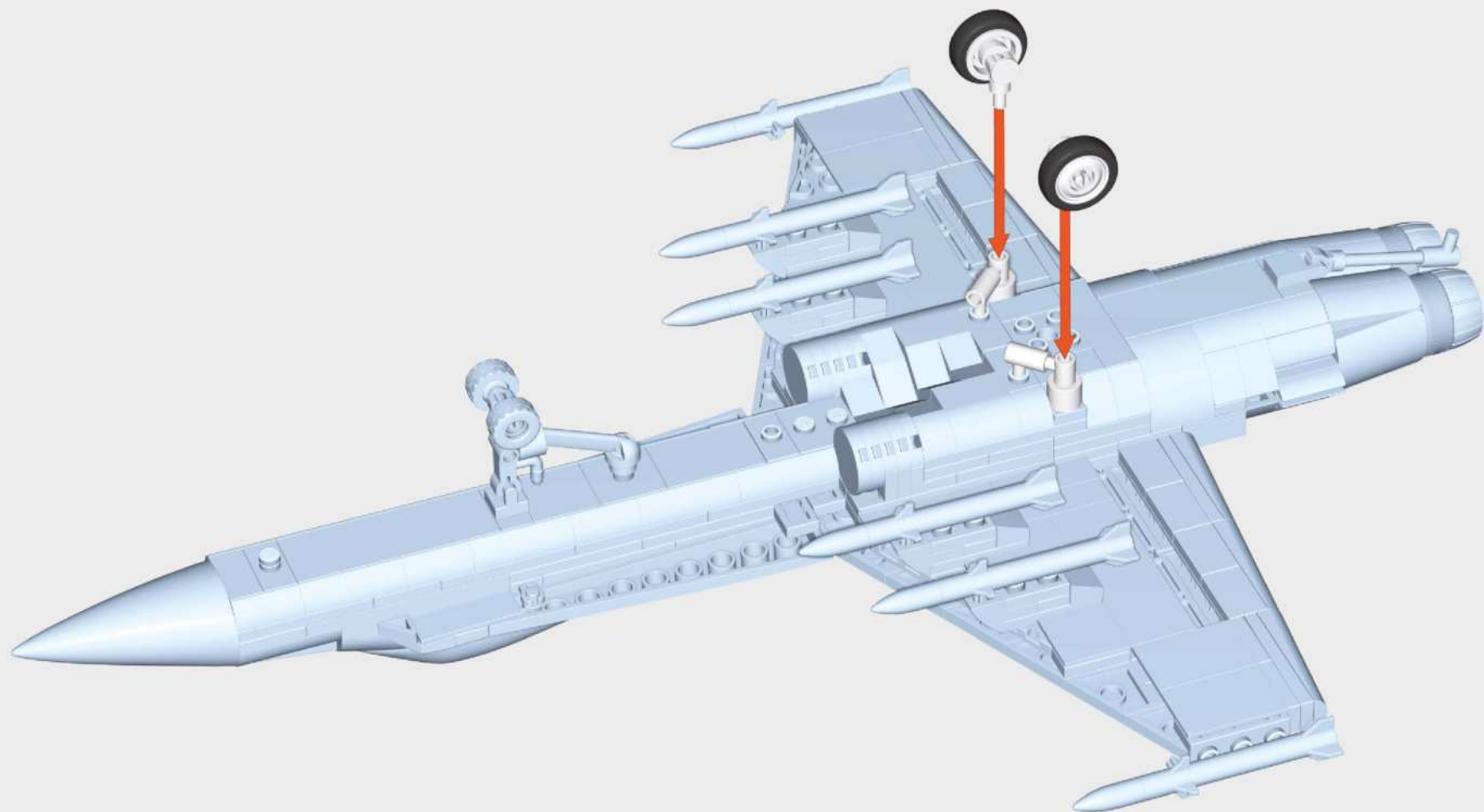

101

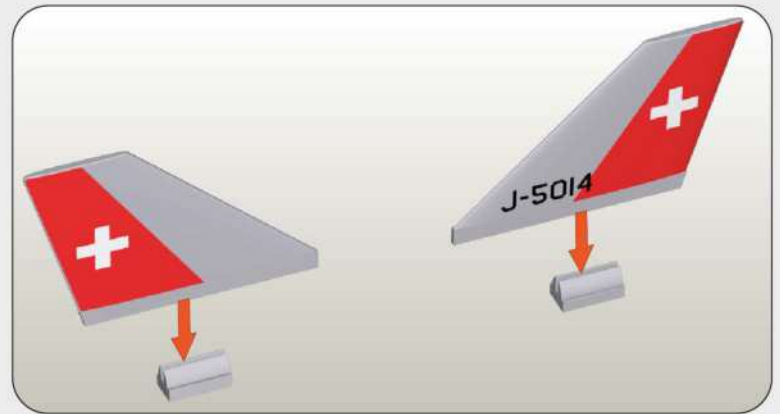
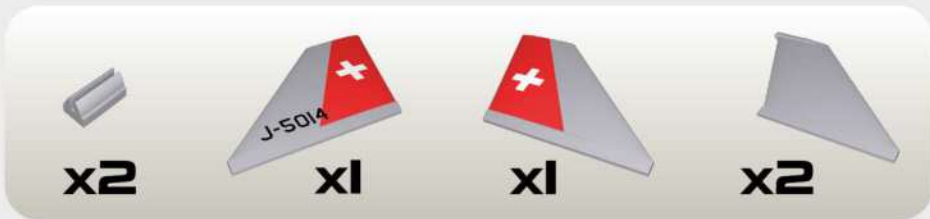

102

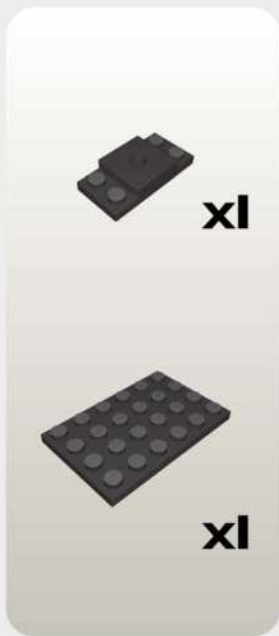

103

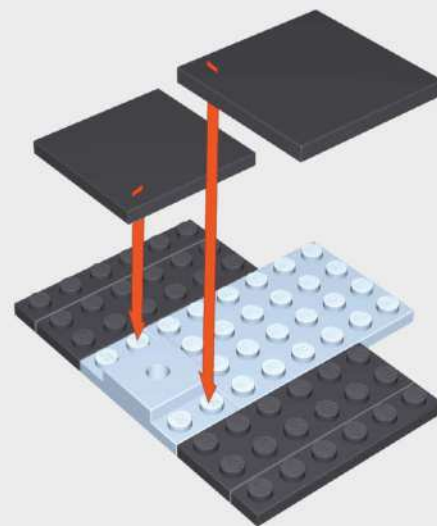

104

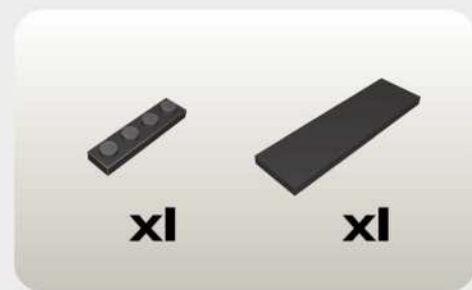
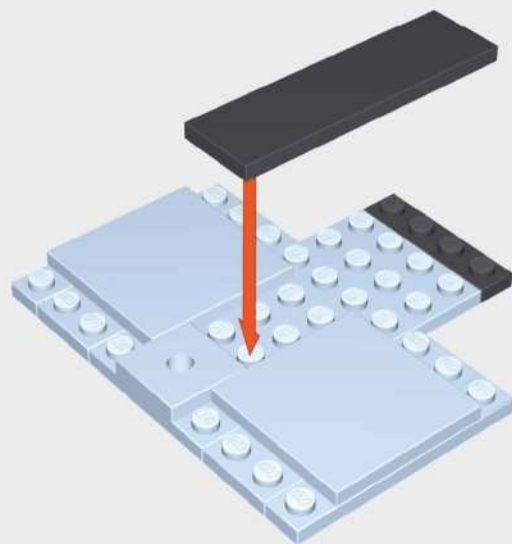

105

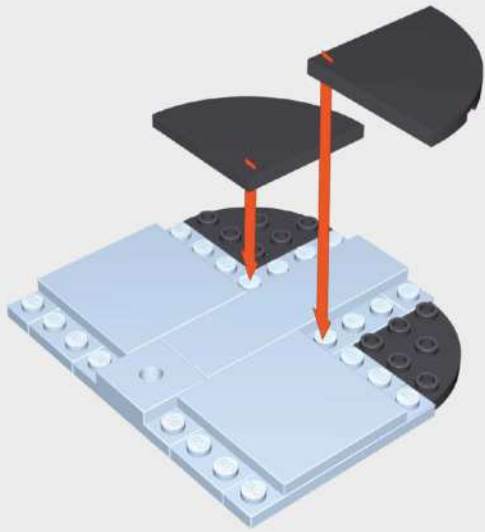

106

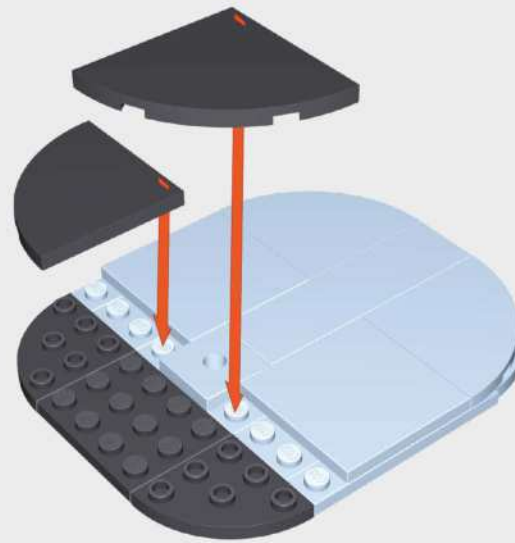

107

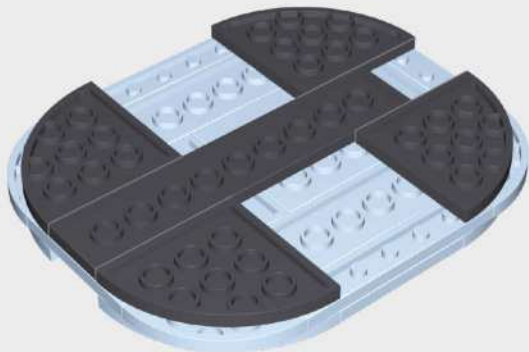

108



1:1



109



x2



x1



x1

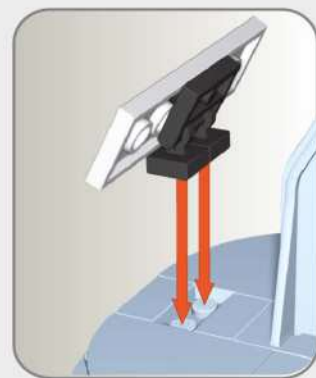
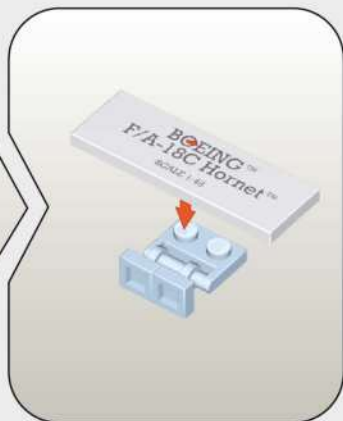
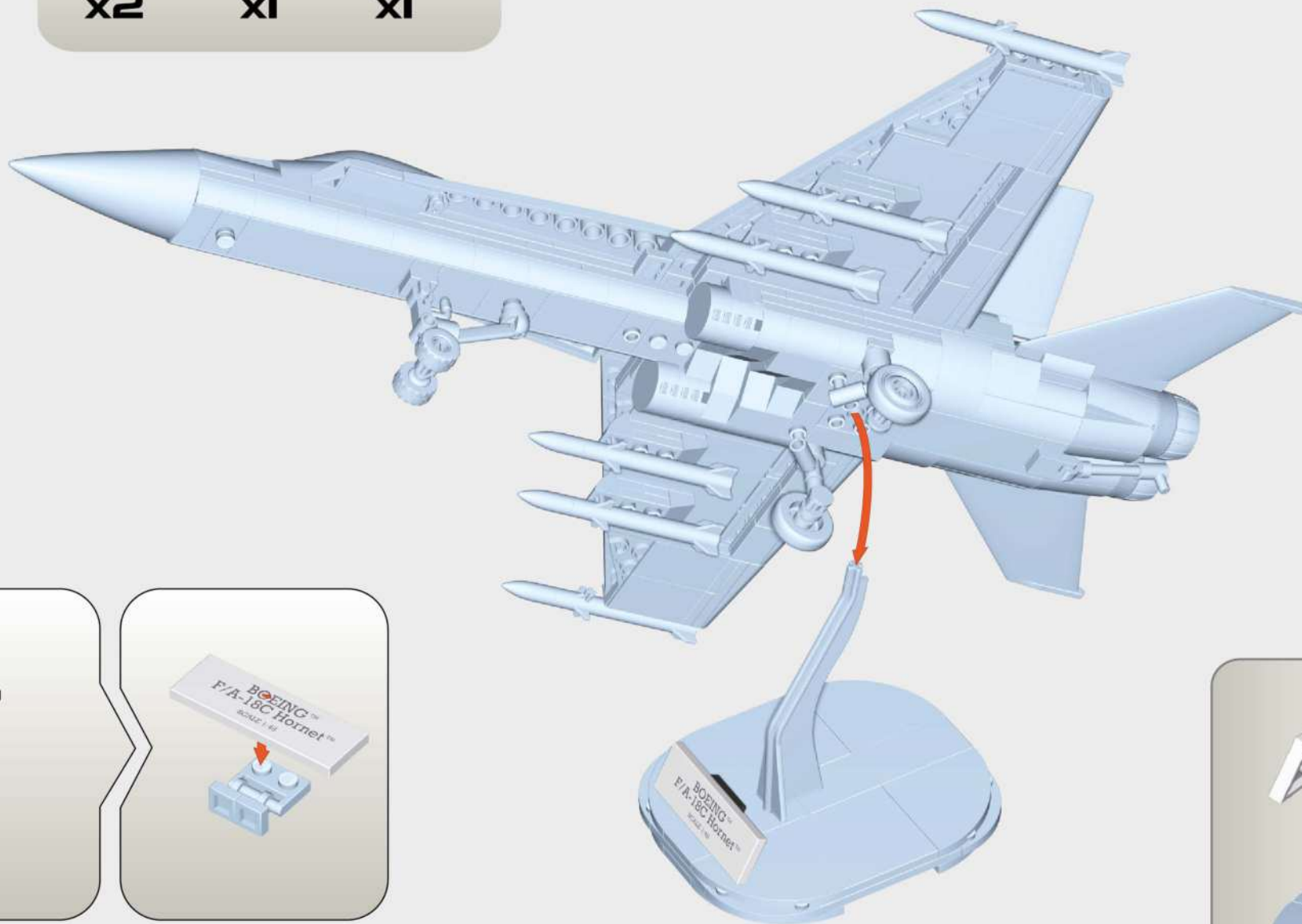

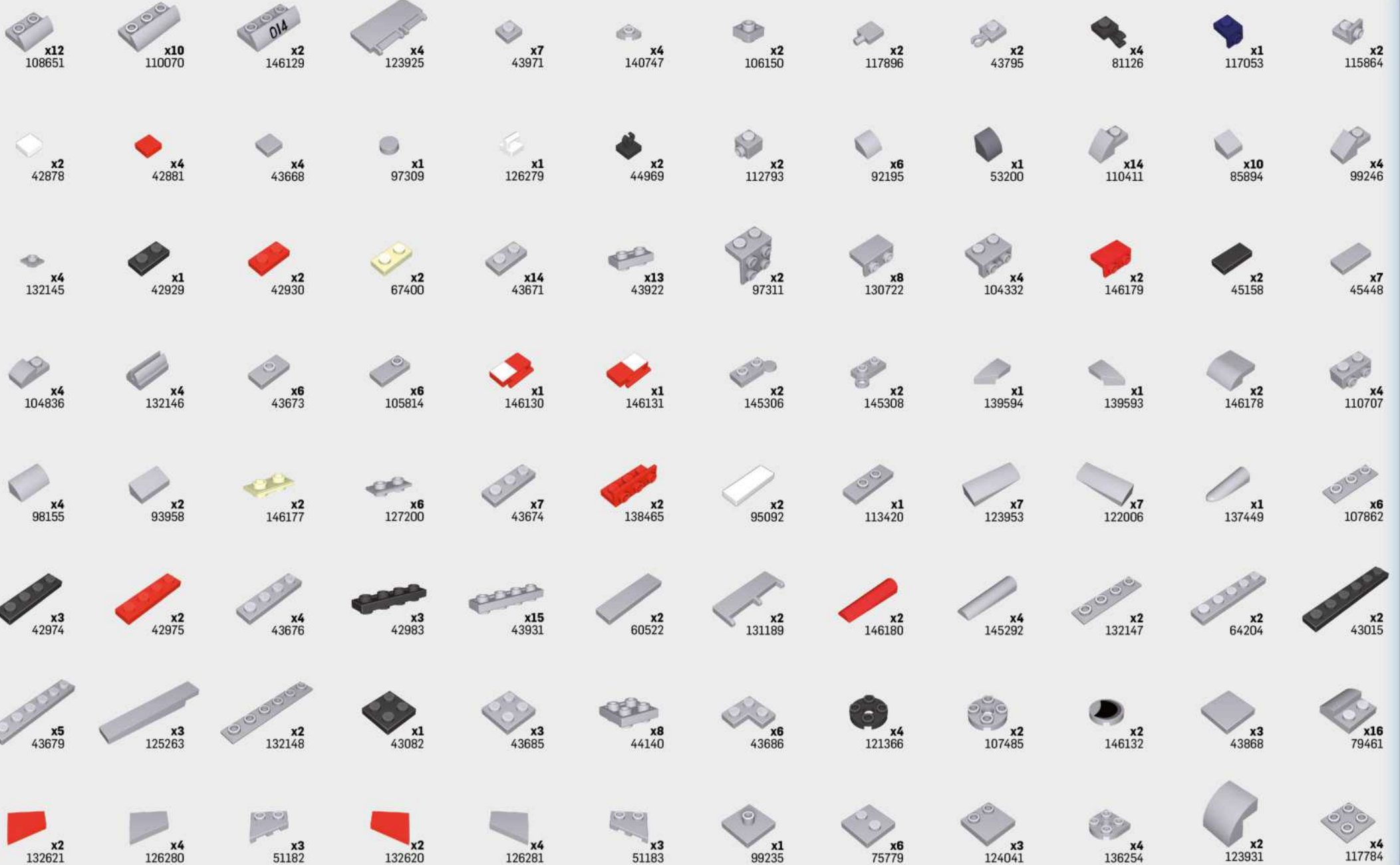

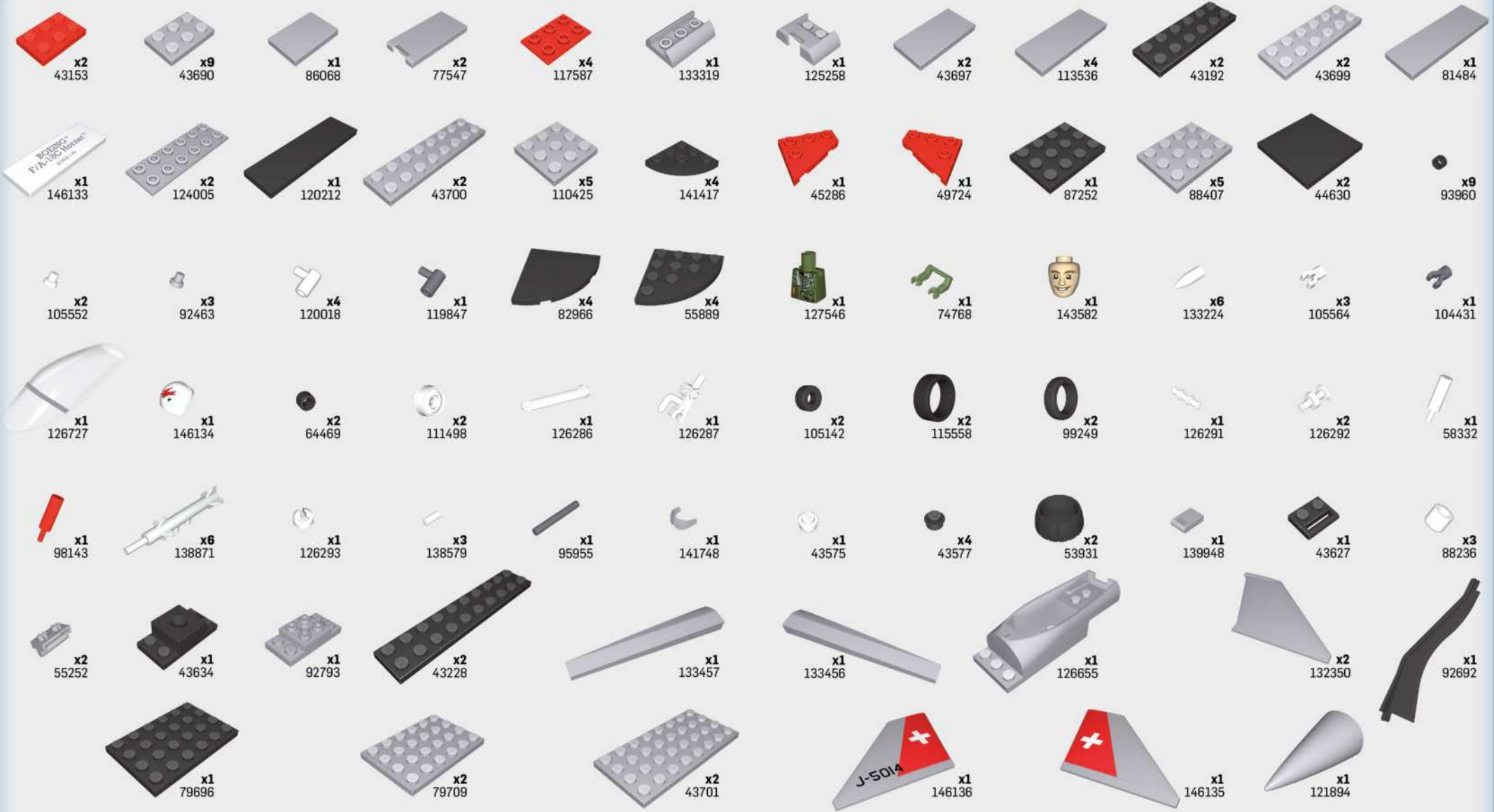



Produced under license from Boeing. Boeing and F/A-18 Hornet are trademarks of The Boeing Company.



F/A-18C HORNET™
5810



F-16® D FIGHTING FALCON®
5815

LOCKHEED MARTIN

LOCKHEED MARTIN®, F-16® D Fighting Falcon®, associated emblems and logos, and body designs of vehicles are either registered trademarks or trademarks of Lockheed Martin Corporation in the USA and/or other jurisdictions, used under license by COBI.



F-16® C FIGHTING FALCON®
5814

LOCKHEED MARTIN

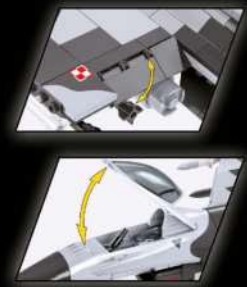

LOCKHEED MARTIN®, F-16® C Fighting Falcon®, associated emblems and logos, and body designs of vehicles are either registered trademarks or trademarks of Lockheed Martin Corporation in the USA and/or other jurisdictions, used under license by COBI.

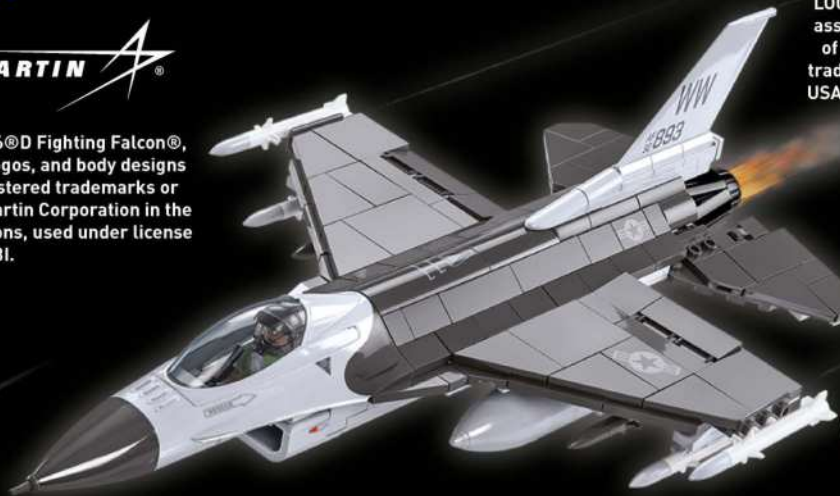

F-16® C FIGHTING FALCON®
5813

WWW.COBI.EU

For news and special deals

03-05819-536

Find us on:
cobi.bricks
cobi.klocki
COBI SA