

# ARMED FORCES



**MIG-29 NATO CODE "FULCRUM"**  
 IN POLISH SERVICE - 1989 - PRESENT  
 PLACE OF ORIGIN - SOVIET UNION  
 ROLE - FIGHTER  
 WINGSPAN - 11,36m (37' 3")  
 LENGTH - 17,32m (56' 10")  
 HEIGHT - 4,73m (15' 6")  
 WEIGHT - 14900kg (32849lb)  
 ENGINE - 2x KLIMOV RD-33 AFTERBURNING TURBOFANS  
 RANGE - 1430km (770nm)  
 RATE OF CLIMB - 300m/s (59055ft/min)  
 MAXIMUM FLIGHT LEVEL - 18000m (59055ft)  
 MAXIMUM SPEED - 2,5MACH  
 ARMAMENT - 1x 30mm GRYAZEY-SHIPUNOV GSH-30-1 GUN,  
 AIR-TO-AIR ROCKETS, AIR-TO-GROUND ROCKETS,  
 BOMBS  
 CREW - 1 PILOT



**PAD PRINTED**  
 NO STICKERS

Printed in EU

5834



UK  
CA

CE



**WARNING: CHOKING HAZARD-**  
 Toy contains small parts.  
 Not for children under 3 years.

600 

**MIG29 NATO CODE "FULCRUM"**

SCALE 1:48



BE CAREFUL: NOTICE THE DIFFERENCE



UWAGA: RÓŻNE KLOCKI

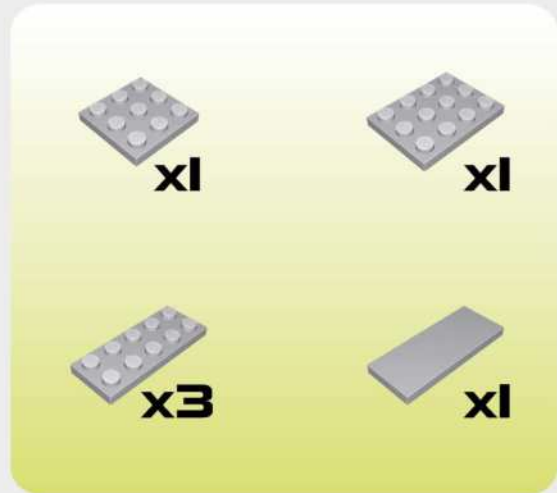

1

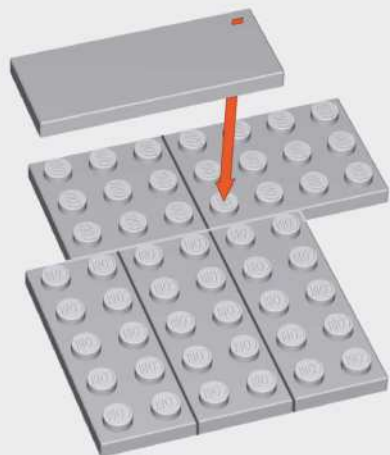

2

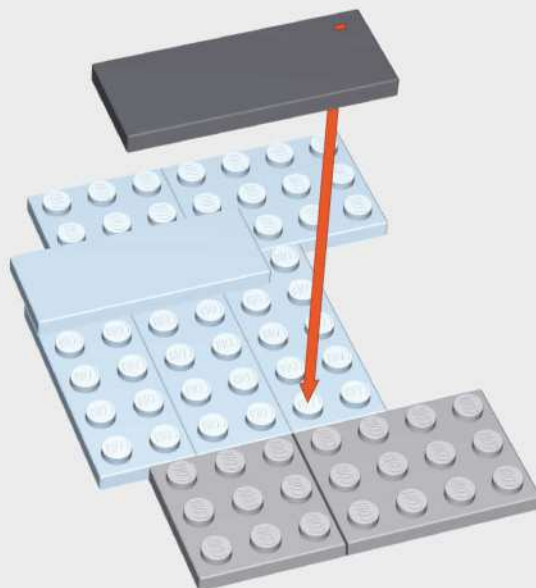
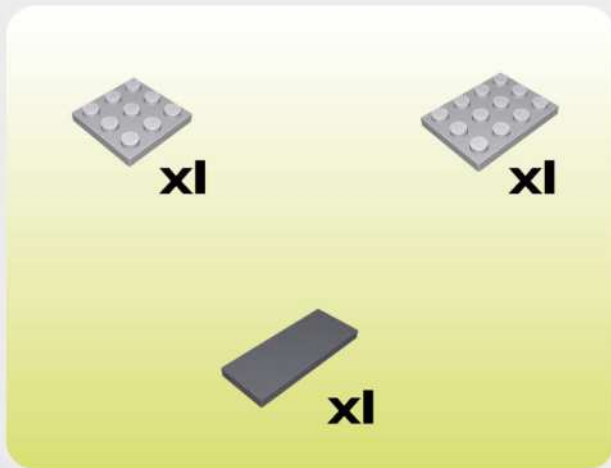

3

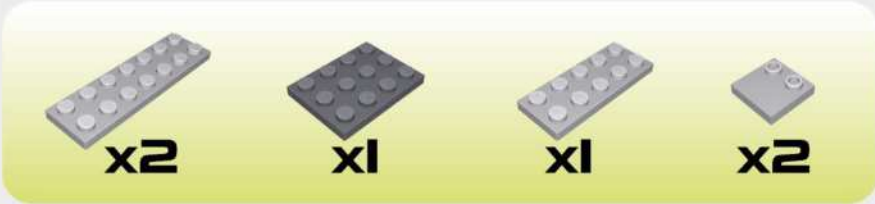
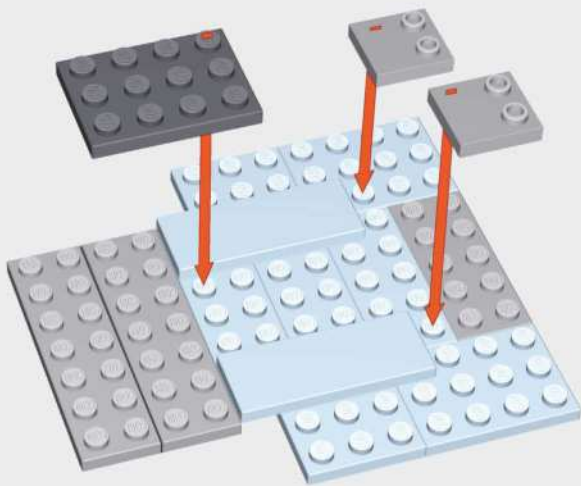

4

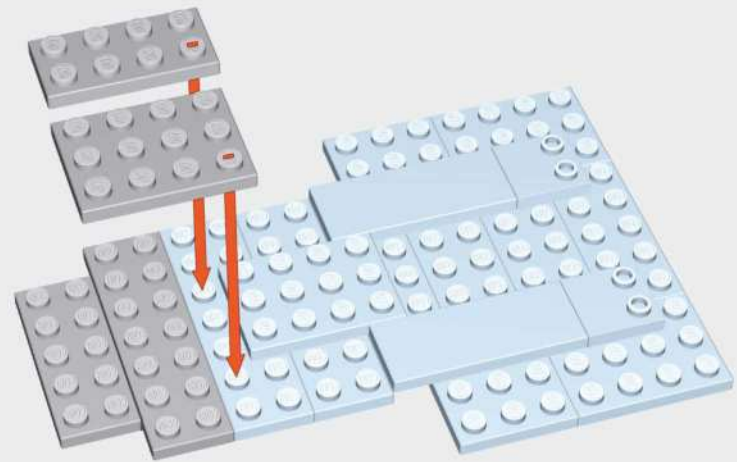



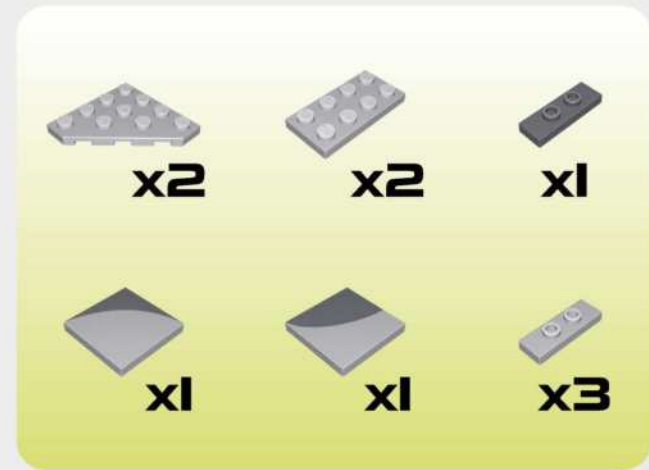
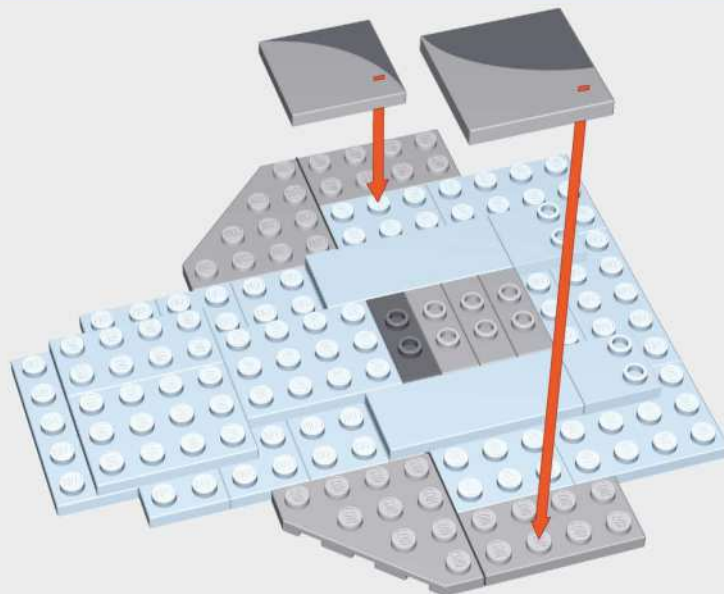

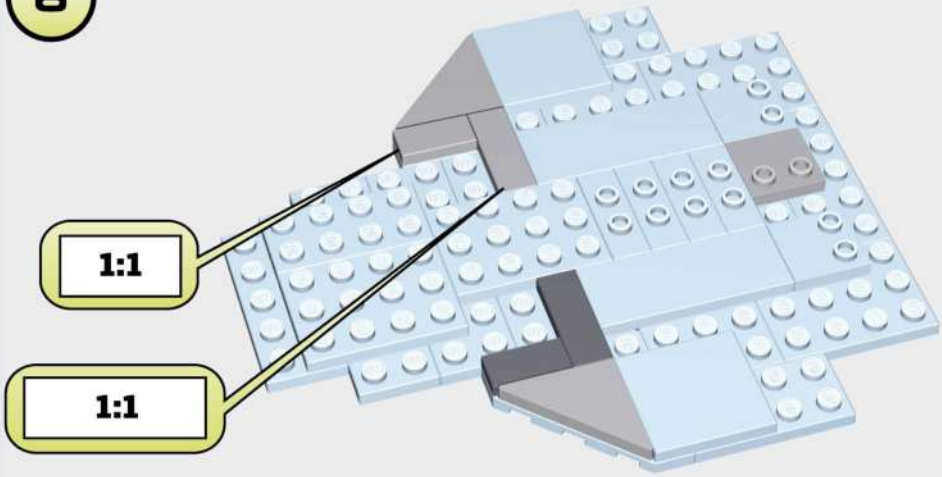

5



6



-   
**x2**
-   
**x1**
-   
**x1**
-   
**x1**
-   
**x1**
-   
**x1**

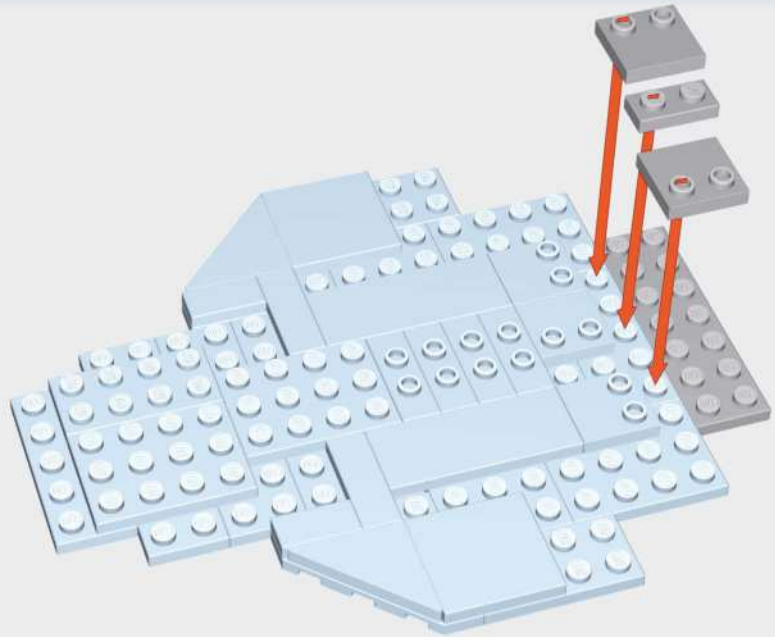

7

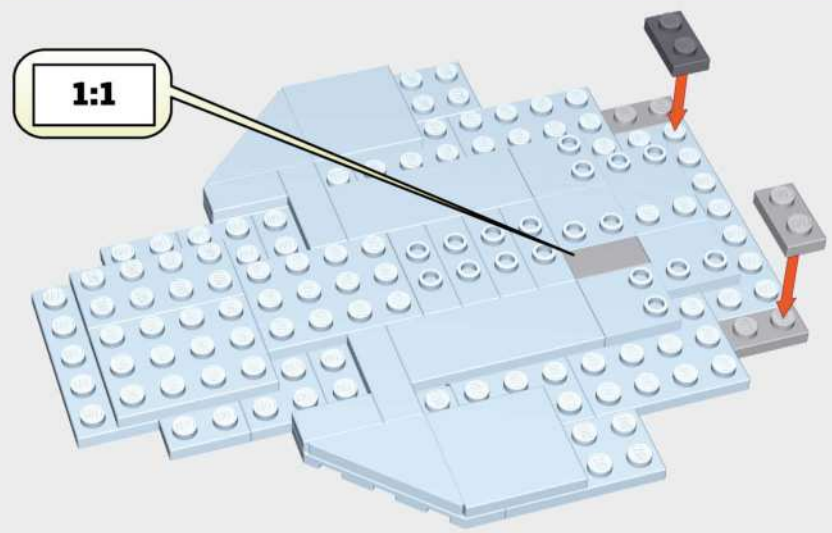

-   
**x1**
-   
**x2**
-   
**x1**

8



-   
**x3**
-   
**x1**
-   
**x1**

9

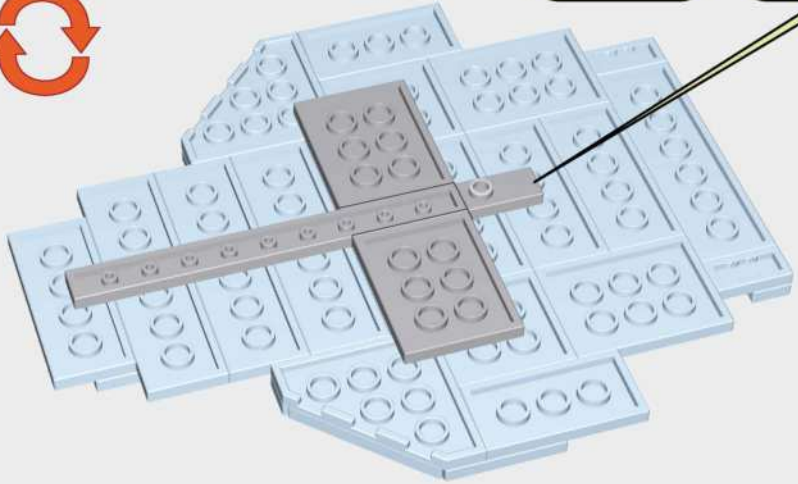
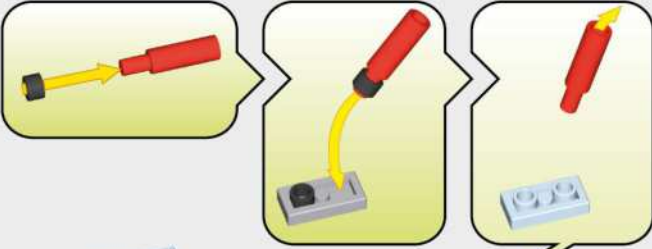

10

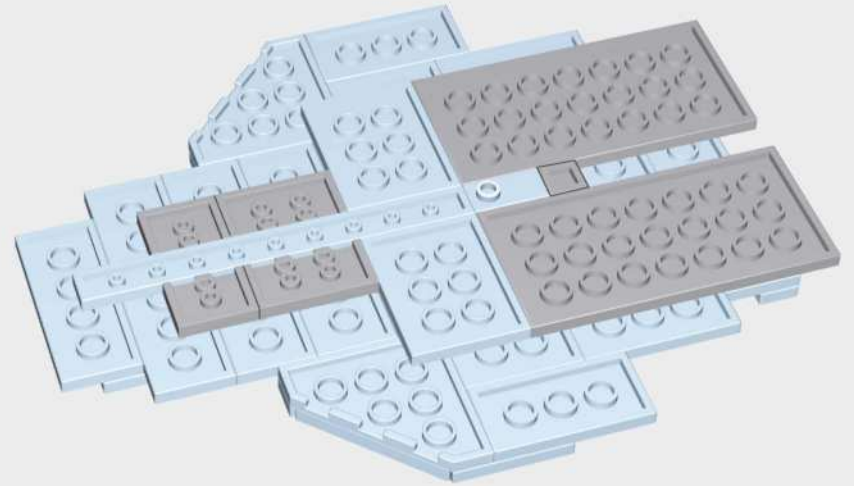

11

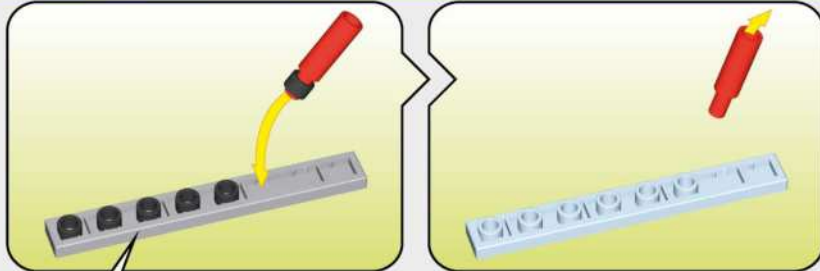

1:1



12



13

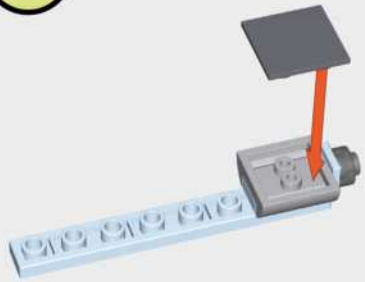

x1



x1



x1

14

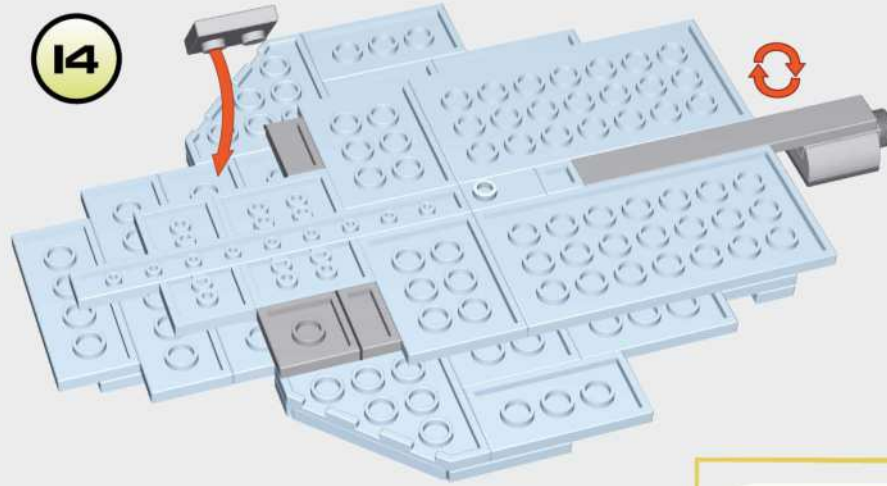

x2



x2

15

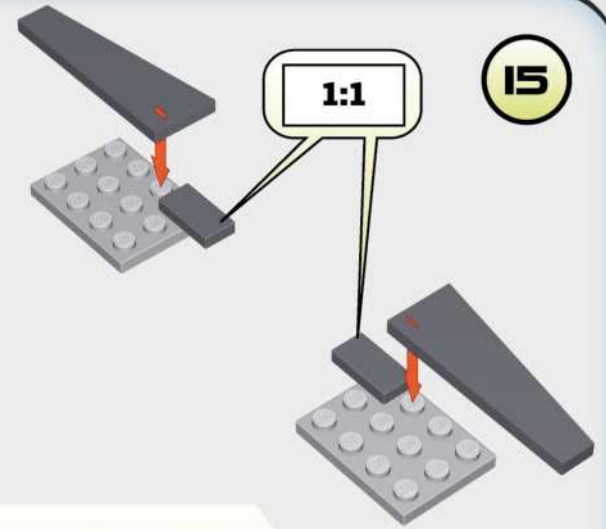

x2



x1



x1



x2

16

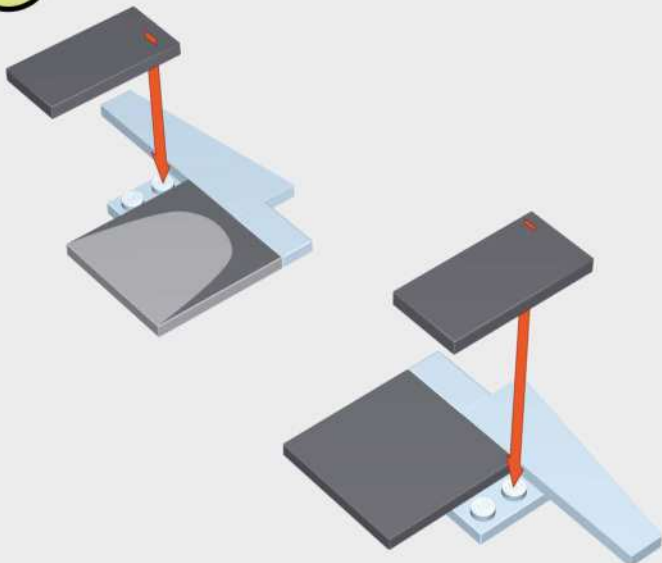

x2

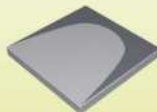

x1



x1

17

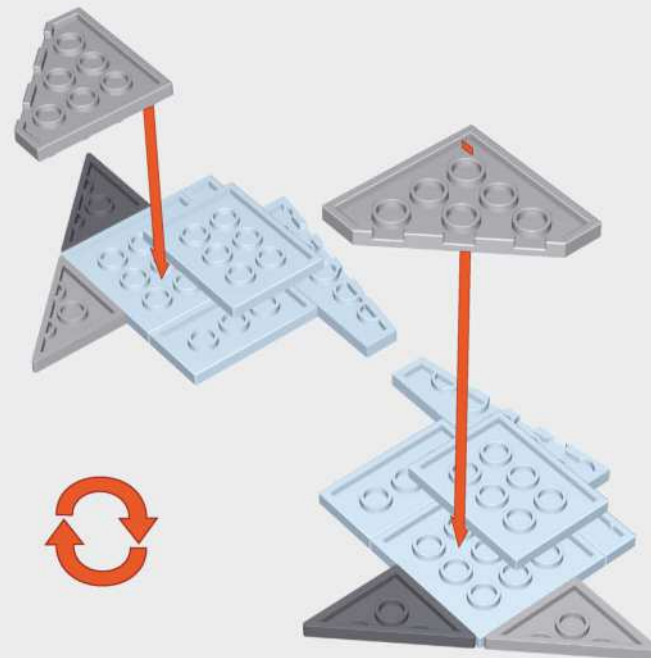

x2



x2



x2

18

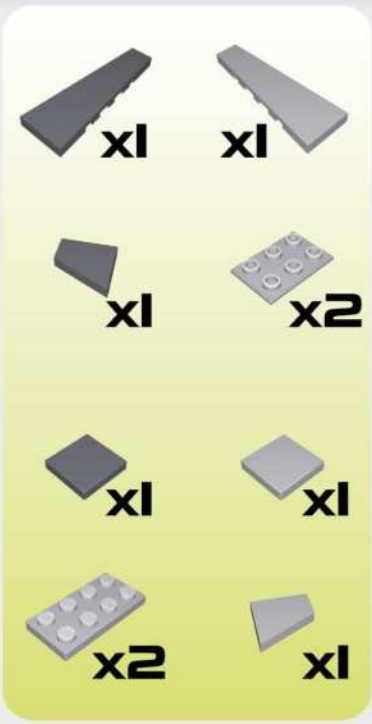
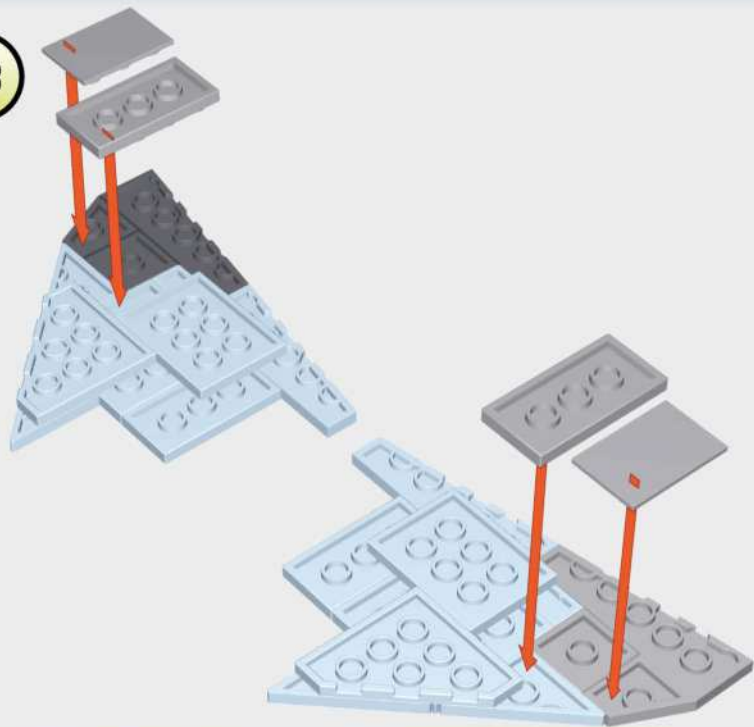

20

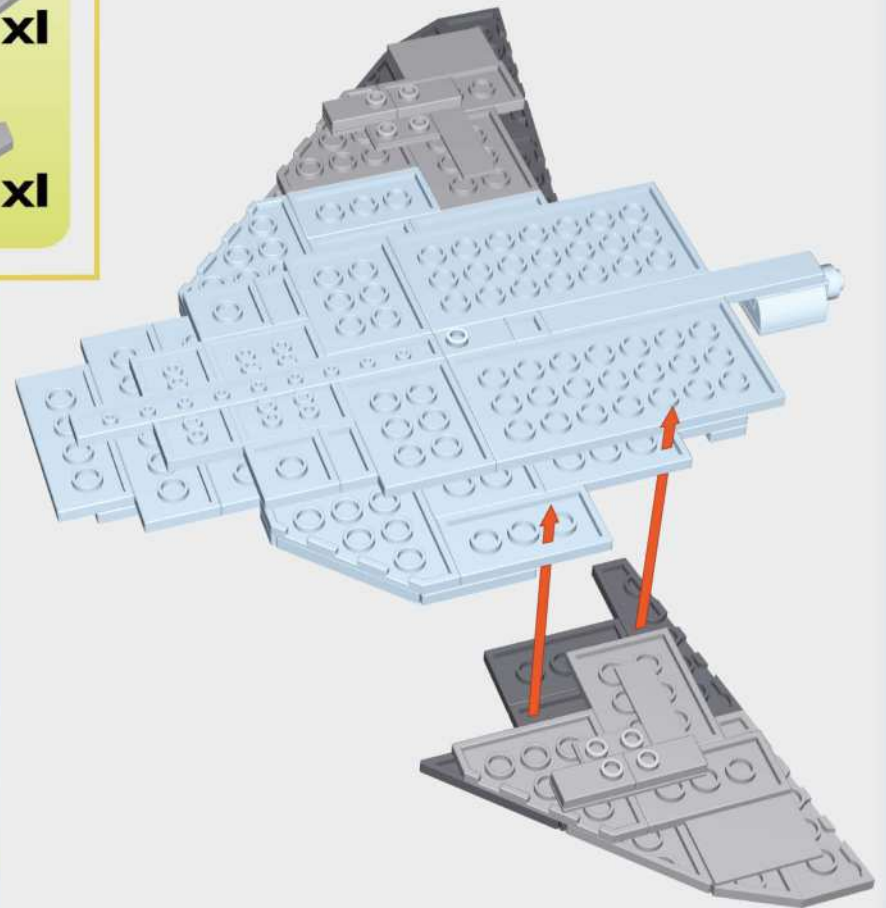

19

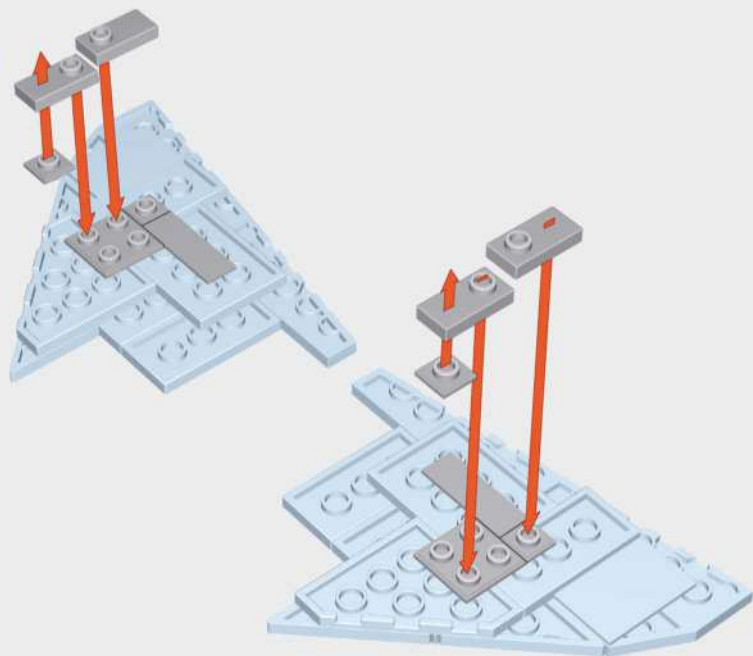

21

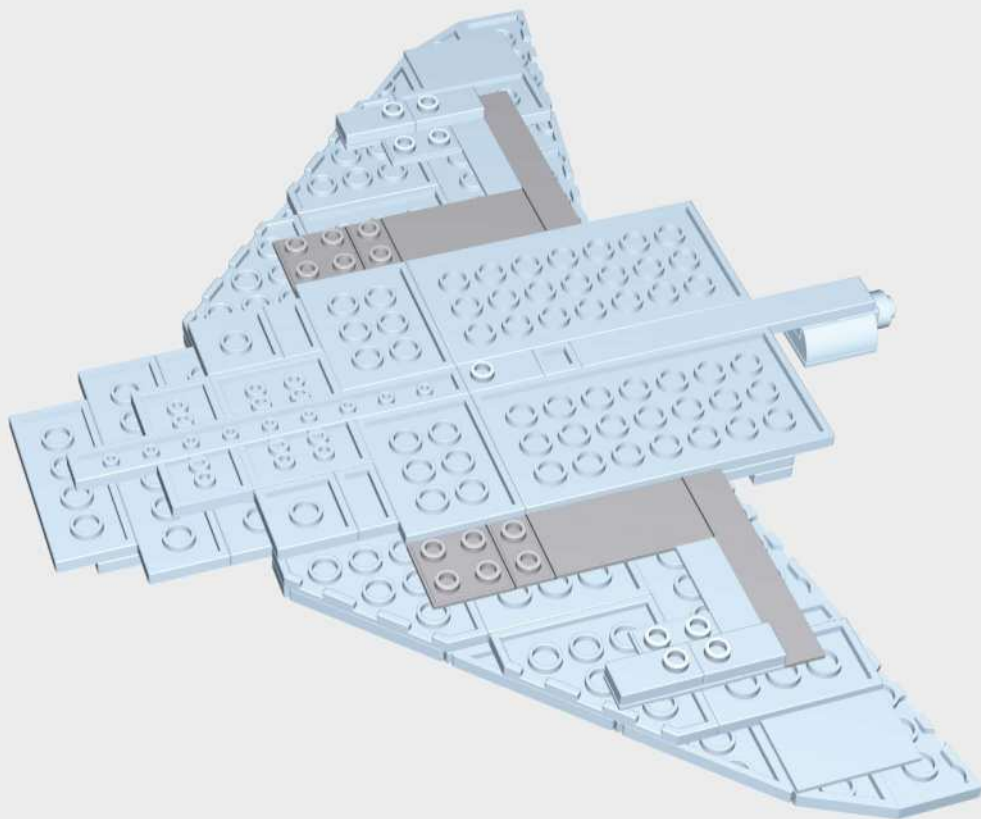

x2



x2



x2



x2

22

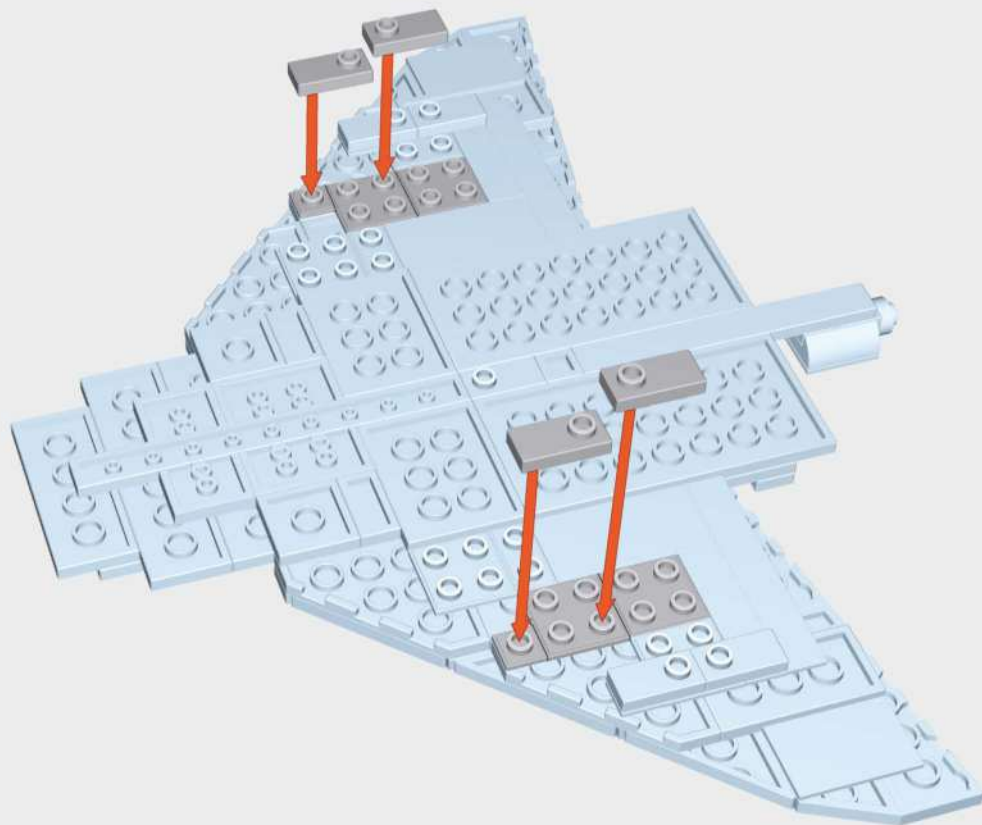

x4



x2



x4



23

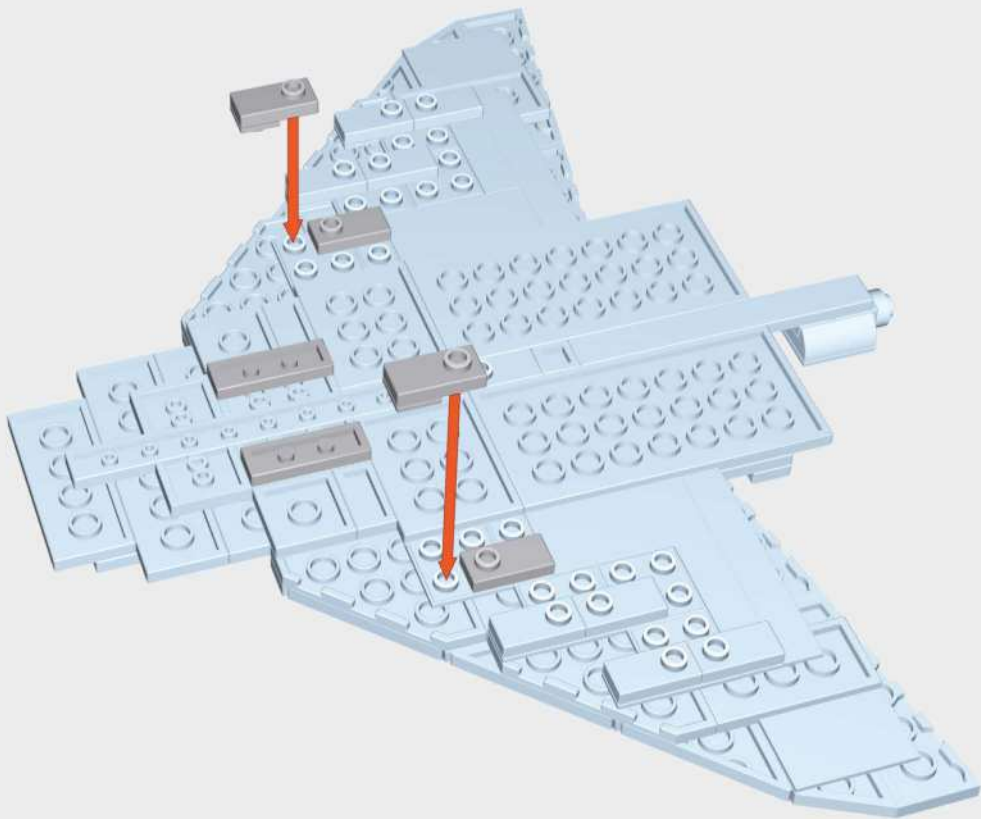

x2



x4



x2

24

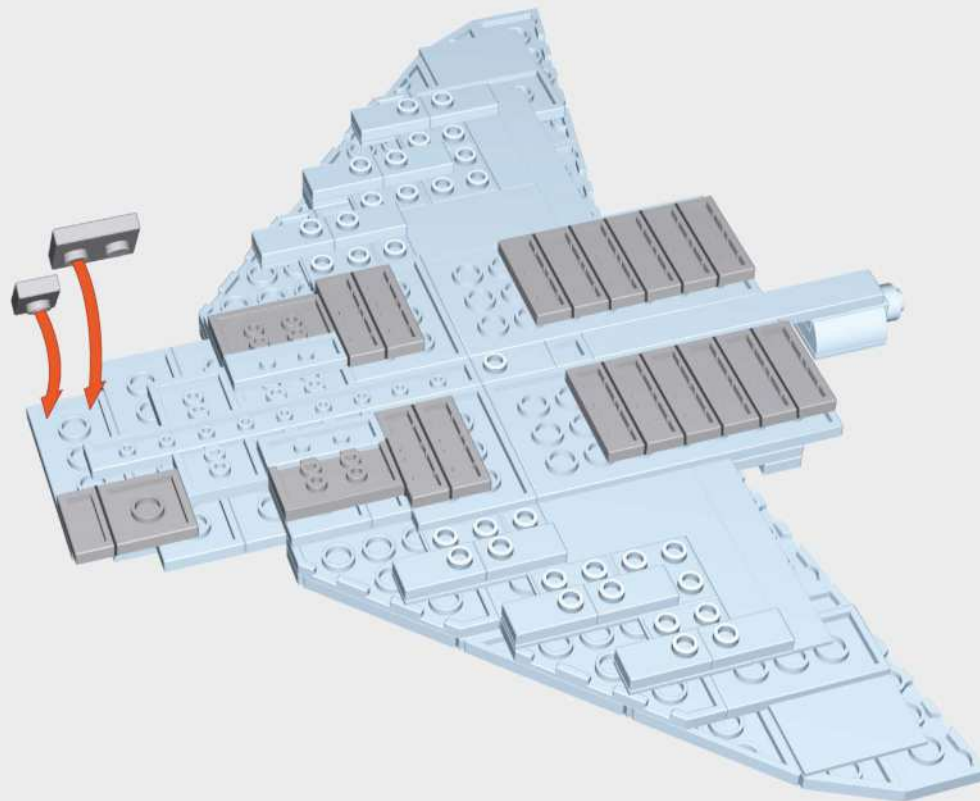

x2



x2



x2



x16

25

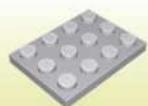
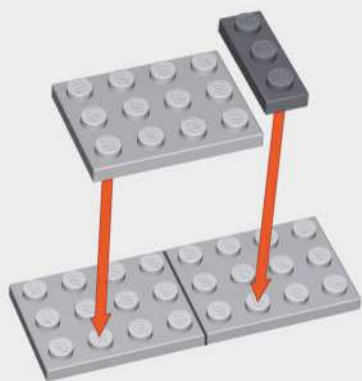

x3



x1

26

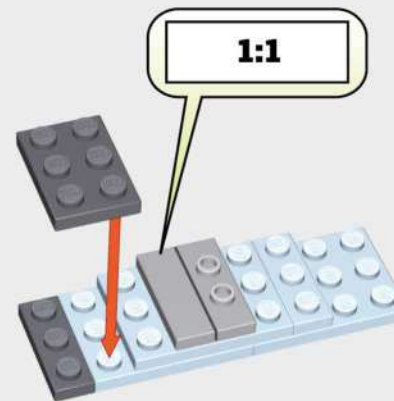

x1



x1



x1



x1

27

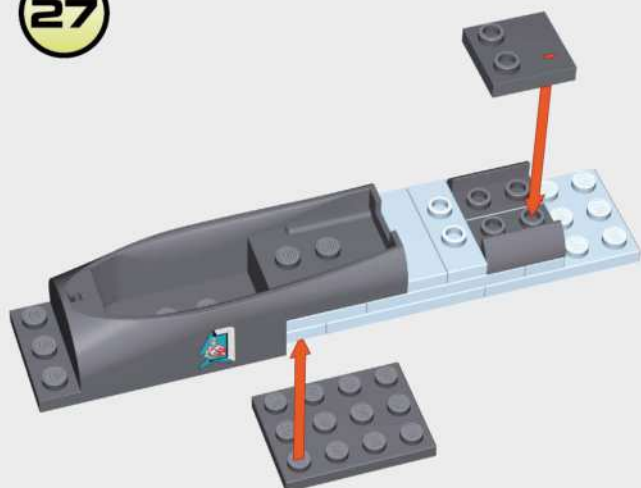

x1



x1



x2



x1

28

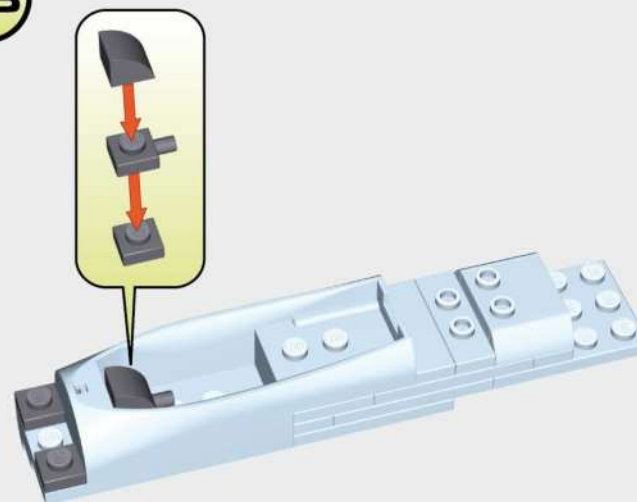

x3

x1

x1

29

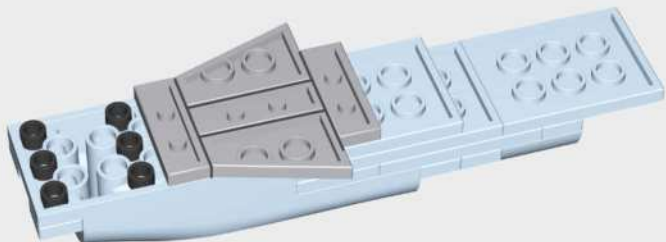
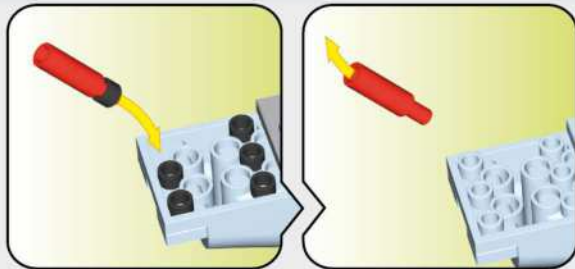

x6

x3

x1

x1

30

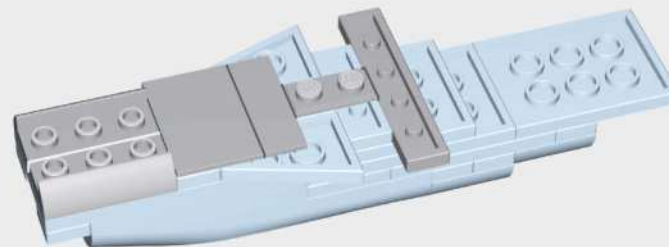

x2

x1

x1

x1

x1

31

1:1

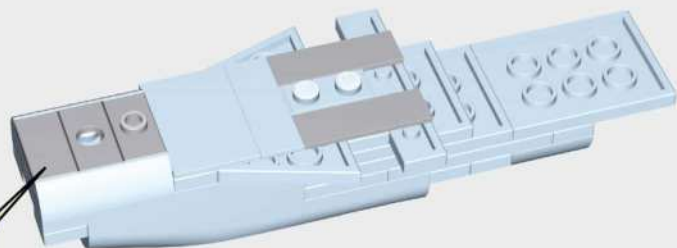

x1

x1

x1

x2

32

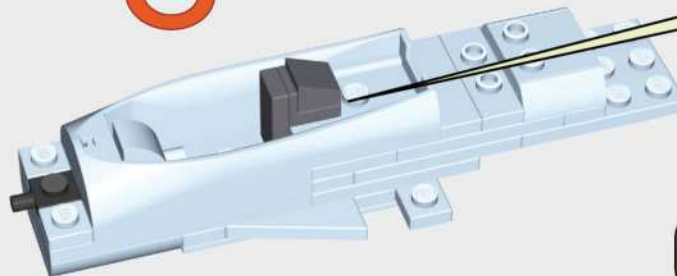

1:1

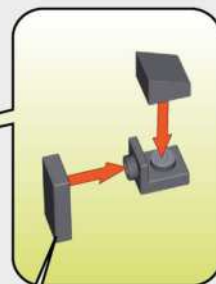

x1

x1

x1

x1

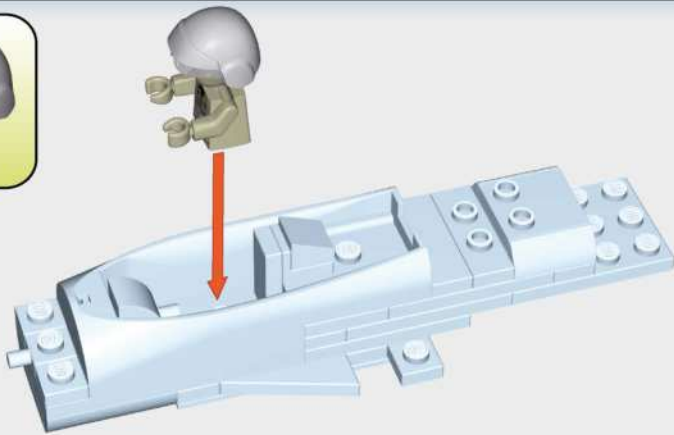

33

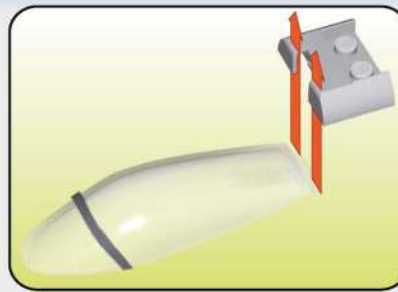

34



35

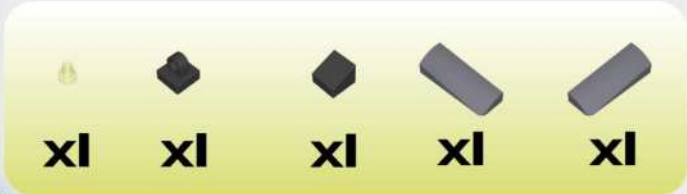
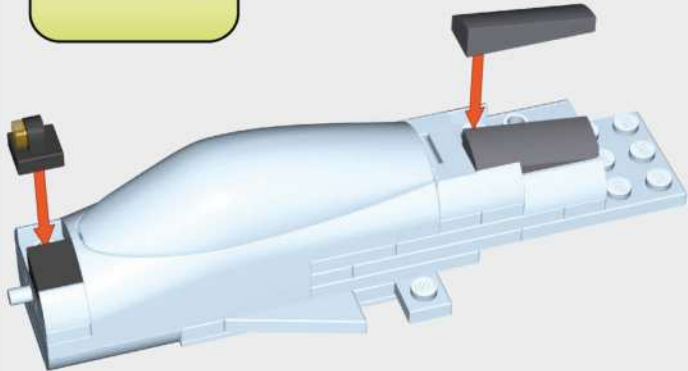

36

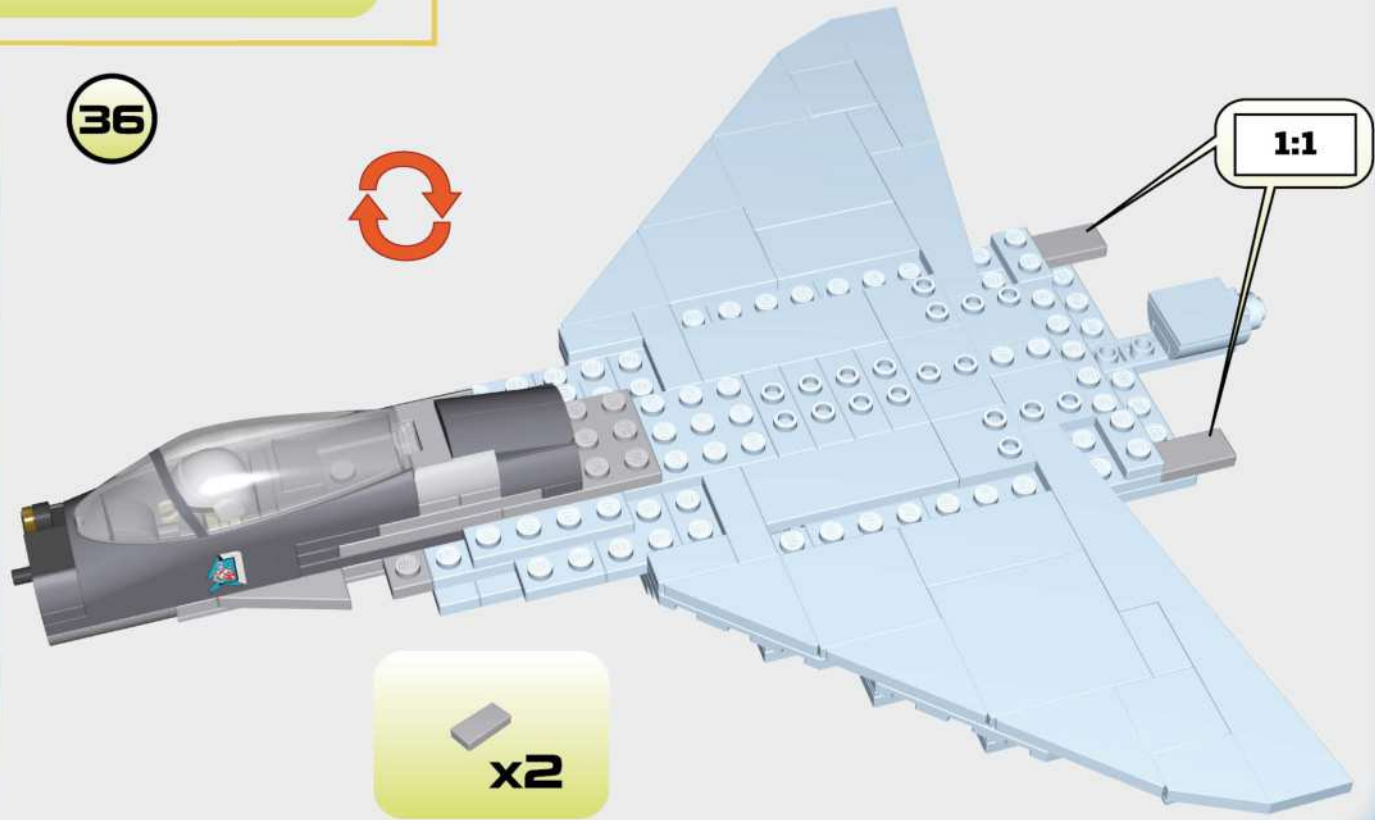

37

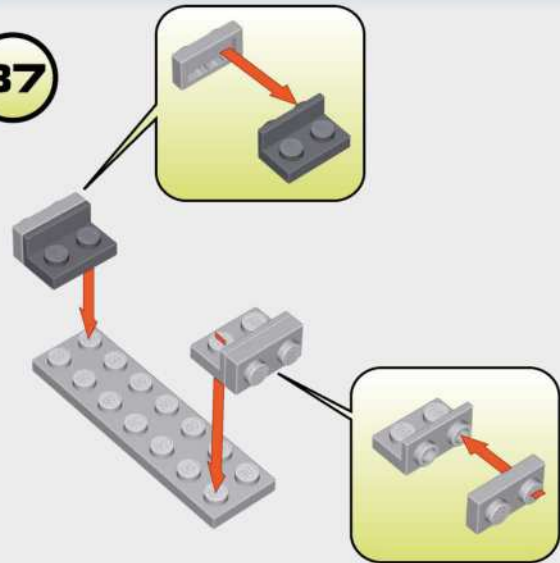

38

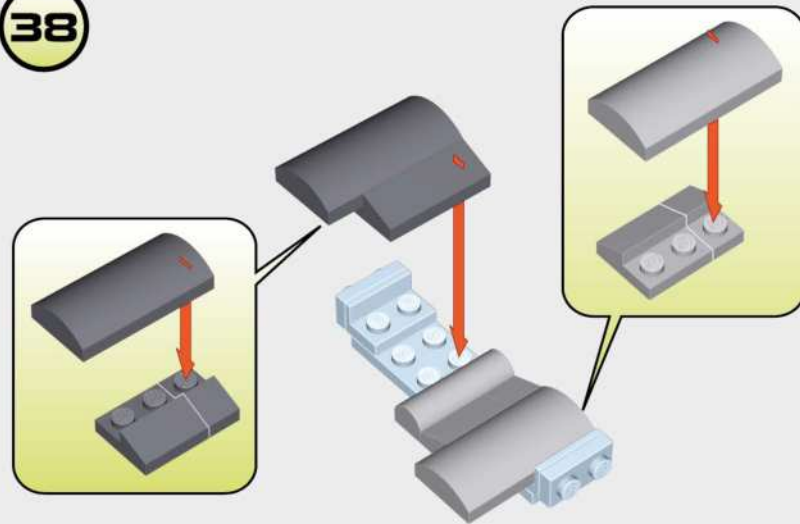

39



40

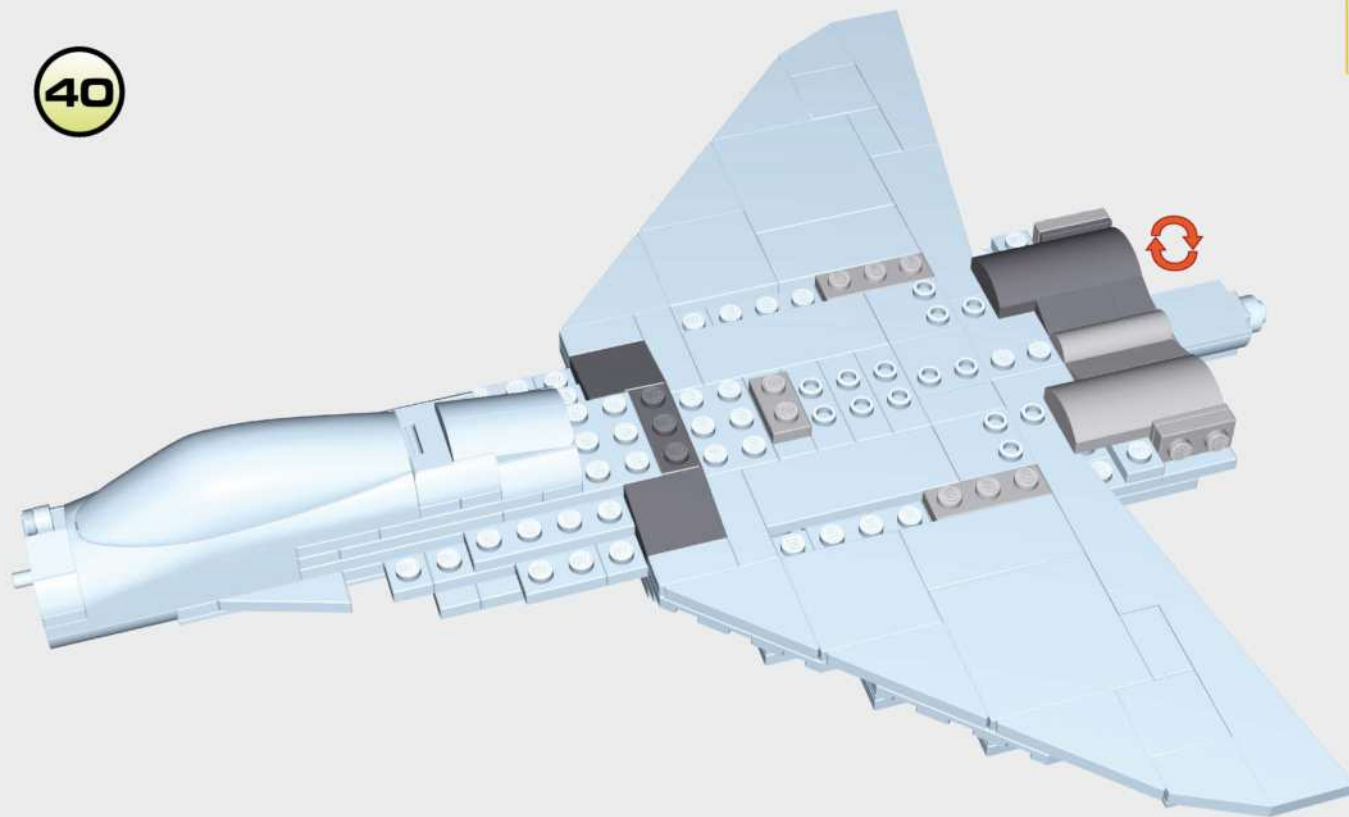

41

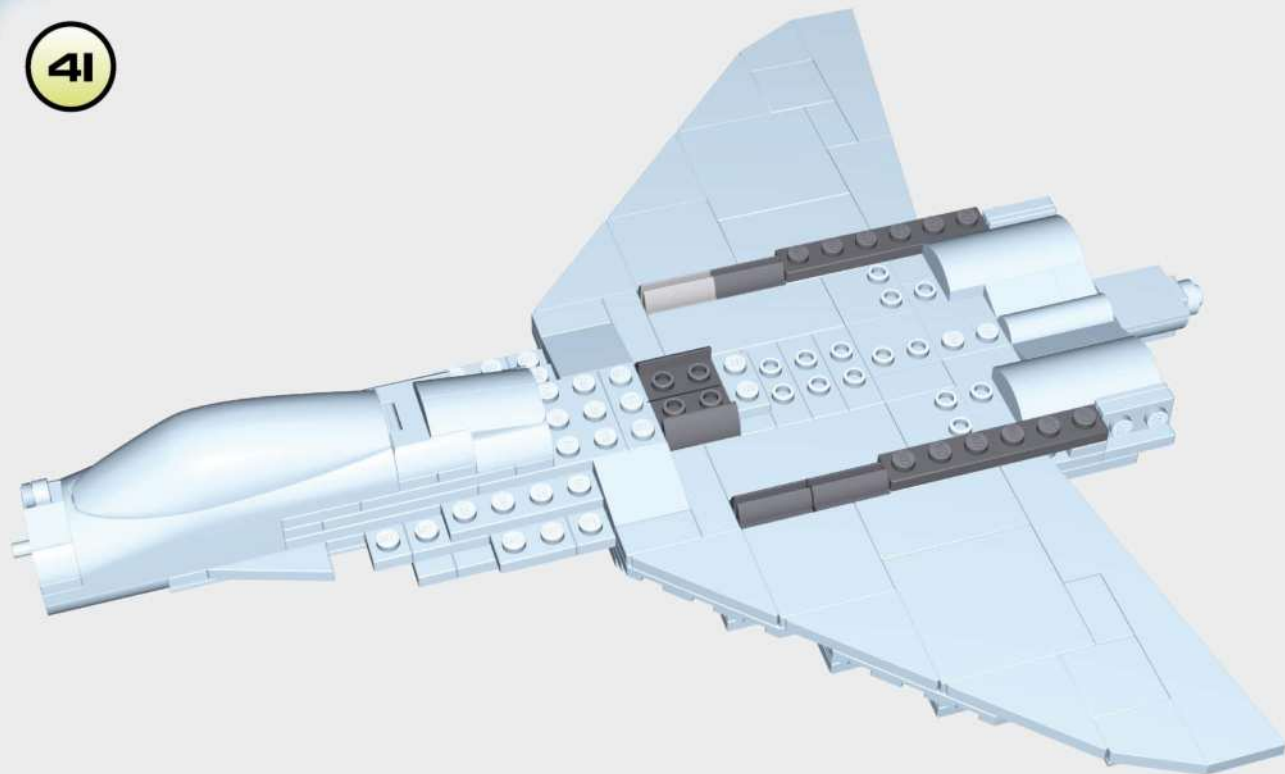

x2



x3



x1



x2

42

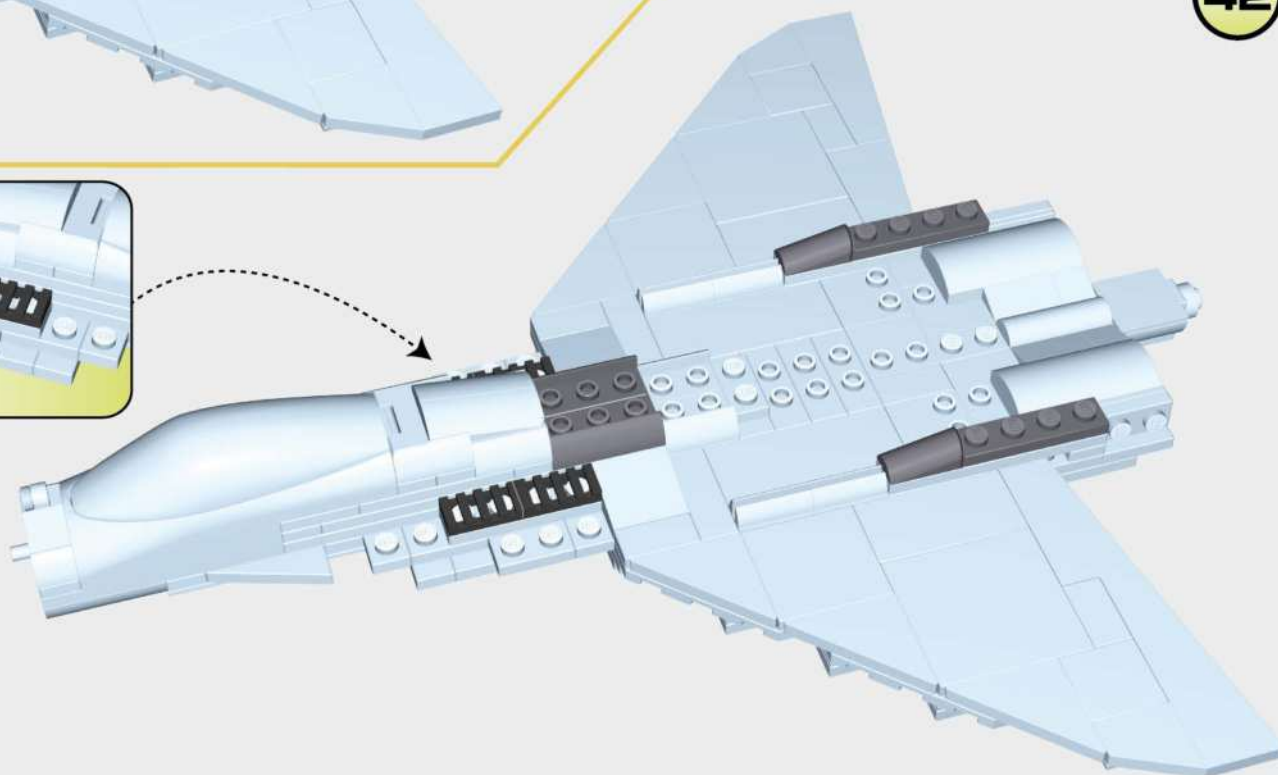

x4



x2



x2



x2

43

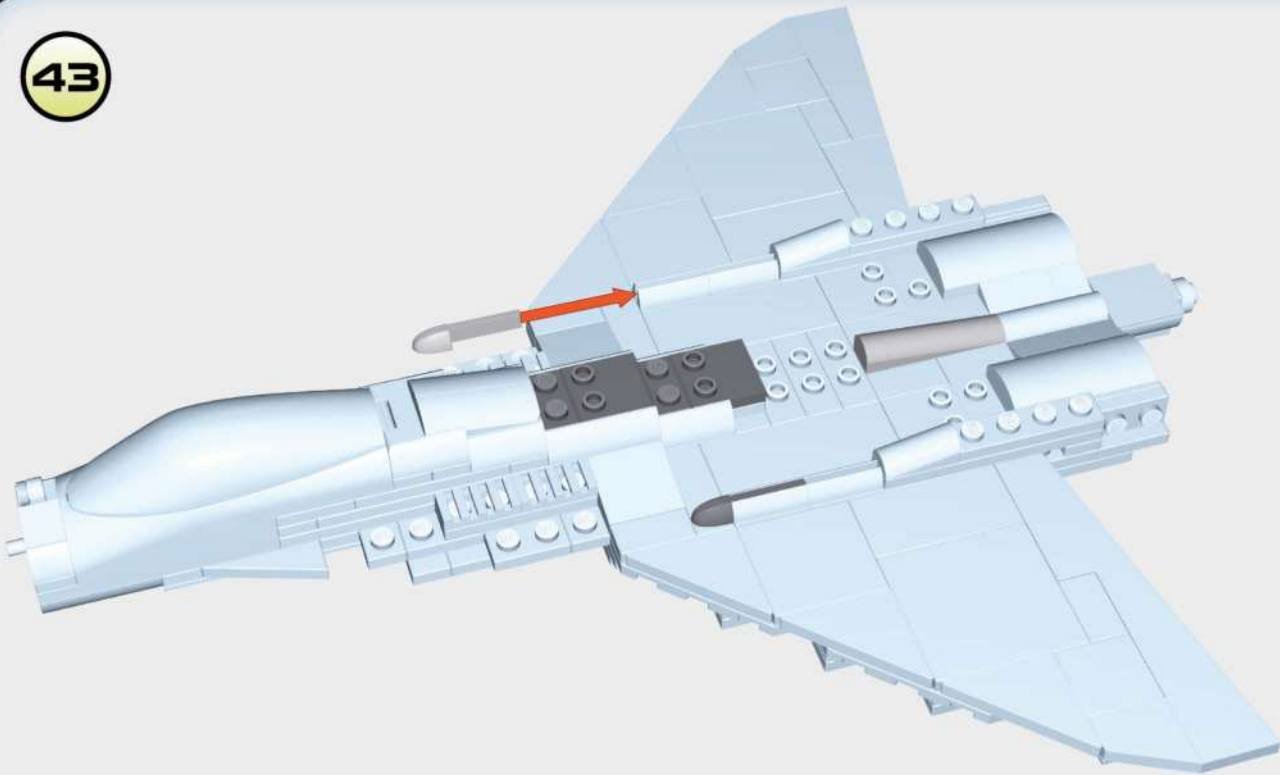

Parts list for step 43:

- Dark grey 1x2 Technic brick with holes: x2
- Dark grey 1x2 Technic brick with holes: x2
- White 1x2 Technic axle pin: x1
- White 1x2 Technic axle pin: x1
- White 1x2 Technic axle pin: x1

44

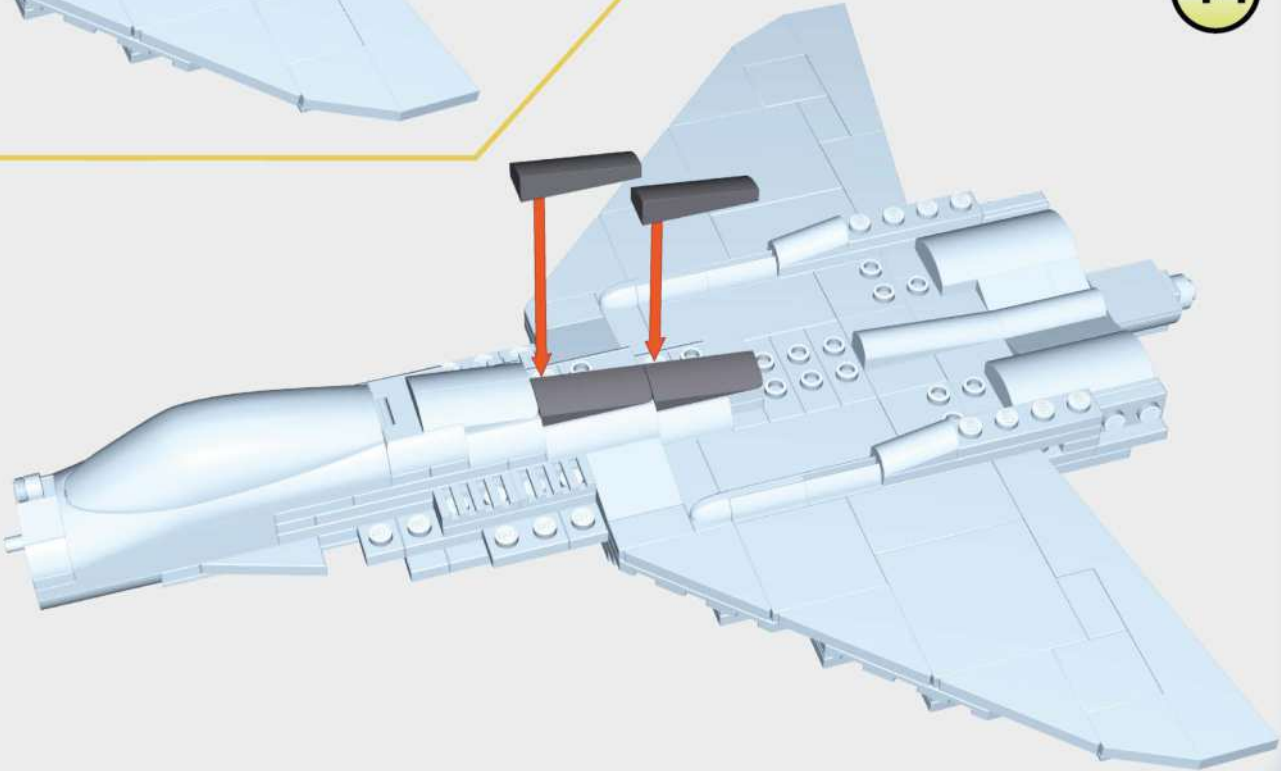

Parts list for step 44:

- Dark grey 1x2 Technic brick with holes: x2
- Dark grey 1x2 Technic brick with holes: x2

45

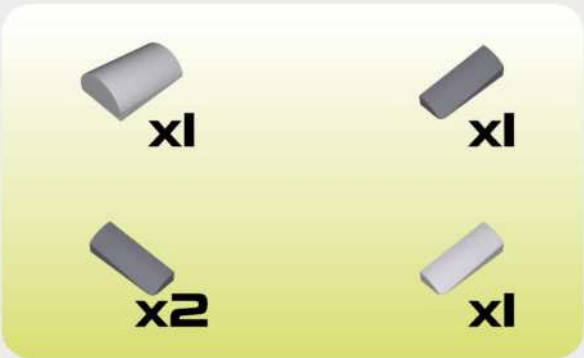
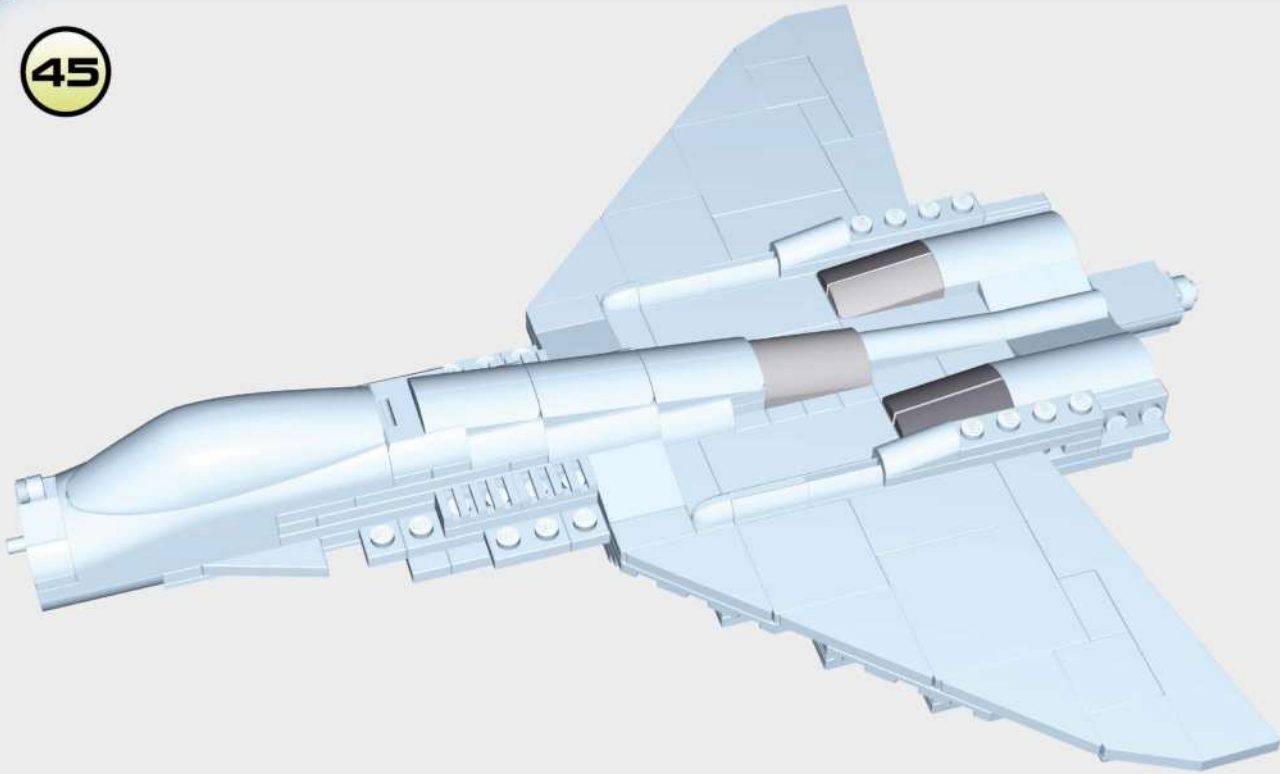

46

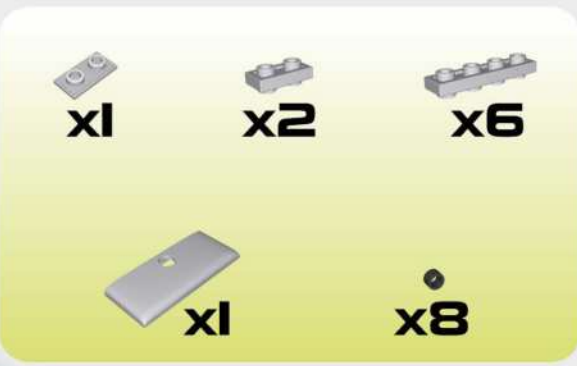
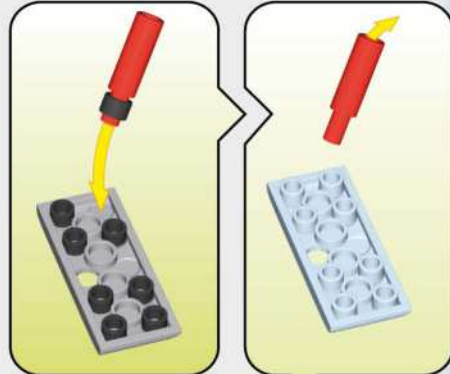



47

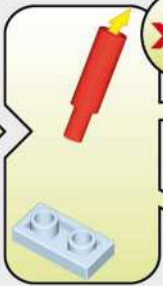

x2

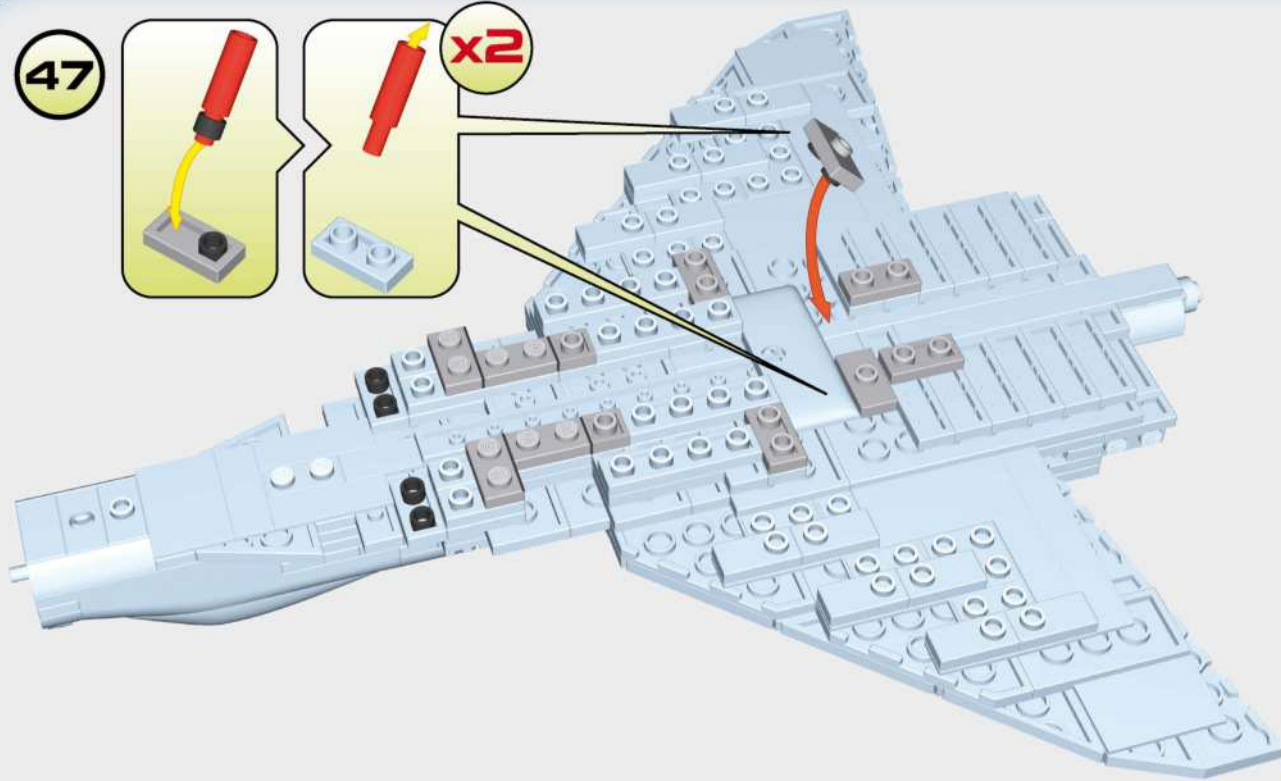

x4



x2



x4



x2



x8

48

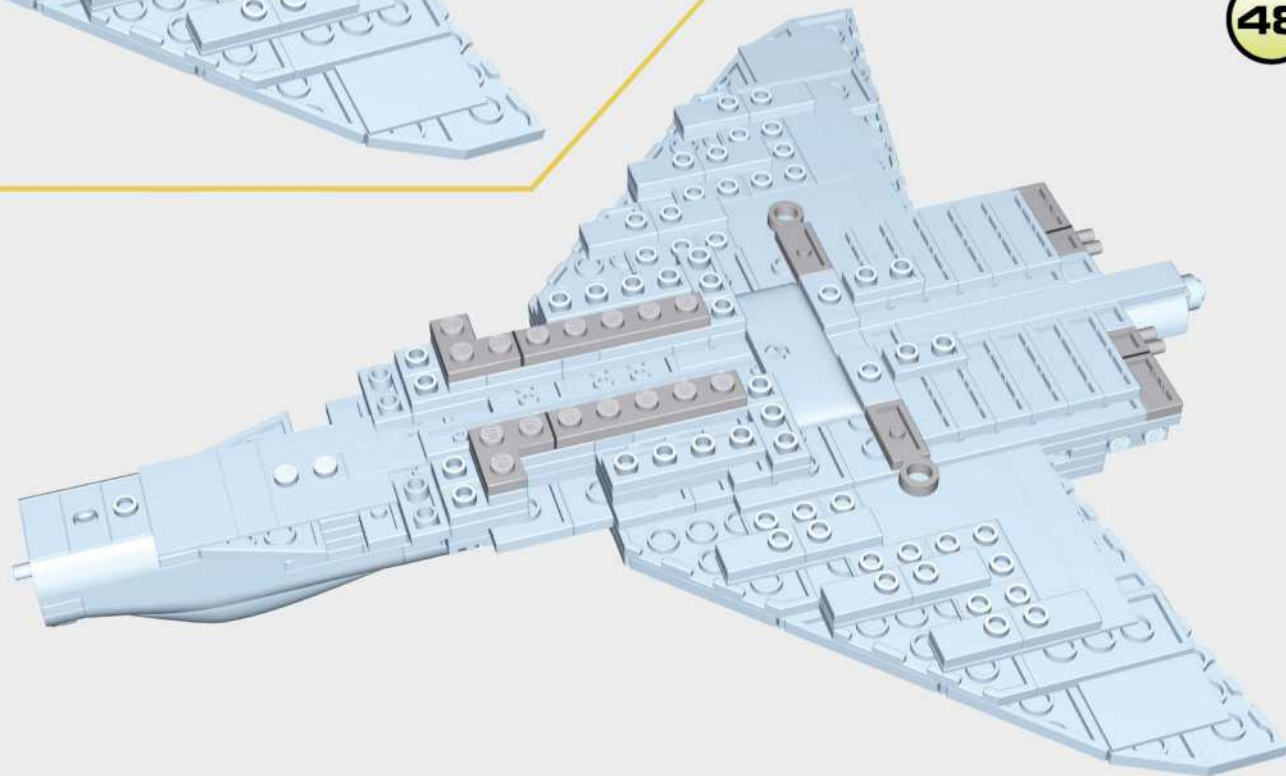

x2



x2



x2



x2



x2



2

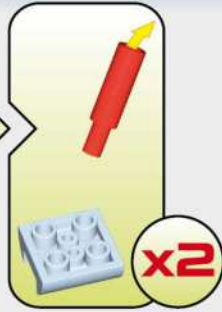
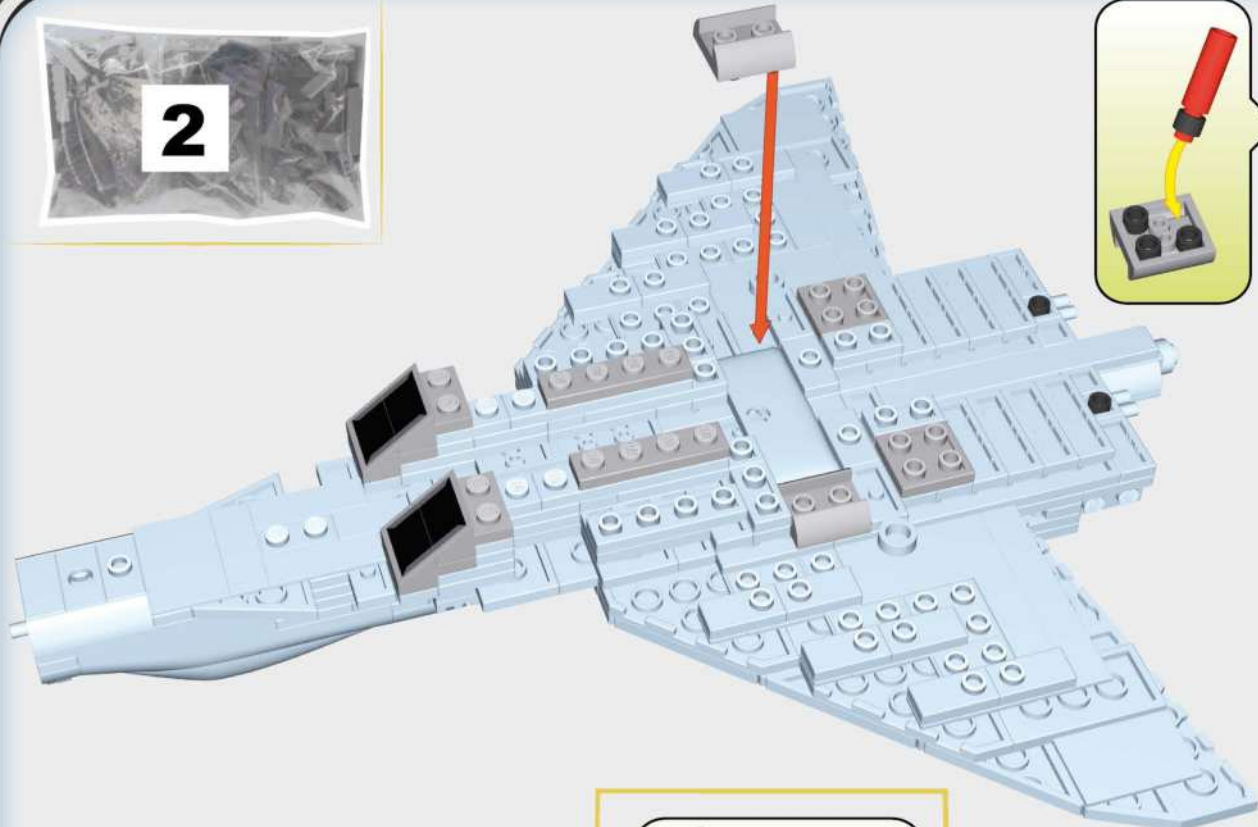

x2

49

- x2
- x2
- x2
- x2
- x10

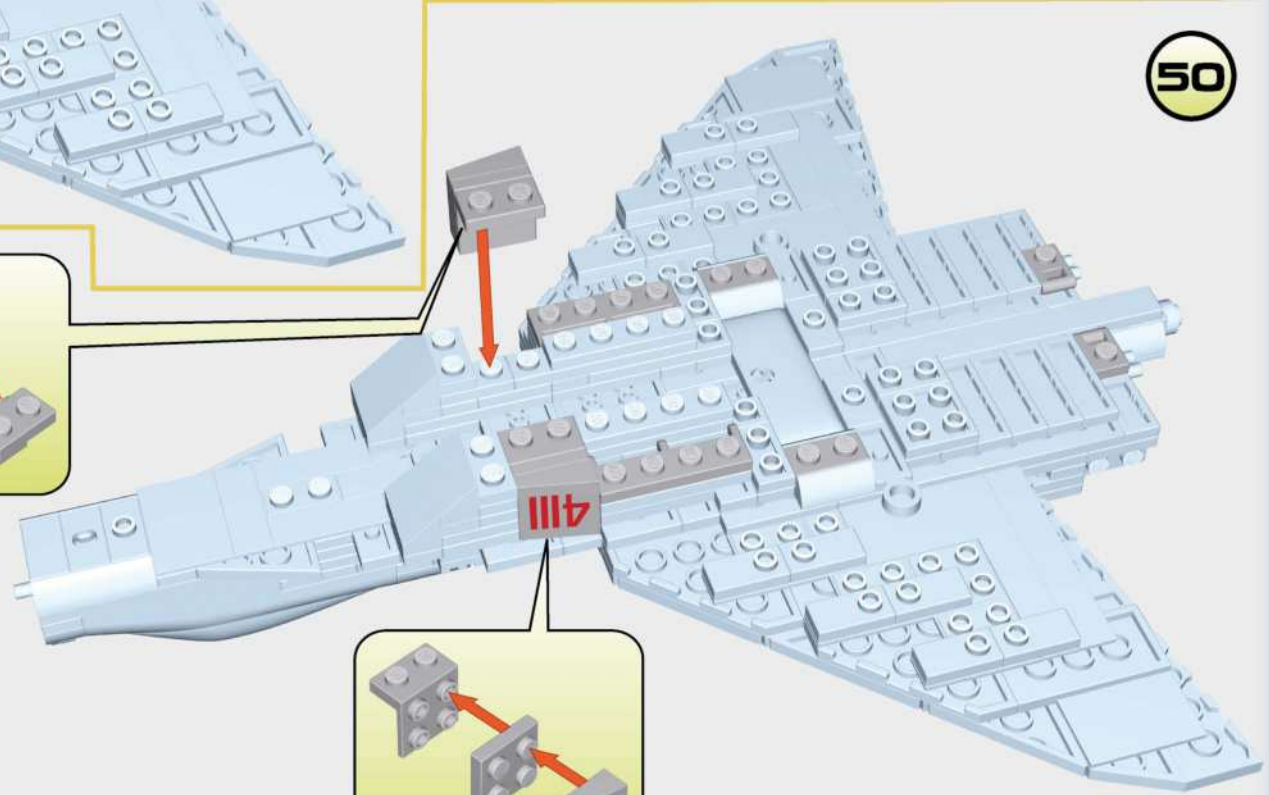
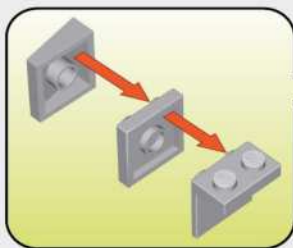

50

- x2
- x2
- x1
- x1
- x2
- x2
- x2

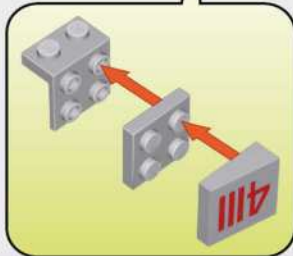

51

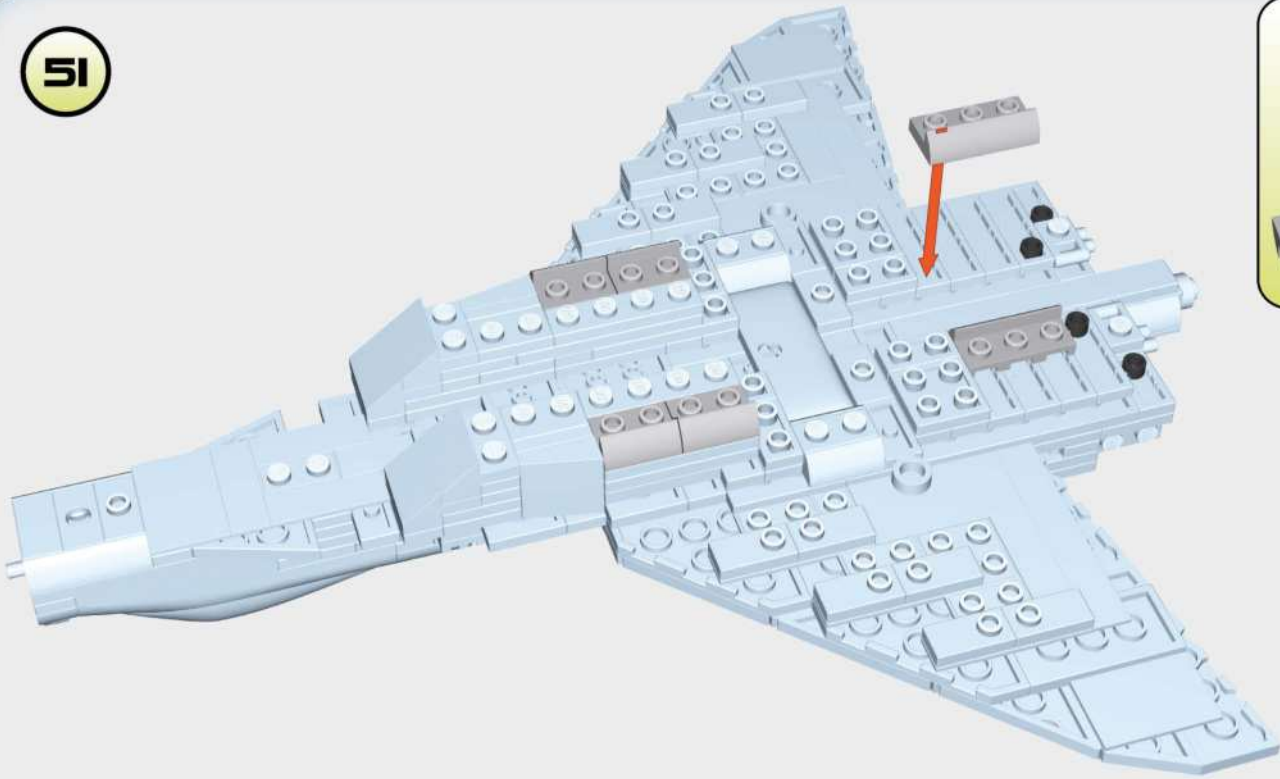

52

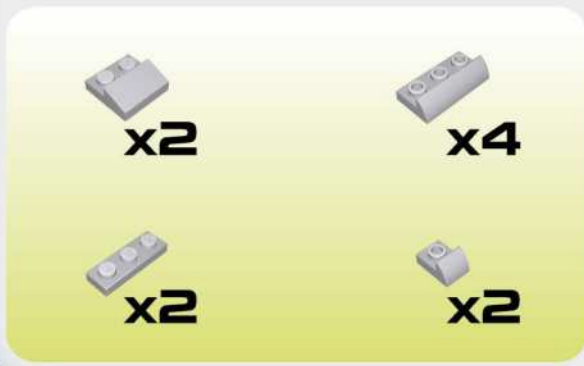
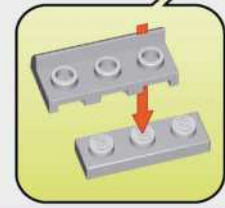
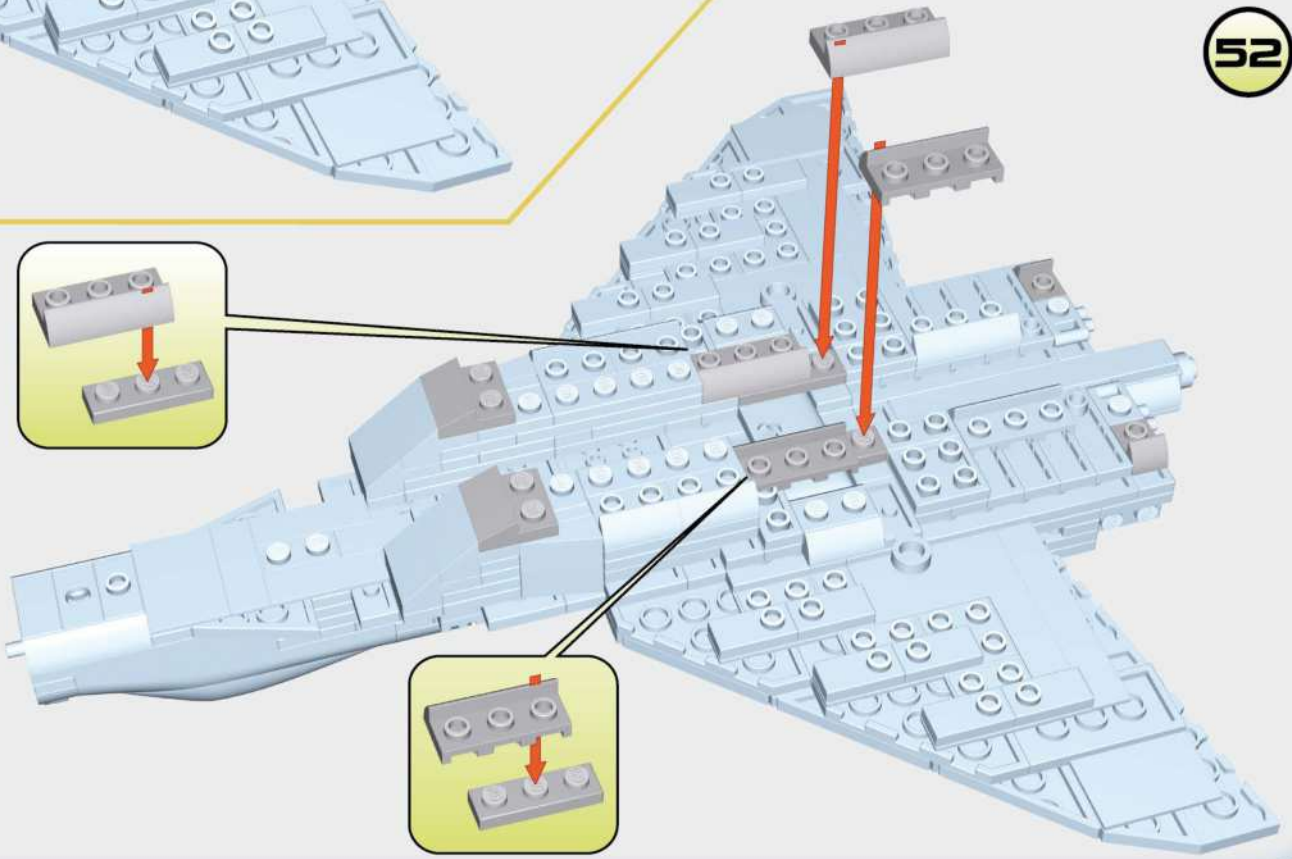

53

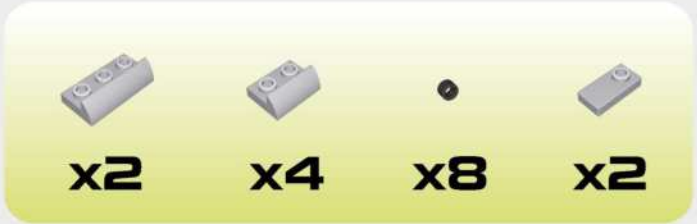
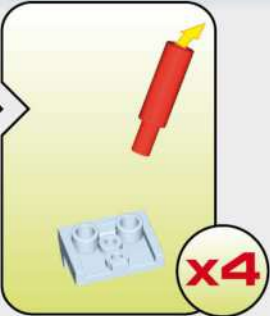
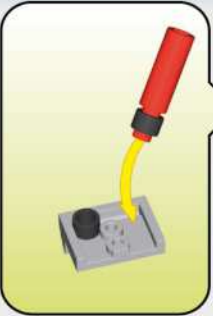
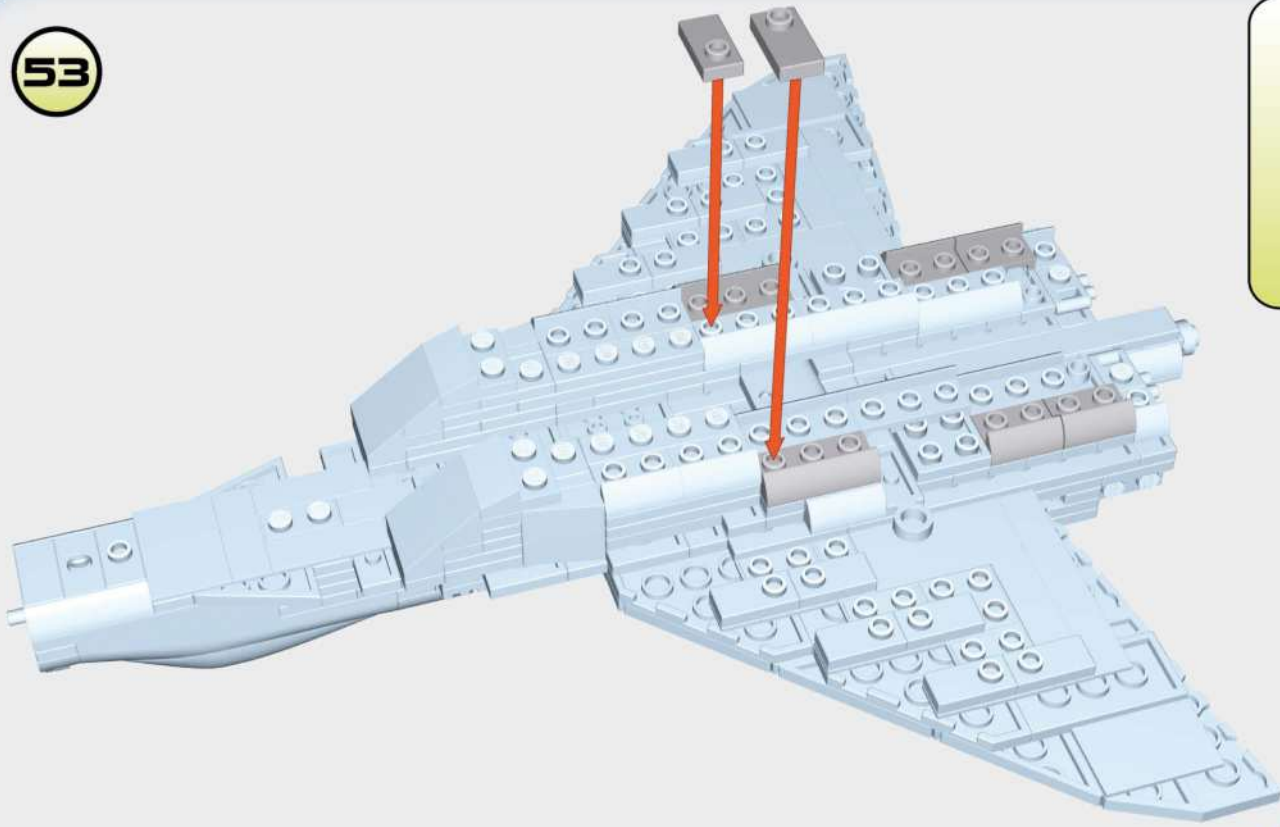

54

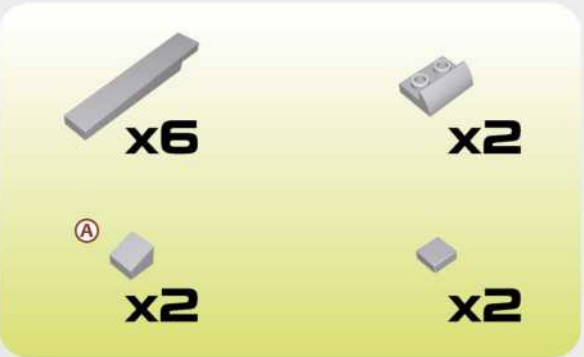
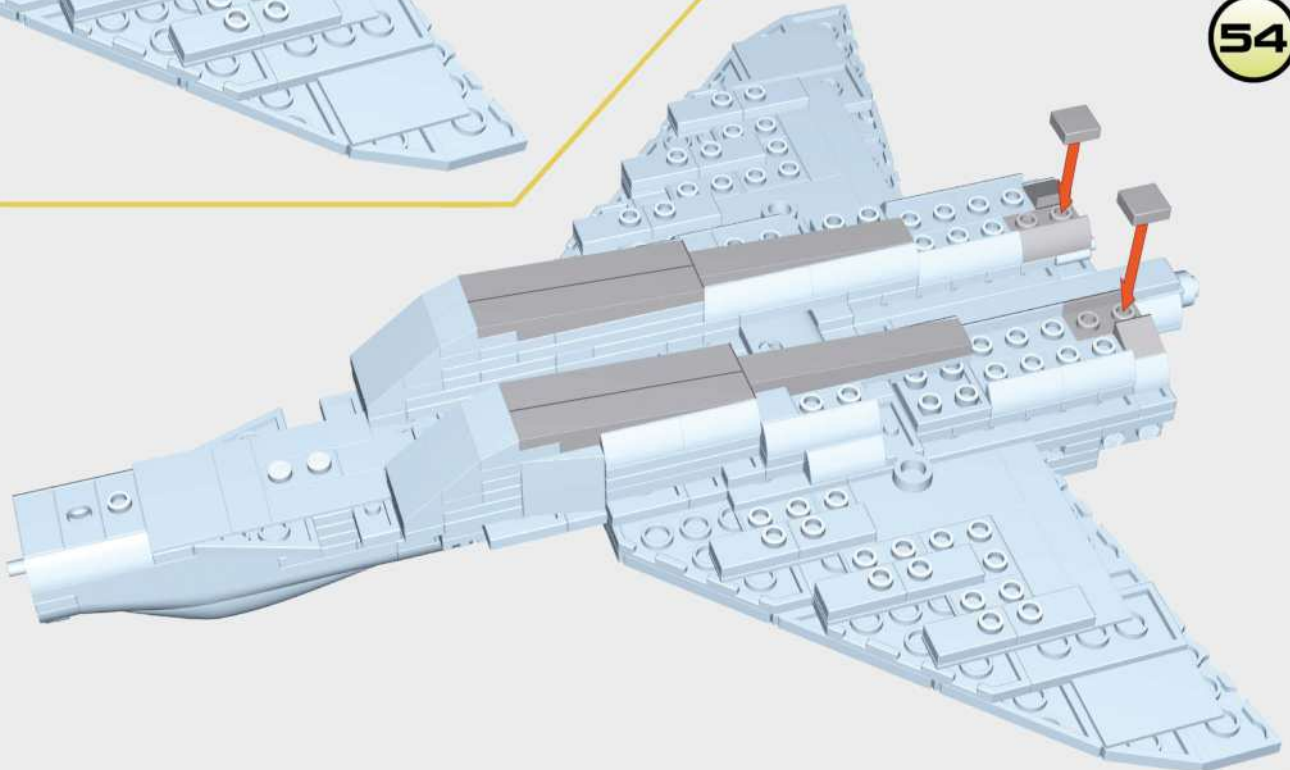

x6



55



x6



x6



x2

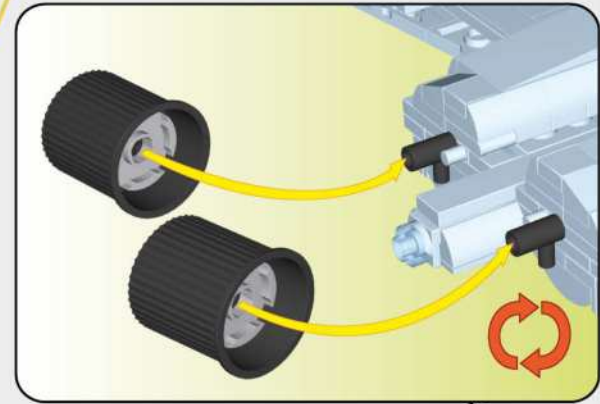
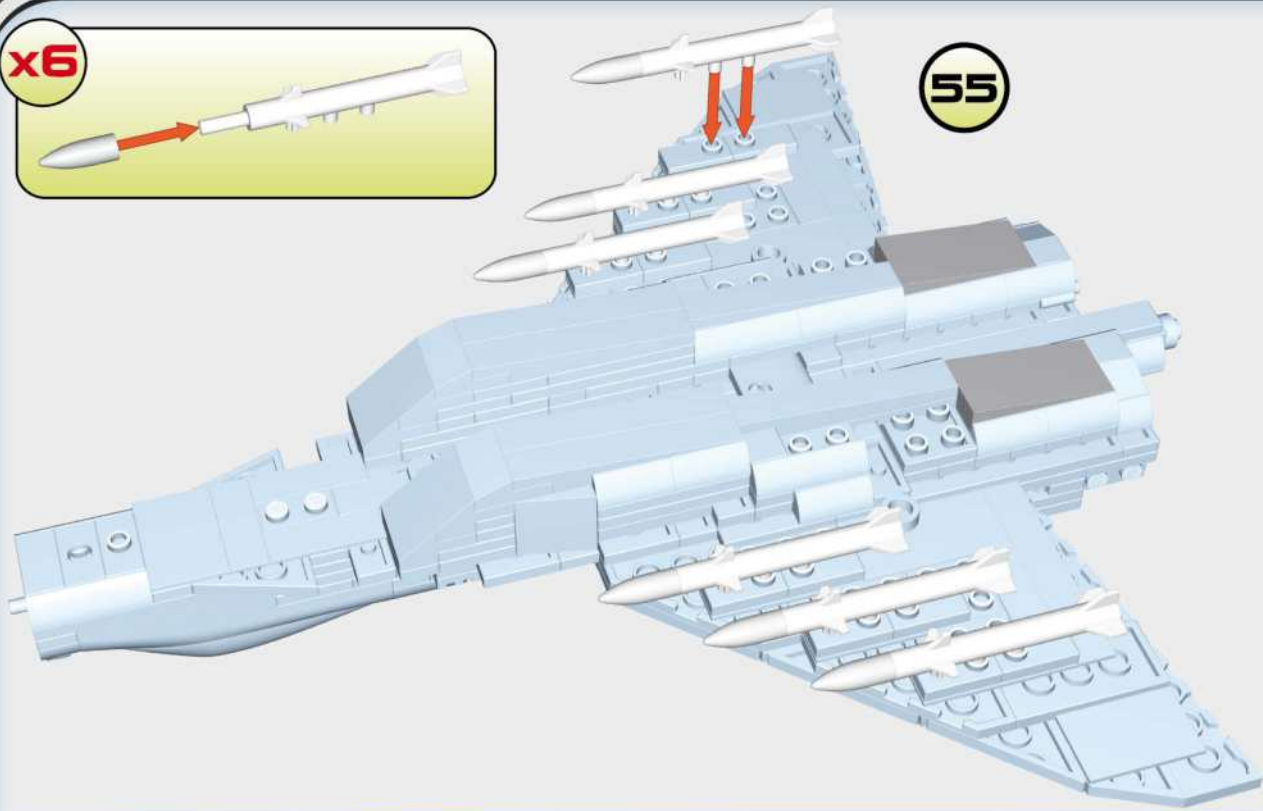

56



x1



x1



x2



x2



x2



x2

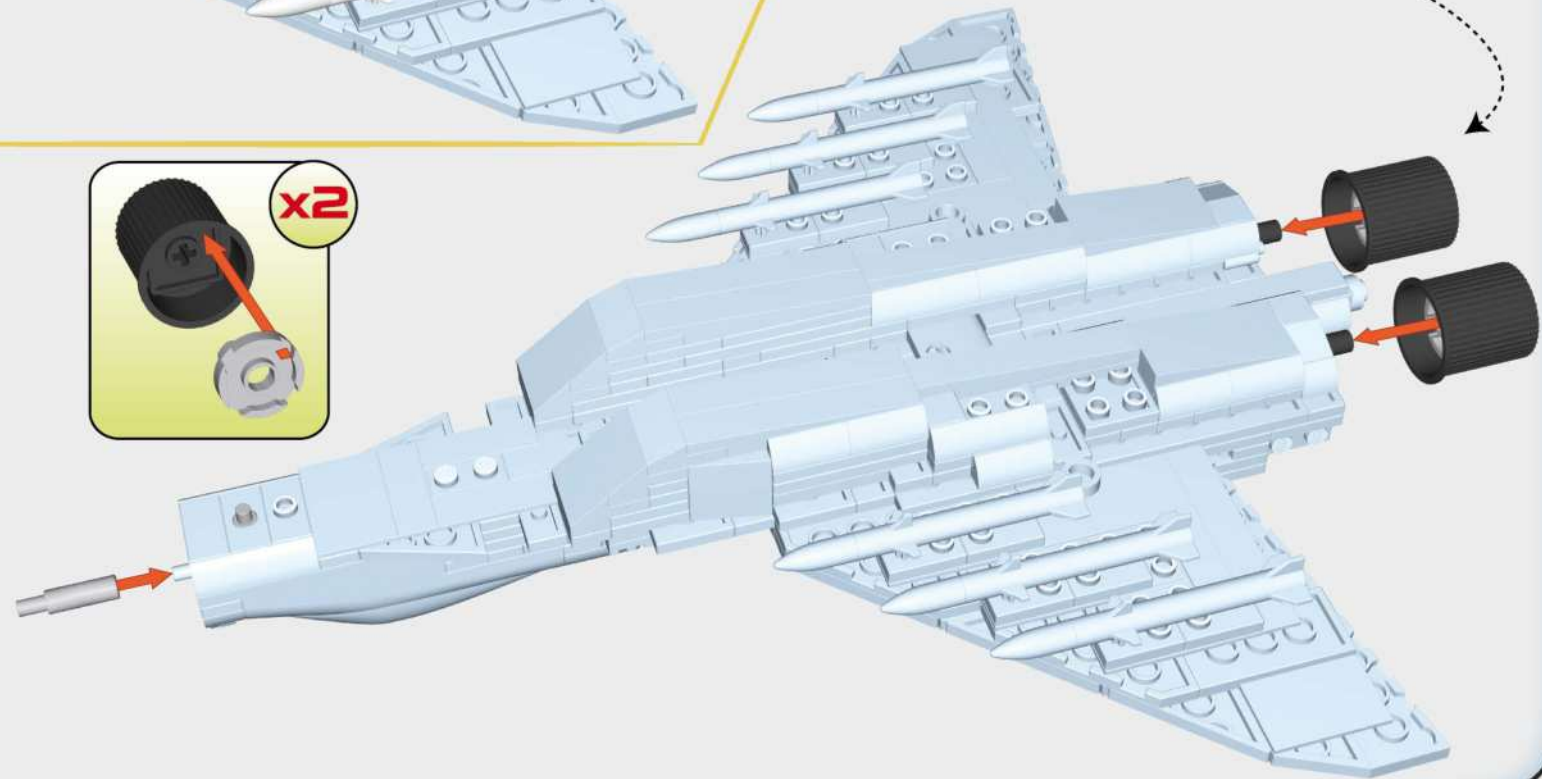

57

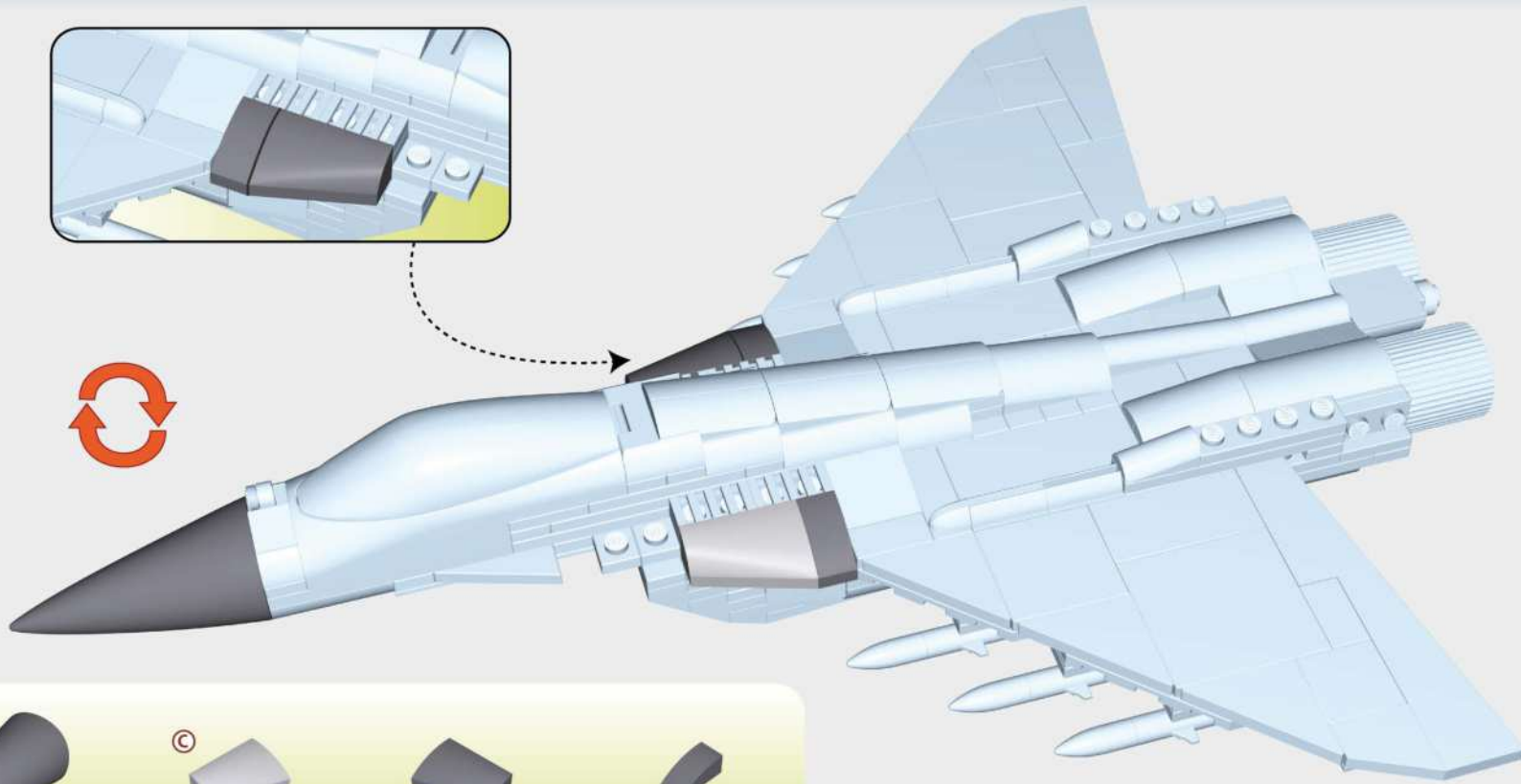
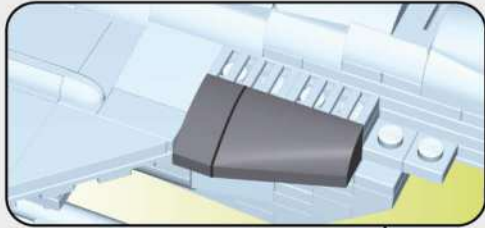

58

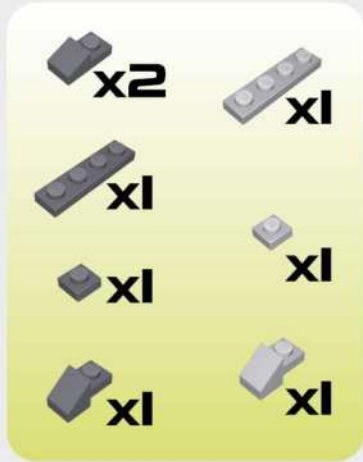
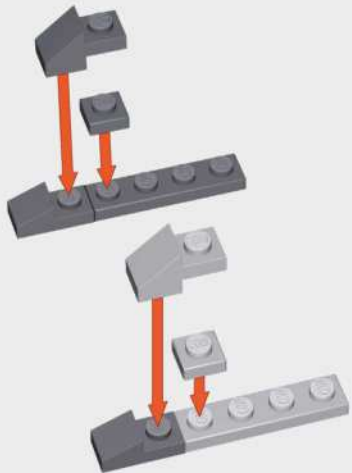

59

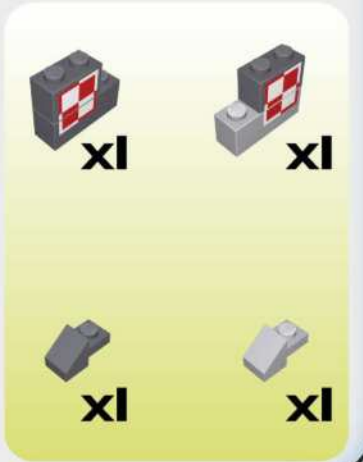
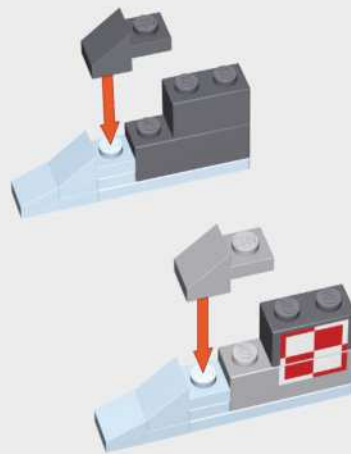

60

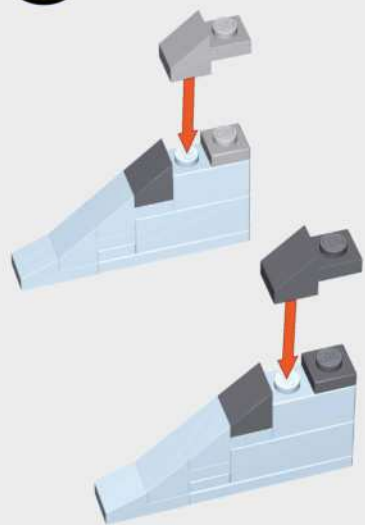

<sup>(B)</sup> x2

x1

x1

x1

x1

61

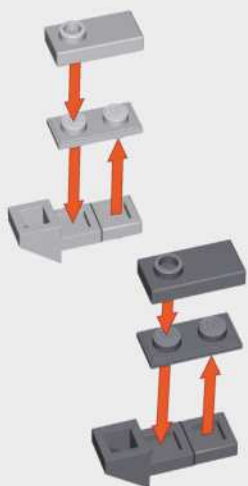

x1

x1

x1

x1

x1

x1

x1

x1

62

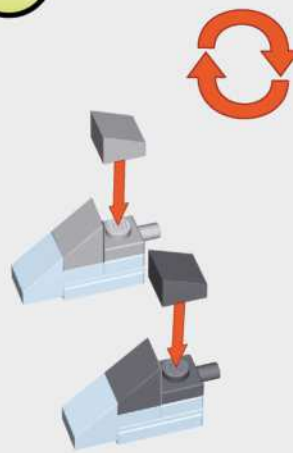

<sup>(B)</sup> x1

<sup>(A)</sup> x1

x1

<sup>(B)</sup> x1

<sup>(A)</sup> x1

x1

63

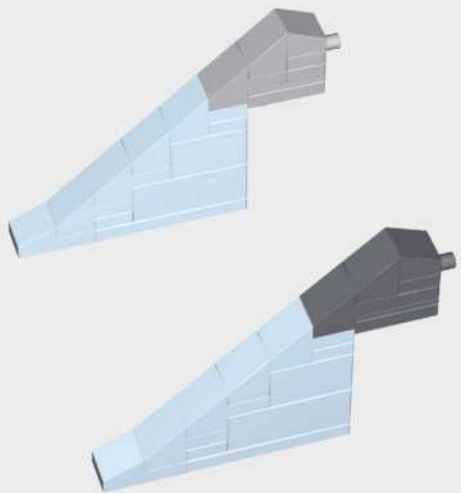

64

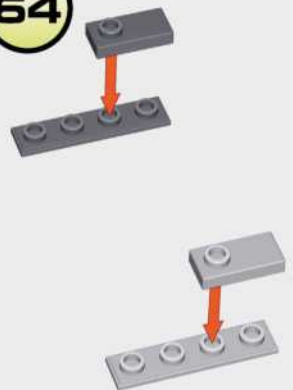

x1

x1

x1

x1

1:1

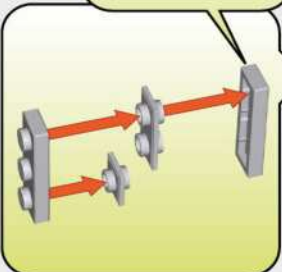

1:1

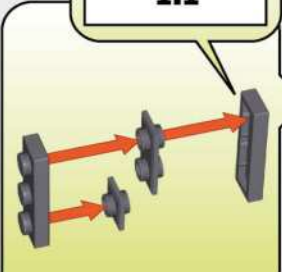

65

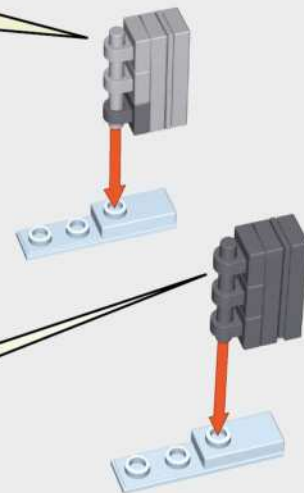

x1

x1

x1

x1

x1

x1

x1

x1

x2

x4

x1

x1

1:1

1:1

66

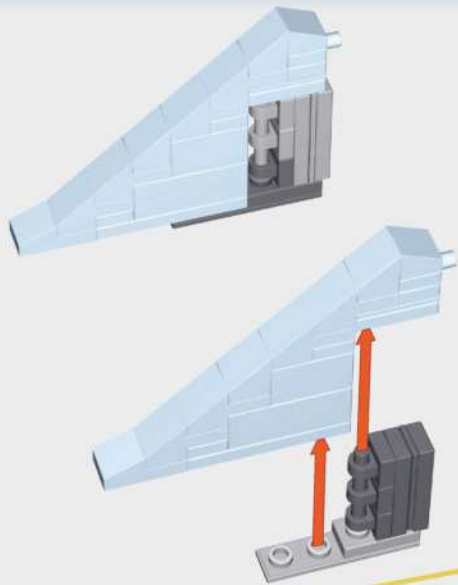

67

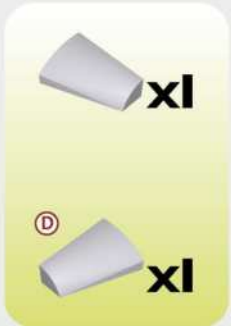
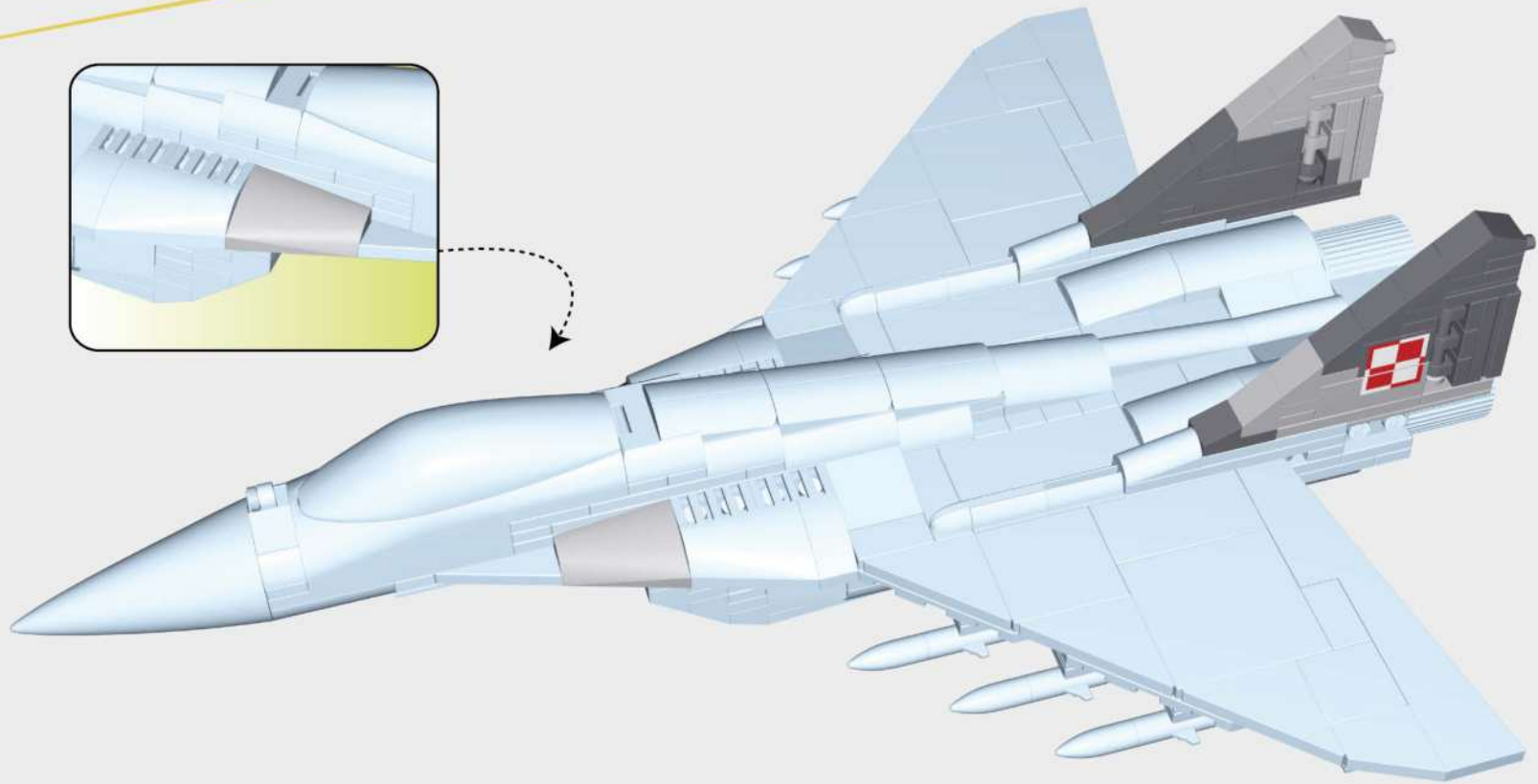
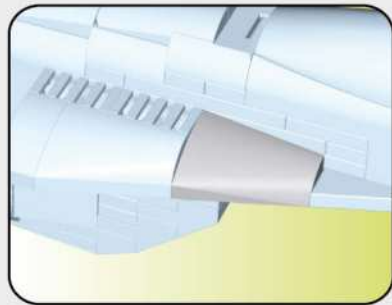



68

1:1

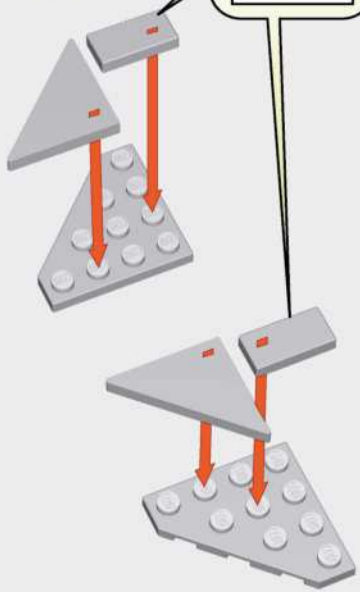

- x2
- x2
- x2

69

1:1

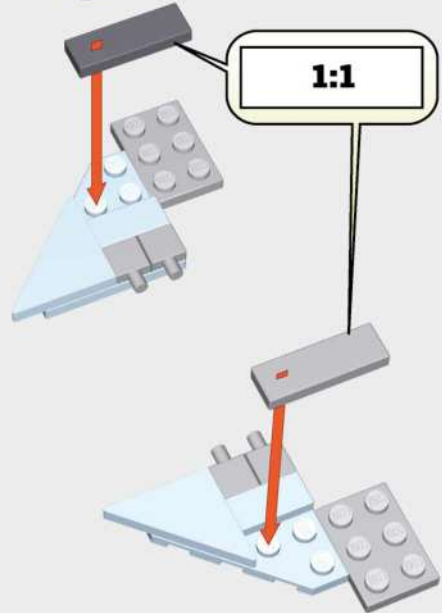

- x2
- x1
- x1
- x4

70

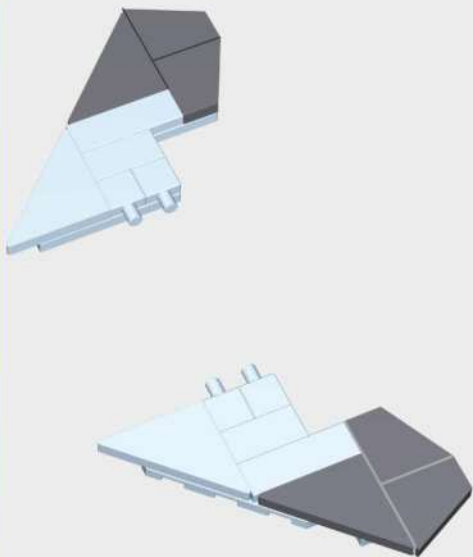

- x2
- x2
- x2

71

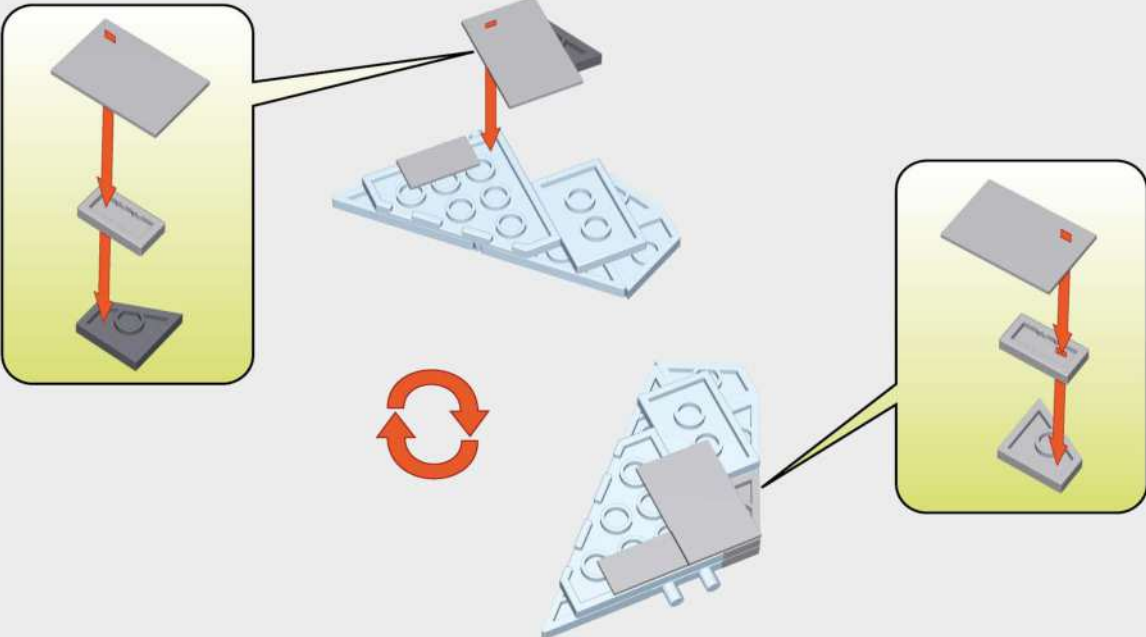

- x1
- x2
- x2
- x1
- x2

72

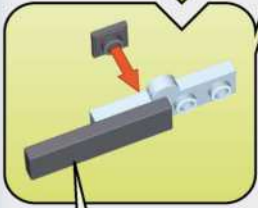
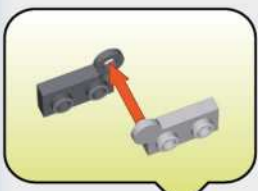

1:1

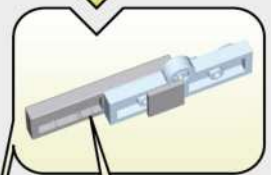
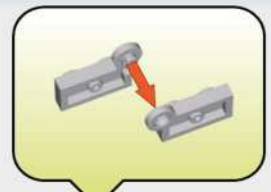
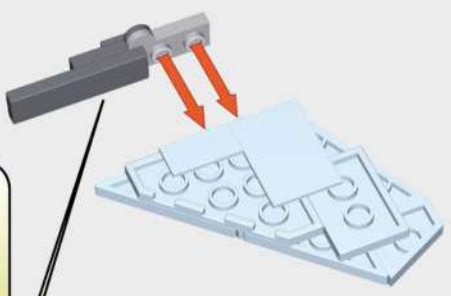

1:1

- x1
- x1
- x2
- x1
- x1
- x1
- x1

73

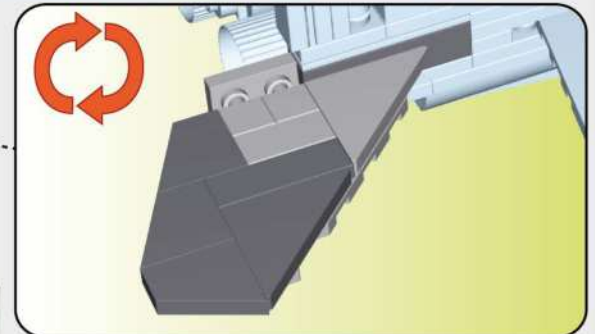
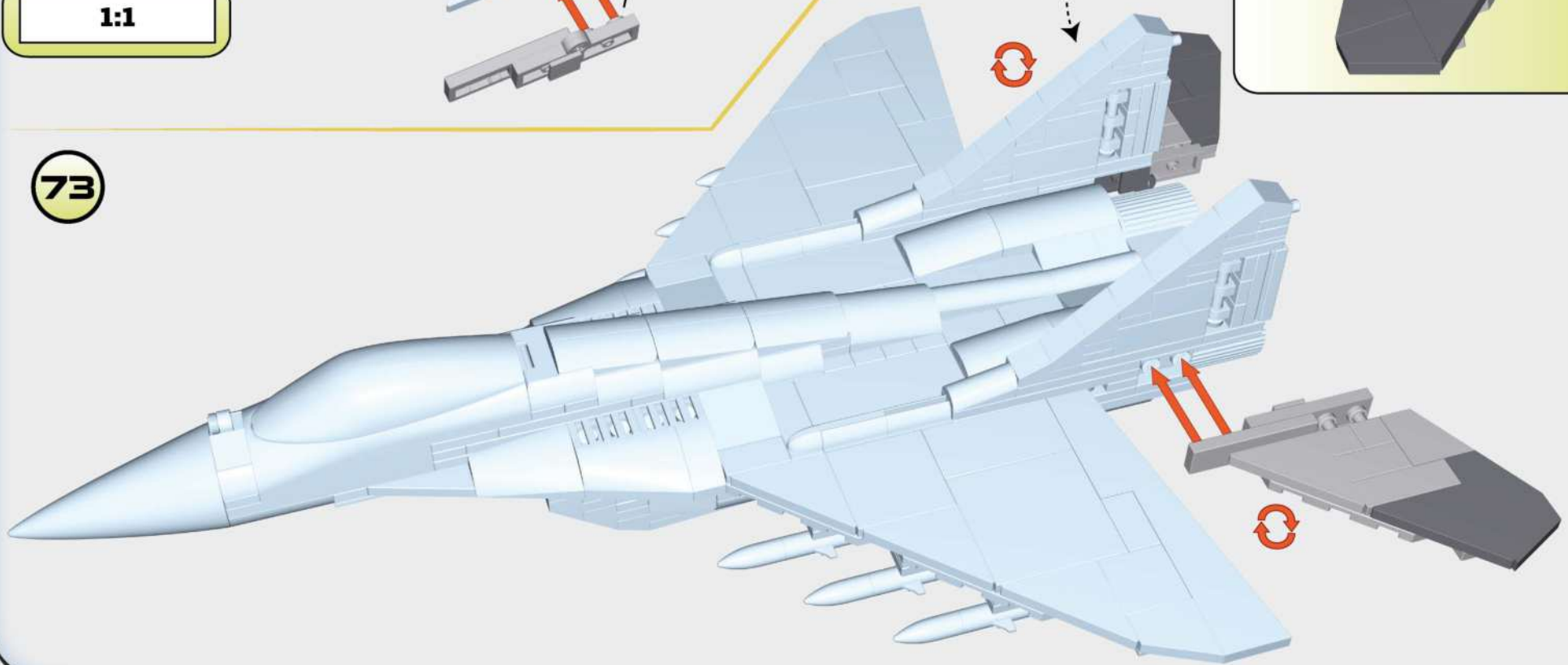

74



- x1
- x1
- x1
- x1

75

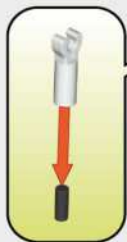

- 1:1**
- x1
- x1

76

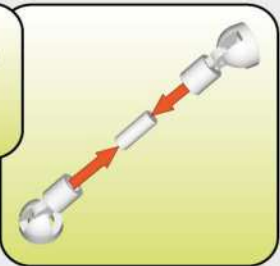

- x2
- x2
- 1:1**
- x1

77

x2

x2

x1

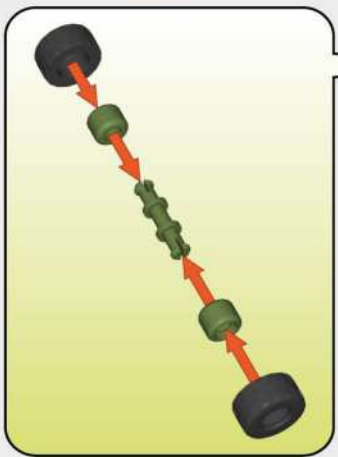

78

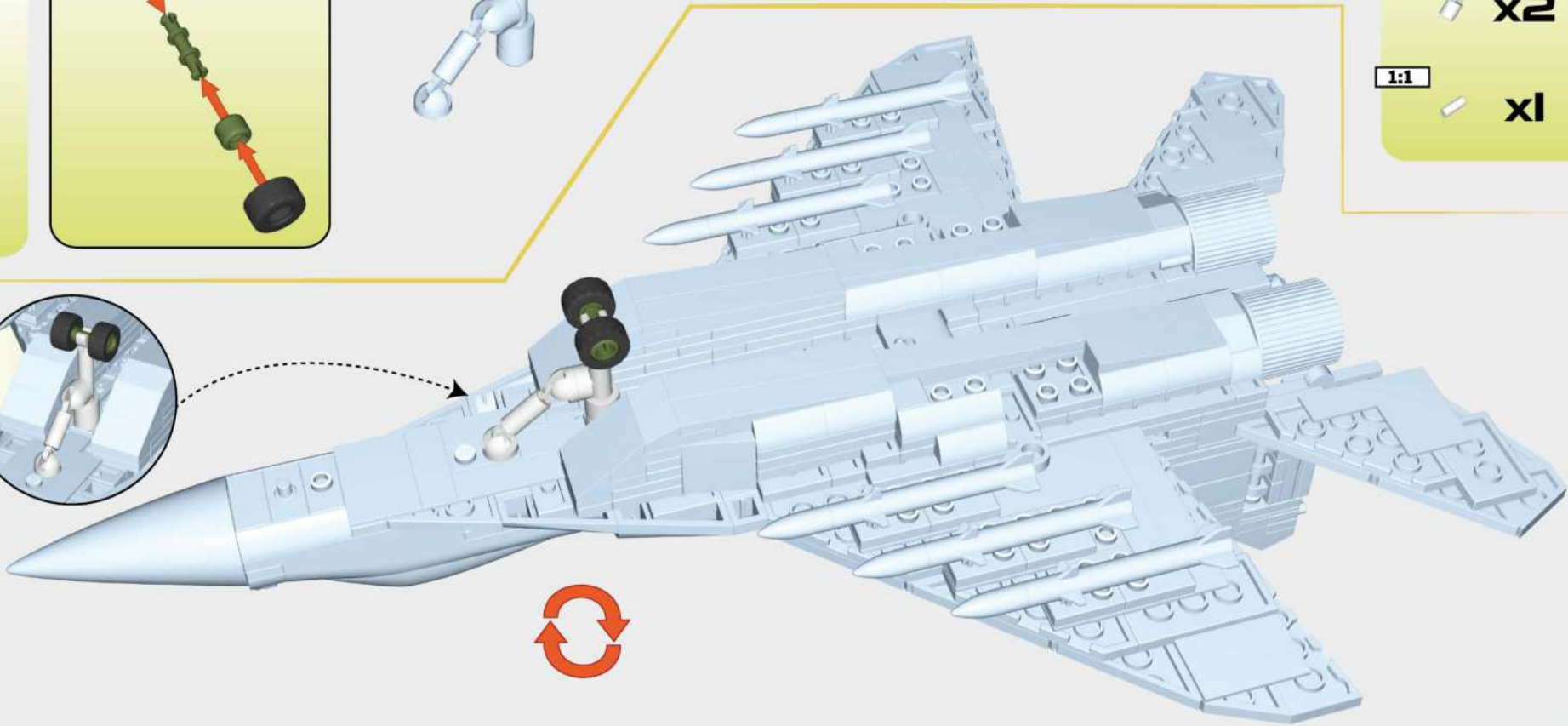
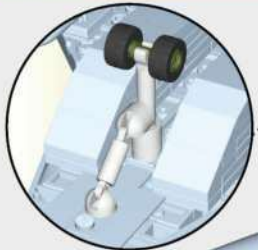

79

1:1

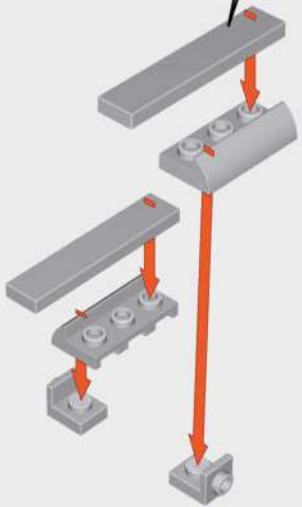

- x2
- x2
- x2

80



- x2
- x2
- x2
- x2

81

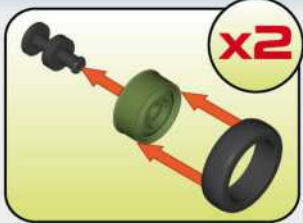

- x2
- x2
- x2
- x2
- x2
- x2

82

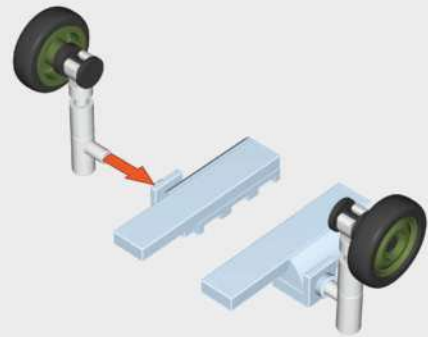

83

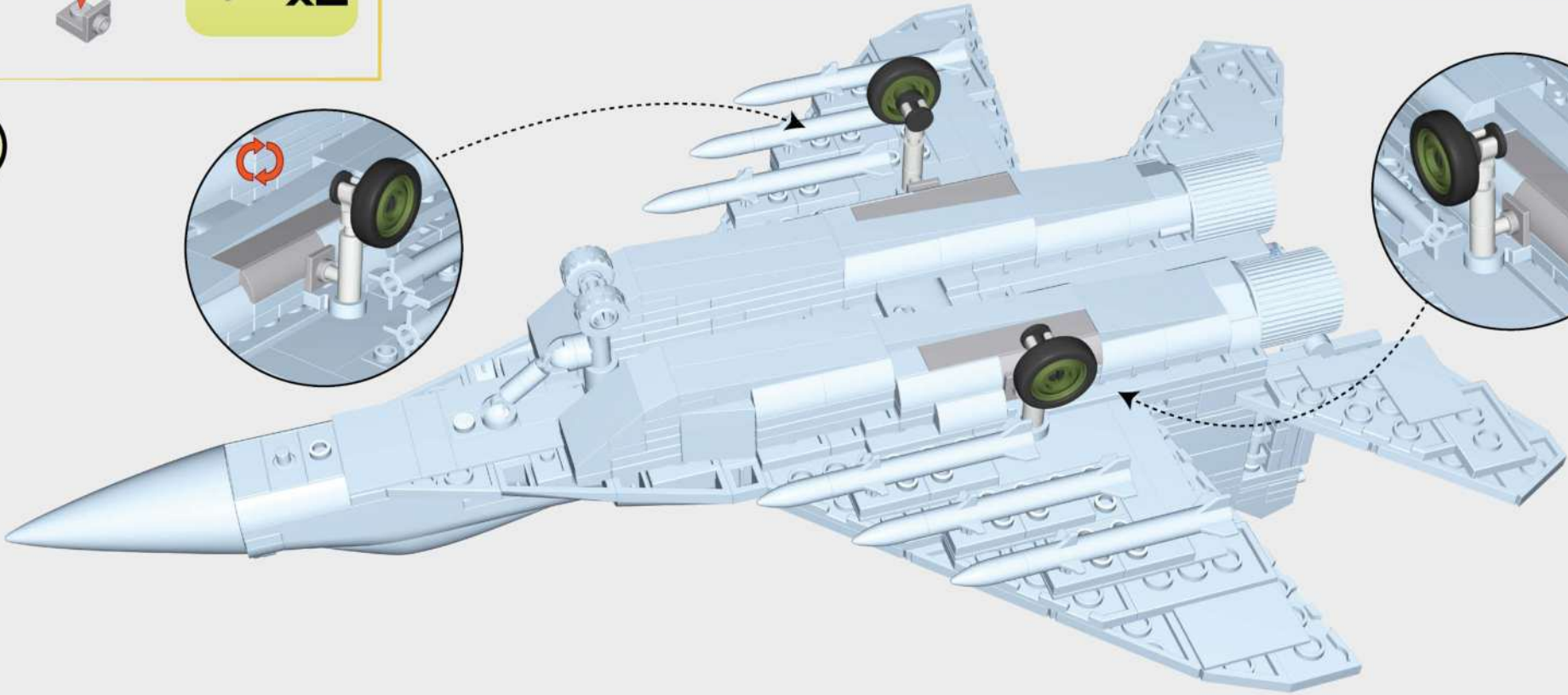

84



85

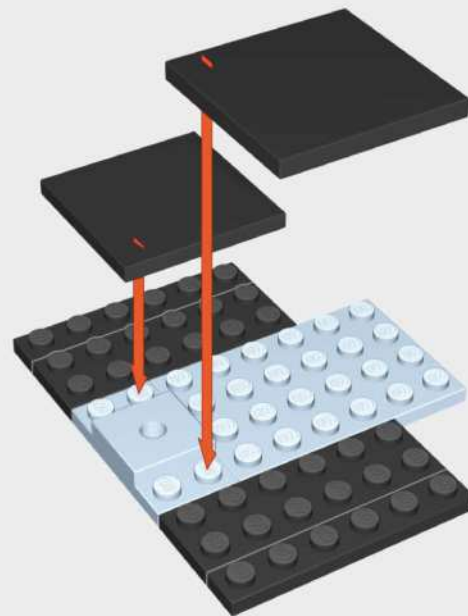

86

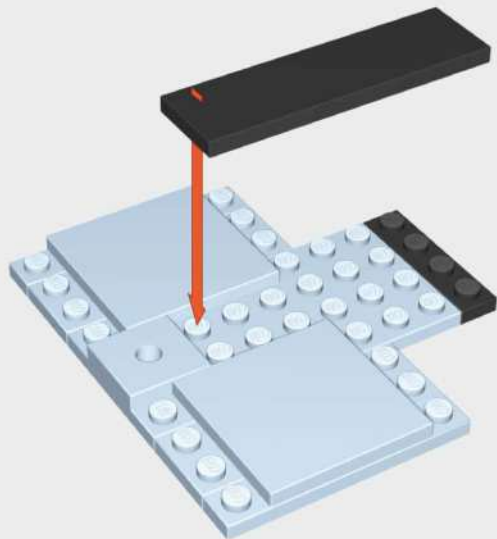

x1



x1

87

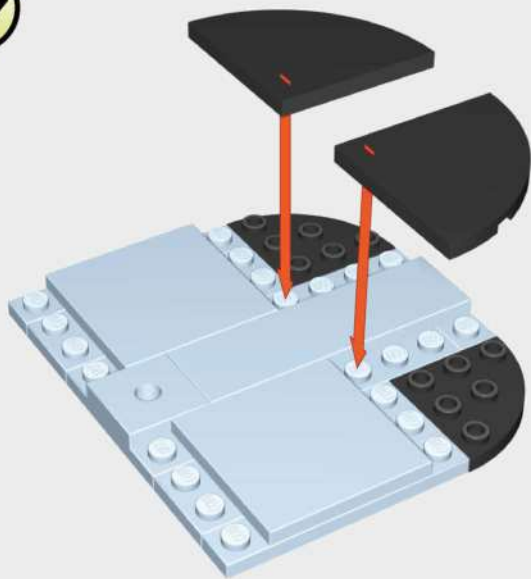

x2



x2

88

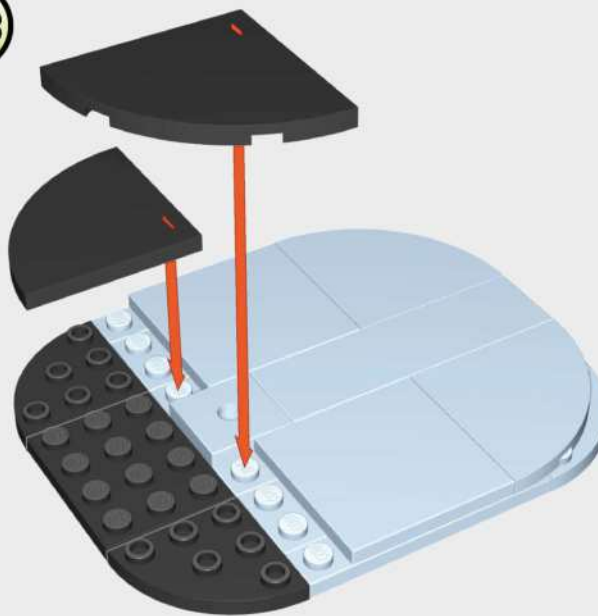

x1



x2



x2

89

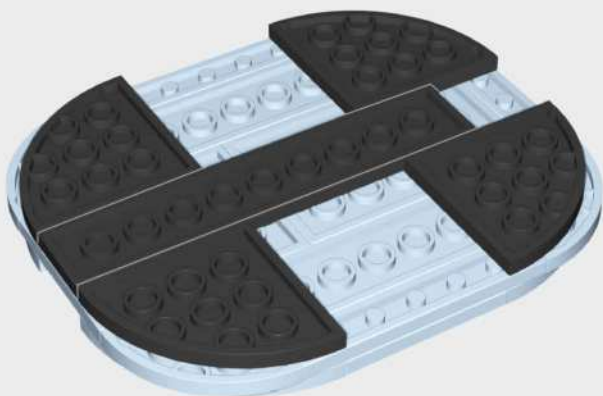

x1



x4

90



1:1

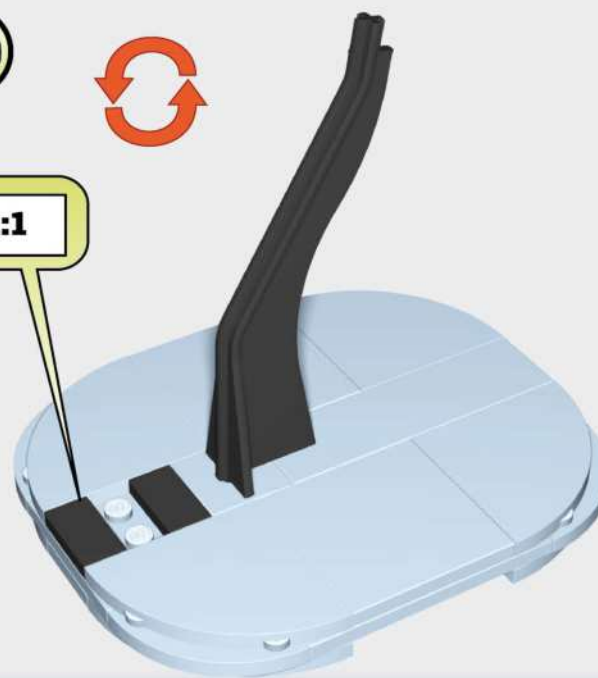









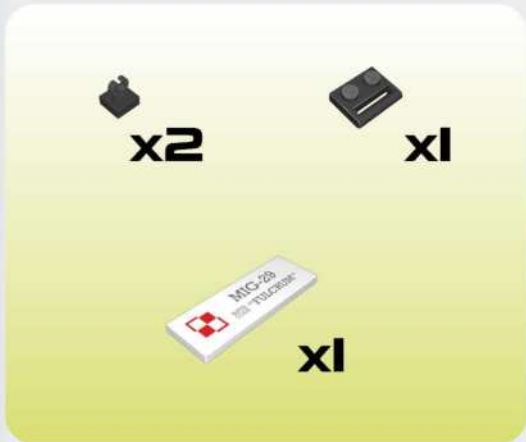
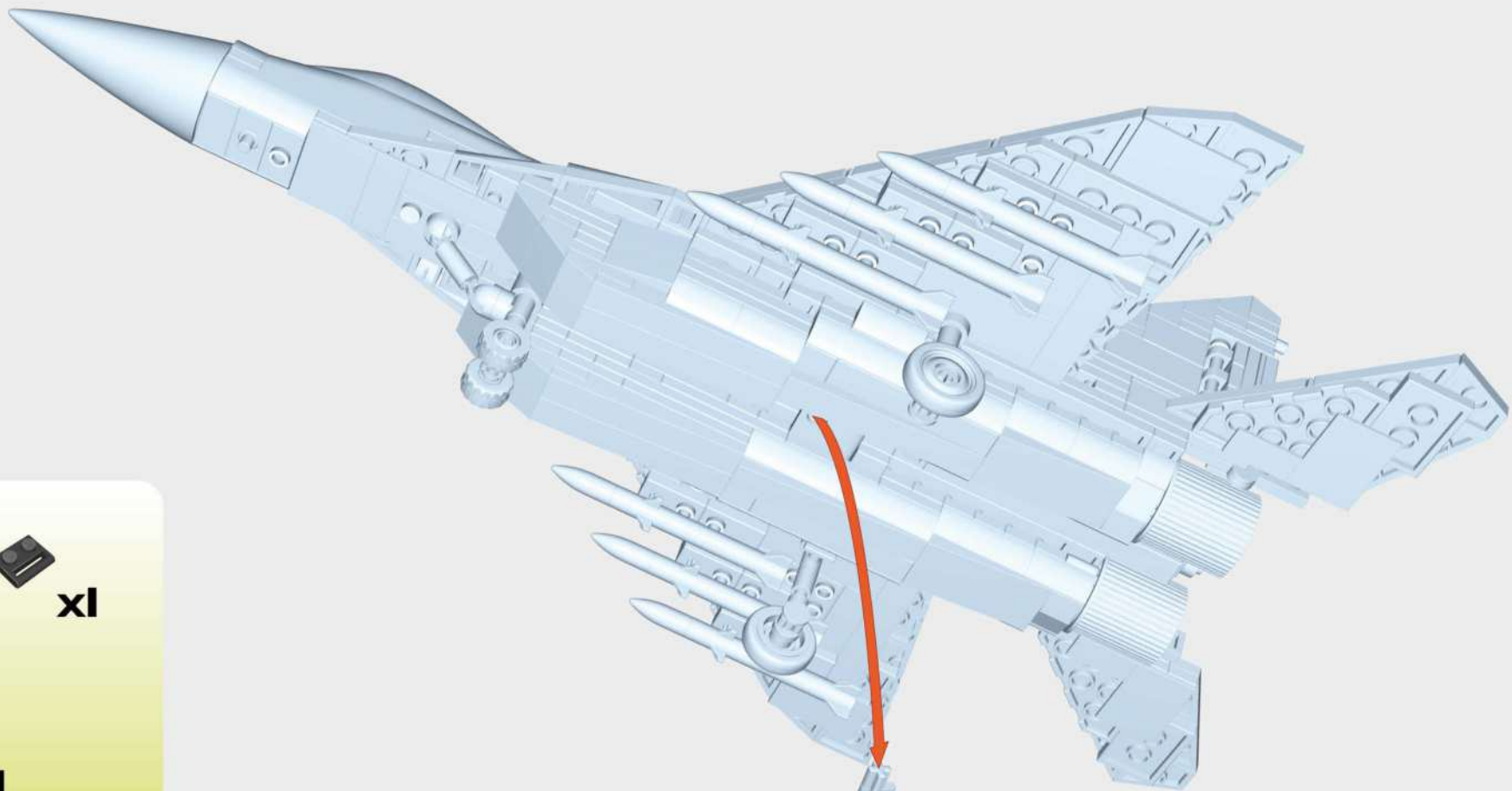



























































































































x2



x1

91



 <b>x2</b> 140810	 <b>x2</b> 138134	 <b>x2</b> 132141	 <b>x4</b> 111104	 <b>x10</b> 108651	 <b>x4</b> 132142	 <b>x2</b> 110407	 <b>x1</b> 43627	 <b>x12</b> 110070	 <b>x6</b> 54631	 <b>x2</b> 44969
 <b>x7</b> 43971	 <b>x1</b> 106341	 <b>x2</b> 106150	 <b>x2</b> 105325	 <b>x1</b> 104128	 <b>x2</b> 106151	 <b>x4</b> 117896	 <b>x1</b> 109854	 <b>x1</b> 107100	 <b>x1</b> 118637	 <b>x2</b> 115864
 <b>x1</b> 126907	 <b>x1</b> 145289	 <b>x2</b> 43668	 <b>x1</b> 130627	 <b>x4</b> 123022	 <b>x2</b> 118380	 <b>x1</b> 98243	 <b>x1</b> 95106	 <b>x2</b> 85912	 <b>x3</b> 85894	 <b>x1</b> 132144
 <b>x3</b> 57535	 <b>x1</b> 44366	 <b>x4</b> 101559	 <b>x3</b> 51554	 <b>x4</b> 99246	 <b>x2</b> 132727	 <b>x1</b> 141745	 <b>x9</b> 132145	 <b>x17</b> 43671	 <b>x6</b> 43922	 <b>x2</b> 97311
 <b>x1</b> 104562	 <b>x2</b> 113468	 <b>x4</b> 51590	 <b>x7</b> 45448	 <b>x1</b> 142898	 <b>x4</b> 98907	 <b>x3</b> 135714	 <b>x1</b> 105329	 <b>x1</b> 132146	 <b>x3</b> 100922	 <b>x1</b> 96778
 <b>x7</b> 43673	 <b>x2</b> 111106	 <b>x17</b> 105814	 <b>x2</b> 145306	 <b>x1</b> 145308	 <b>x1</b> 146514	 <b>x1</b> 146513	 <b>x2</b> 145309	 <b>x1</b> 146737	 <b>x2</b> 145232	 <b>x2</b> 140767
 <b>x3</b> 108368	 <b>x2</b> 135615	 <b>x5</b> 127200	 <b>x4</b> 57130	 <b>x2</b> 45158	 <b>x10</b> 43674	 <b>x3</b> 94600	 <b>x1</b> 100655	 <b>x4</b> 93456	 <b>x1</b> 116337	 <b>x20</b> 113420
 <b>x1</b> 104561	 <b>x5</b> 120189	 <b>x1</b> 146515	 <b>x1</b> 146516	 <b>x4</b> 120190	 <b>x2</b> 43192	 <b>x1</b> 122006	 <b>x5</b> 107862	 <b>x3</b> 51558	 <b>x1</b> 42974	 <b>x3</b> 43676
 <b>x6</b> 43931	 <b>x1</b> 64409	 <b>x1</b> 60522	 <b>x2</b> 44359	 <b>x1</b> 120212	 <b>x1</b> 145292	 <b>x1</b> 129130	 <b>x1</b> 132147	 <b>x3</b> 64204	 <b>x2</b> 85379	 <b>x2</b> 51561
 <b>x6</b> 125263	 <b>x2</b> 132148	 <b>x1</b> 67219	 <b>x1</b> 146517	 <b>x1</b> 87252	 <b>x2</b> 89125	 <b>x2</b> 43685	 <b>x2</b> 44140	 <b>x2</b> 43686	 <b>x2</b> 107485	 <b>x1</b> 51567
 <b>x1</b> 43868	 <b>x1</b> 123023	 <b>x3</b> 108322	 <b>x2</b> 118386	 <b>x2</b> 126280	 <b>x4</b> 118385	 <b>x4</b> 141417	 <b>x4</b> 75779	 <b>x3</b> 127068	 <b>x5</b> 124041	 <b>x2</b> 63853
 <b>x1</b> 124043	 <b>x8</b> 124558	 <b>x3</b> 132149	 <b>x1</b> 51628	 <b>x2</b> 43690	 <b>x1</b> 146697	 <b>x5</b> 117785	 <b>x1</b> 125258	 <b>x5</b> 45569	 <b>x2</b> 51572	 <b>x1</b> 100656



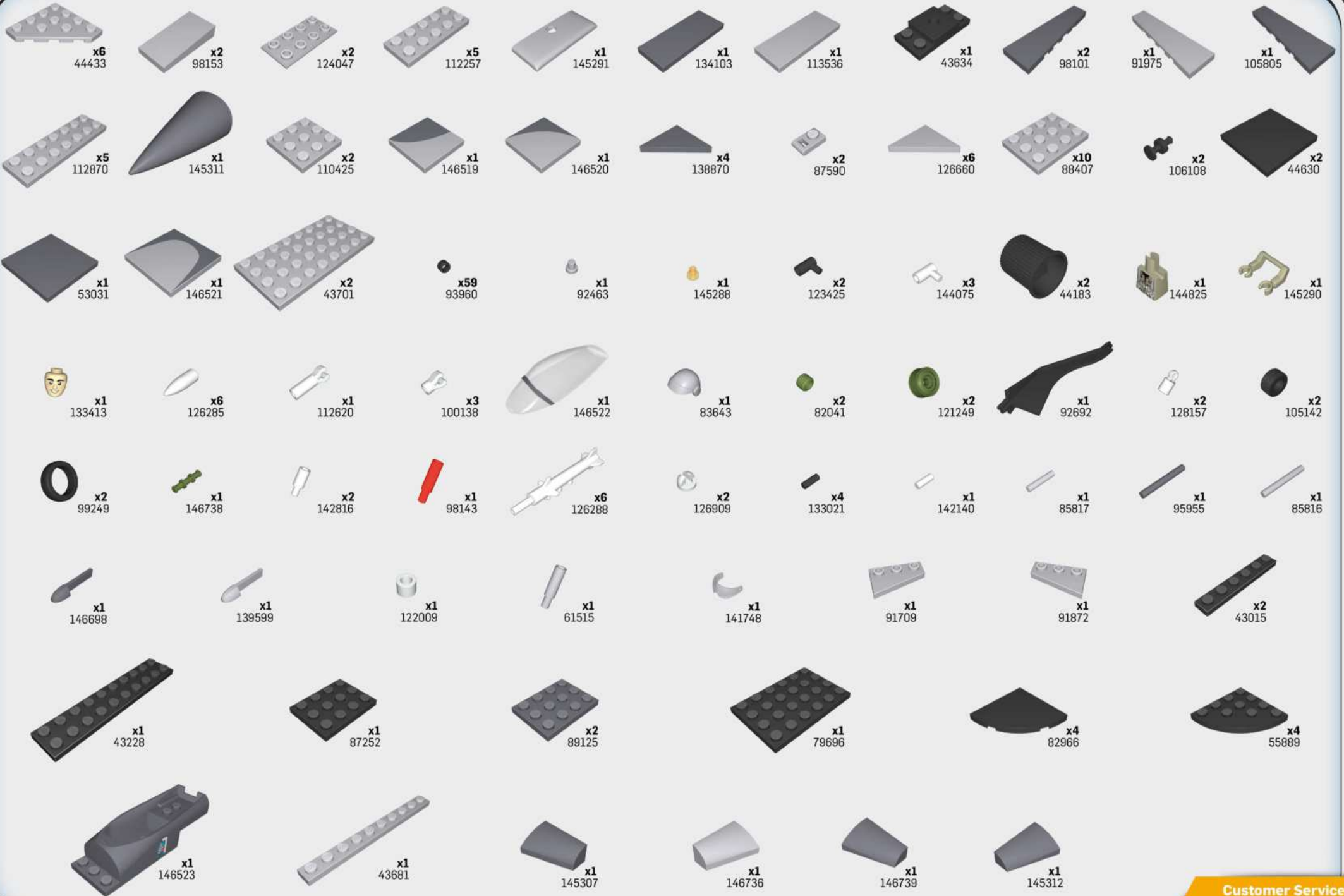



# HISTORICAL COLLECTION



LIM-1 POLISH AIR FORCE 1952



5822



S-102 CZECHOSLOVAK AIR FORCE



5821



MESSERSCHMITT BF 109 E-3



5727



SUPERMARINE SPITFIRE MK. VB



5725



FOCKE-WULF FW 190 A5



5722



Produced under license from Boeing. Boeing and F/A-18 Hornet are trademarks of The Boeing Company.



F/A-18C HORNET™  
5819



F-16®D FIGHTING FALCON®  
5815



F-16®C FIGHTING FALCON®  
5814



MERKAVA MK. I/II  
2621

DEUTSCHES  
PANZERMUSEUM  
MUNSTER



LOCKHEED MARTIN



LOCKHEED MARTIN®, F-16®C Fighting Falcon®, F-16®D Fighting Falcon®, associated emblems and logos, and body designs of vehicles are either registered trademarks or trademarks of Lockheed Martin Corporation in the USA and/or other jurisdictions, used under license by COBI.



F-16®C FIGHTING FALCON®  
5813





Produced under license from Boeing. Boeing and F/A-18 Hornet are trademarks of The Boeing Company.



F/A-18C HORNET™  
5810



MIRAGE III S SWISS AIR FORCE  
5827



MIRAGE III C  
5818



MIRAGE III C  
5826



WWW.COBI.EU

For news and special deals

Find us on:



00-05834-595