

HISTORICAL COLLECTION

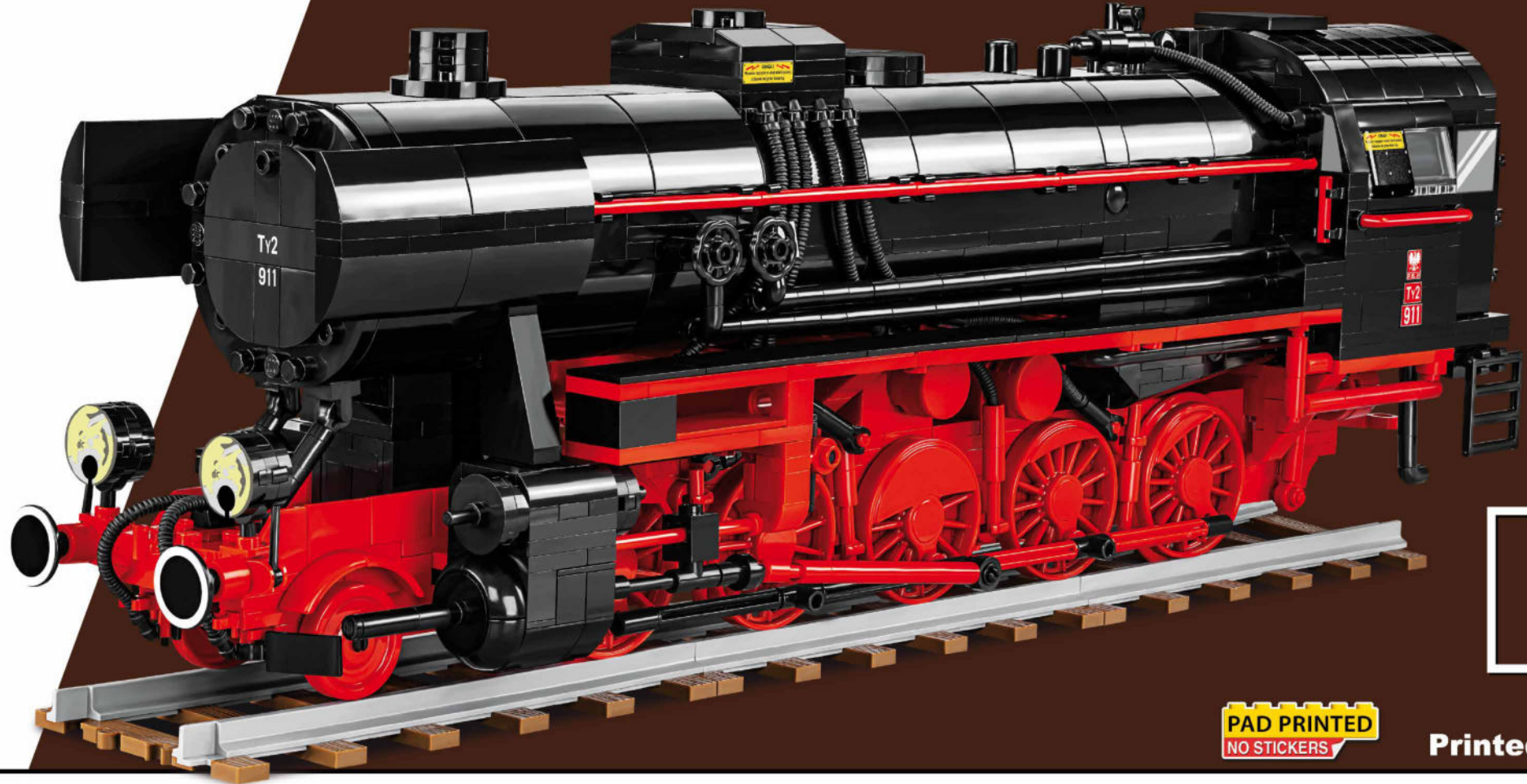

6283



PAD PRINTED
NO STICKERS

Printed in EU



WARNING: CHOKING HAZARD-
Toy contains small parts.
Not for children under 3 years.

1723 2

STEAM LOCOMOTIVE DR BR 52 / TY2

SCALE 1:35



+



+



BE CAREFUL: NOTICE THE DIFFERENCE



UWAGA: RÓŻNE KLOCKI



1

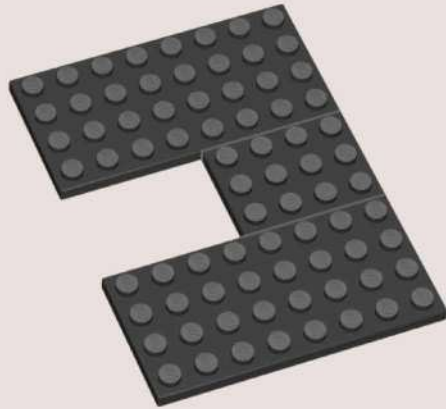

2

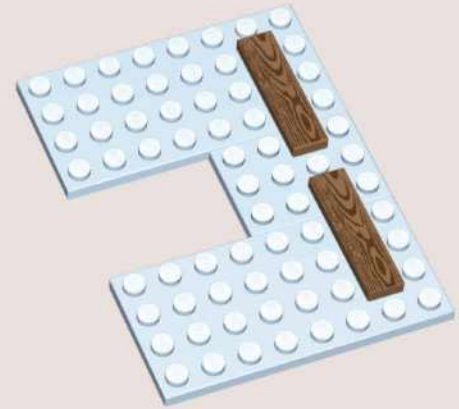

3

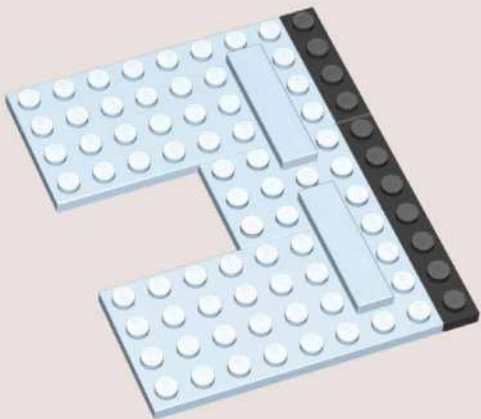

4

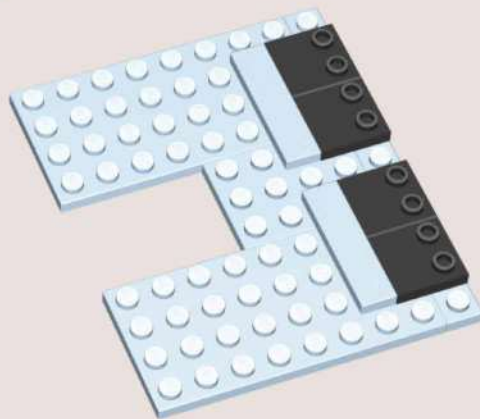

5

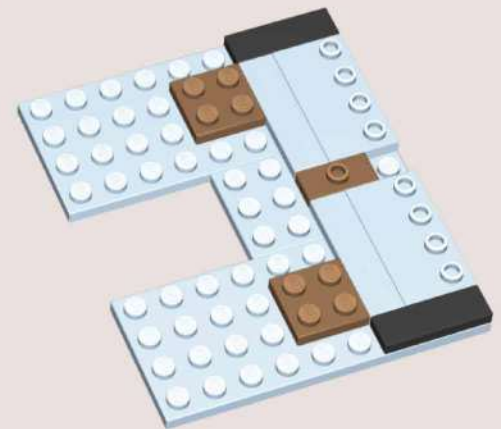

6

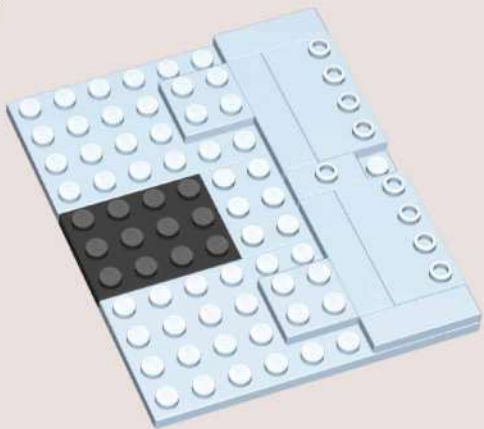

7

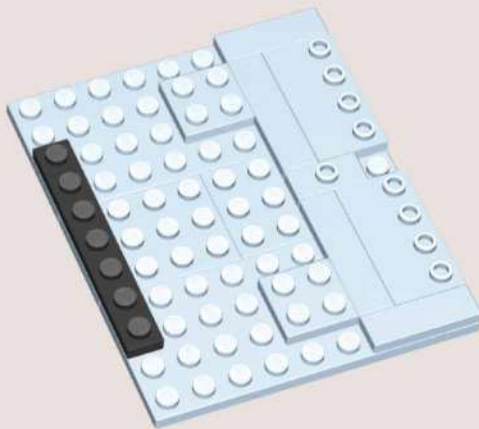

8

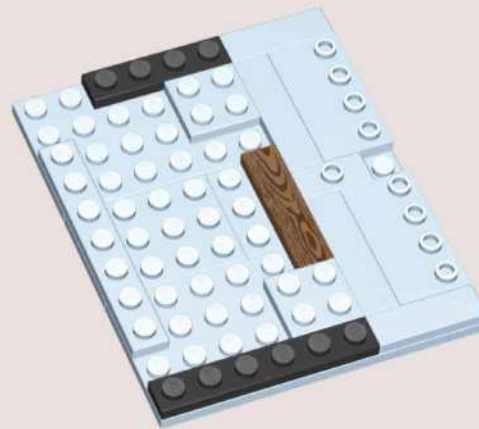

9

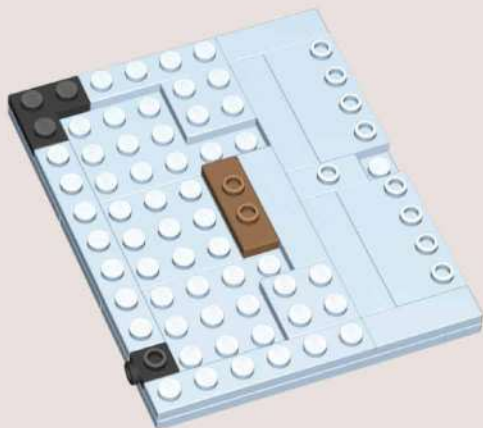

10

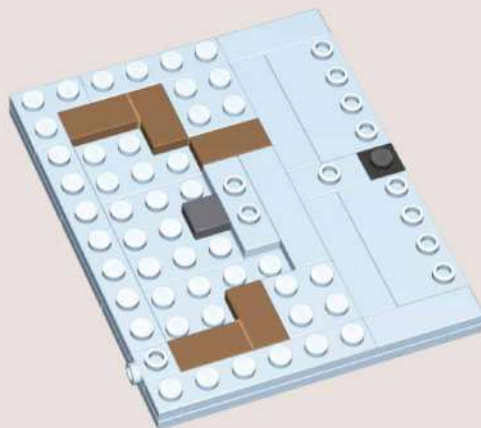

11

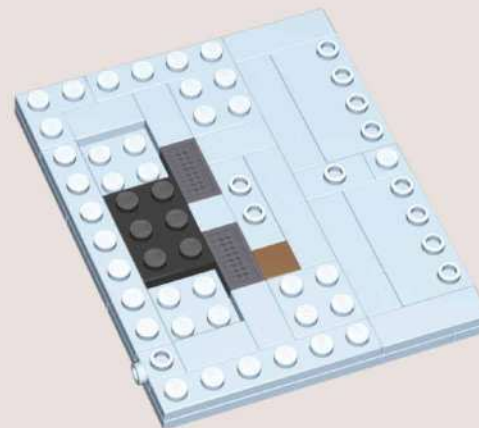

18

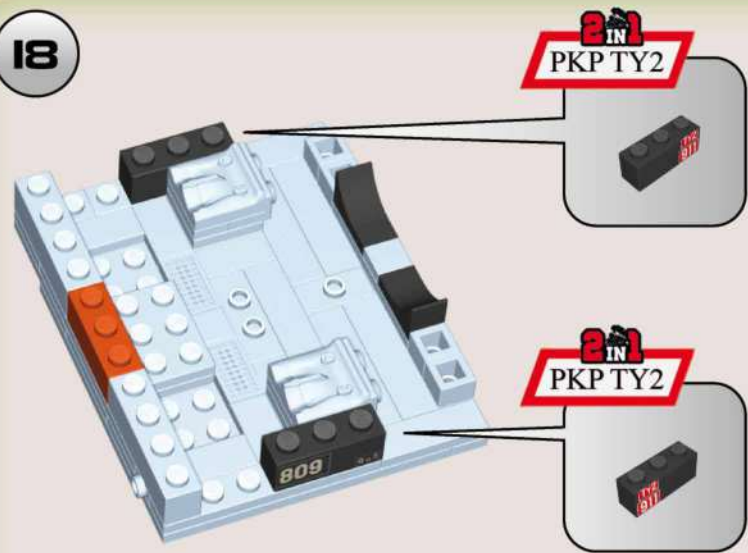

19

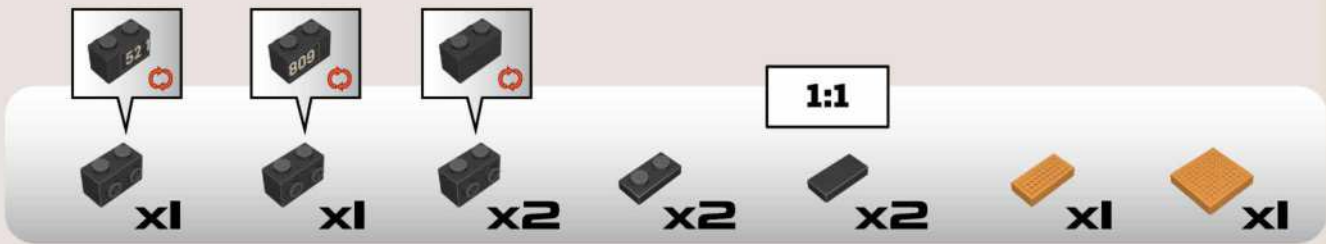
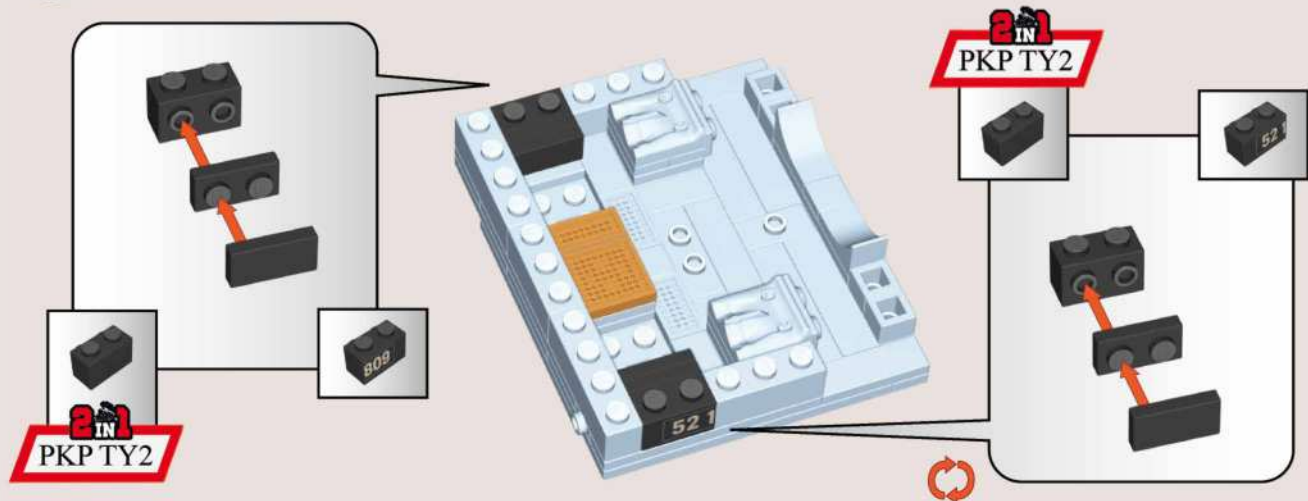

20

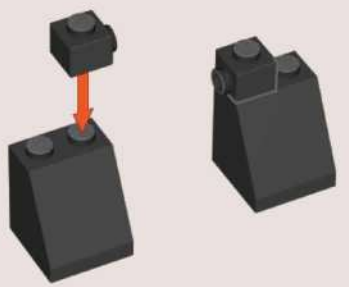

21

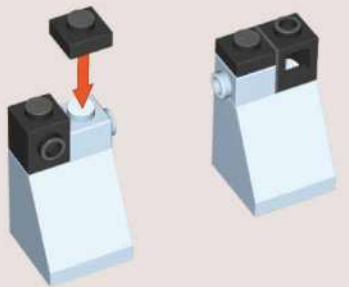

22

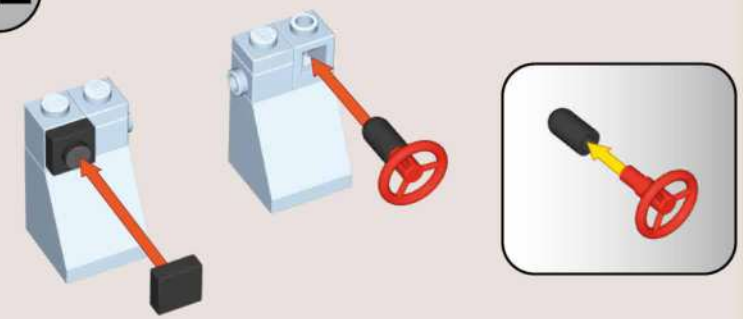

23

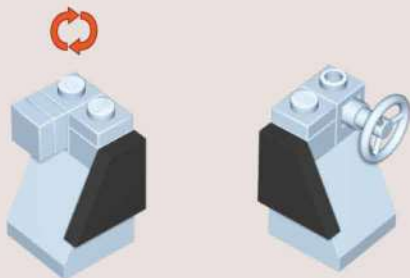

24

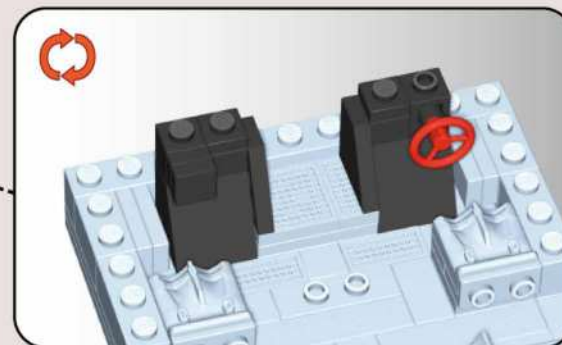
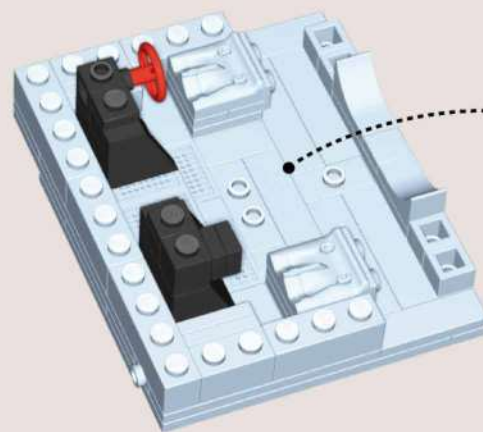

25

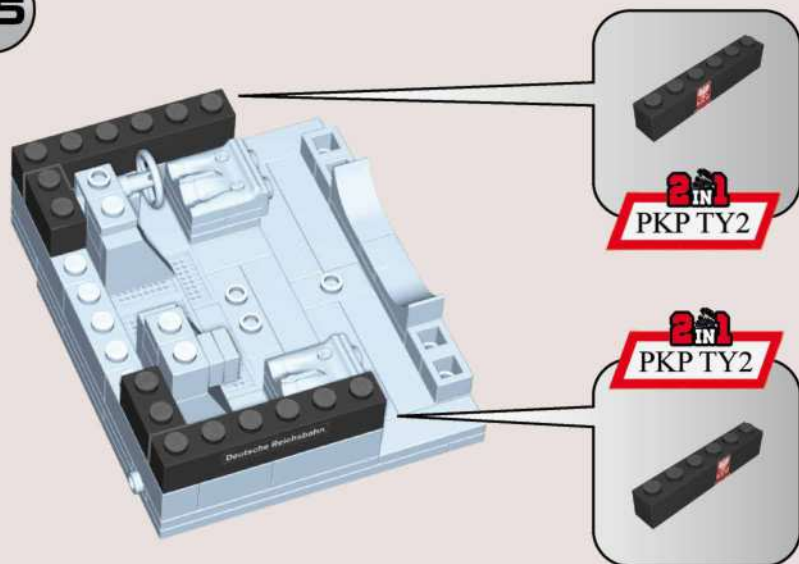

26

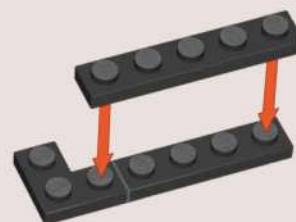

27



28

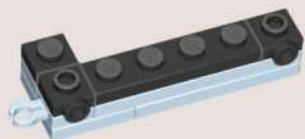

29



30

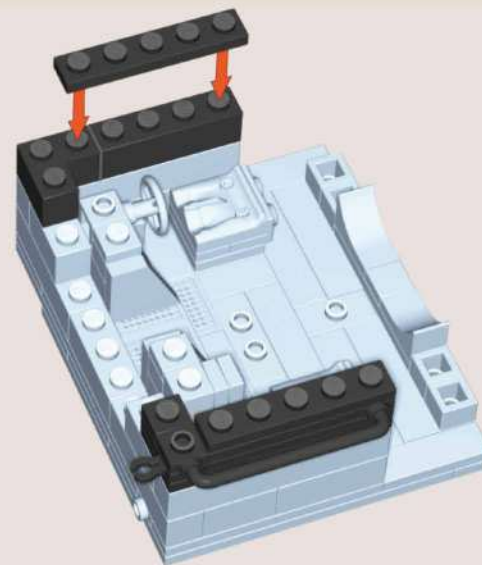

31



32

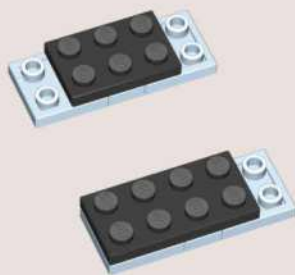

33

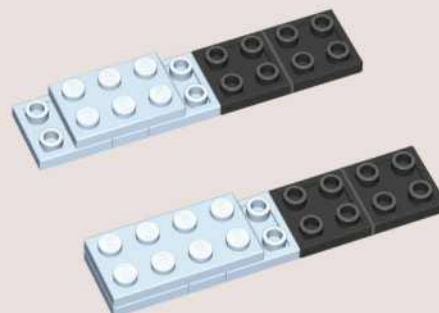

34

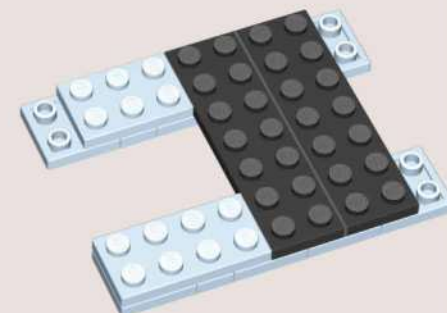

35

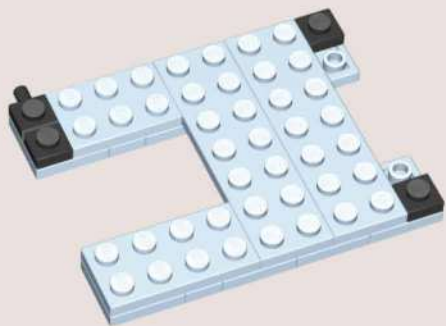

x1



x3

36

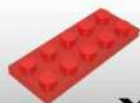
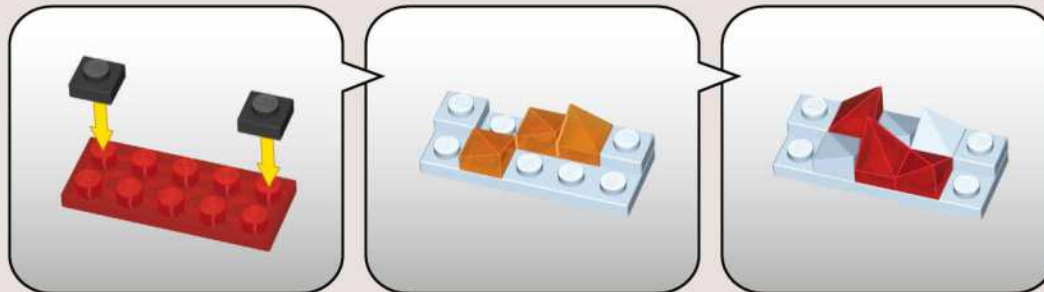

x1



x2



x3



x3

37

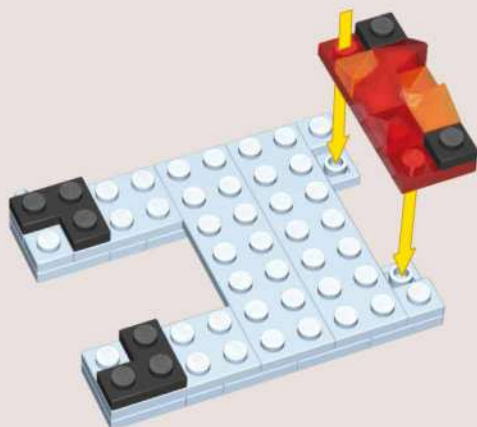

x2

38

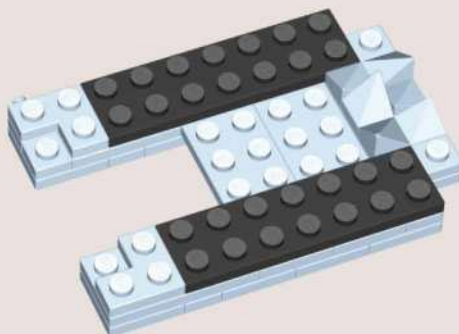

x2

39

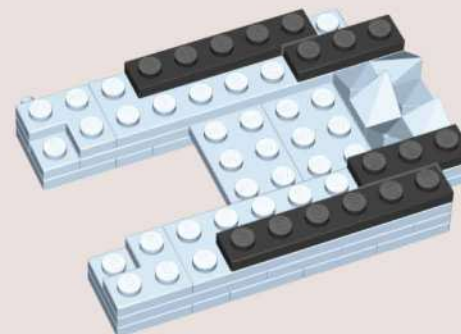

x1



x1



x2

40

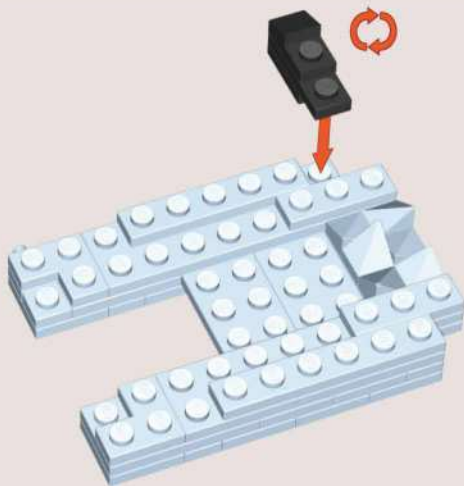
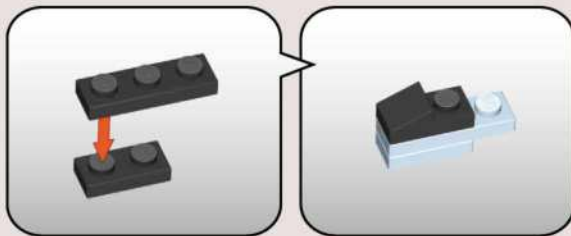

41

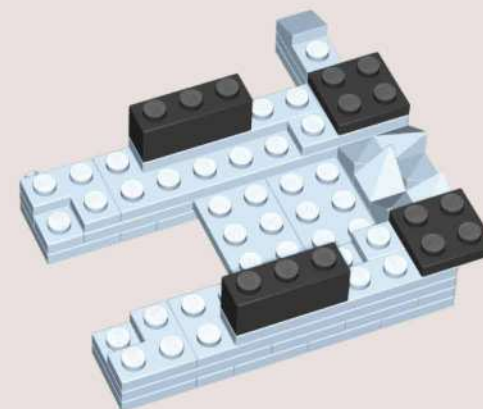

42

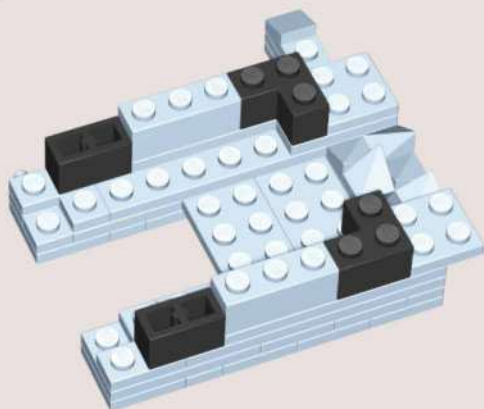

43

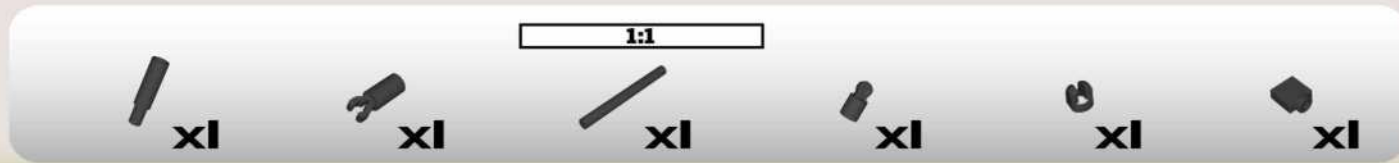
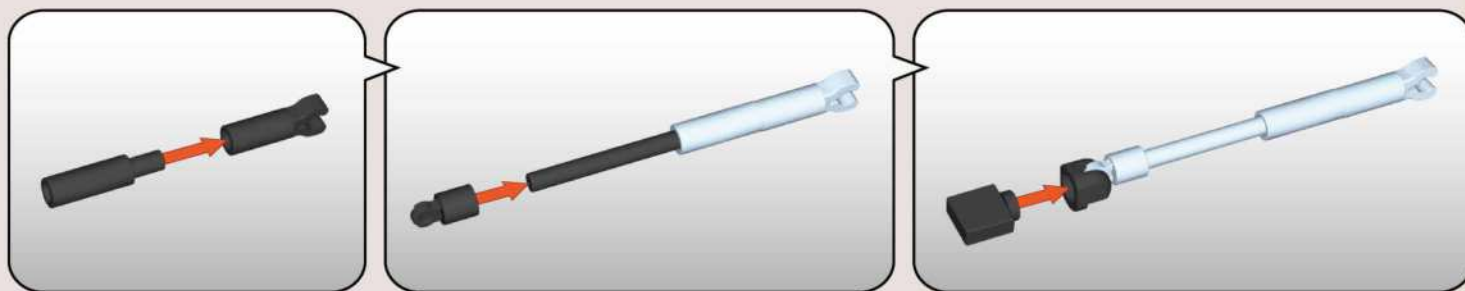

44

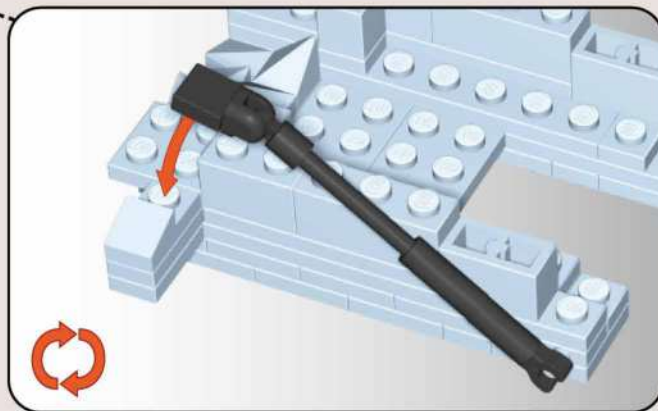
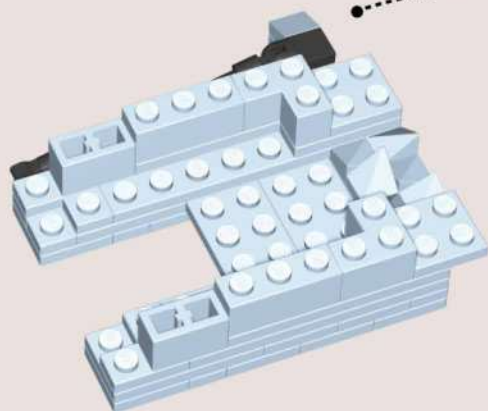

45

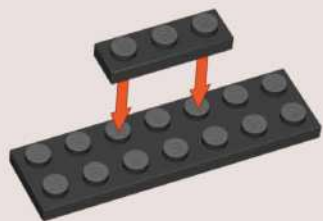

46



47



48

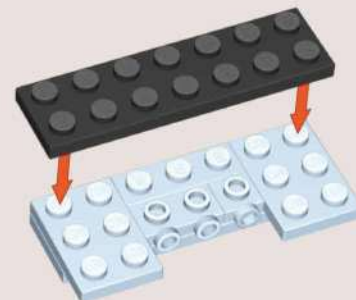

49



x1

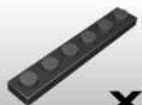

x1

50



x1



x3

51



x1

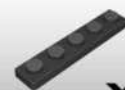

x1

52



x4



x1

53



1:1



x2



x2

54

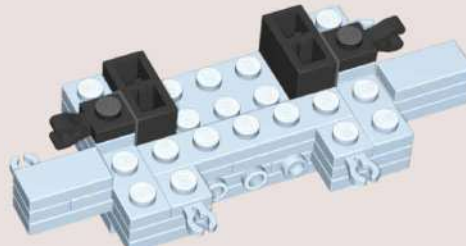

x2



x2

55

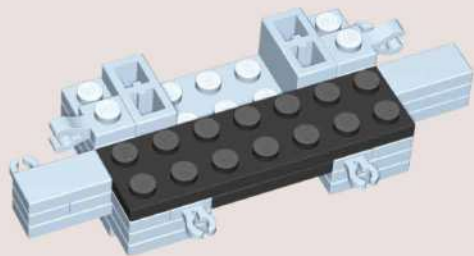
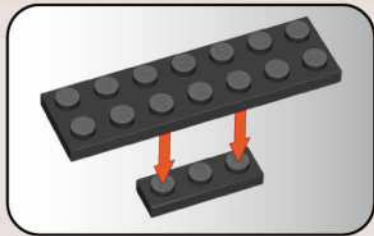

x1

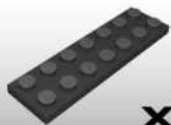

x1

56

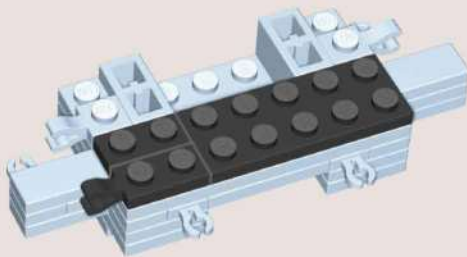

x1



x1

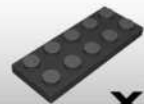

x1

57

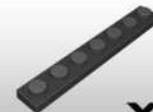
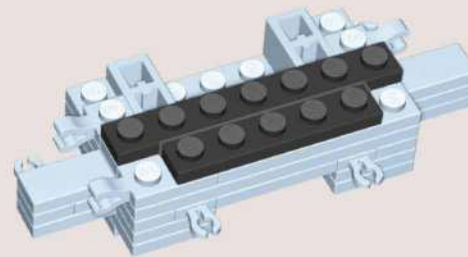

x1



x1

58

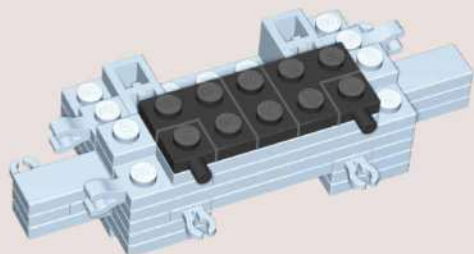

x2



x2



x1

59

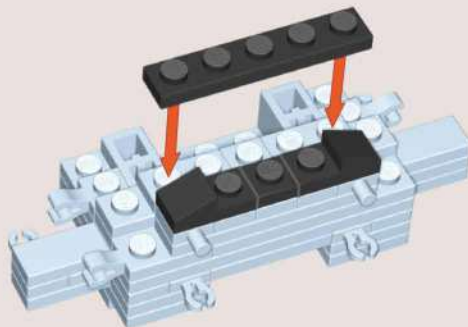

Ⓟ



x2



x1



x1

60

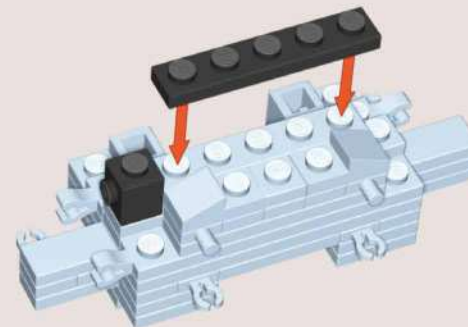

②



x1



x1

61

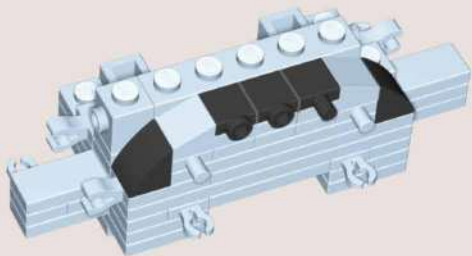

62

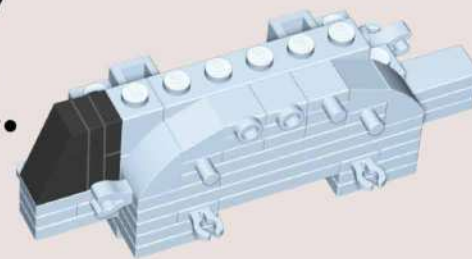
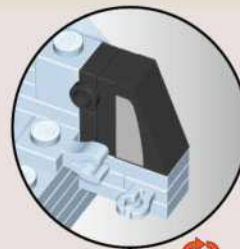
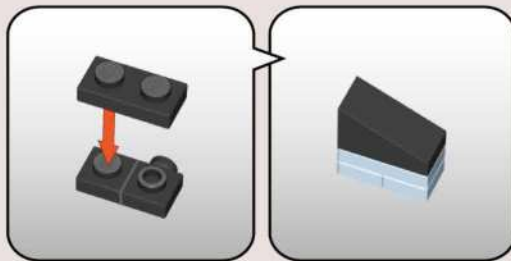

63

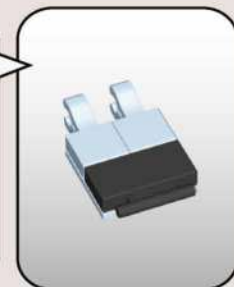
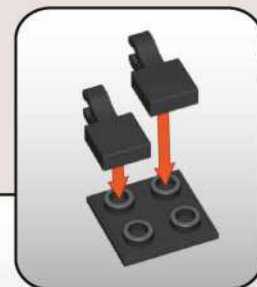
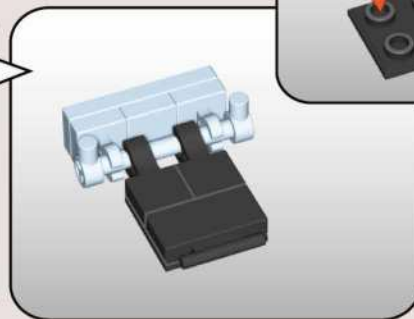
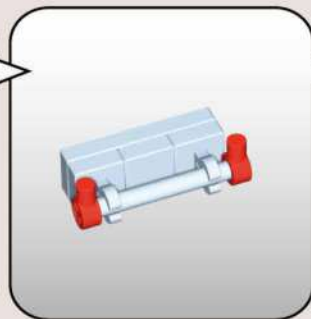
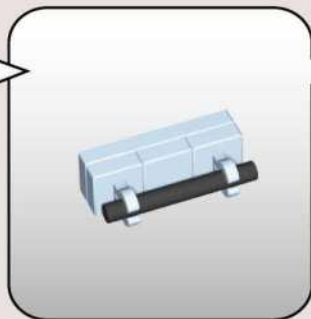
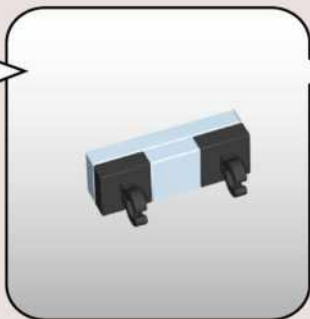
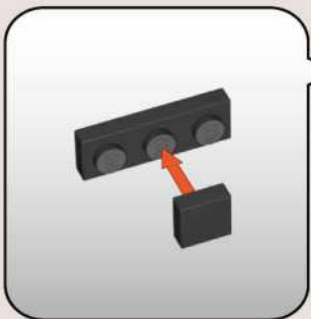

1:1



64

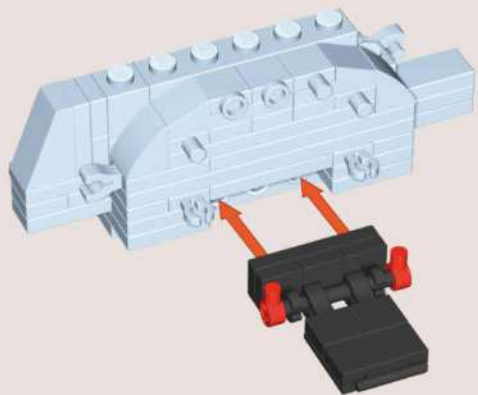

65

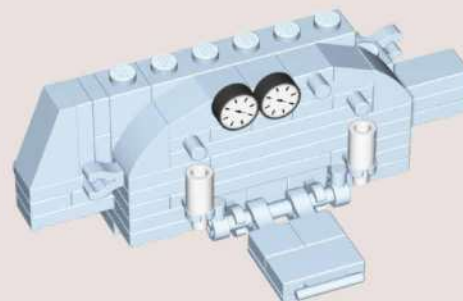

x2



x2

66

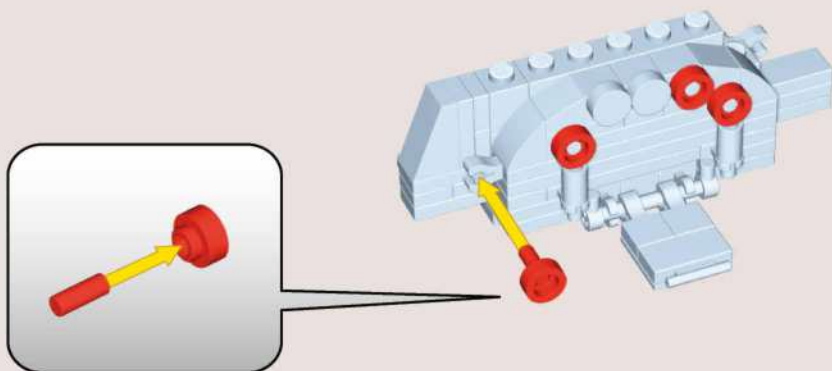

1:1



x1



x4

67

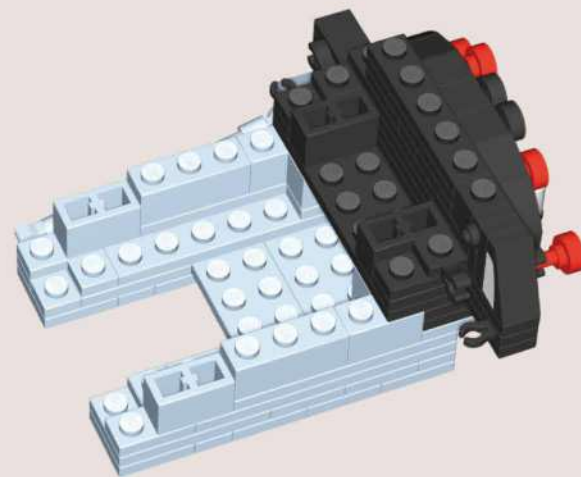

68

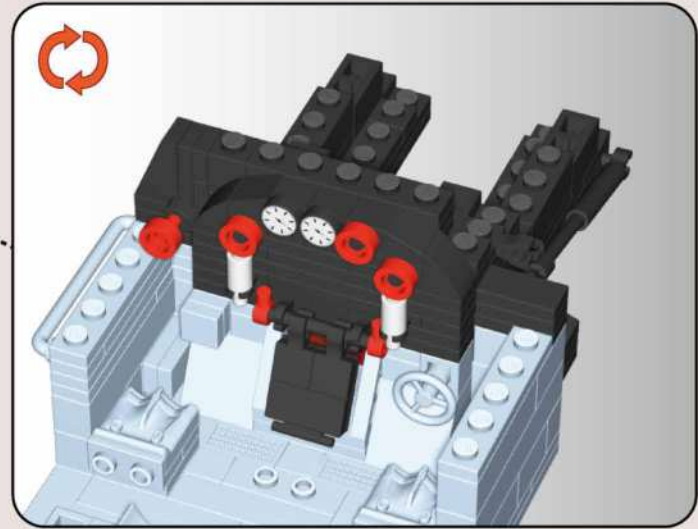
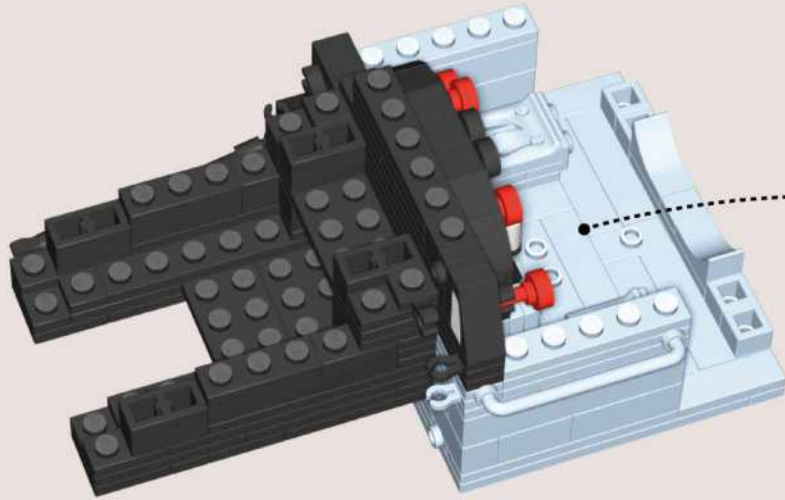

69



70

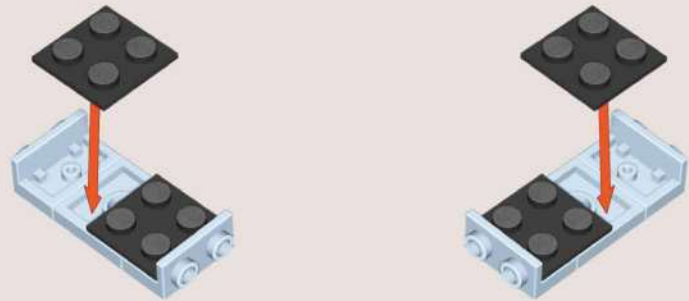

71



1:1



x2



x2

72

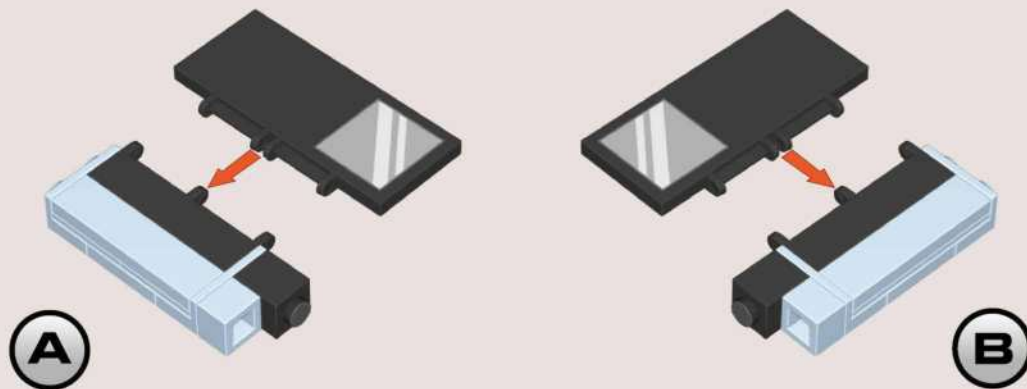

x2



x2

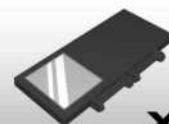

x1

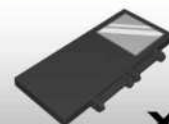

x1

73

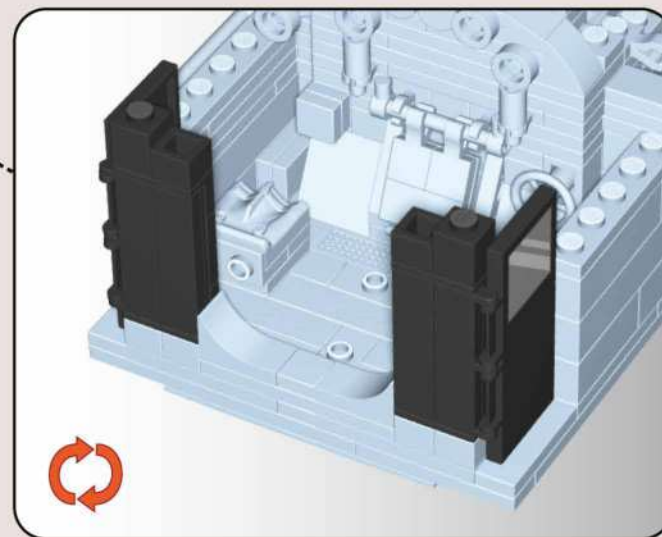
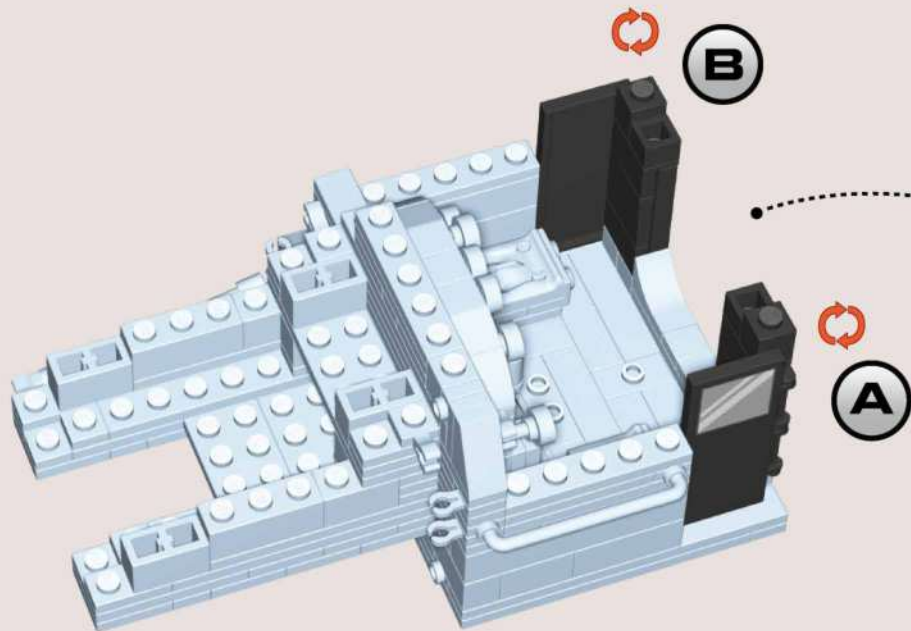

74

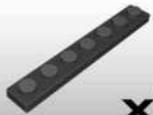

x1



x1

75



x2

76

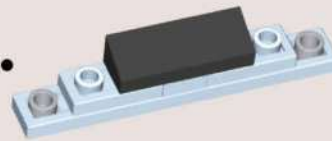
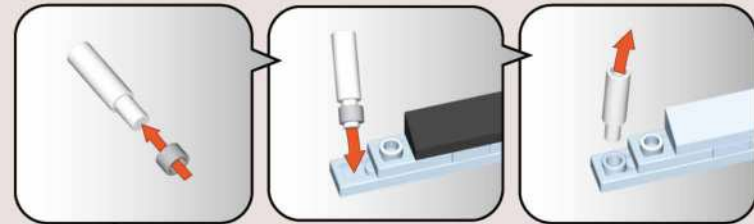

x2



x1

77

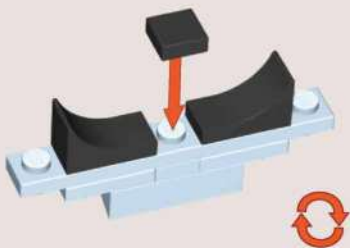

x2



x1

78

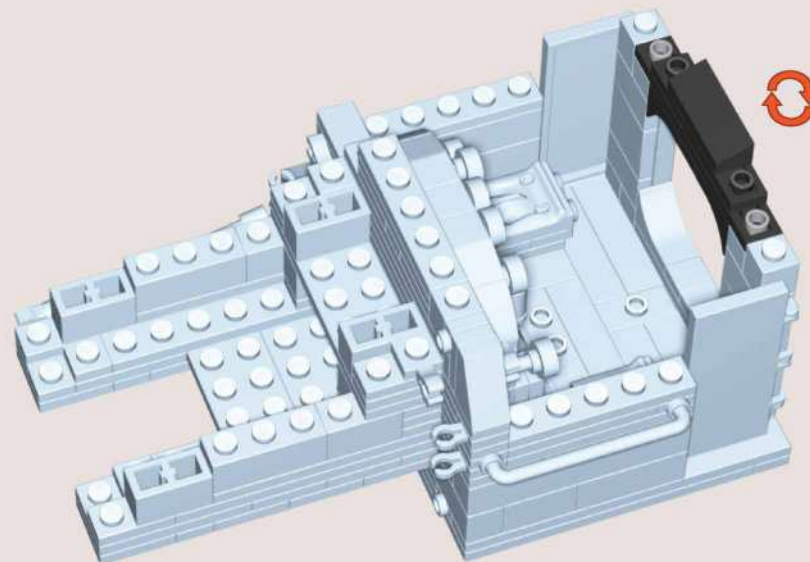

79

A

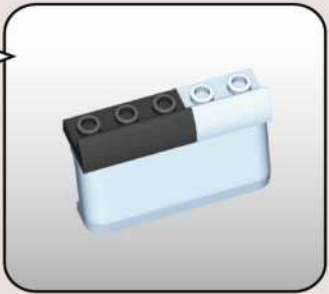
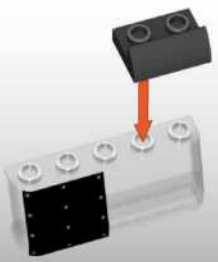

2 IN
PKP TY2



B

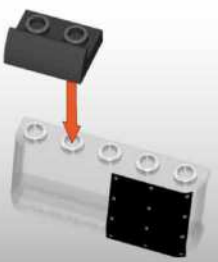

2 IN
PKP TY2



B

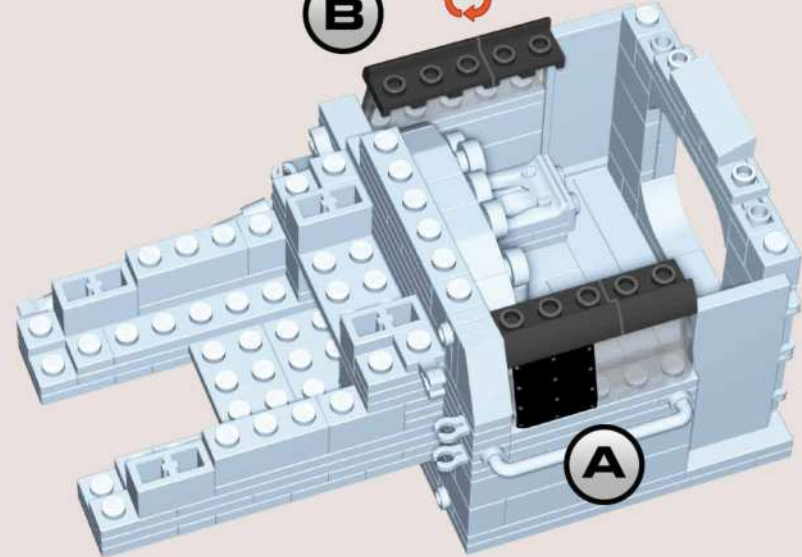

A



80

A



B



B

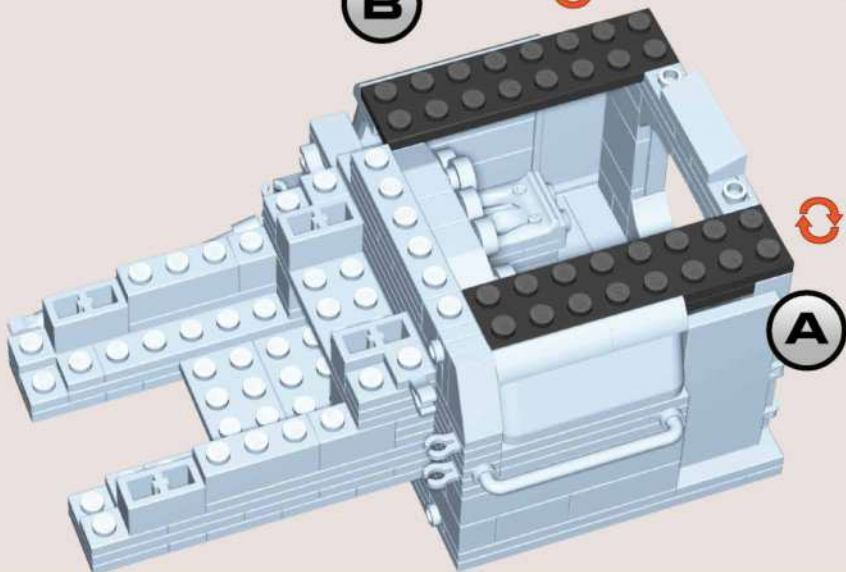

A



81

2 IN
PKP TY2

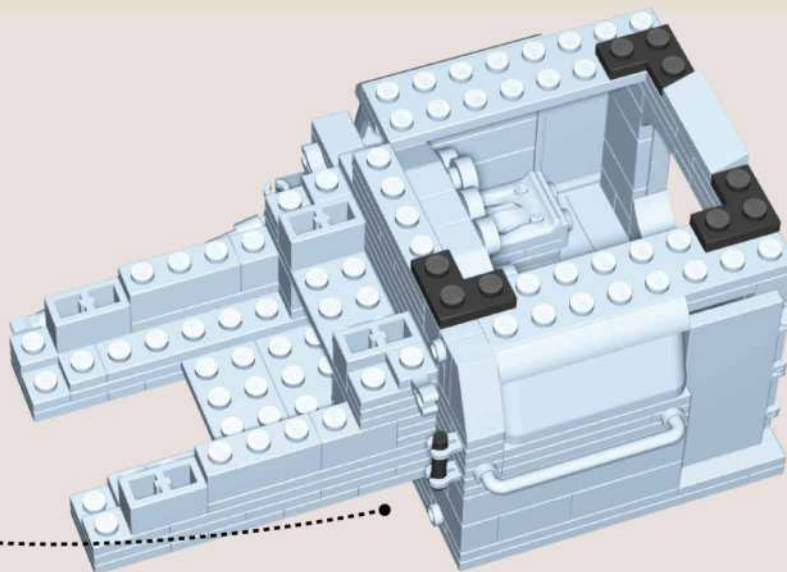

1:1

1:1



x3



x1



x1

82

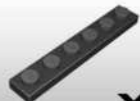
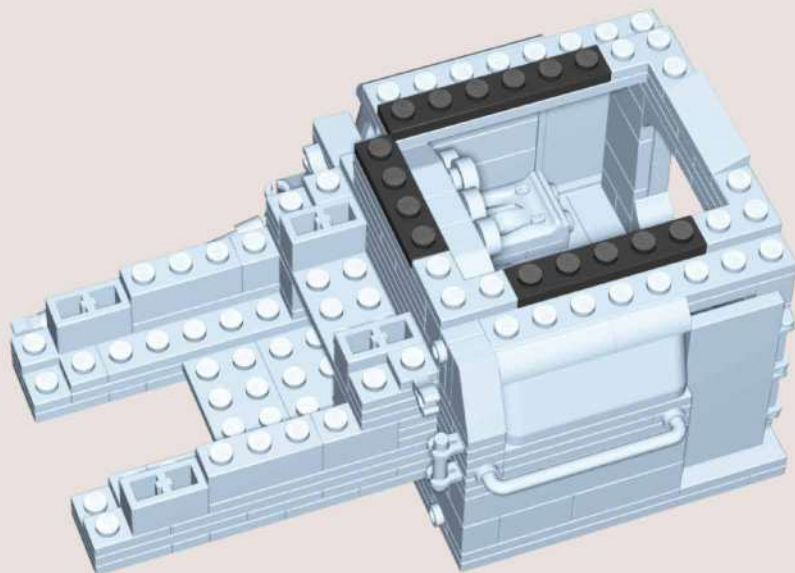

x1

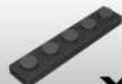

x1



x1

83

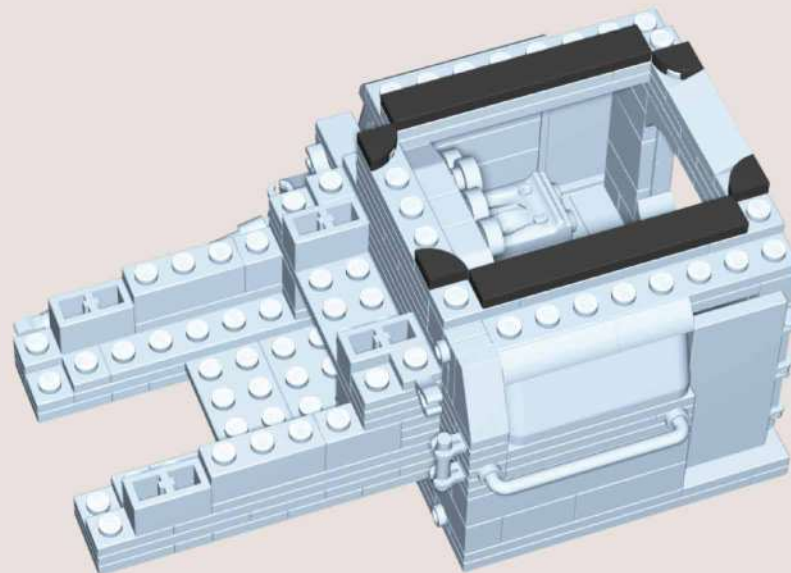

1:1



x2



x4

84

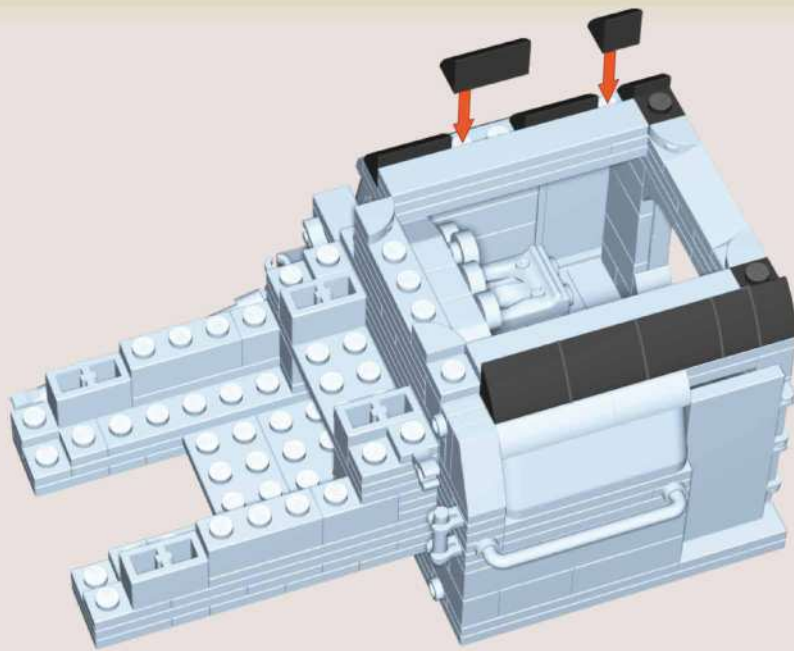

⑨
x6

x2

③
x2



86



x2

87

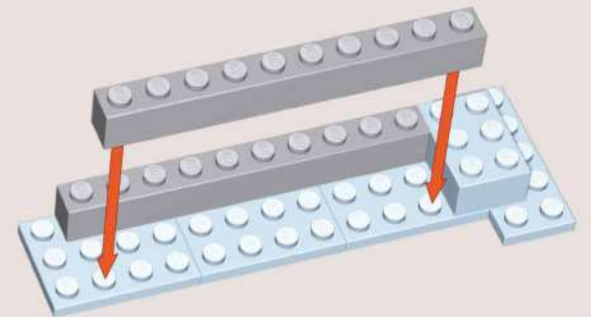

x2

85

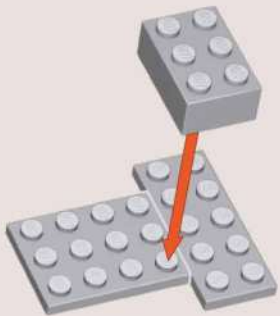

x1 x1 x1

88

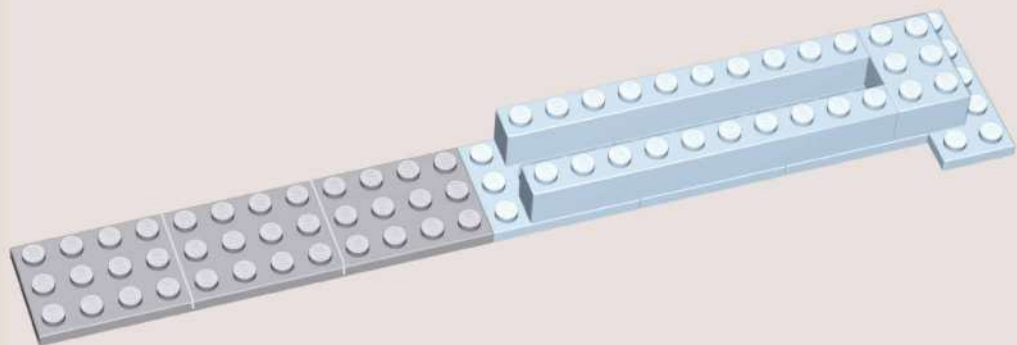

x3

89

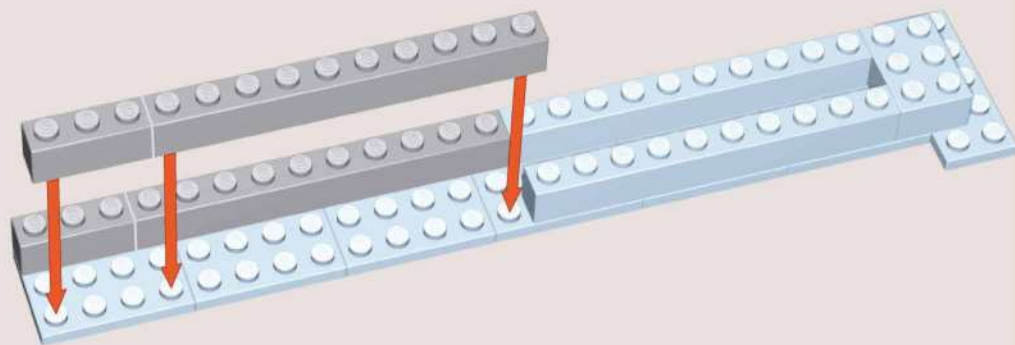

x2



x2

90

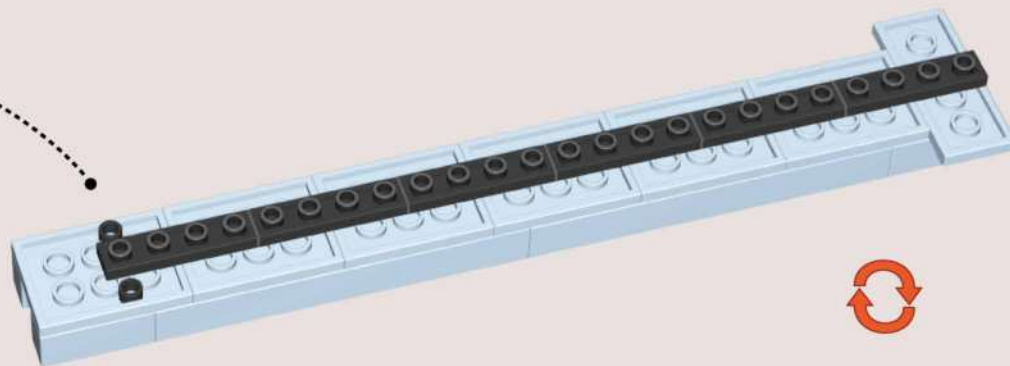
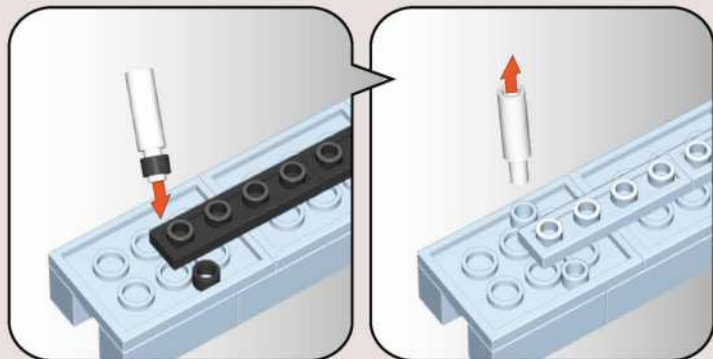

x6



x2

91

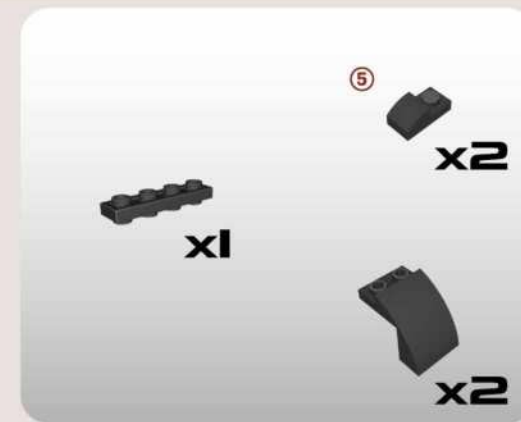
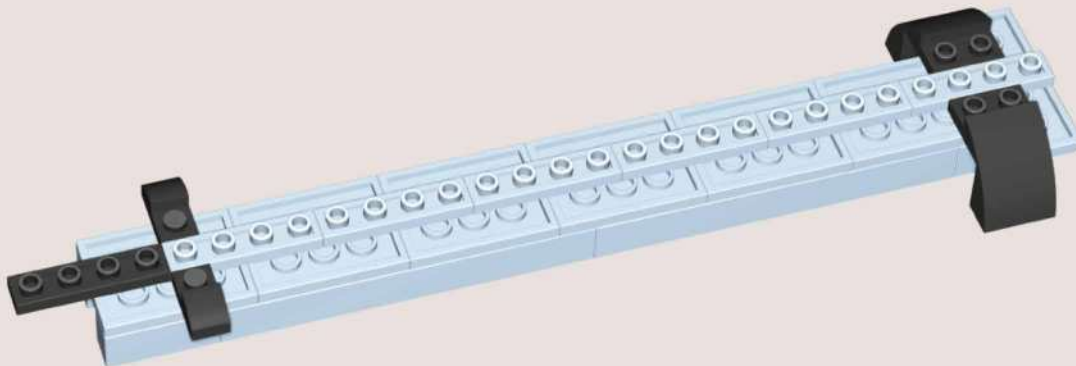

92

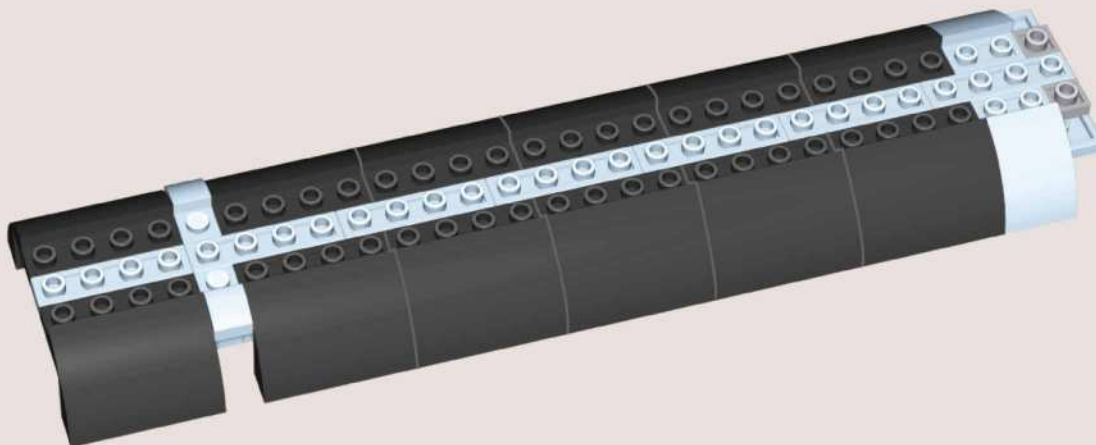

93

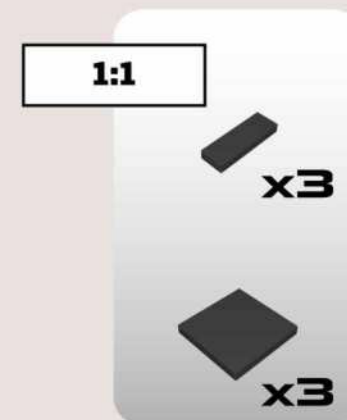
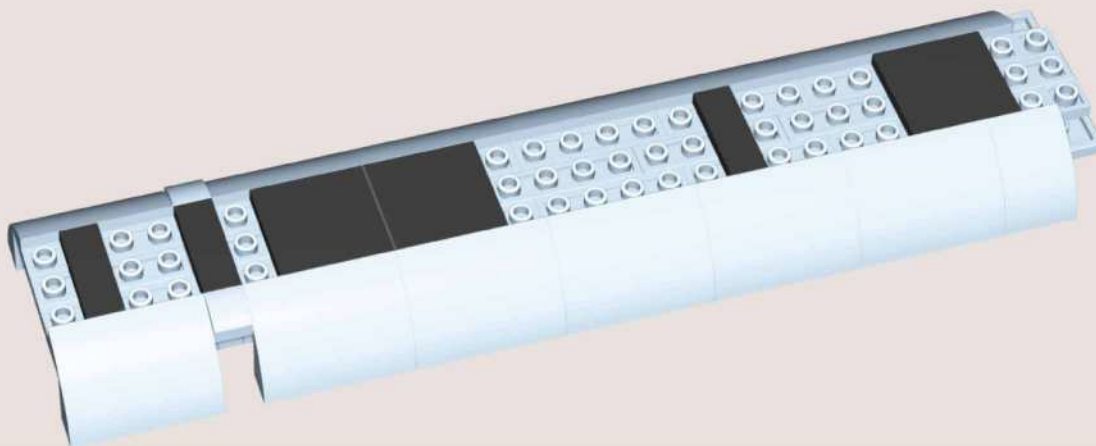

94

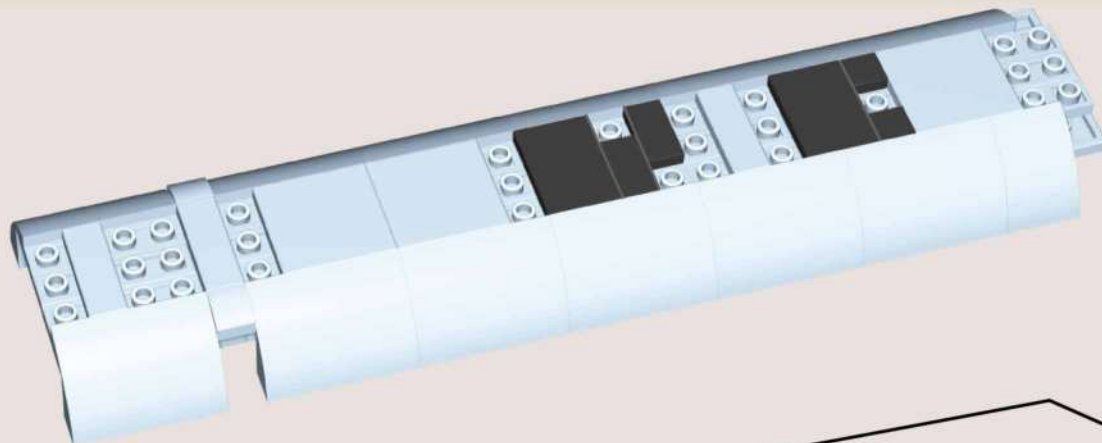

1:1



95



96

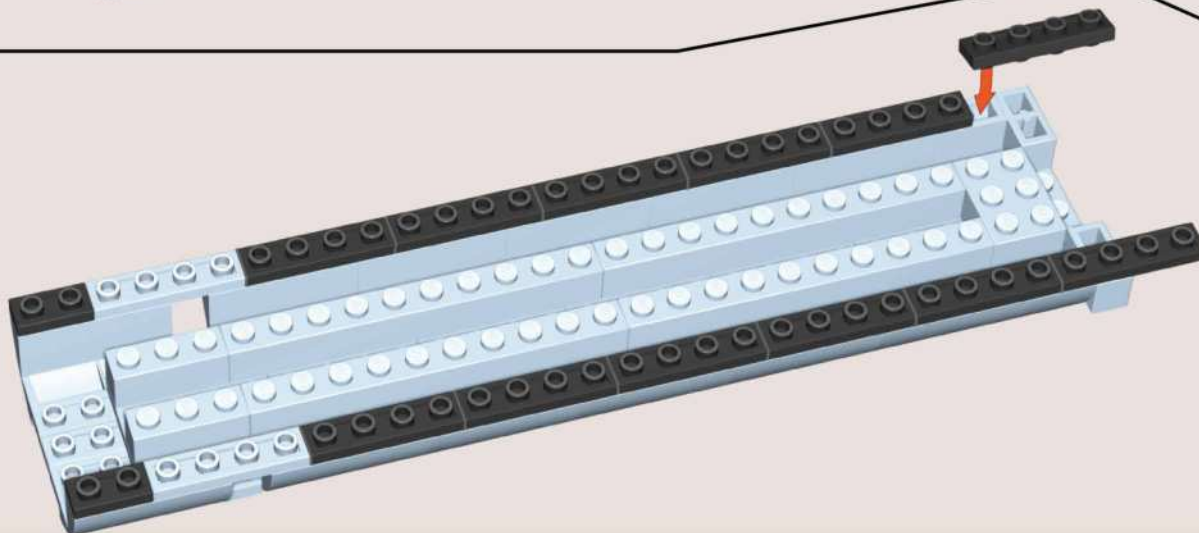

97

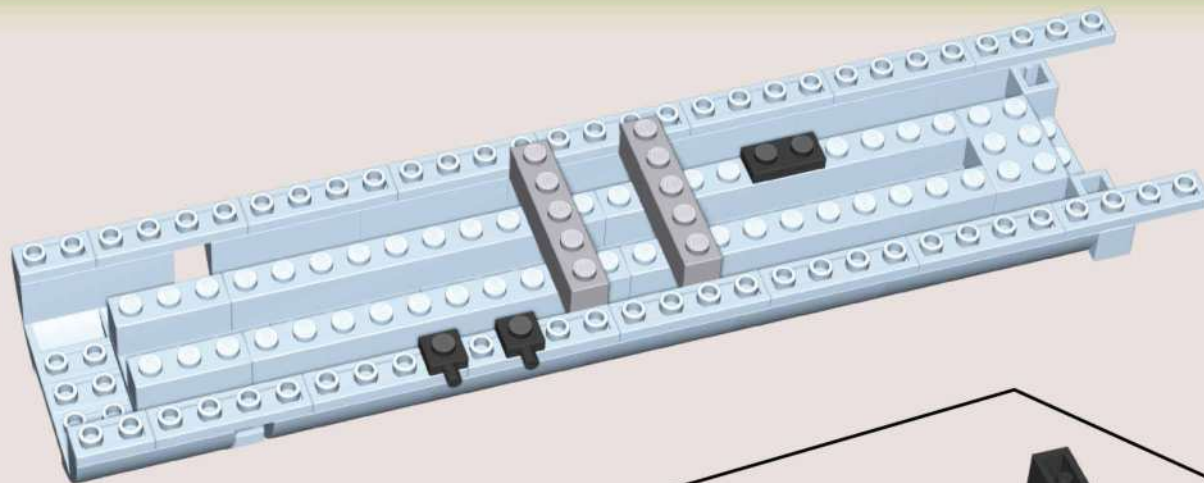

 x2

 x2

 x1

98

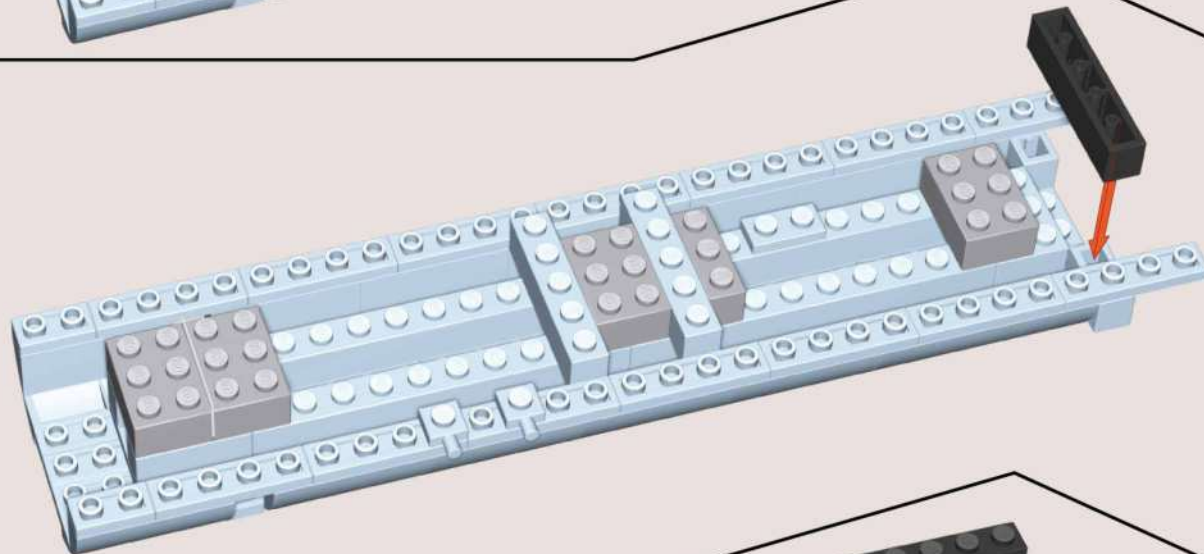

 x4

 x1

 x1

99

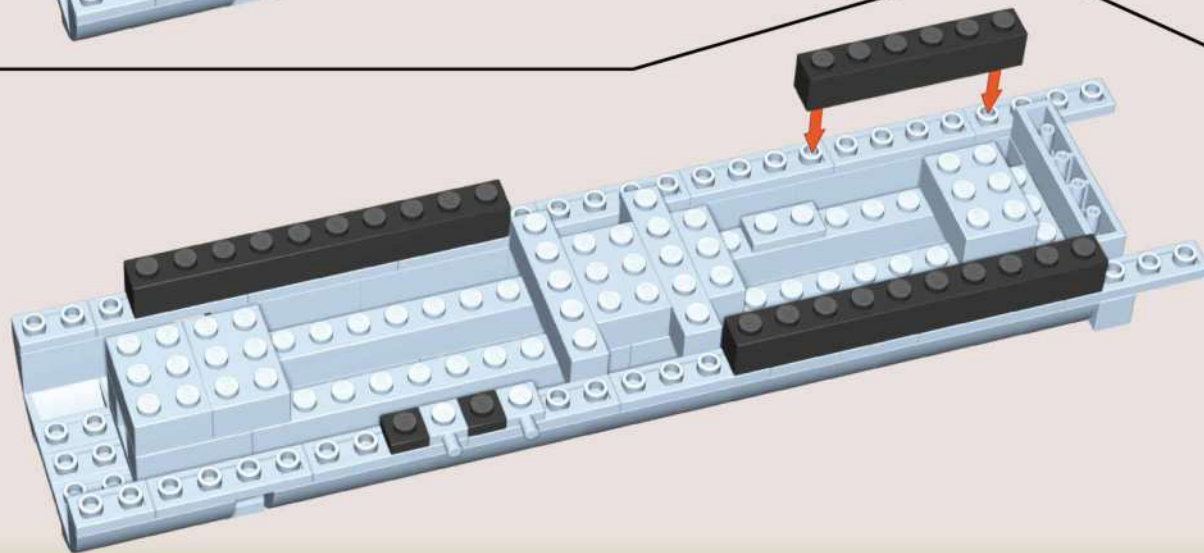

 x2

 x1

 x2

100

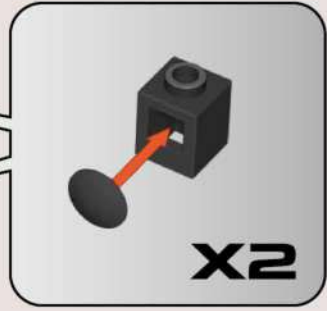
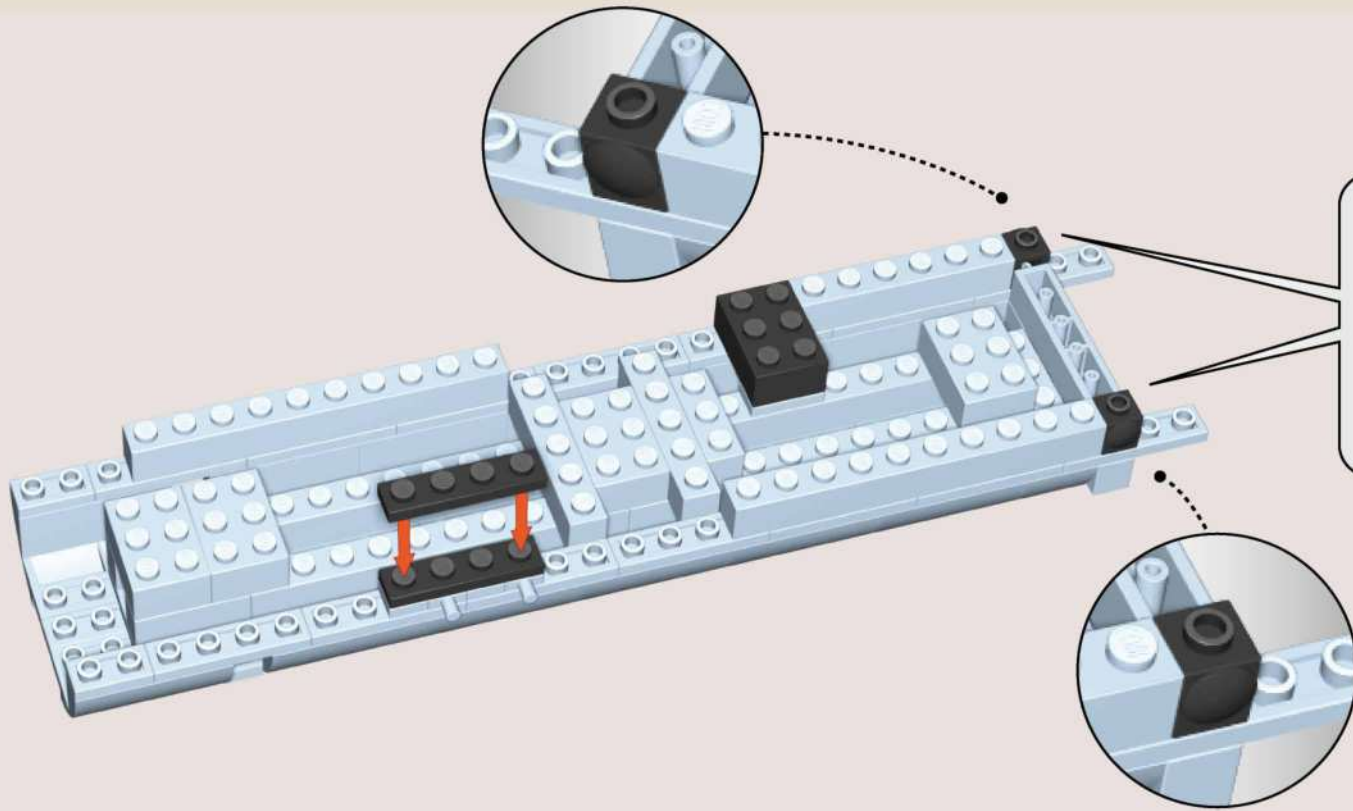

-  x2
-  x1
-  x2
-  x2

101



-  x1
-  x1
-  x3

102

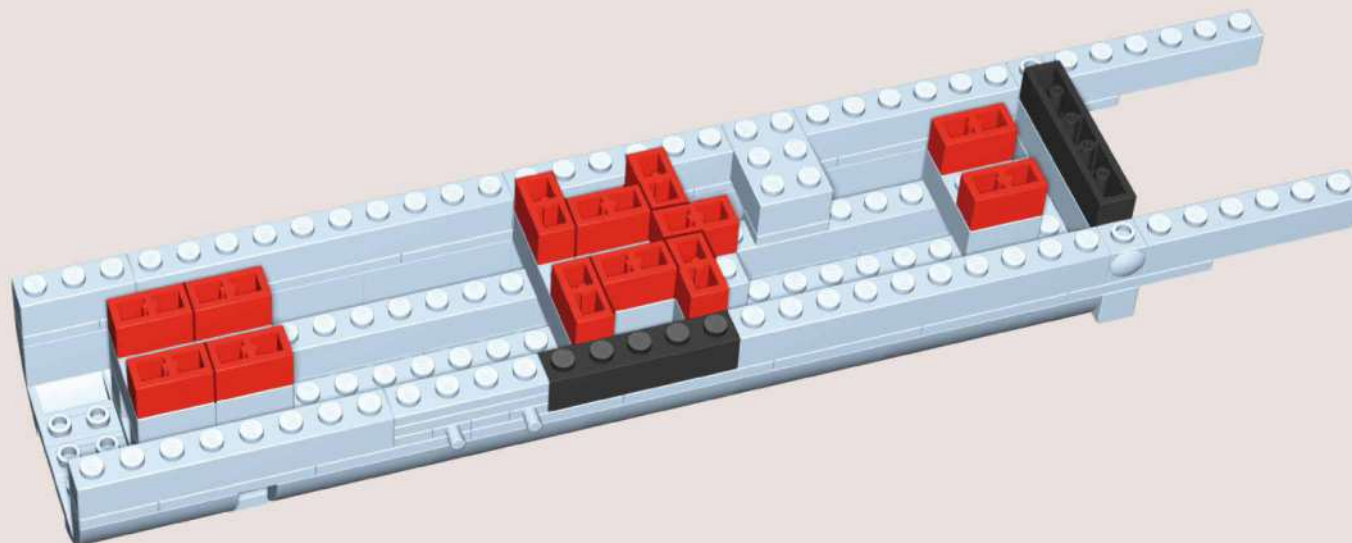

 x13

 x2

103

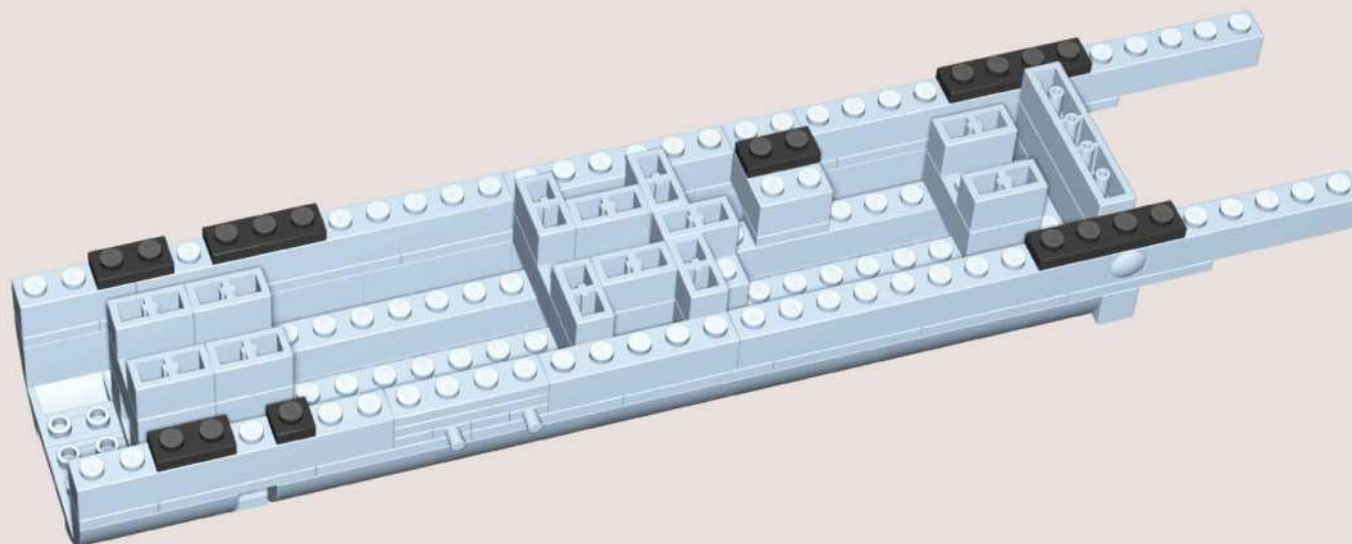

 x3

 x1

 x1

 x2

104

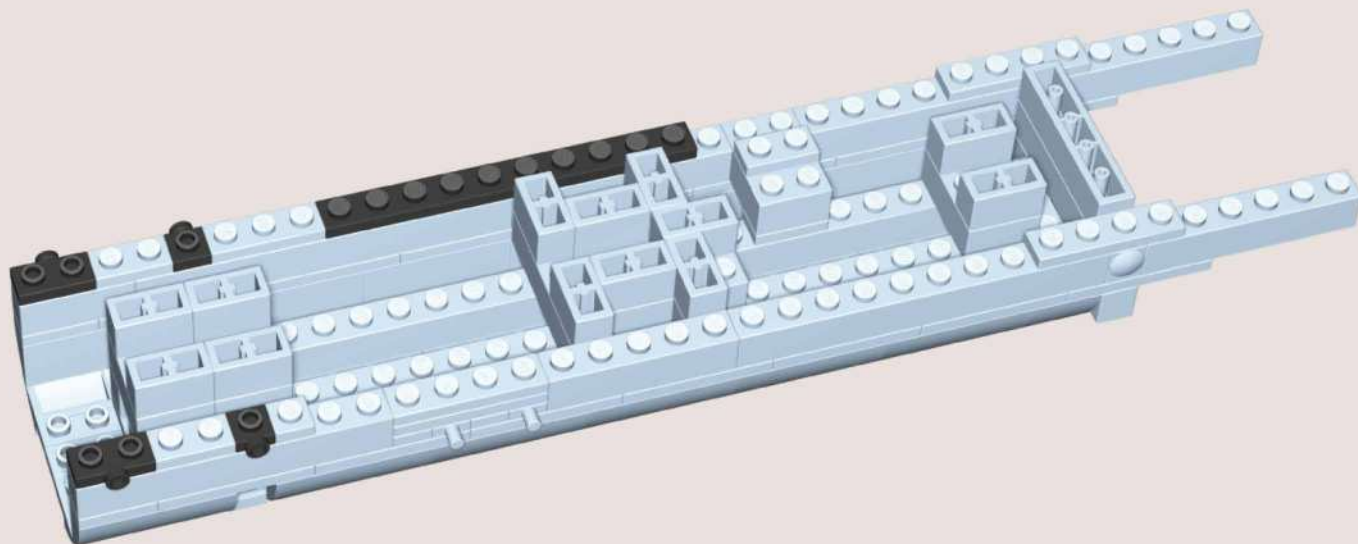

x1



x2



x2

105

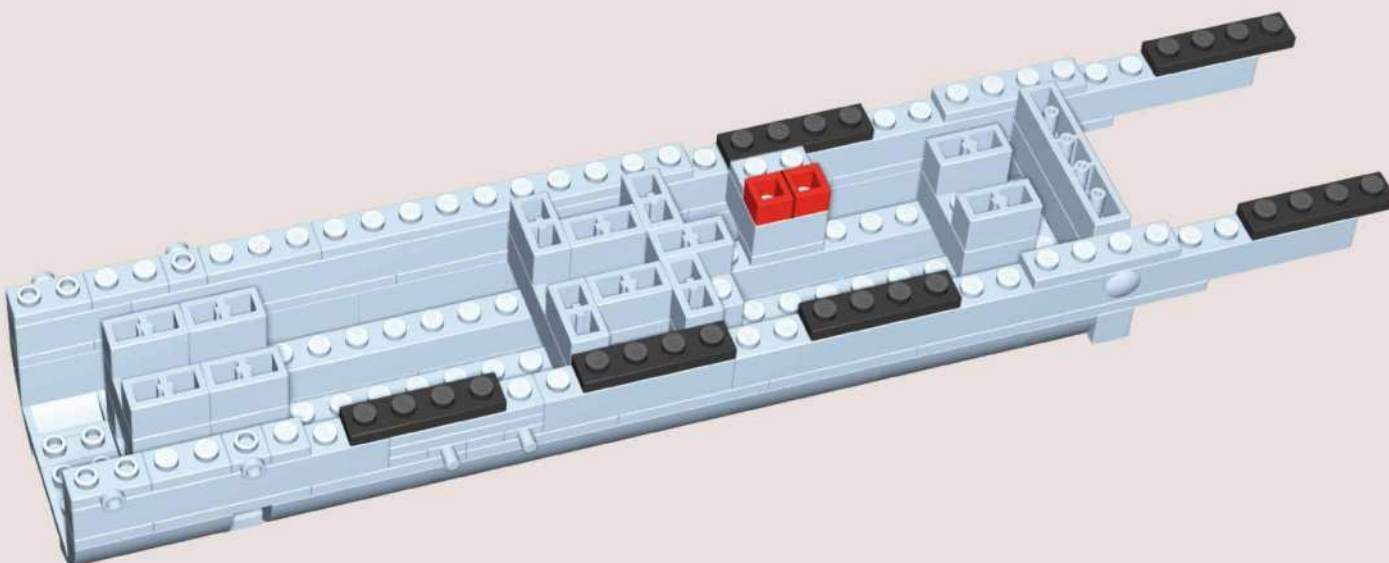

x6



x2

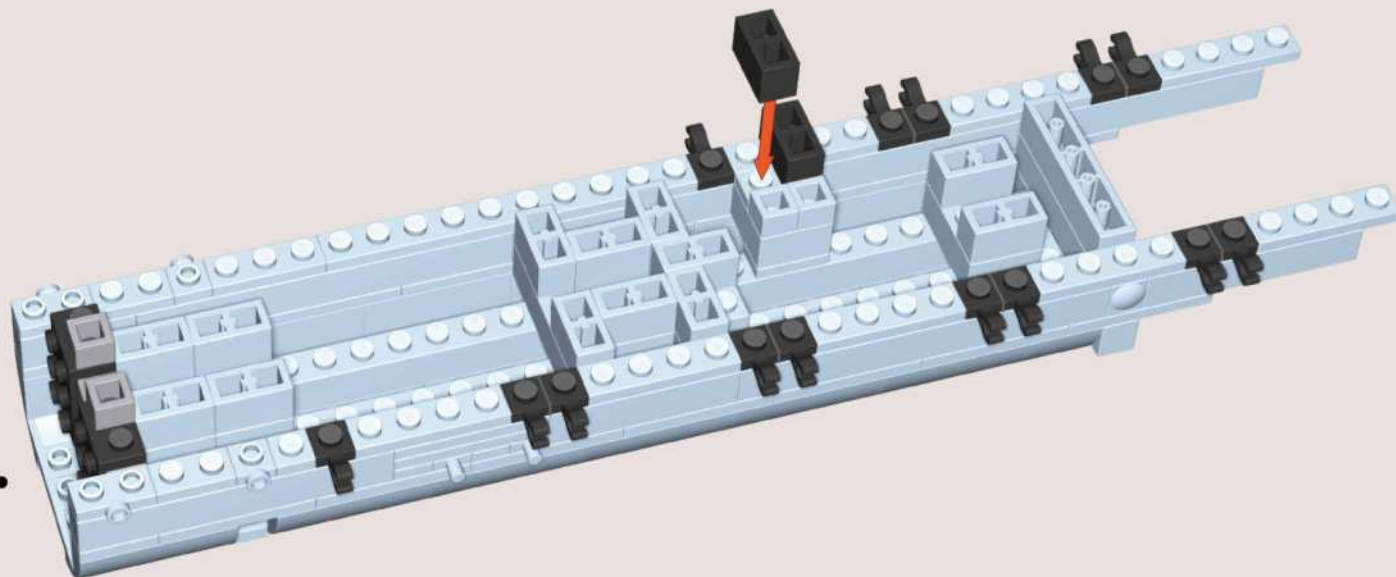
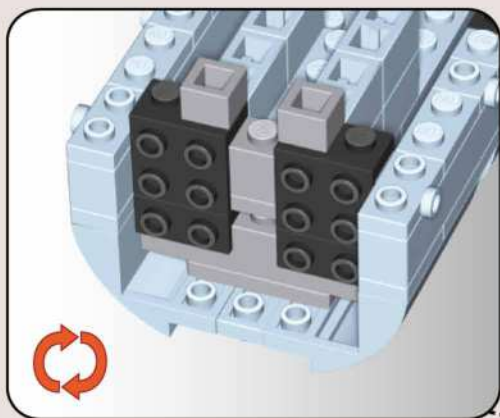
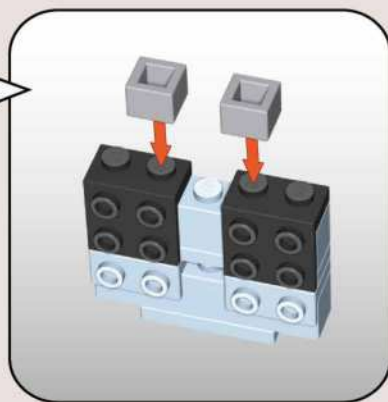
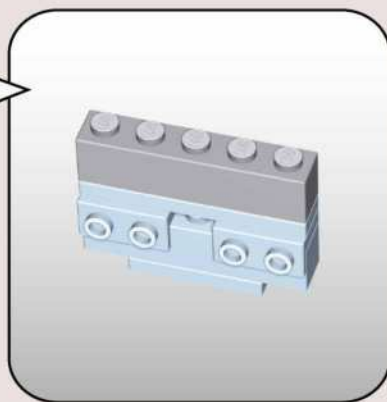
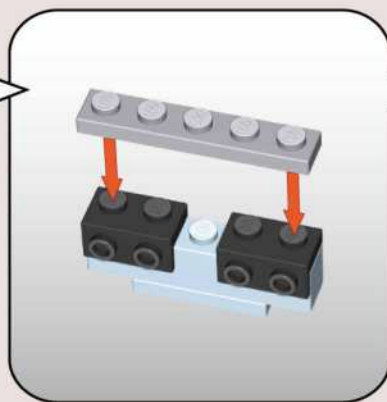
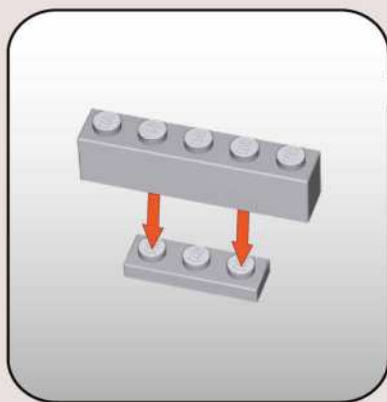

x1



x2



x2



x1



x2



x2



x2



x14

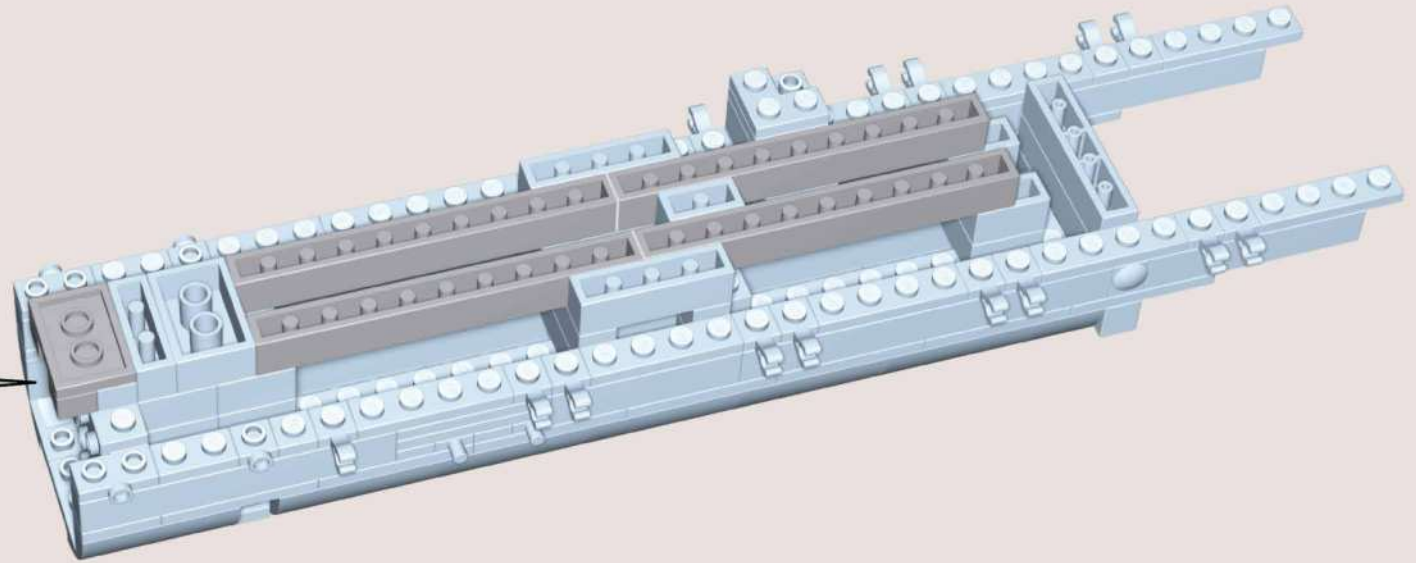
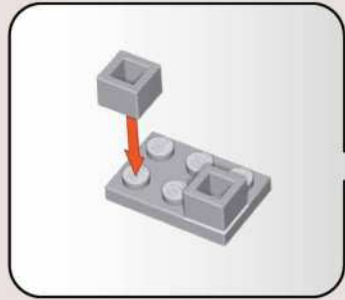

x1



x2



x4

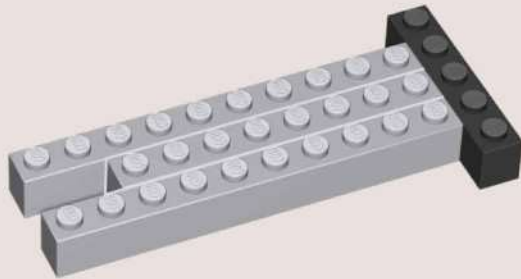

x2



x1



x1

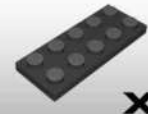

x1

112

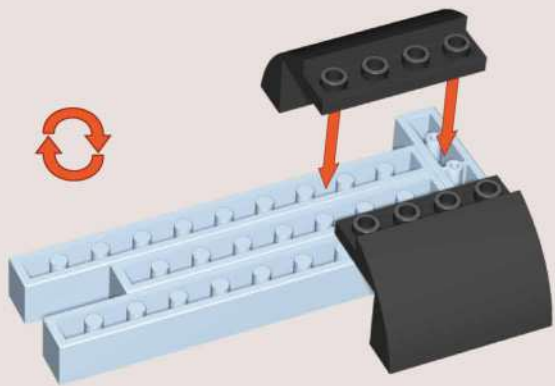

113

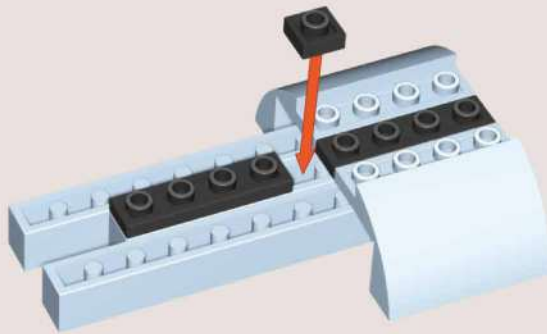

114



115

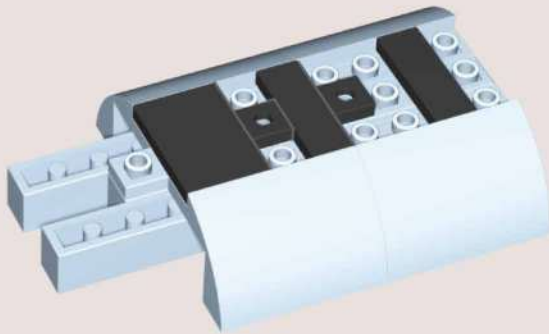

116

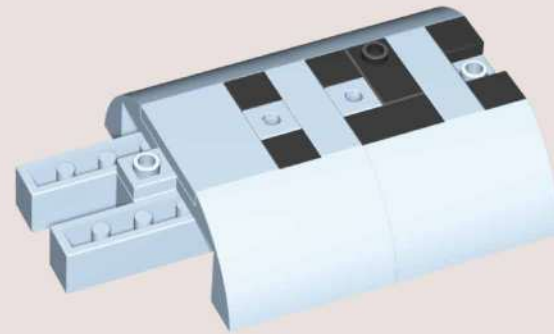

117

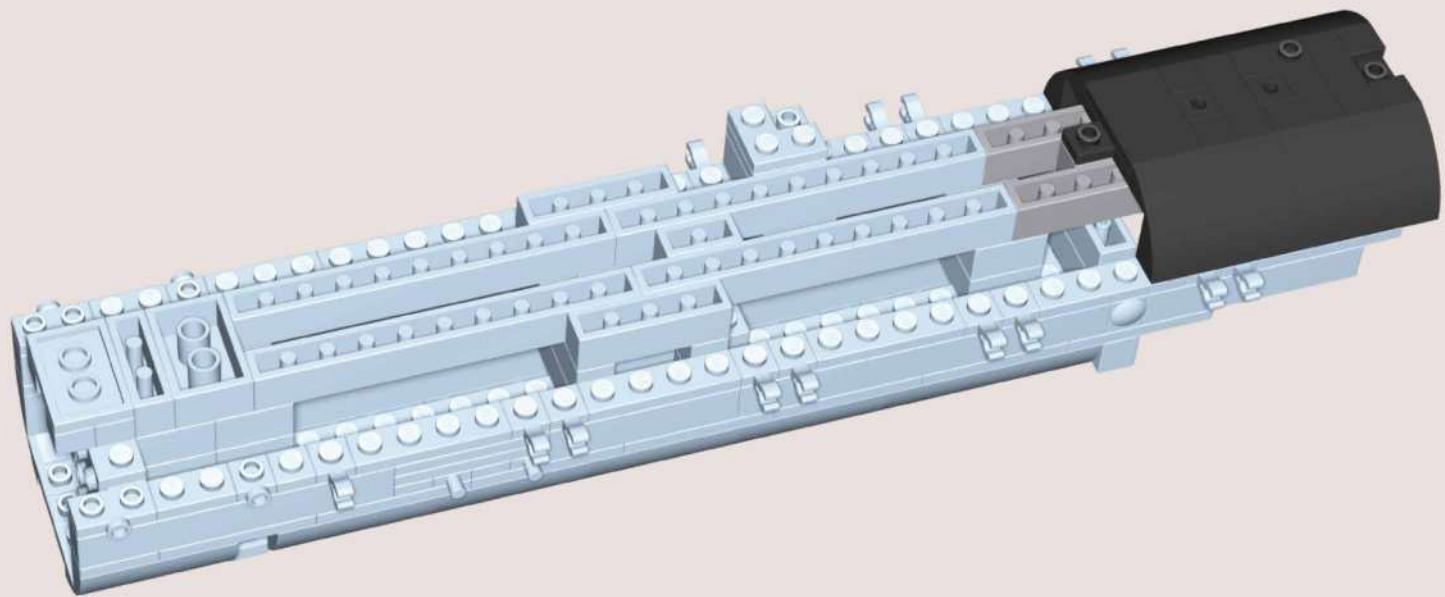

118

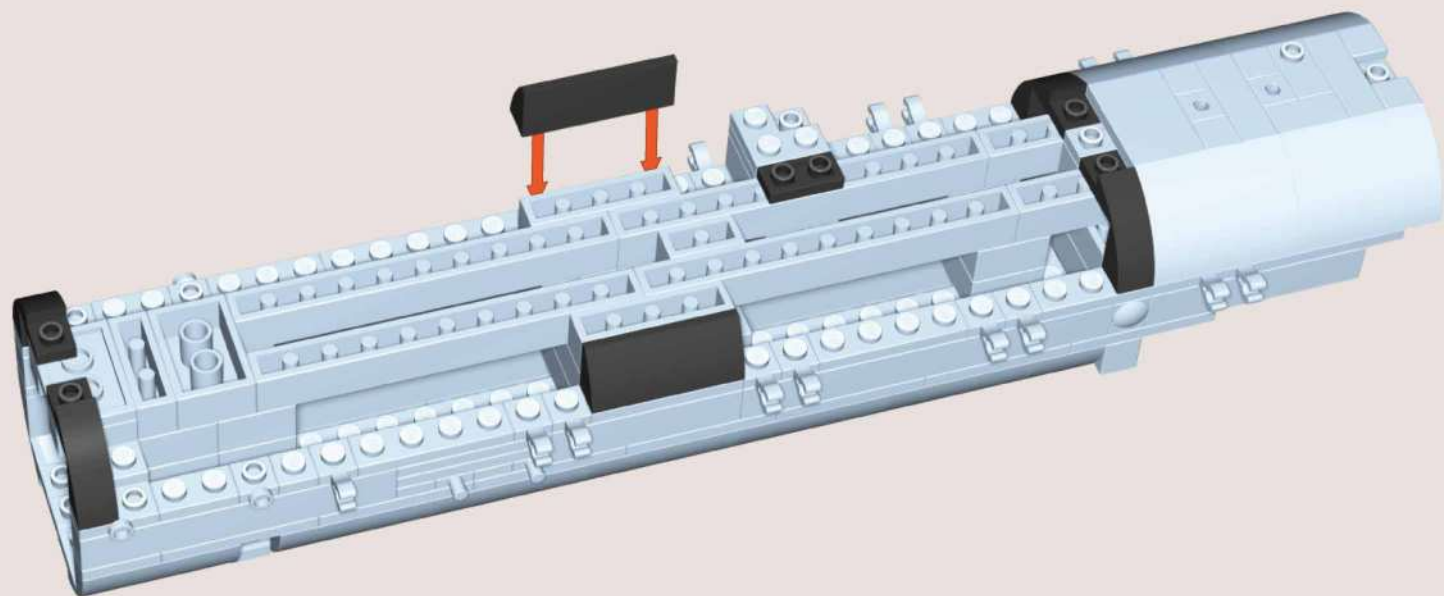

x4



x2



x1

119

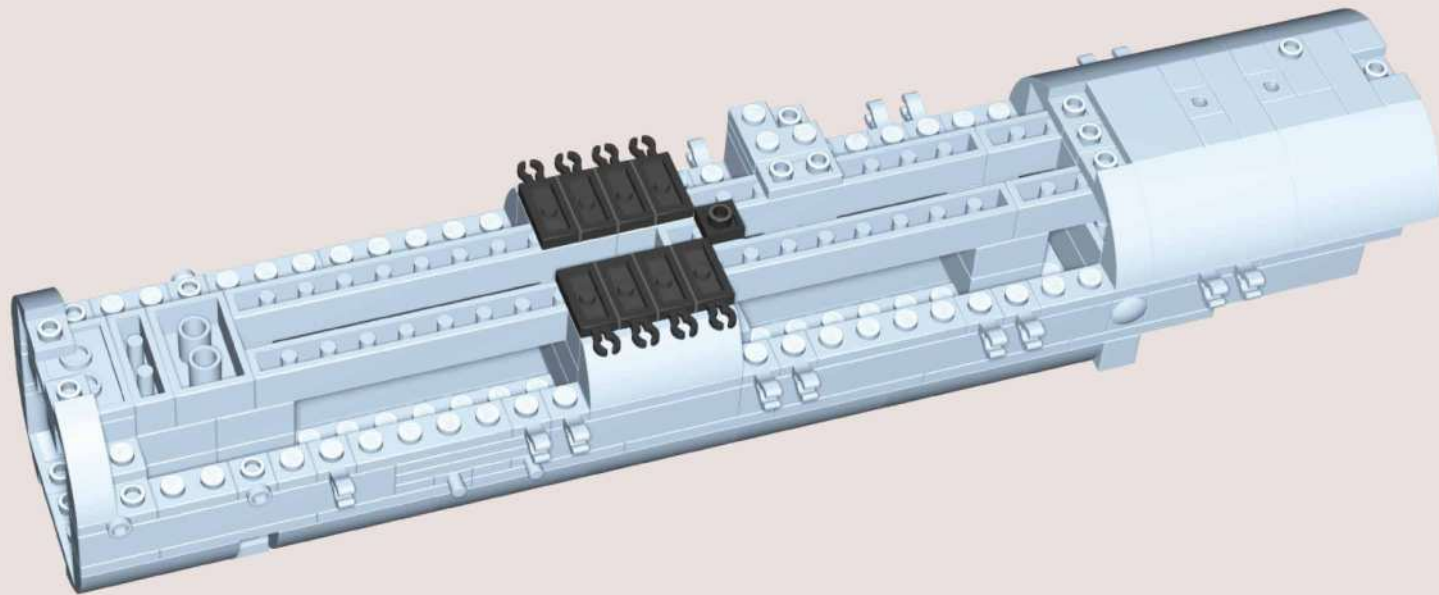

-  x8
-  x1

120

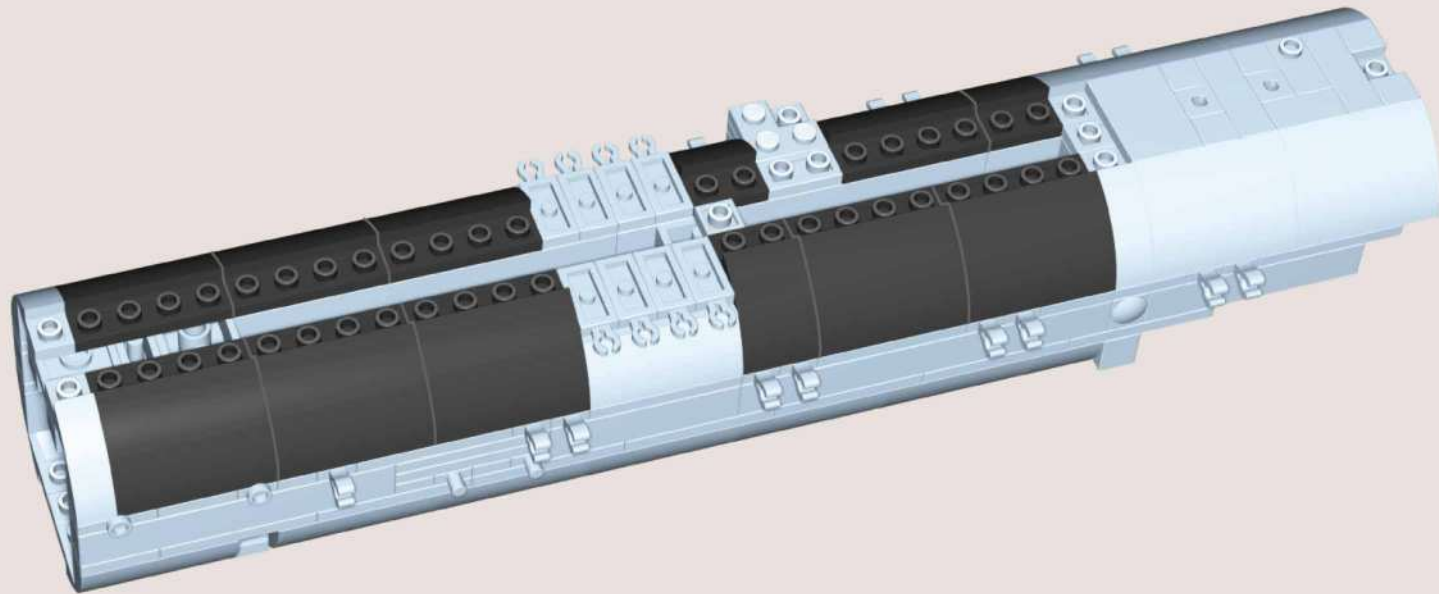

-  x9
-  x3

121

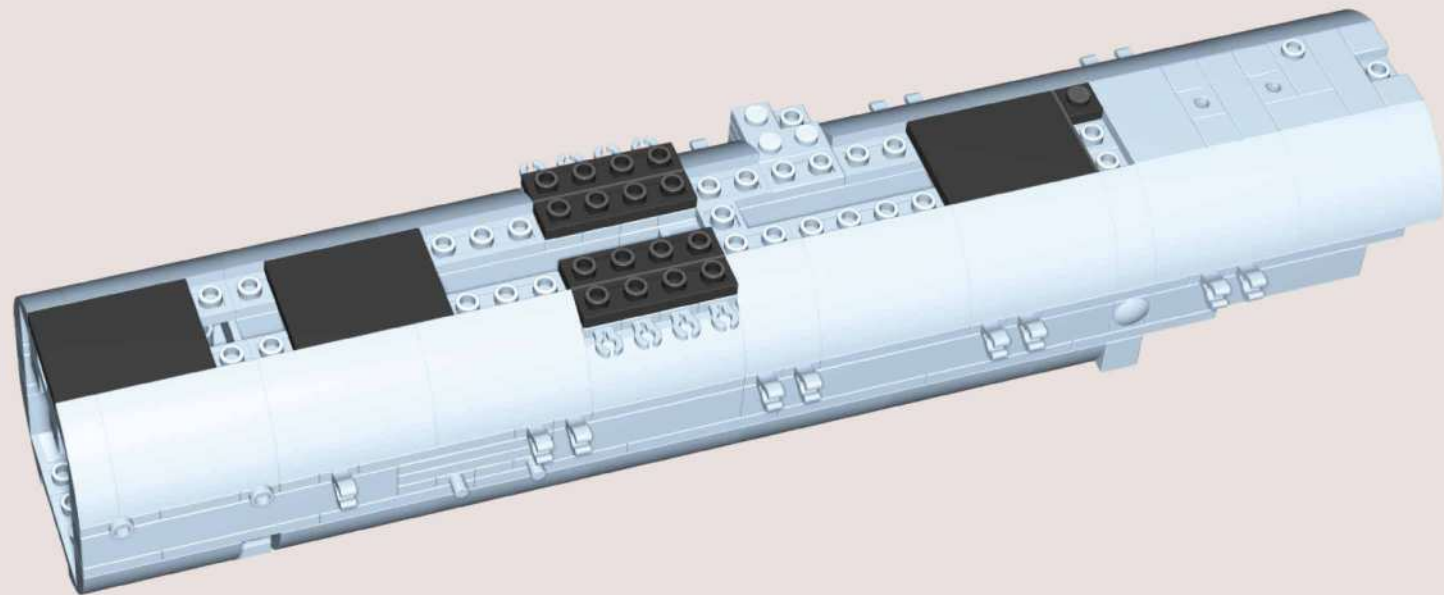

122

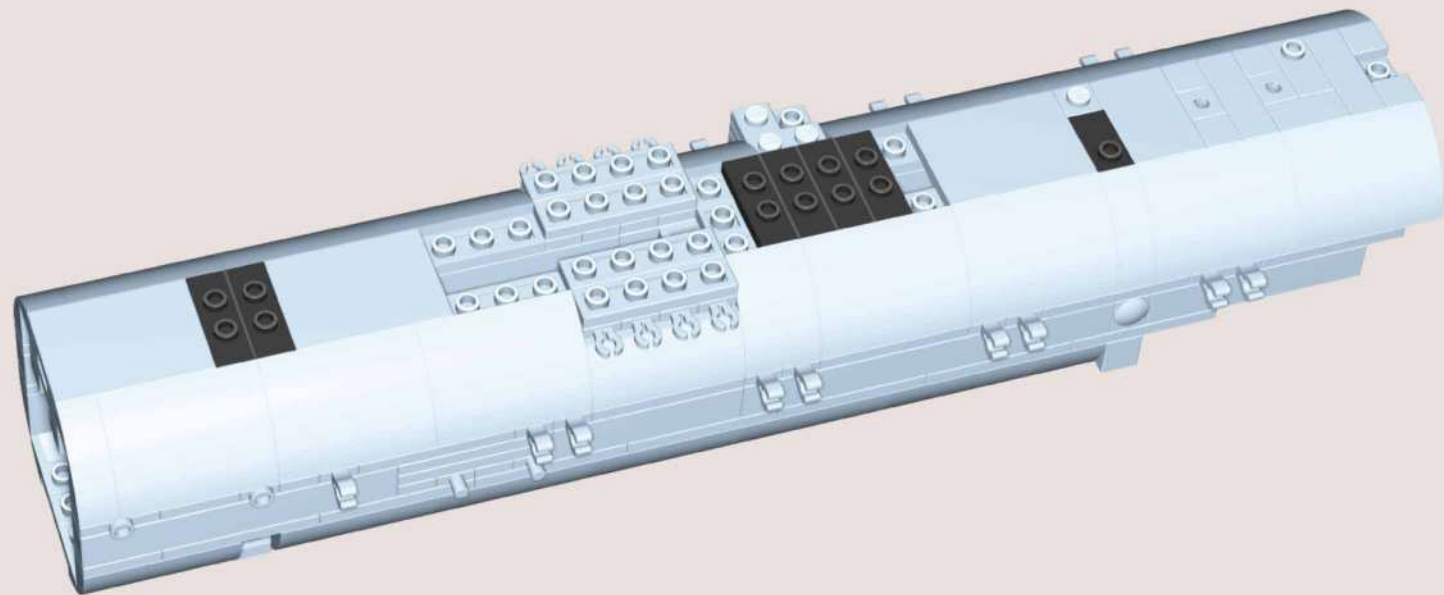

123

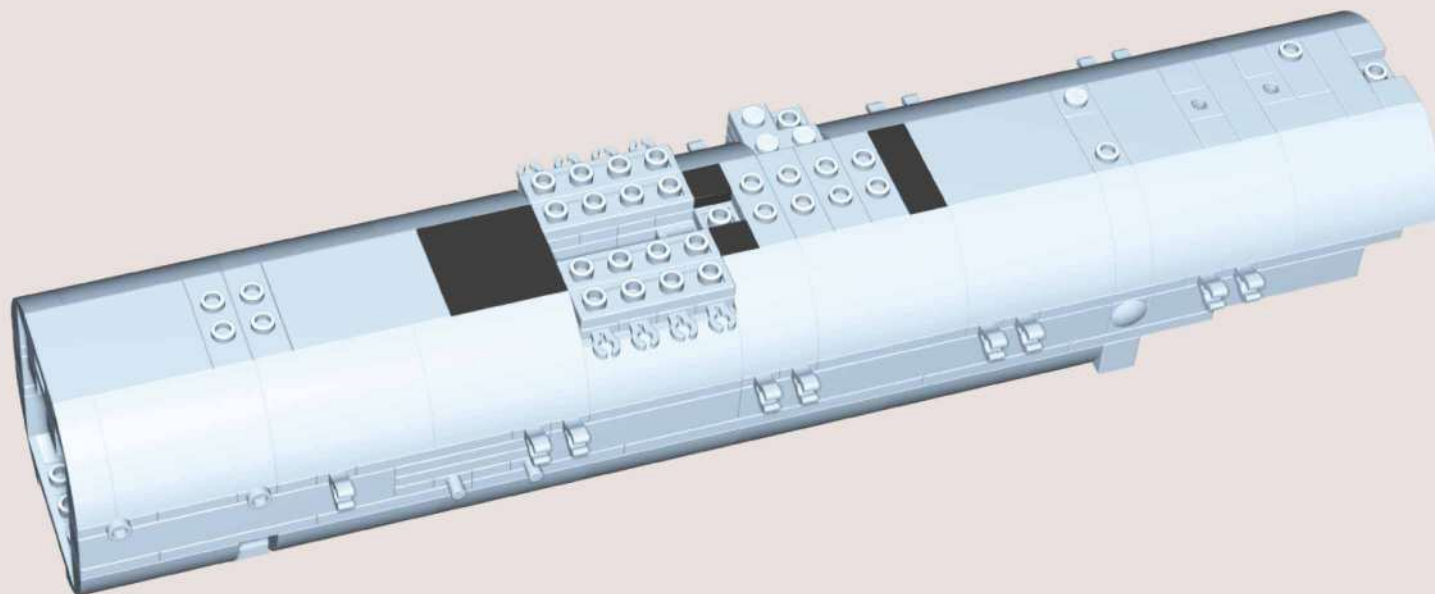

1:1



124

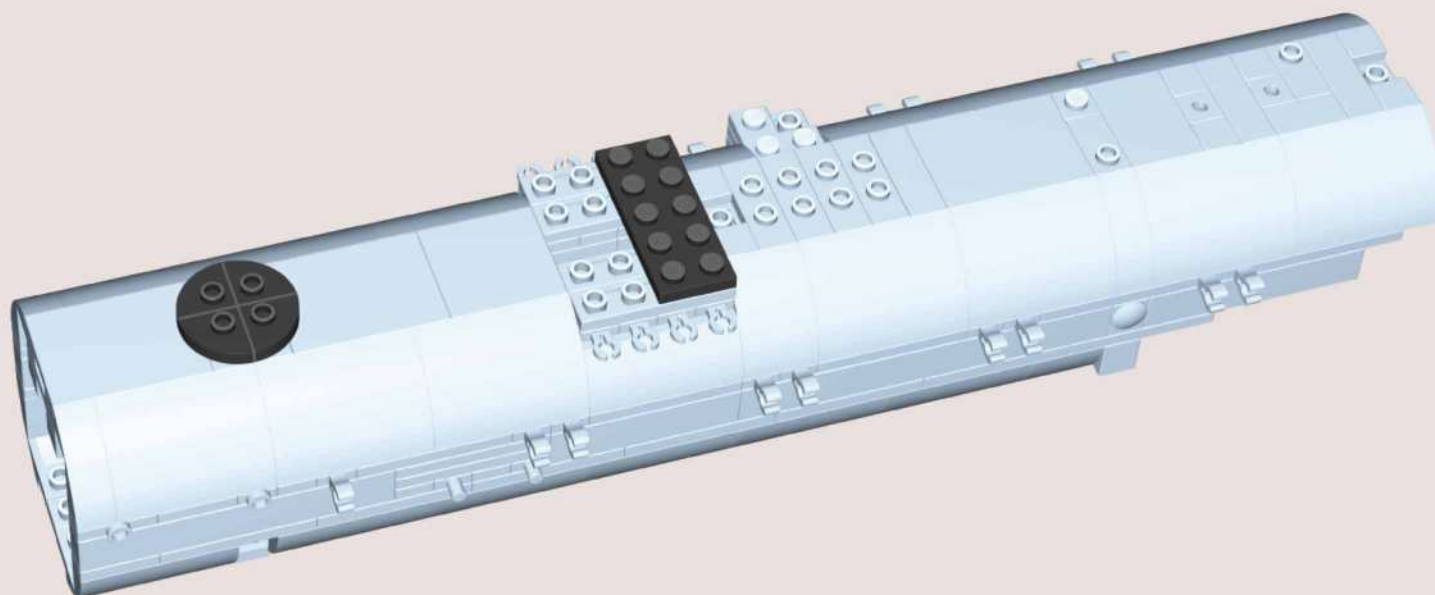

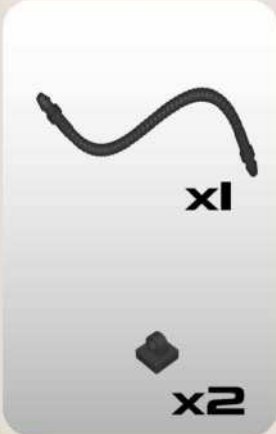
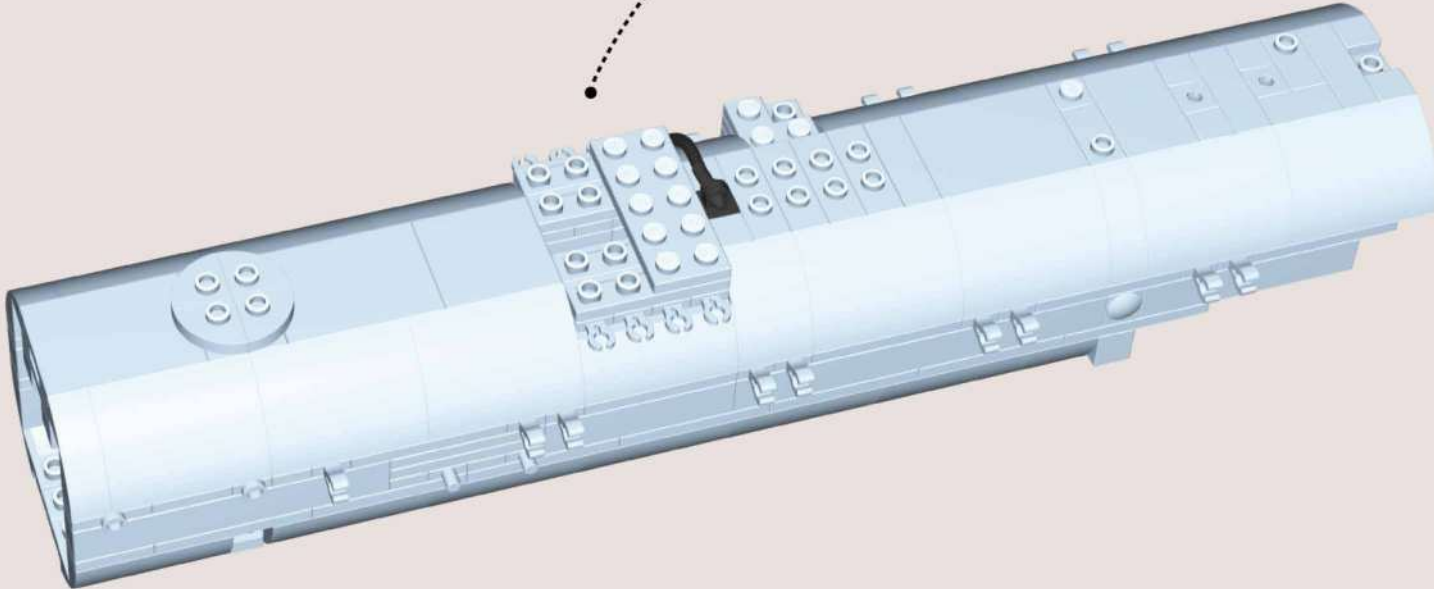
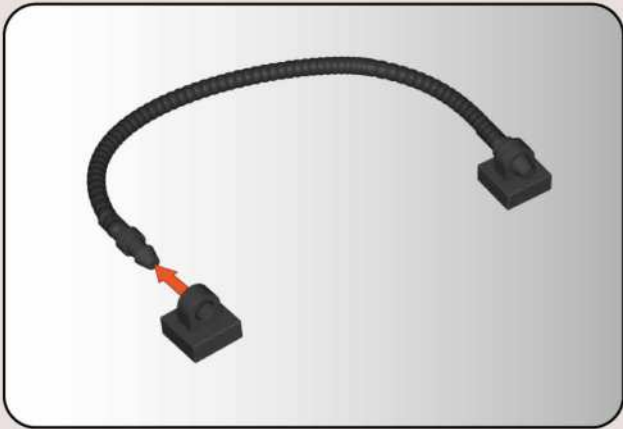

126

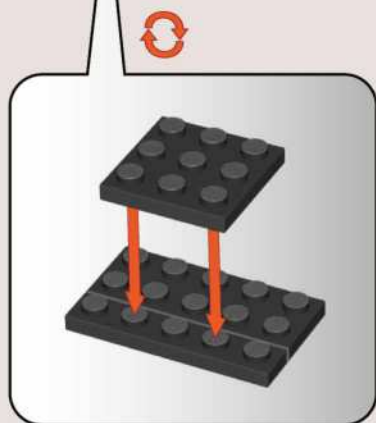

x2



x2

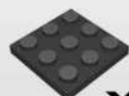

x1



x1

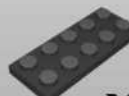

x1

127

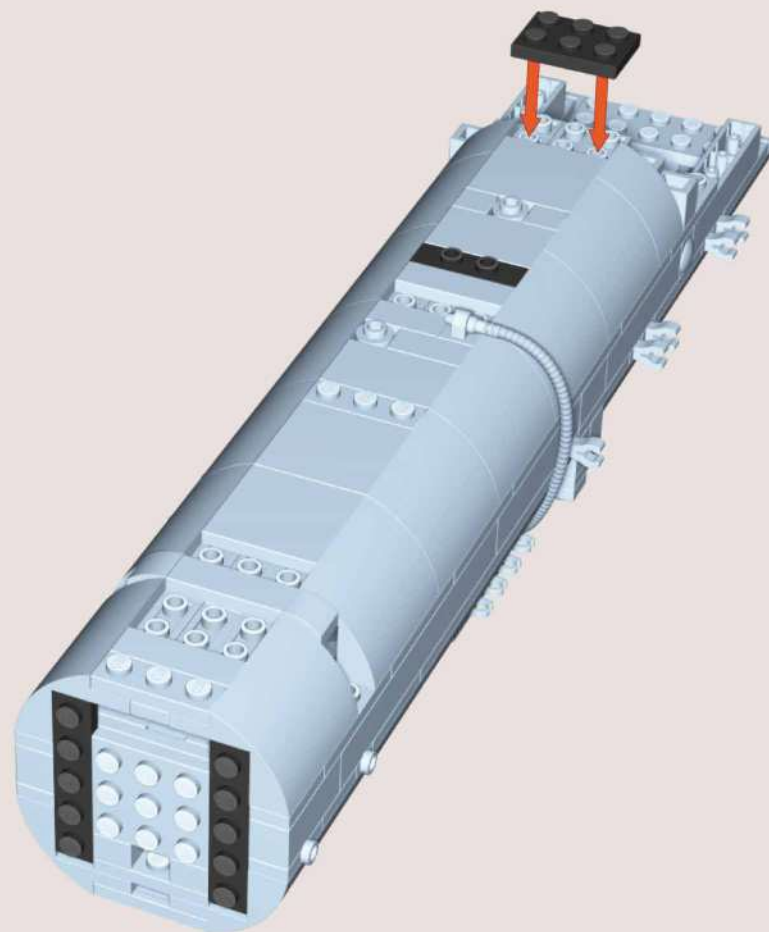

x2



x1

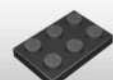

x1

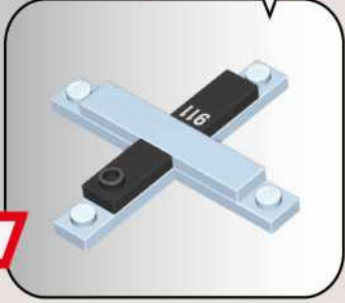
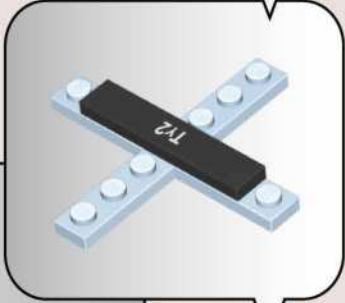
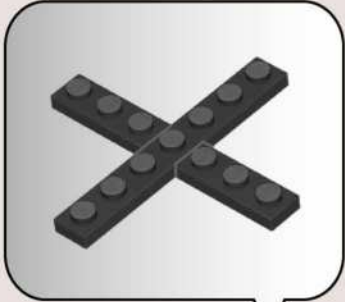
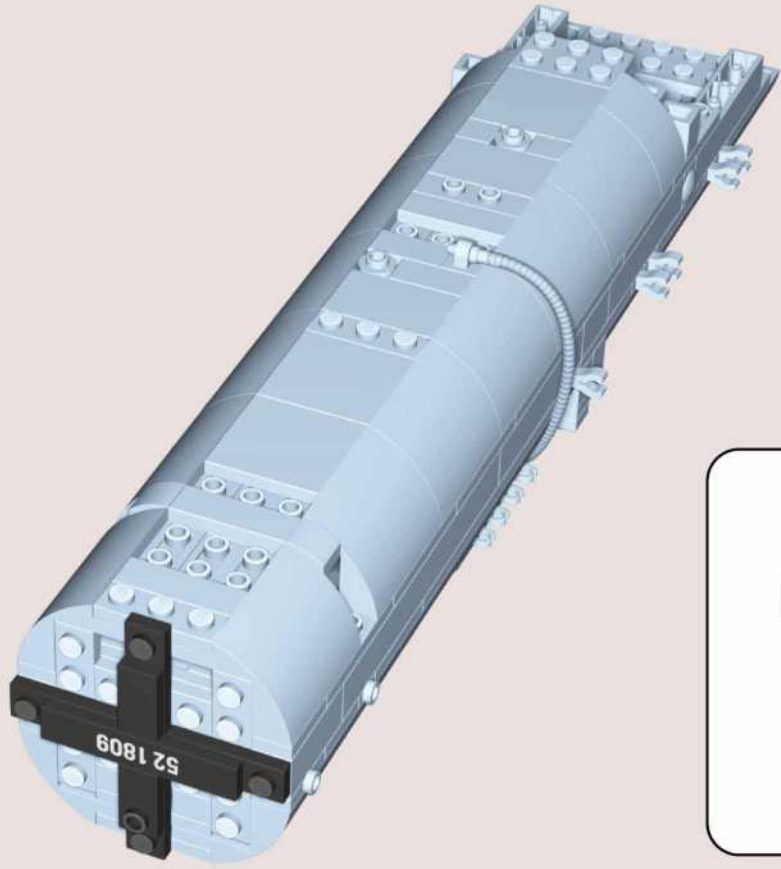
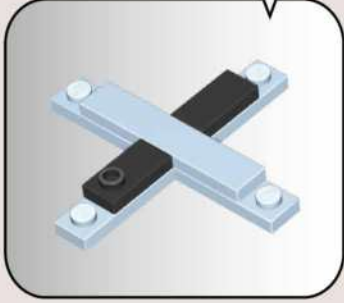
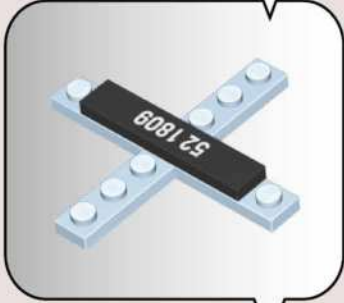
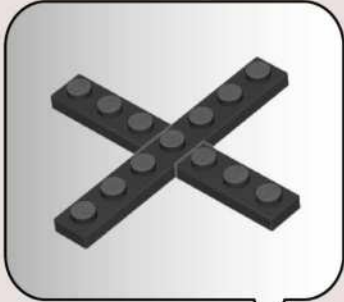

1:1



129

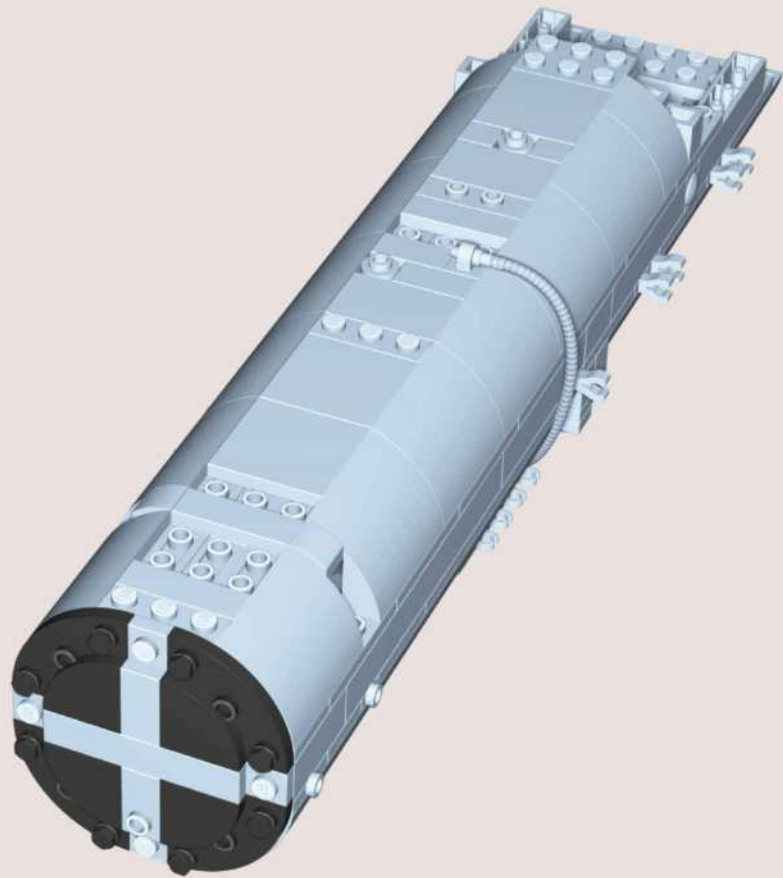

x4



130

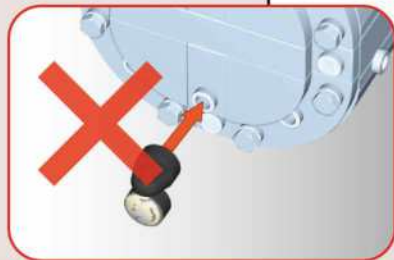

131

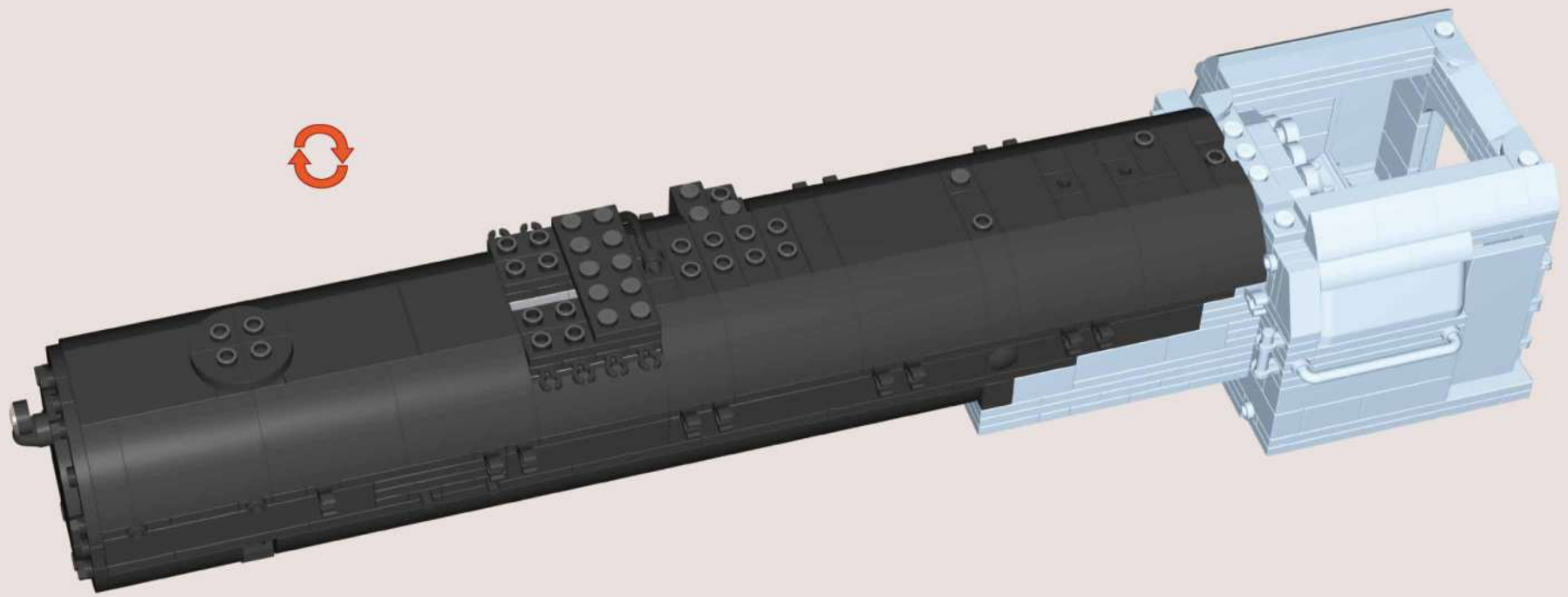

132

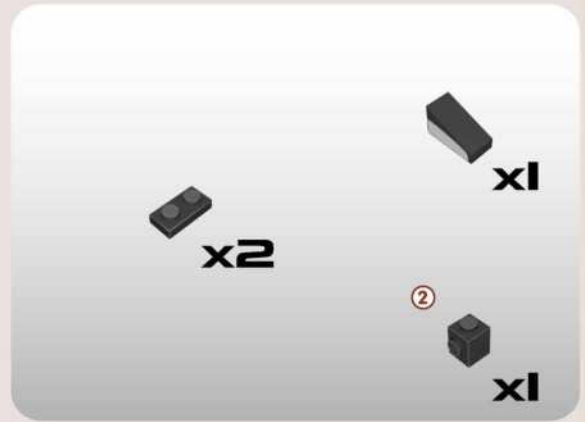
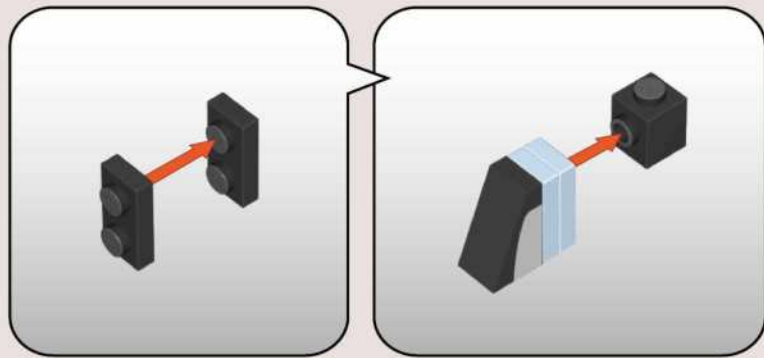

133

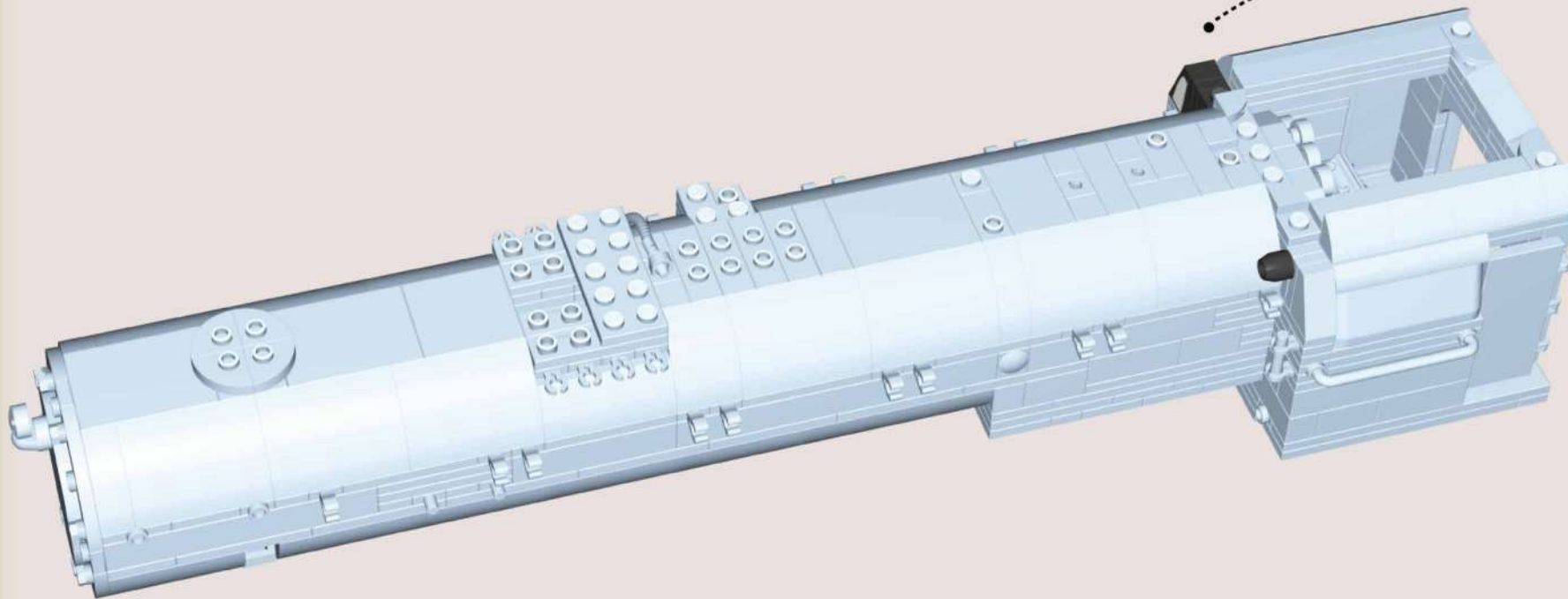

134



135



136

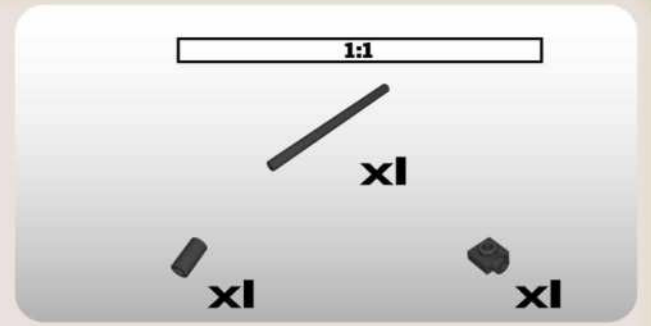
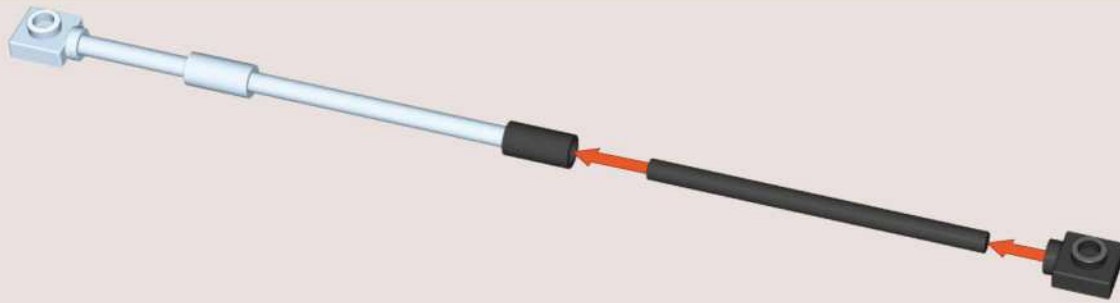

137

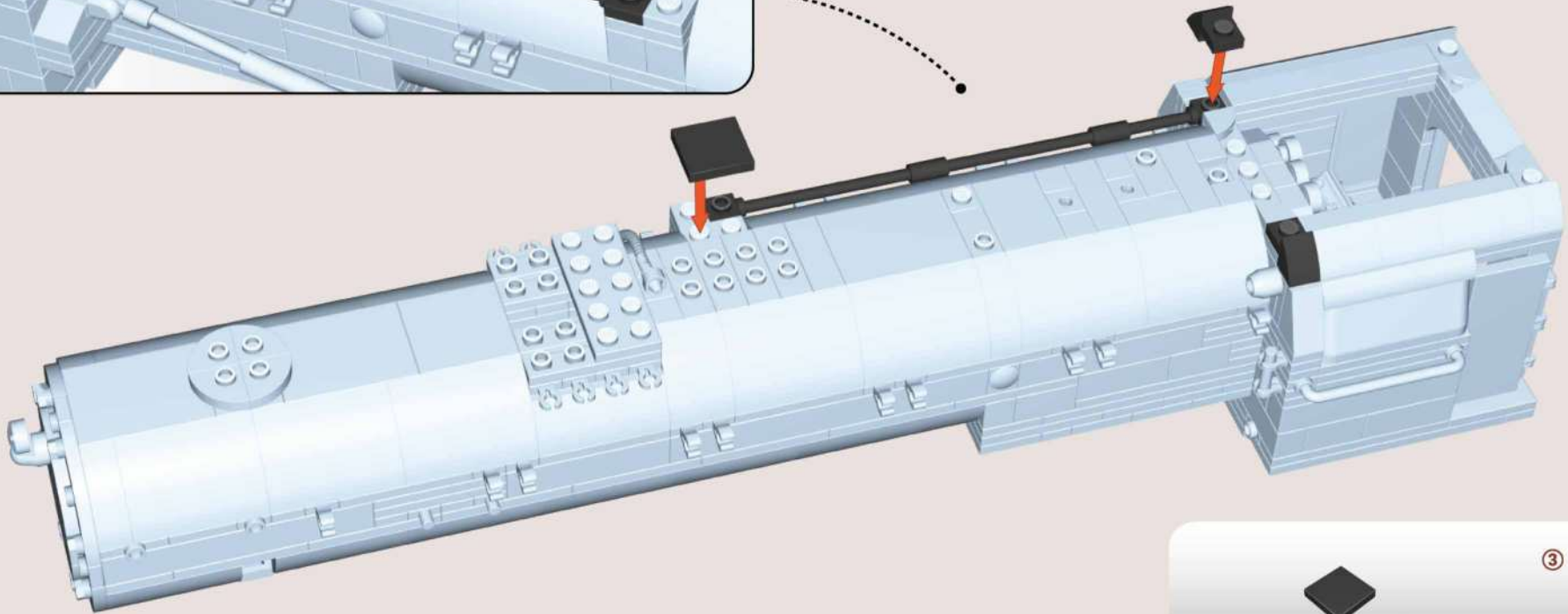
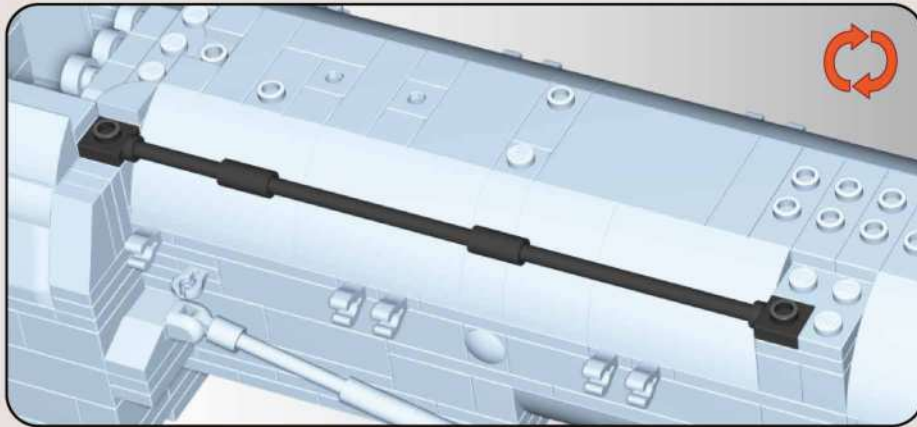



HISTORICAL COLLECTION



CROMWELL MK.IV
2269



H.M.C M8 SCOTT
2279



15cm NEBELWERFER 41
2291



ZiS-3 SOVIET GUN
2293



Sd.Kfz.7 HALF-TRACK
2275



SHERMAN IC FIREFLY HYBRID
2276