

HISTORICAL COLLECTION

WORLD WAR II



BATTLESHIP TIRPITZ

PLACE OF ORIGIN - GERMANY
 TYPE - BISMARCK-CLASS BATTLESHIP
 LAUNCHED - 1 APRIL 1939
 COMMISSIONED - 25 FEBRUARY 1941
 FATE - SUNK, 12 NOVEMBER 1944
 DISPLACEMENT - 42900t (94,578,310LB)
 LENGTH - 251M (823' 6")
 BEAM - 36M (118' 1")
 INSTALLED POWER - 12x WAGNER WATER-TUBE BOILERS
 160796SHP (119905kW)
 PROPULSION - 3x SCREW PROPELLERS, 3x STEAM TURBINES
 ARMAMENT - 8x 38cm (15") L/52 SK C/34
 12x 15cm (5.9") L/55 SK C/28
 16x 10,5cm (4.1") FLAK SK C/33
 16x 3,7cm (1.45") SK C/30
 12x 2cm (.787") FLAK 30
 AIRCRAFT CARRIED - 4x ARADO AR 196 FLOATPLANES
 AVIATION DEVICES - 1x DOUBLE-ENDED CATAPULT
 SPEED - 30KNOTS (56KM/H, 35MPH)
 RANGE - 8870NMI (16430 KM, 10210MI)
 CREW - 2608



PAD PRINTED
NO STICKERS

Printed in EU



4839



WARNING: CHOKING HAZARD-
Toy contains small parts.
Not for children under 3 years.

2810 

BATTLESHIP TIRPITZ

SCALE **1:300**



+



+



+



BE CAREFUL: NOTICE THE DIFFERENCE

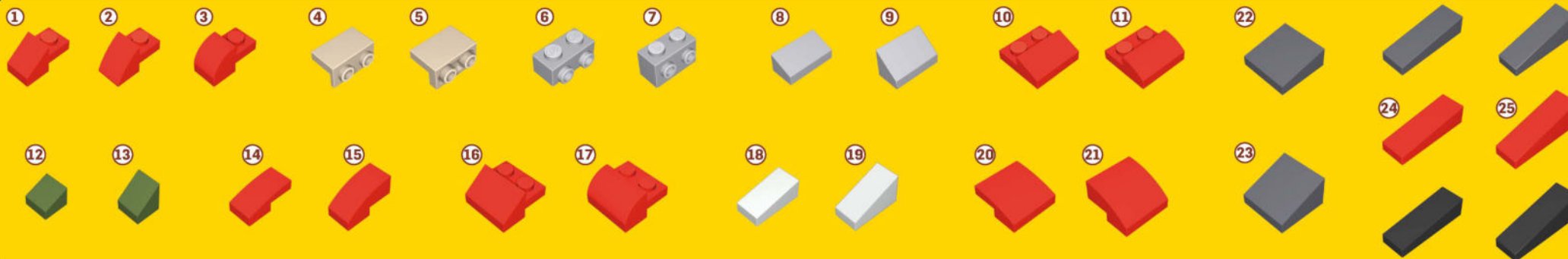

UWAGA: RÓŻNE KLOCKI



1

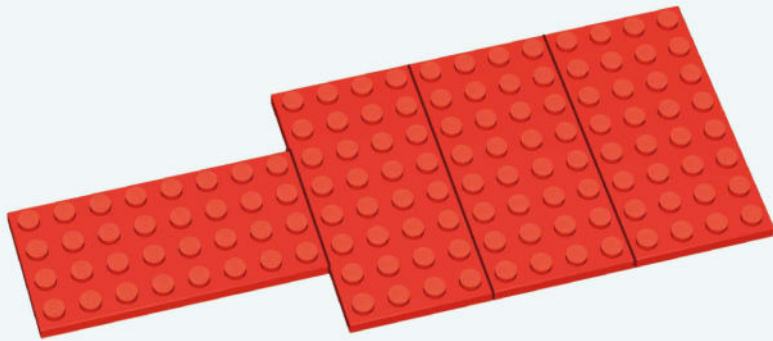

x4

2

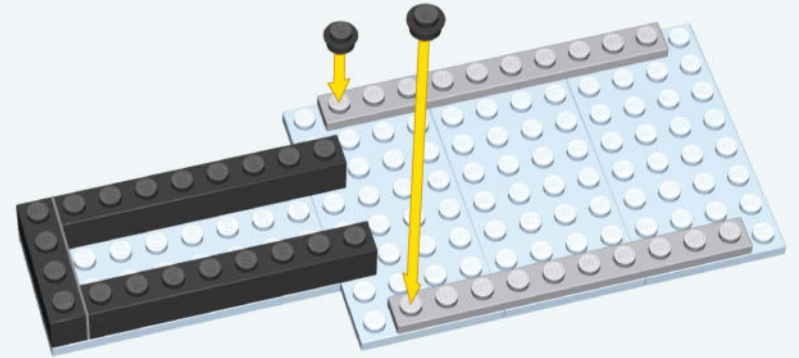

x1



x2



x2



x2

3

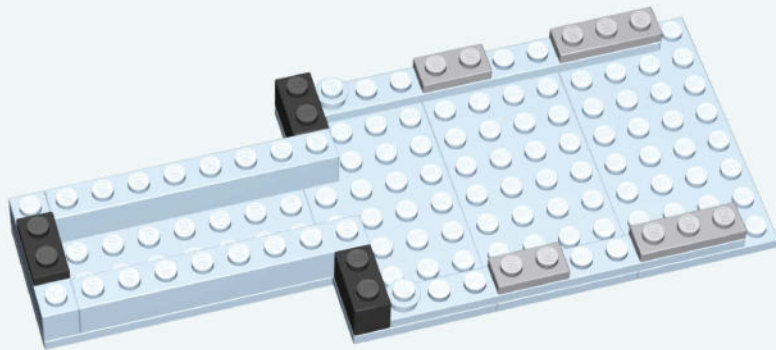

x1



x2



x2



x2

4

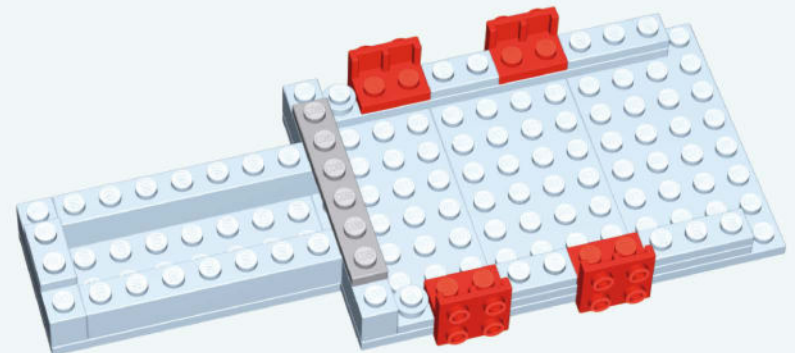

x1



x4

5

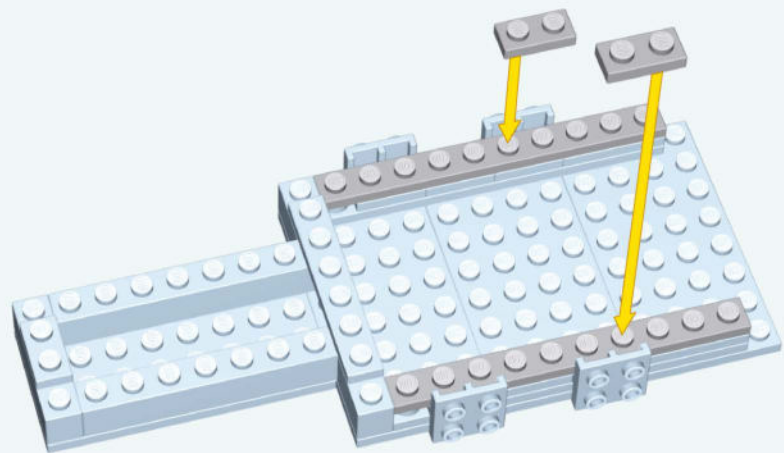

6

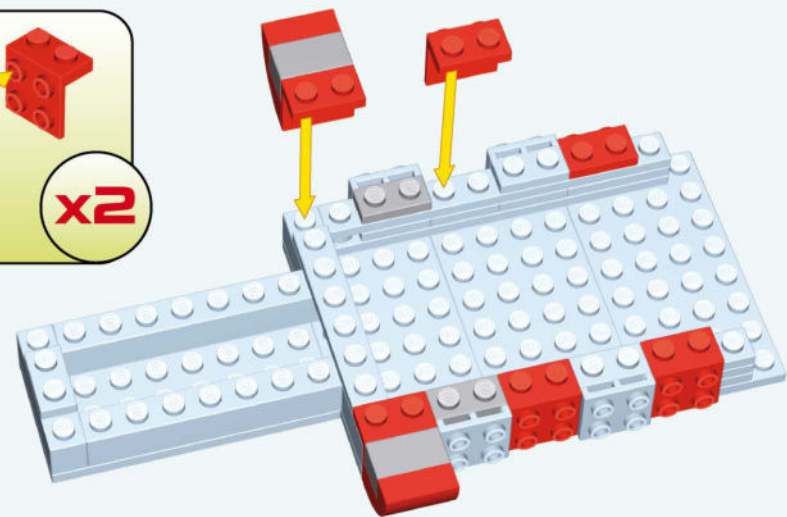
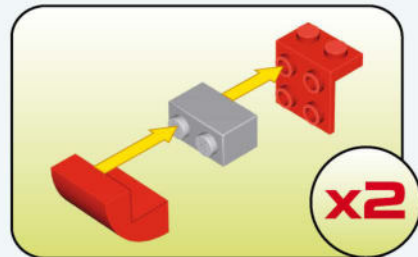

7

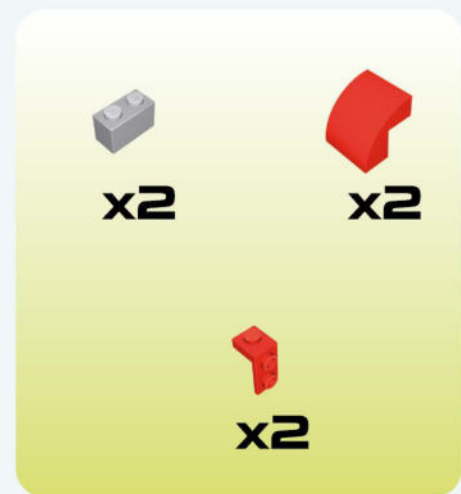
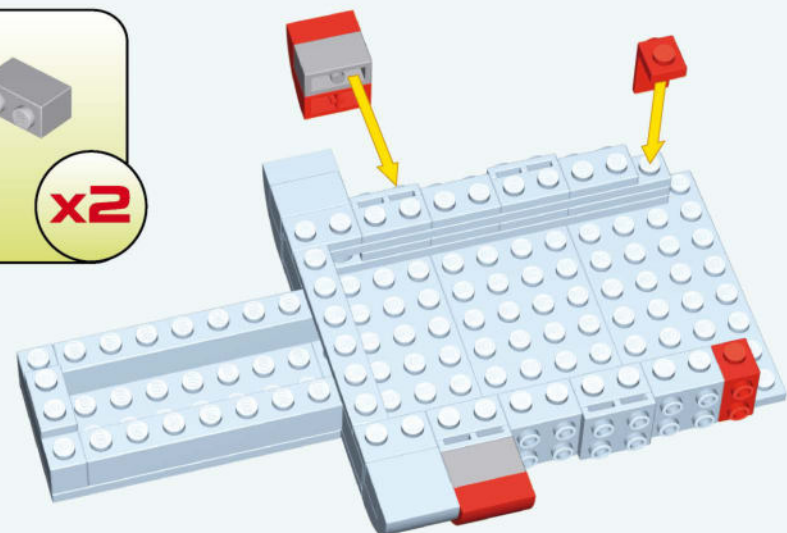
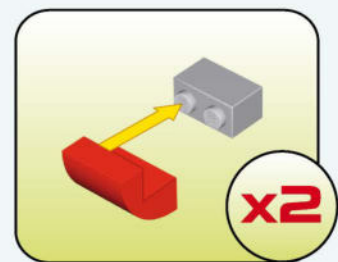

8

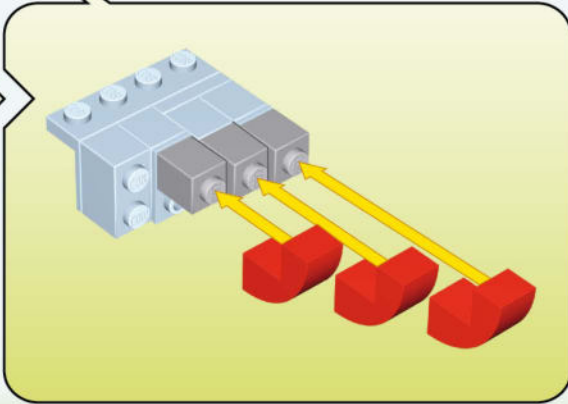
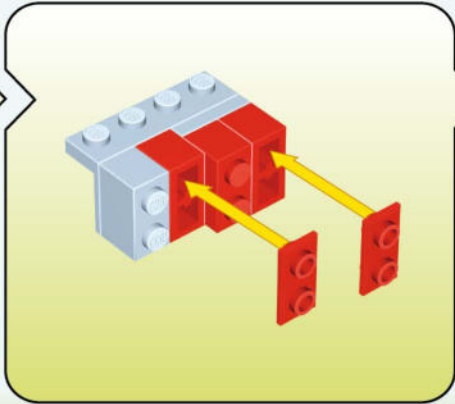
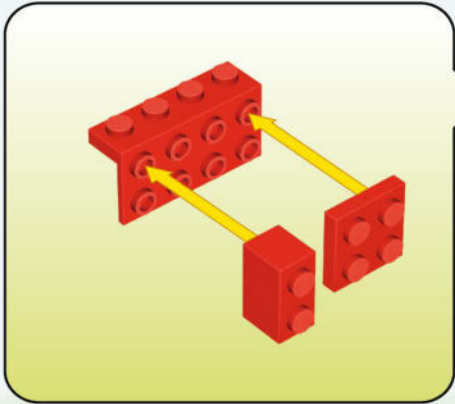
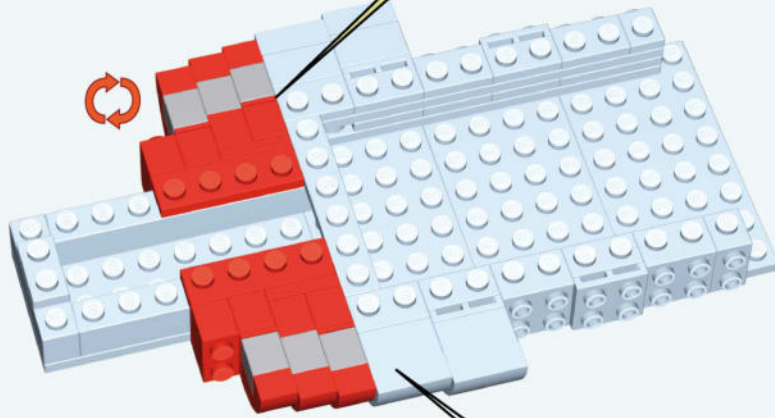
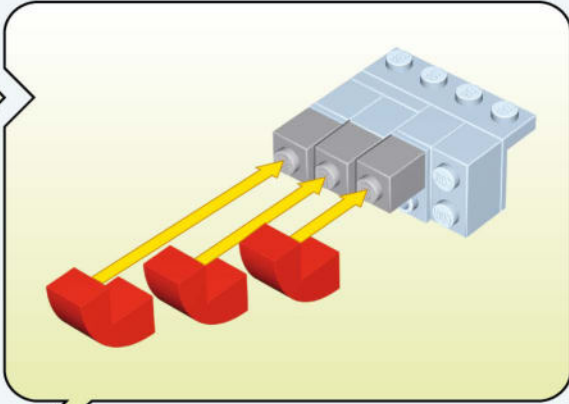
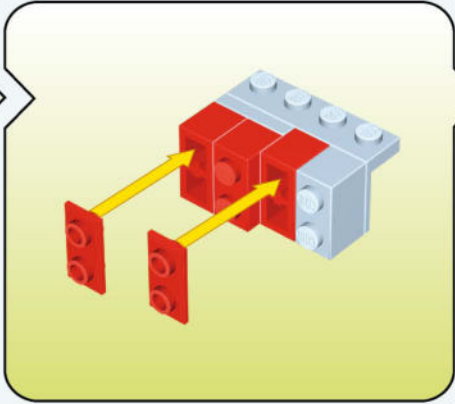
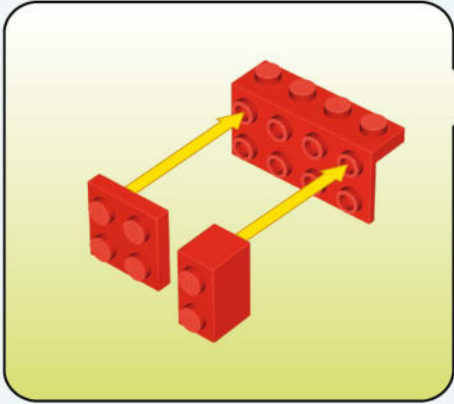

9

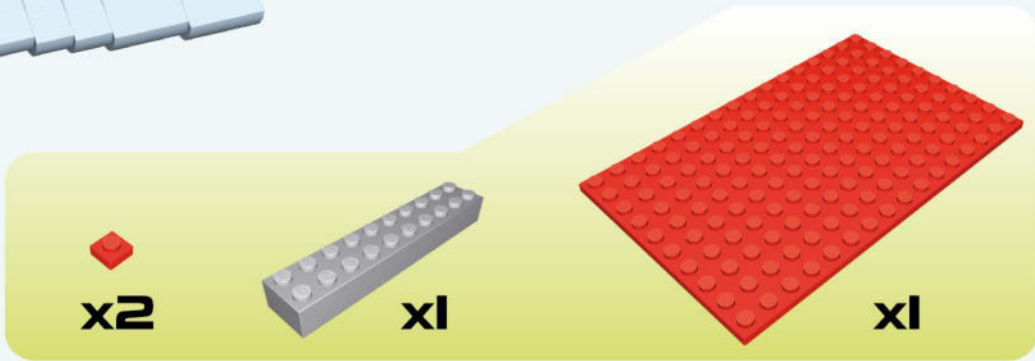
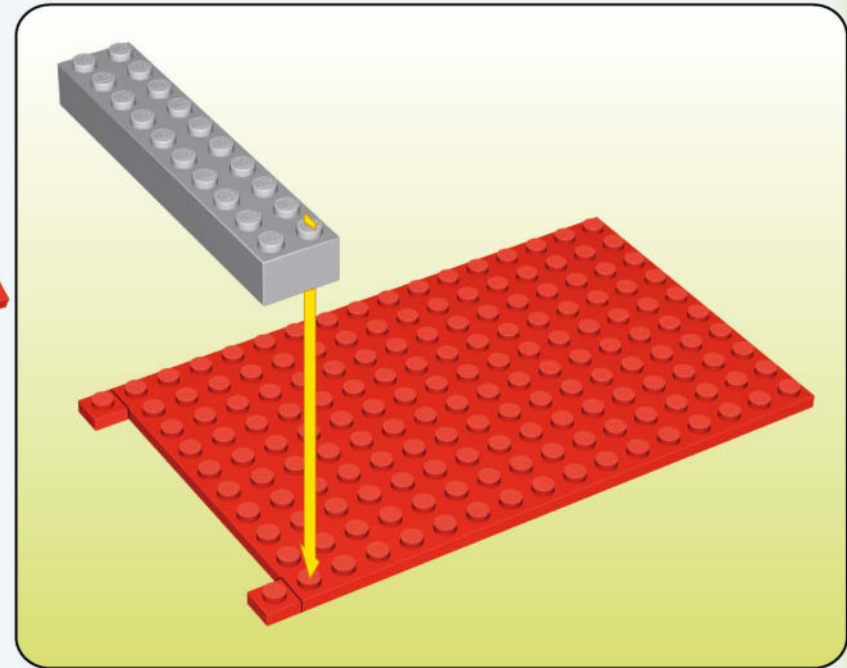
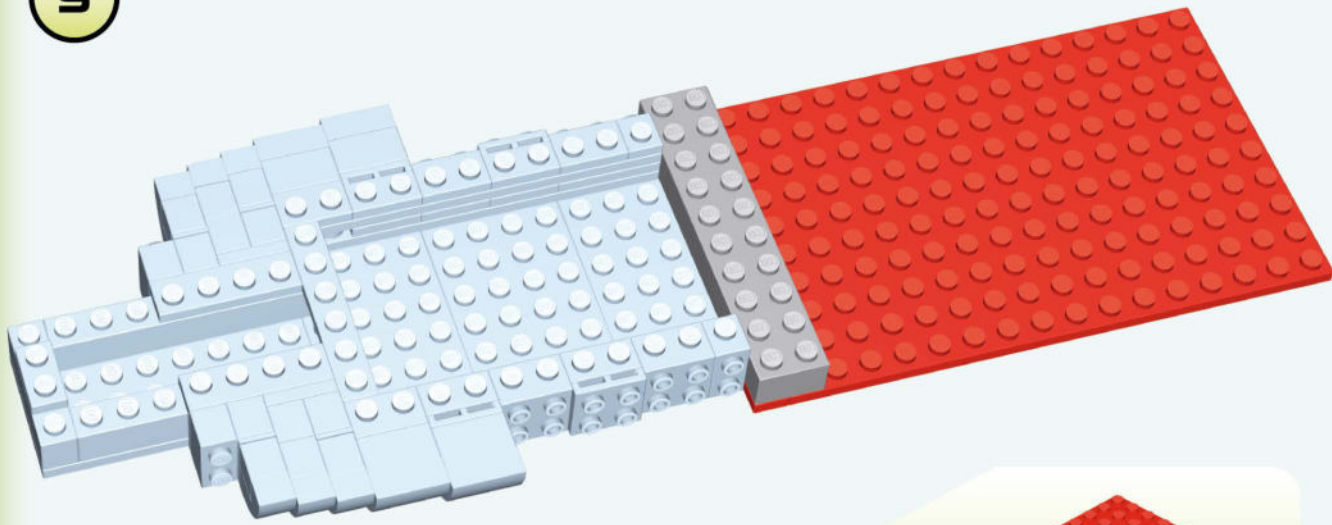

10

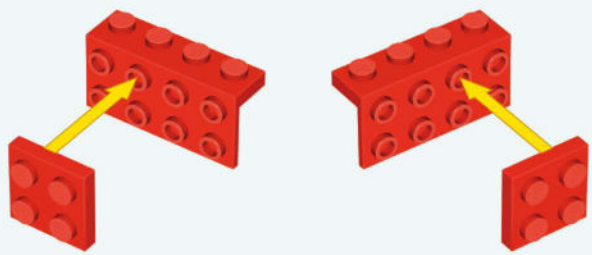

11

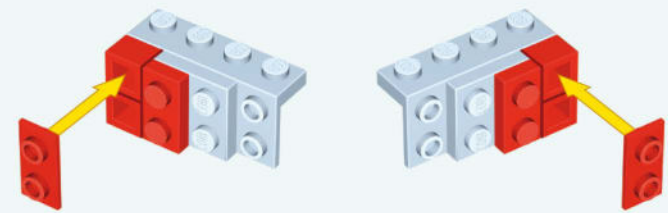

12

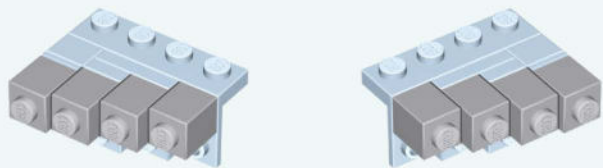

13

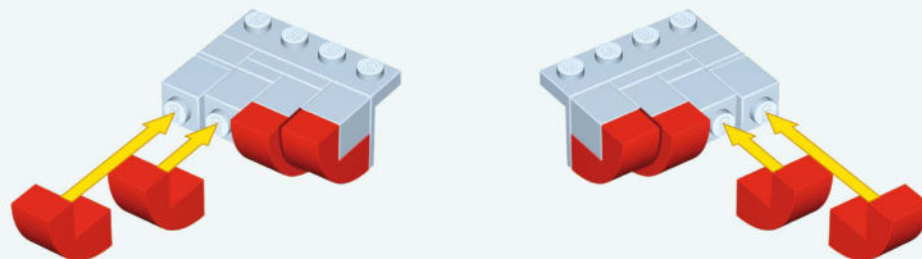

14

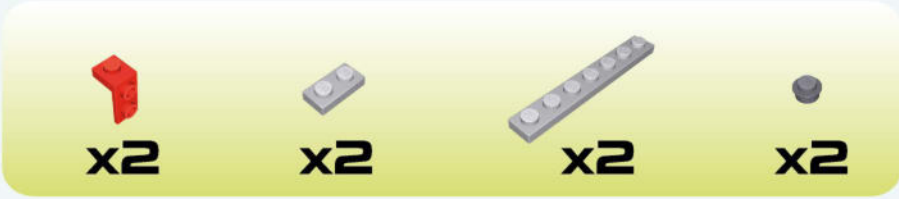
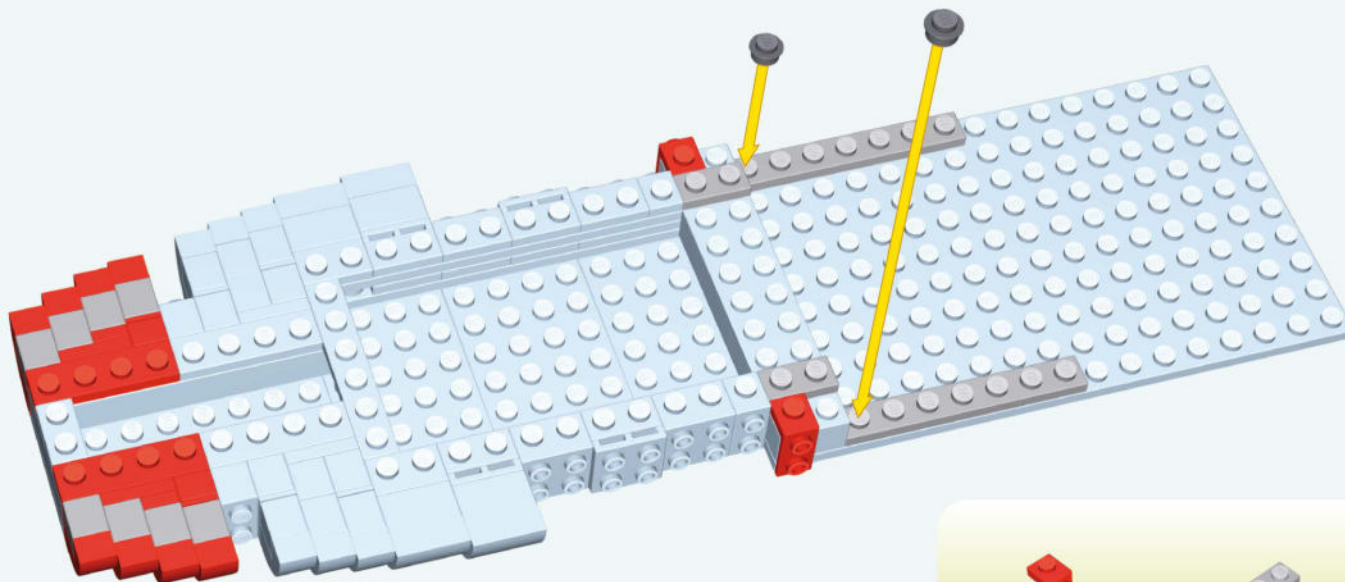

15

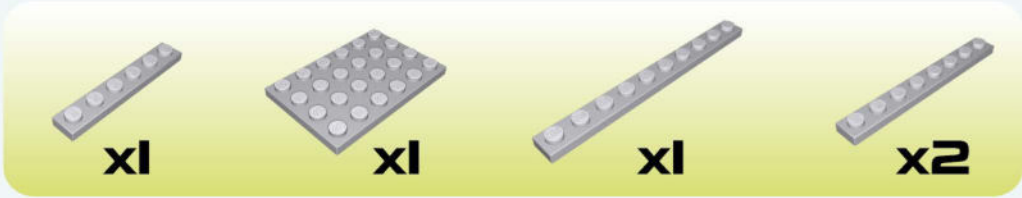
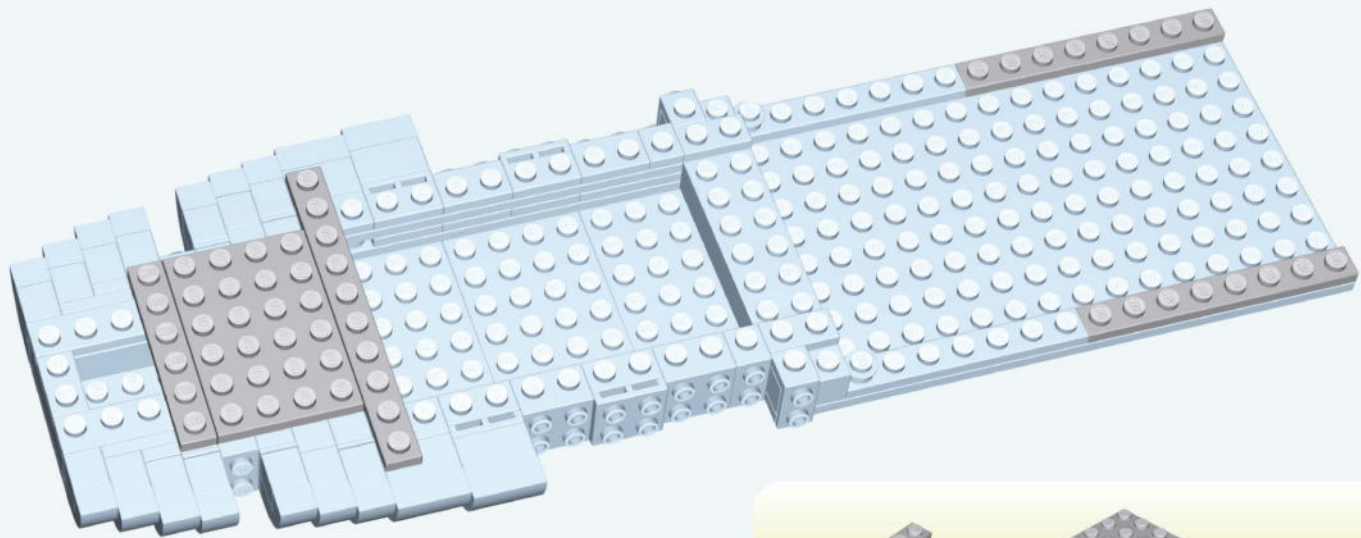

16

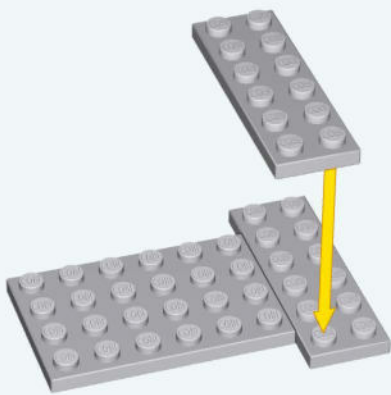

17

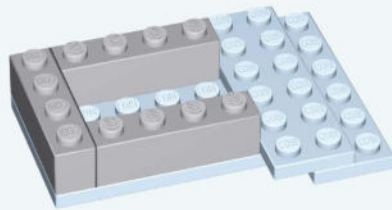

18

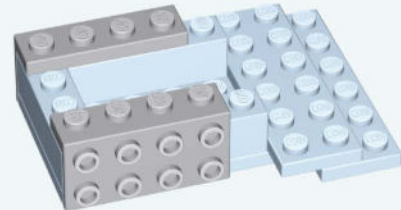

19

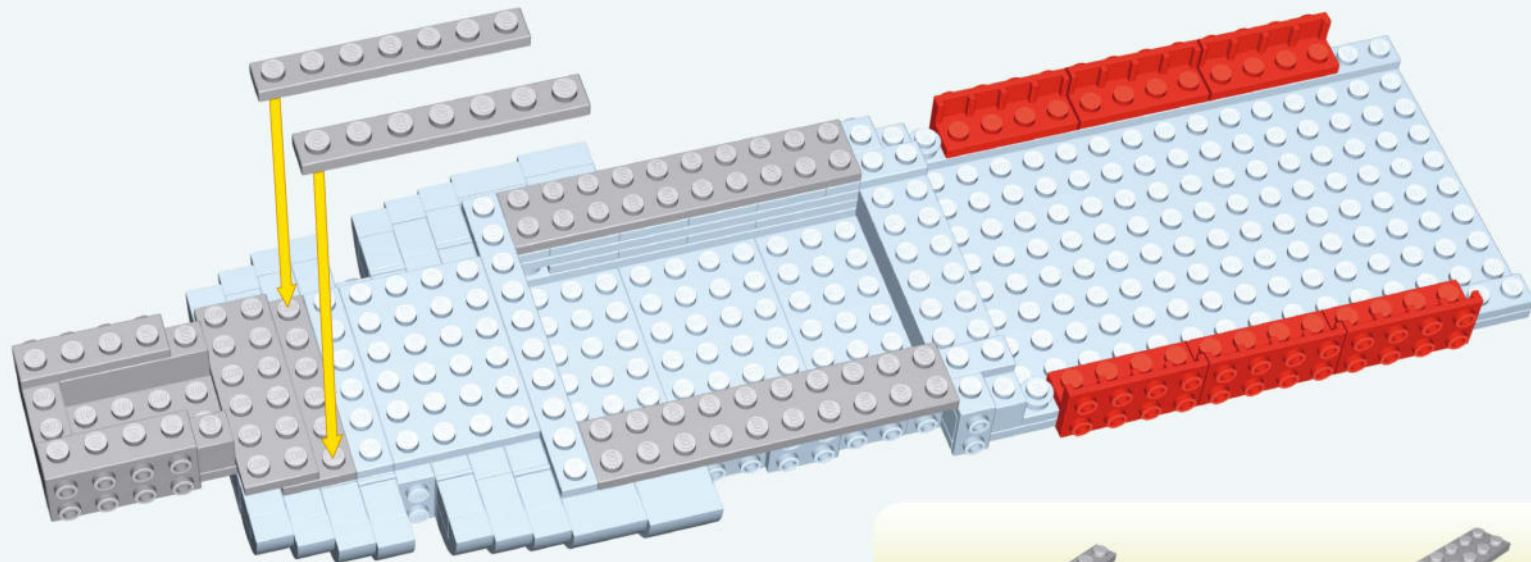

x2



x2



x6

20

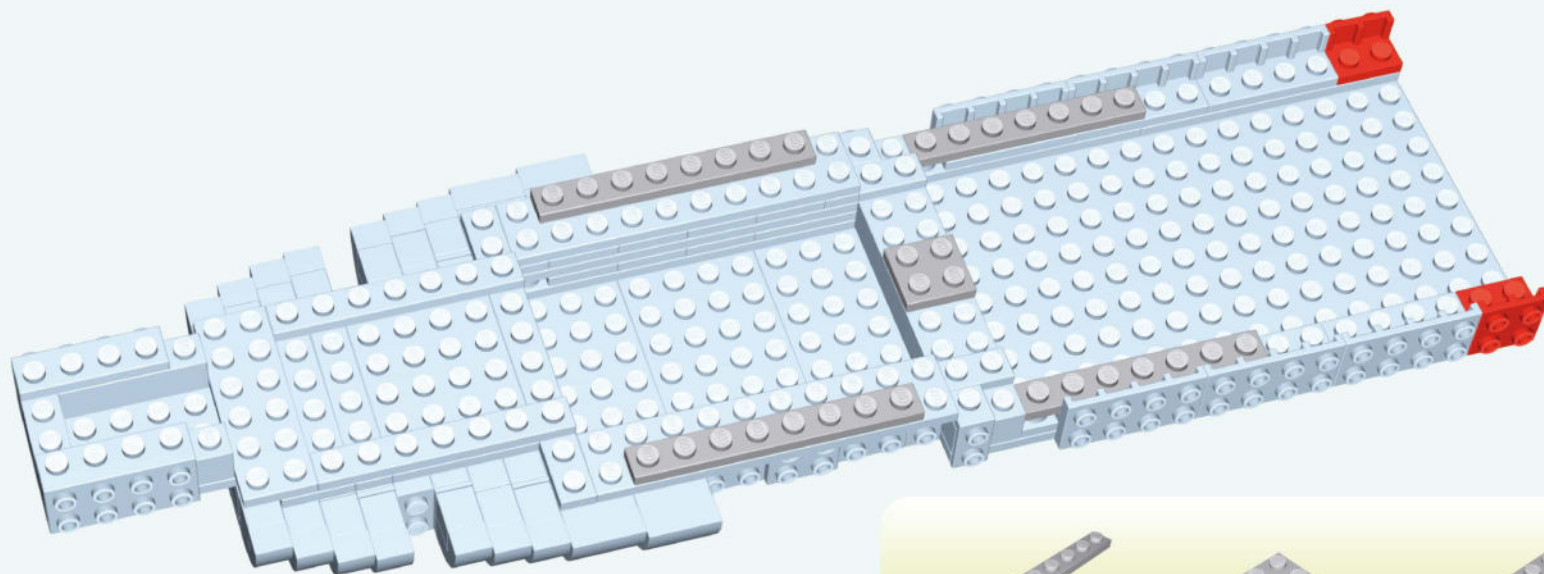

x2



x1



x2



x2

21

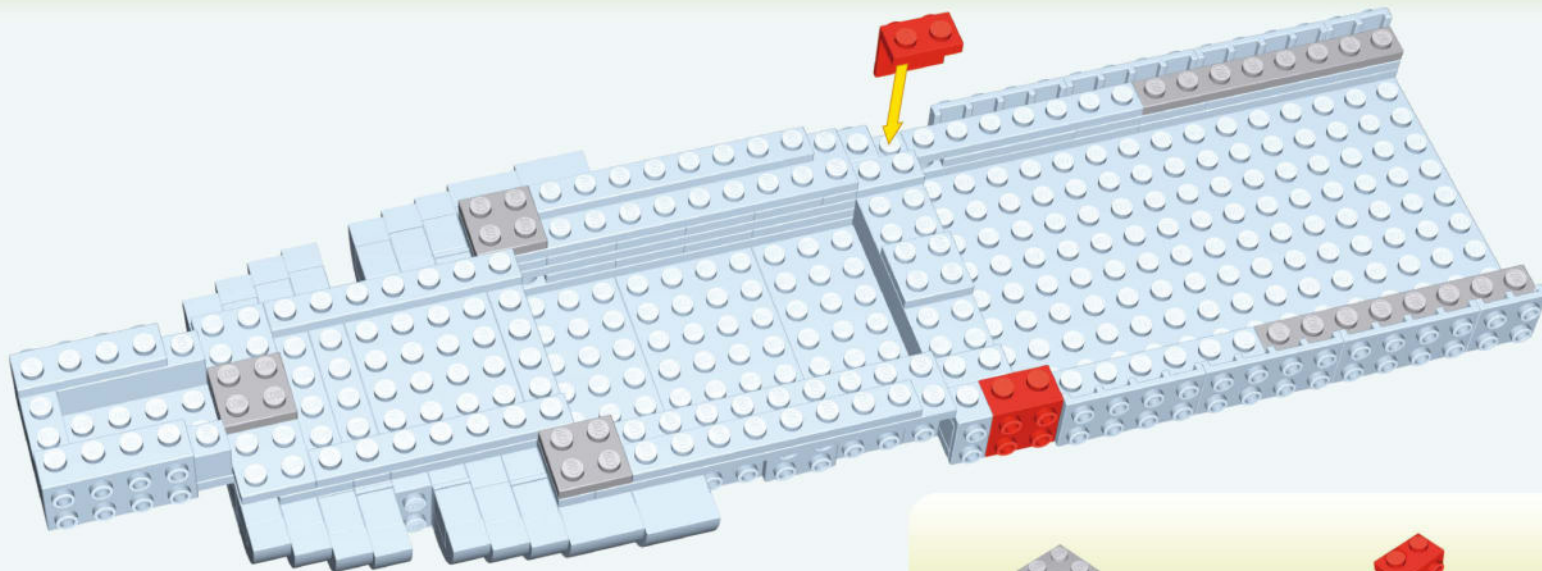

x3



x2



x2

22

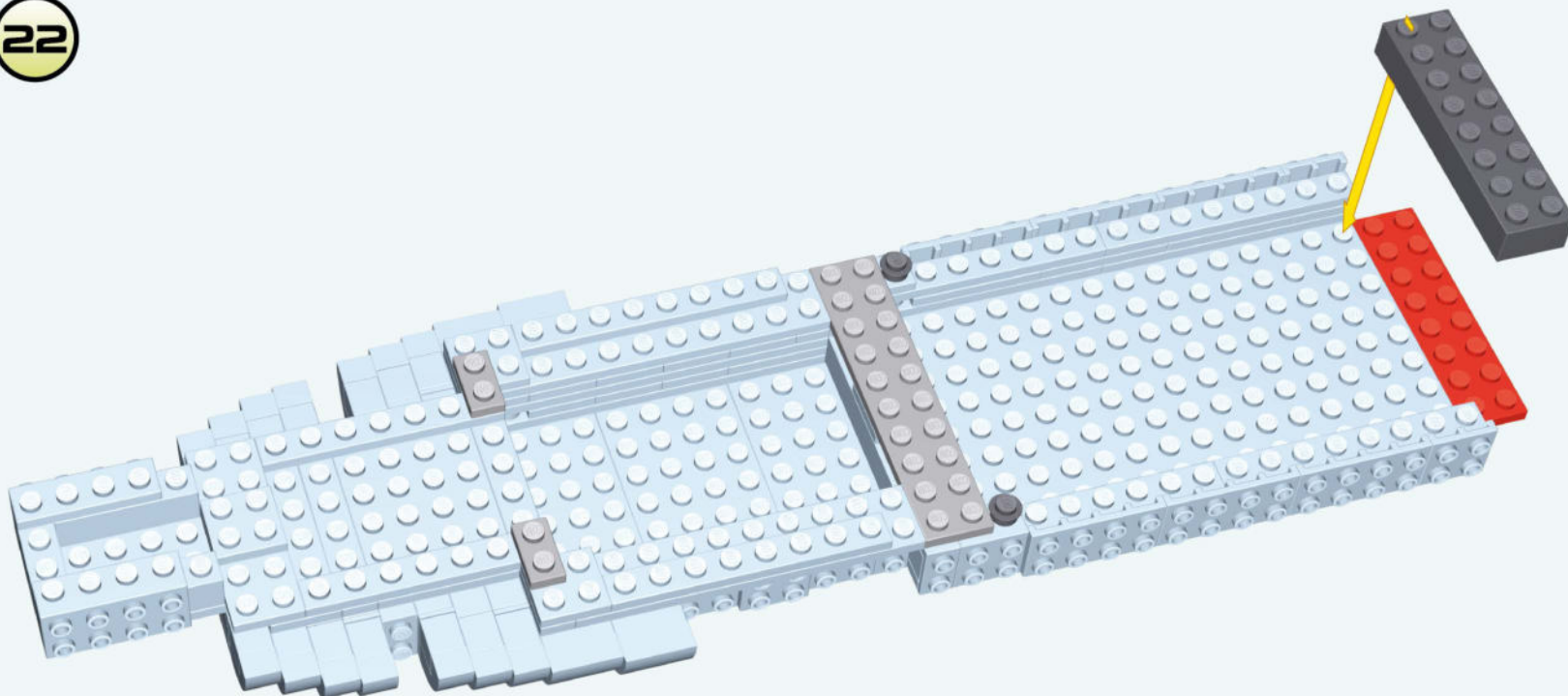

x2



x1



x2



x1



x1

23

1:1

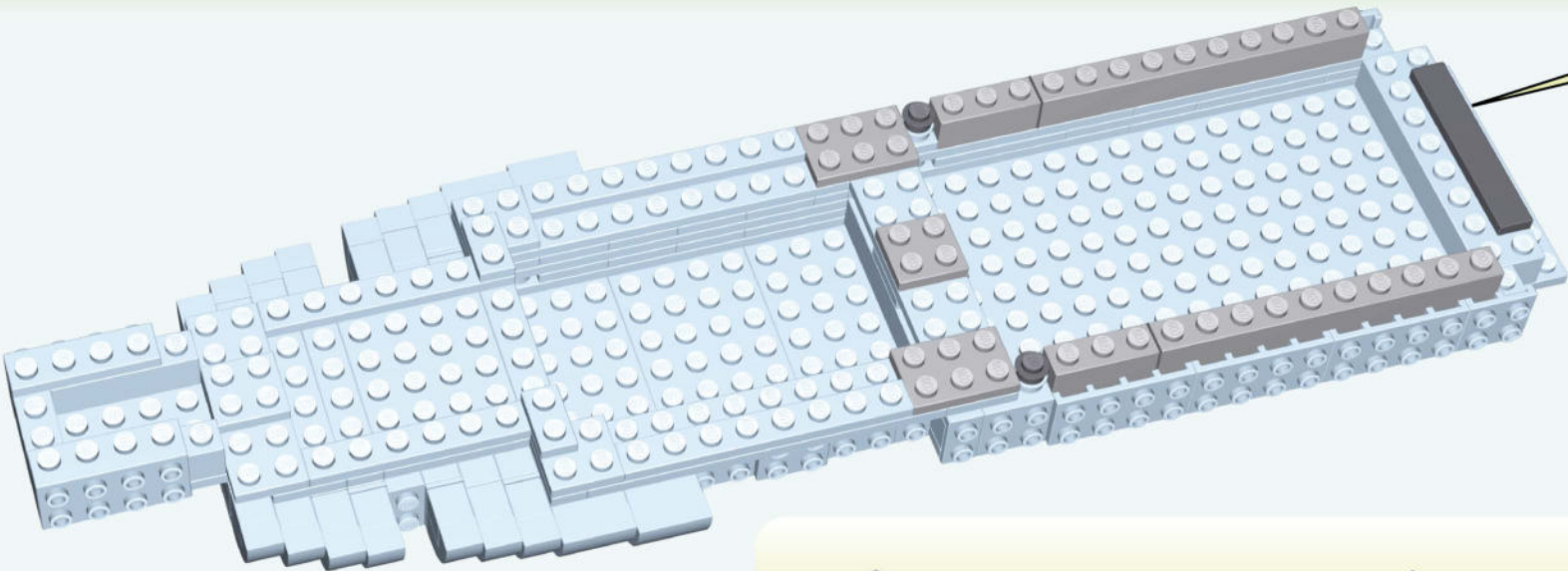

-  x2
-  x1
-  x2
-  x2
-  x2
-  x1

24

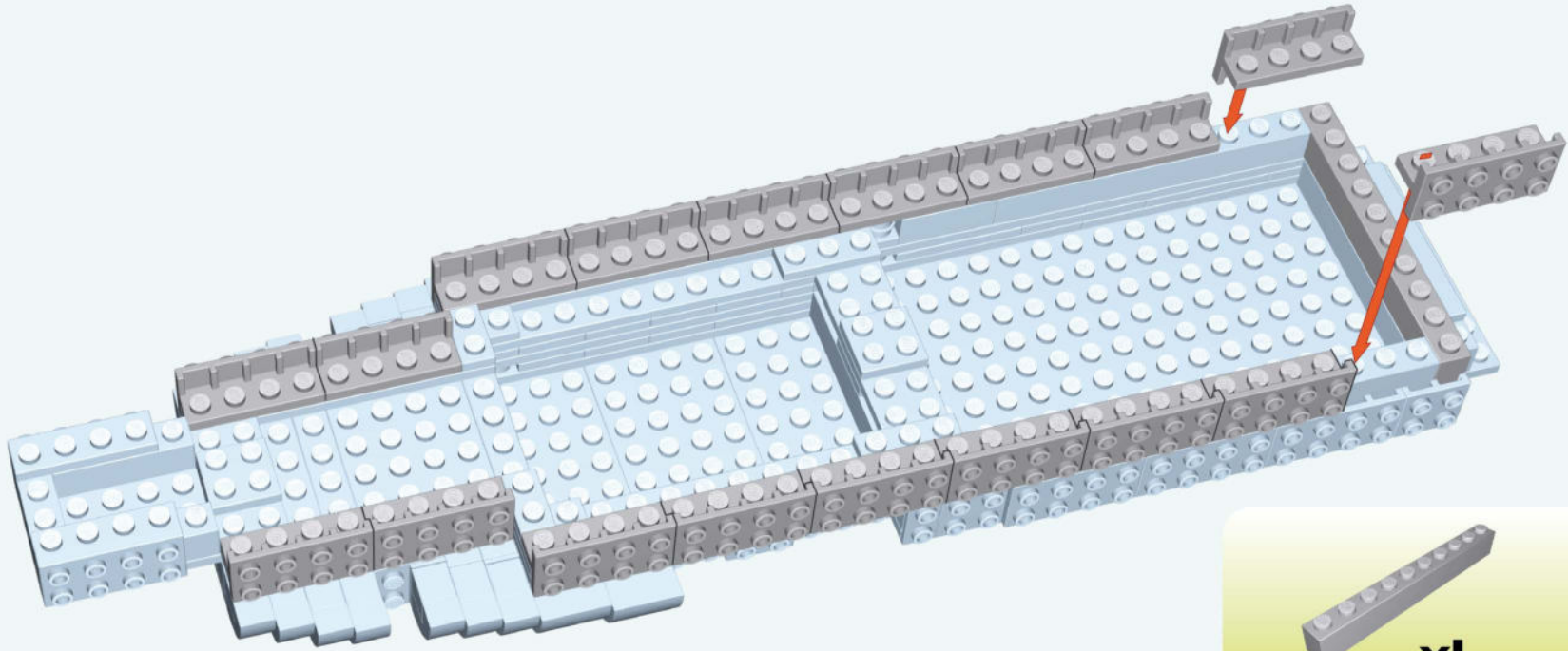

-  x1
-  x18

25

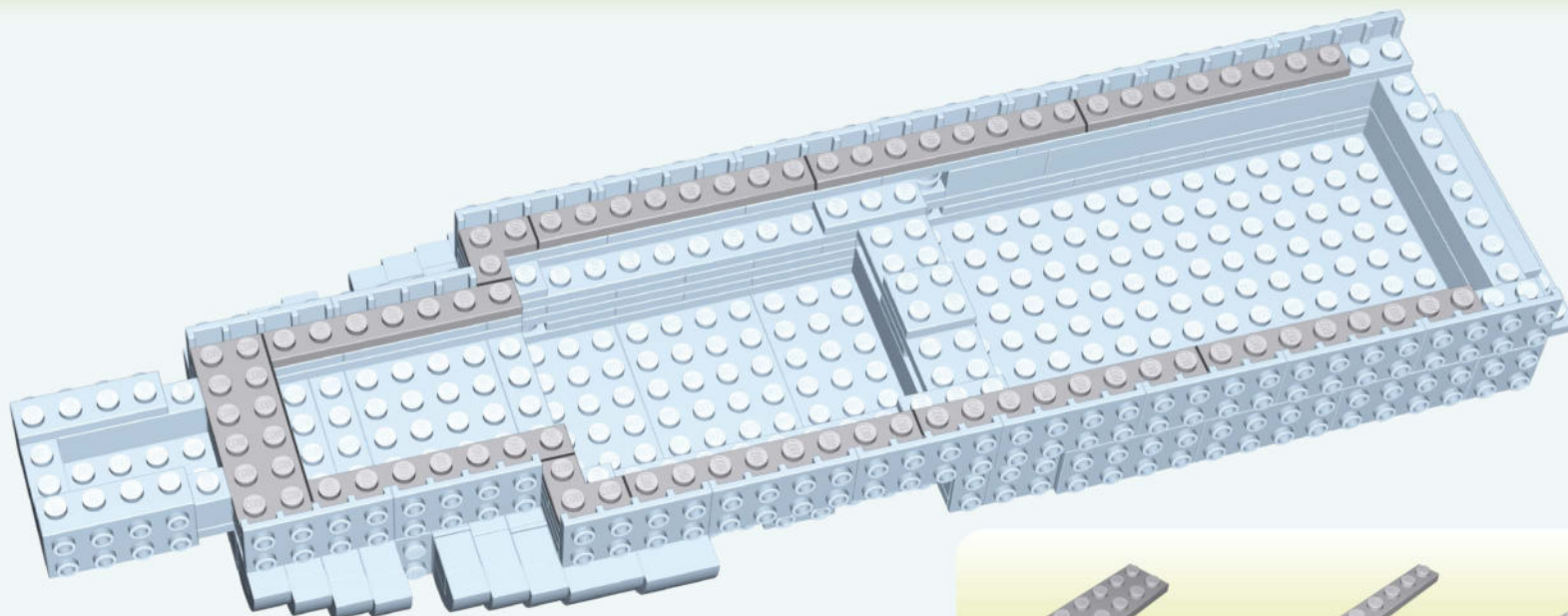

x1



x2



x2



x6

26

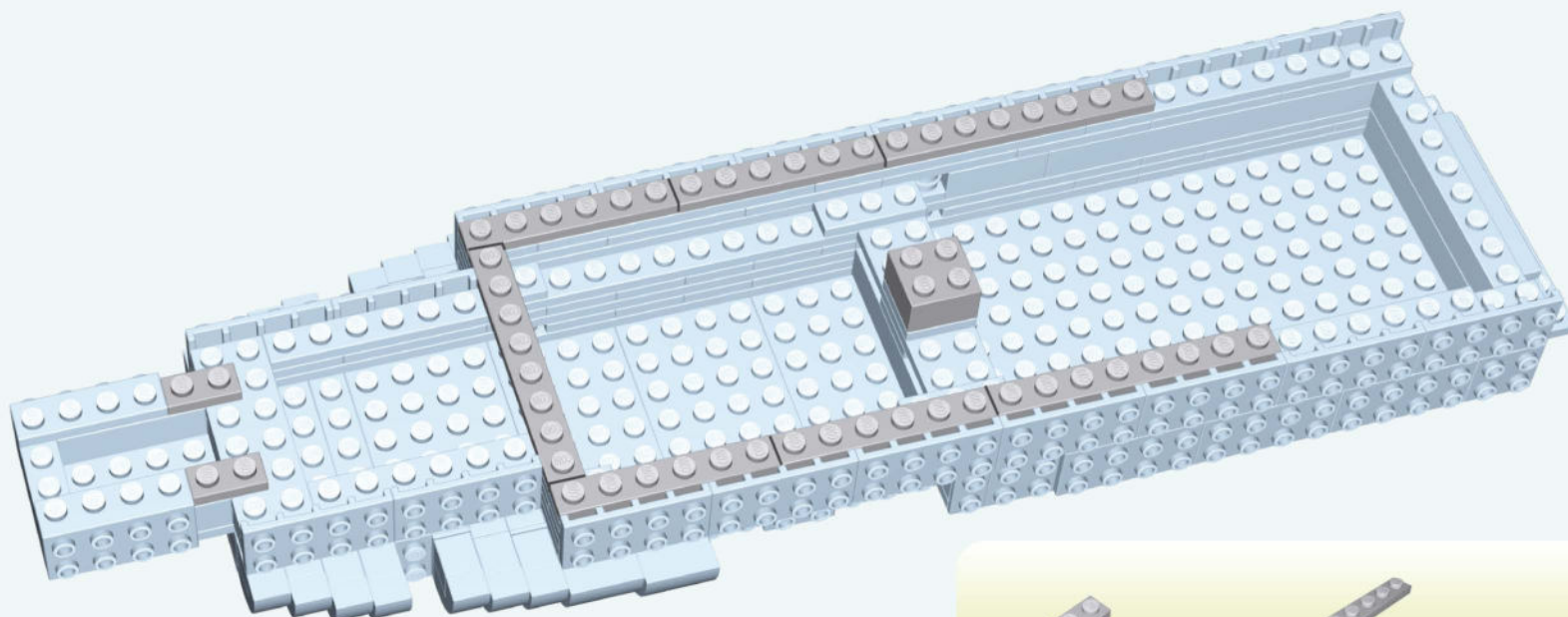

x2



x3



x4



x1

27

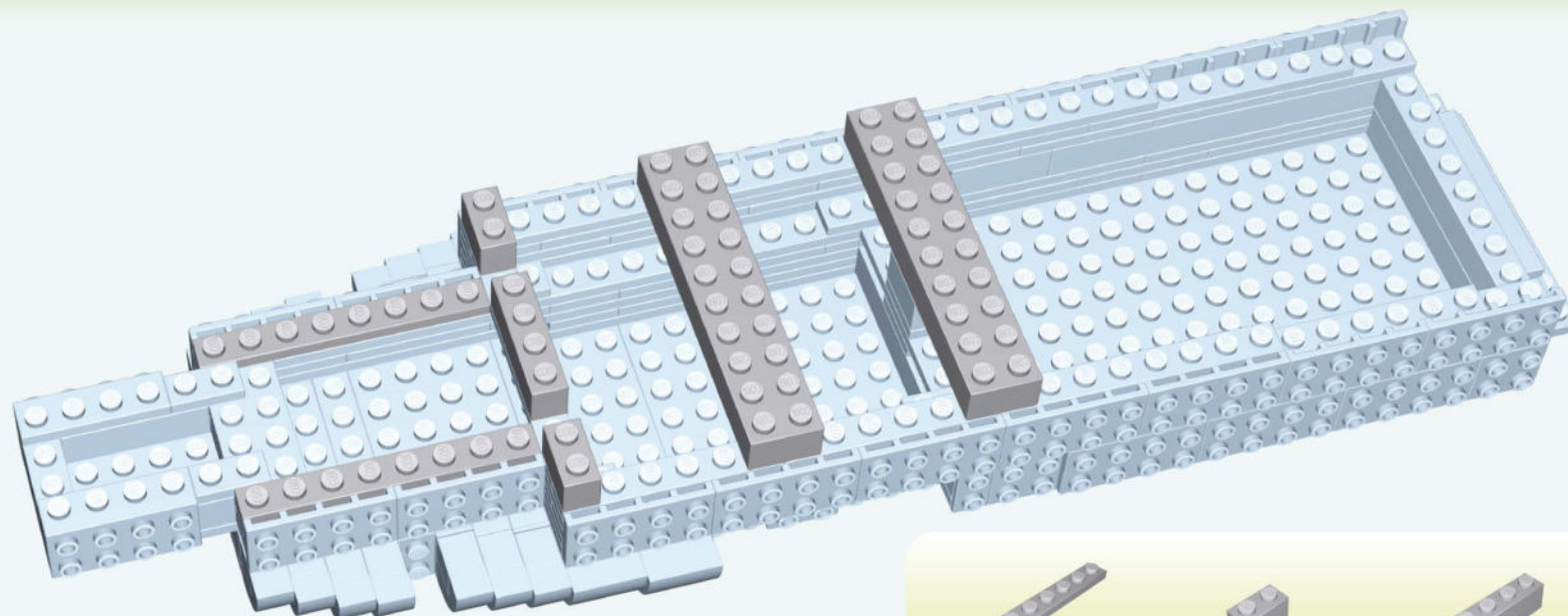

x2



x2



x1

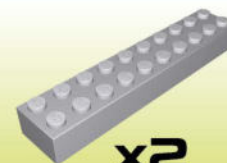

x2

28

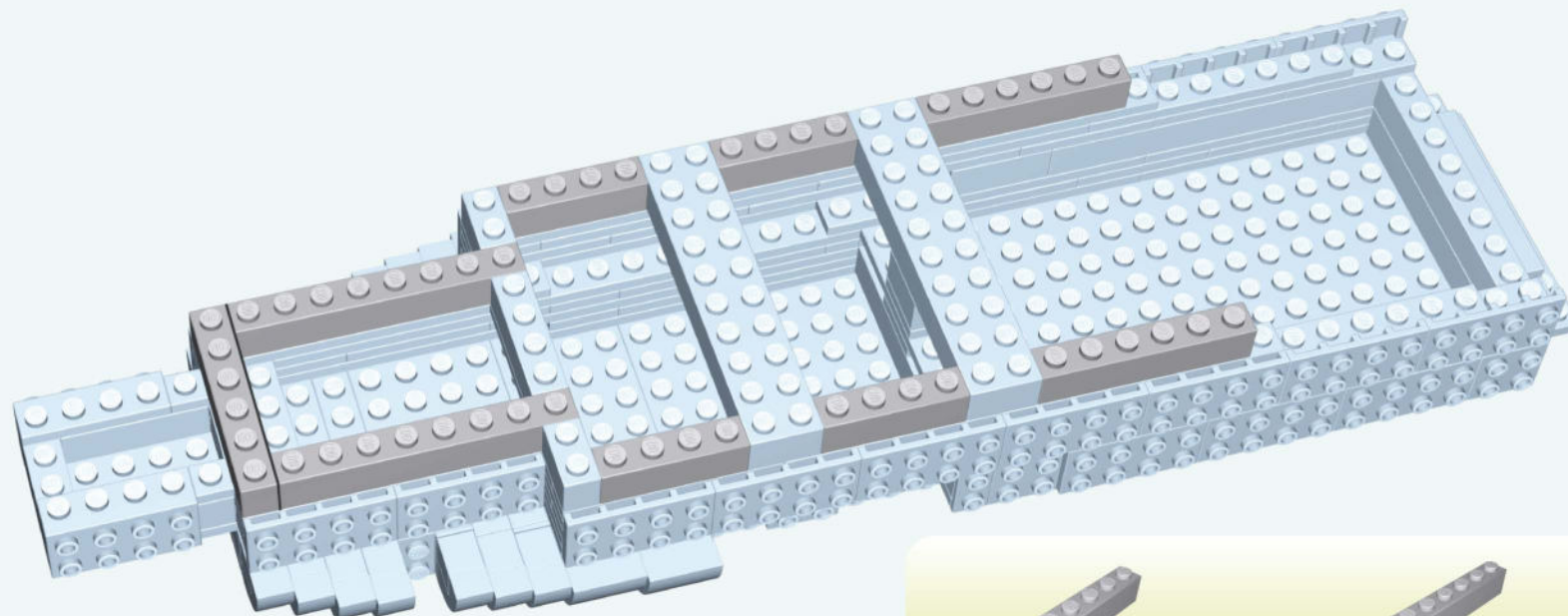

x3

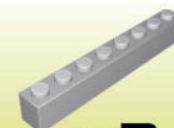

x2



x4

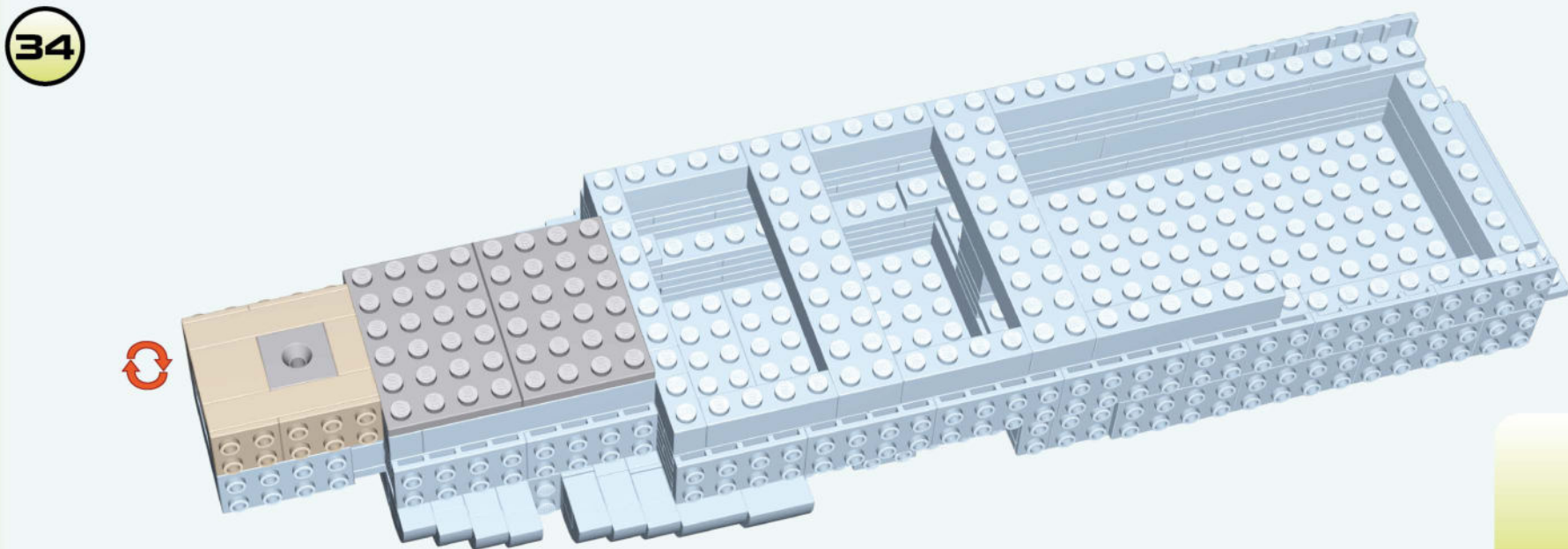
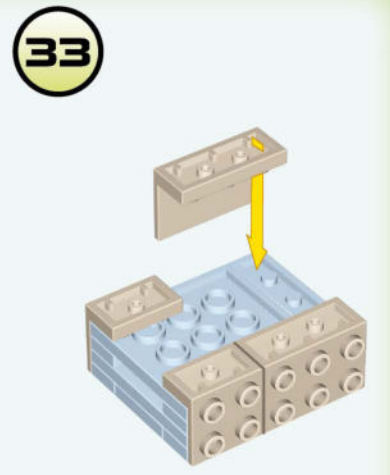
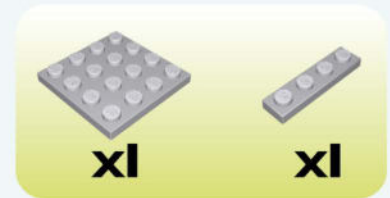
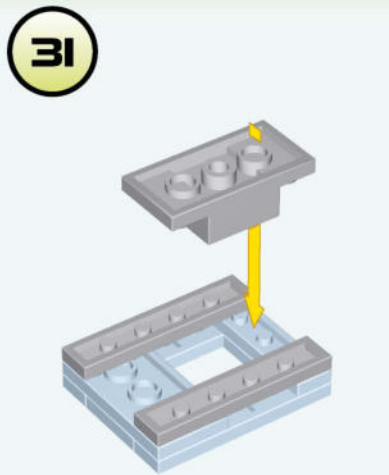
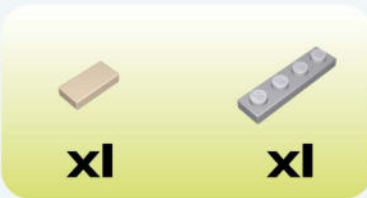
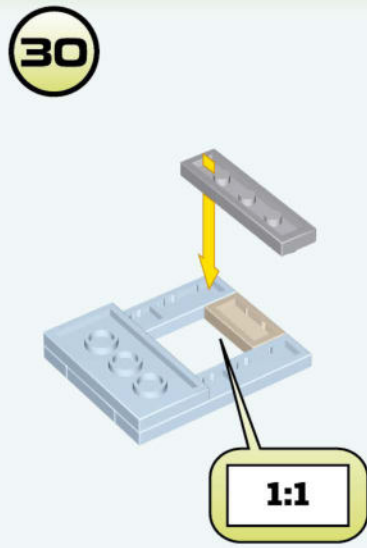
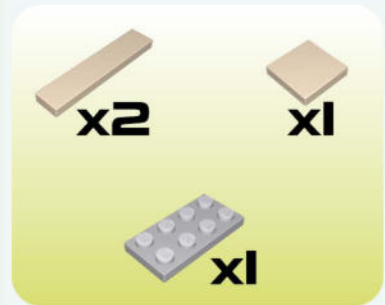
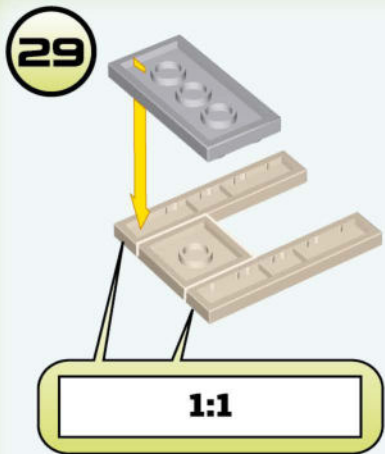

35

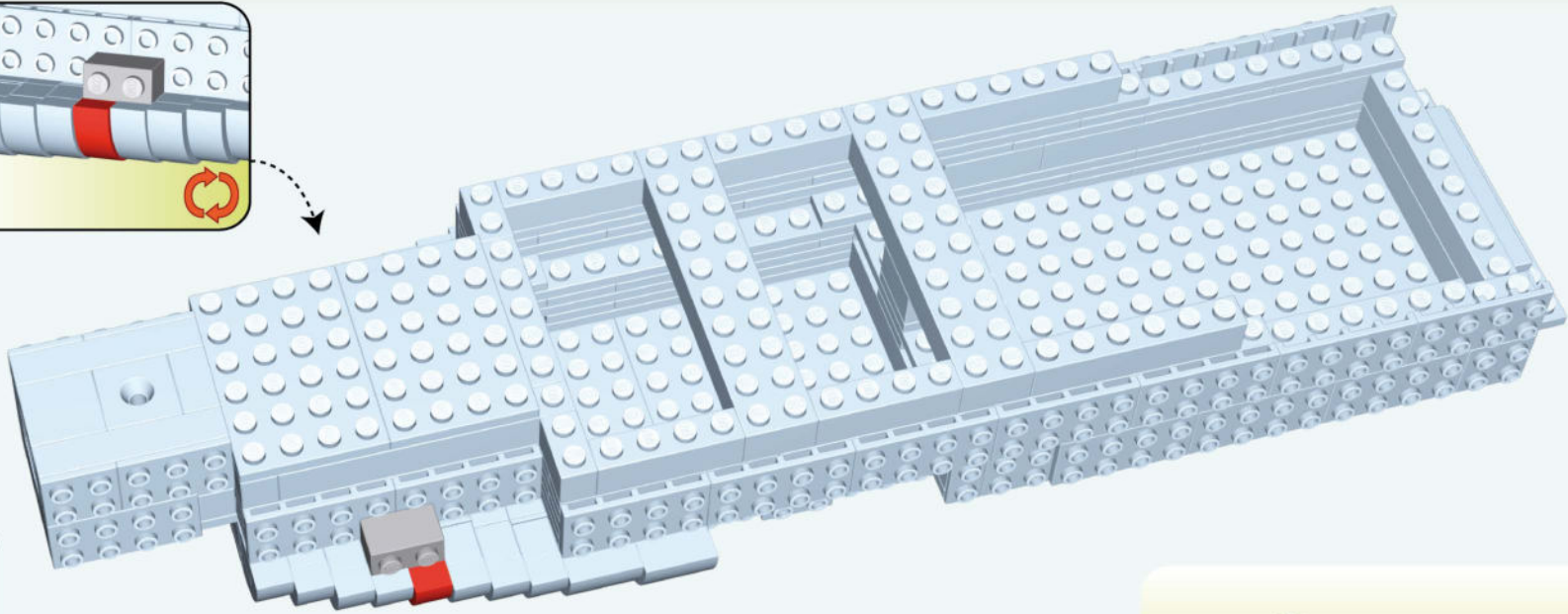
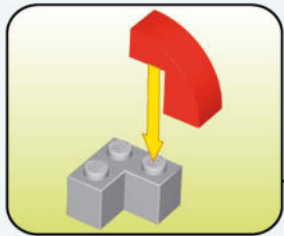
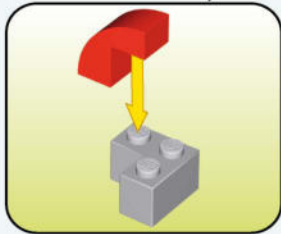
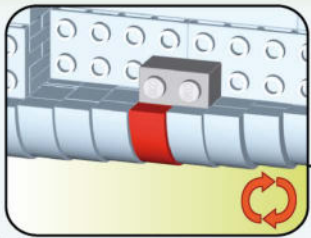

x2



x2



36

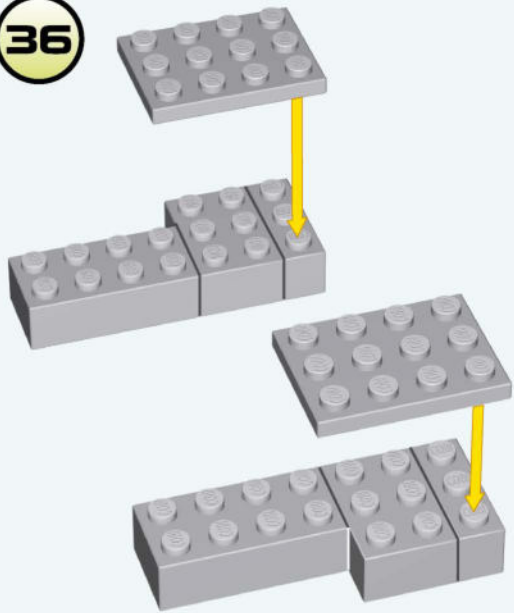

x2

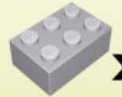

x2



x2



x2

37



x4



x2



x2

38

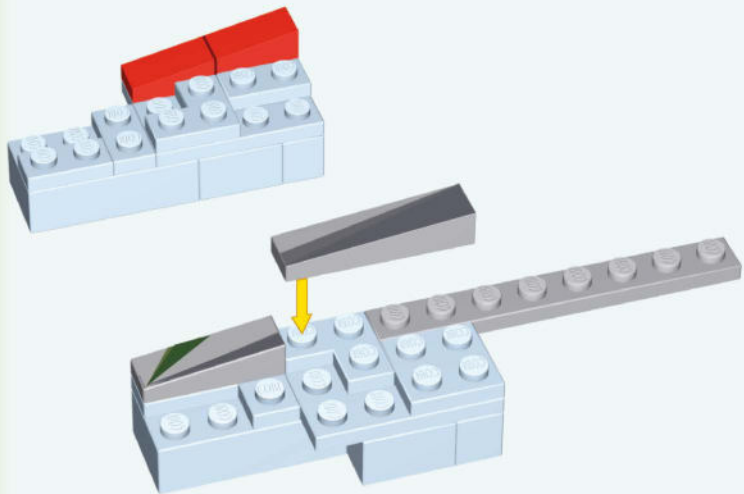

Red 1x2 Technic Brick x2

Grey 1x2 Technic Technic Axle x1

Grey 1x10 Technic Technic Axle x1

Grey 1x2 Technic Technic Axle x1

39

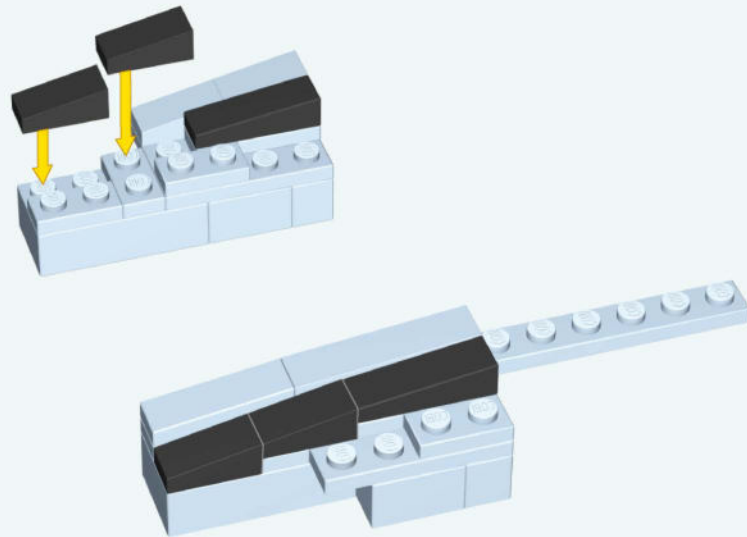

Black 1x2 Technic Technic Axle x4

Black 1x2 Technic Technic Axle (24) x2

40

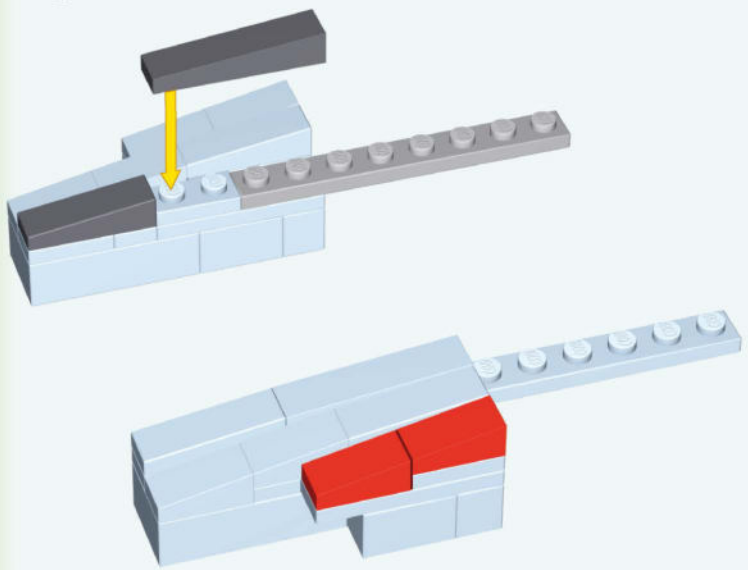

Black 1x2 Technic Technic Axle (24) x1

Grey 1x10 Technic Technic Axle x1

Black 1x2 Technic Technic Axle x1

Red 1x2 Technic Brick x2



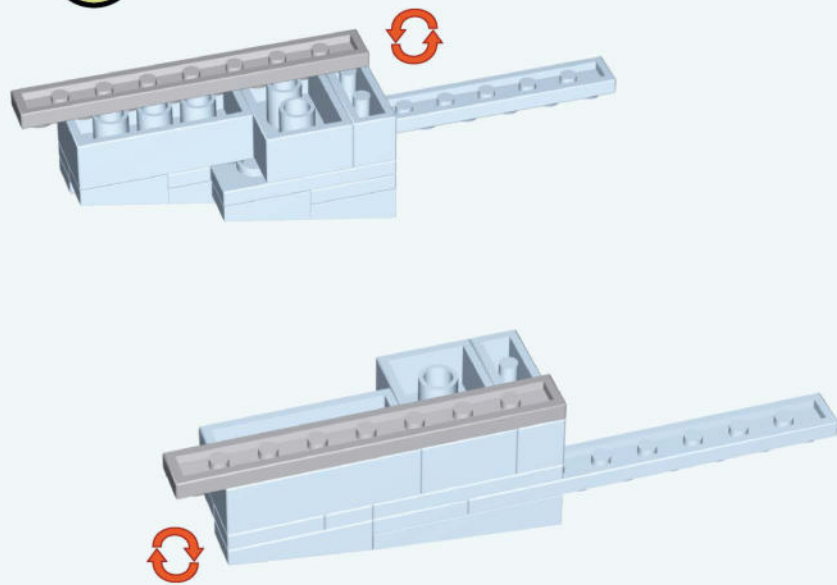

41

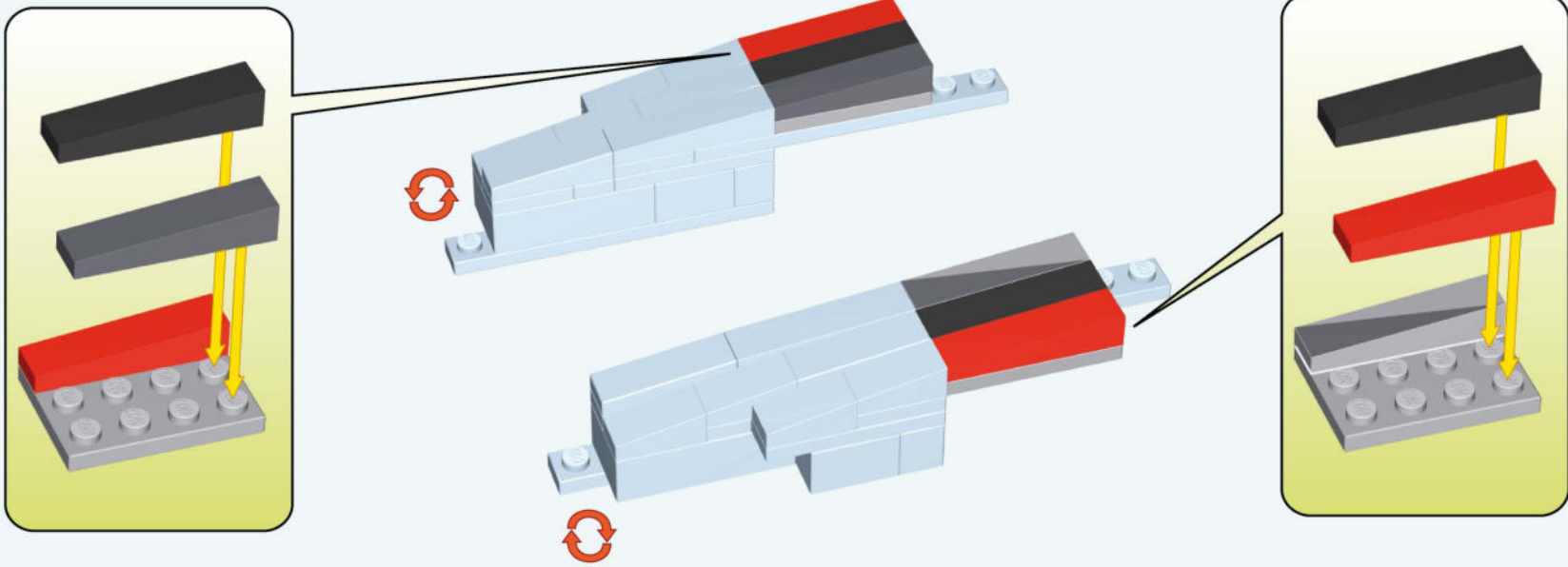

Grey 1x10 Technic Technic Axle x2

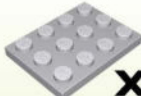
42

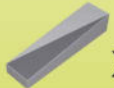

-  x2
-  x2
-  x2
-  x1
-  x1

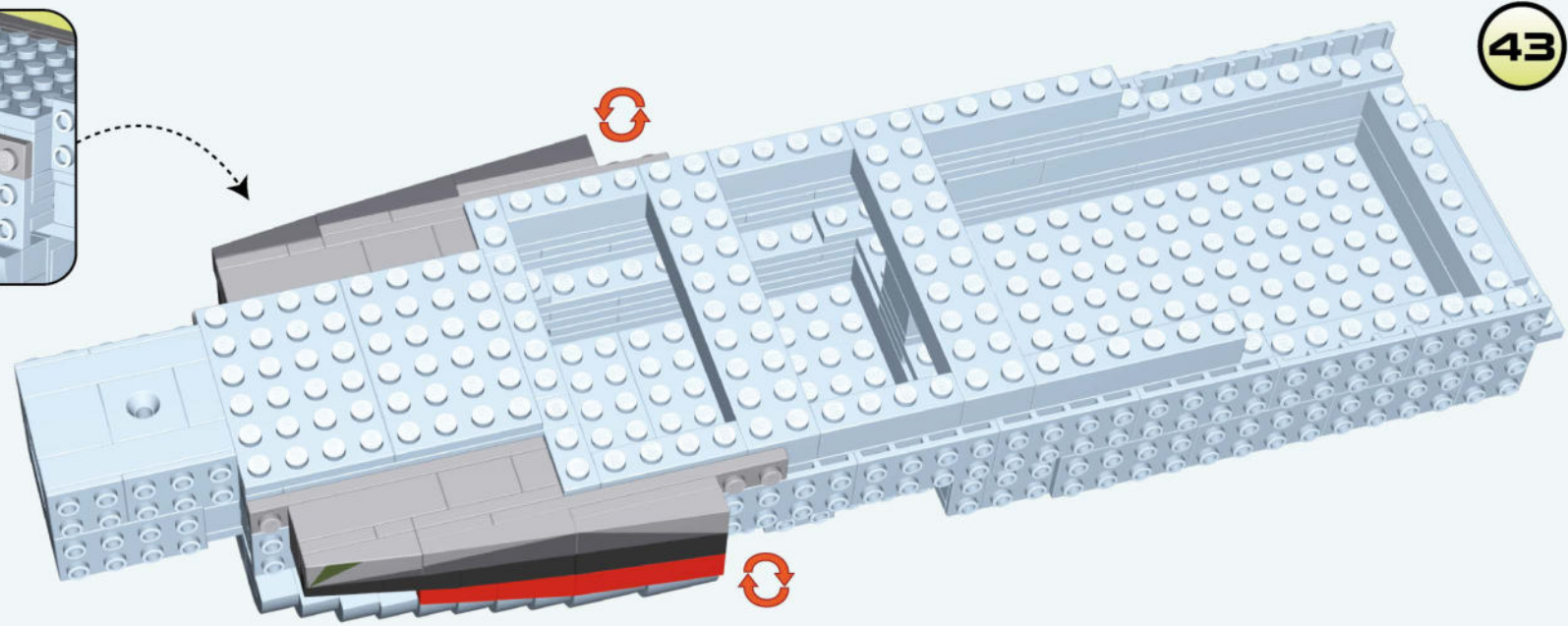
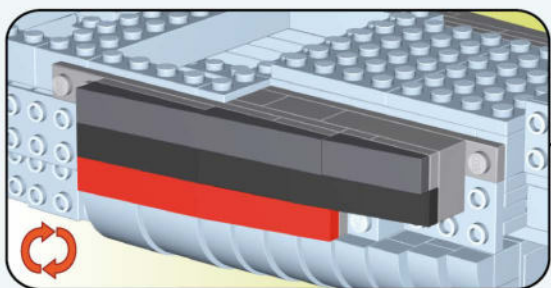

43

44

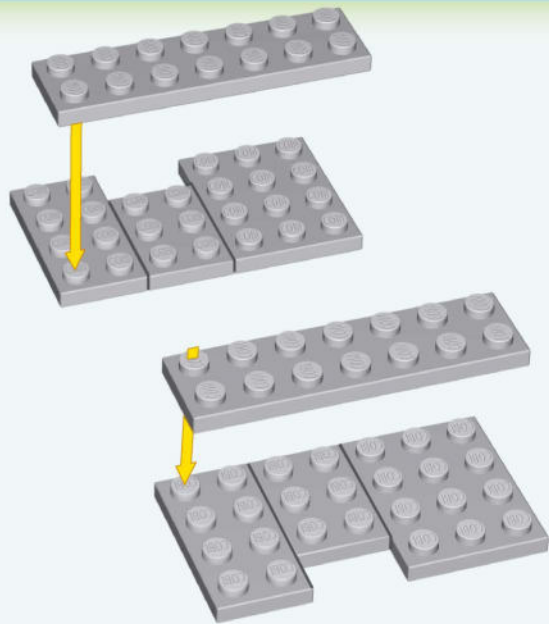

45

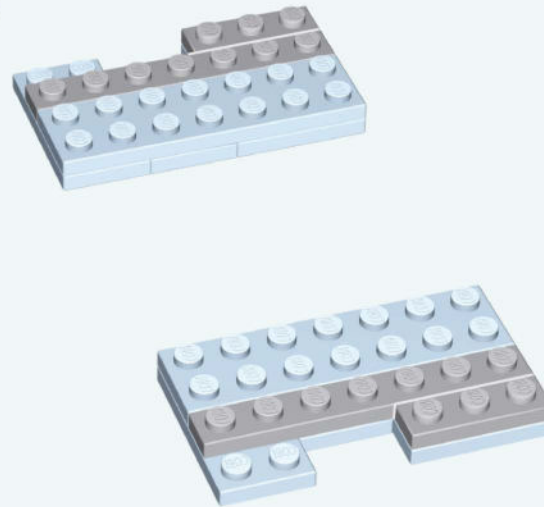

46

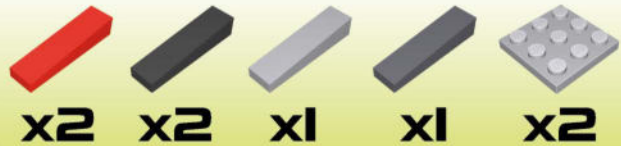
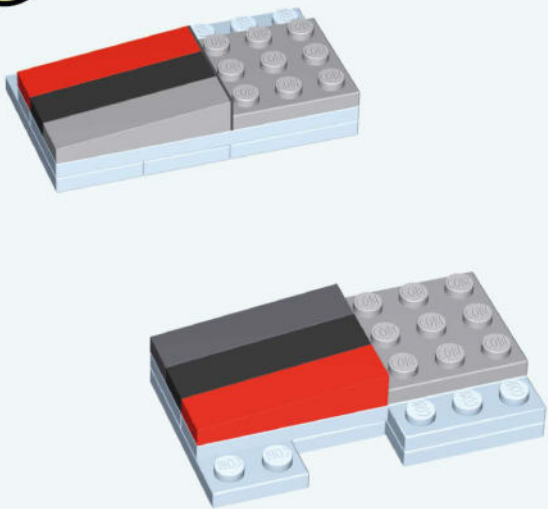

47

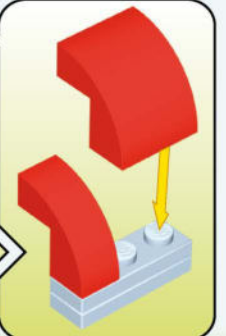
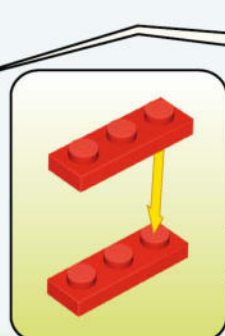
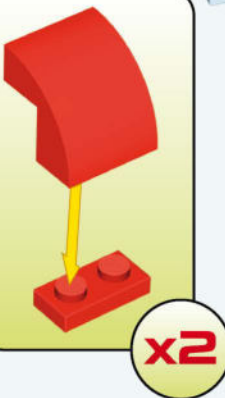
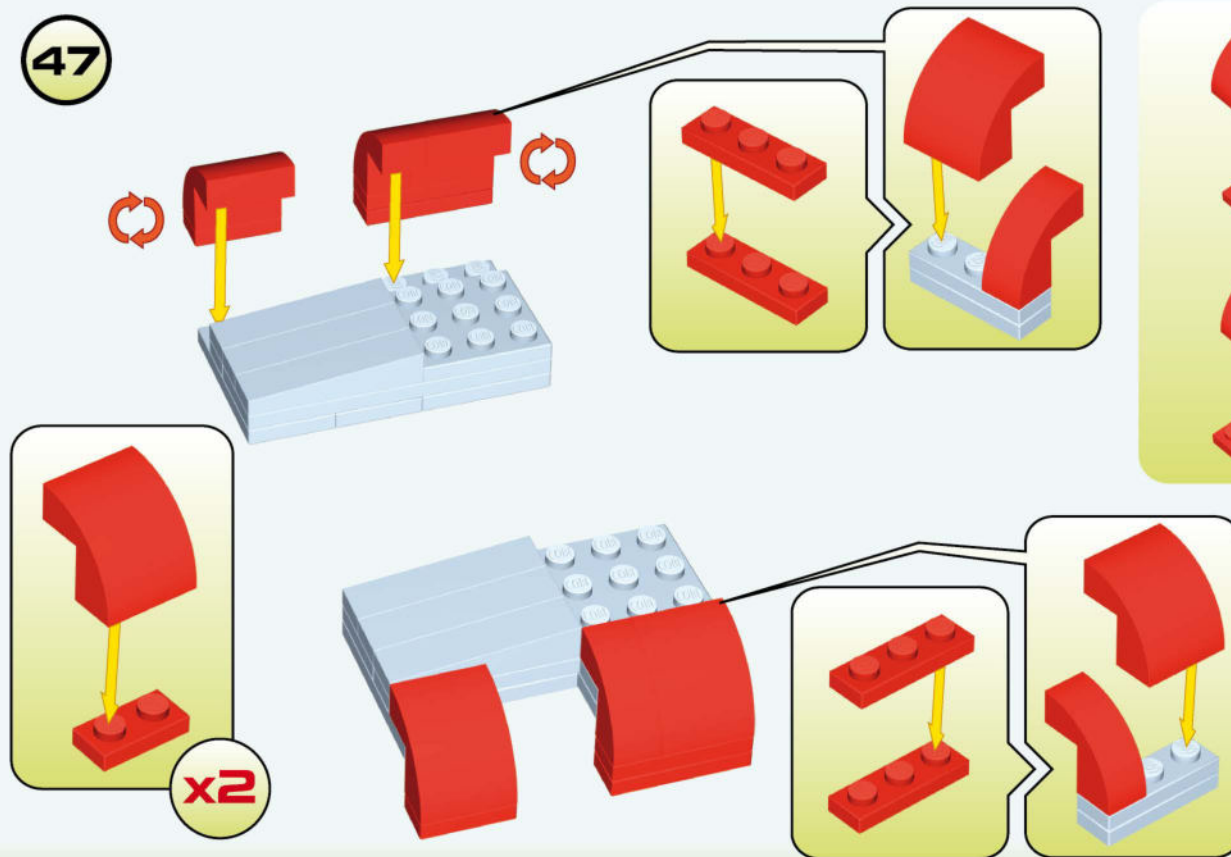

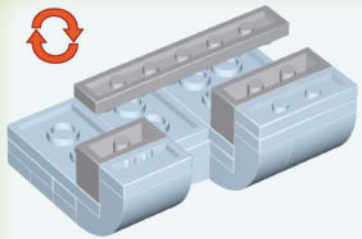

48

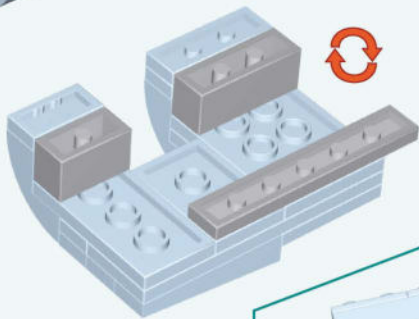

49

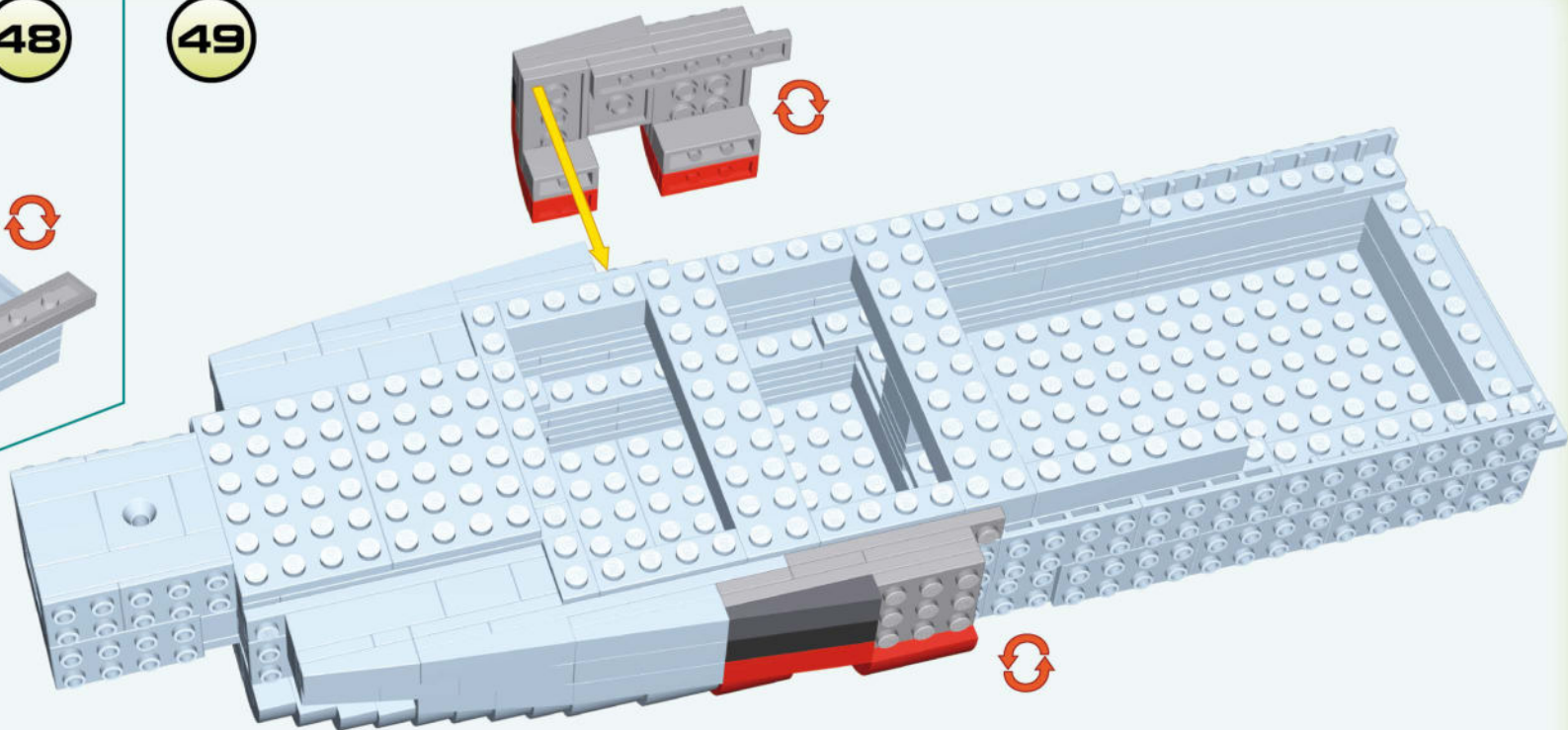

x2



x2



x2

50

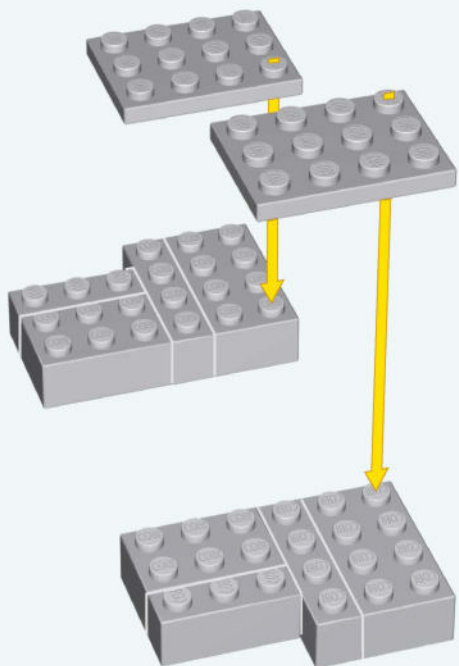

x2



x2



x2



x2



x2

51

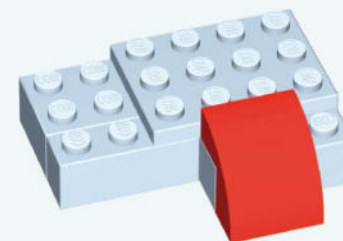
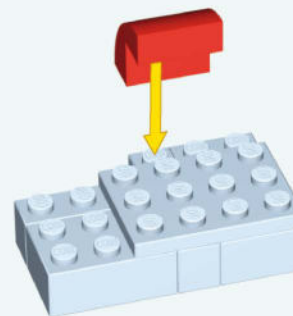

x2

52

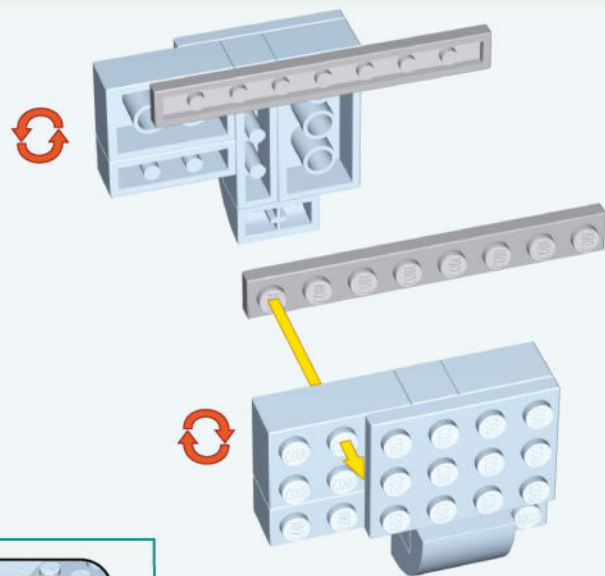



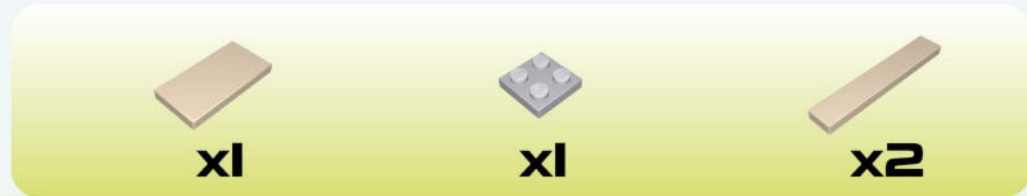
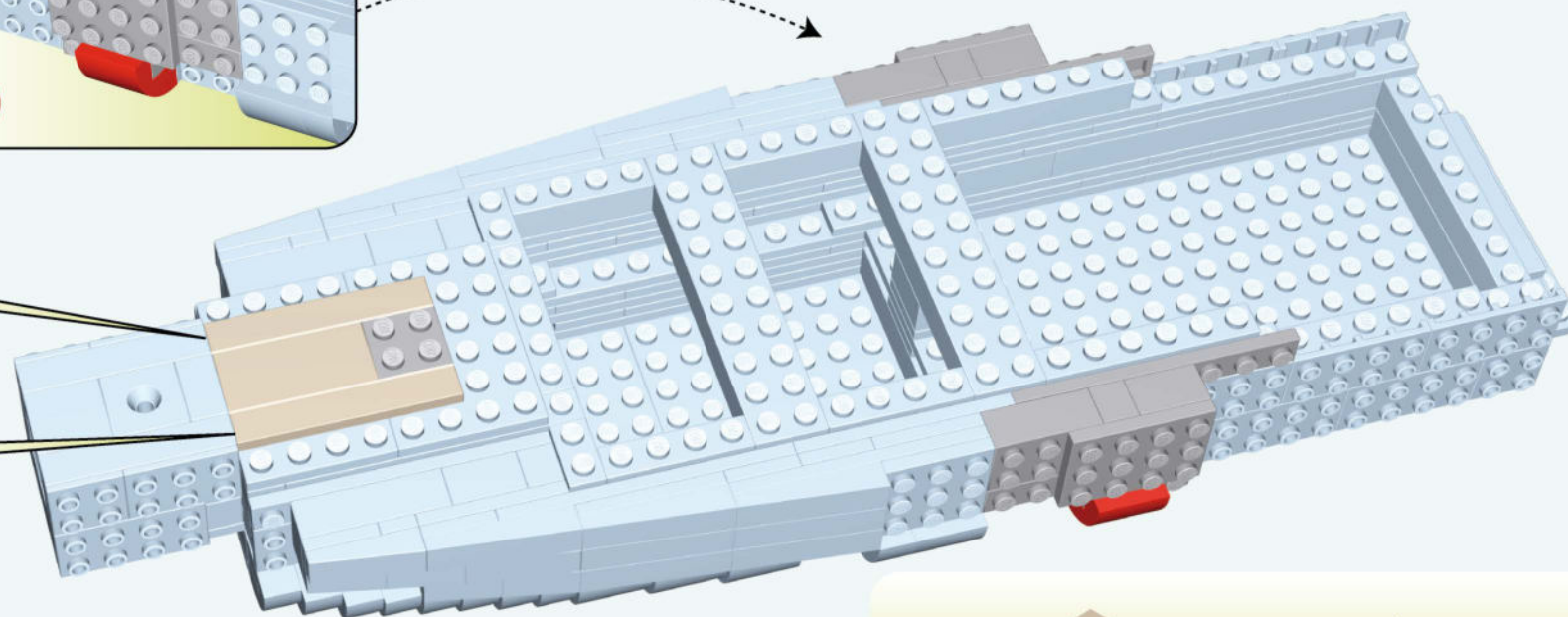
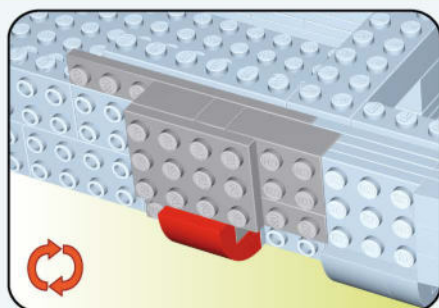

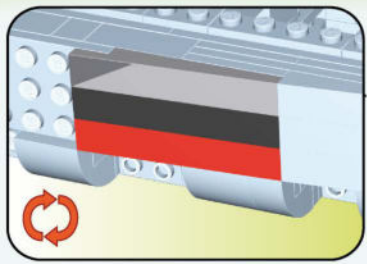

53

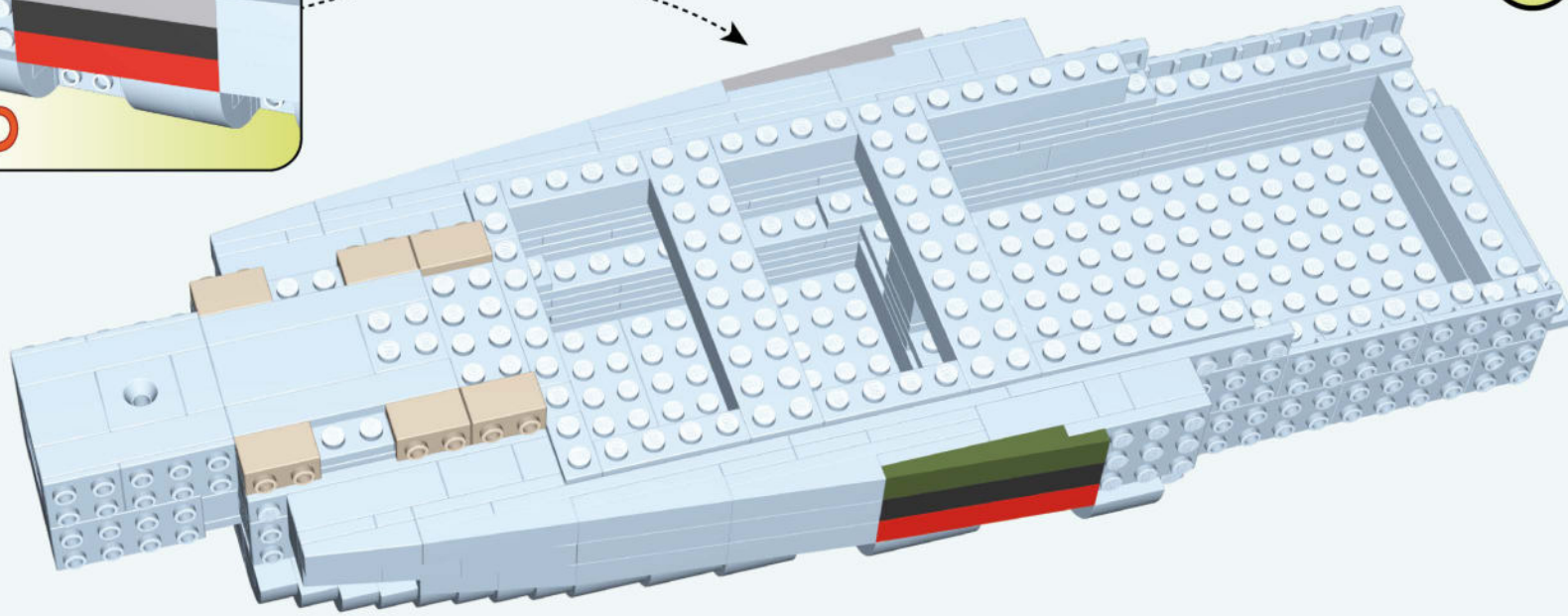





54

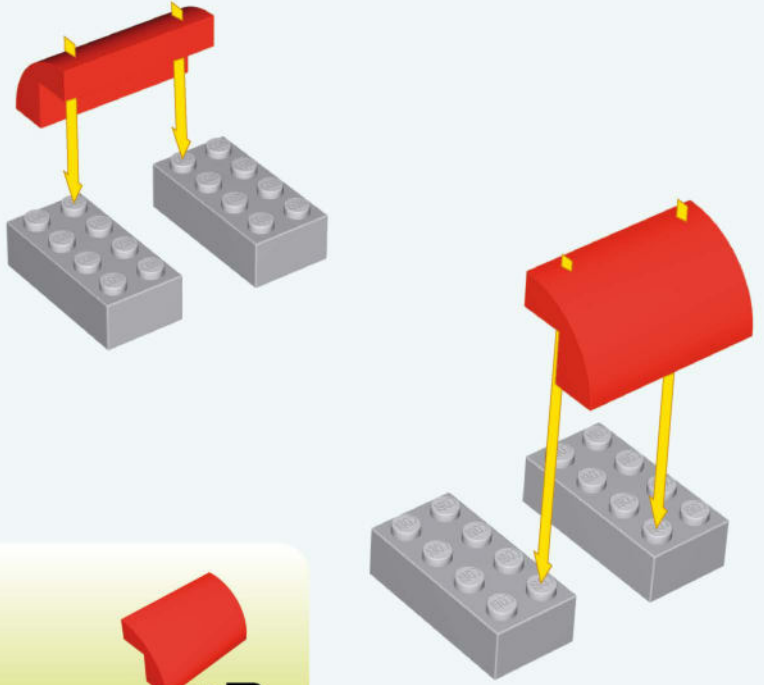

-  x6
-  x1
-  x2
-  x2
-  x1

55



-  x4
-  x2

56

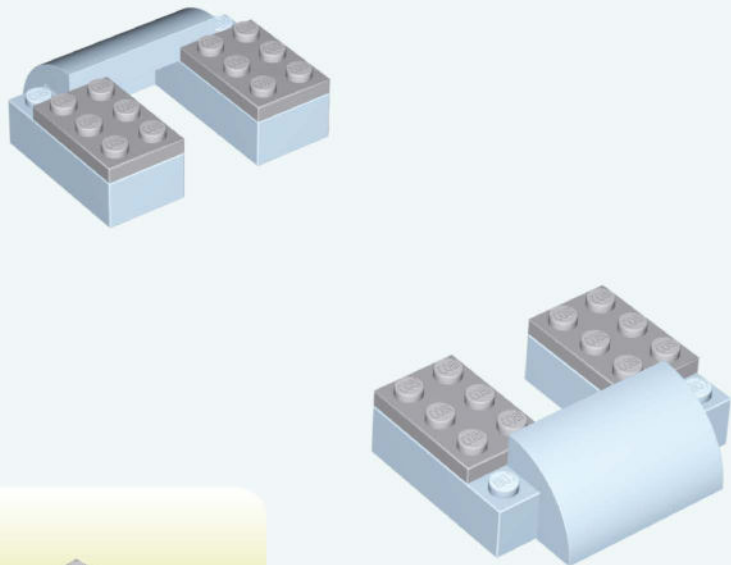

-  x4

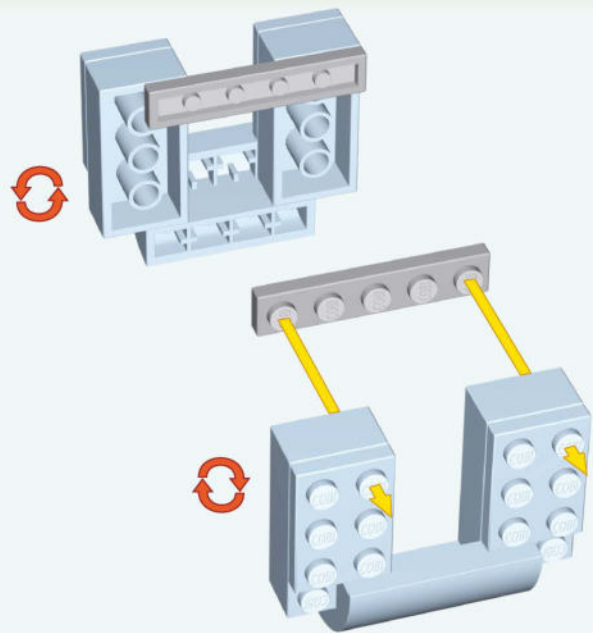

57

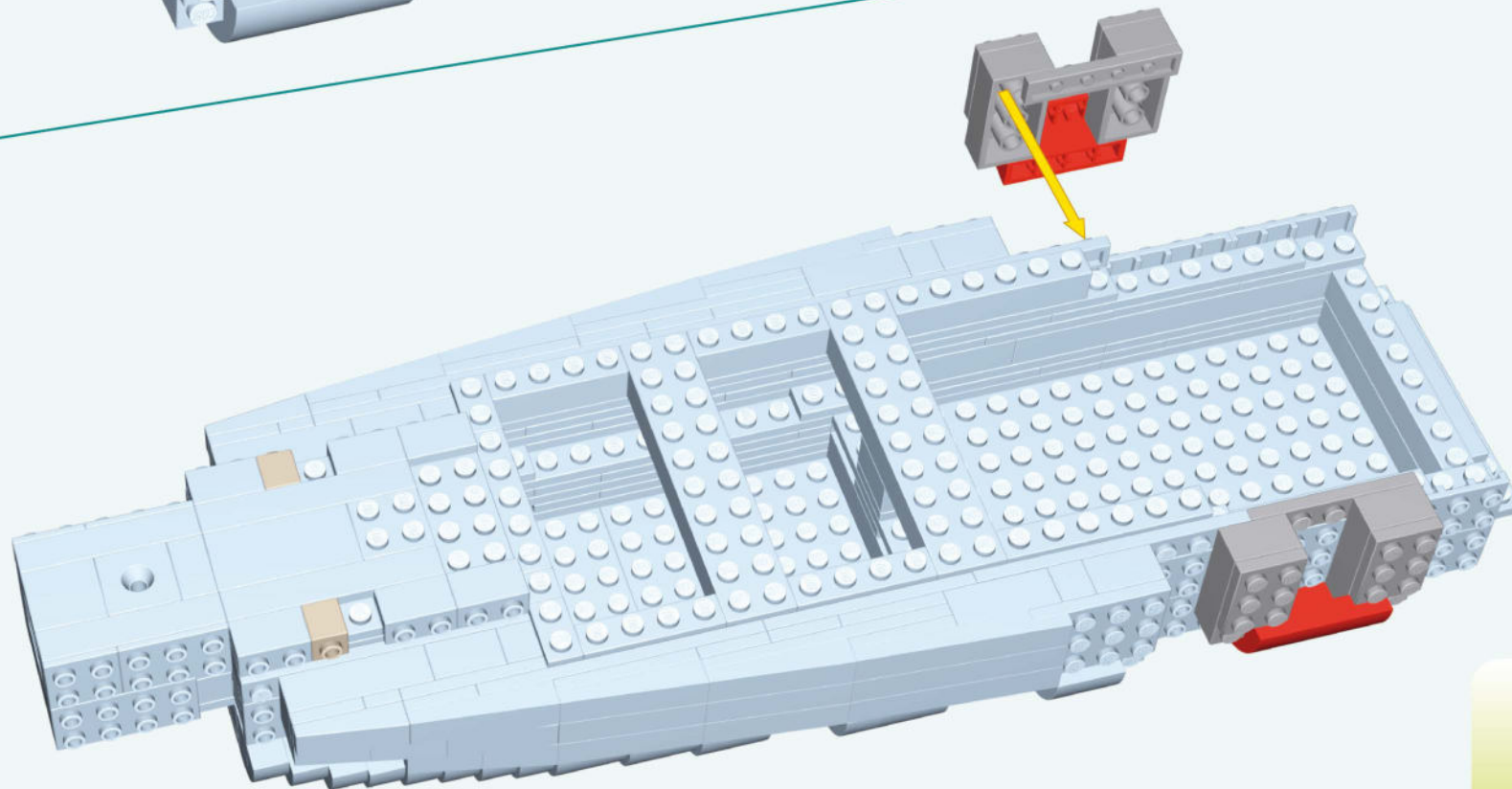

58

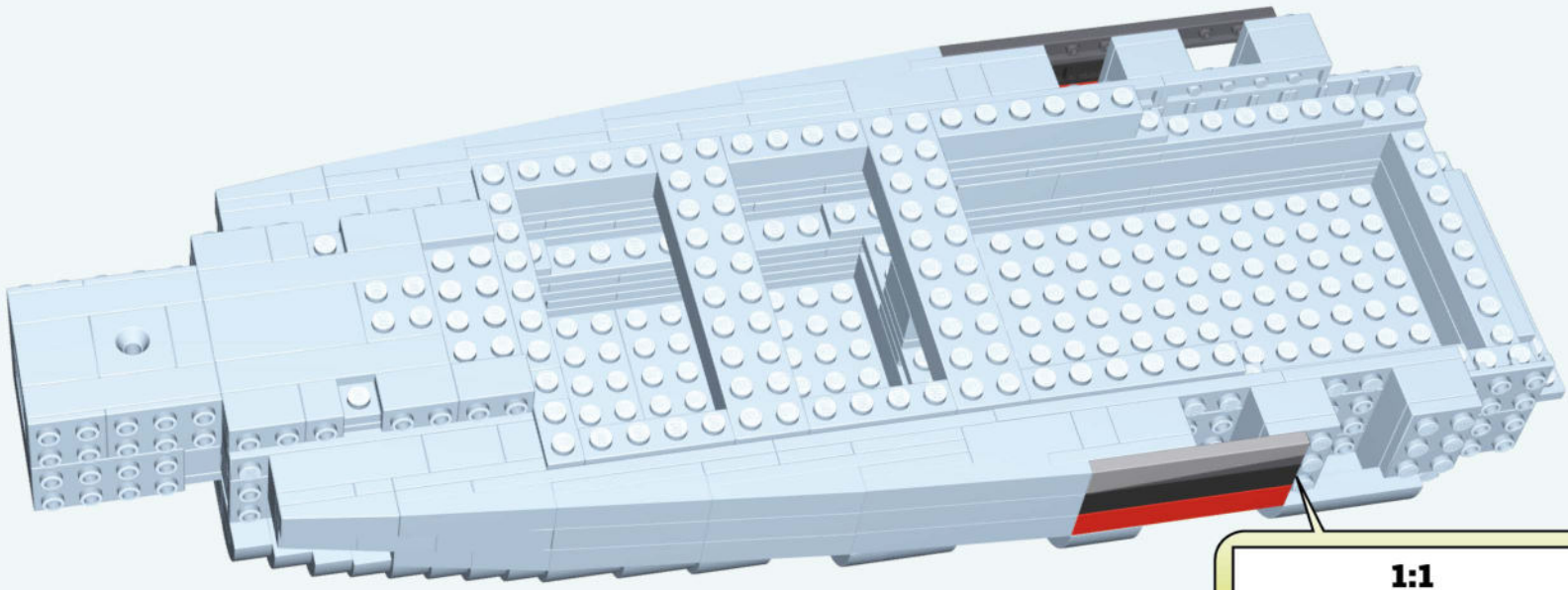
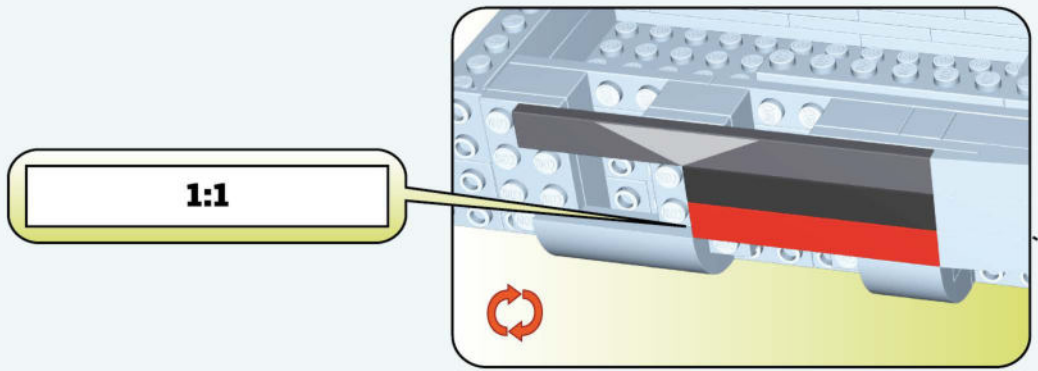

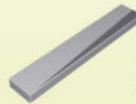

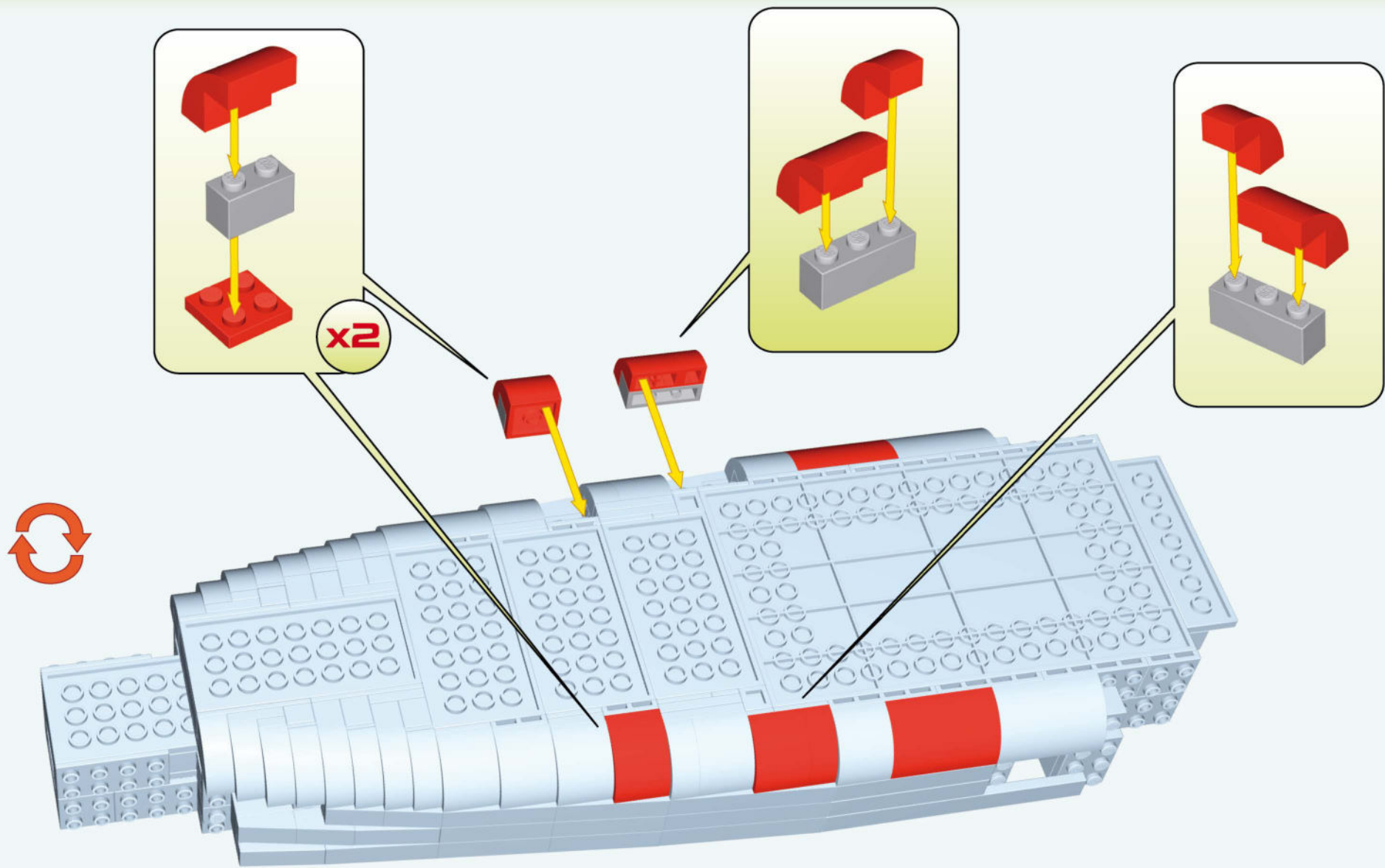

-  x1
-  x1
-  x2
-  x2







x2

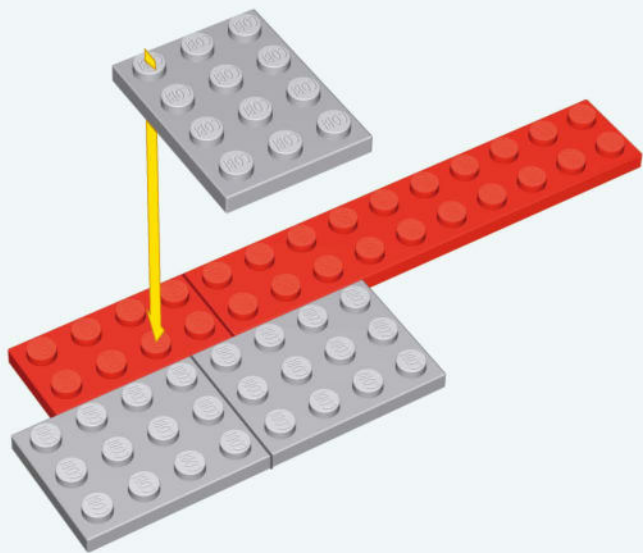

-  x2
-  x2
-  x4
-  x2
-  x2
-  x2



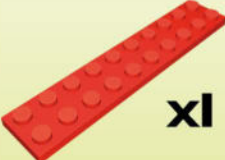

61

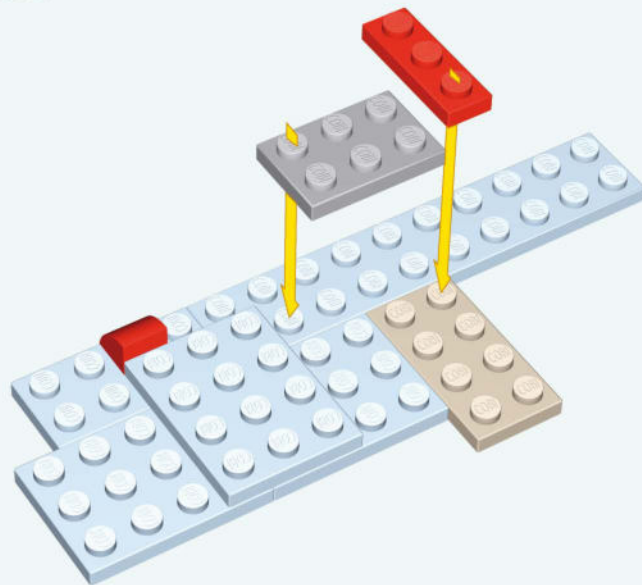

-  x1
-  x1
-  x3





62

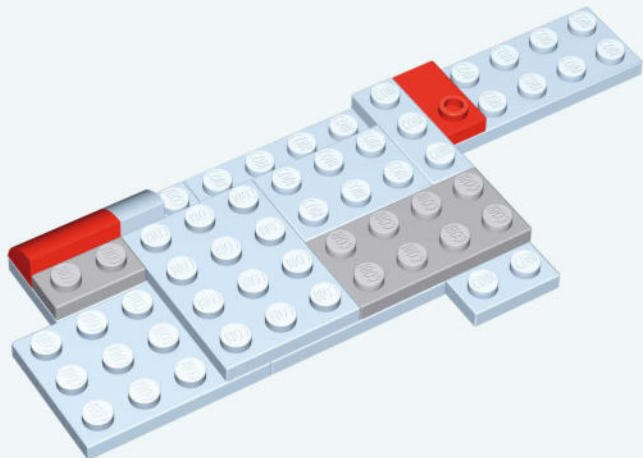

-  x1
-  x1
-  x1
-  x1



63

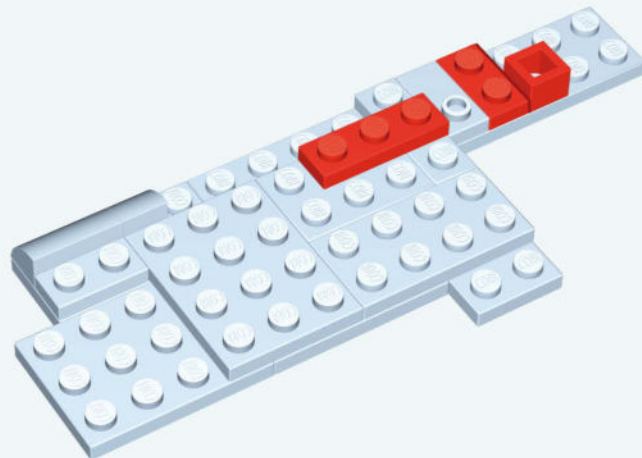

-  x1
-  x1
-  x1
-  x1

64



-  x1
-  x1
-  x1

65

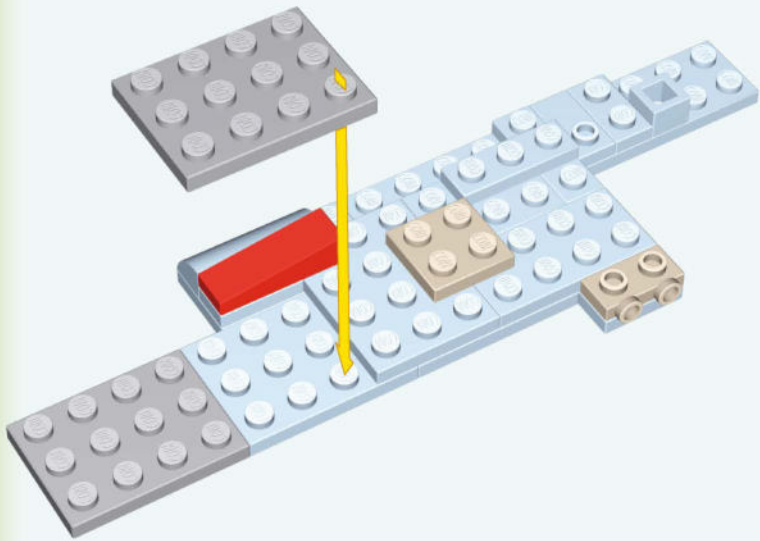

24
x1

x2

x1

x1

66

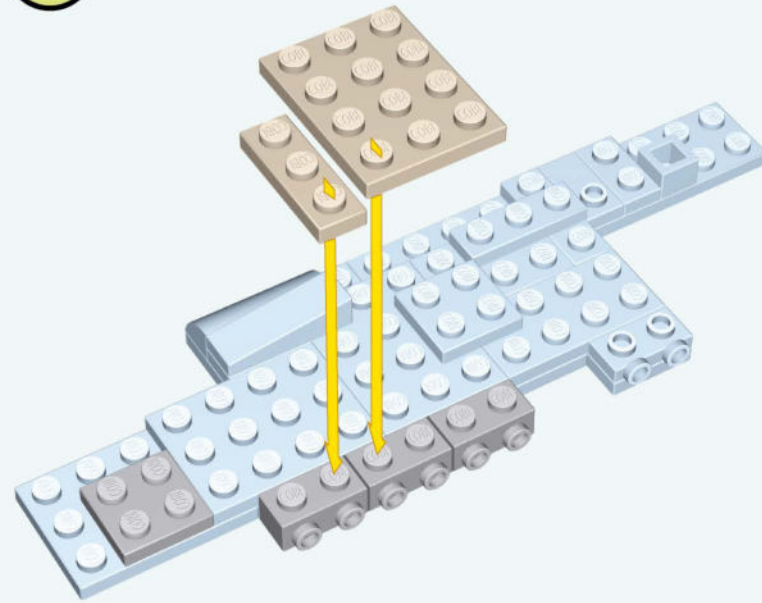

x1

x3

x1

x1

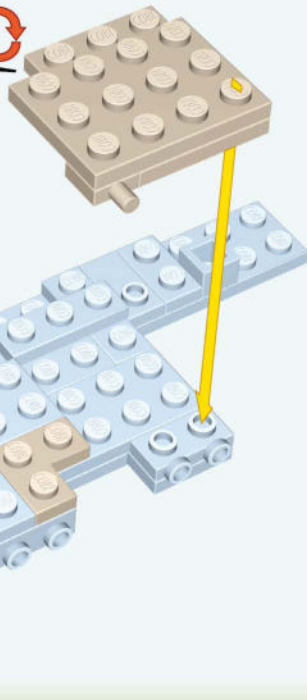
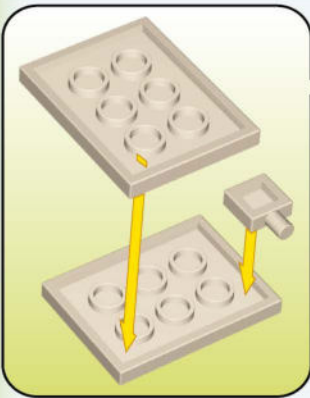

67

x1

x2

x1

68

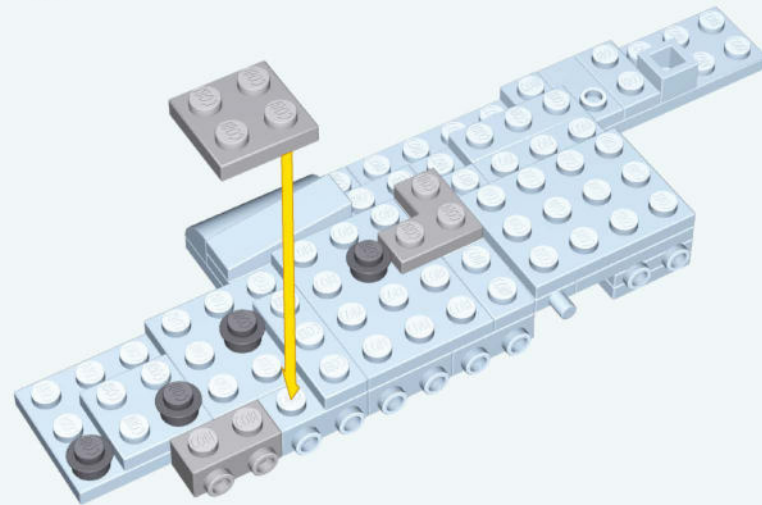

x1

x1

x1

x4

69

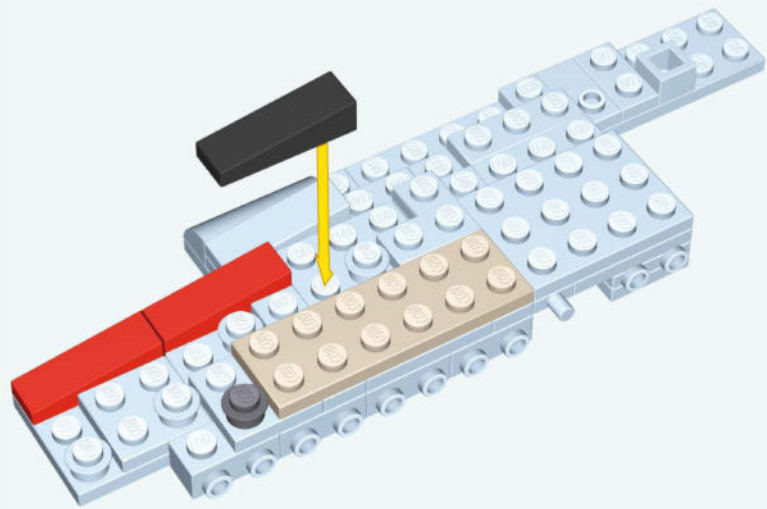

-  x2
-  x1
-  x1
-  x1



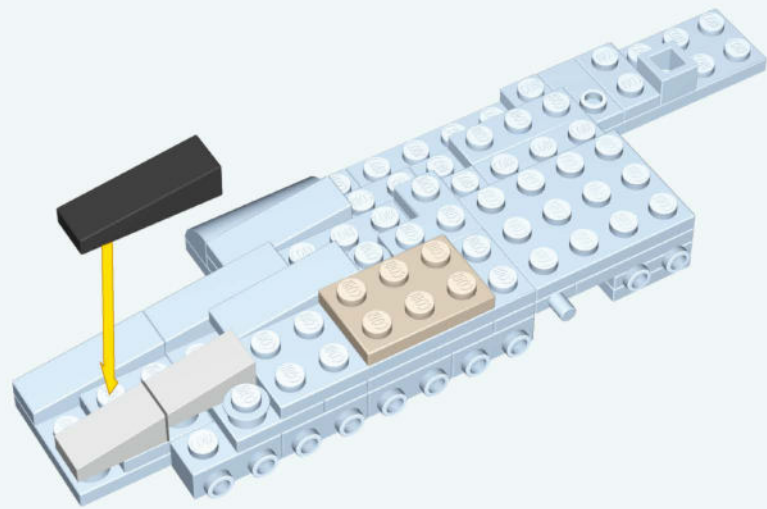

70

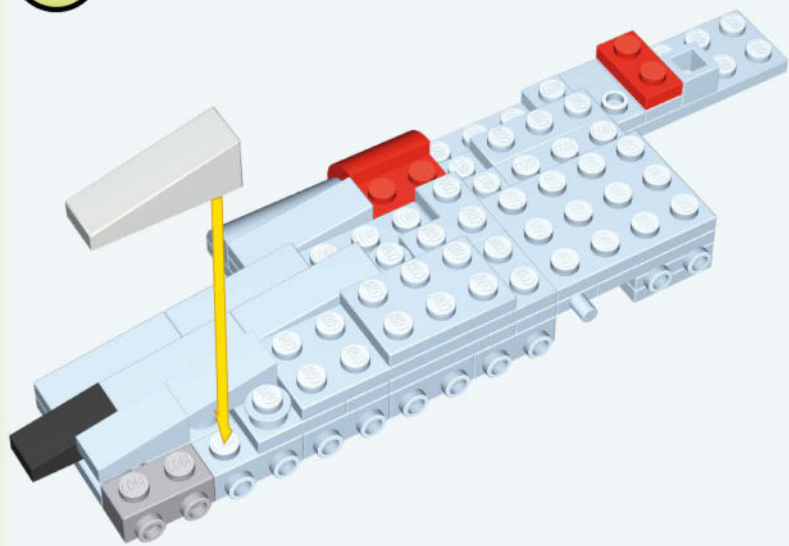

-  x2
-  x1
-  x1





71

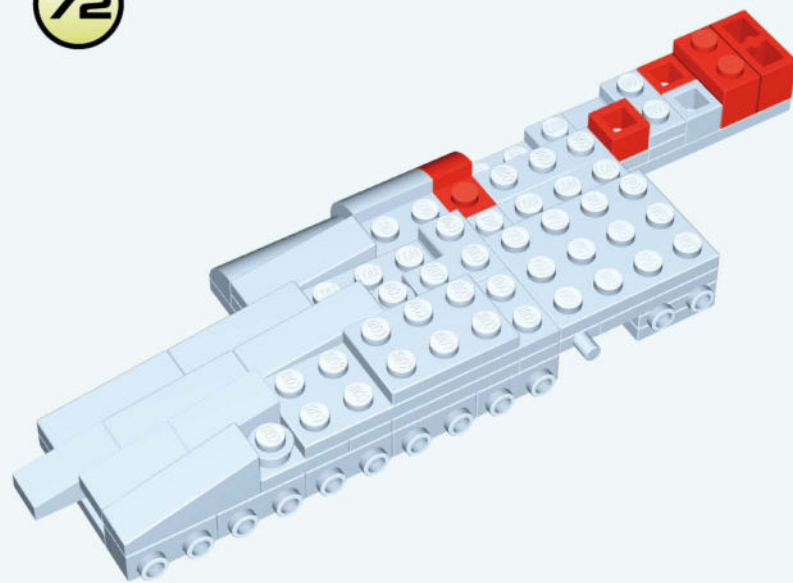

-  x1
-  x1
-  x1
-  x1
-  x1

72



-  x1
-  x2
-  x1
-  x1

73

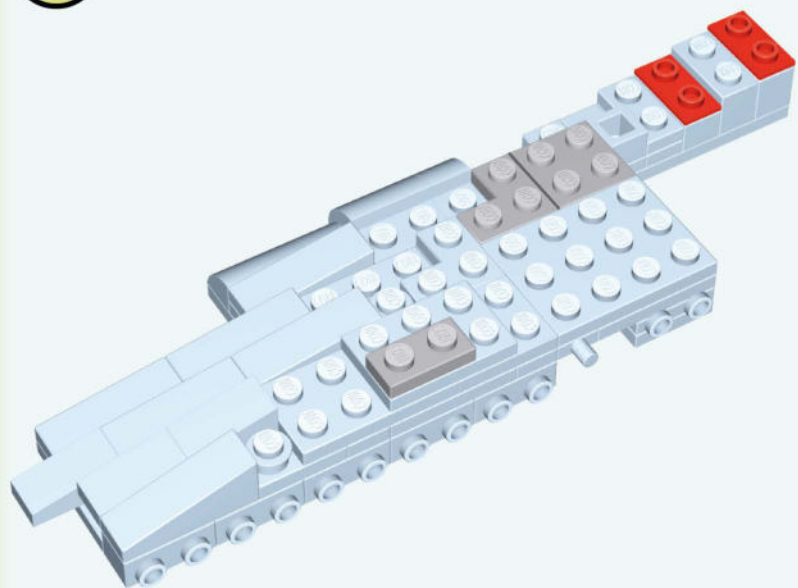

 x1

 x1

 x1

 x2

74

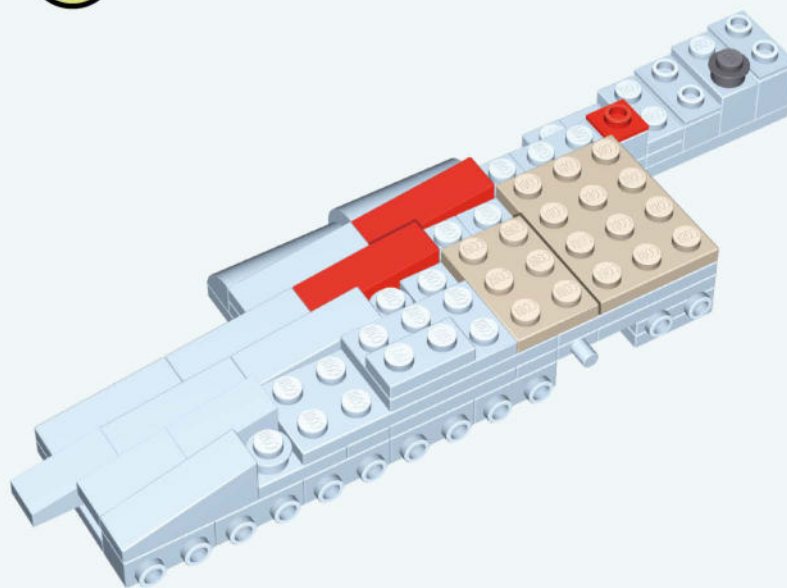

⁽²⁴⁾  x2

 x1

 x1

 x1

 x1

75

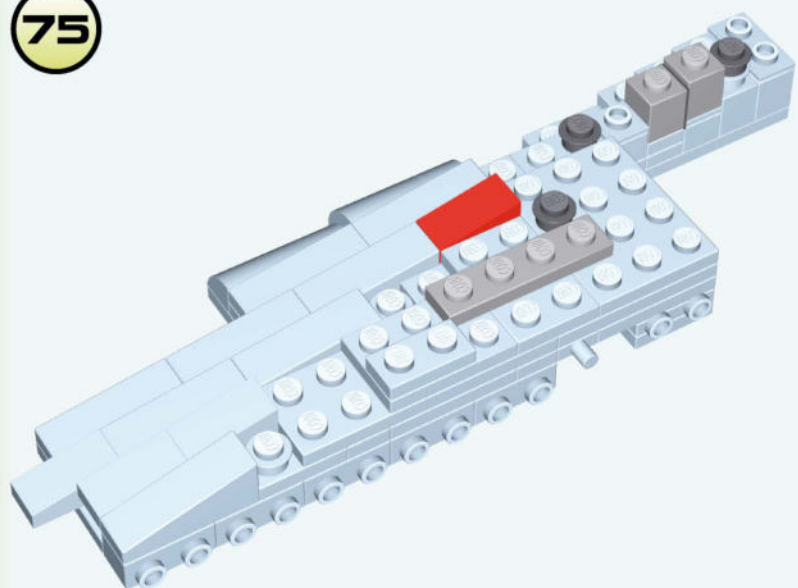

 x1

 x1

 x3

 x2

76

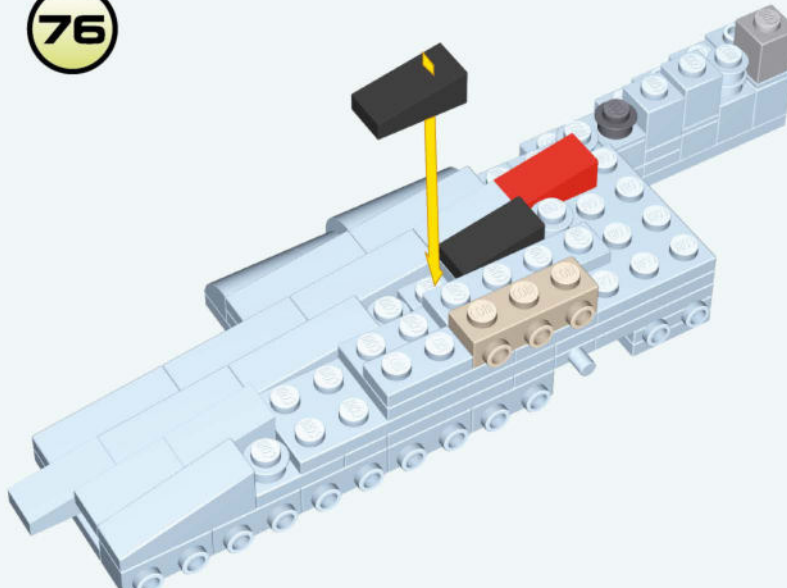

 x2

 x1

 x1

 x1

 x1

77

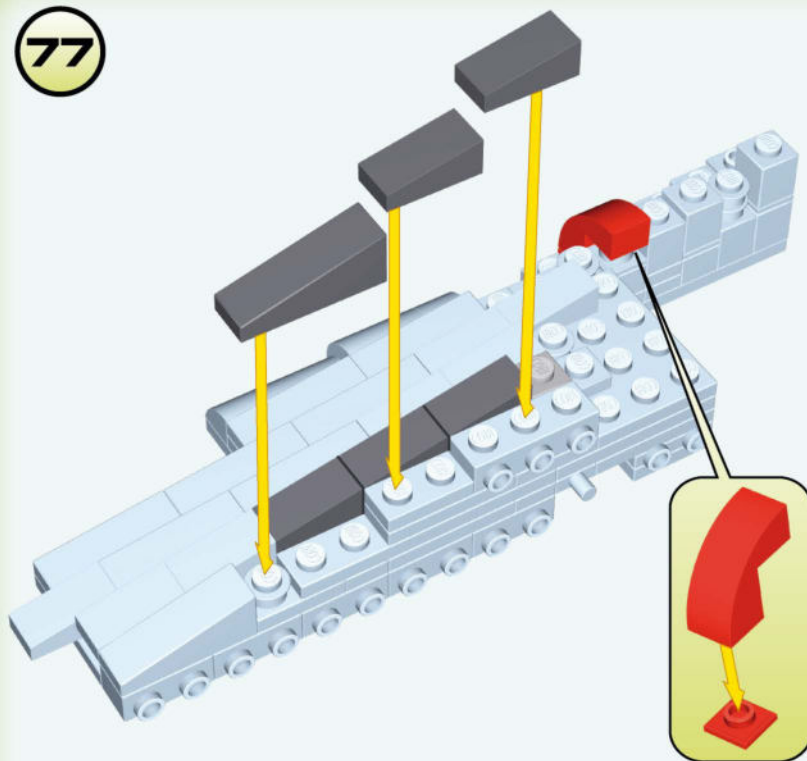

x5

x1

25 x1

x1

x1

78

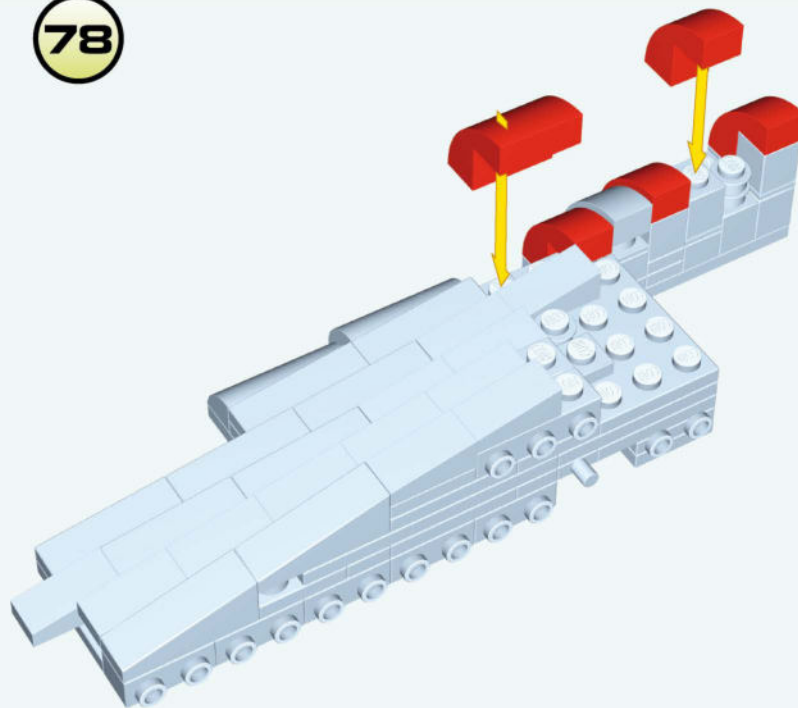

x1

x4

79

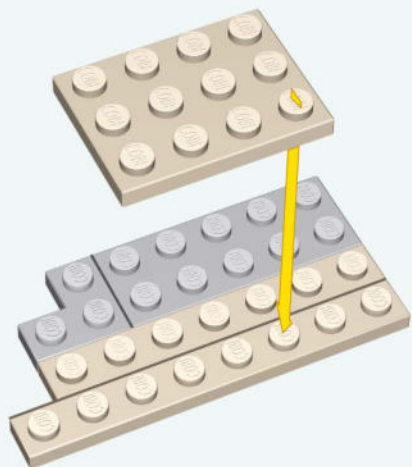

x1

x1

x1

x1

x1

80



x1

x1





x1

x1

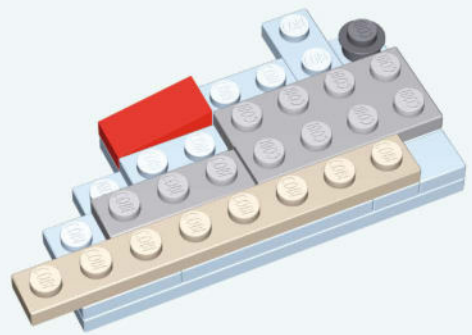
x1

81



-  xl
-  xl
-  xl
-  xl
-  xl



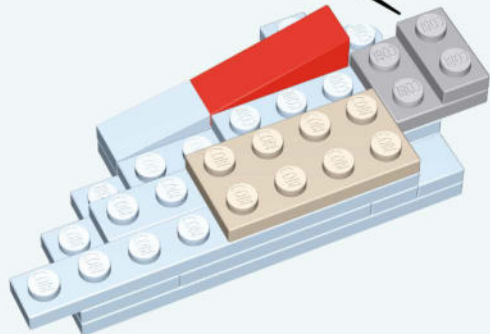
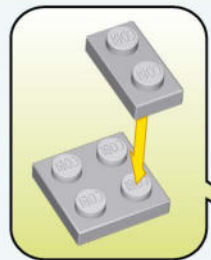

82

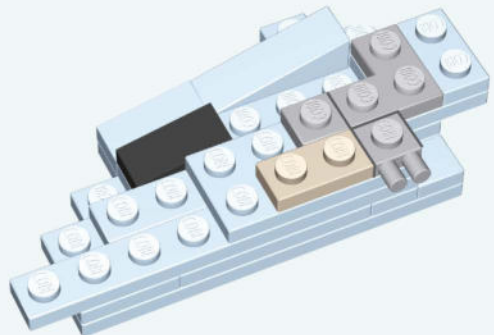

-  xl
-  xl
-  xl
-  xl



83

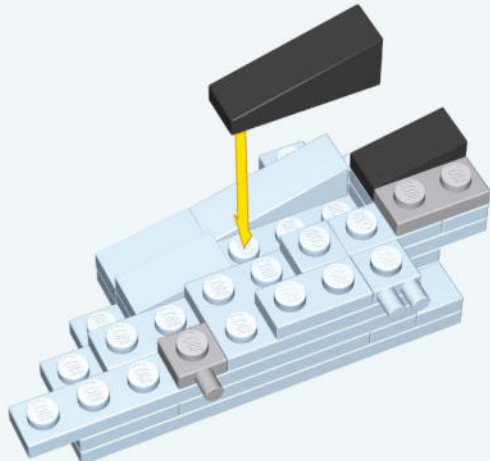

-  xl
-  xl
-  xl
-  xl
-  xl

84



-  xl
-  xl
-  xl
-  xl

85

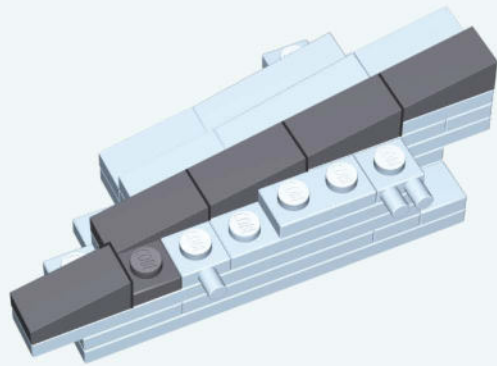

 x1

 x5

86

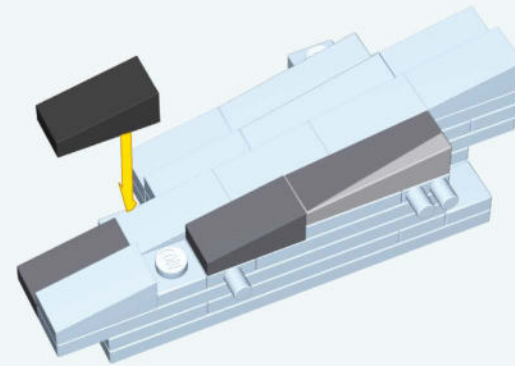

 x2

 x1

 x1

87

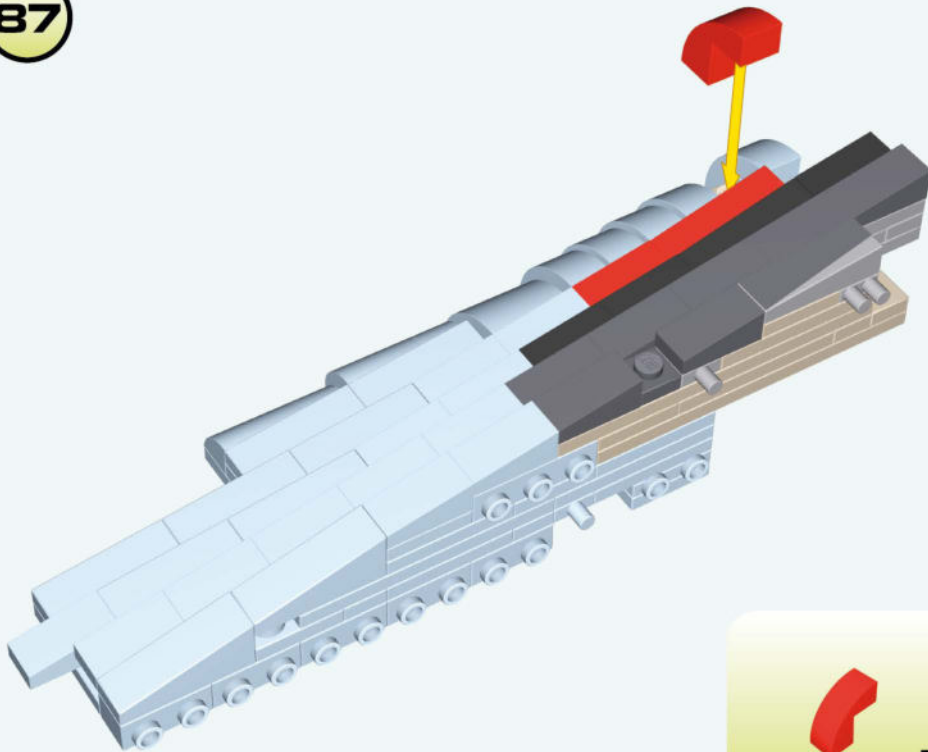

 x1

88

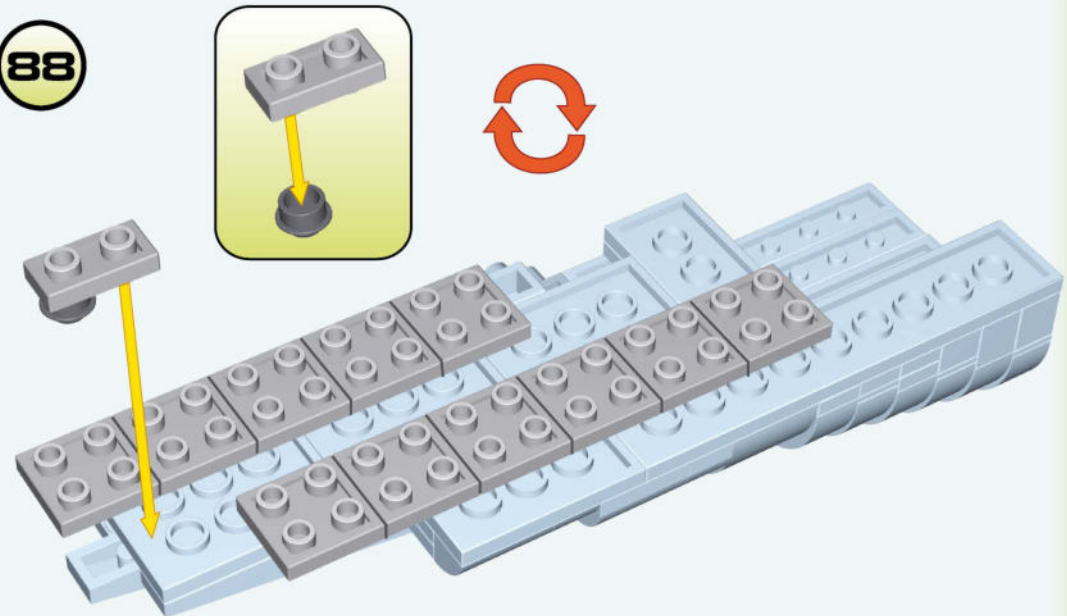

 x11

 x1

 x1



3

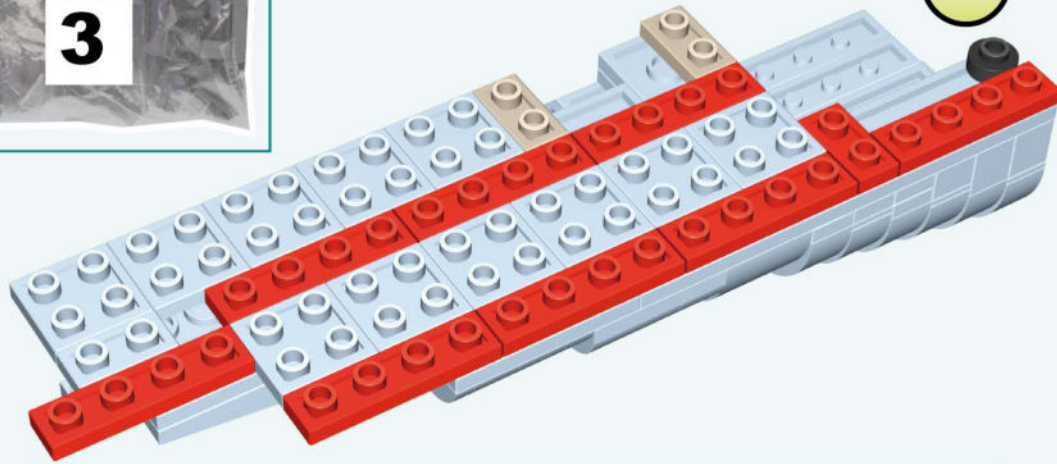

89



x8



x2



x1



x1

90

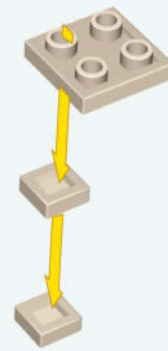

x2



x1

91

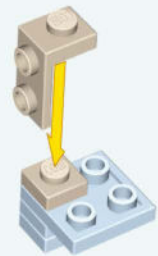

x1



x1

92

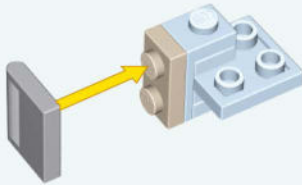

x1



x1

93

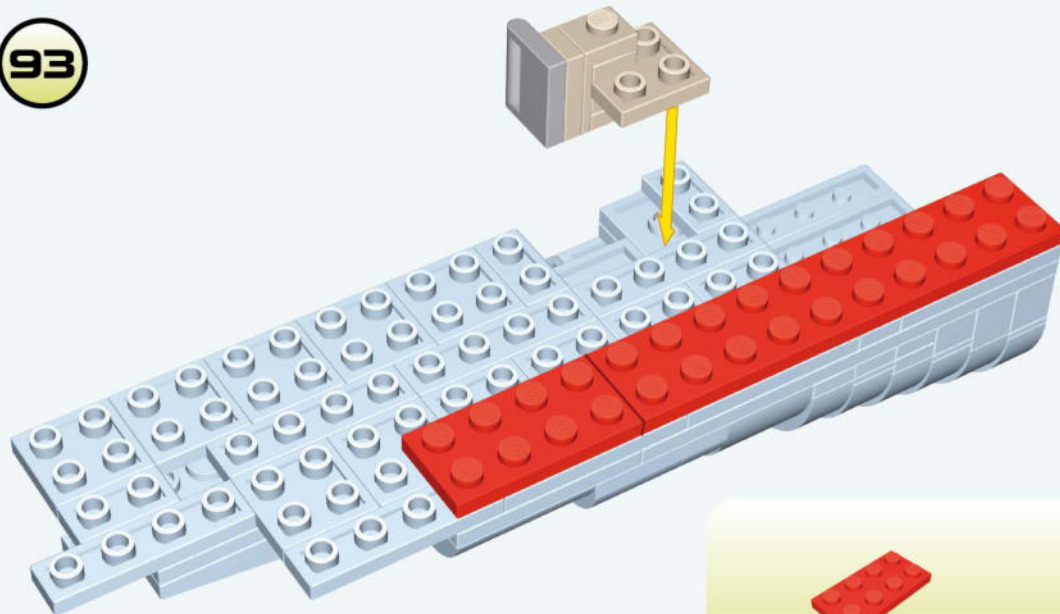

x1

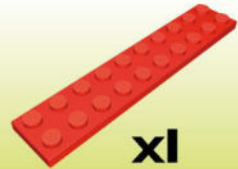

x1

94

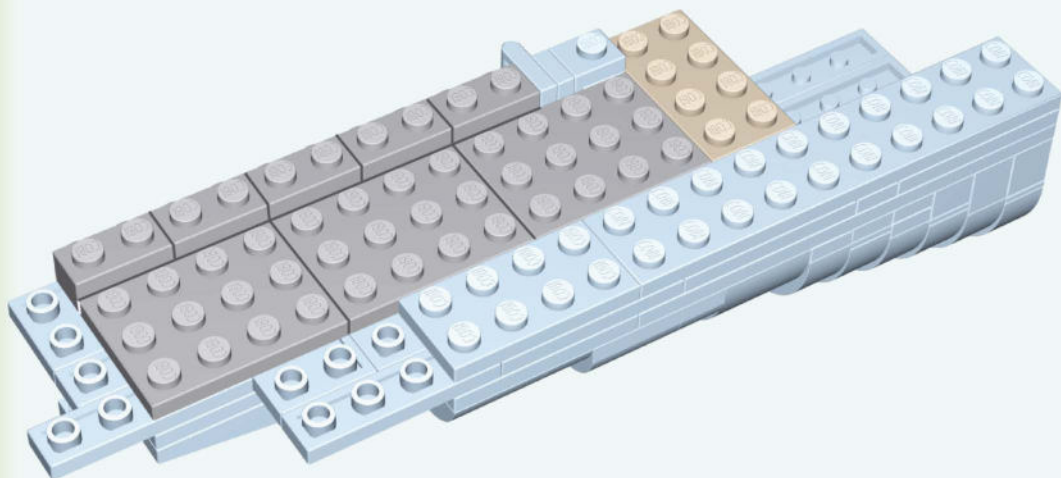

6



x5



x3



x1

95

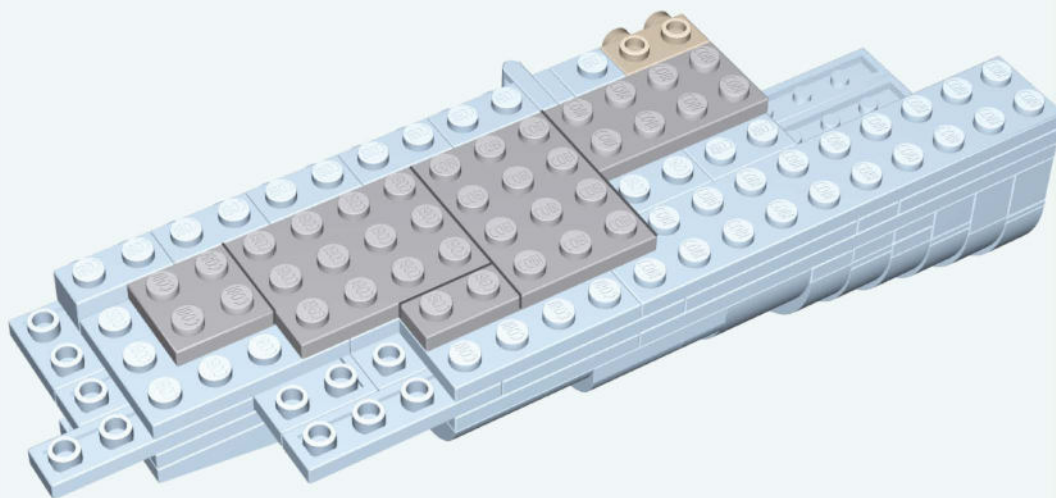

x1



x2



x1



x1



x1

96

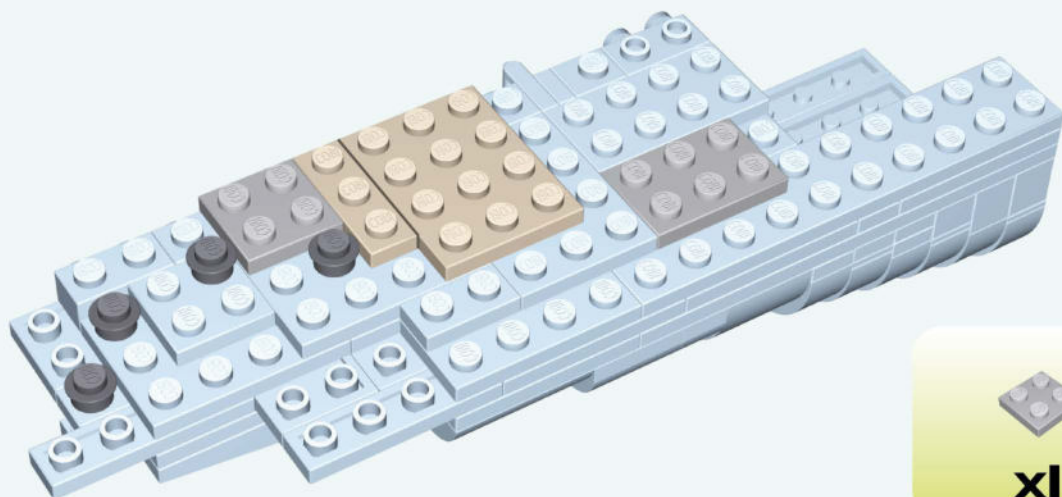

x1



x4



x1



x1



x1

97

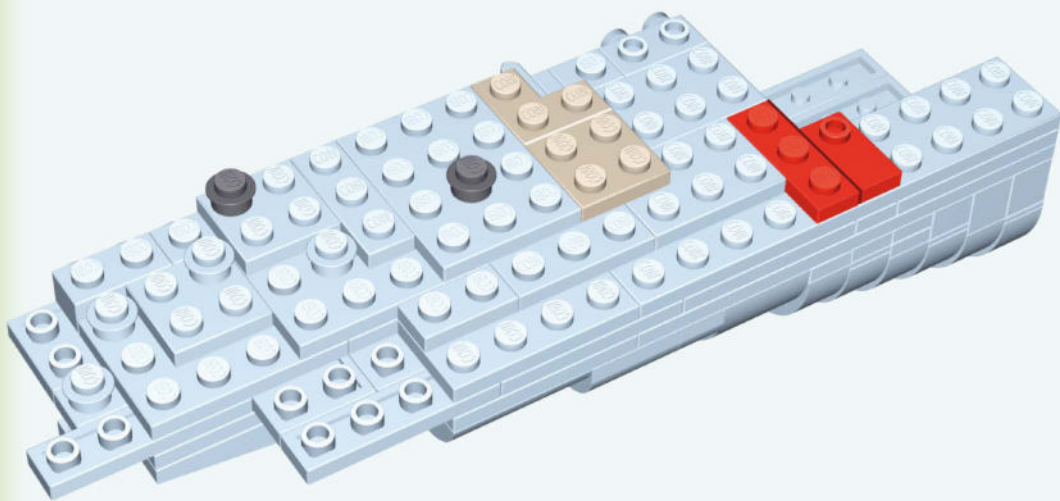

98

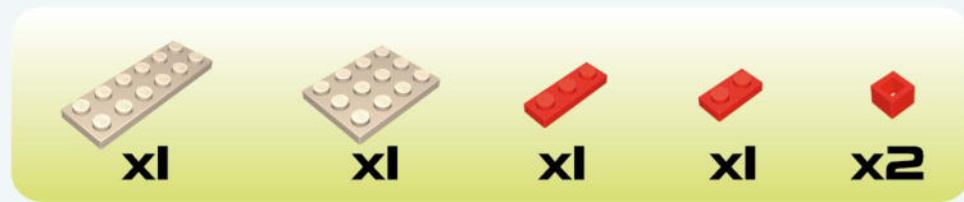
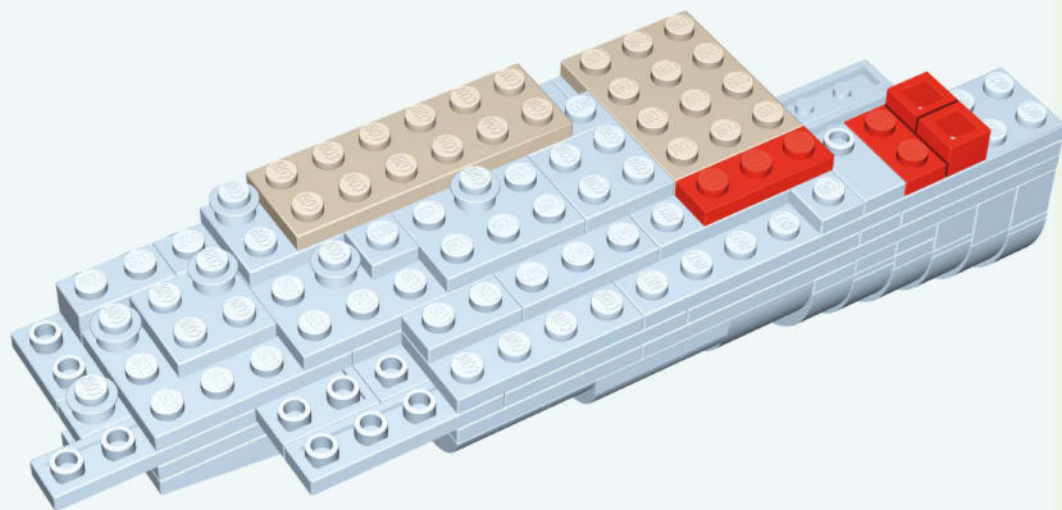

99

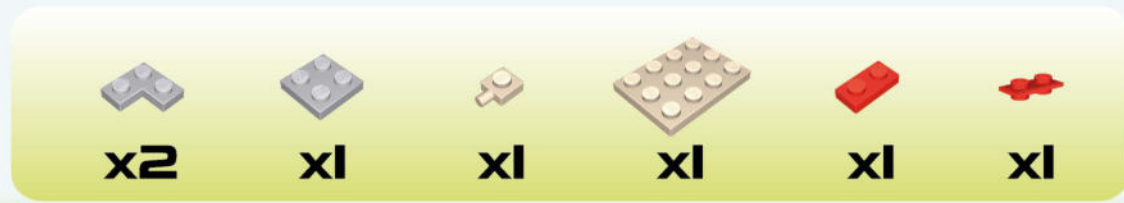
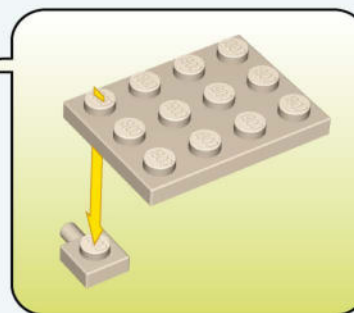
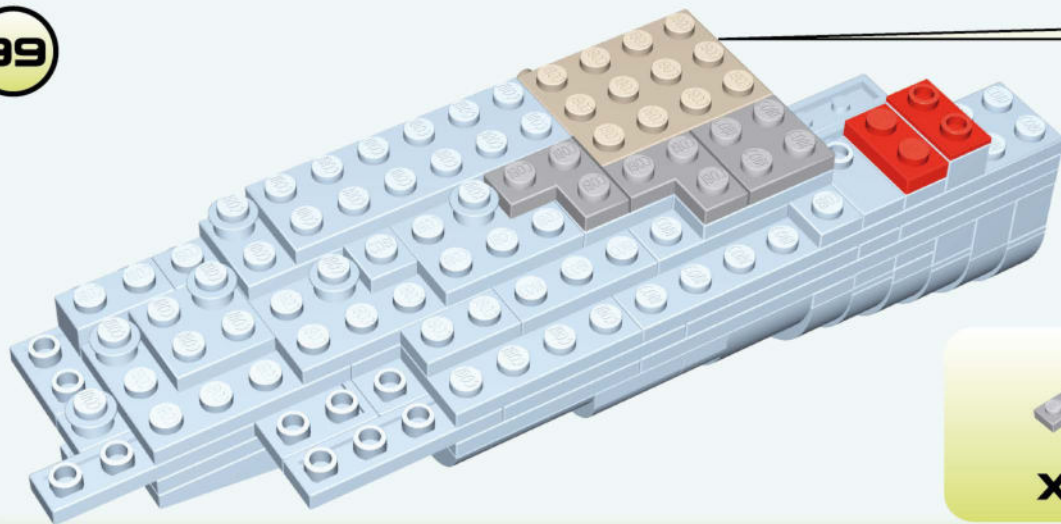

100

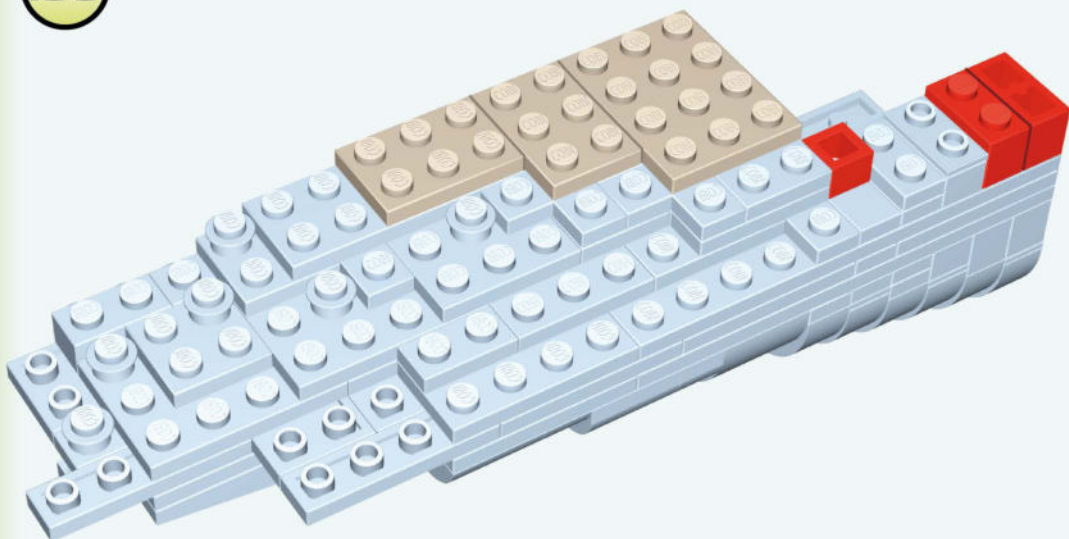

x2



x1



x1



x1



x1

101

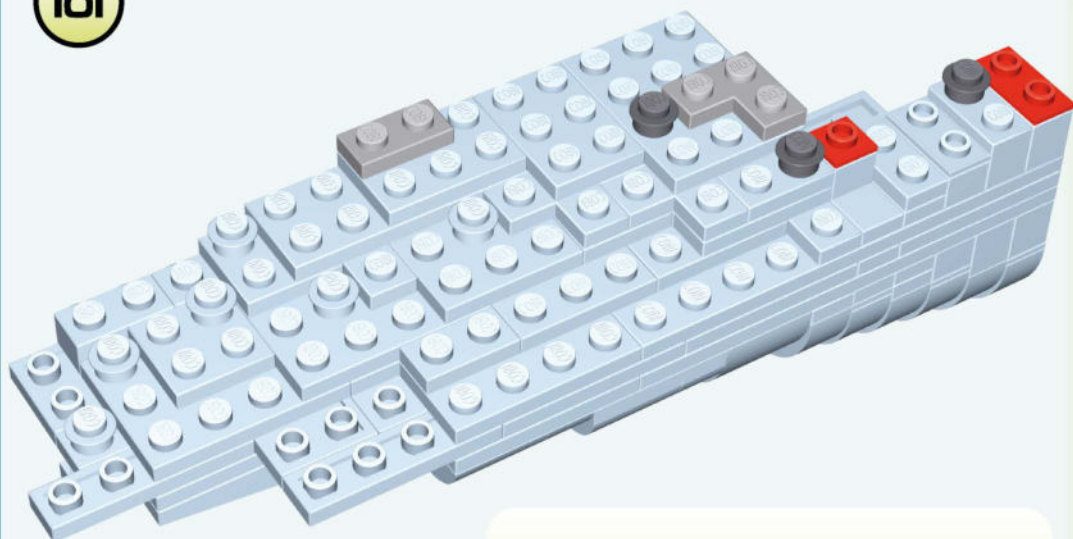

x1



x3



x1



x1



x1

102

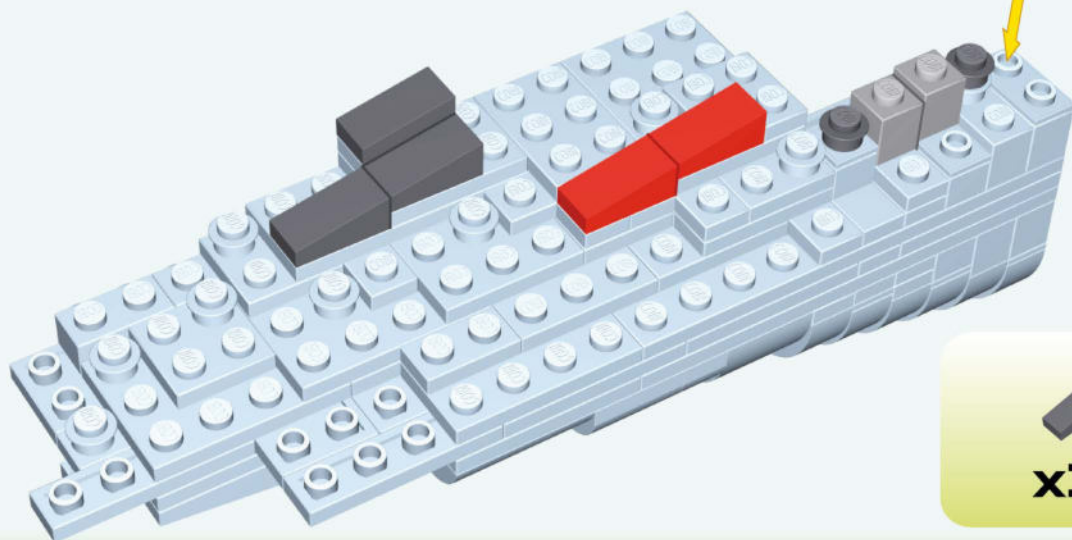

x3



x2





x2



x3

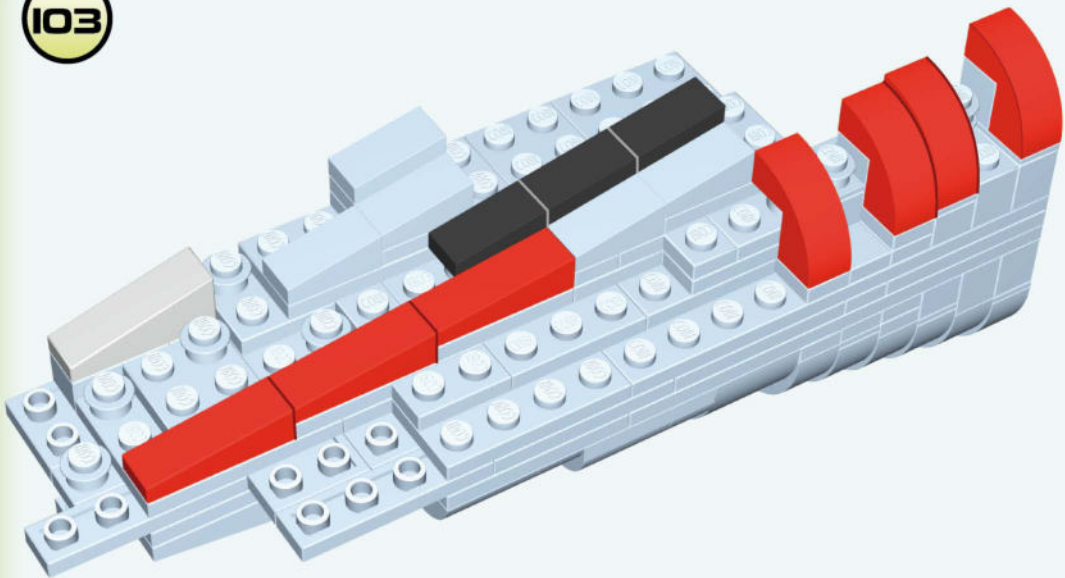



103

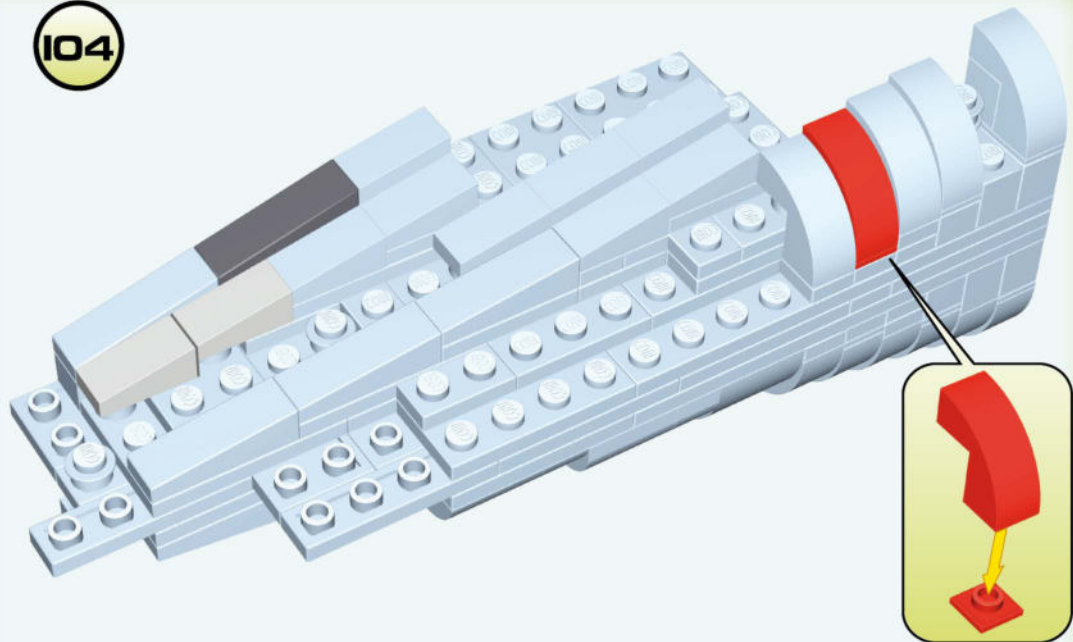

-  x1
-  x3
-  x3
-  x4





104

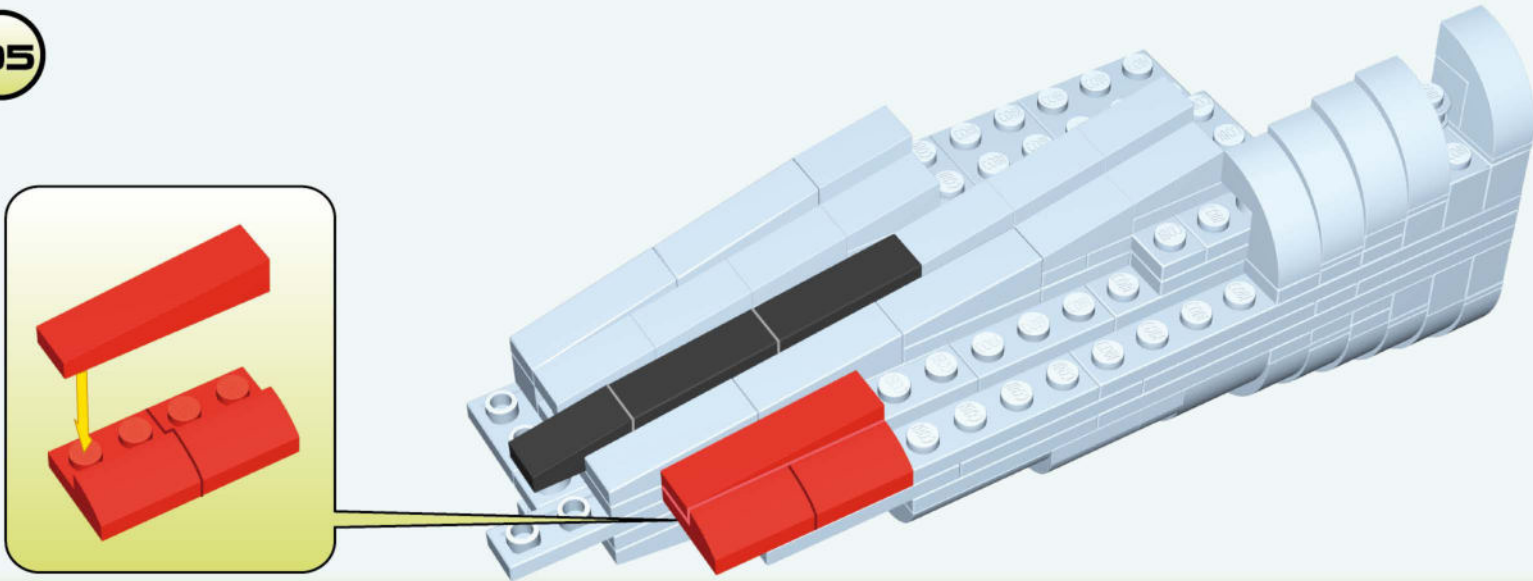

-  x2
-  x1
-  x1
-  x1







105

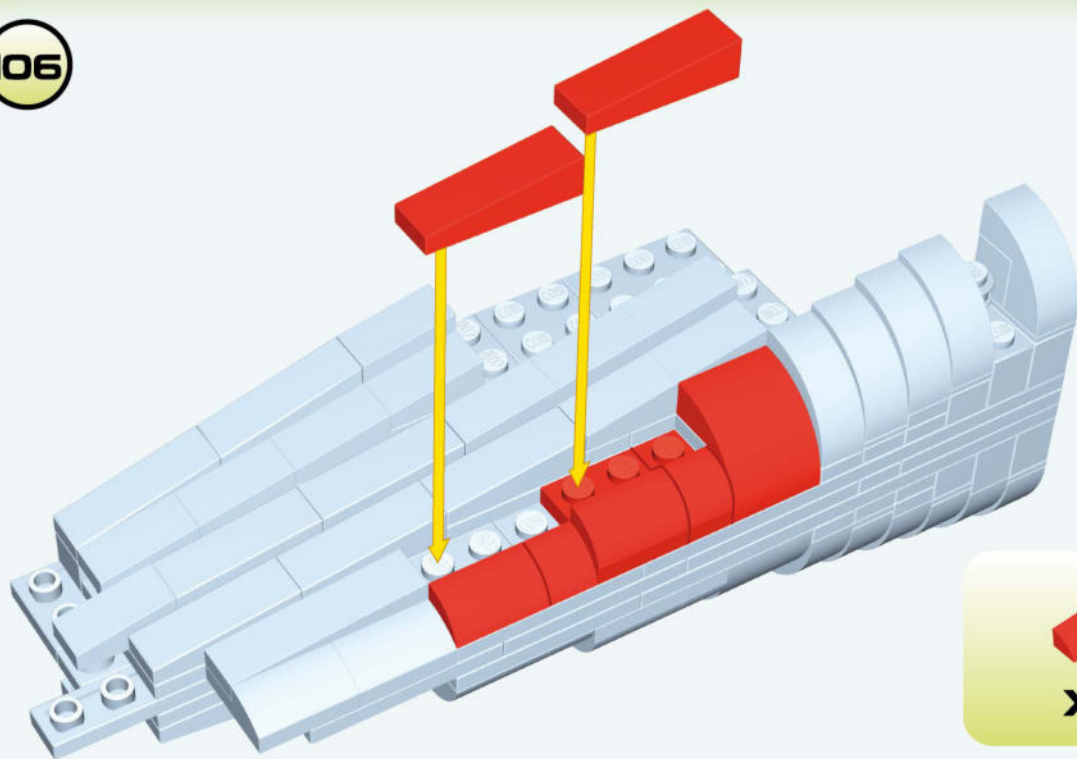

-  x1
-  x2
-  x2
-  x1





106

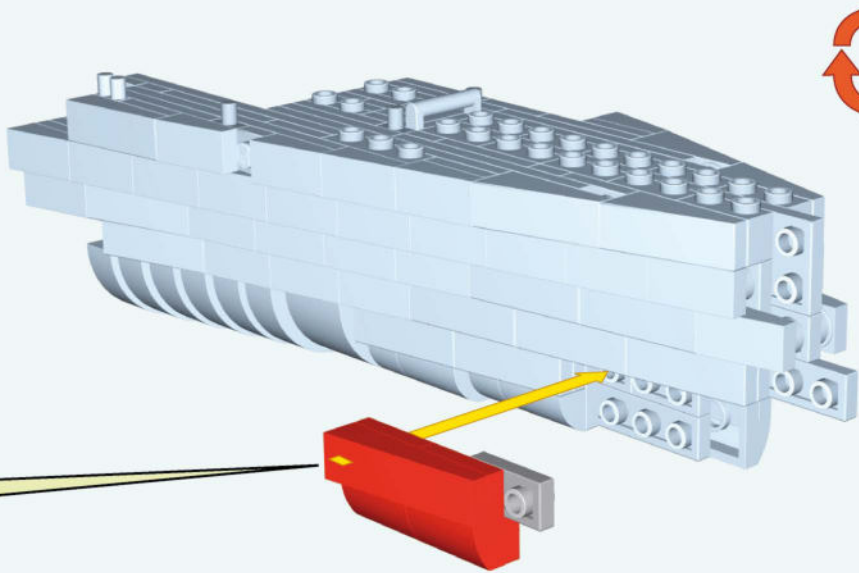
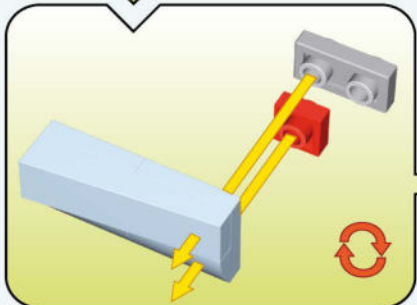
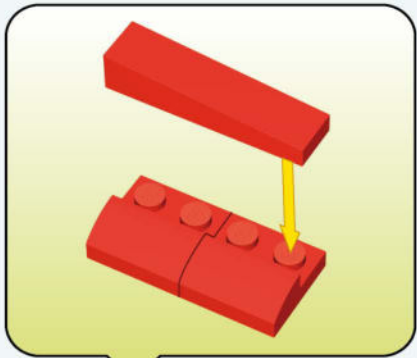

- 
x1
- 
x1
- 
x1
- 
x1
- 
x1
- 
x2

107



- 
x2
- 
x1
- 
x1
- 
x1

108

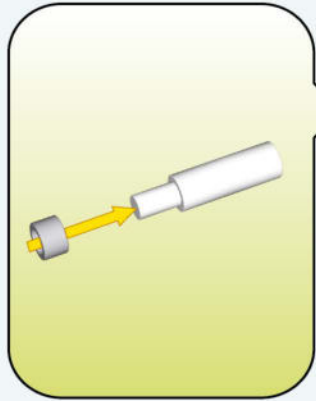

x2

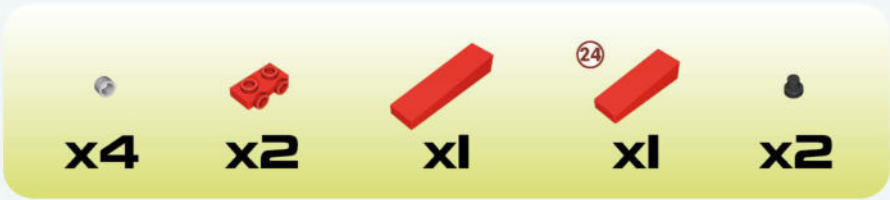
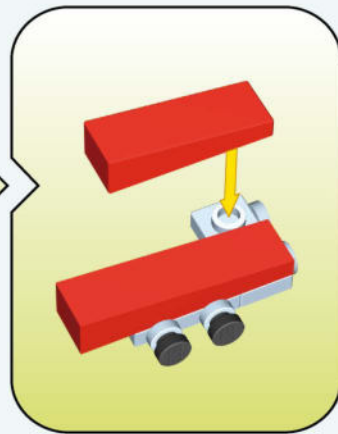
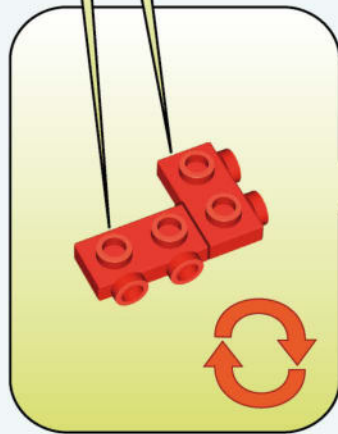
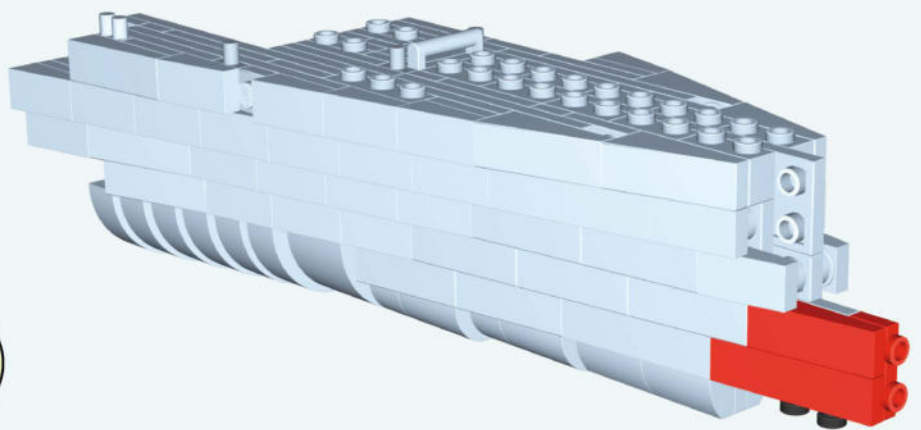

109

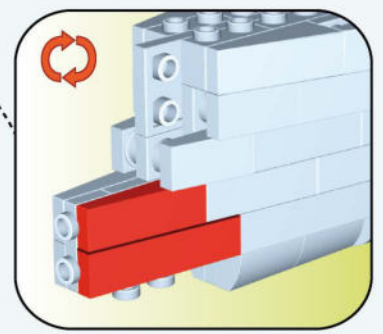
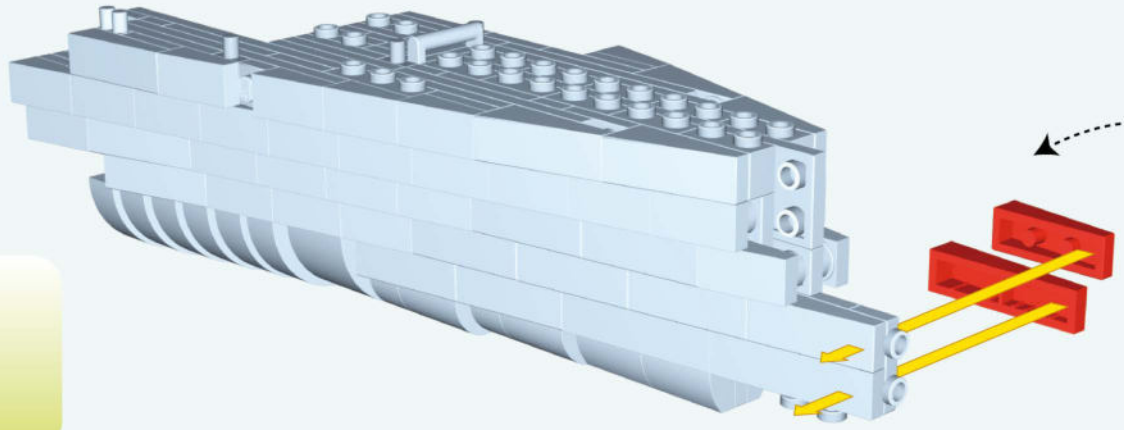

110

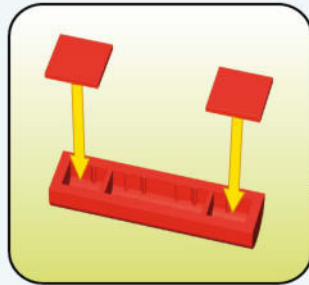
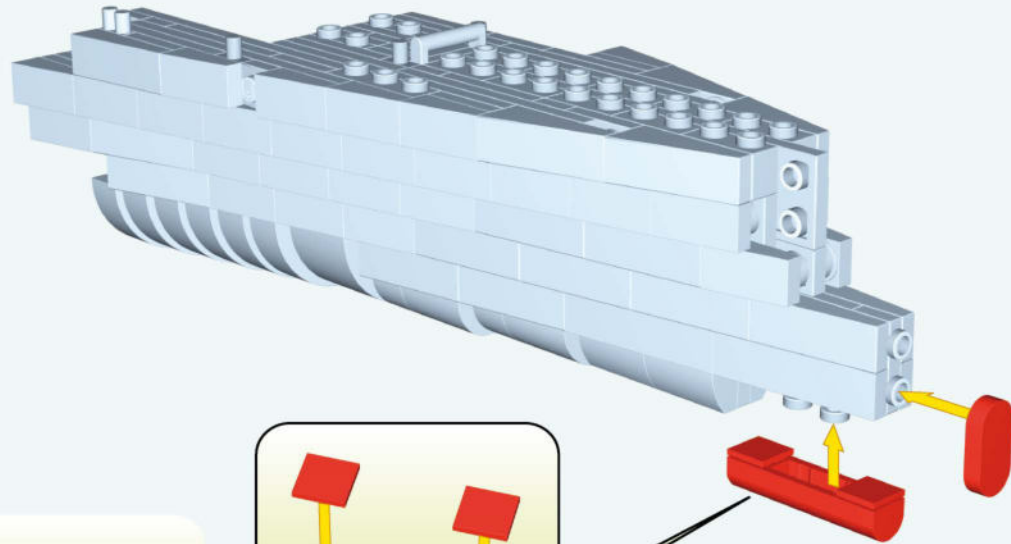

x1



x2



x1

111

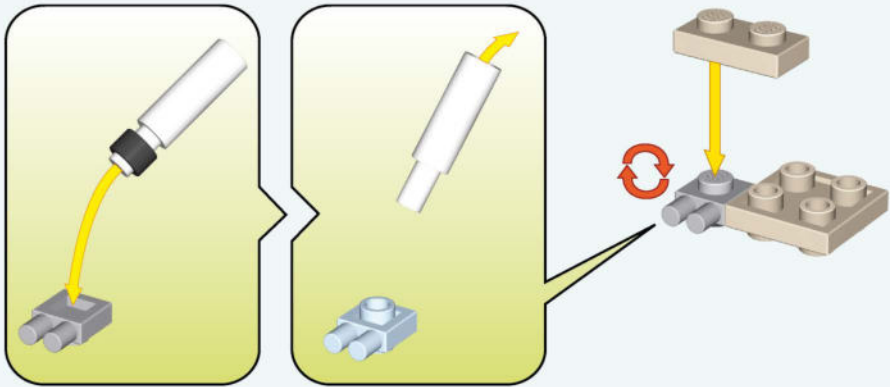

x1



x1



x1



x1

112

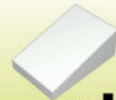
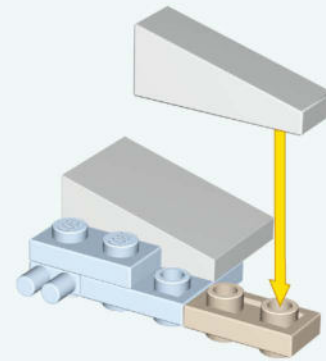

x1



x1



x1

113

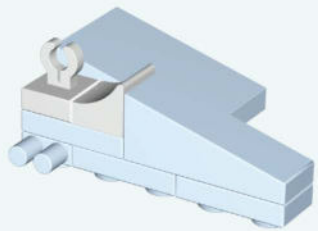

x1



x1

114

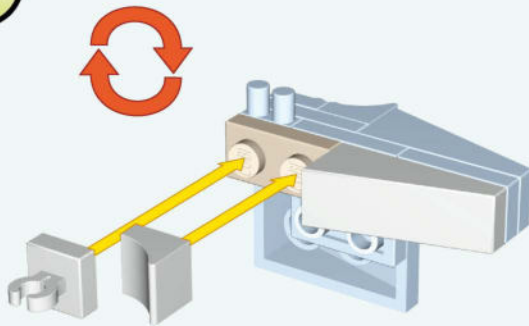

x1



x1



x1



x1

115

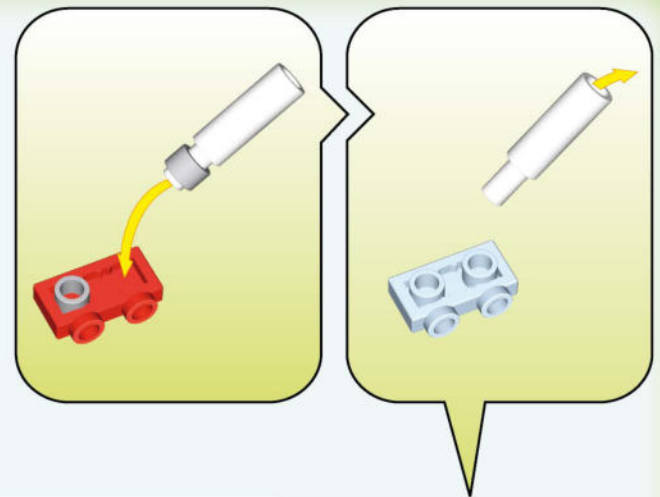

x1



x2



116

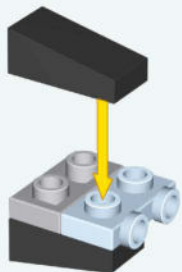

x1



x2

117

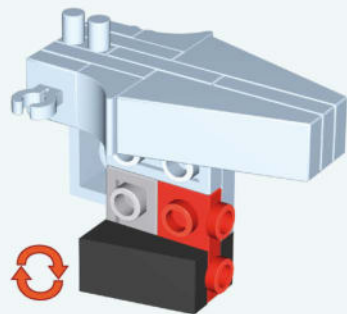

118

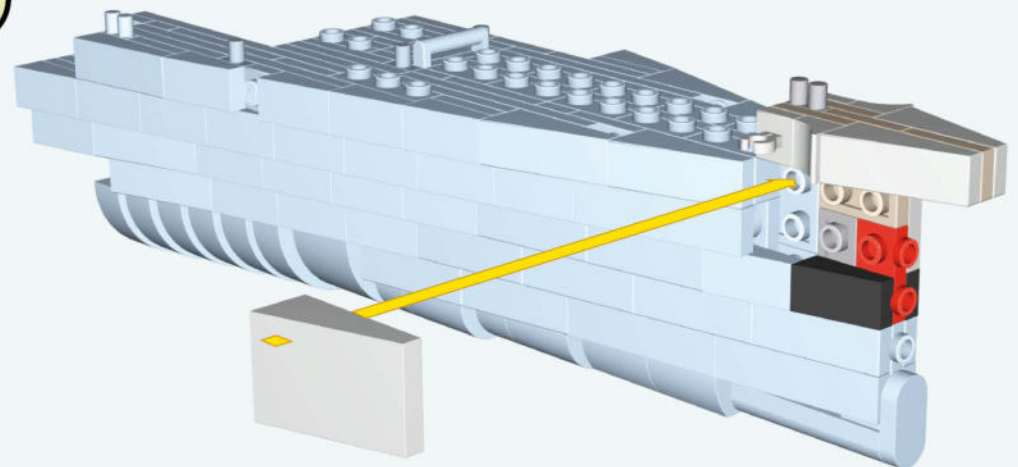

x1