

270 — 292

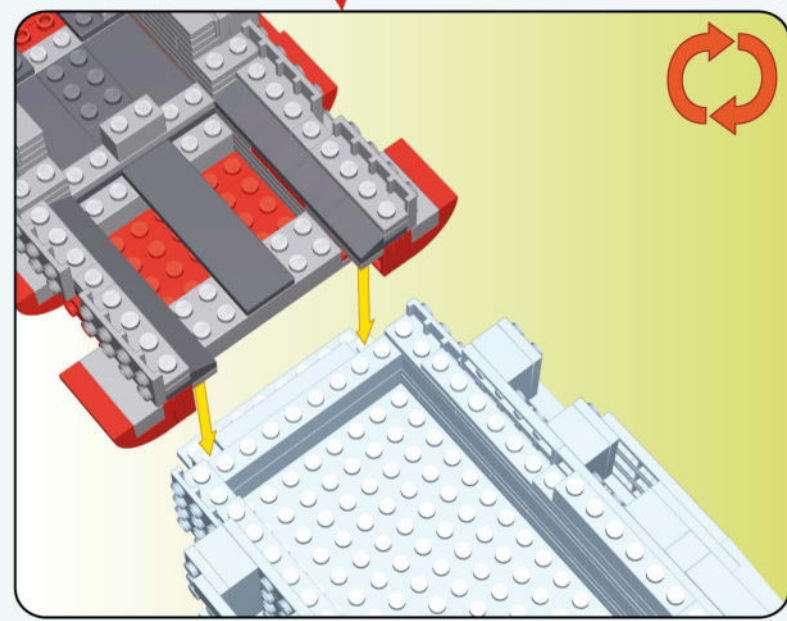

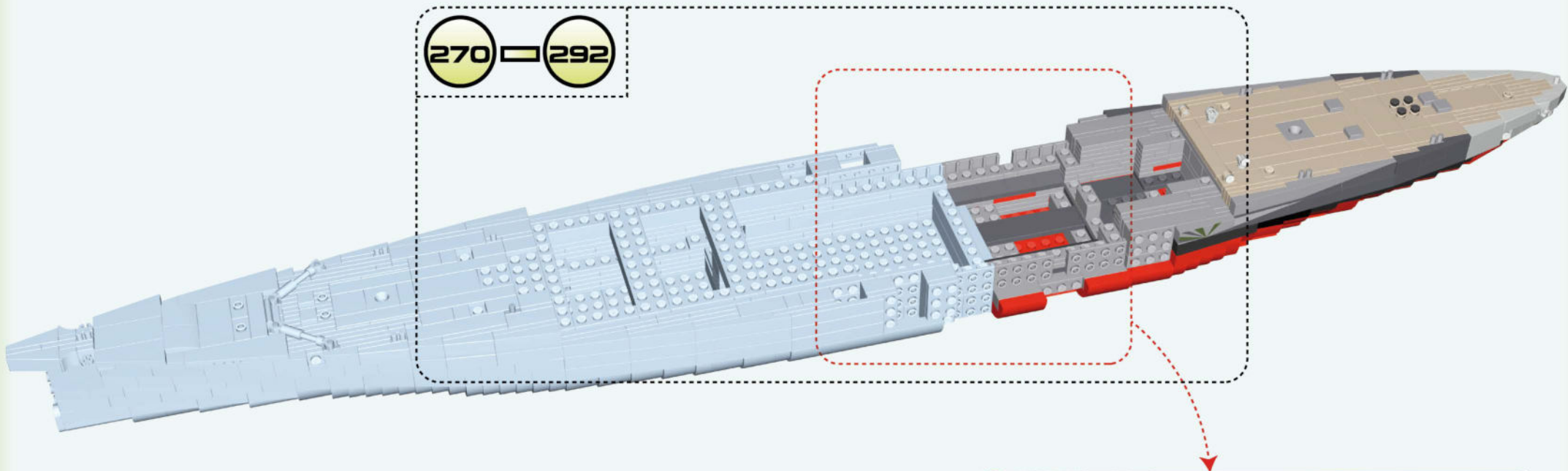

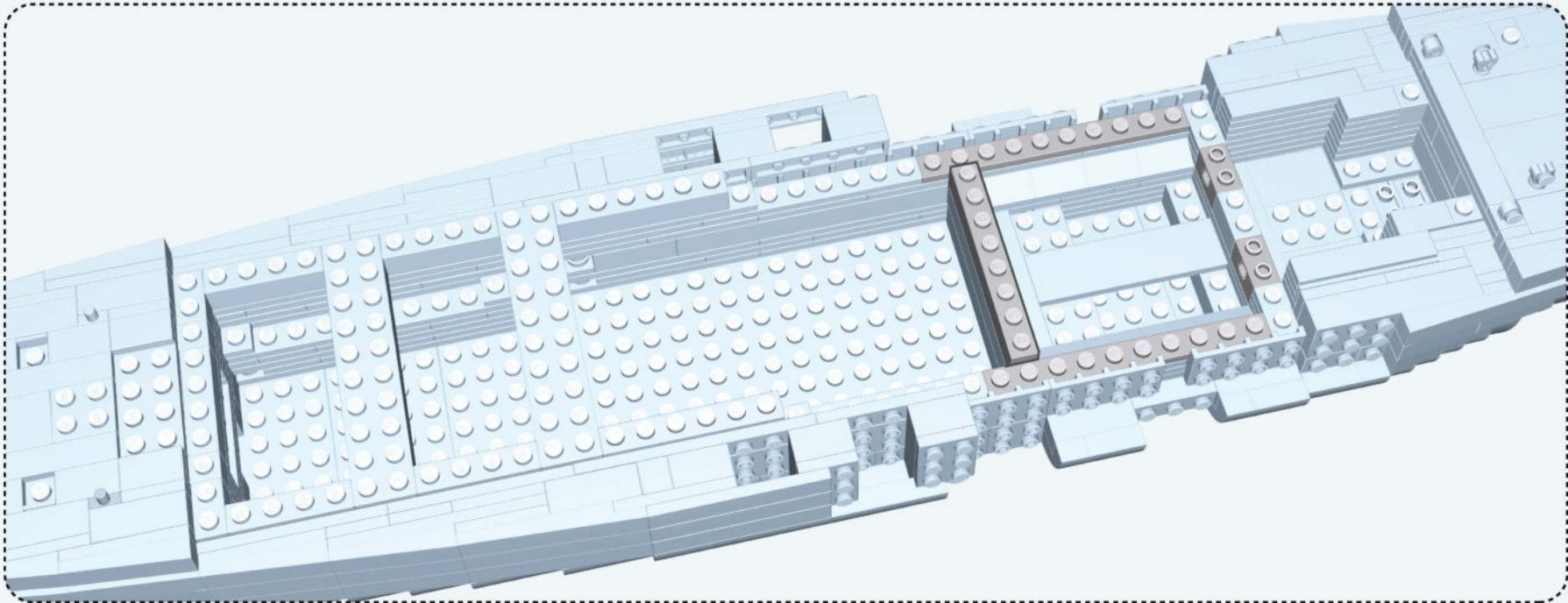

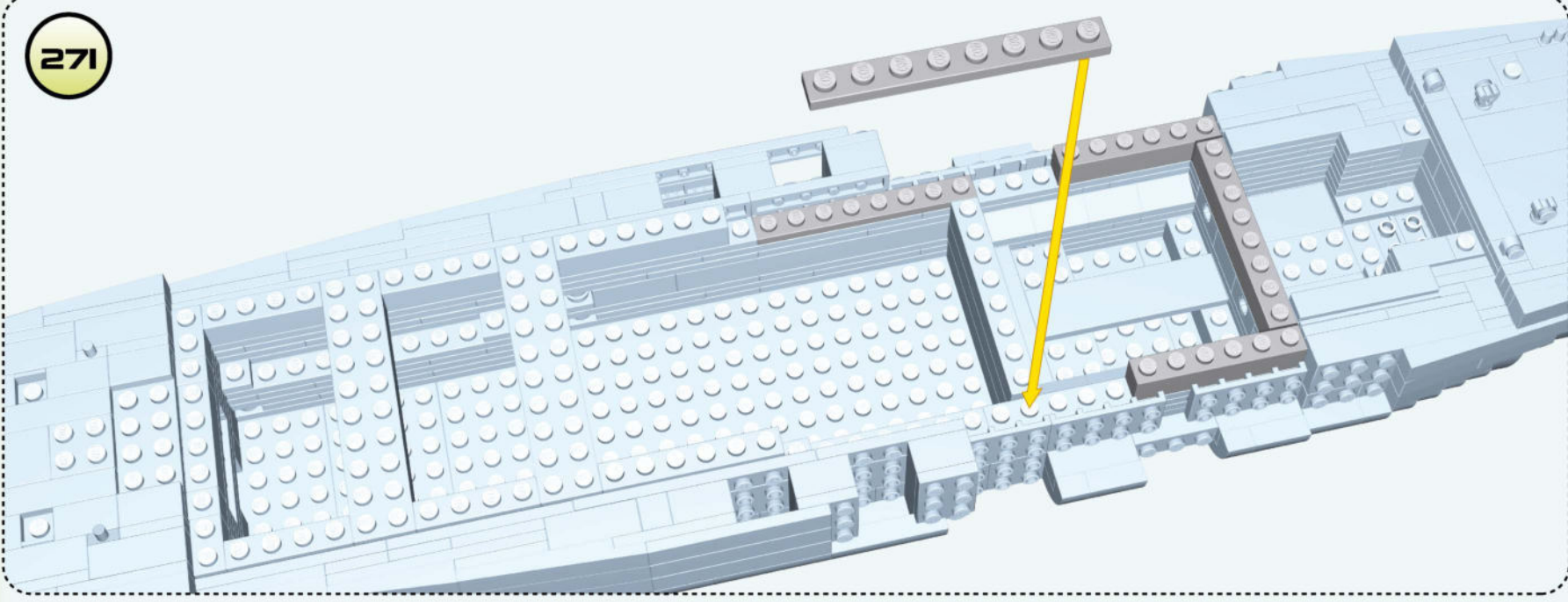

271

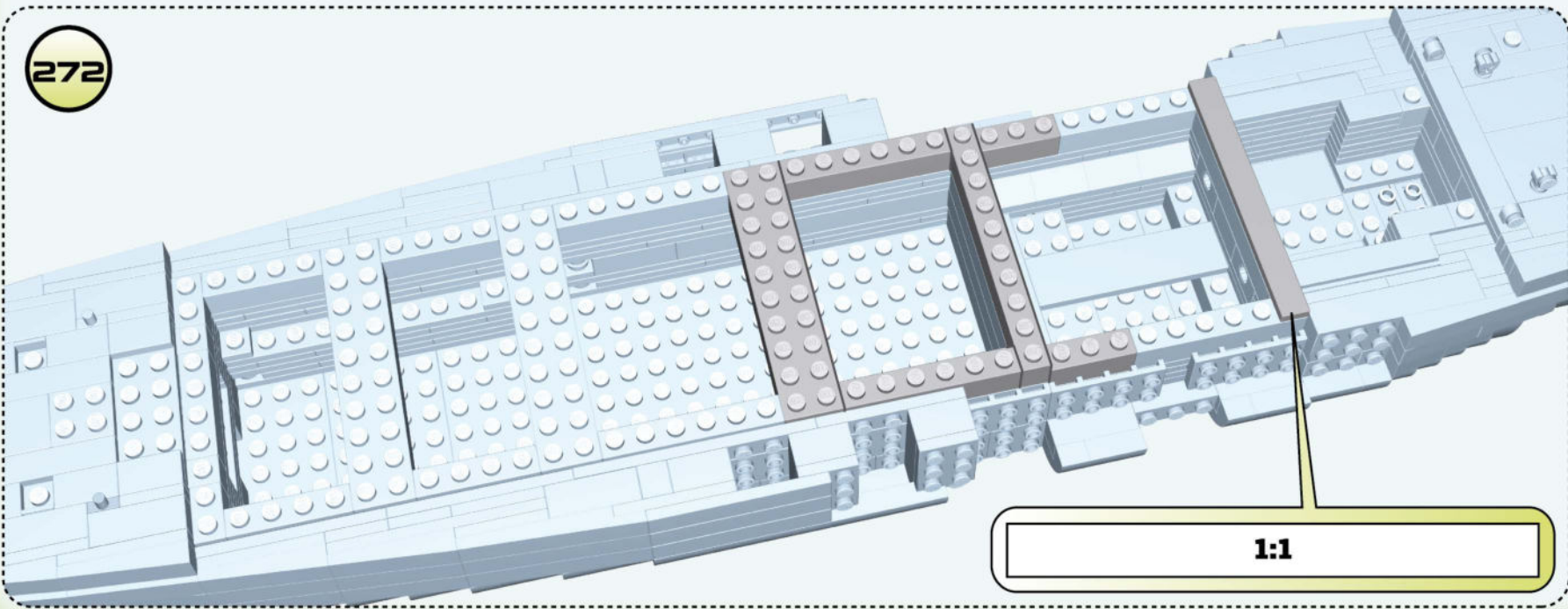

-  x2
-  x2
-  x1

272

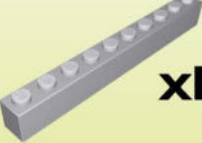

-  x1
-  x2
-  x1
-  x2
-  x1

1:1

278

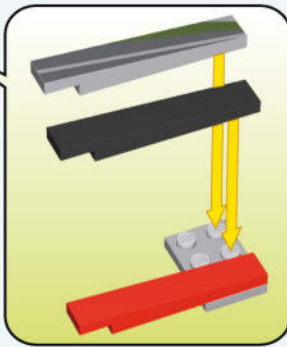
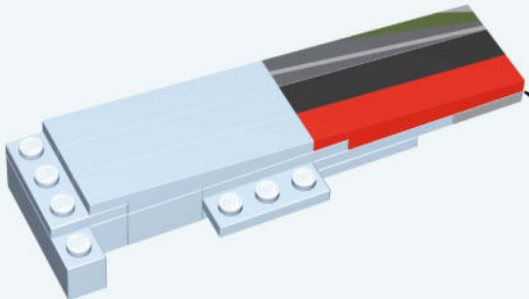
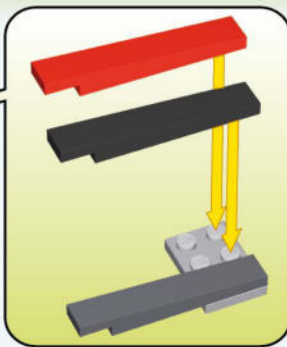
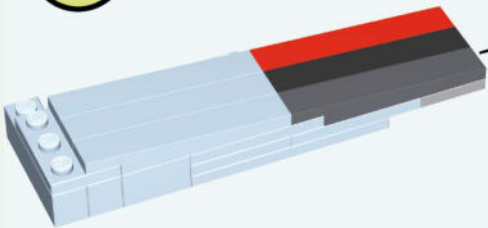

x2

x2

x2

x1

x1

279

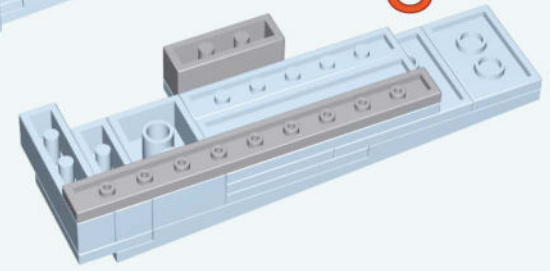
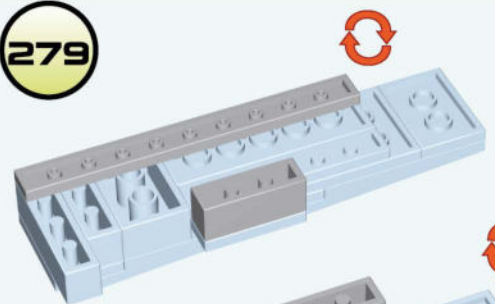

x2

x2

280

1:1

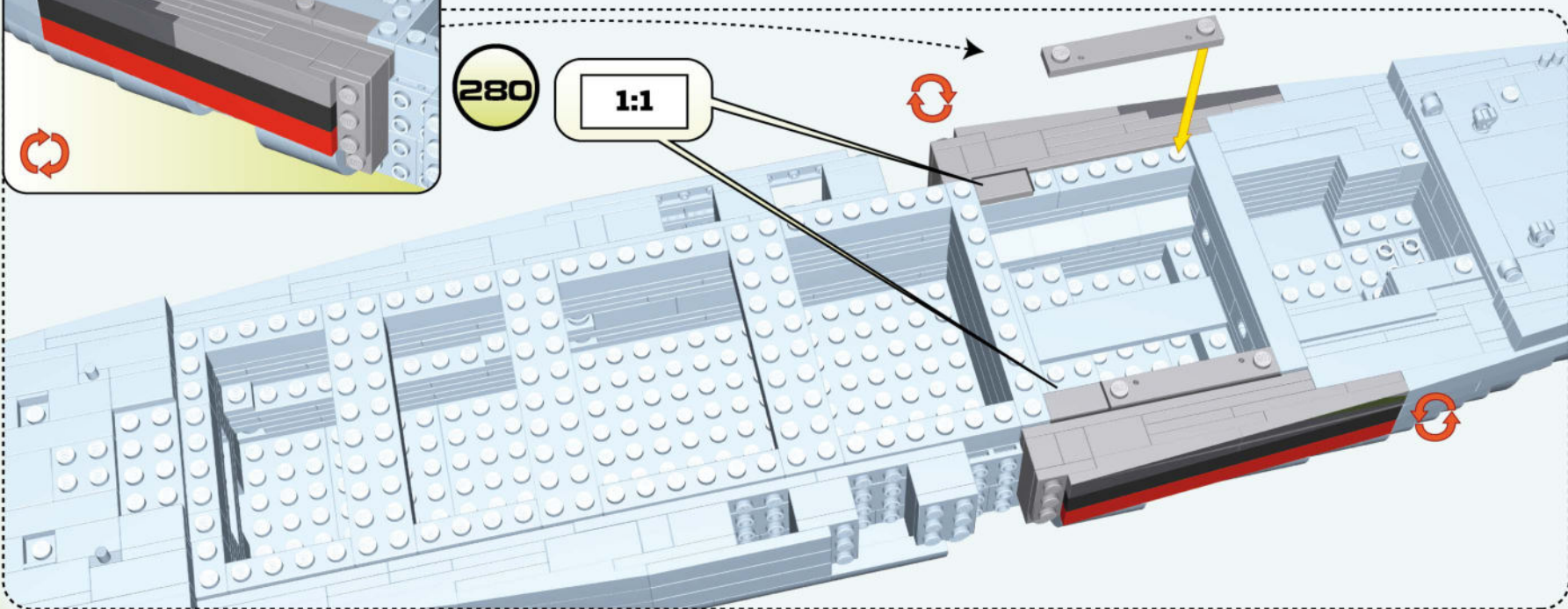
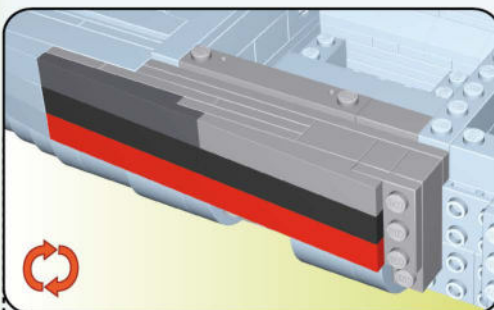





x2

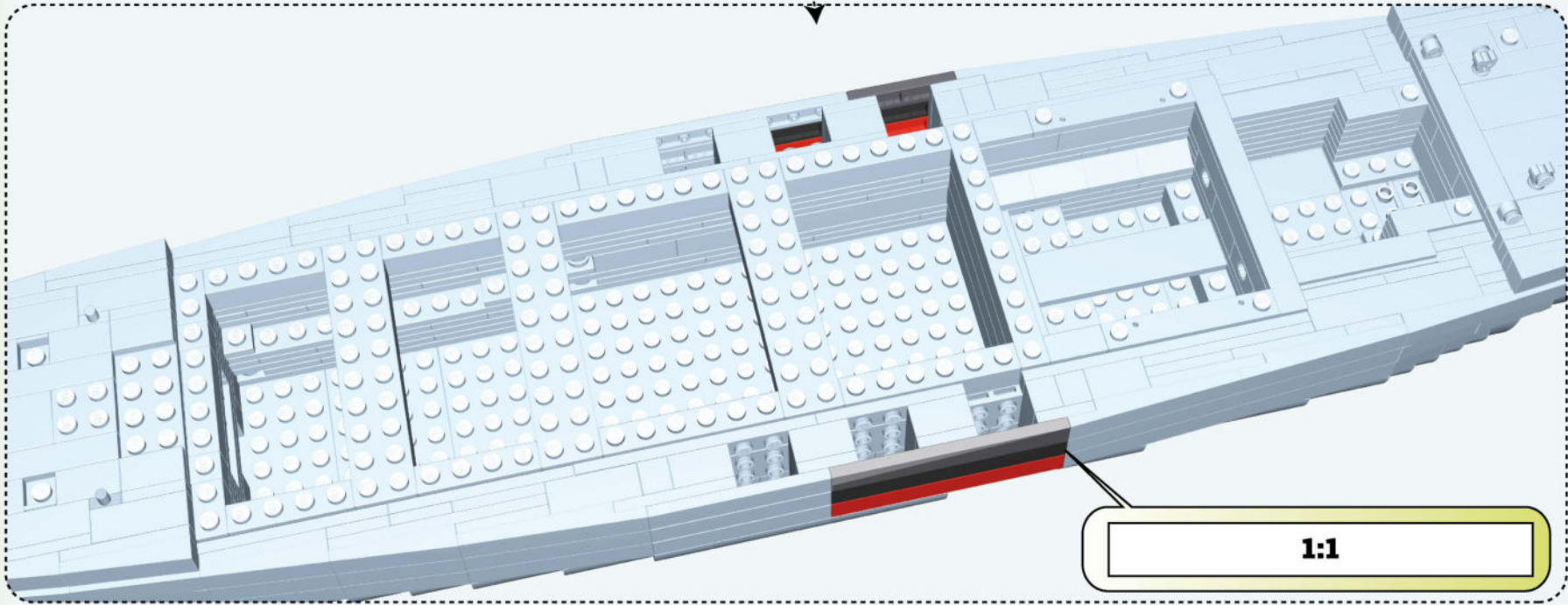
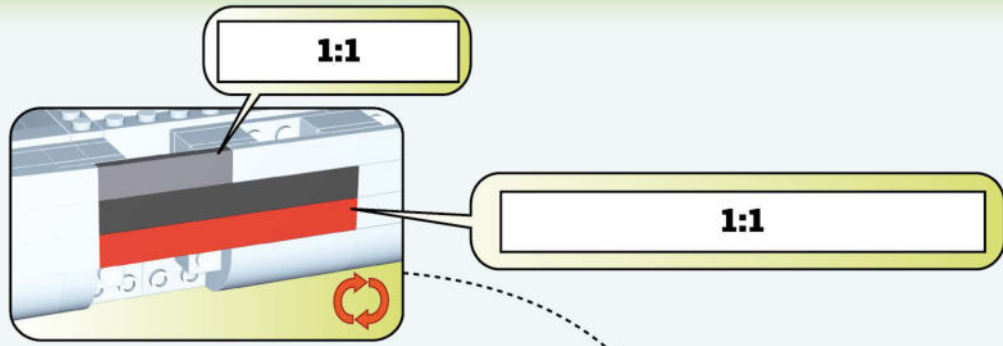

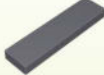
x2

281

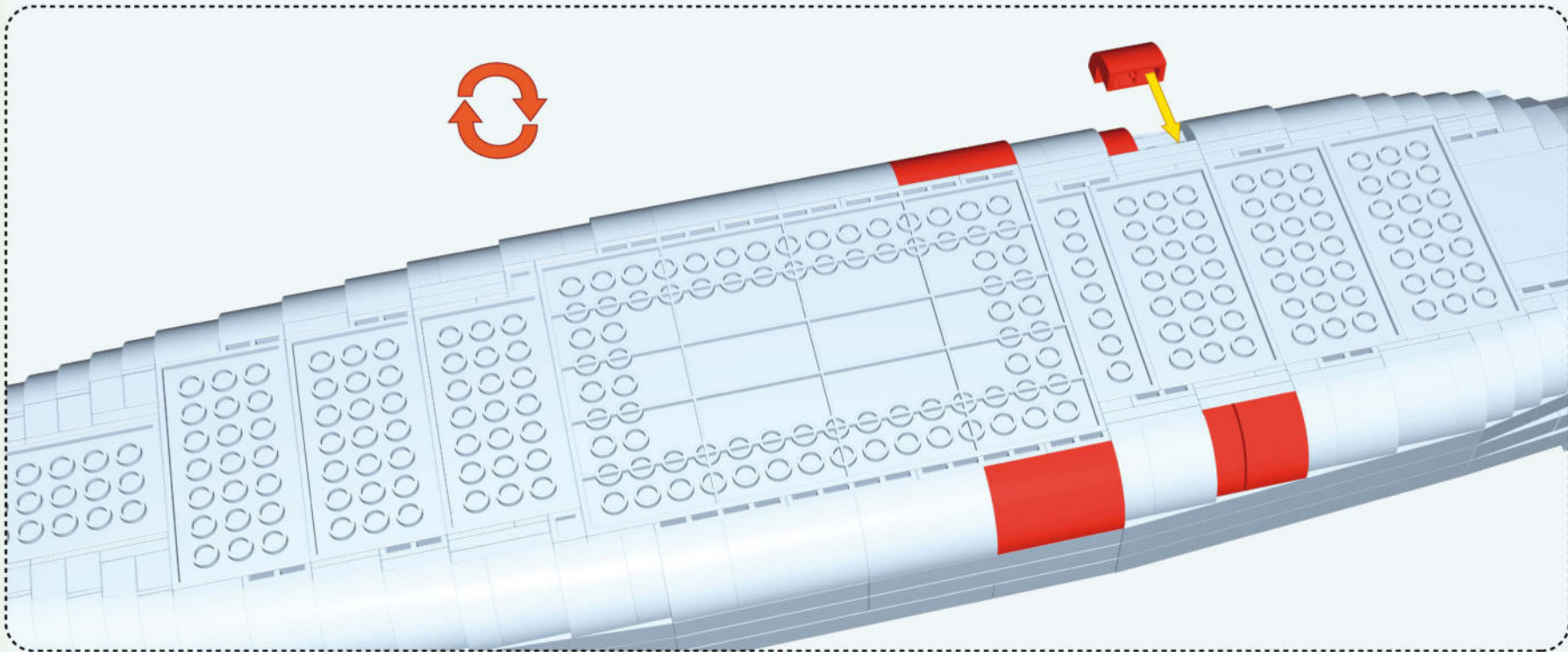

-  x1
-  x2
-  x2
-  x1



-  x2
-  x2
-  x2

283

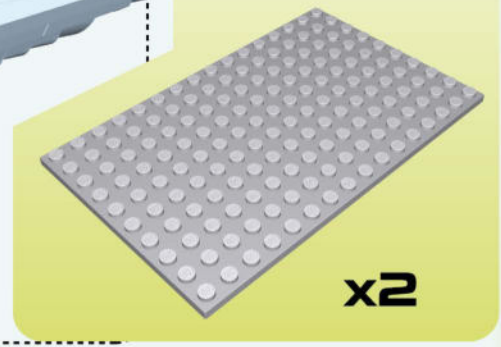
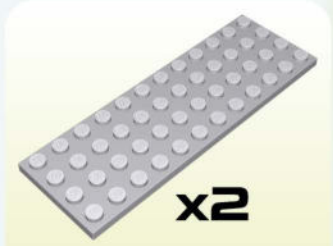
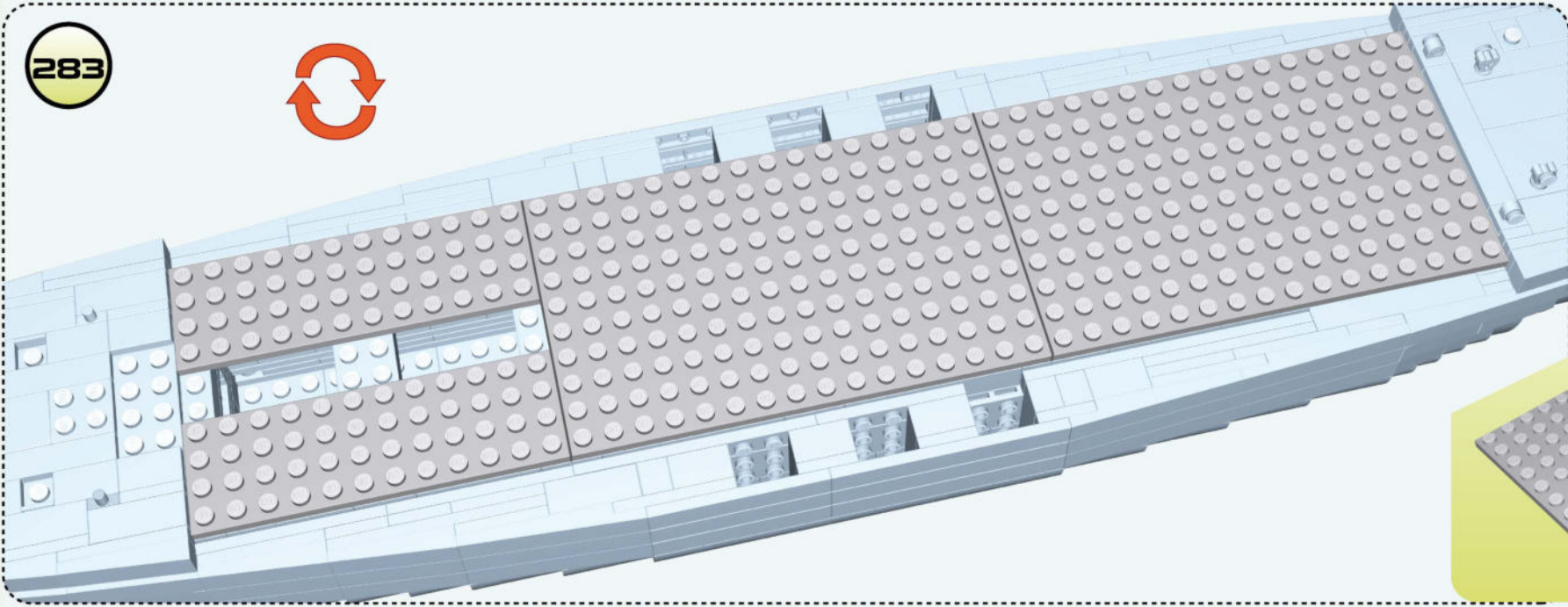

284

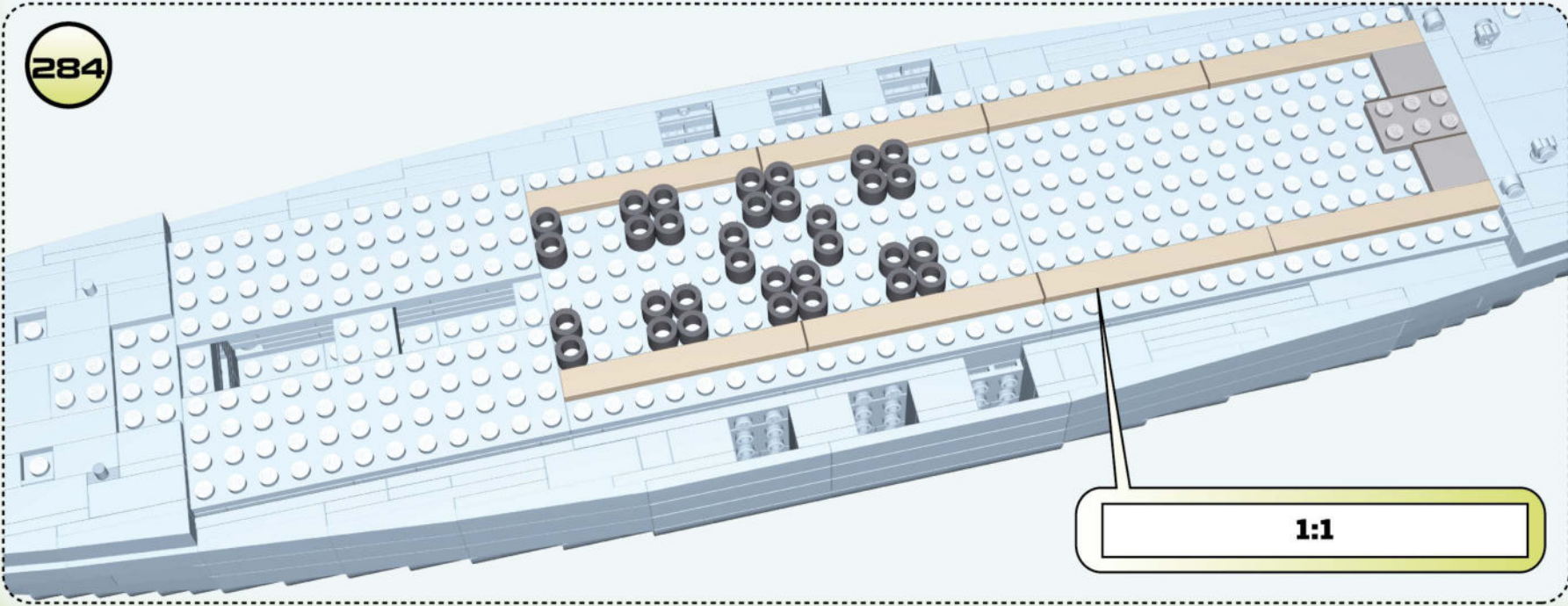

1:1

285

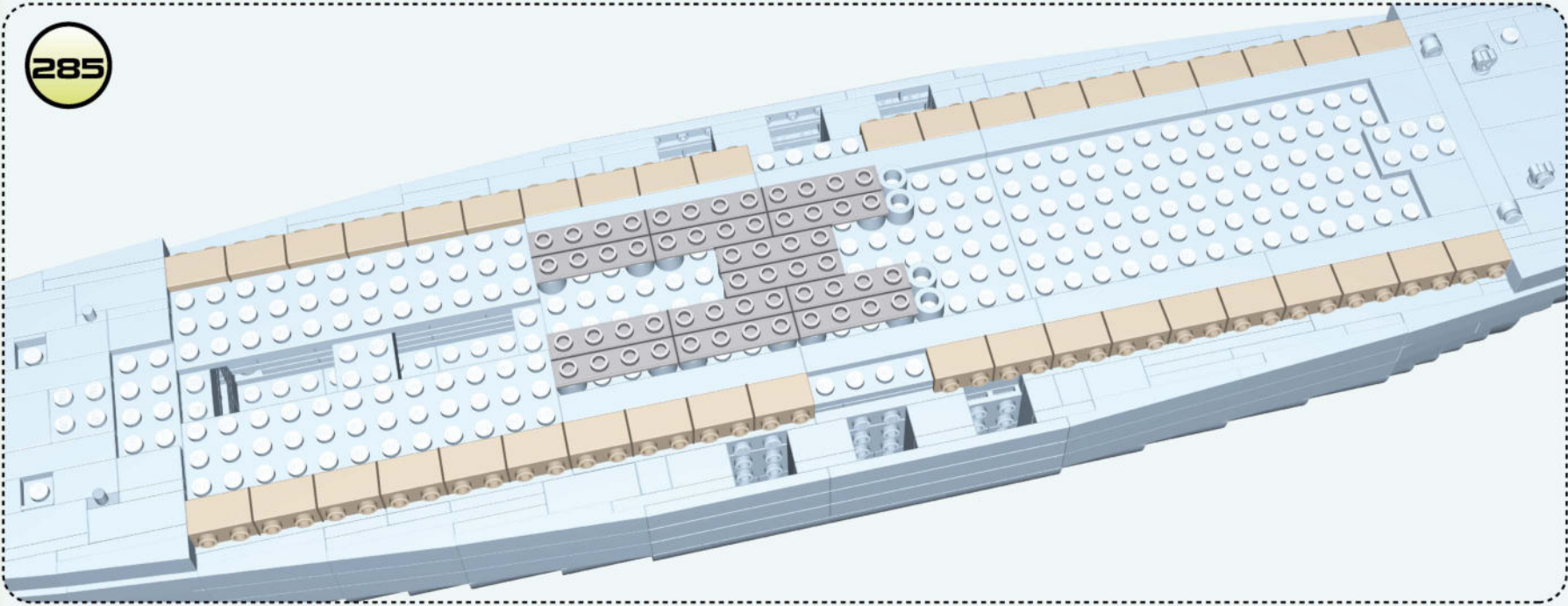

④ x40

x14

286

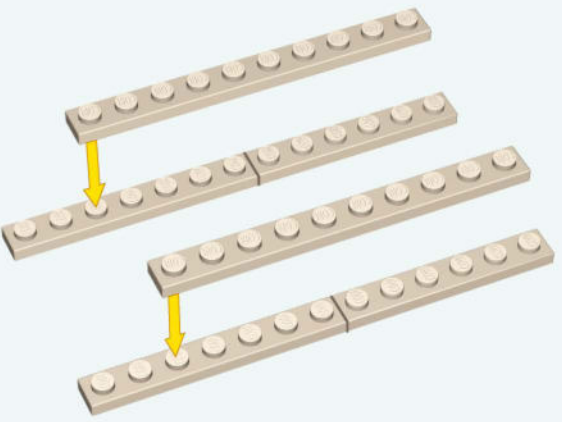

x2

x2

x2

287

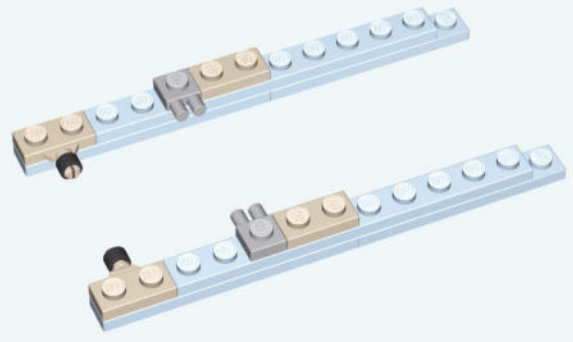

x2





x2

x2

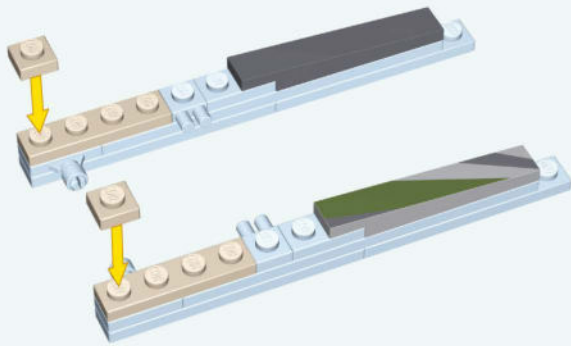
x2





288

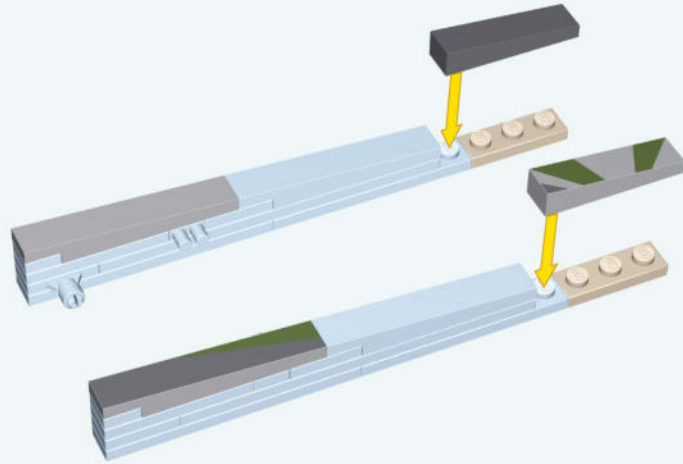

-  x2
-  x2
-  x1
-  x1

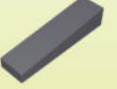
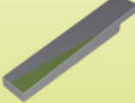

289

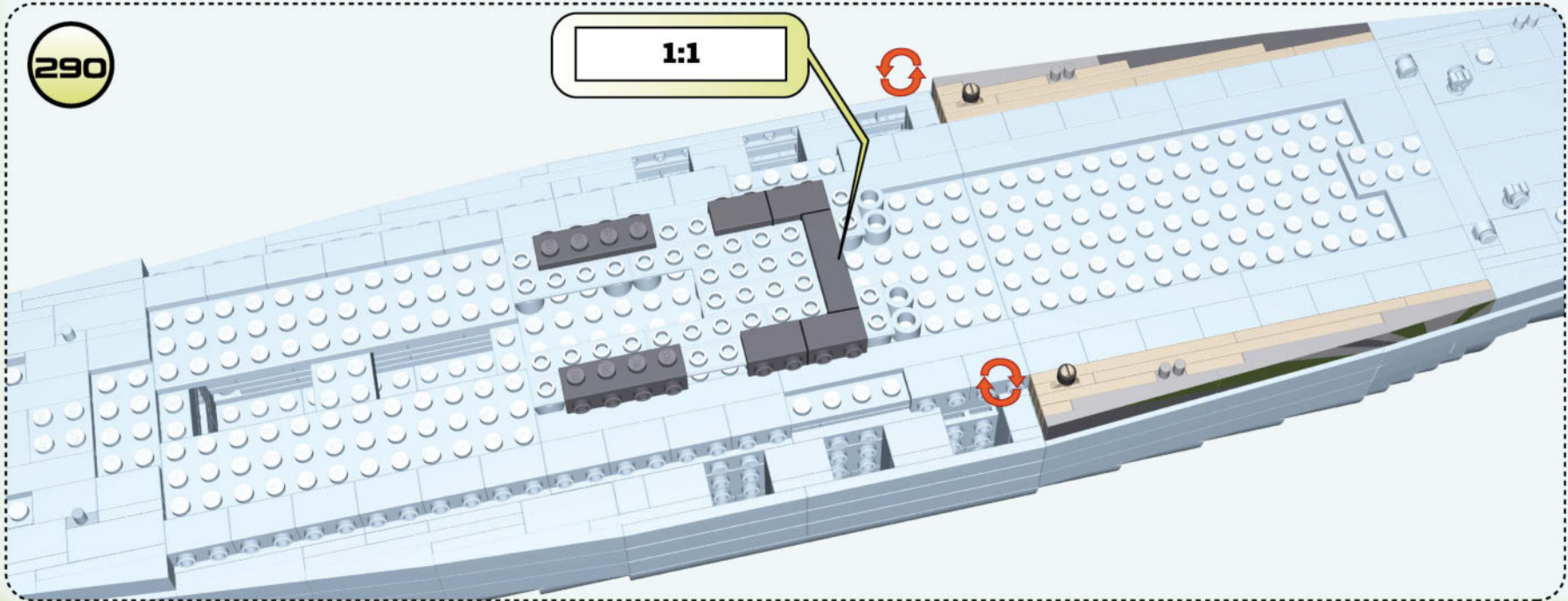

-  x1
-  x2
-  x1
-  x1
-  x1

290



-  x2
-  x4
-  x1

291

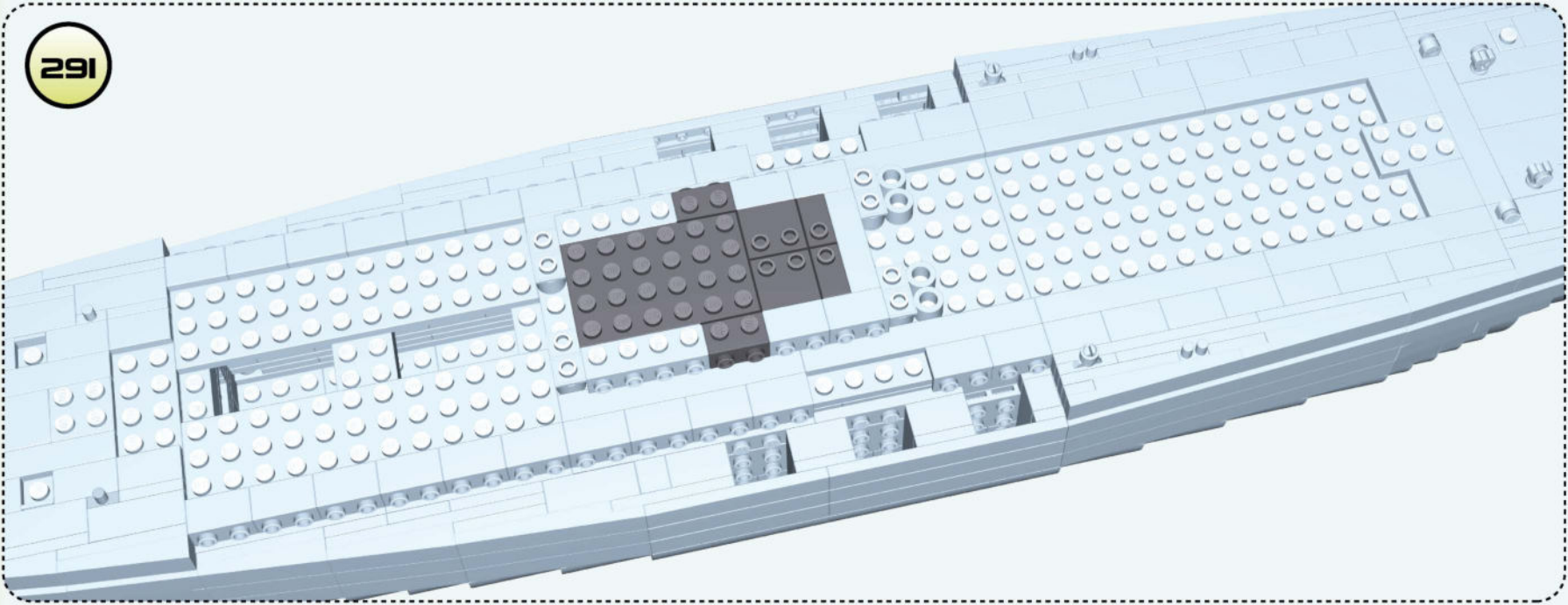

x1



x2



x2



x2

292

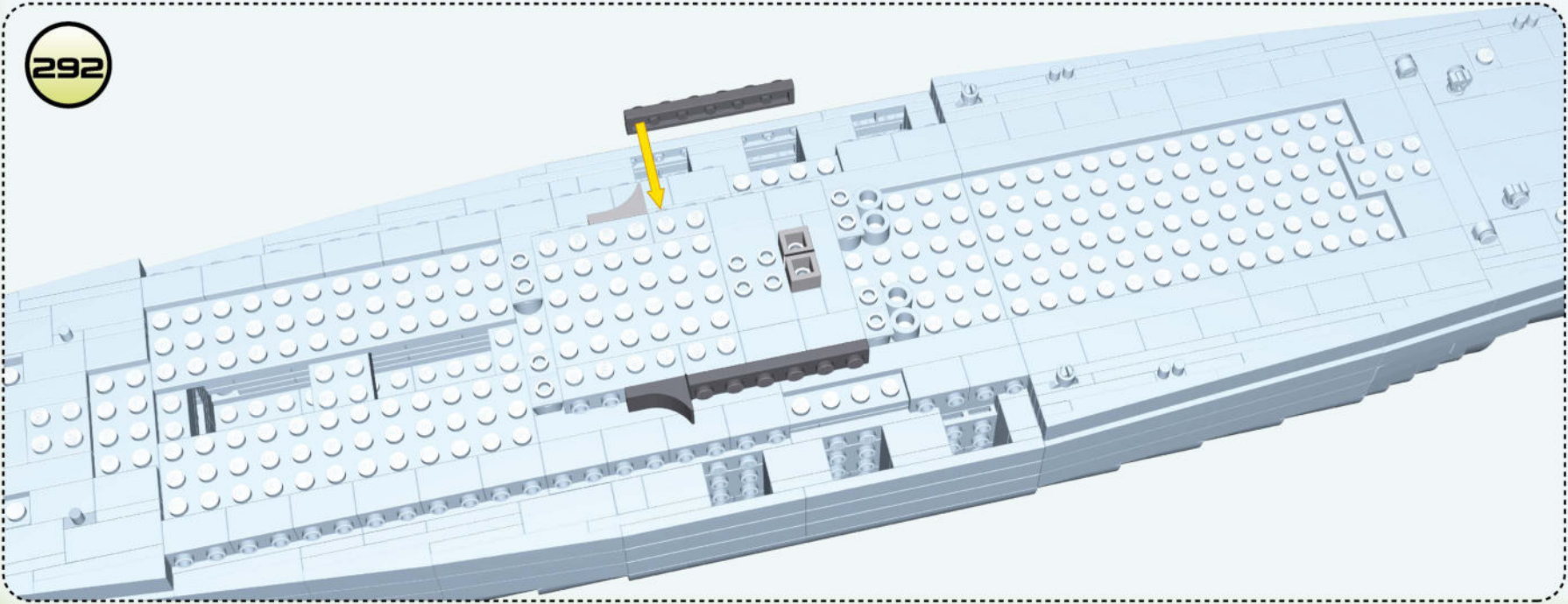

x1



x1



x2



x2

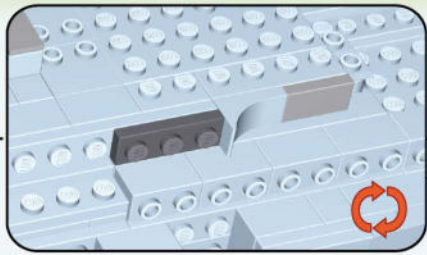

293

1:1

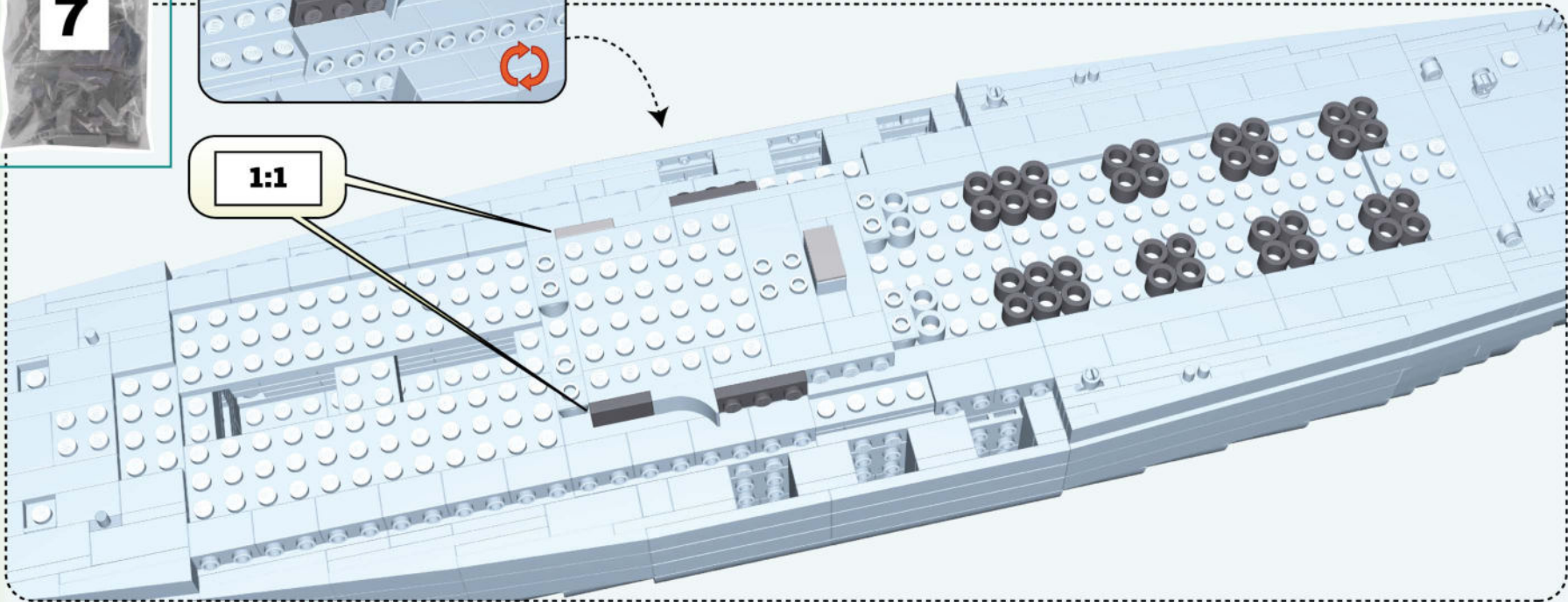

 x1

 x1

 x2

 x1

 x36

294

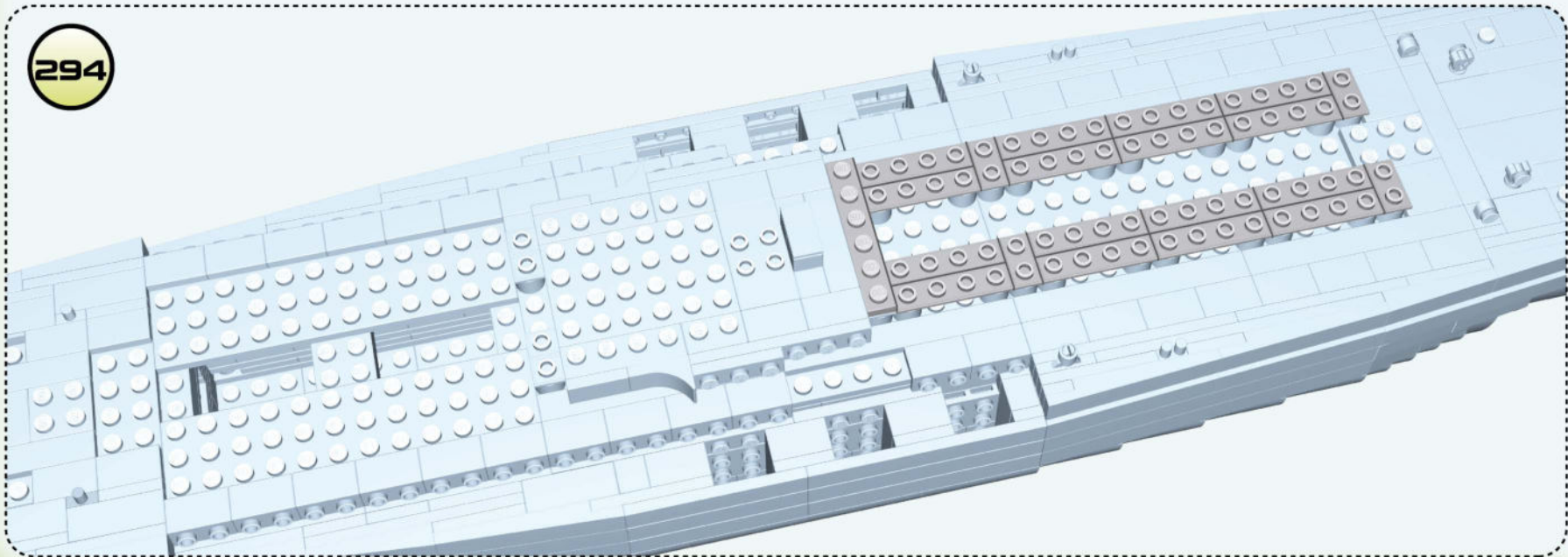



 x1

 x16

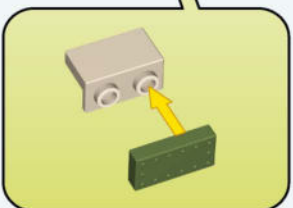
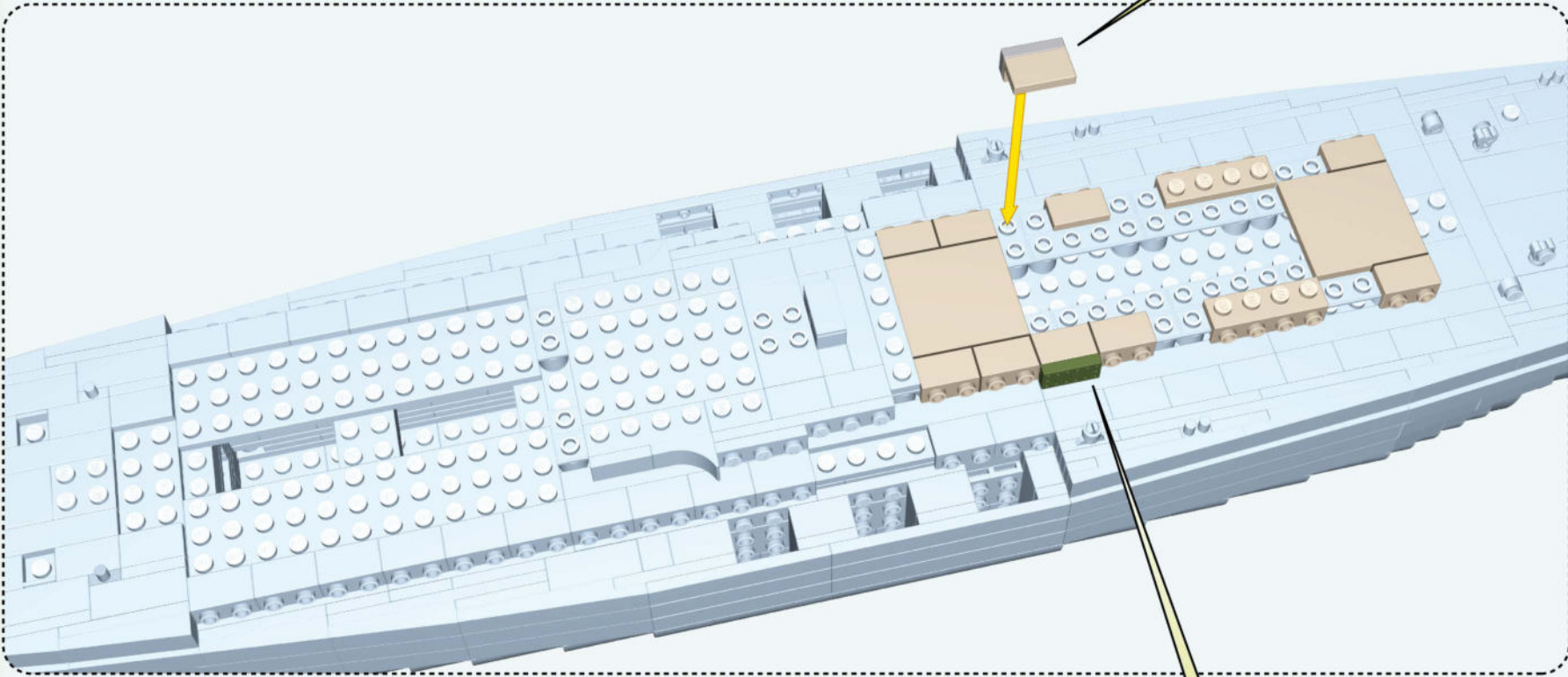
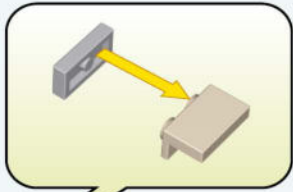
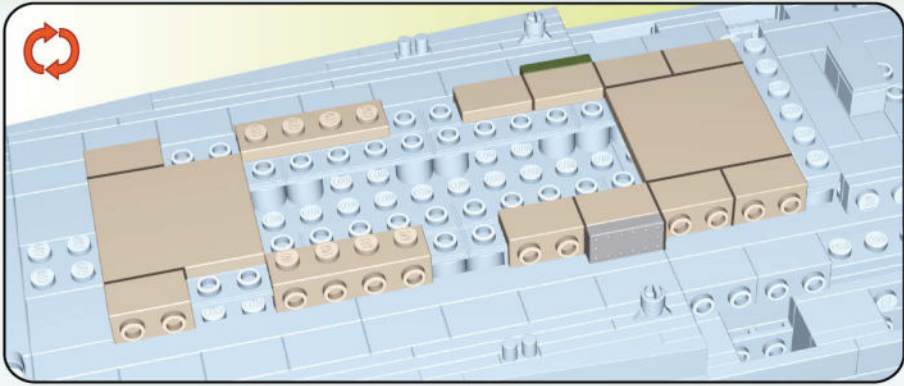
 x4



-  x2
-  x10
-  x1
-  x1
-  x2

296

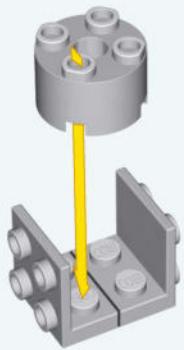

x2



x1

297

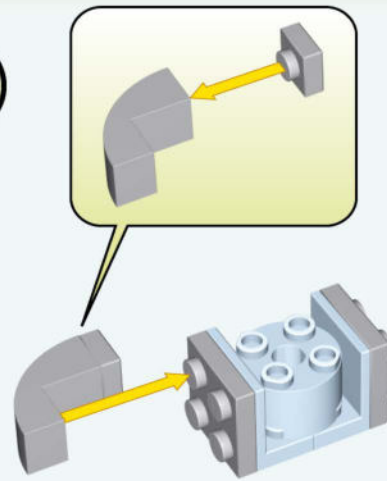

x2



x1



x1

298

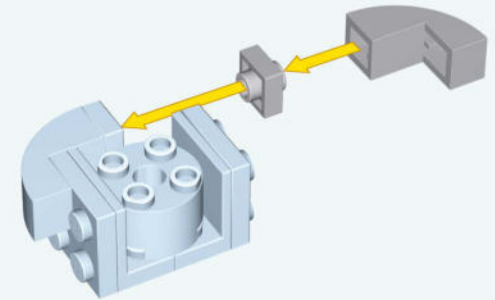

x1



x1

299

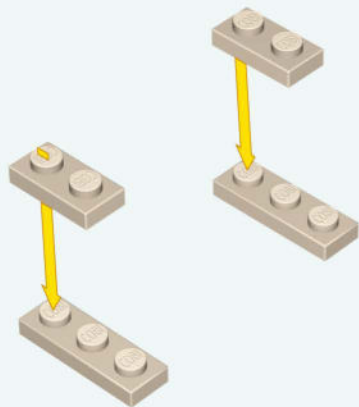

x2



x2

300

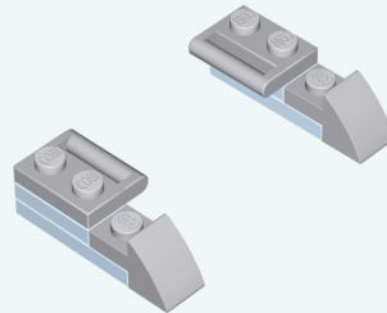

x2



x2

301

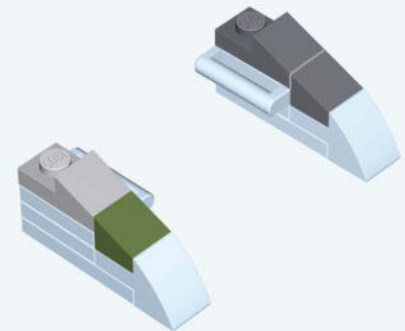

x1



x1



x1



x1

302

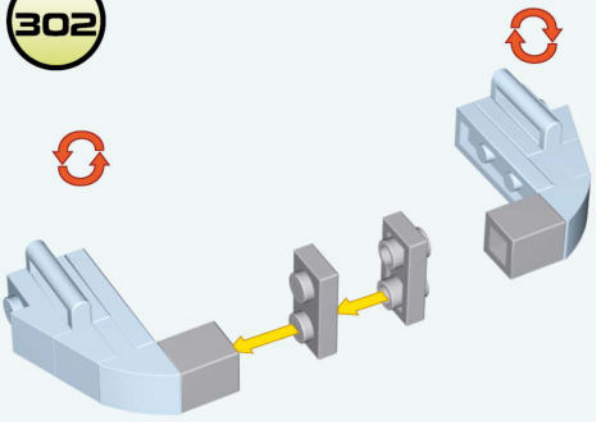

- 
x2
- 
x1
- 
x1

303

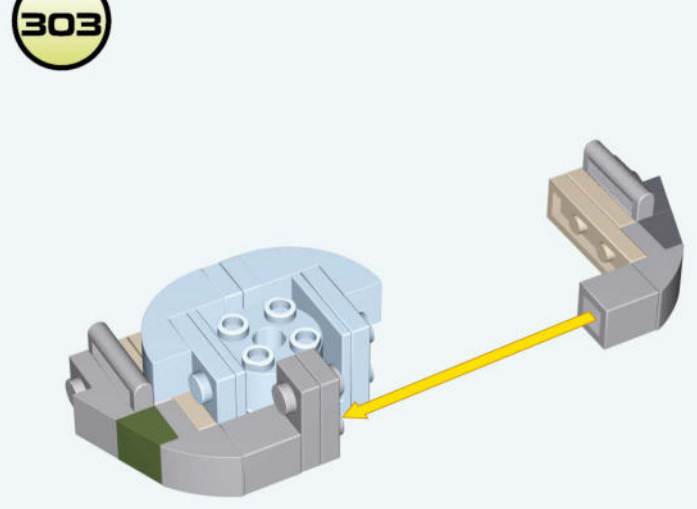

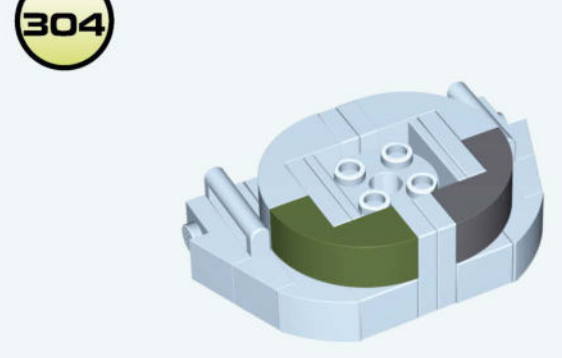

304

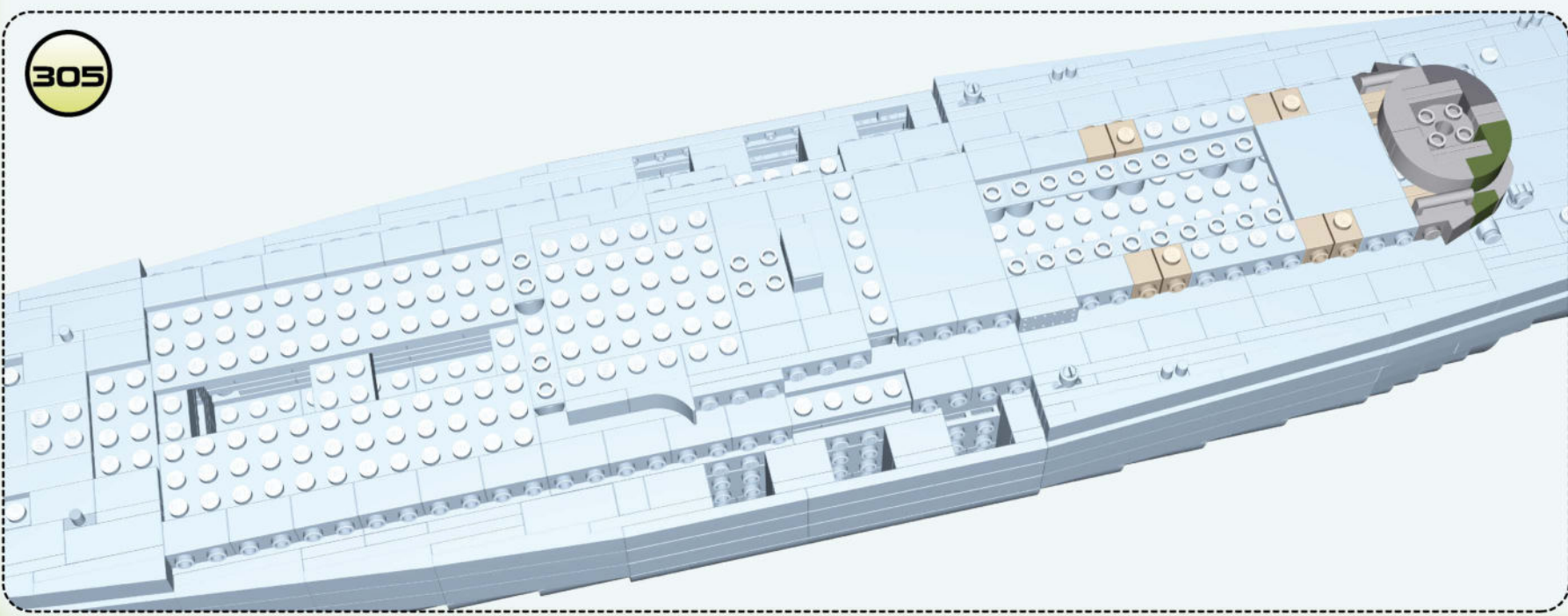

- 
x1
- 
x1

305





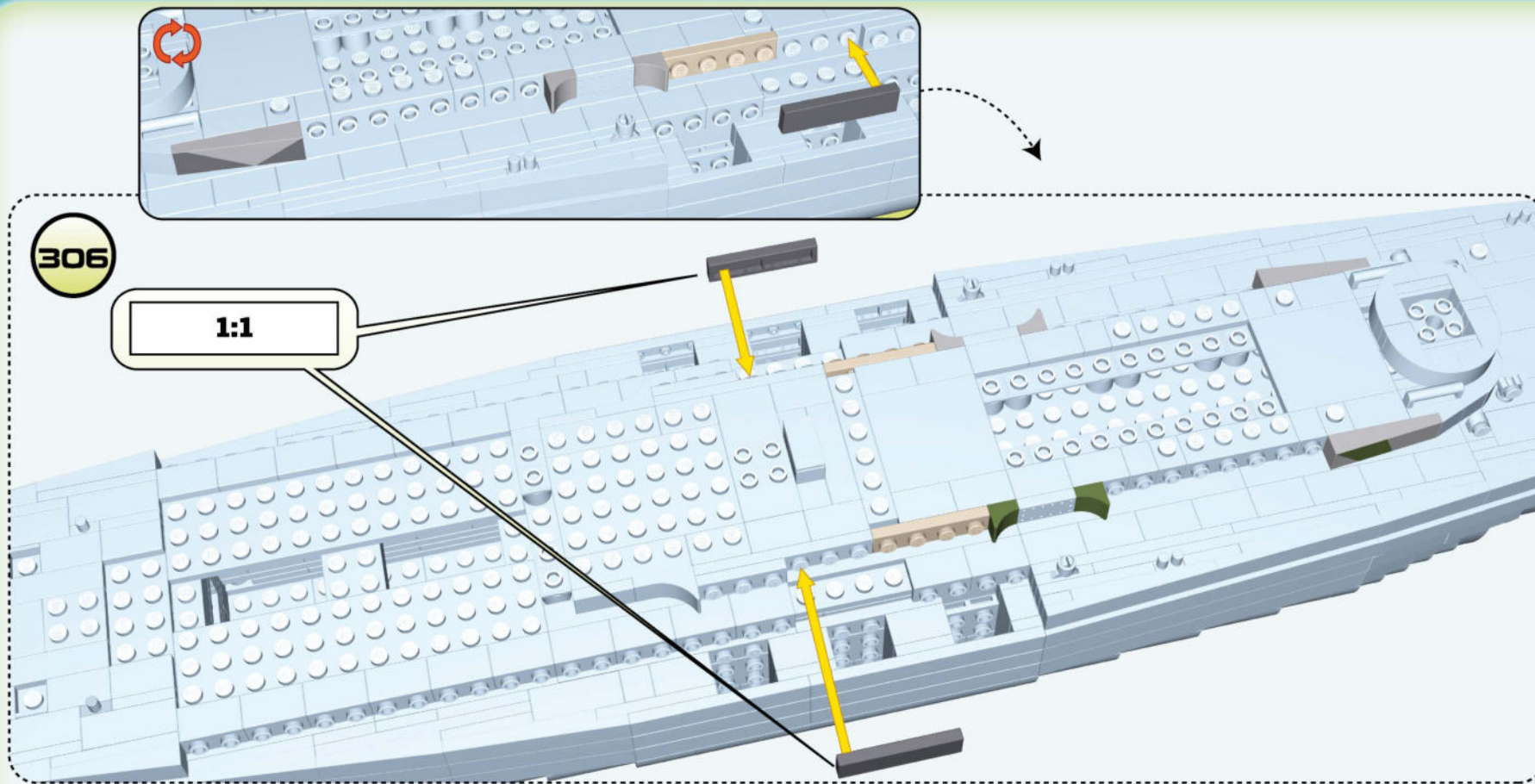



- 
x4
- 
x4



306

1:1

-  x2
-  x2
-  x2
-  x2
-  x1
-  x1

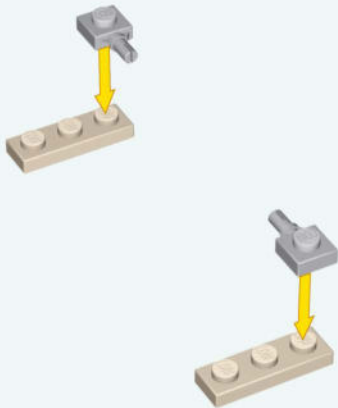

307

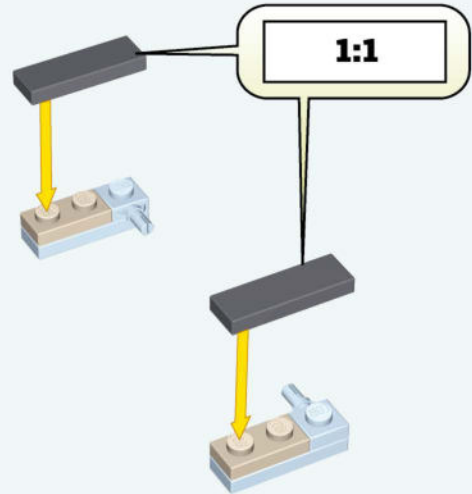

-  x2
-  x2

308



-  x2
-  x2

309

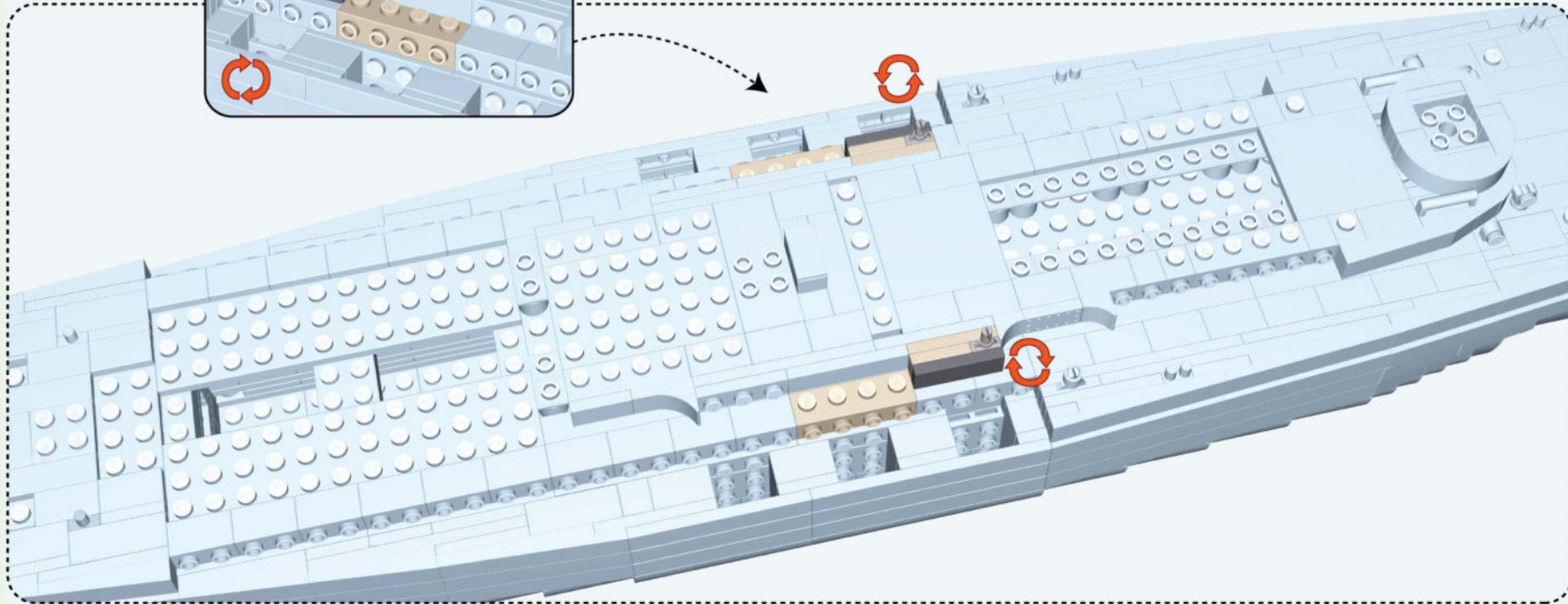
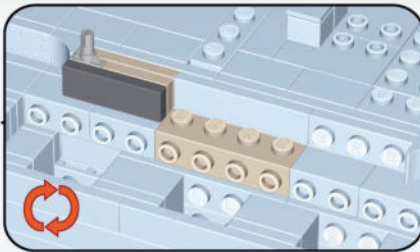

x2

310

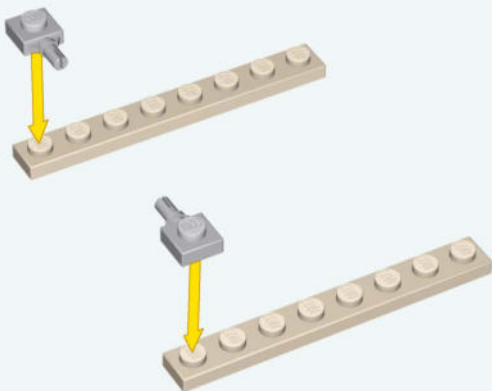

x2



x2

311

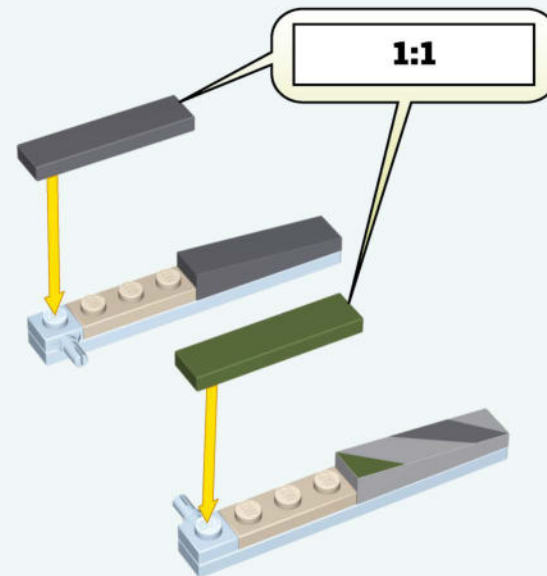

x2



x1



x1



x1



x1

312

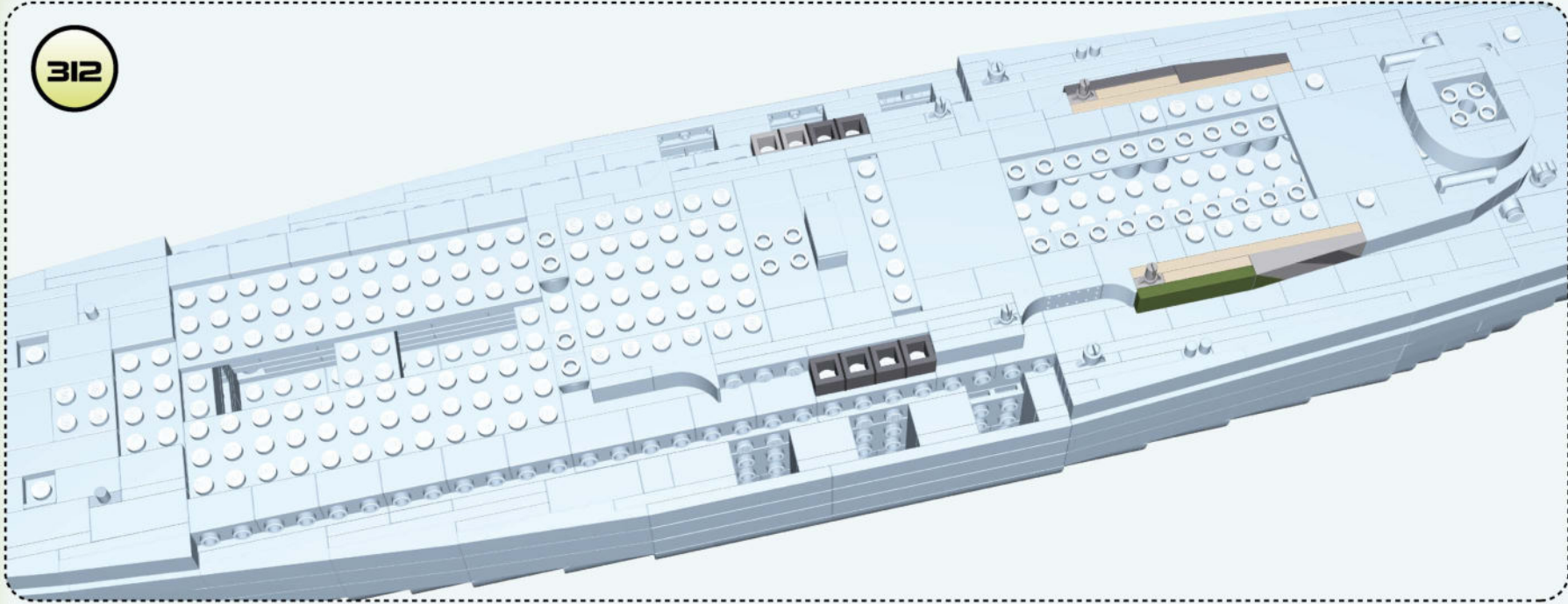

 x2

 x6

313

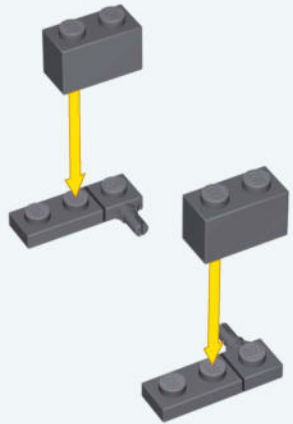

 x2

 x2

 x2

314

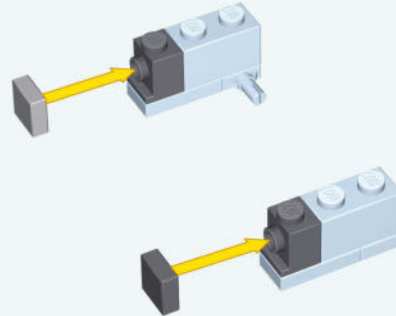

 x2

 x1

 x1

315

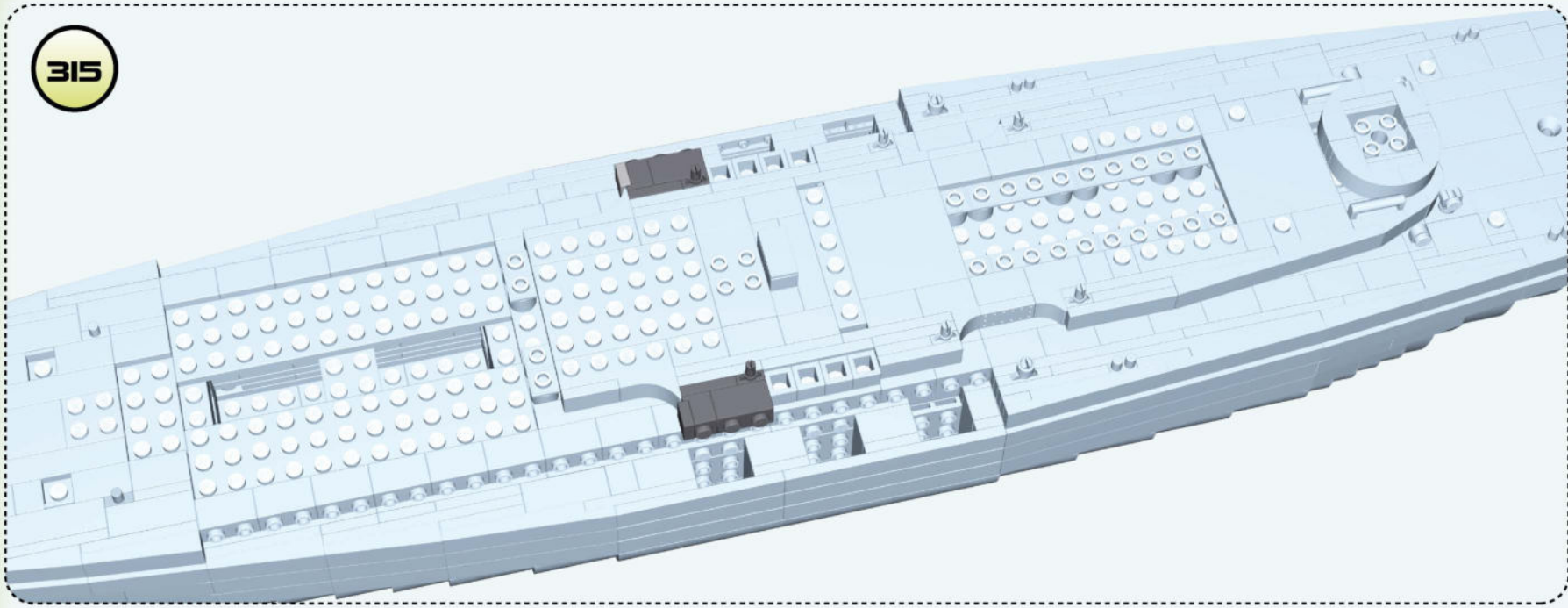

316

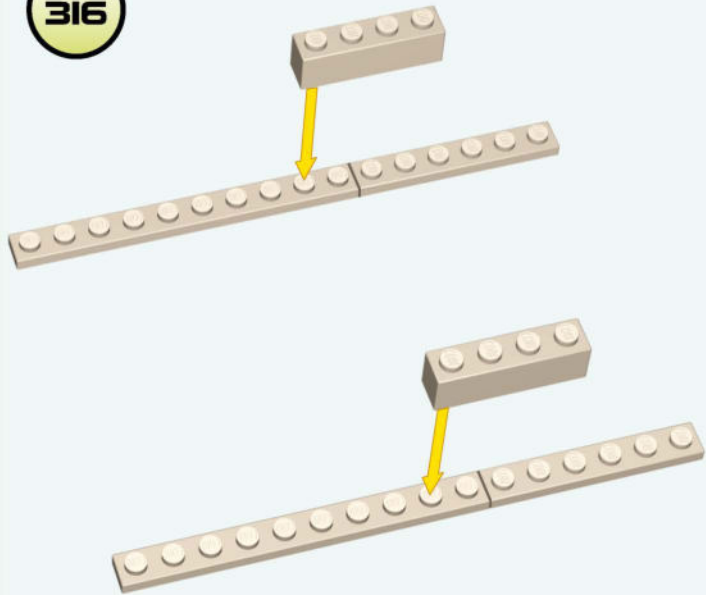

-  x2
-  x2
-  x2

317

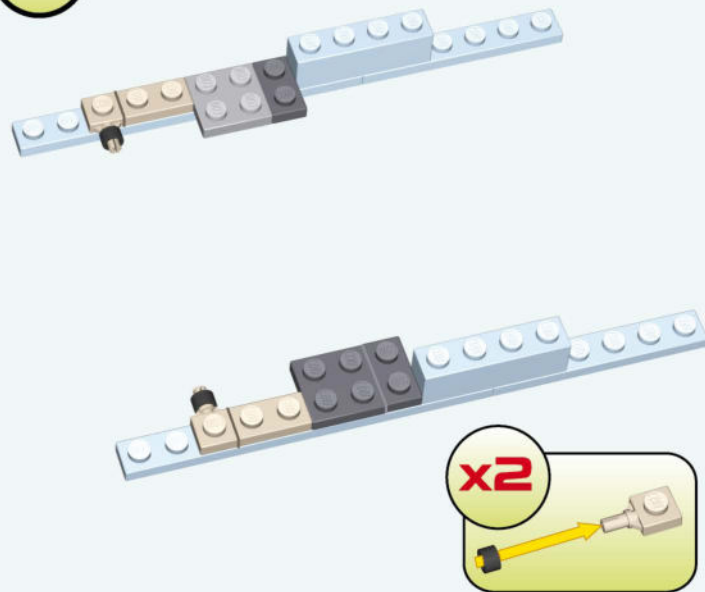

-  x2
-  x2
-  x2
-  x1
-  x2
-  x1

318

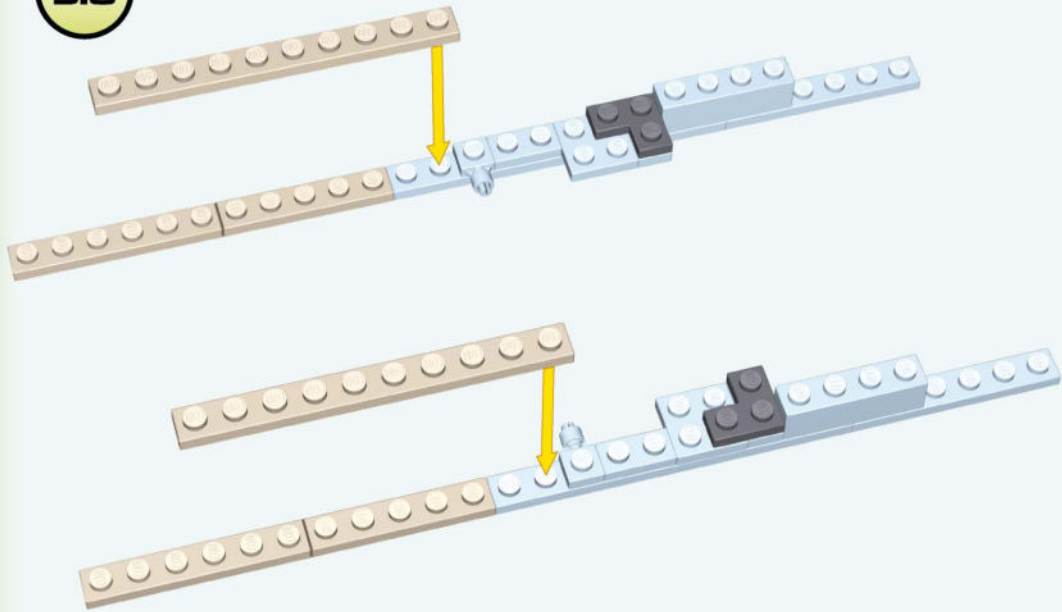

319

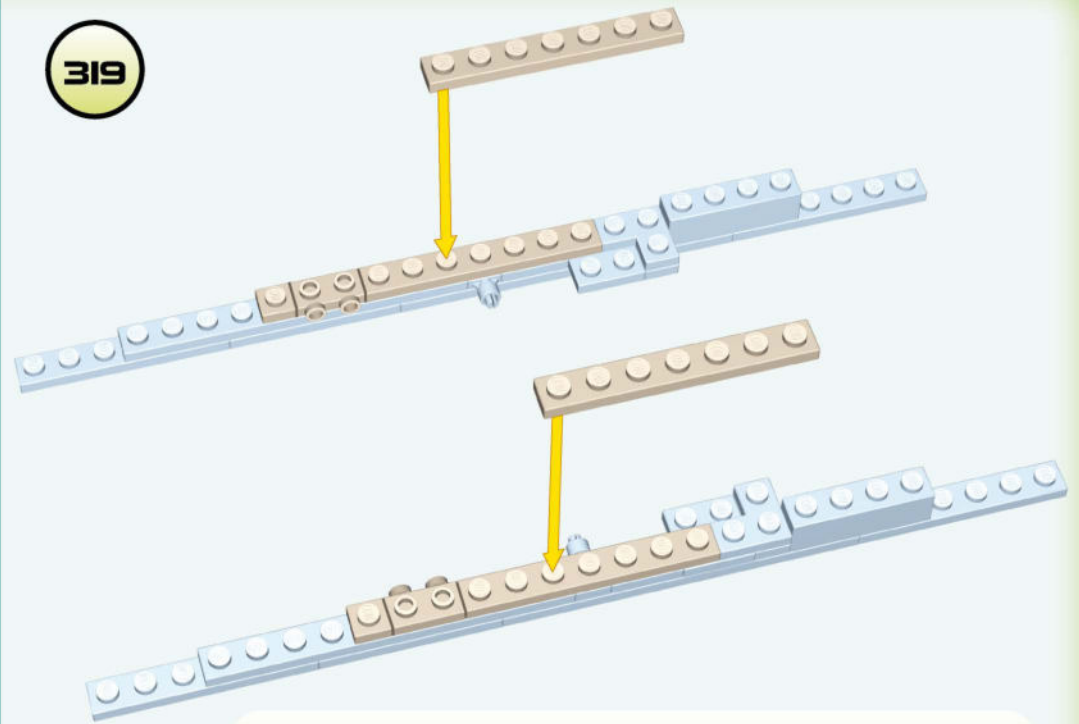

320

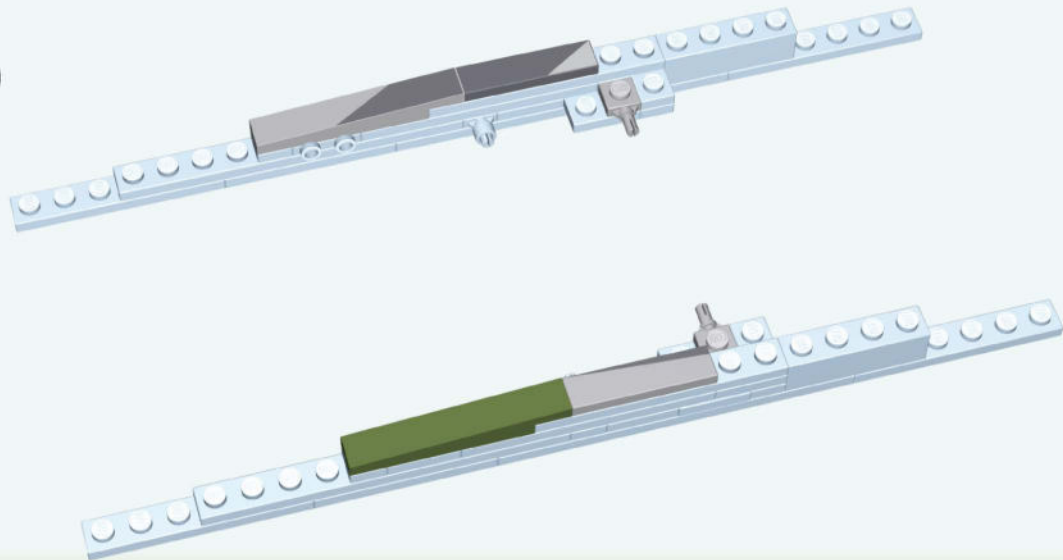

321

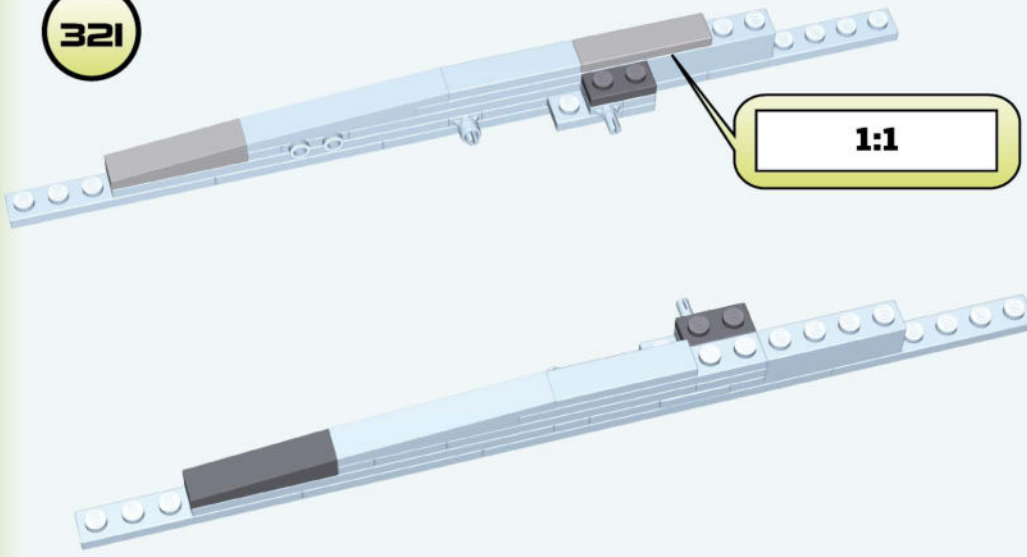

- 
x1
- 
x1
- 
x2
- 
x1



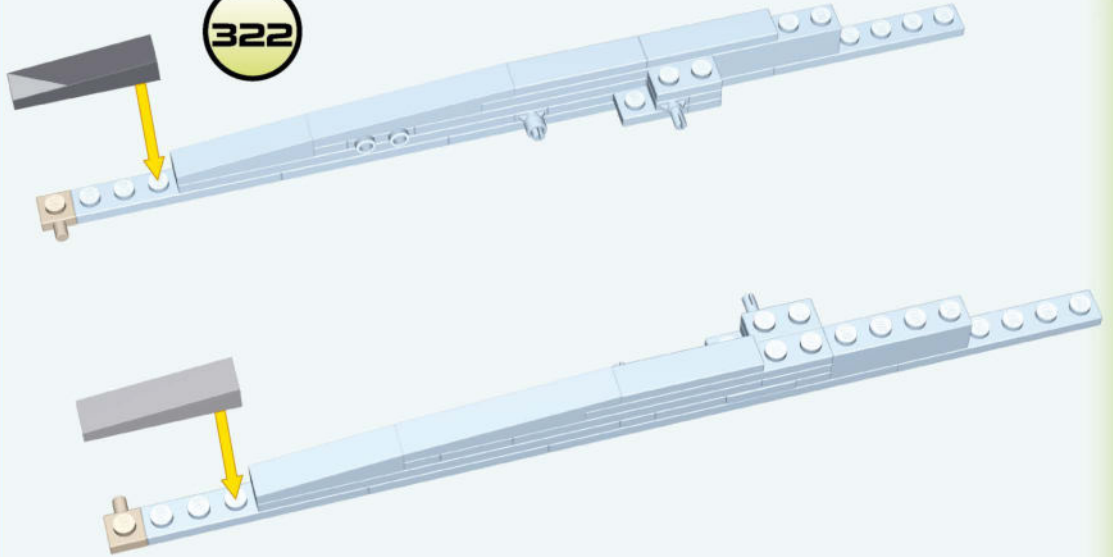

322

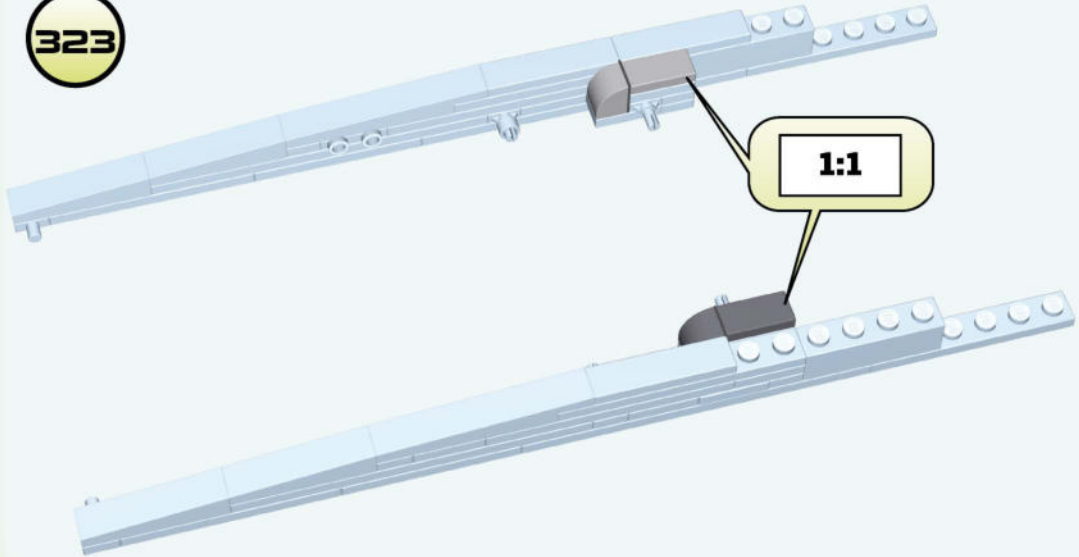

- 
x2
- 
x1
- 
x1

323



-  **x1**
-  **x1**
-  **x1**
-  **x1**

324

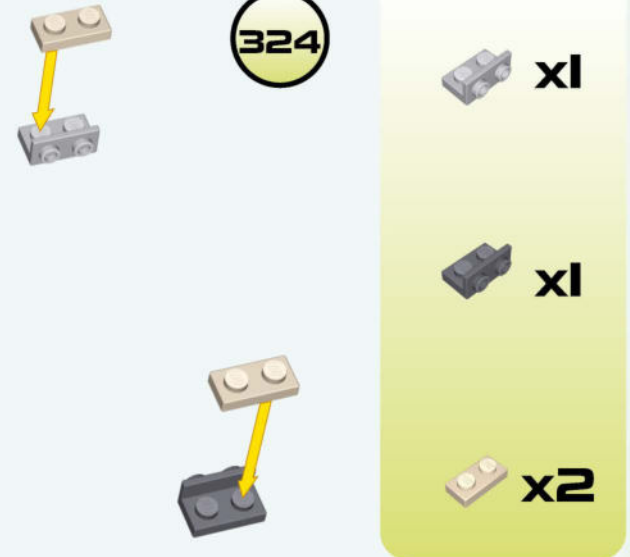

-  **x1**
-  **x1**
-  **x2**



325

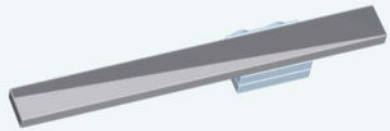

x1



x1



326

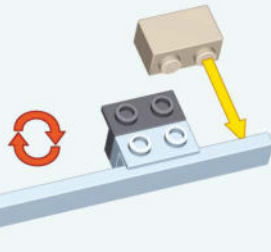

x1



x1



x2

327

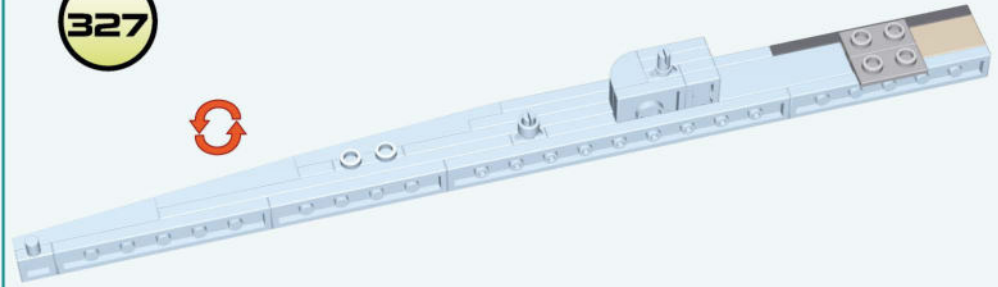

327

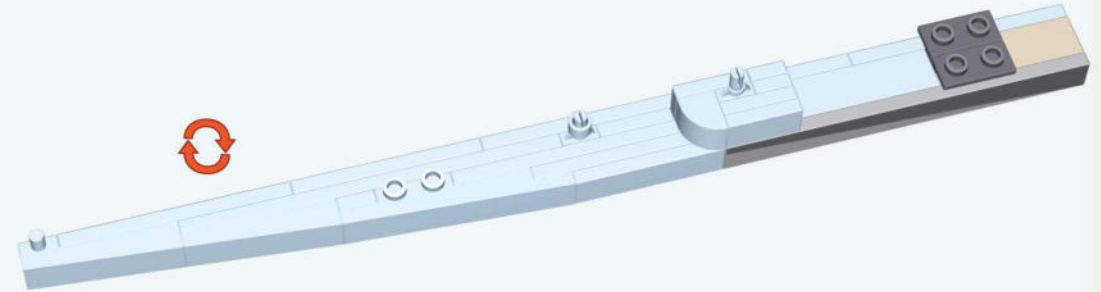

328

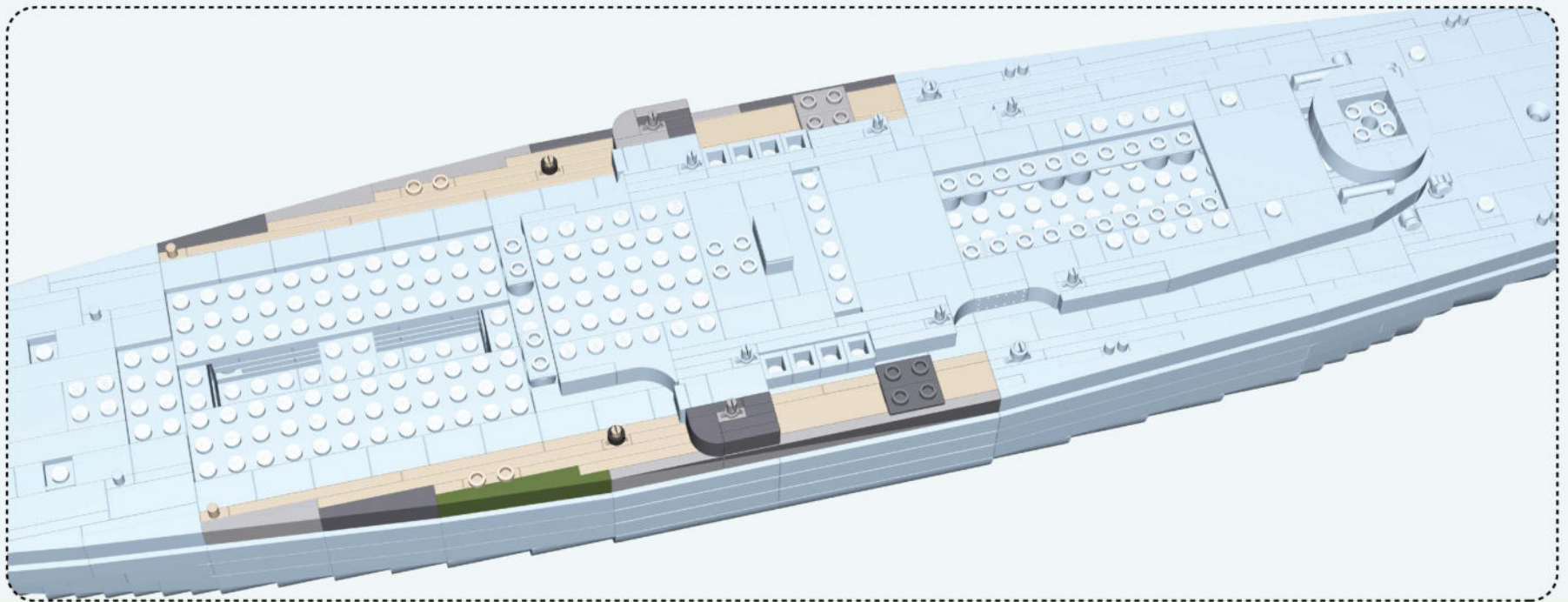

329

1:1

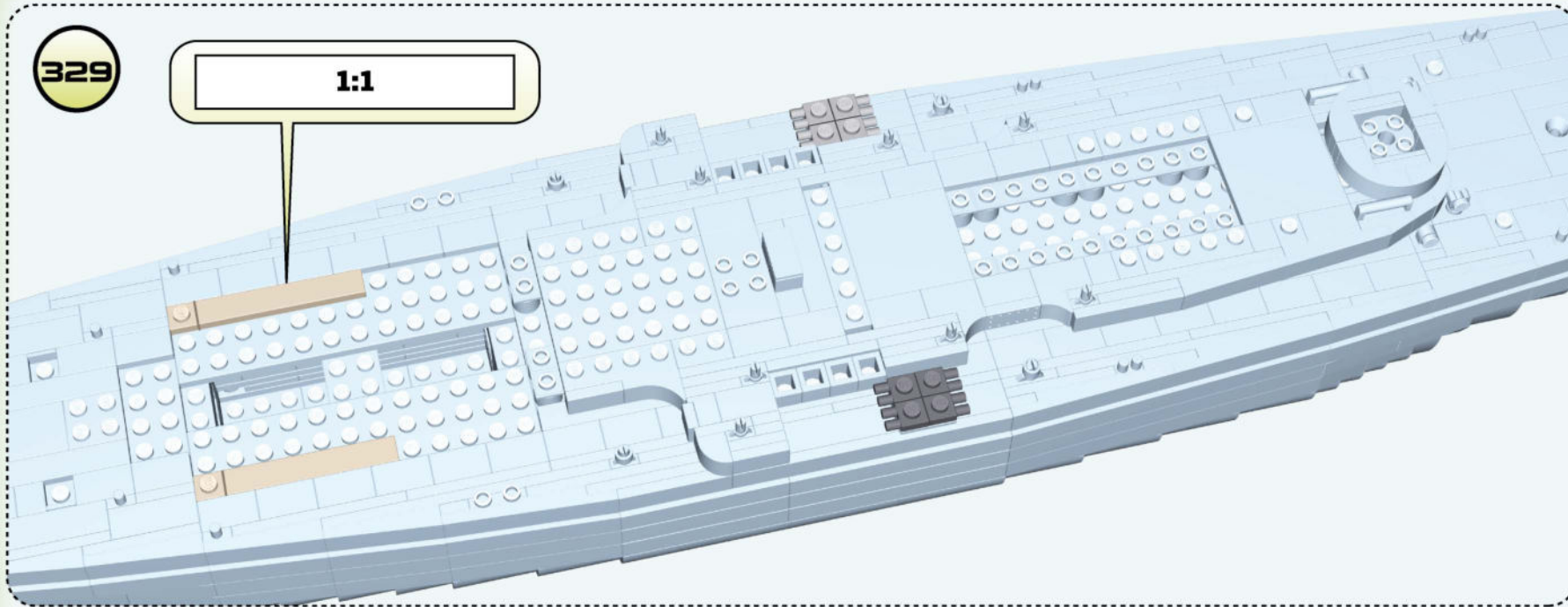

 x2

 x2

 x4

 x4

330

x2

1:1

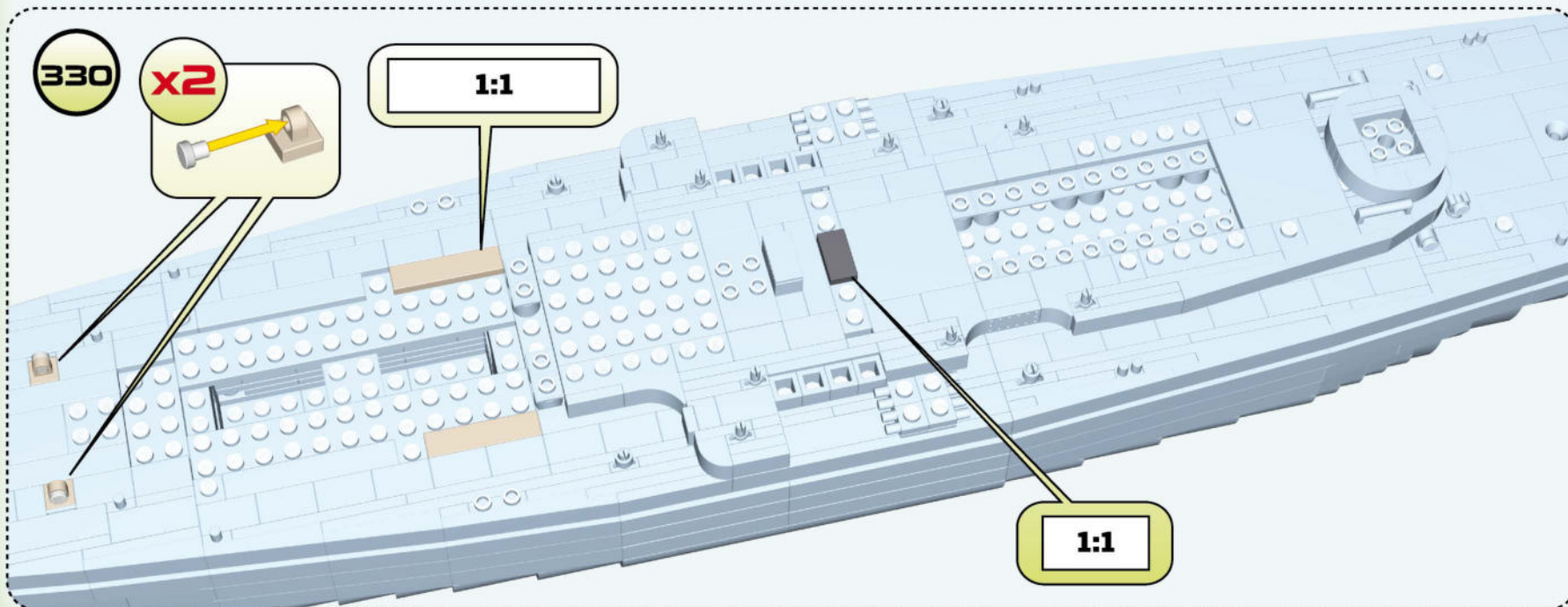

 x2

 x2

 x2

 x1

331

1:1

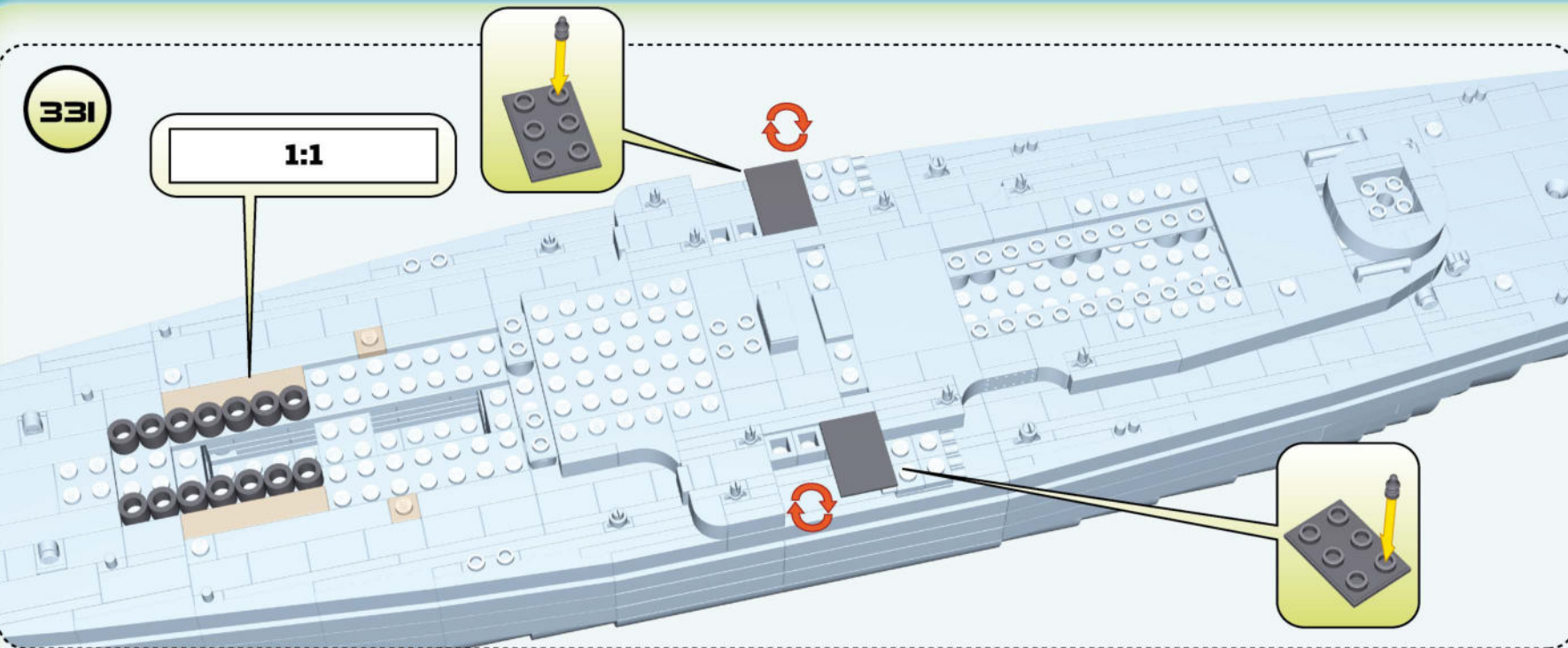

 x2

 x14

 x2

 x2

 x2

332

1:1

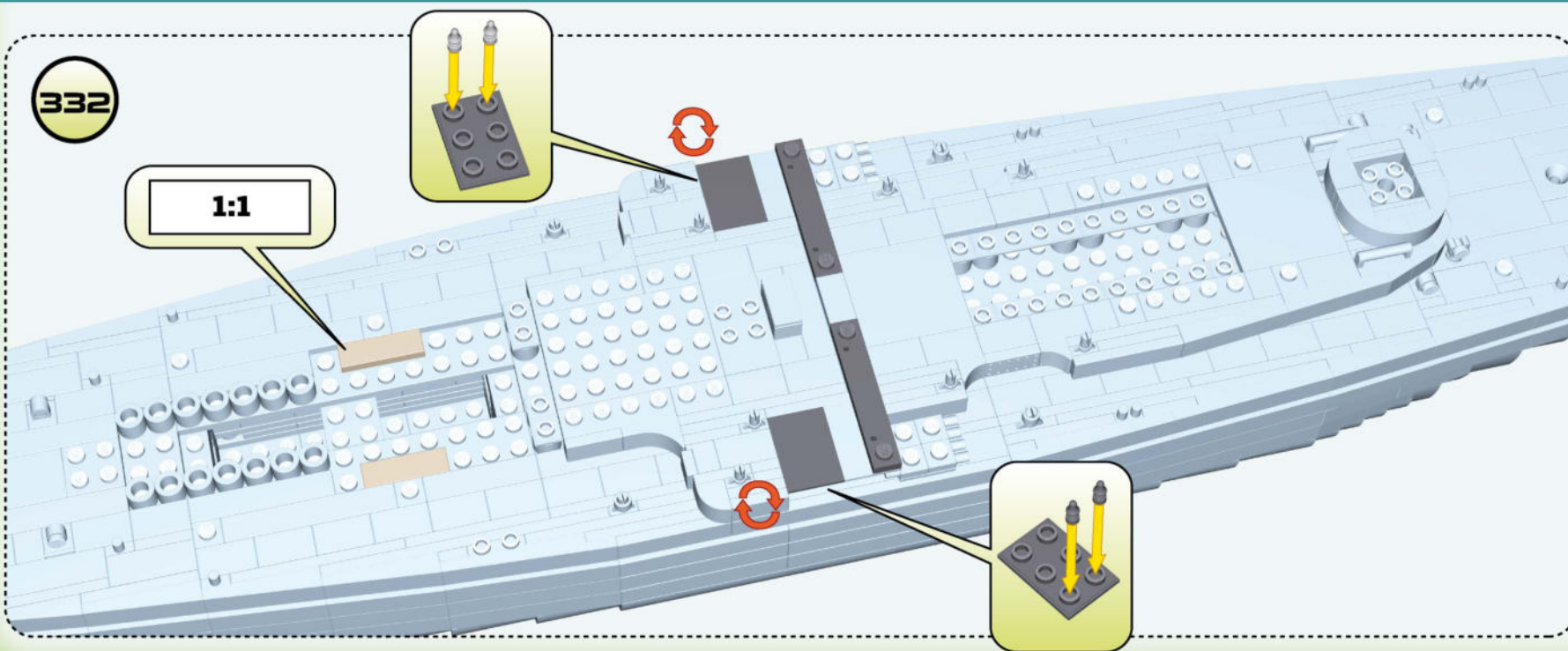

 x2

 x2

 x2

 x2

 x2

333

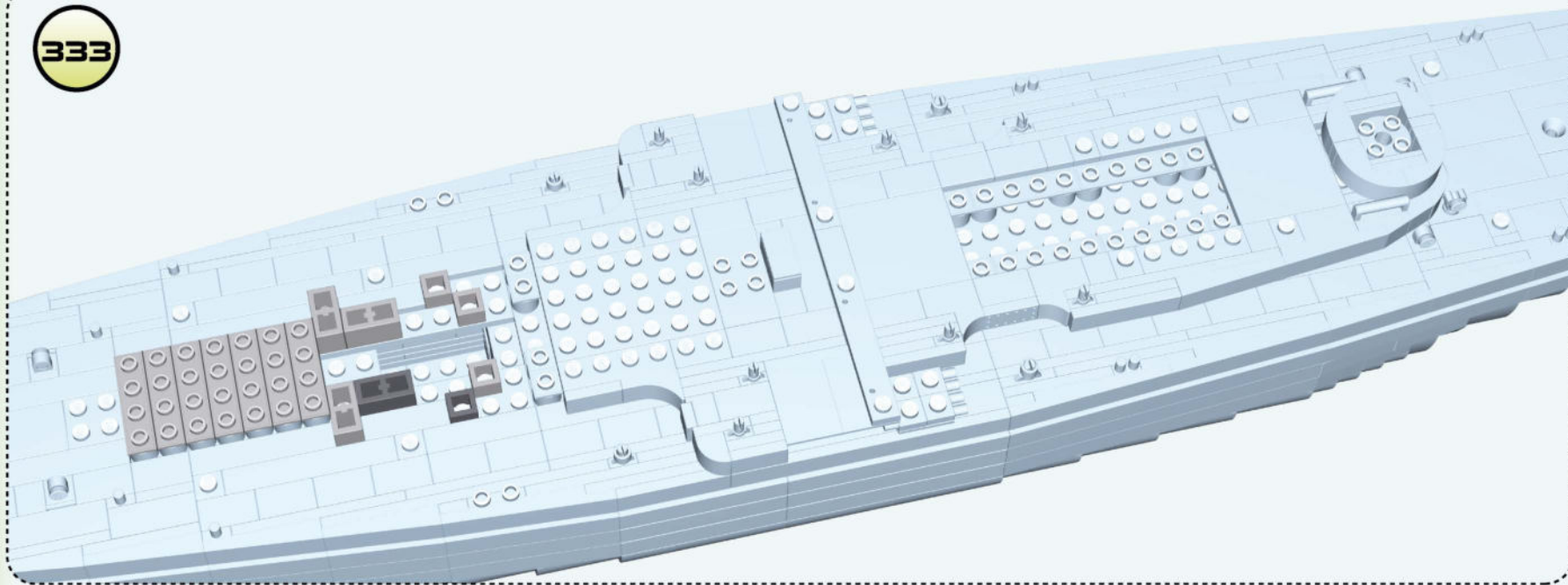

 x7

 x3

 x1

 x3

 x1

334

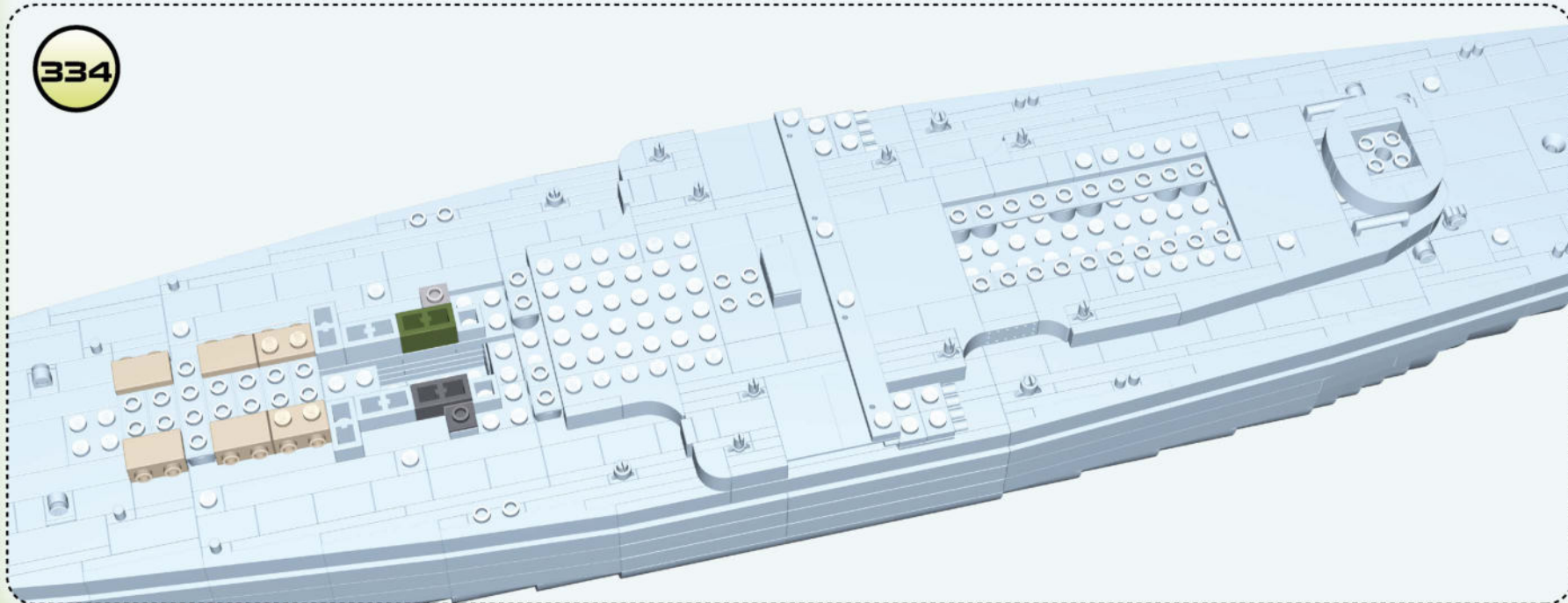

 x4

 x2

 x1

 x1

 x1

 x1

335

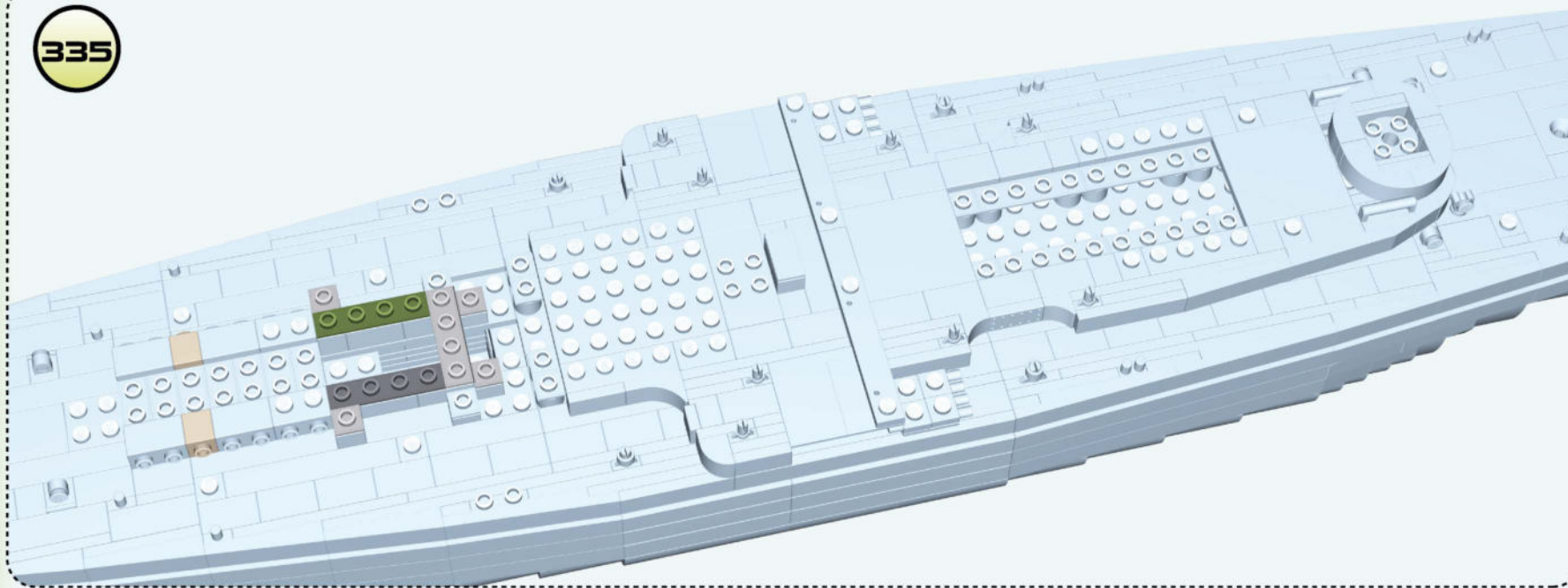

 x2

 x4

 x1

 x1

 x1

336 x2

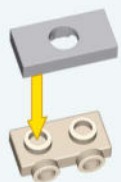

 x1

 x1

337 x2

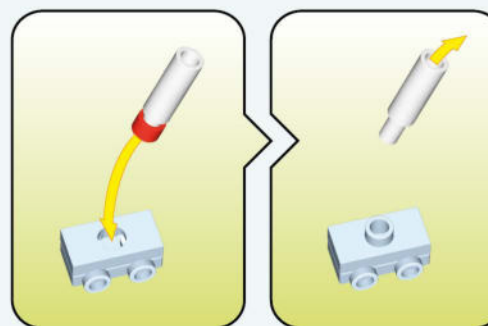

 x1

338

1:1

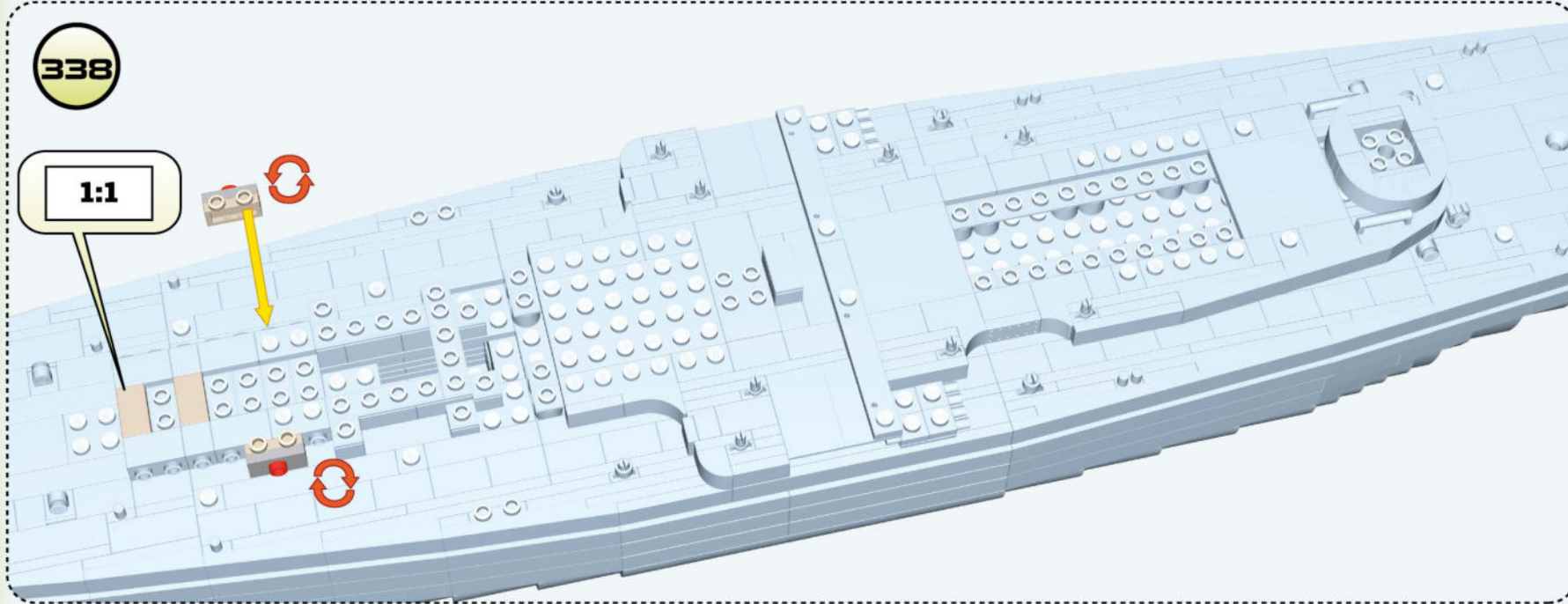

x2



8

339 x2

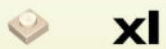

x1



x1

340 x2



1:1



x1

341

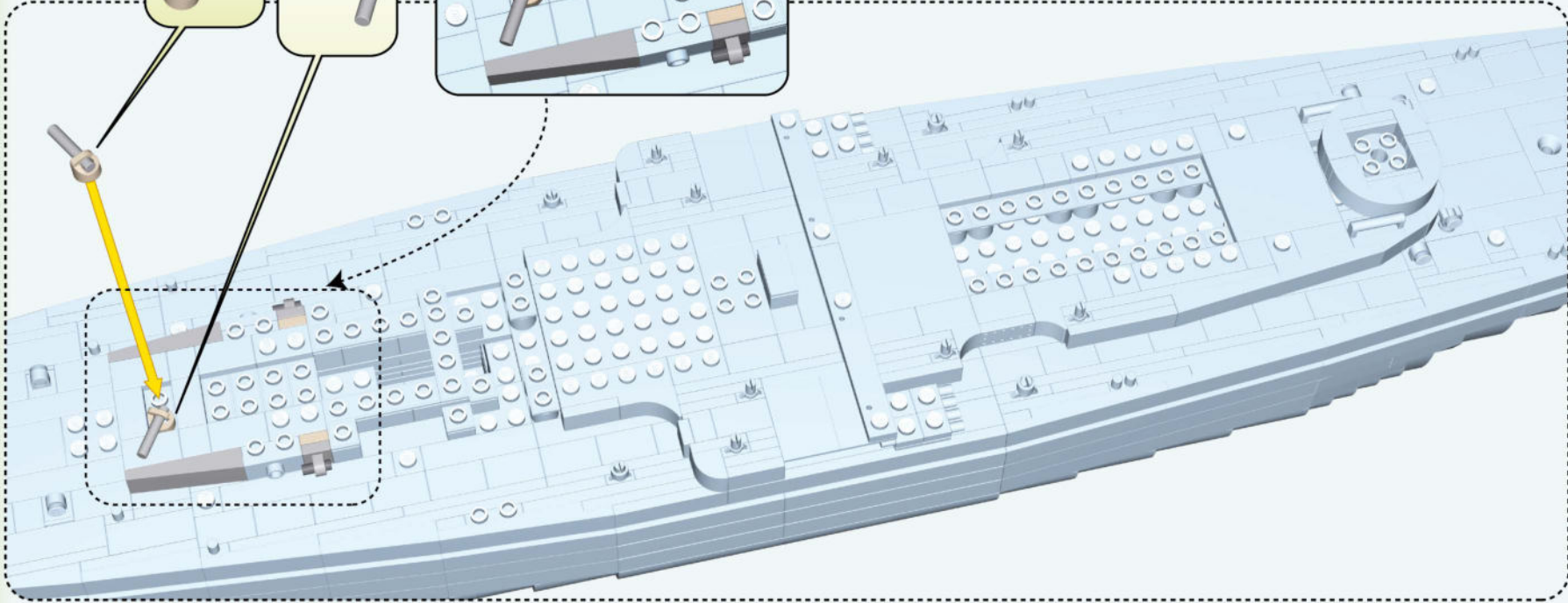
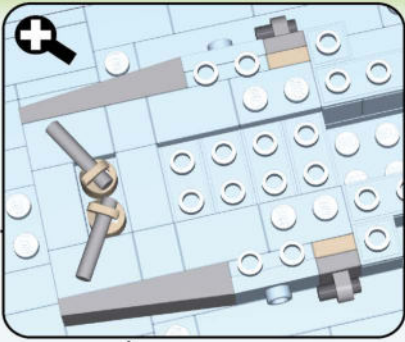

1:1



342

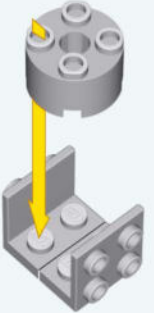

343

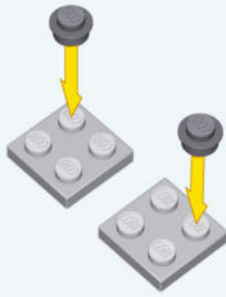

344

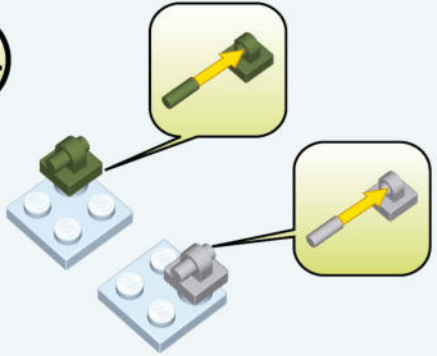



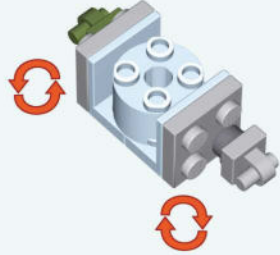

345

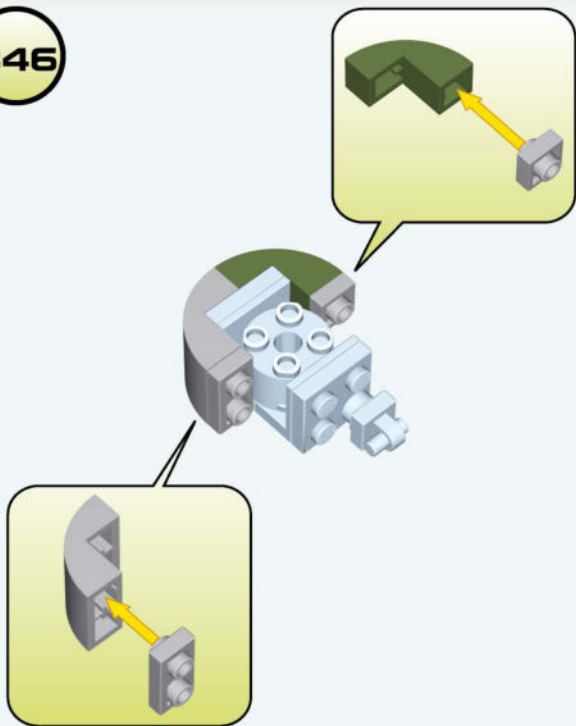

346



-  **x1**
-  **x1**
-  **x1**
-  **x1**

347

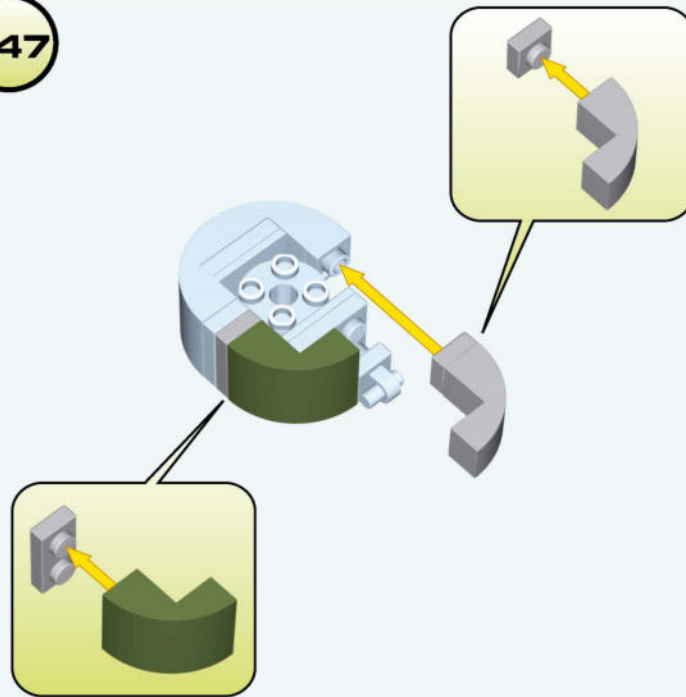

-  **x1**
-  **x1**
-  **x1**
-  **x1**



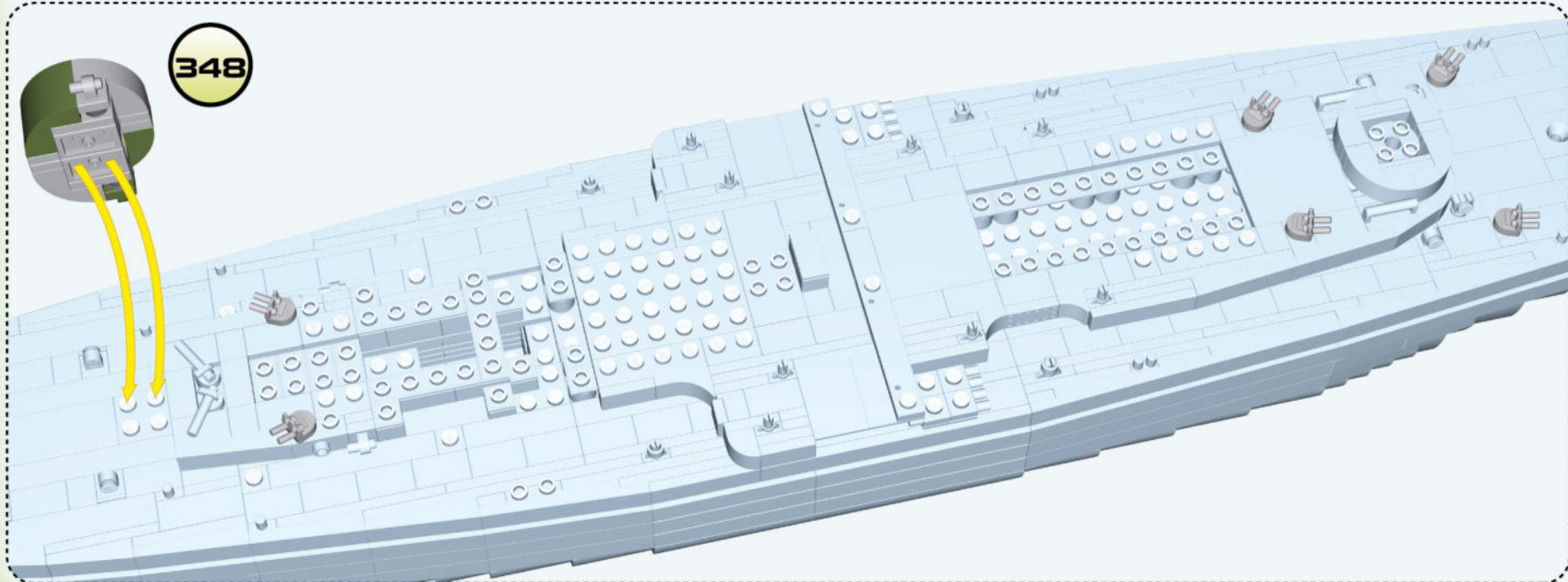

348

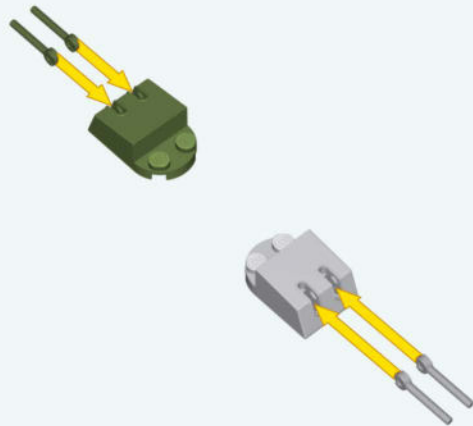

-  **x6**

349



-  x1
-  x2
-  x1
-  x2

350

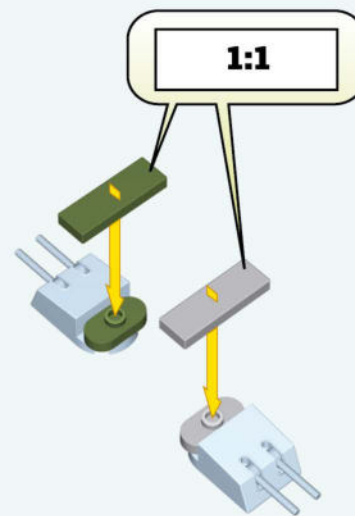

-  x1
-  x1
-  x1
-  x1

351

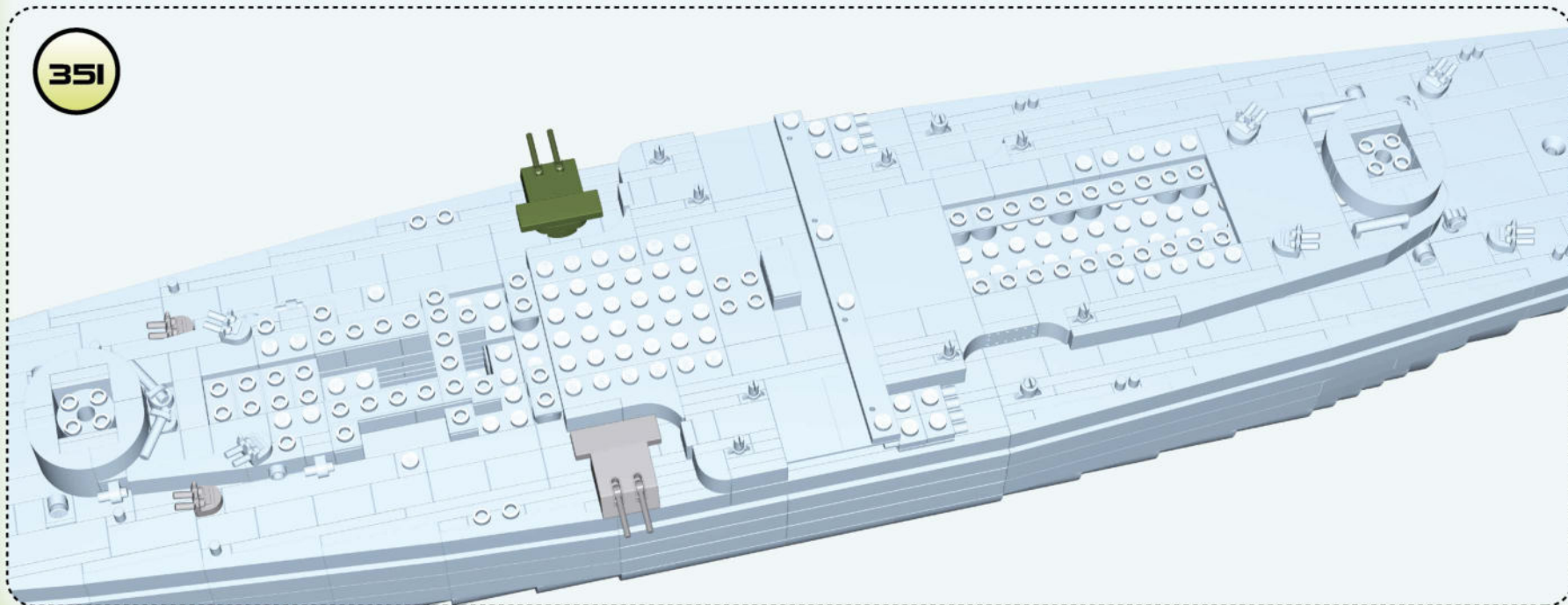

-  x2

352

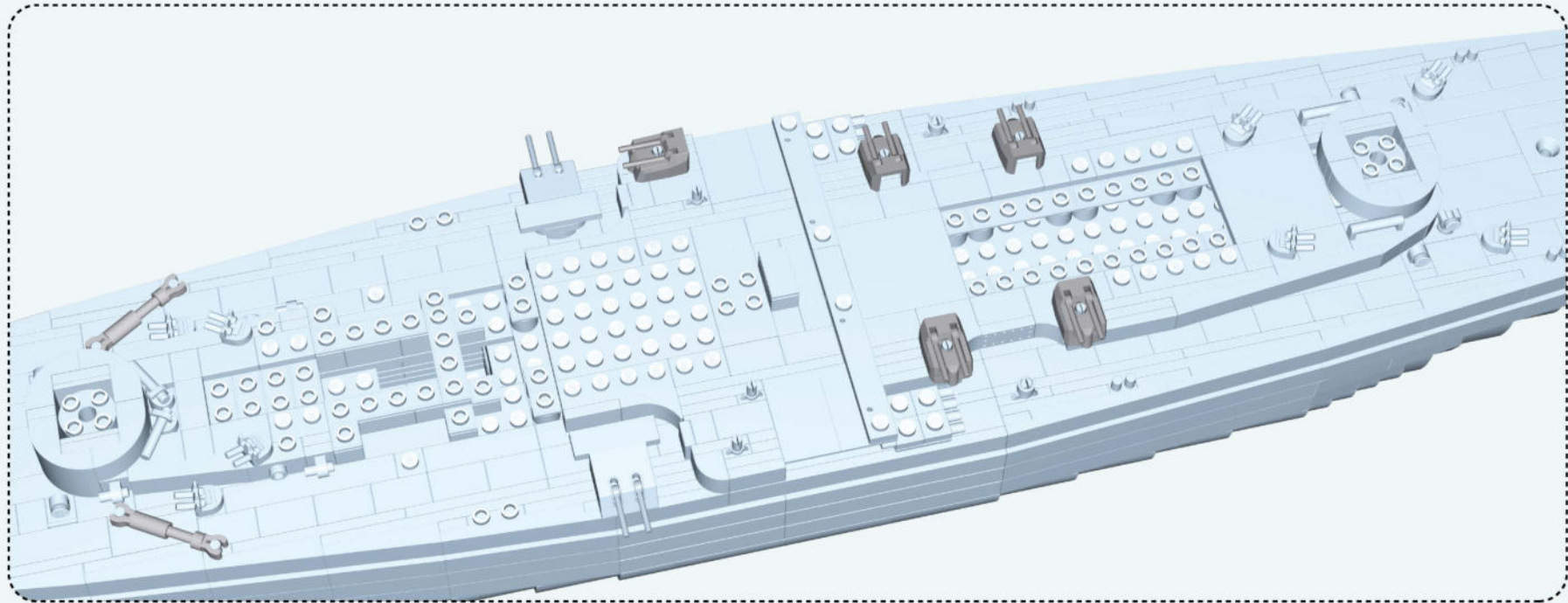
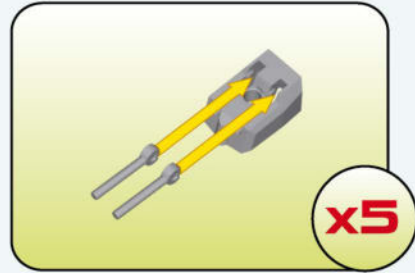
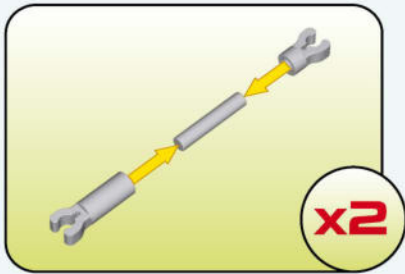

1:1



353

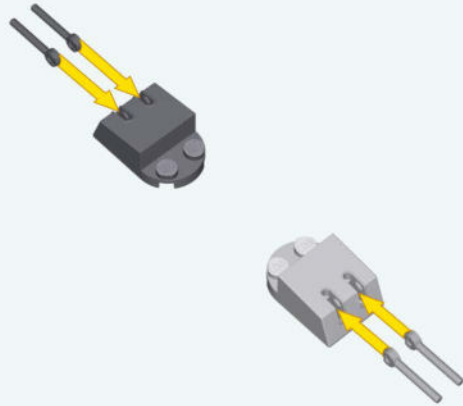

 x1

 x2

 x1

 x2

354

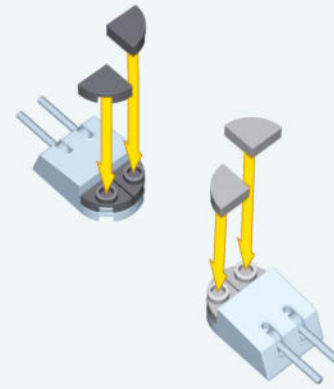

 x2

 x2

 x2

 x2

355

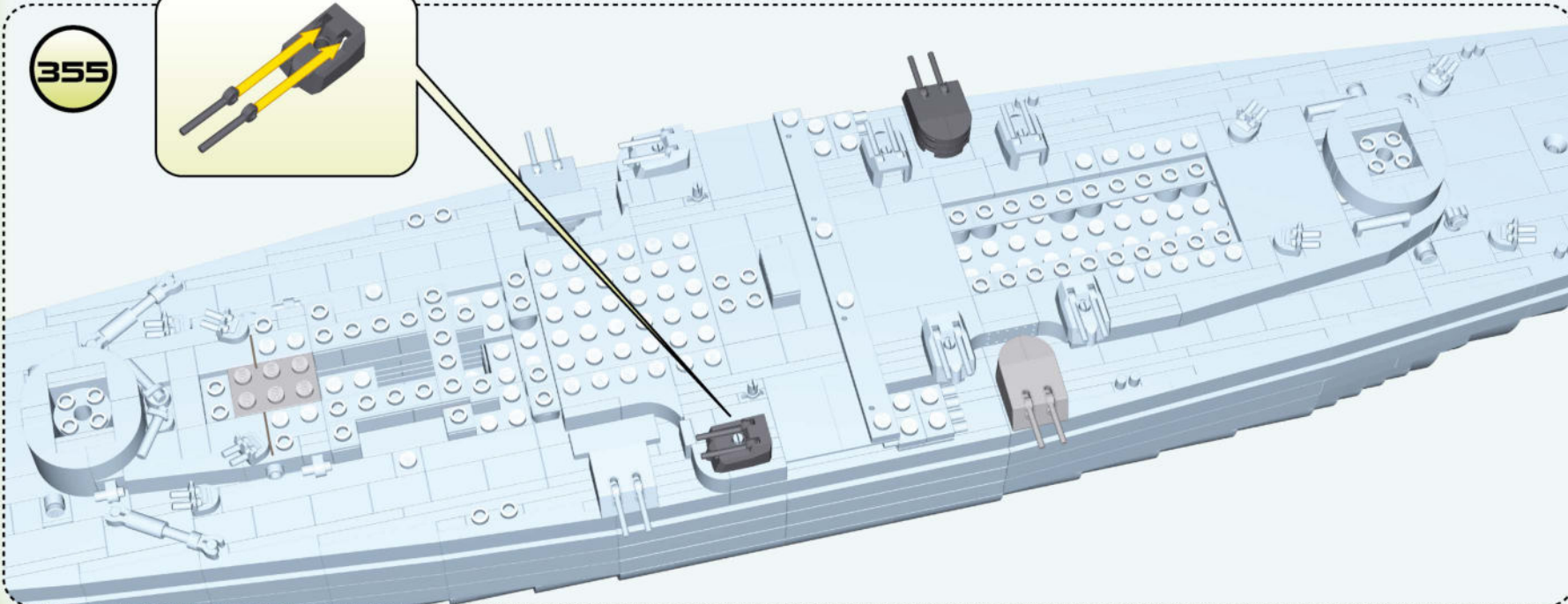

 x1

 x1

 x2

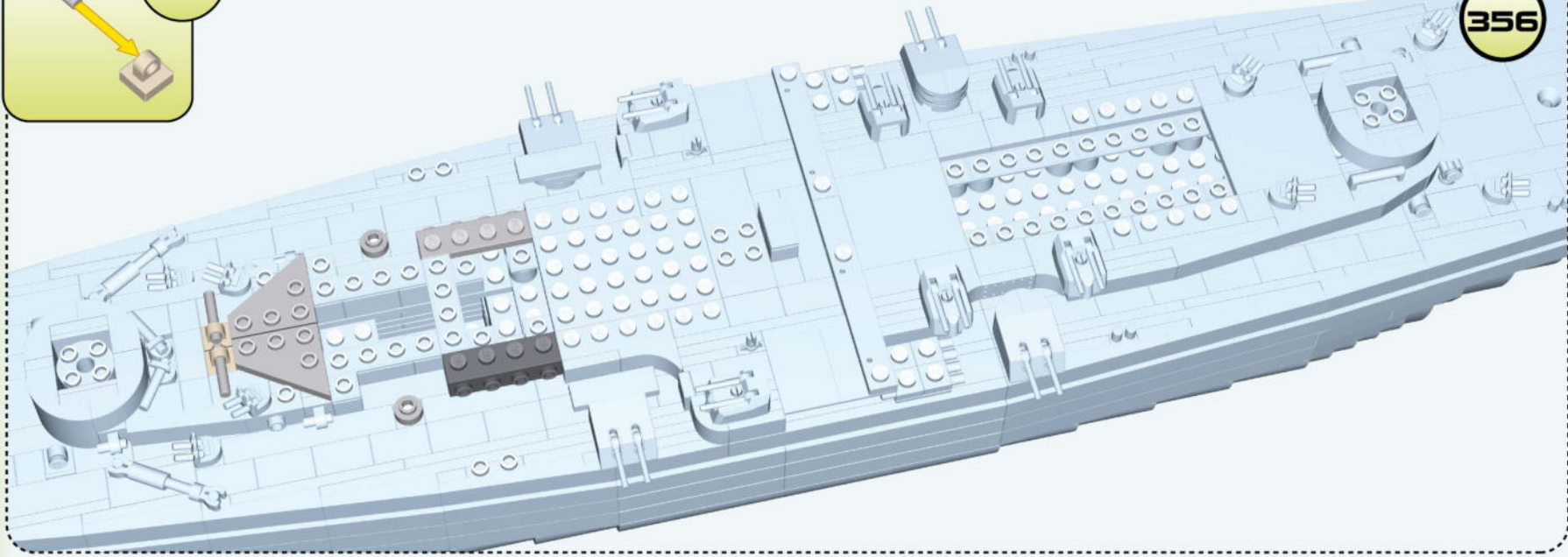
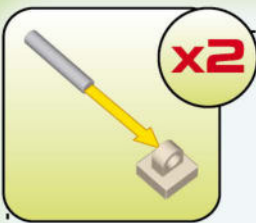

-  x2
-  x2
-  x1
-  x1
-  x2
-  x1
-  x1



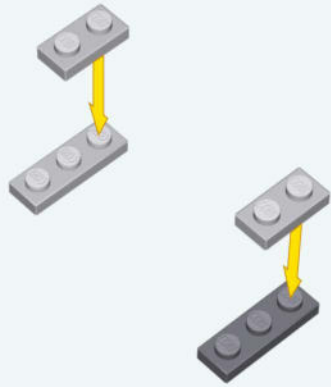



357

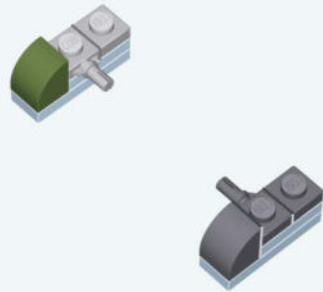

-  x1
-  x1
-  x2

358



-  x1
-  x1
-  x1
-  x1
-  x1
-  x1

359

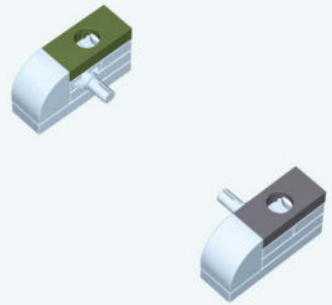

-  x1
-  x1

360

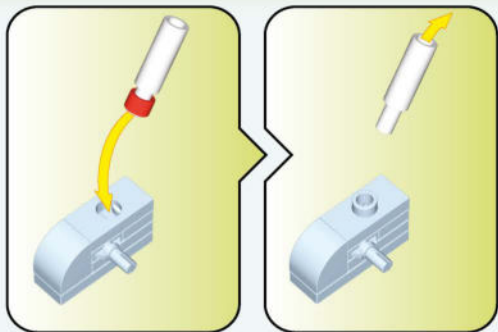

x2

361

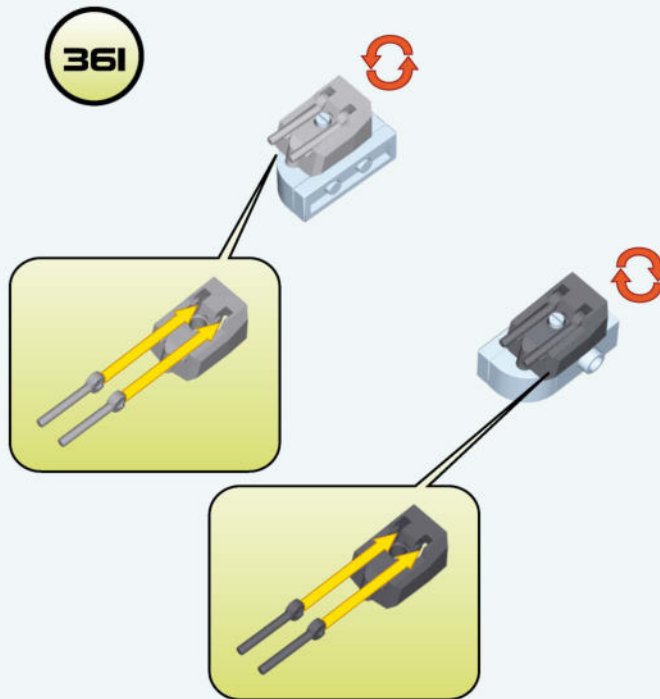

x1

x2

x1

x2

362

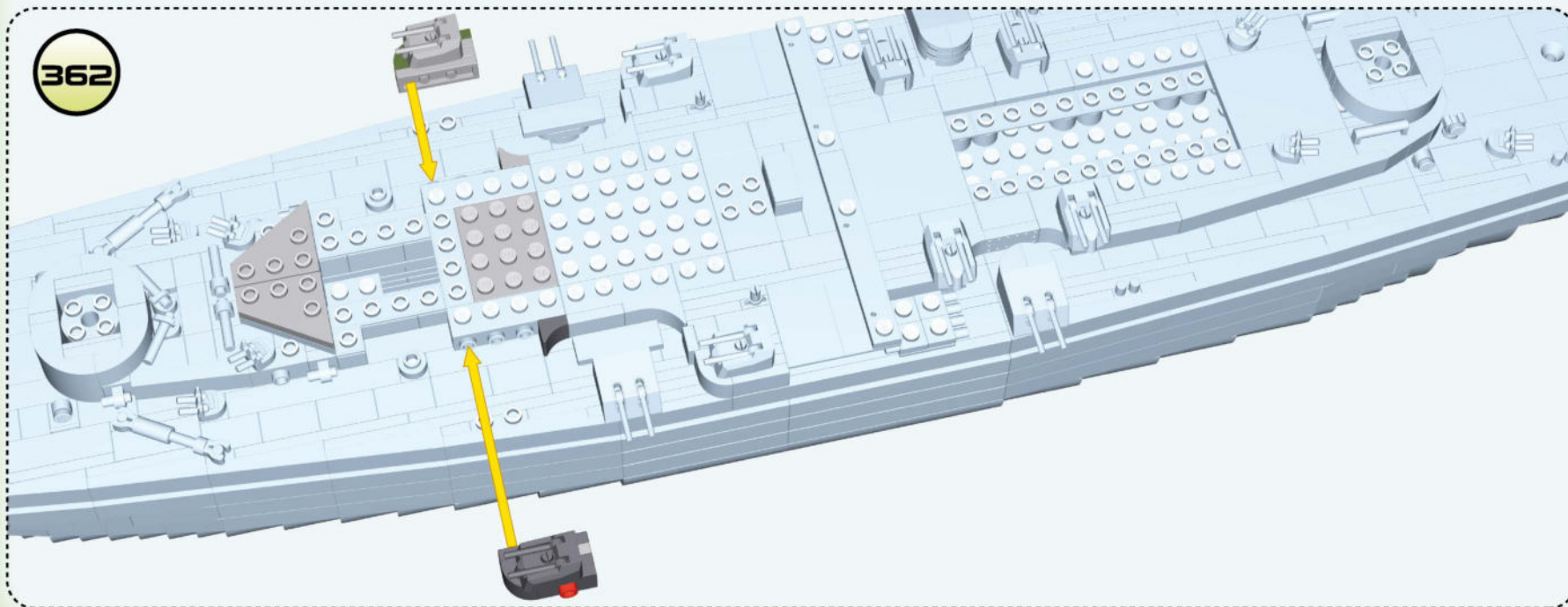

x1

x1

x1

x1

x1

363

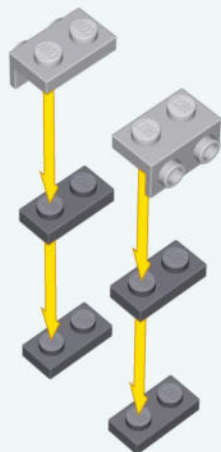

 x4

 x2

364

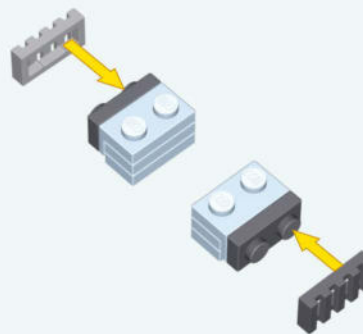

 x2

 x1

 x1

365

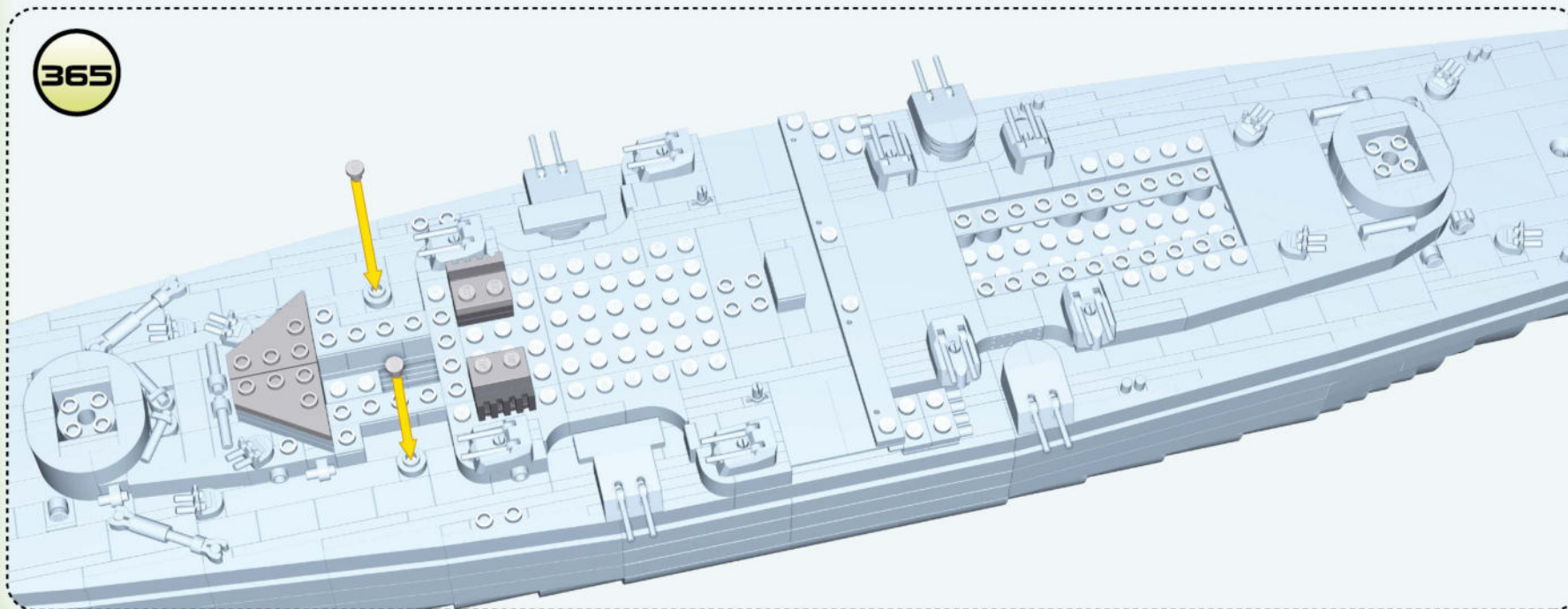

 x1

 x1

 x2

366

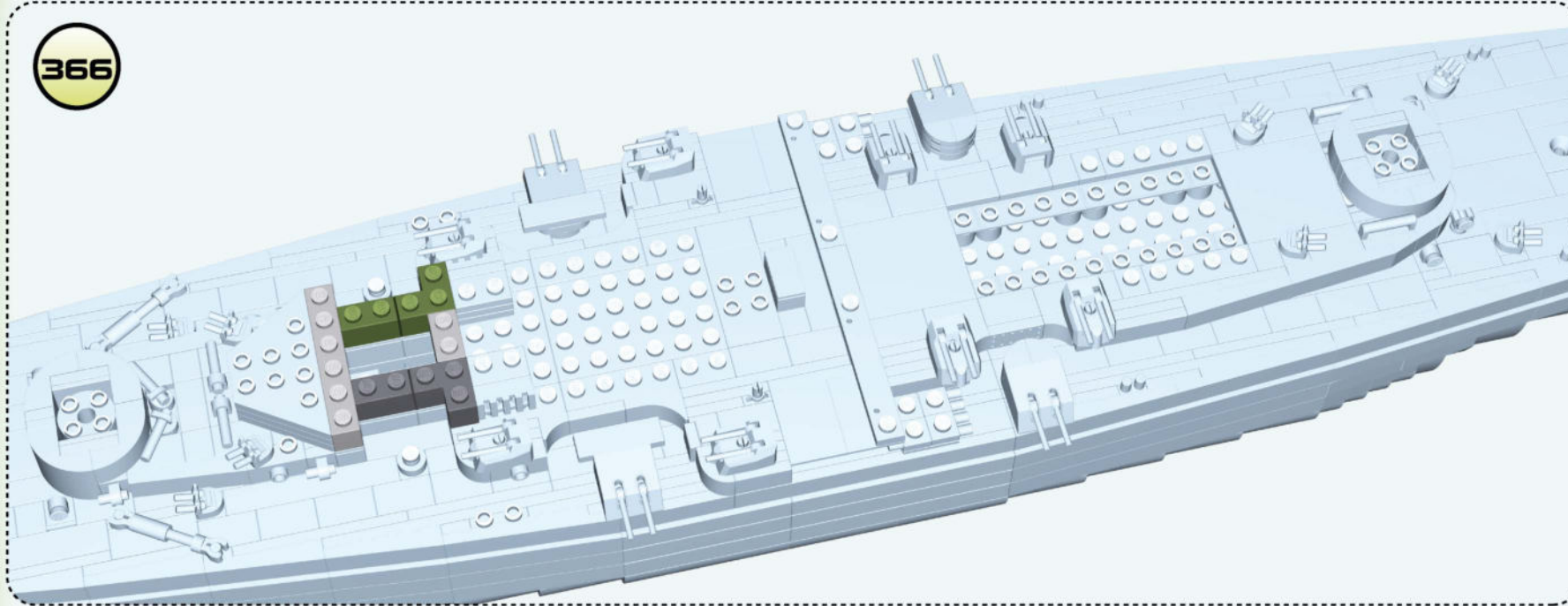

x1



x1



x1



x1



x1



x1

367

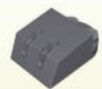
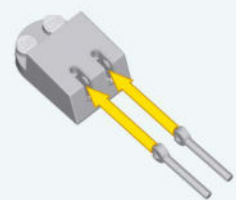
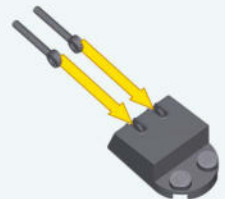

x1



x2



x1



x2

368



x2



x2



x2



x2

369

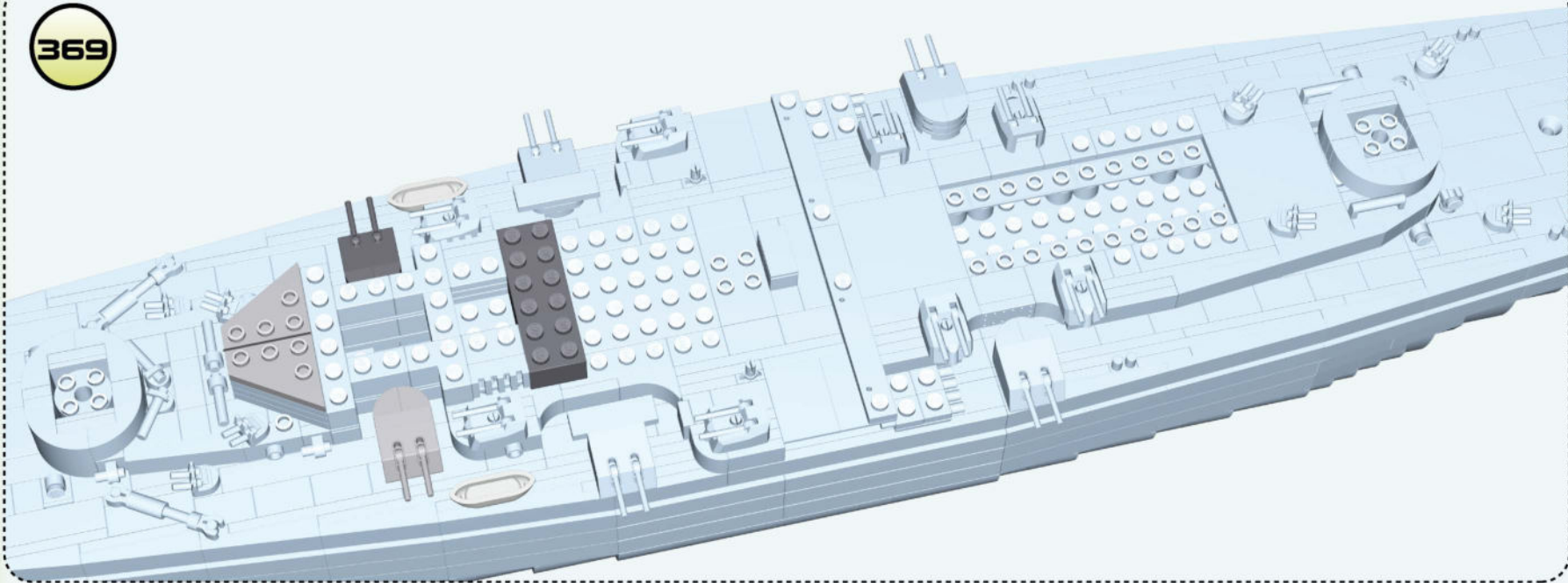

x1



x1



x2



x1

370

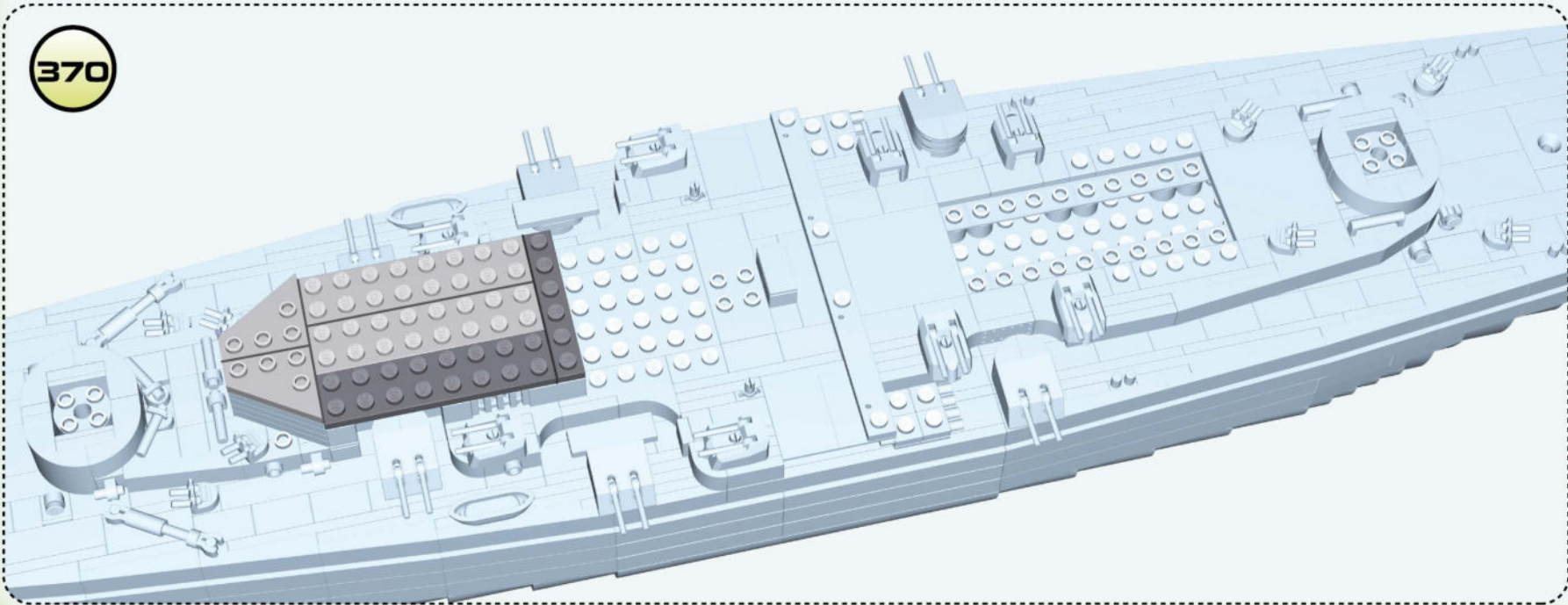

x1



x1



x2



x1







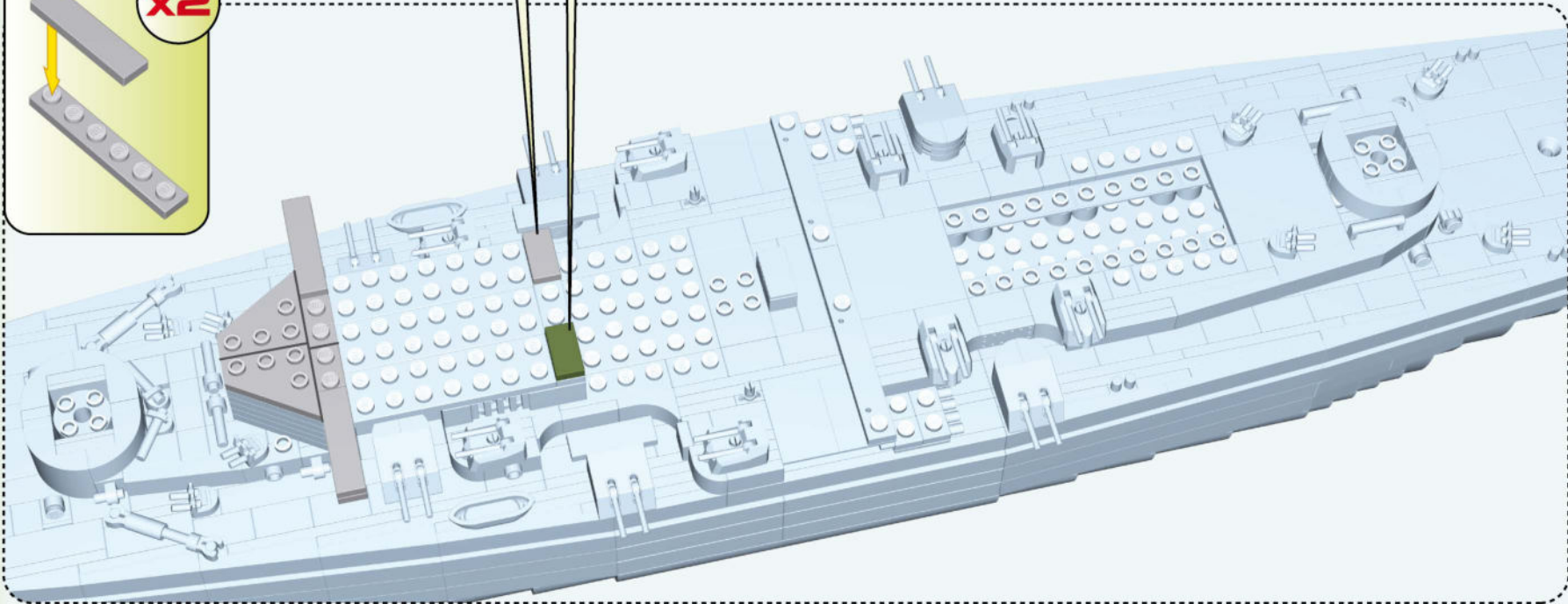
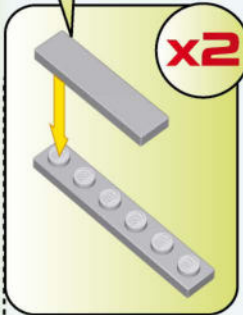

x1

1:1

371



1:1



-  x1
-  x1
-  x2
-  x2
-  x1
-  x1

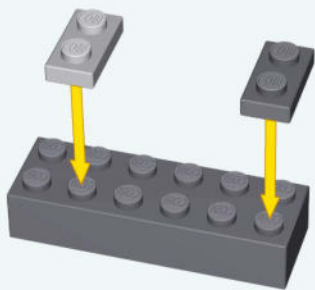

372

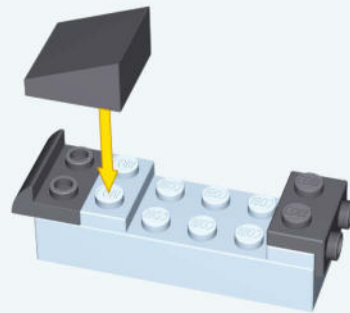

-  x1
-  x1
-  x1

373



-  x1
-  x1
-  x1

374

1:1

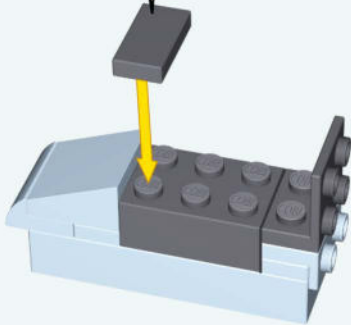

x1



x1



x1

375

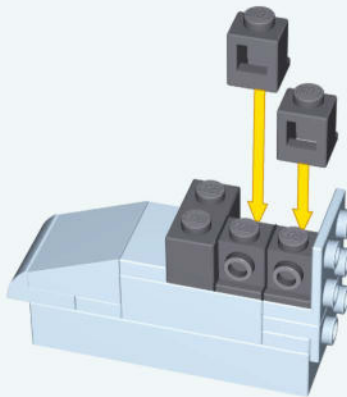

x1



x4

376

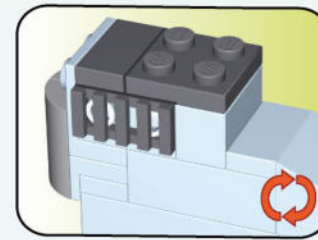

1:1

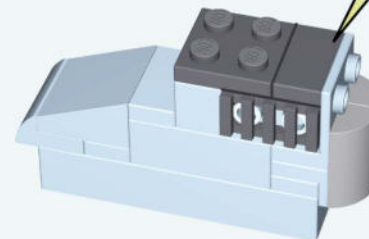

x1



x1



x2



x2

377

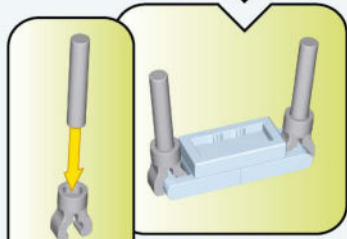

x2

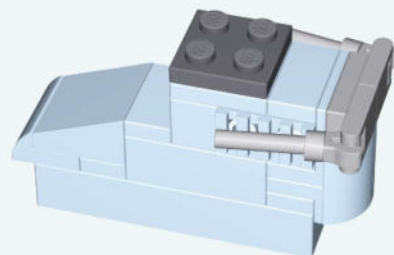

x1



x2



x1



x2



x2

1:1

378

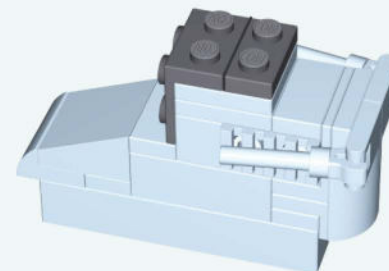

x1



x1

379

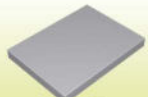

x1



x1

380

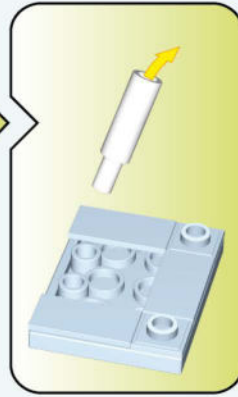
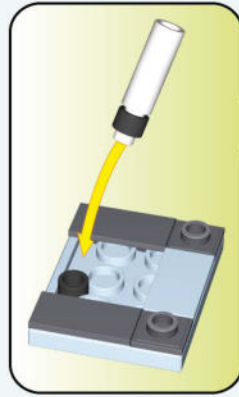

x2



x2



x2

381

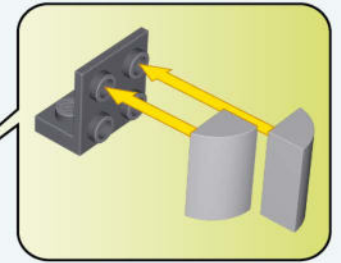
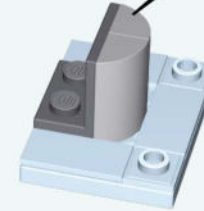

x1



x2

382

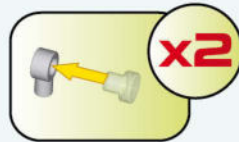
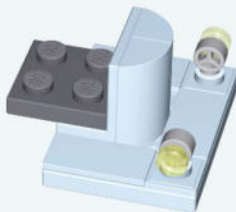

x1



x2



x2

383

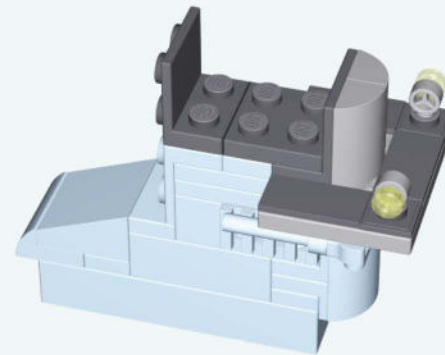

x1