

HISTORICAL COLLECTION

WORLD WAR II



WORLD WAR II



HMS BELFAST

PLACE OF ORIGIN - UNITED KINGDOM
 IN SERVICE - 1939 - 1963
 TYPE - TOWN-CLASS LIGHT CRUISER
 MOTTO - PRO TANTO QUID RETRIBUAMAS
 (LATIN: FOR SO MUCH, HOW SHALL WE REPAY?)
 LAUNCHED - 17 MARCH 1938
 COMMISSIONED - 5 AUGUST 1939
 DECOMMISSIONED - 24 AUGUST 1963
 FATE - MUSEUM SHIP SINCE 21 OCTOBER 1971
 DISPLACEMENT - 11553t (25,470,007LB)
 LENGTH - 186,99m (613' 6") OVERALL
 BEAM: 21m (69')
 DRAUGHT - 6,02m (19' 9")
 PROPULSION - FOUR ADMIRALTY OIL-FIRED 3-DRUM
 BOILERS FOUR PARSONS SINGLE REDUCTION
 GEARED STEAM TURBINES DRIVING FOUR SHAFTS
 AT 80,000_{SHIP} (65621KW)
 SPEED - 32KNOTS (59KM/H, 36.6MPH)
 ARMAMENT (1959) - TWELVE (4x3) 6-INCH MK XXIII
 EIGHT (4x2) QF 4-INCH (101,6MM) MK XVI HA/LA
 TWELVE (6x2) QF 40MM BOFORS AA
 ARMOUR - 4.5" (114 MM) DECK 3" (76MM)
 COMPLEMENT - 750 - 850 (AS FLAGSHIP)



4844

Printed in EU

PAD PRINTED
NO STICKERS



WARNING: CHOKING HAZARD-
Toy contains small parts.
Not for children under 3 years.

1517

HMS BELFAST

SCALE 1:300



+



+



BE CAREFUL: NOTICE THE DIFFERENCE

UWAGA: RÓŻNE KLOCKI



1

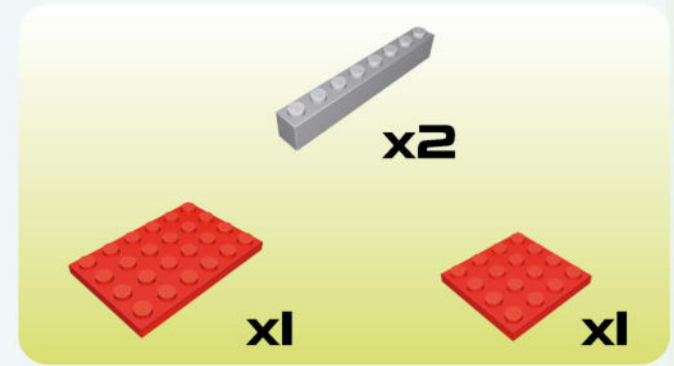
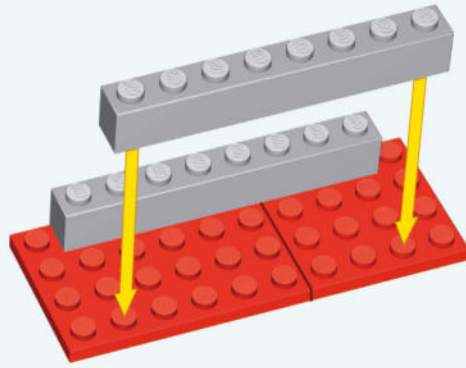

2

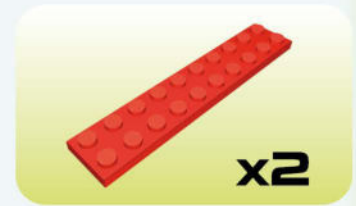

3

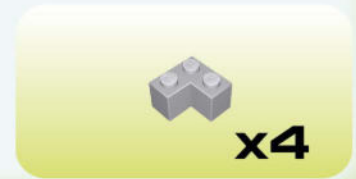
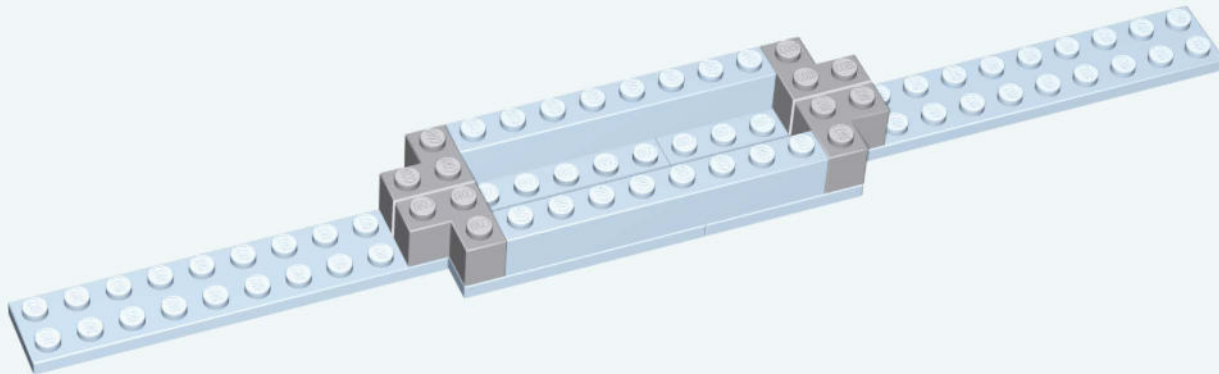

4

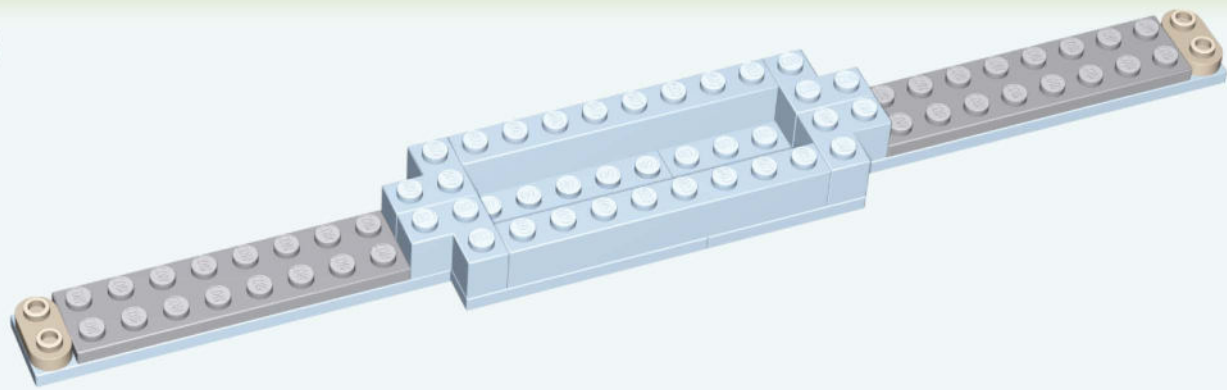

5



6

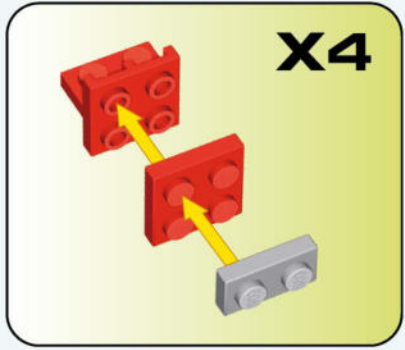
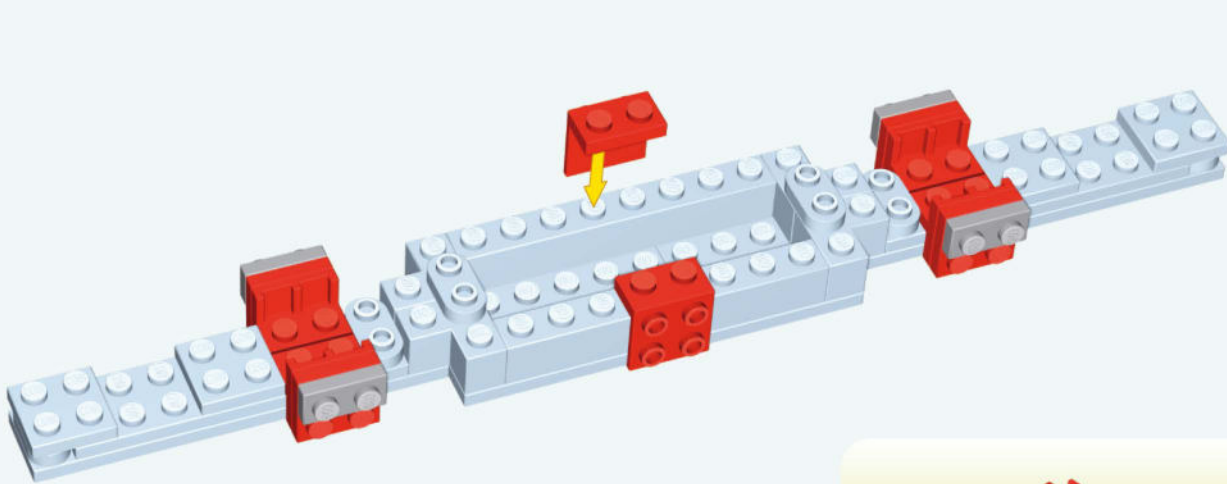

7

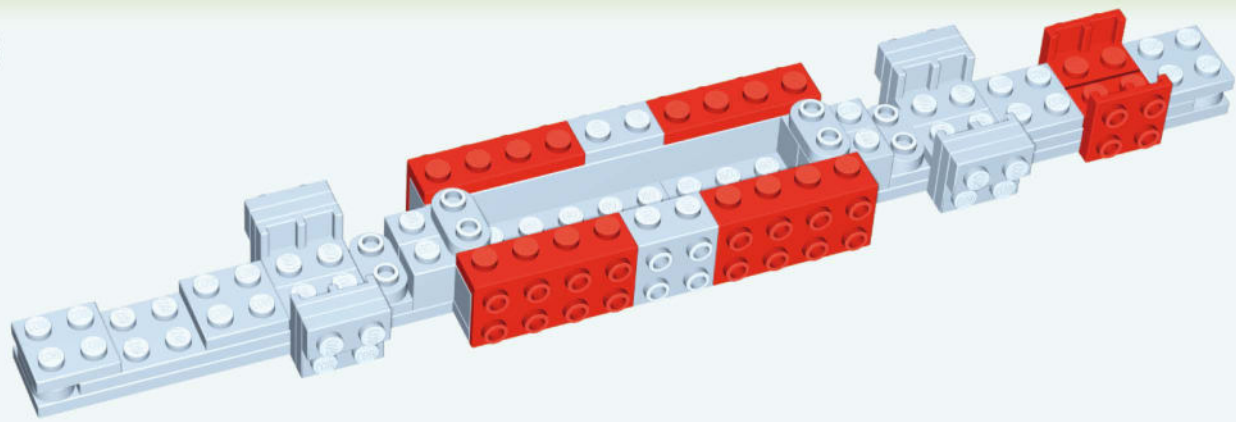

8

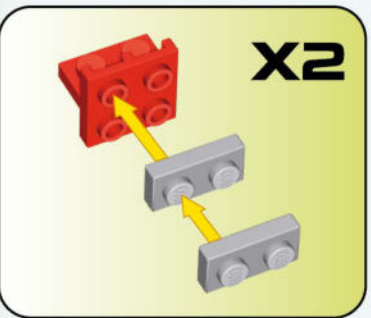
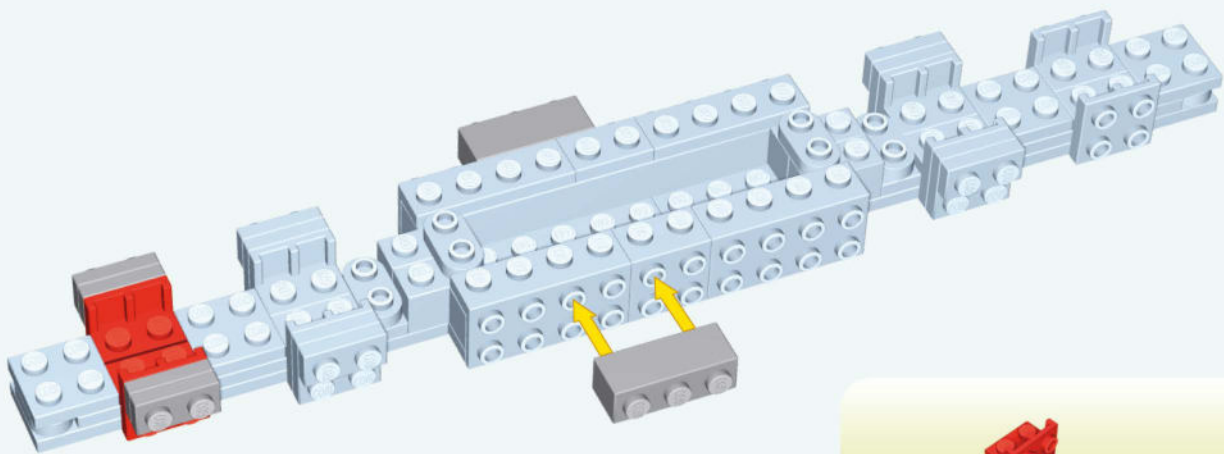

9

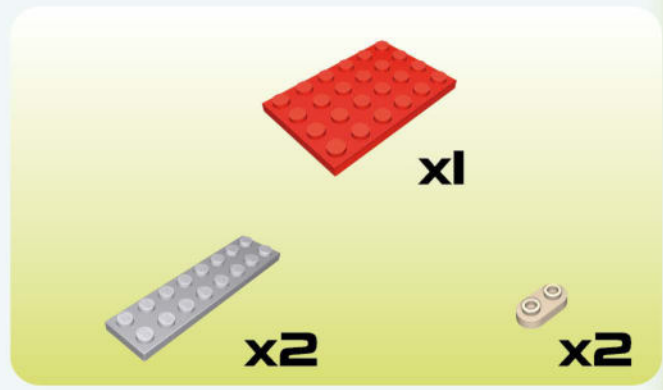
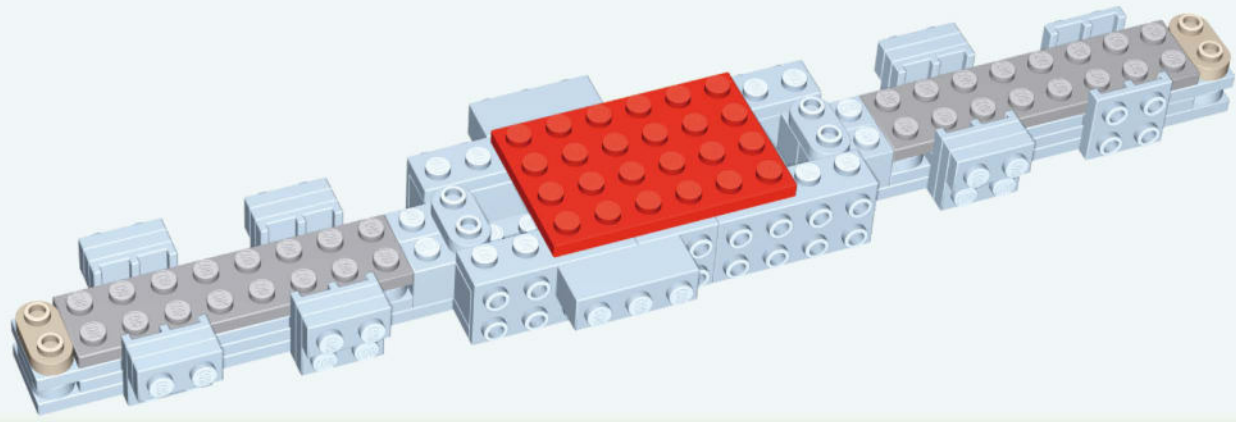

10

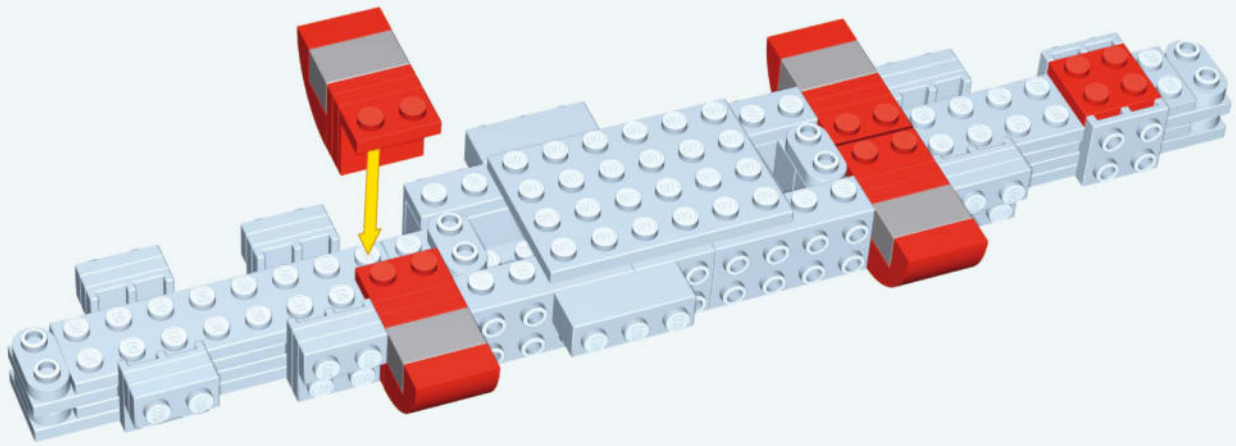
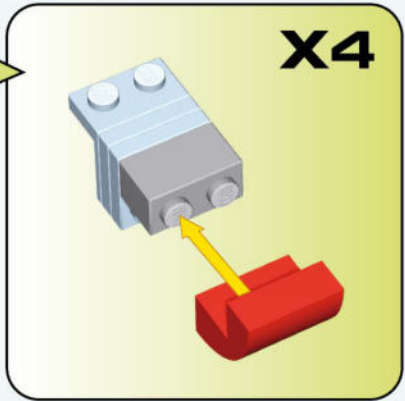
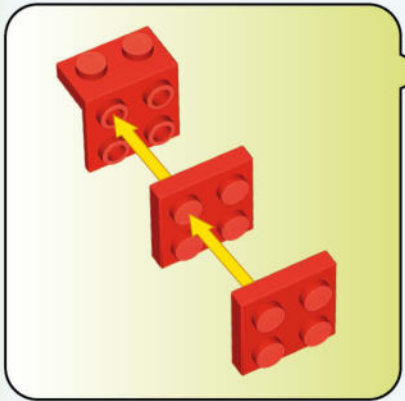

11

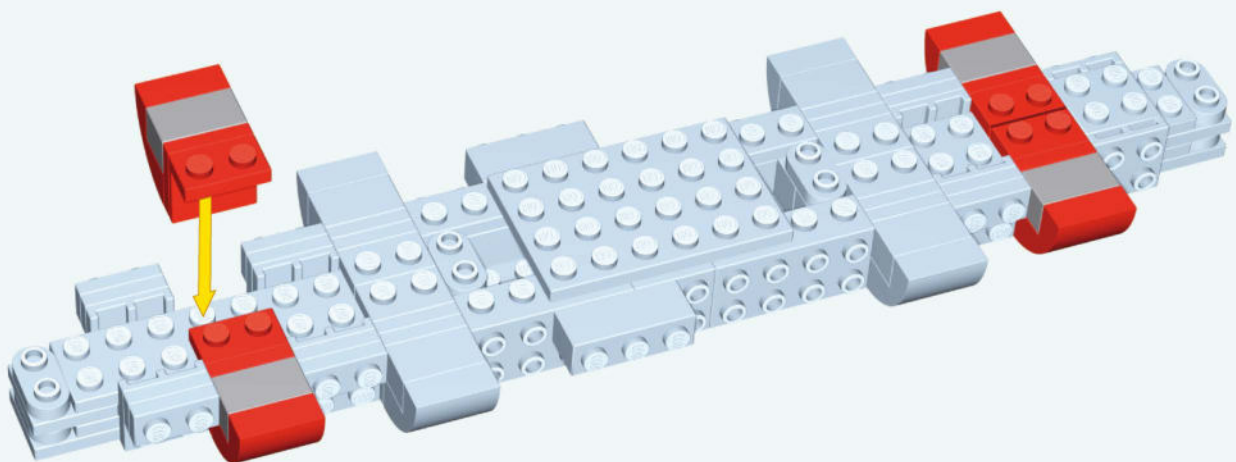
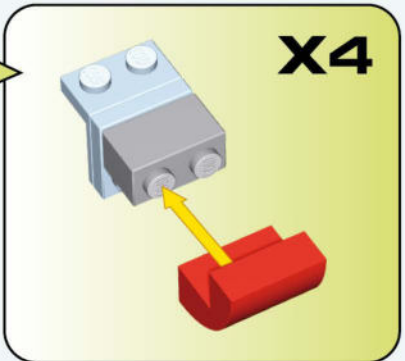
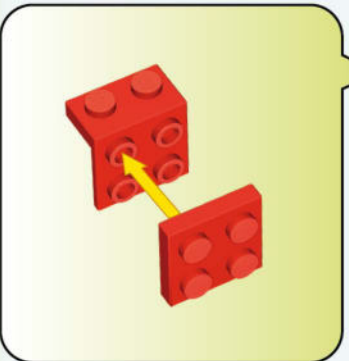

12

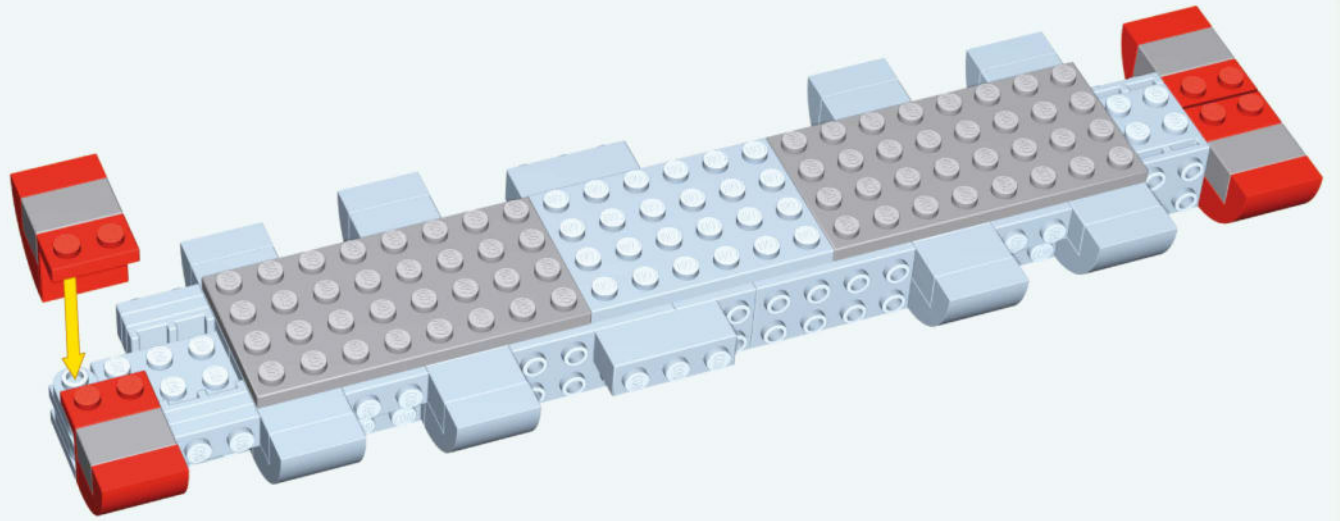
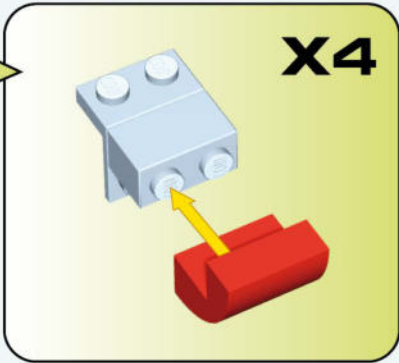
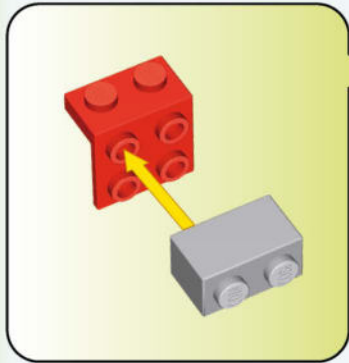

13

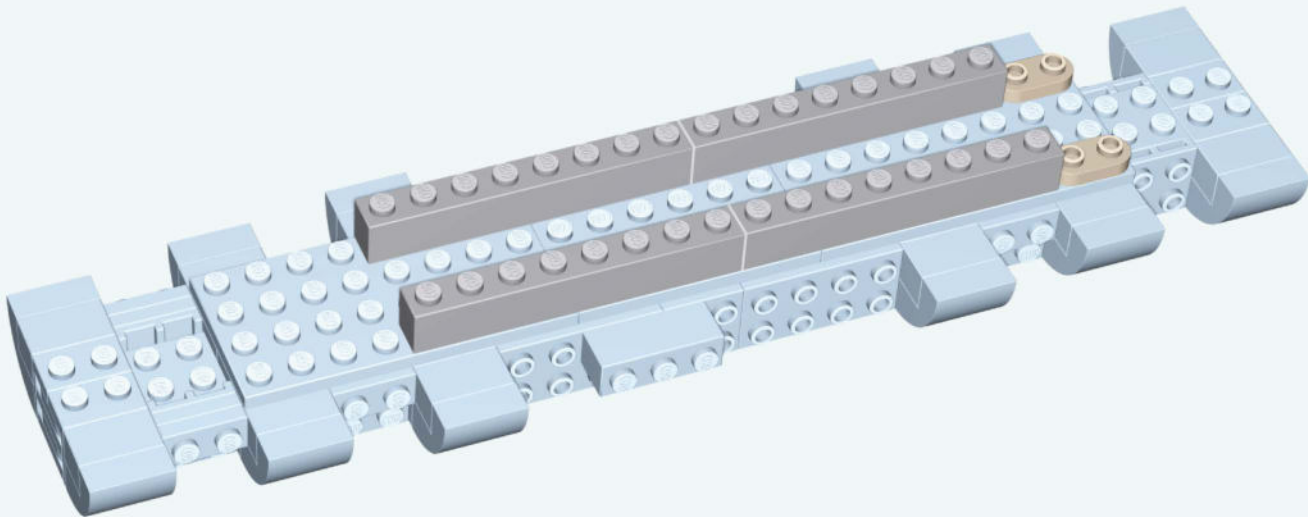

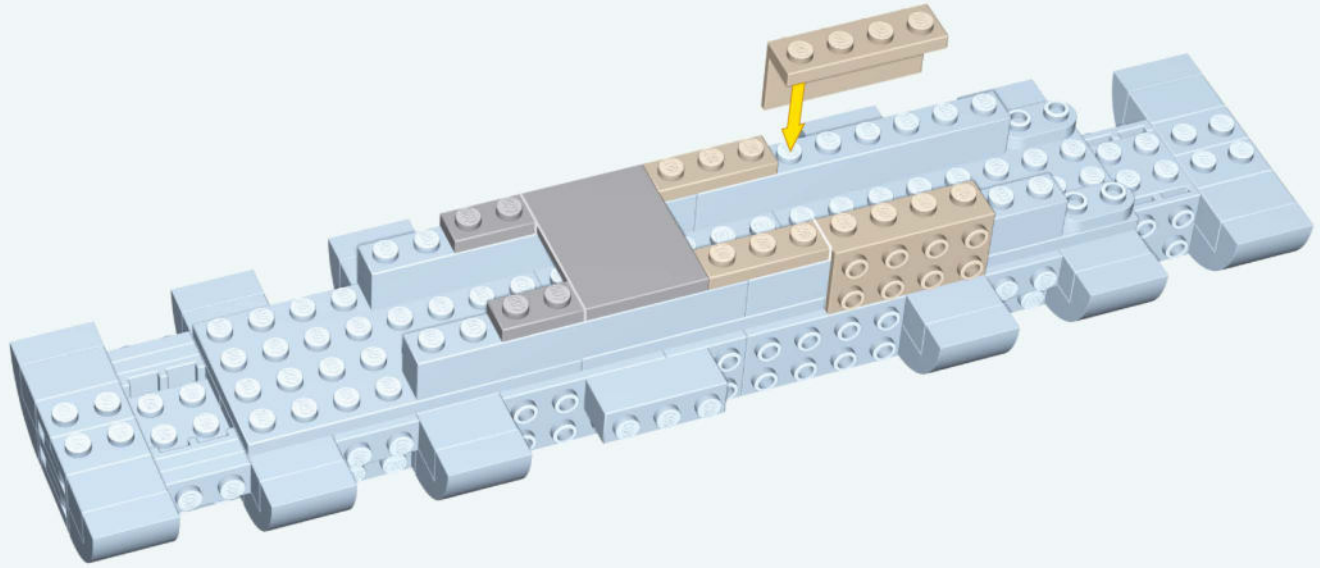

14

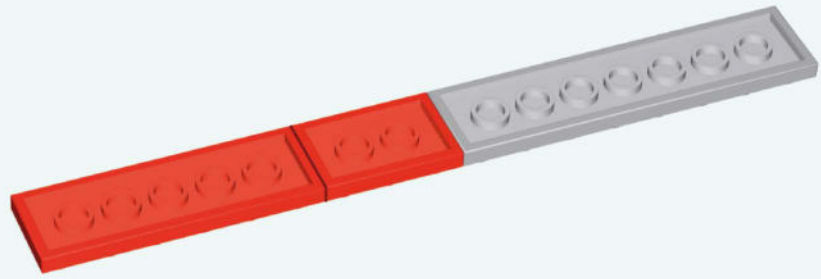

-  x2
-  x1
-  x2
-  x2

15



-  x1
-  x1
-  x1

16

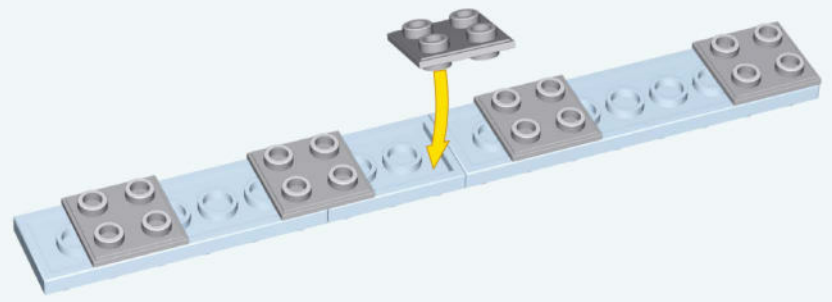

-  x5

17

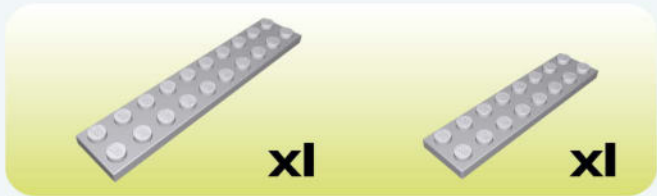
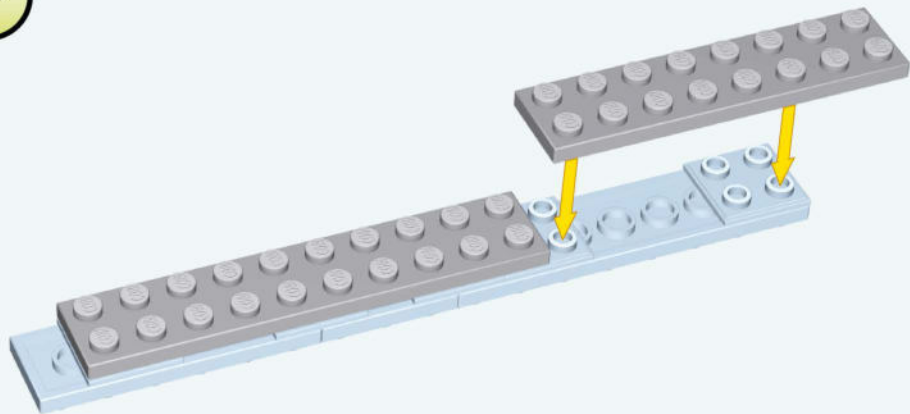

18



19

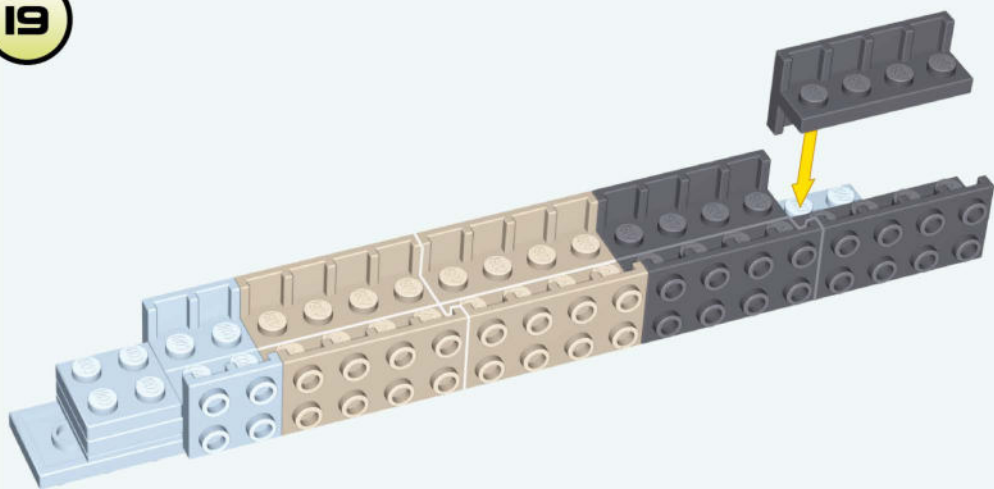

20

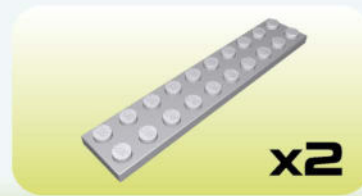
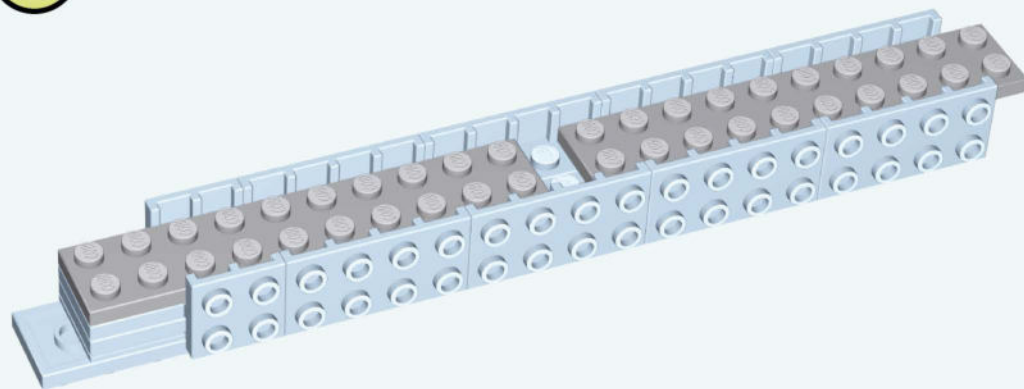

21

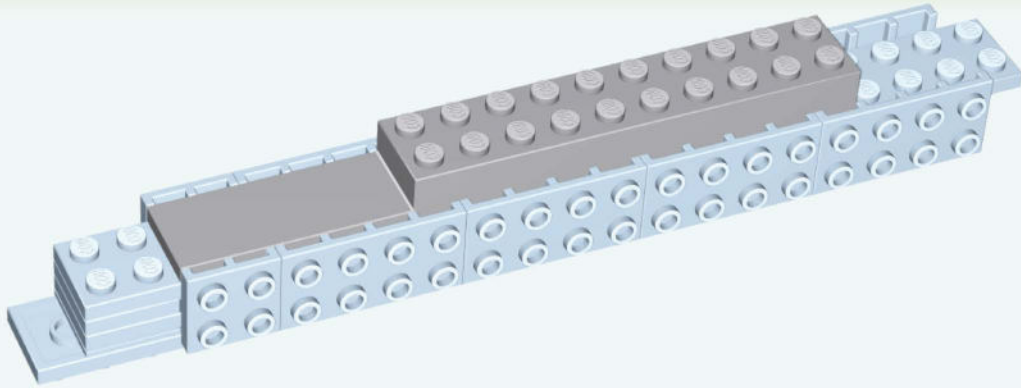

22

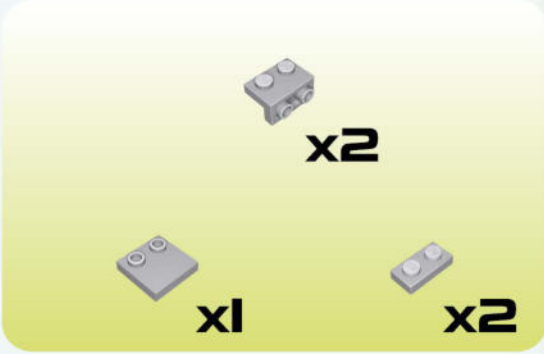
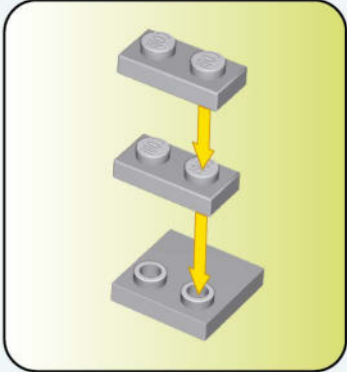
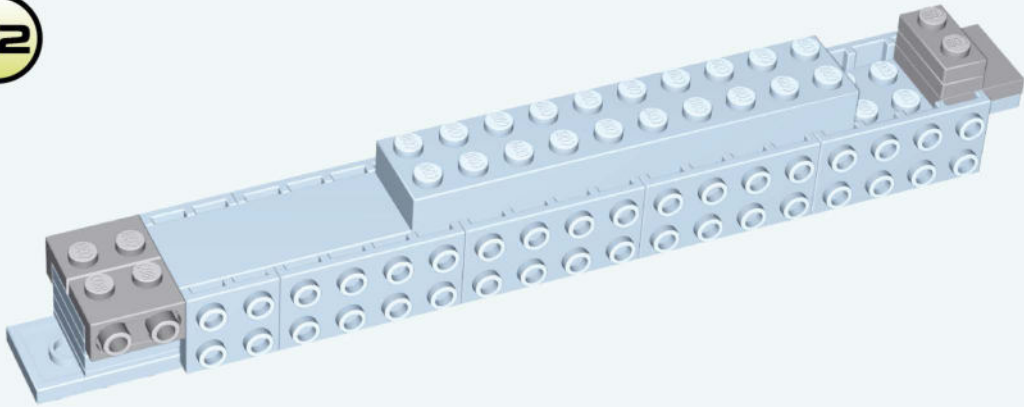

23

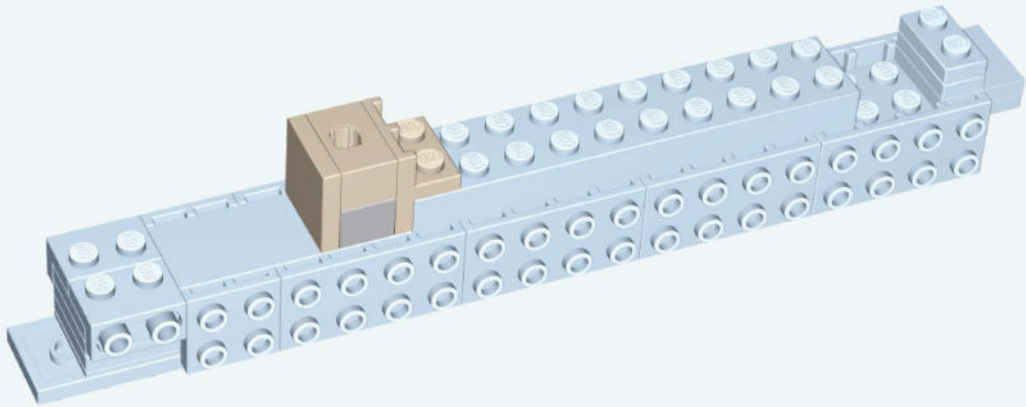
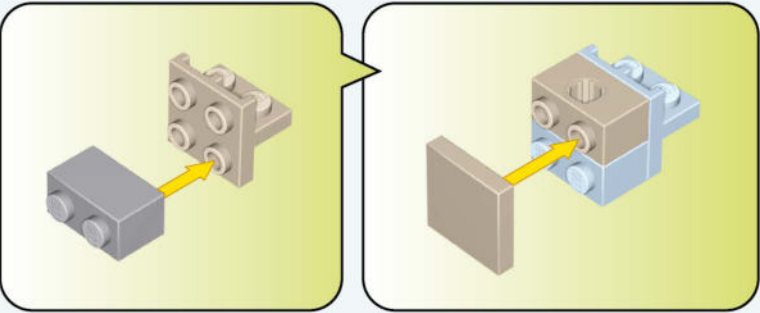

24

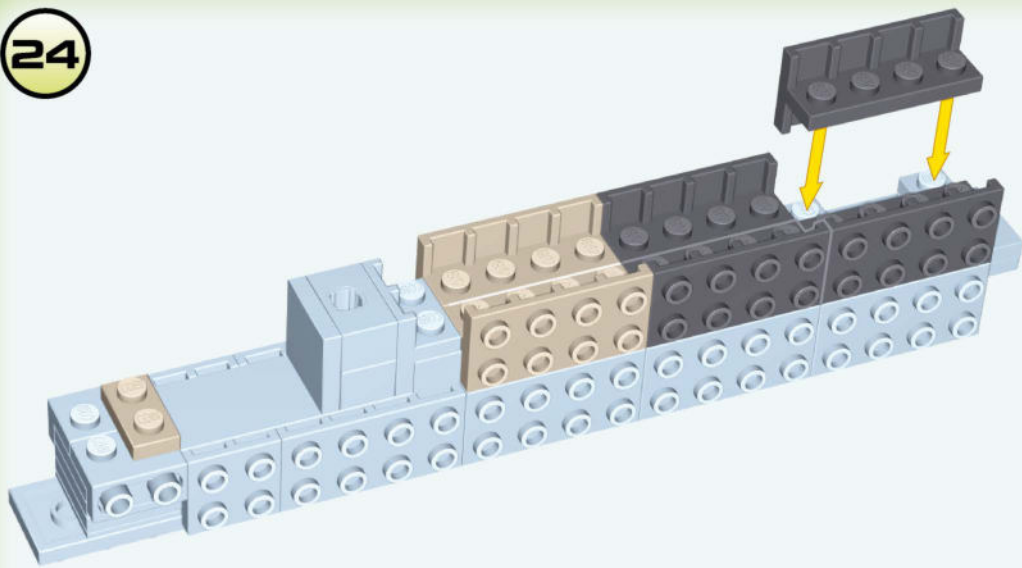

25

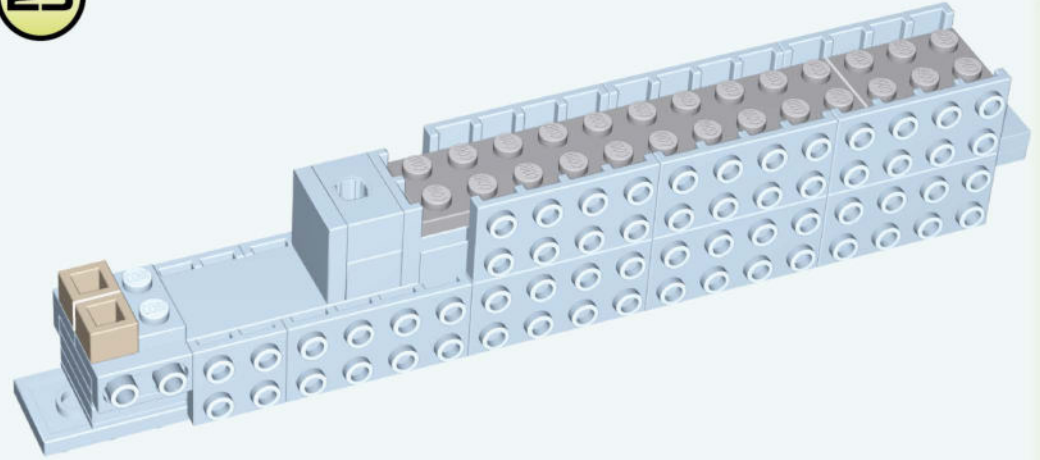

26

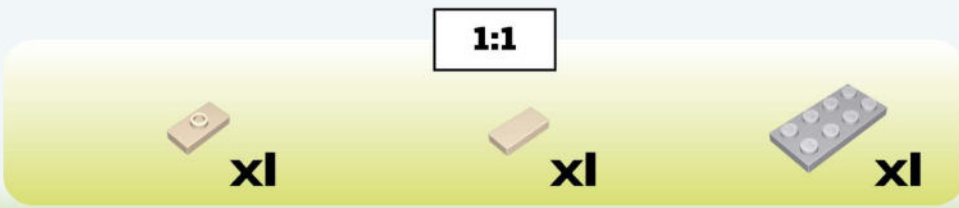
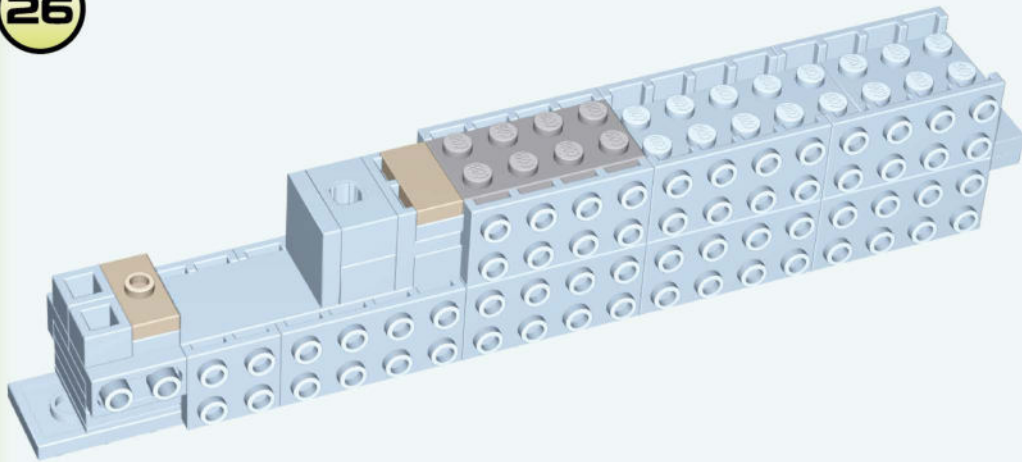

27

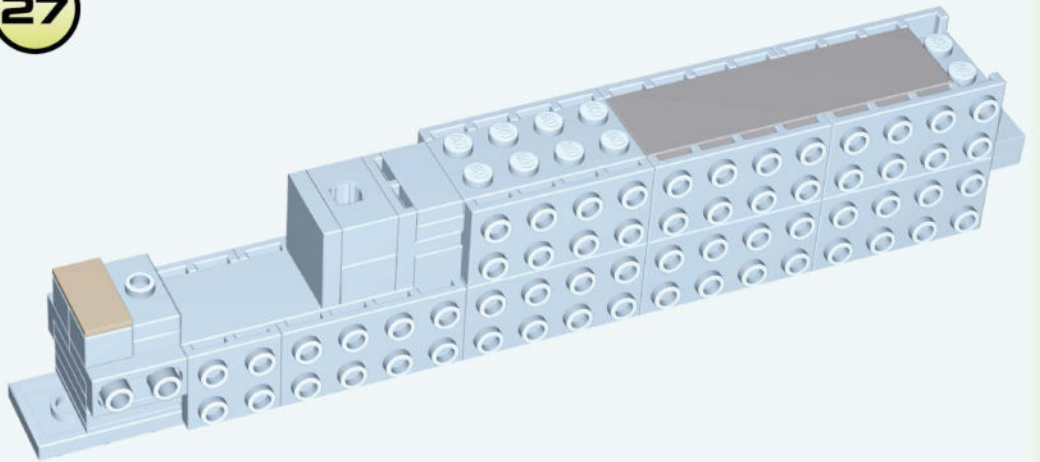

28

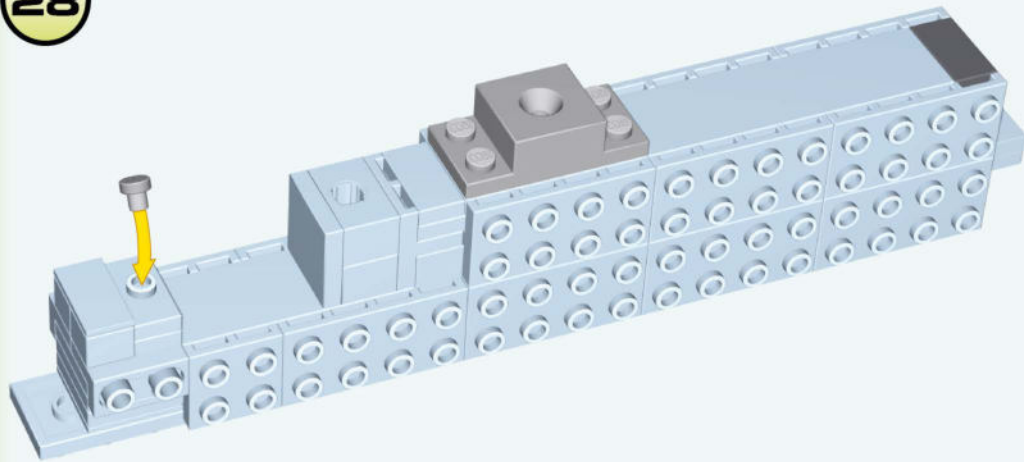

1:1



x1

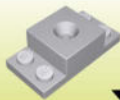

x1



x1

29

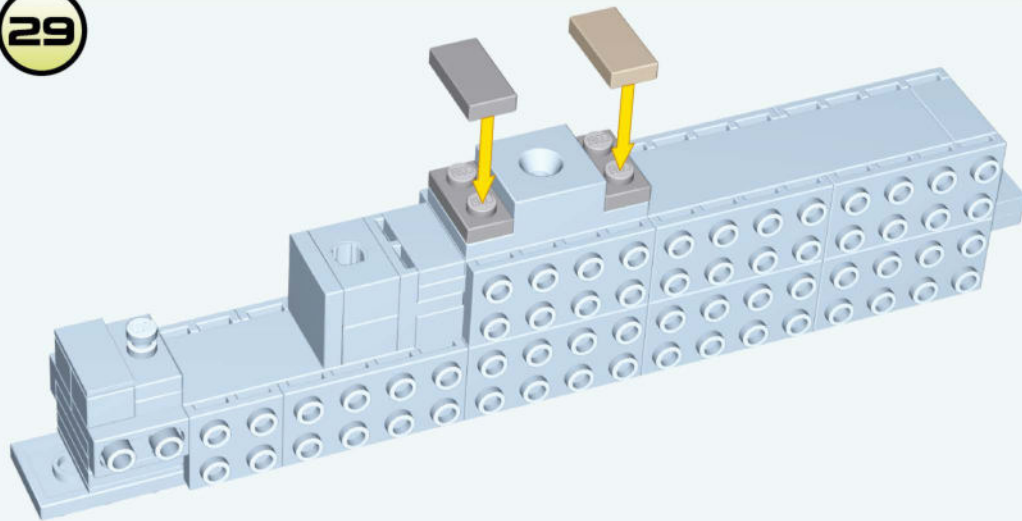

1:1

1:1



x2



x1



x1

30

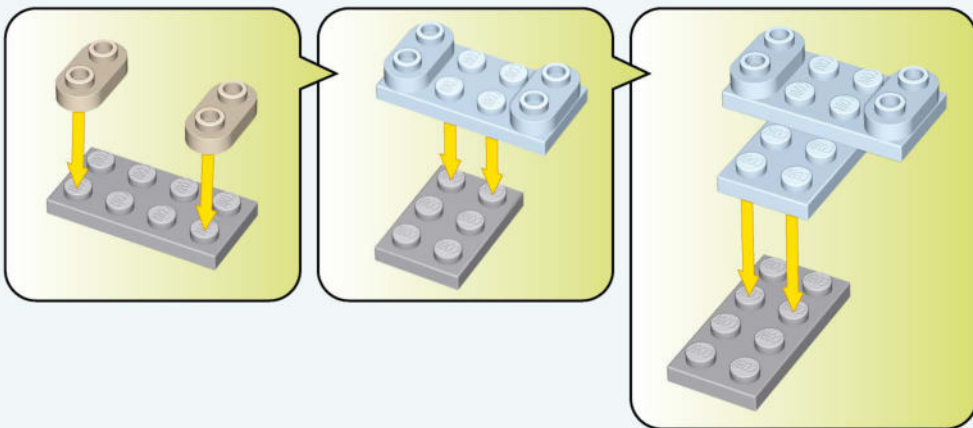

x2



x2



x1

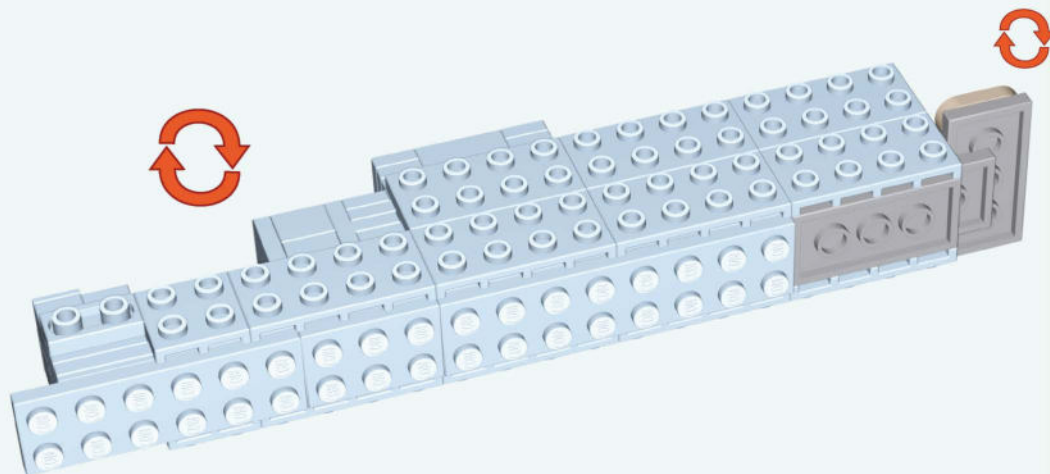

31

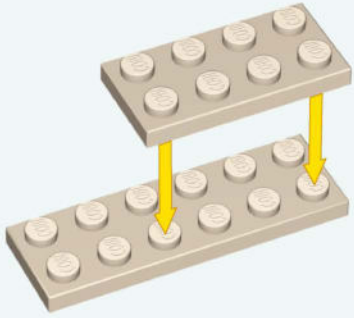

x1



x1

32



x2

33

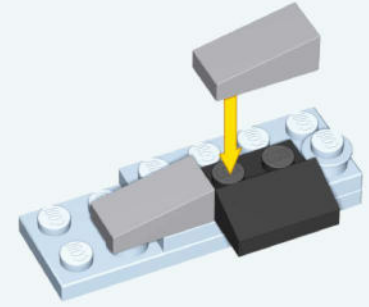

x2



x1

34

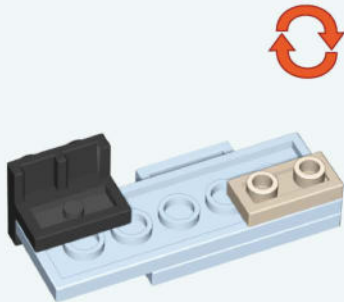

x1



x1

35

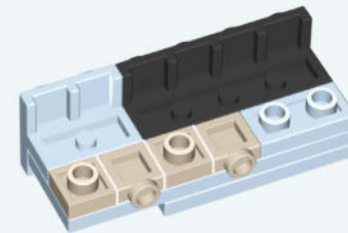

x2



x2



x1

36

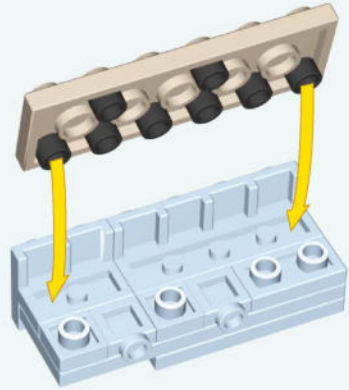
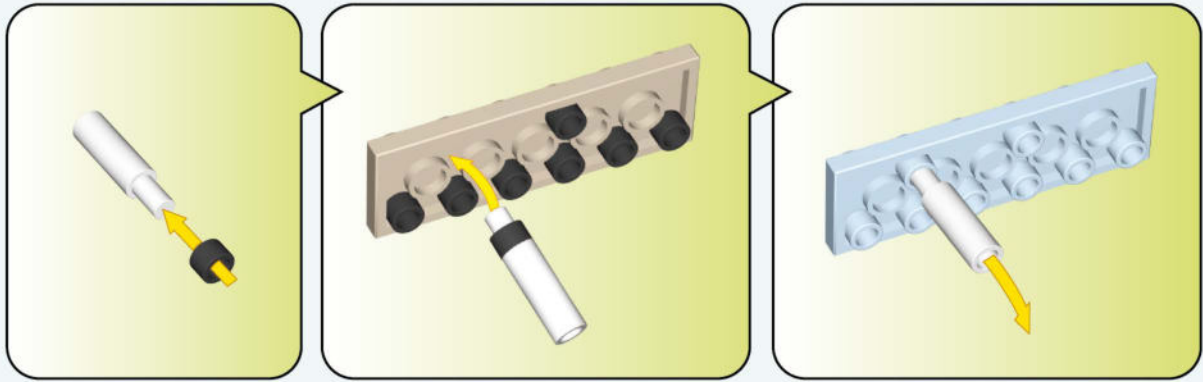

37

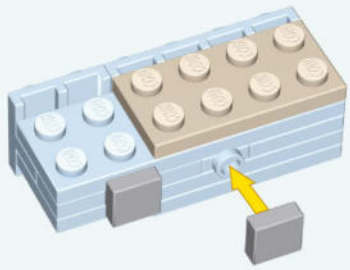

38

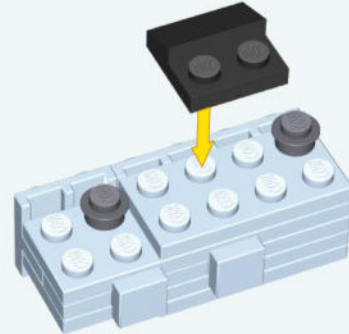

39

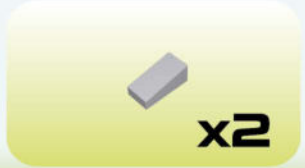
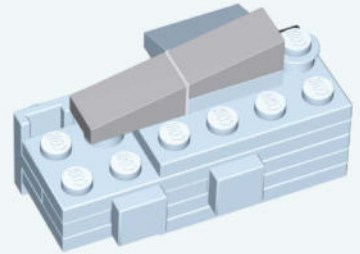

40

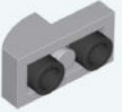
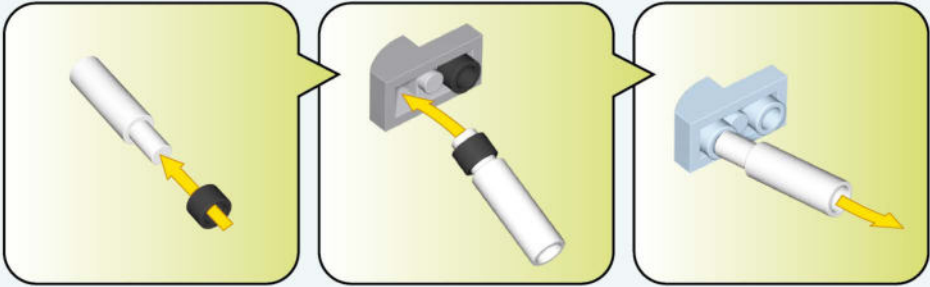

 x1  x2

41

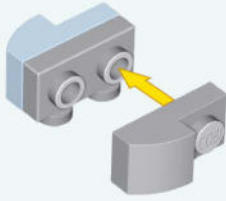

 x1  x1

42

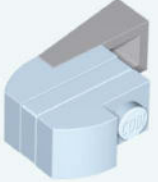

 x1

43

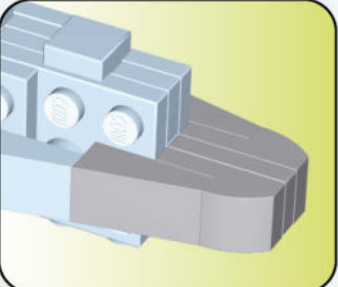
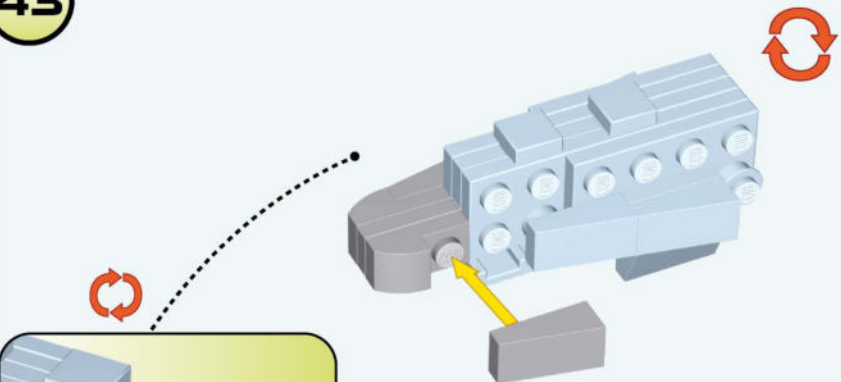

 x1

44

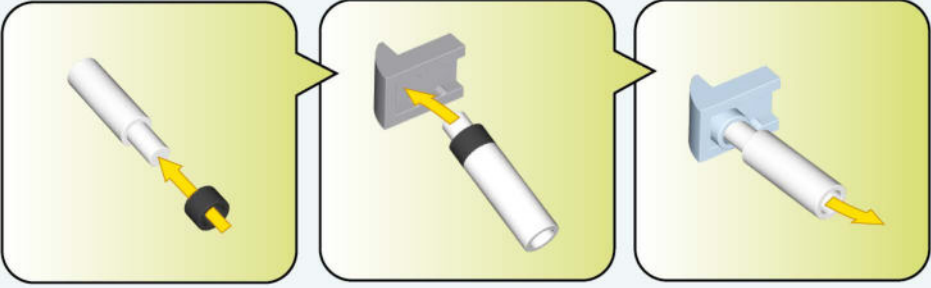

 x1  x1

45

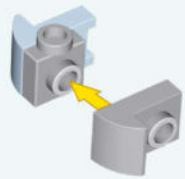

x1



x1

46



E



x1

47

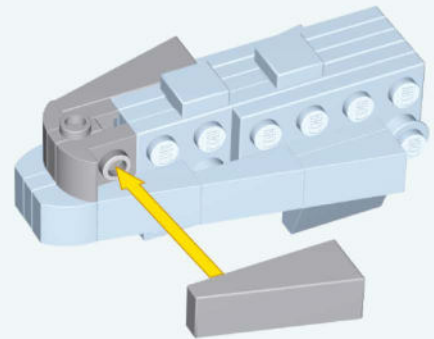

E



x1

48

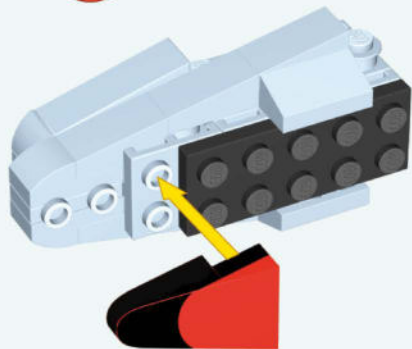

x1



x1

49

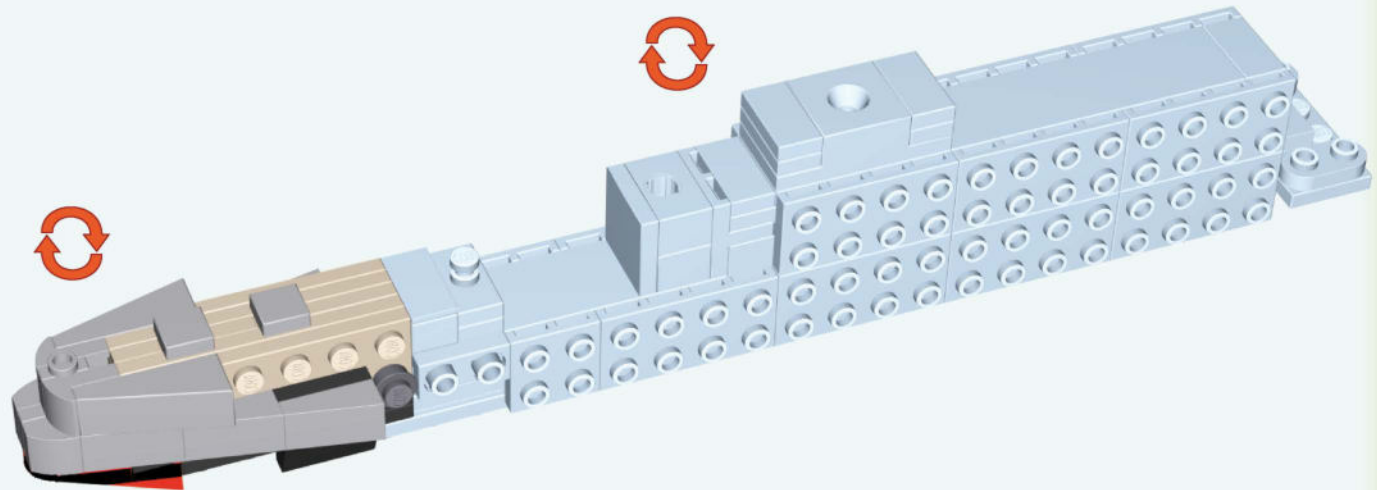

50

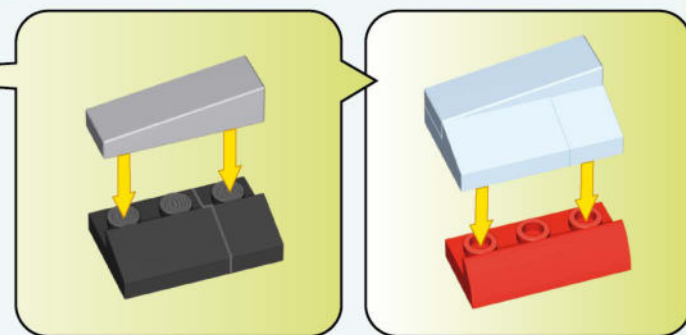
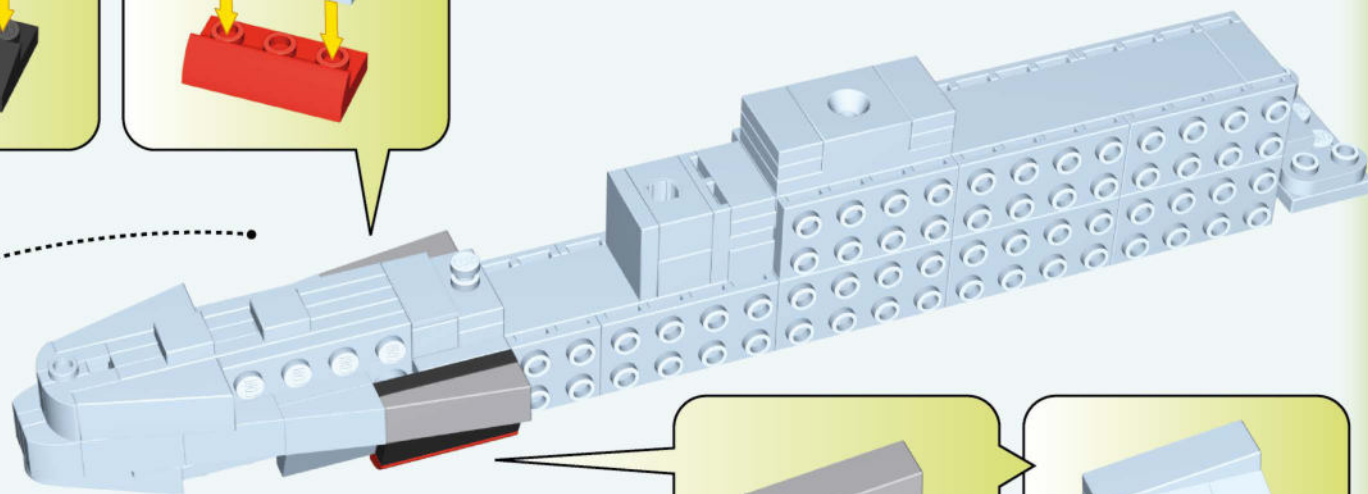
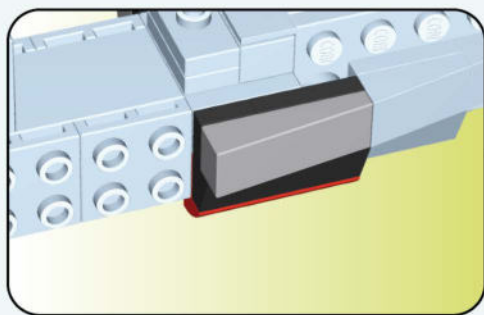
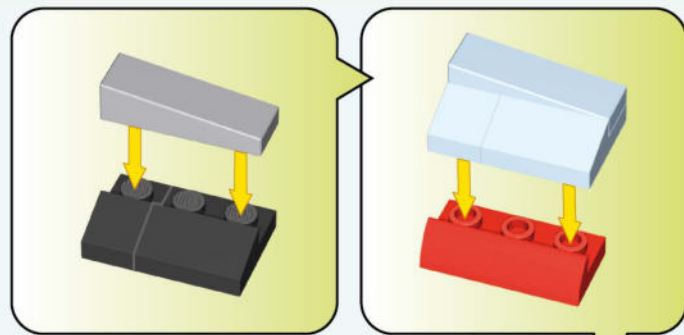

x2

x2

[ⓓ] x2

x2

51

x2

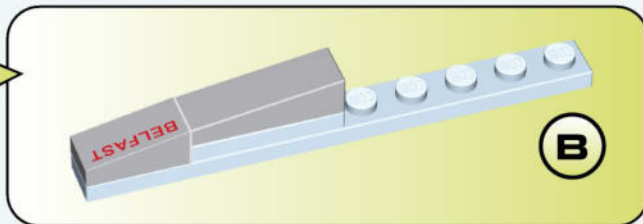
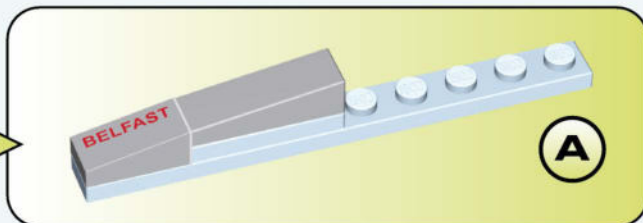

x2

x2

x1

x1

[ⓓ] x2

52

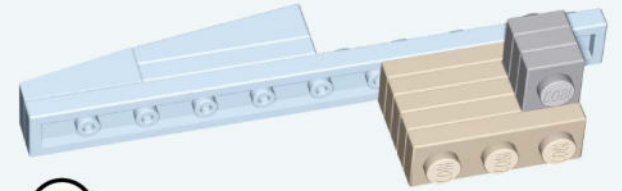
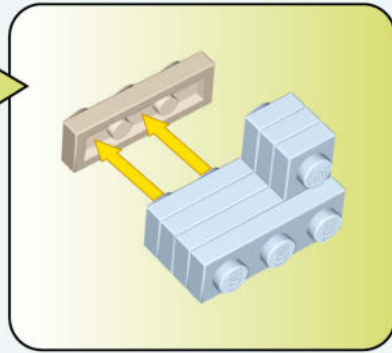
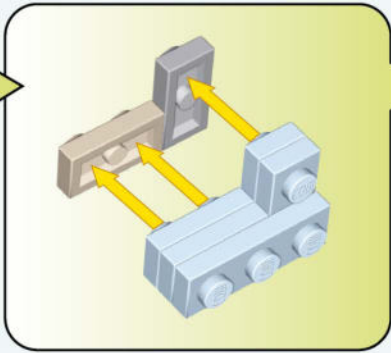
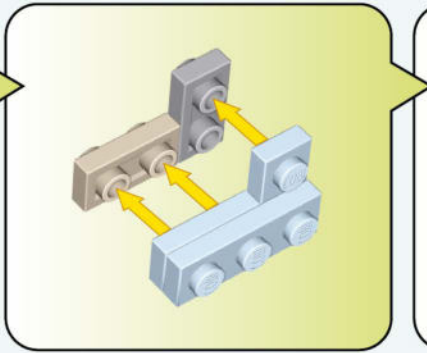
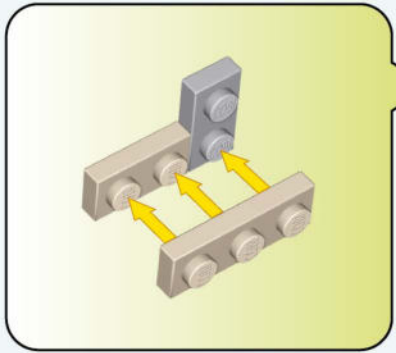

B



x2



x2



x2



x1



x1

53

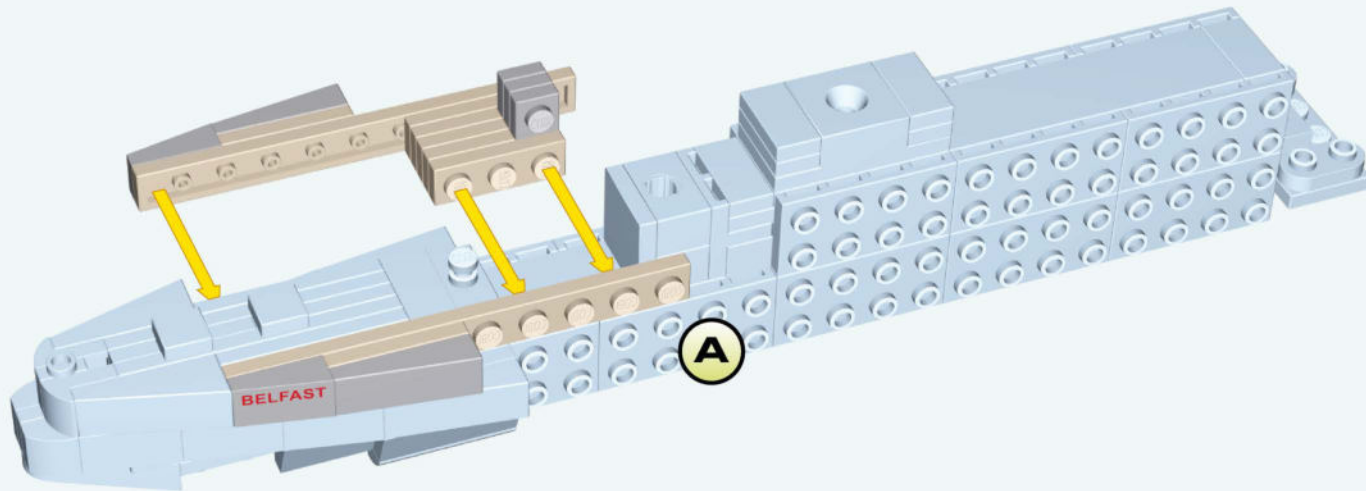



54

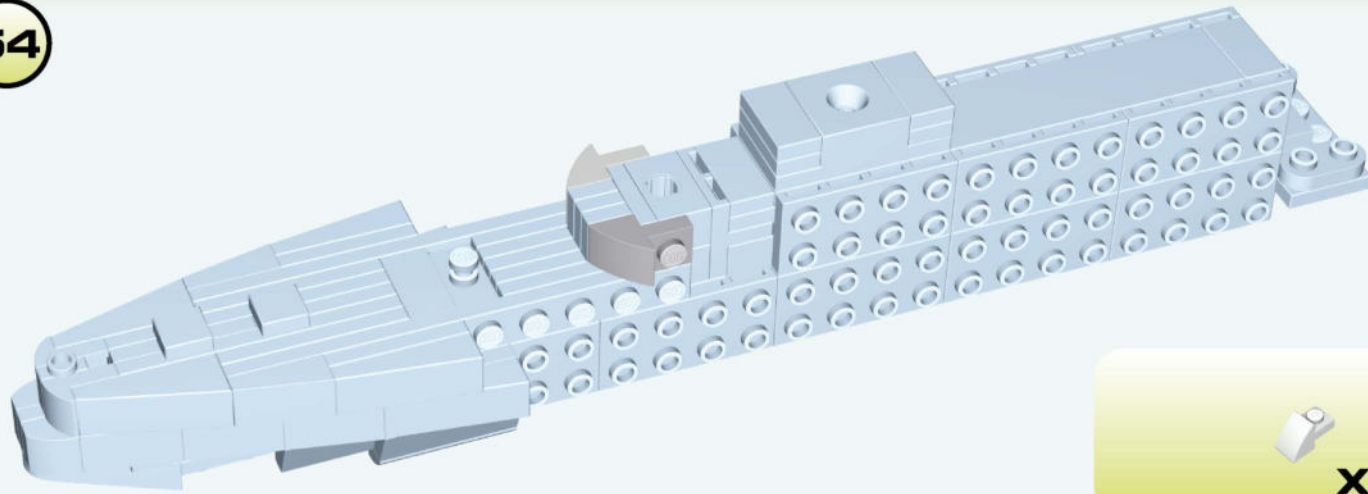

55

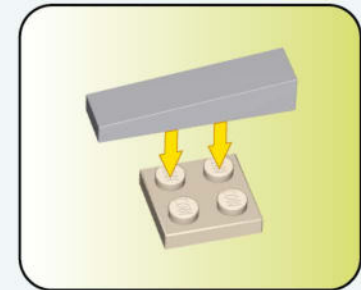
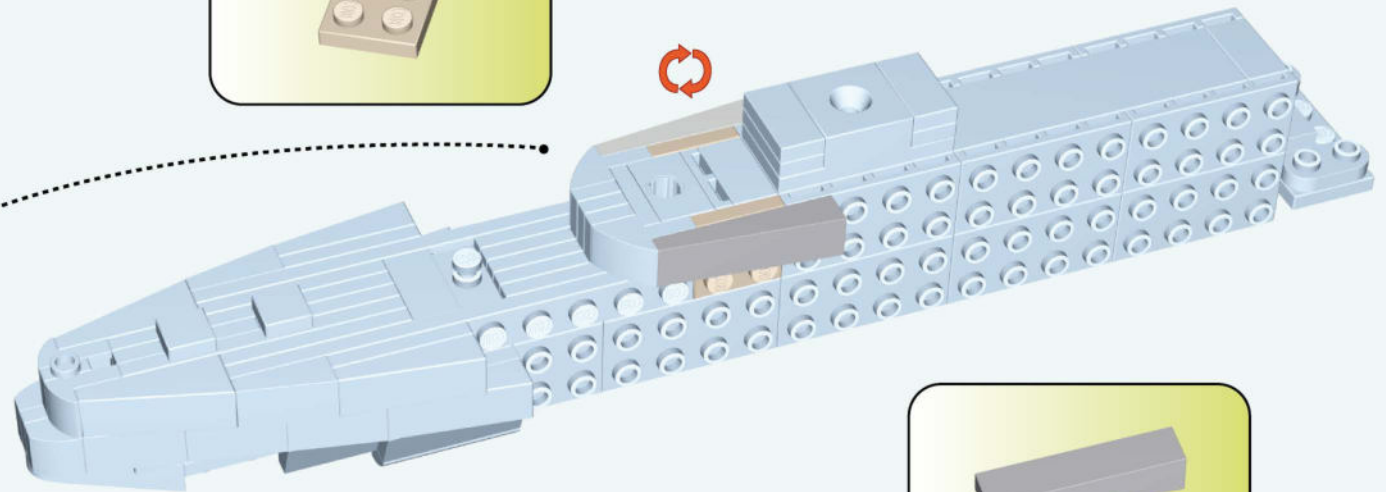
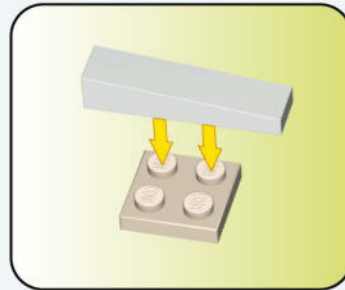
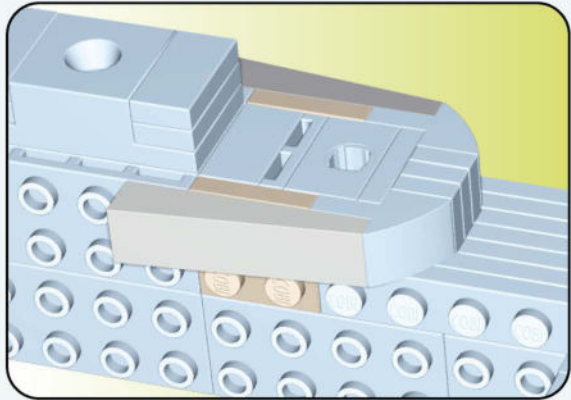

56

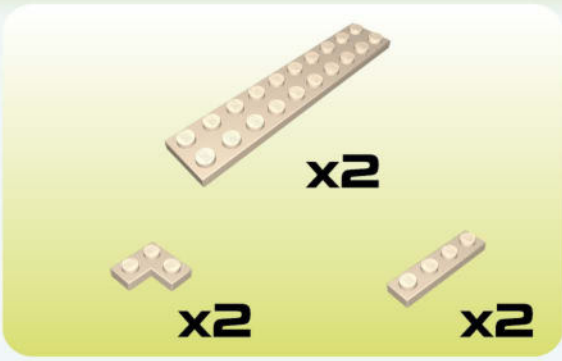

57

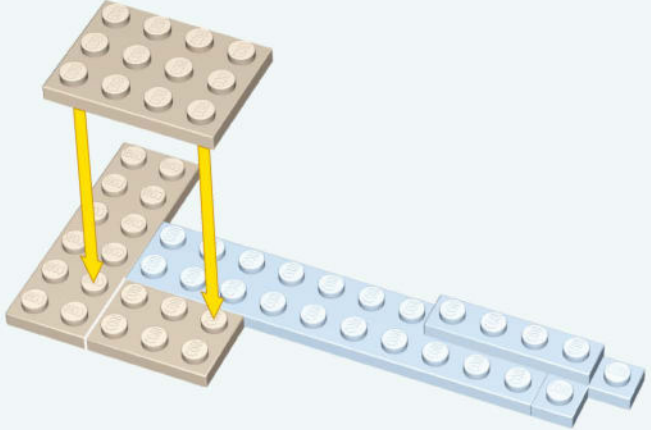
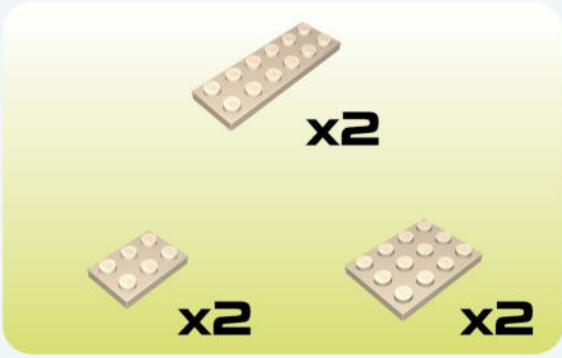
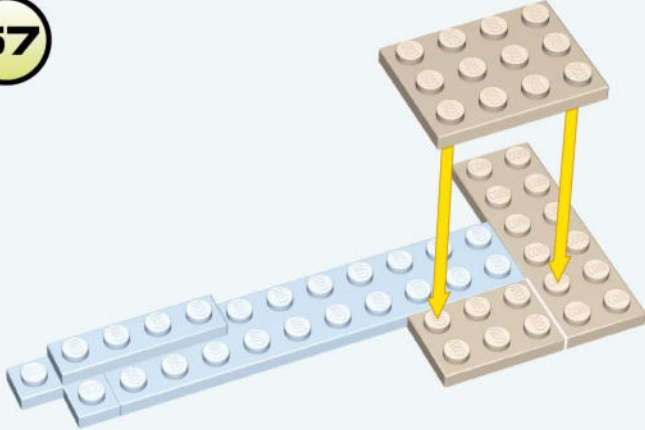

58

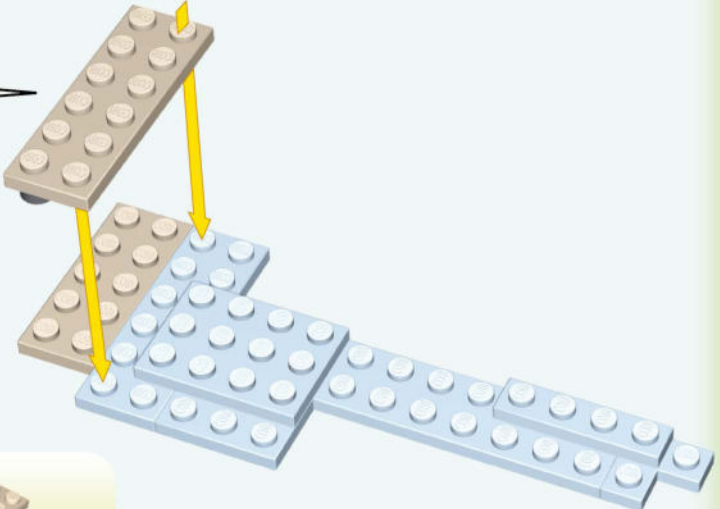
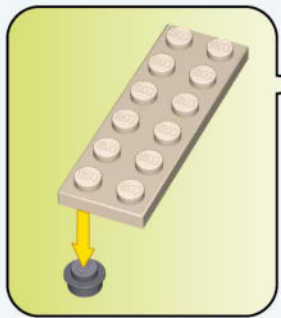
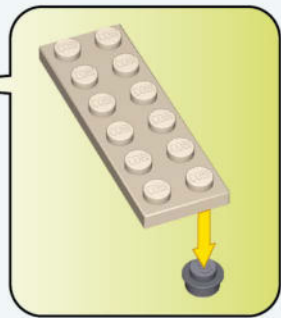
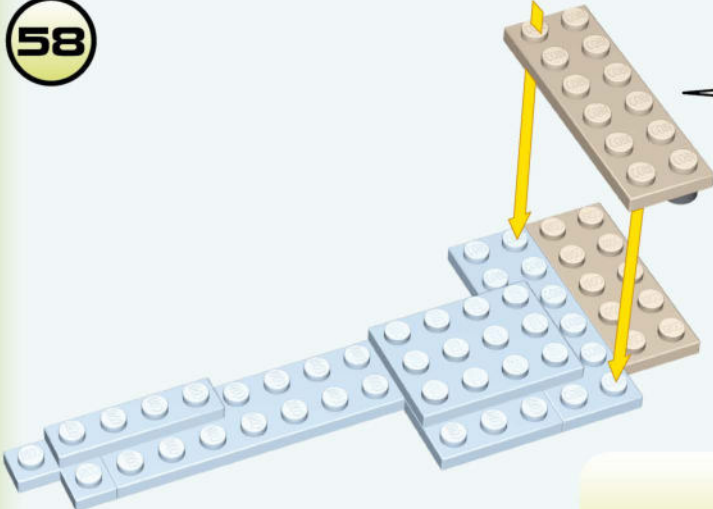

59

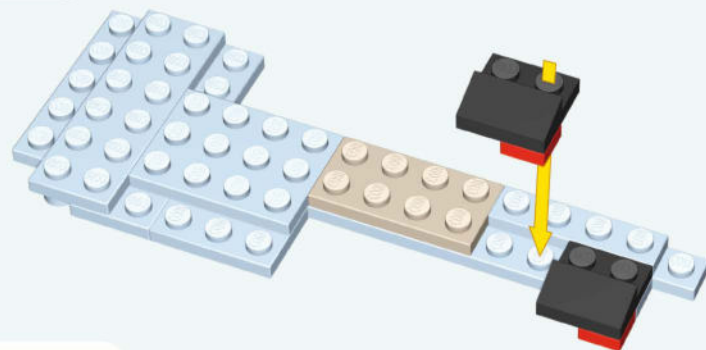
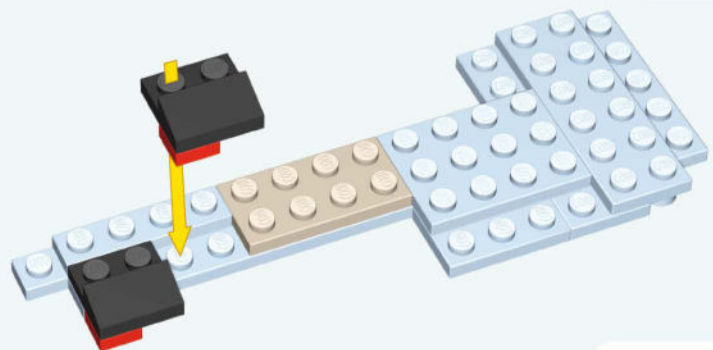
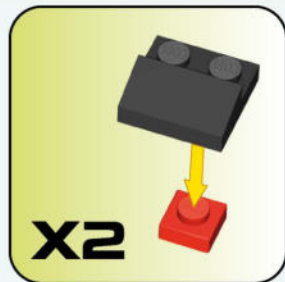
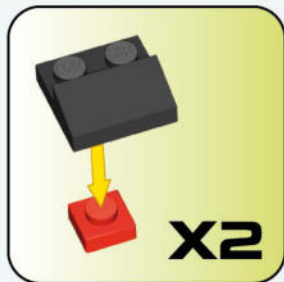

60

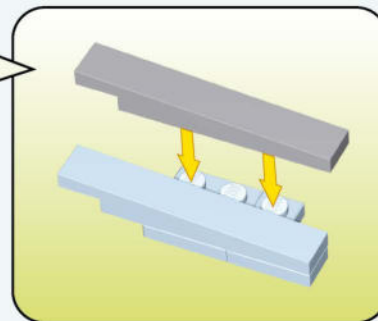
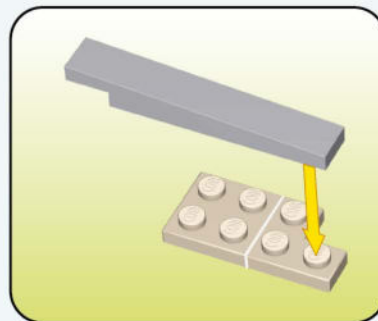
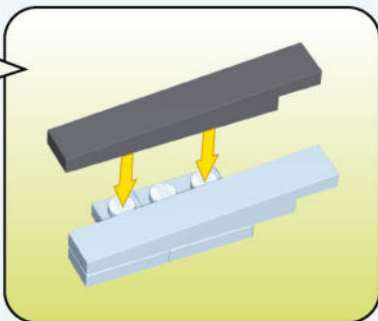
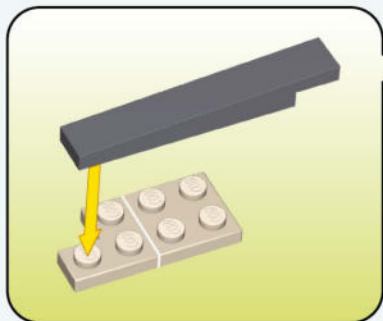

61

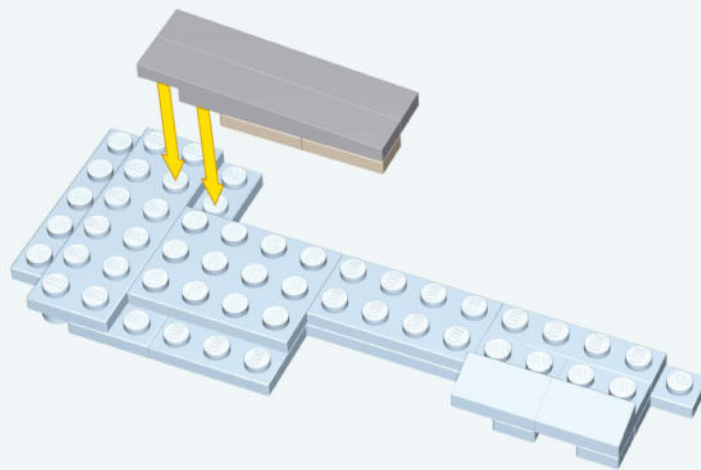
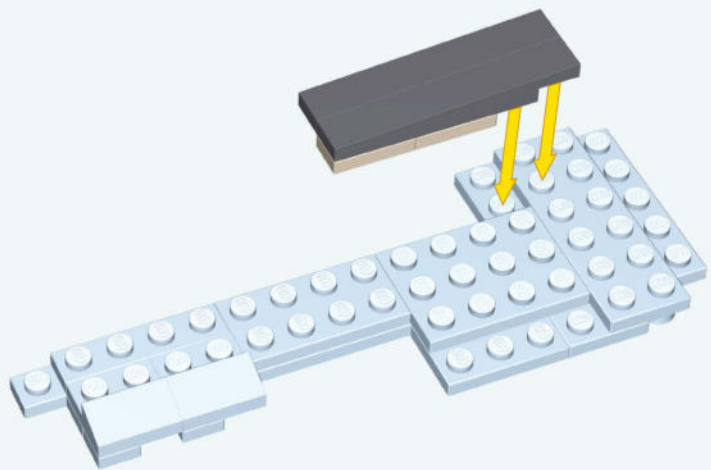

62

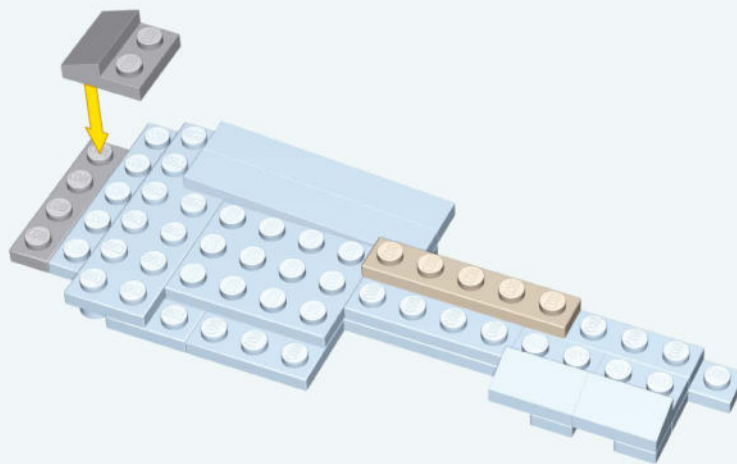

x2



x2



x1



x1

63

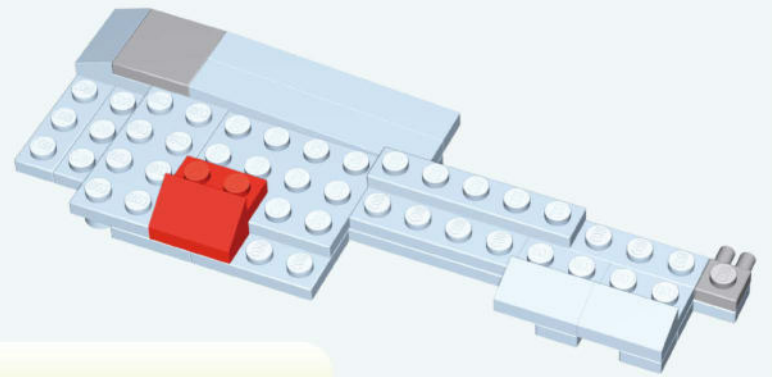
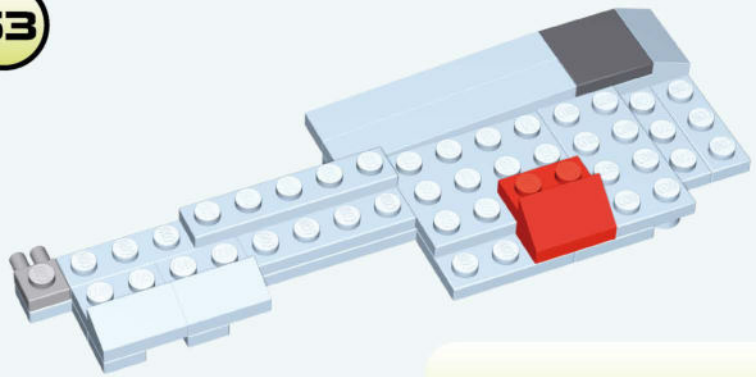

64

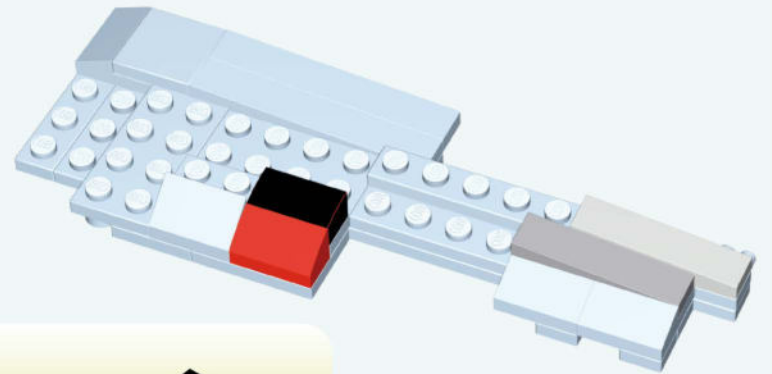
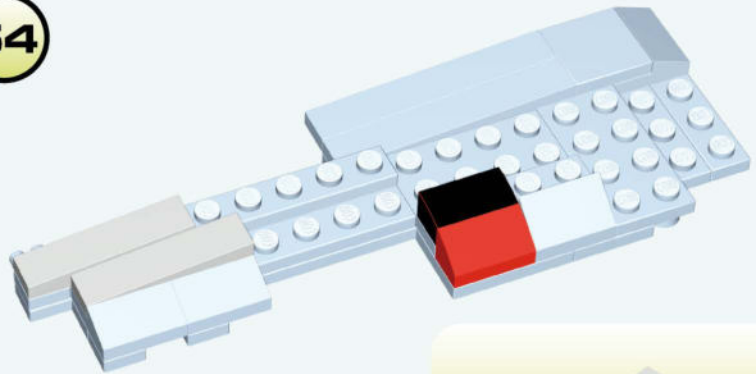

65

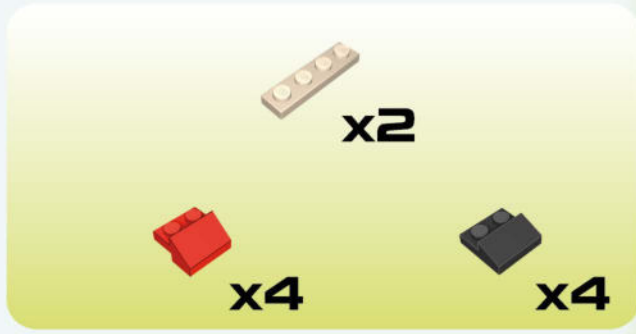
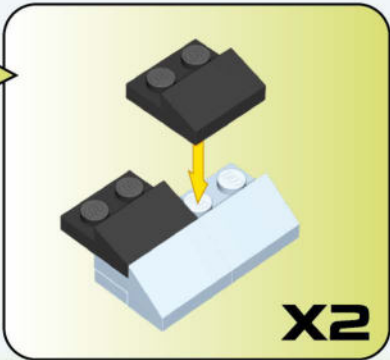
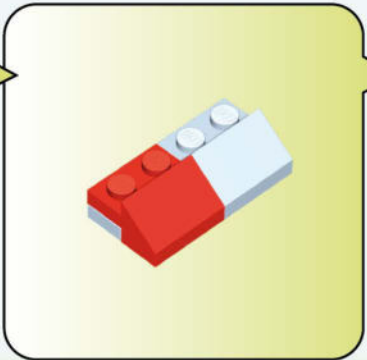
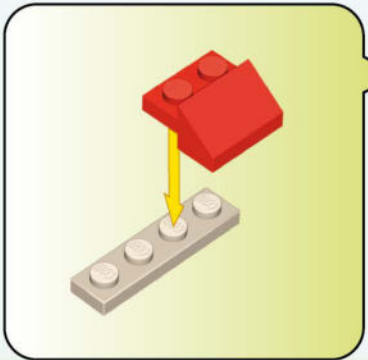

66

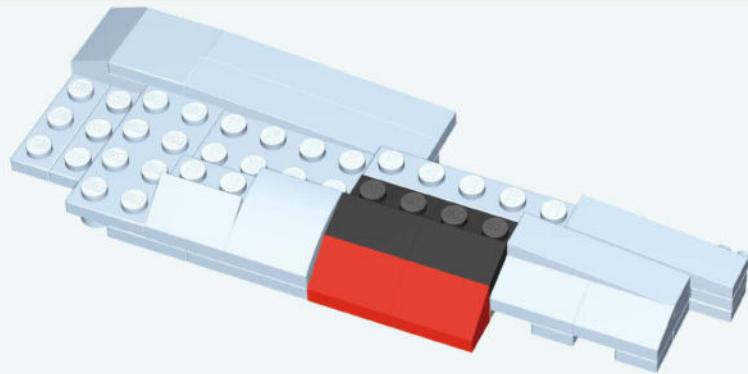
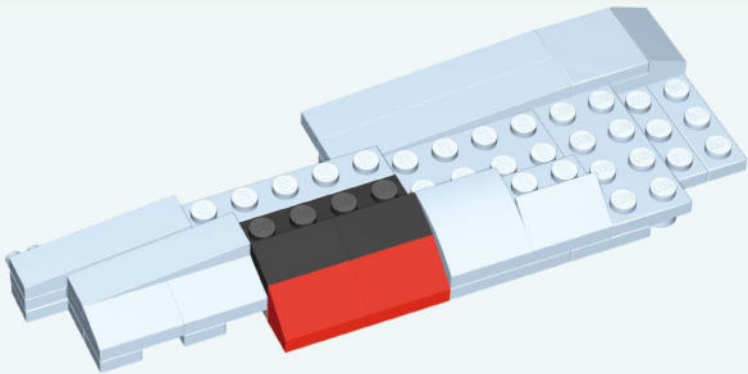

67

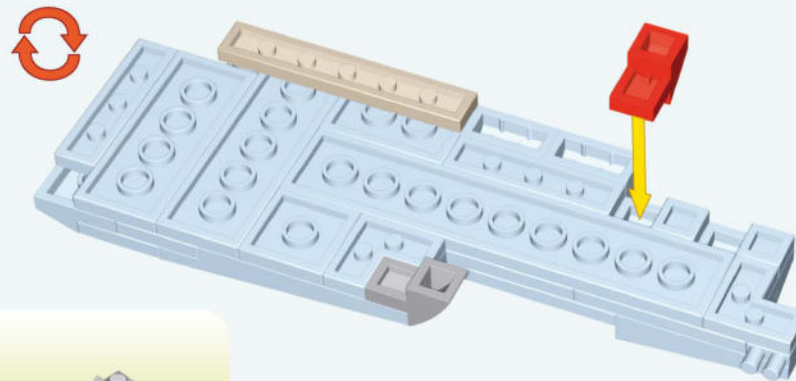
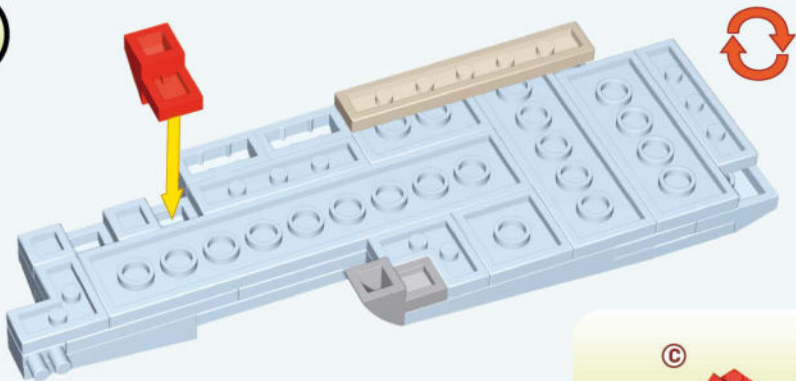

 x2
  x2
  x2

68

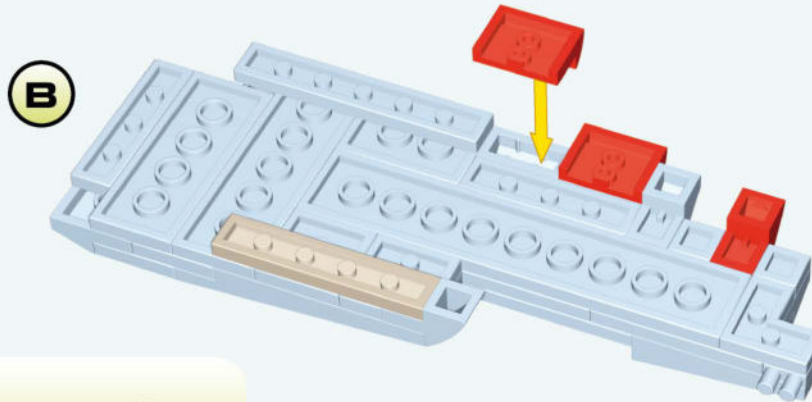
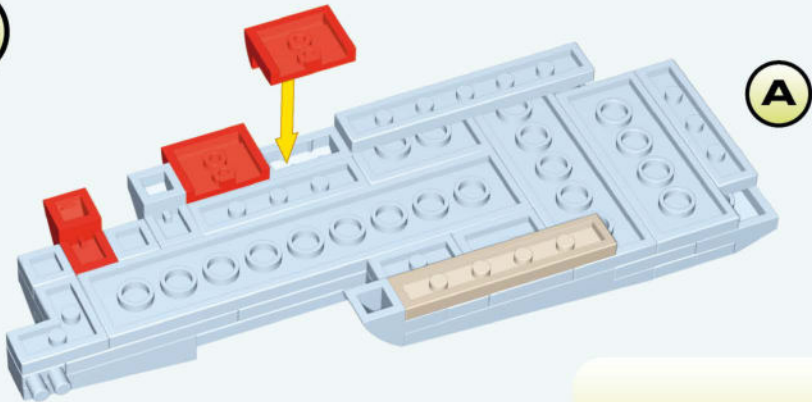

 x4
  x2
  x2

69

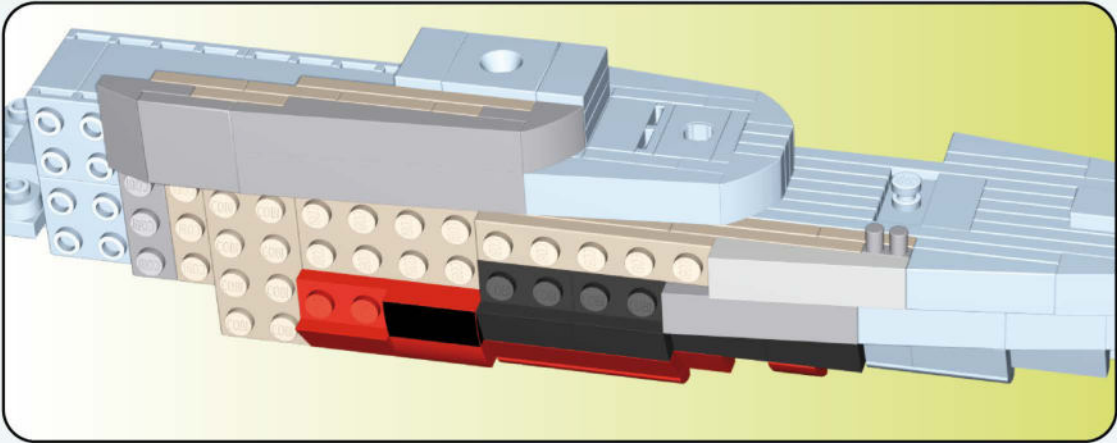

B

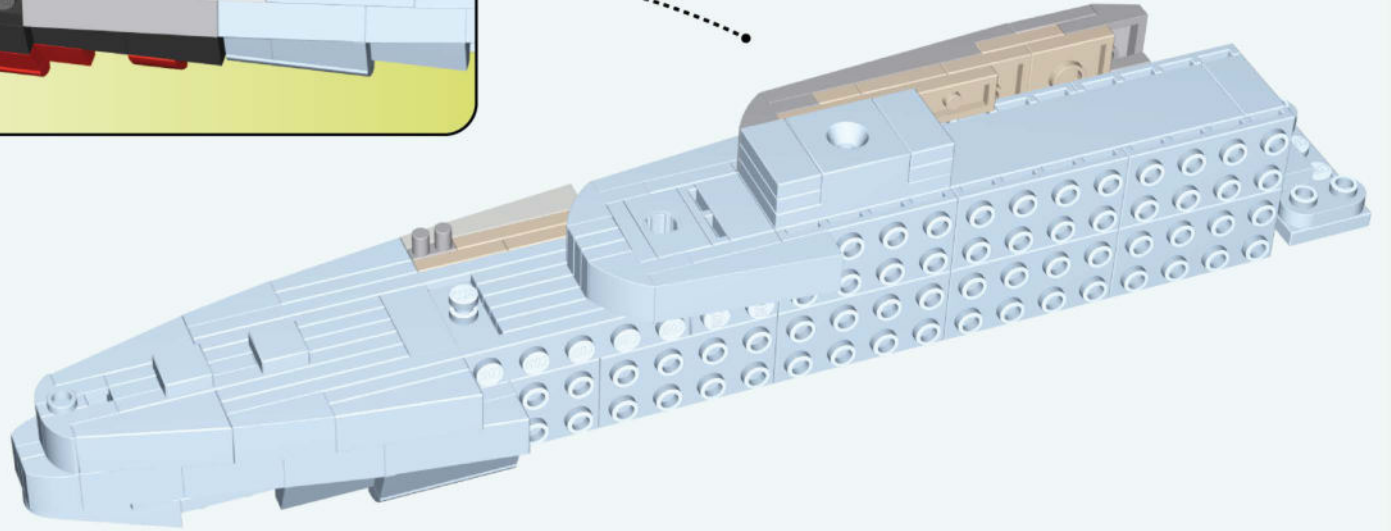

70

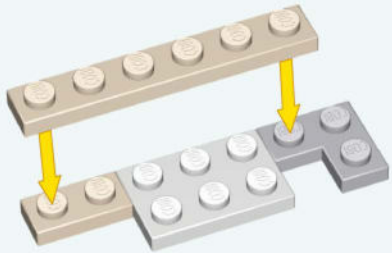

x1



x1



x1



x1

71



x1



x1



x1

72

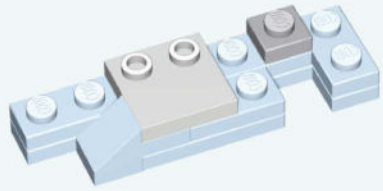

x1



x1

73

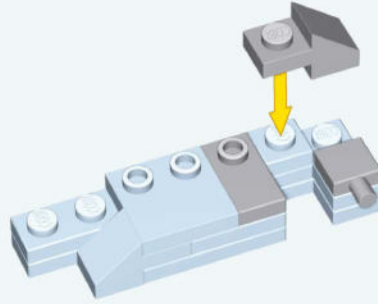

x1



x1



x1

74

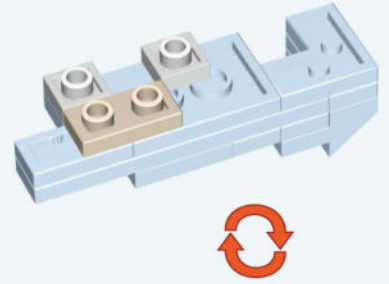

x2



x1

75

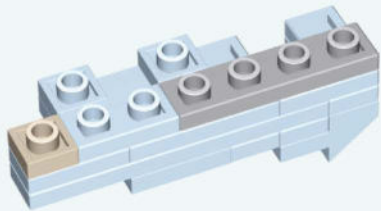

x1



x1

76

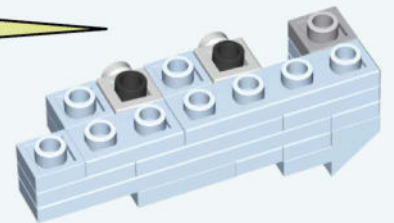
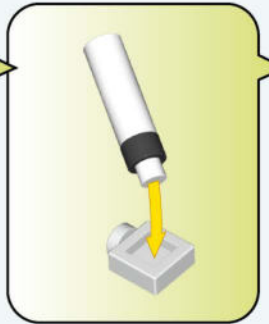
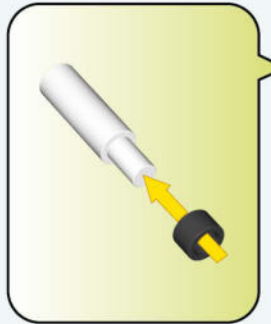

x2



x2



x1

77

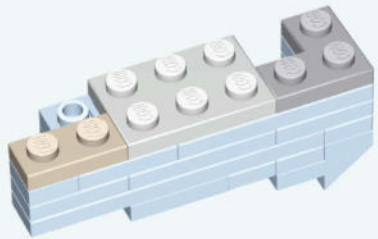

x1



x1



x1

78

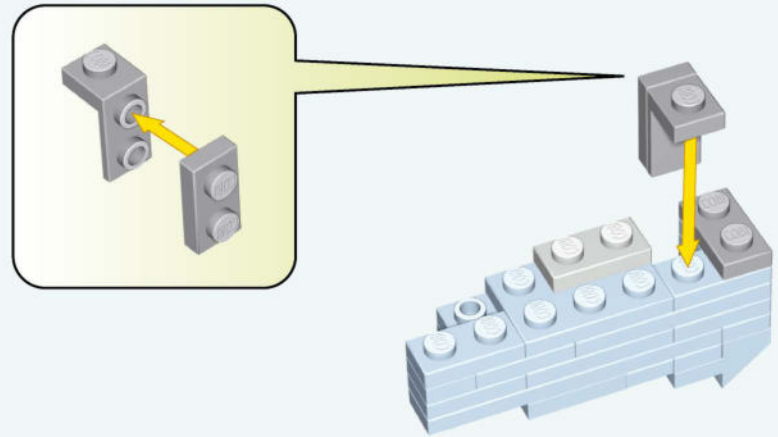

x1



x2



x1

79

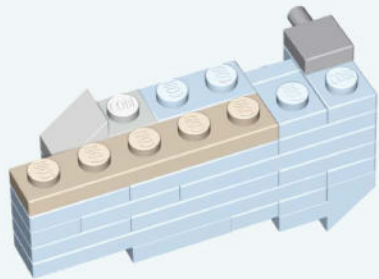

x1



x1



x1

80

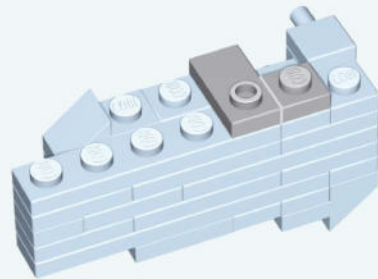

x1



x1

81

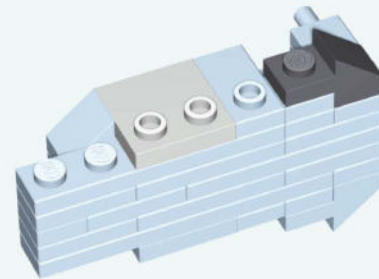

x1



x1

82

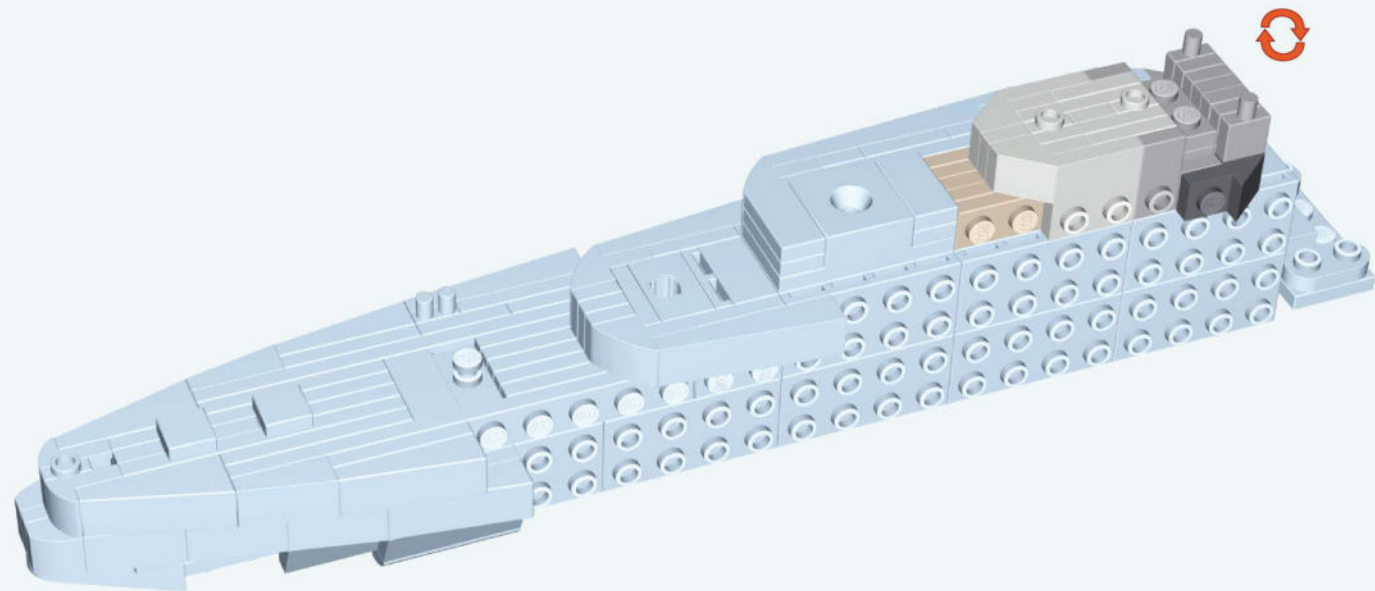

83

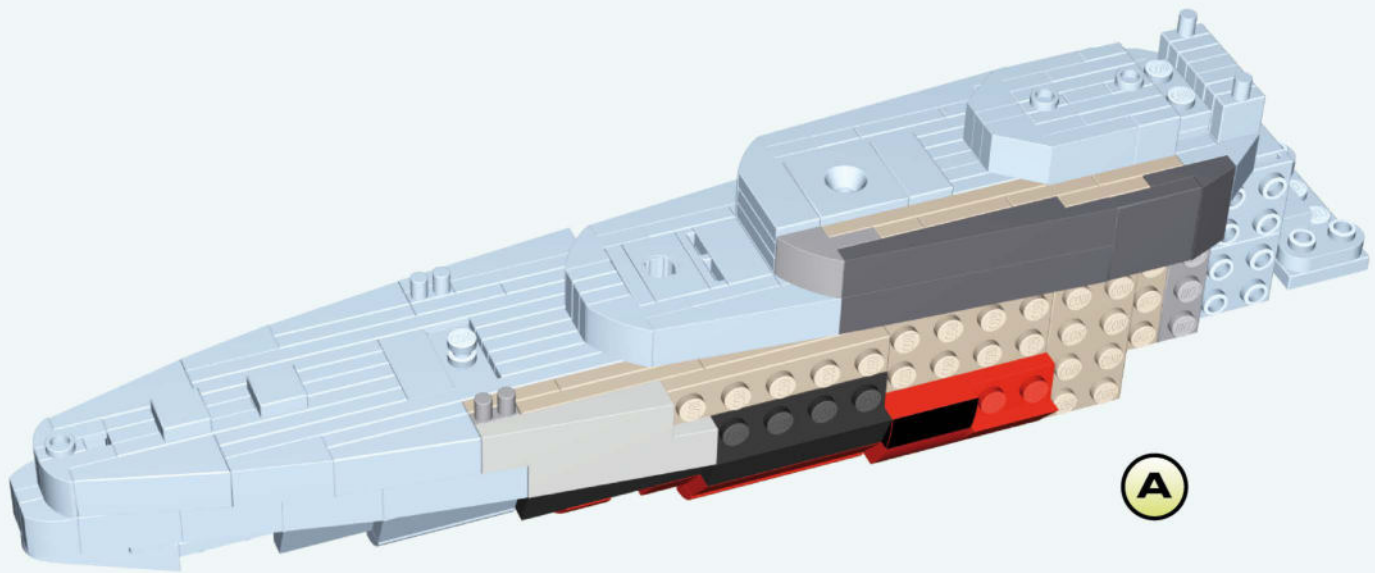

84

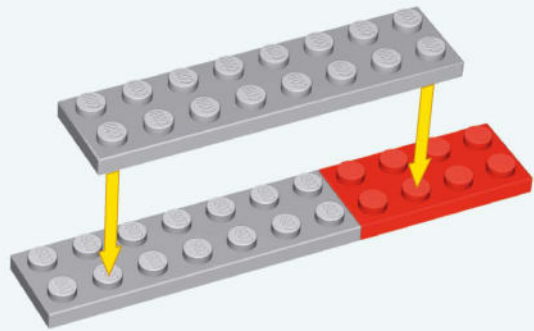

85

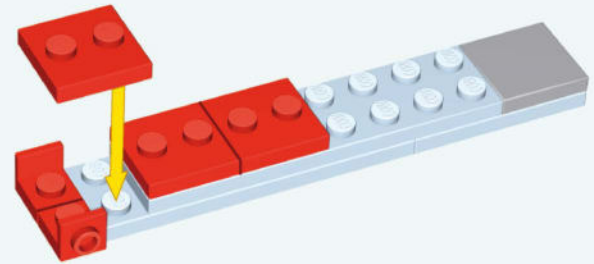

86

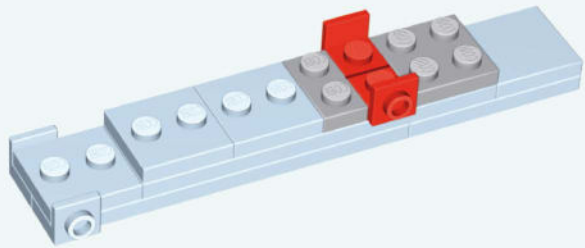

87

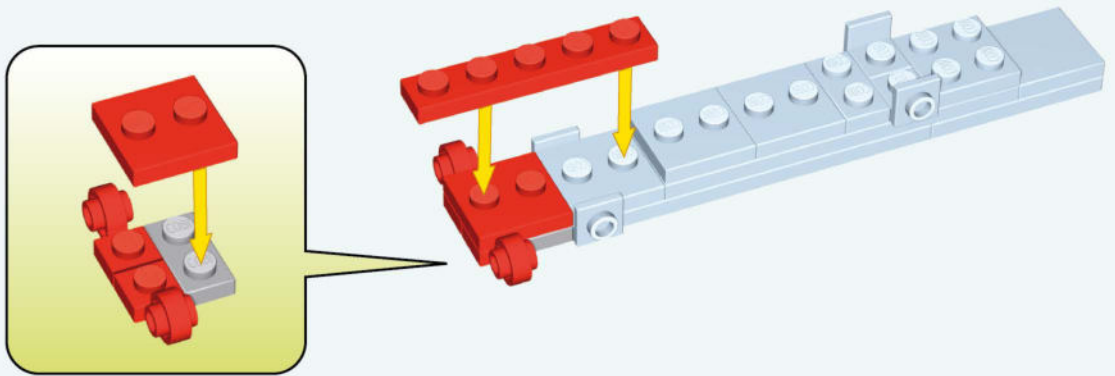

88

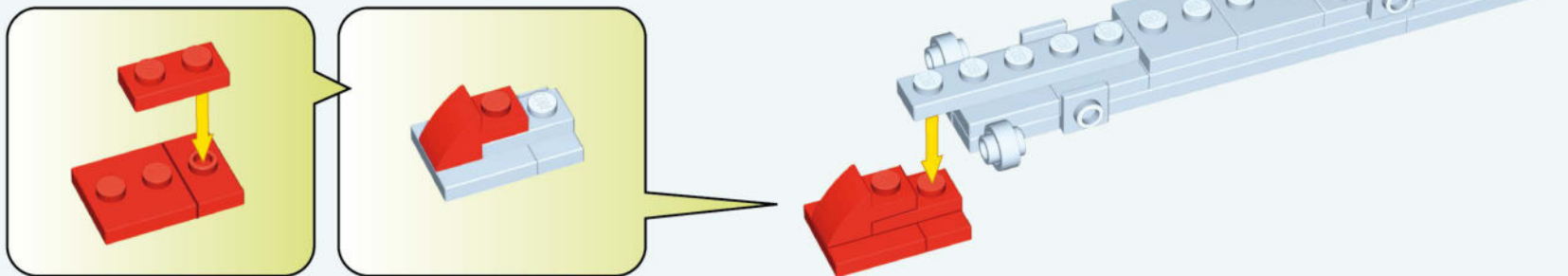

89

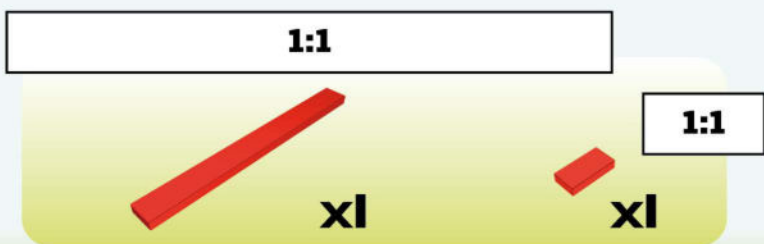
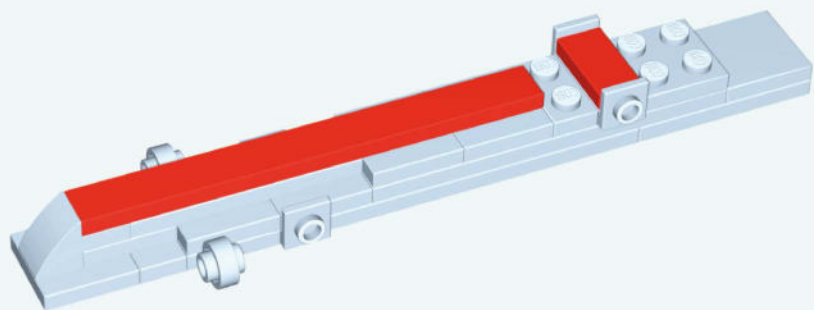

90

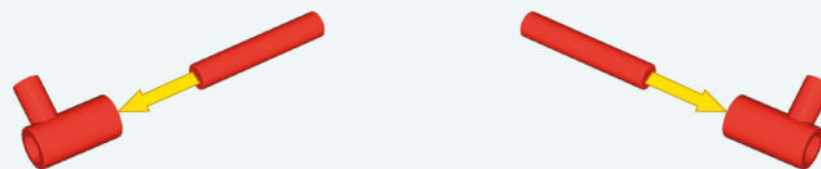

91

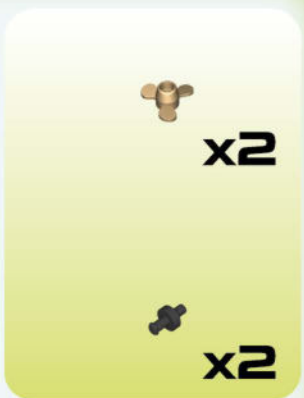

92

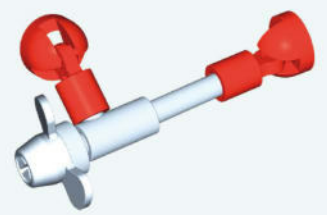

A

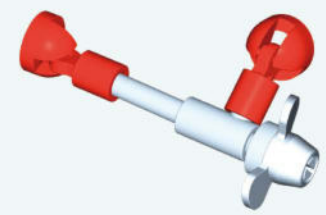
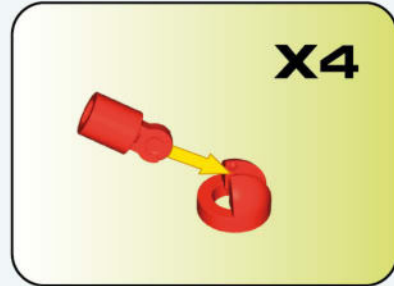

B

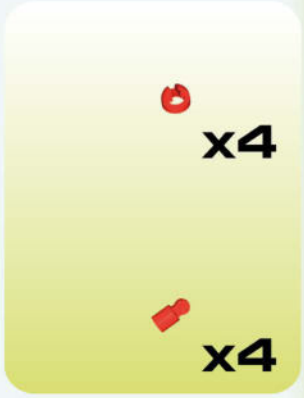

93

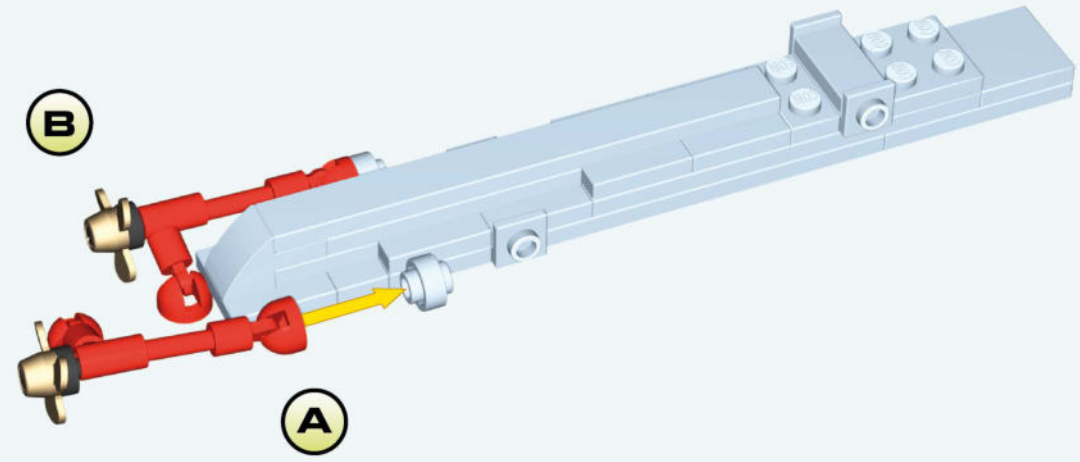

B

A

94

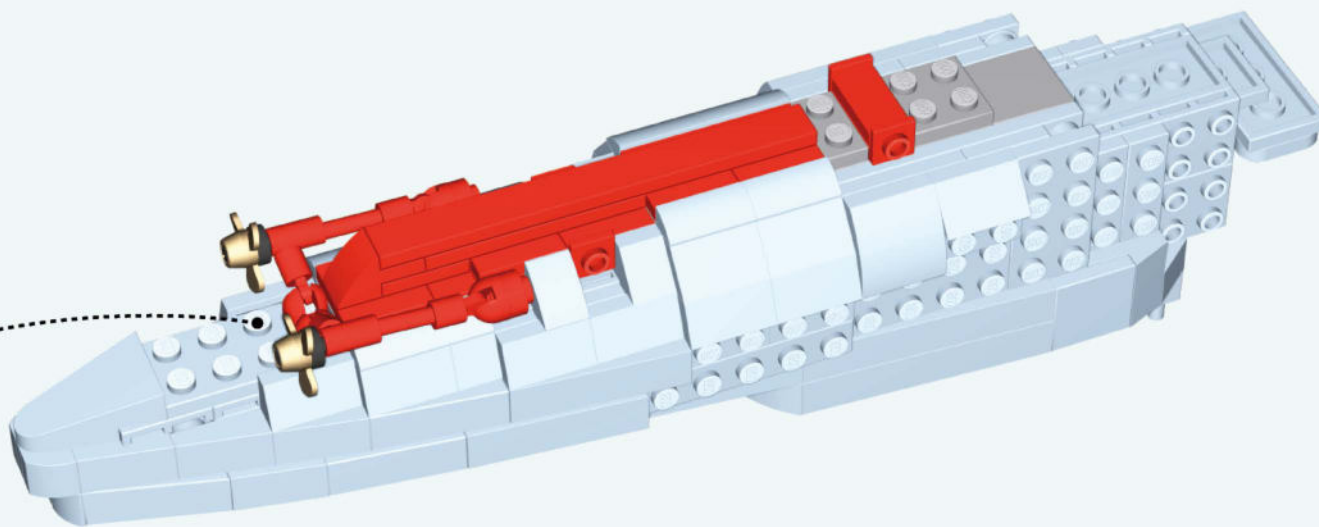
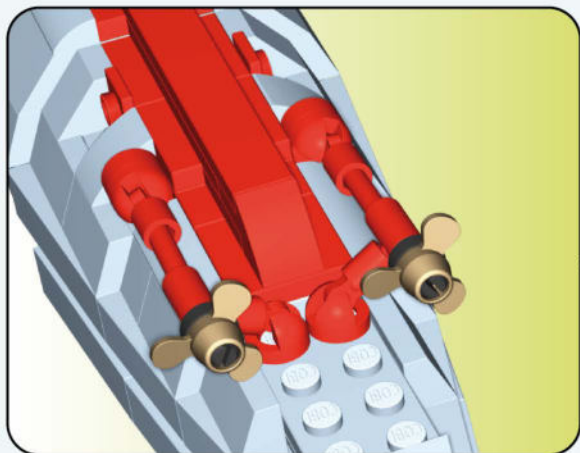

95

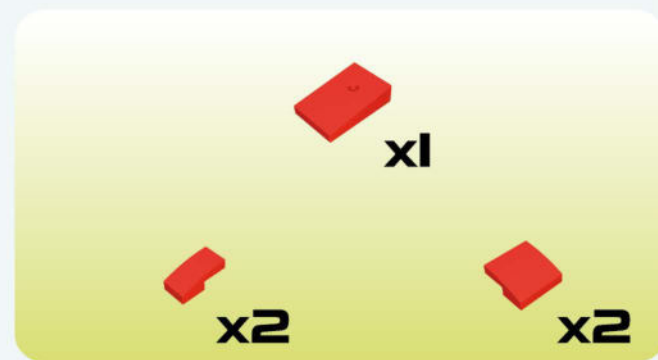
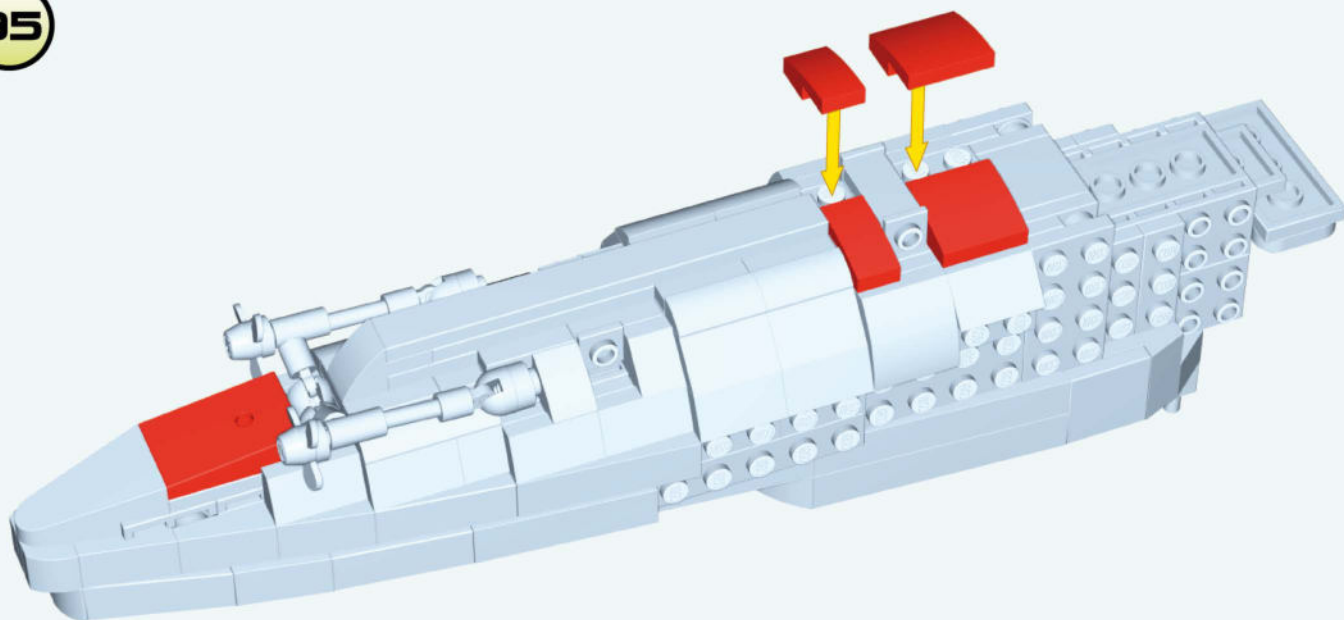

96

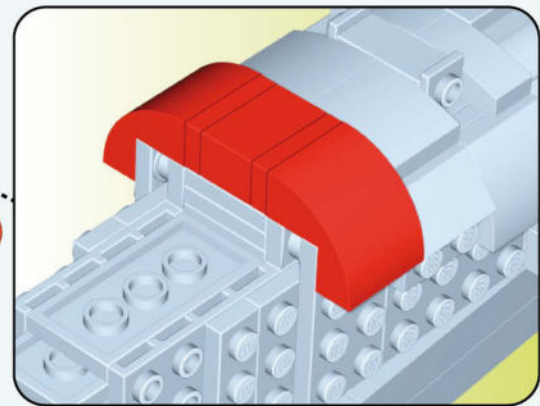
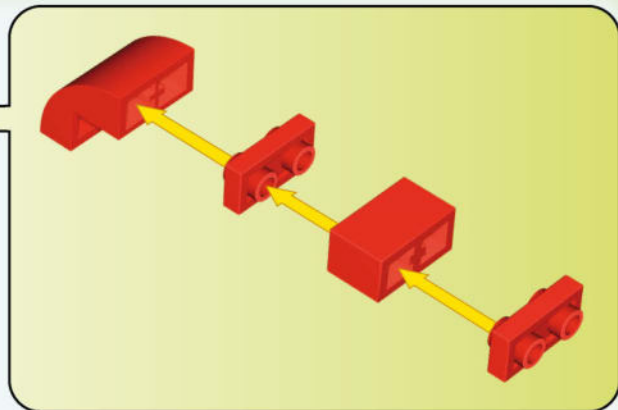
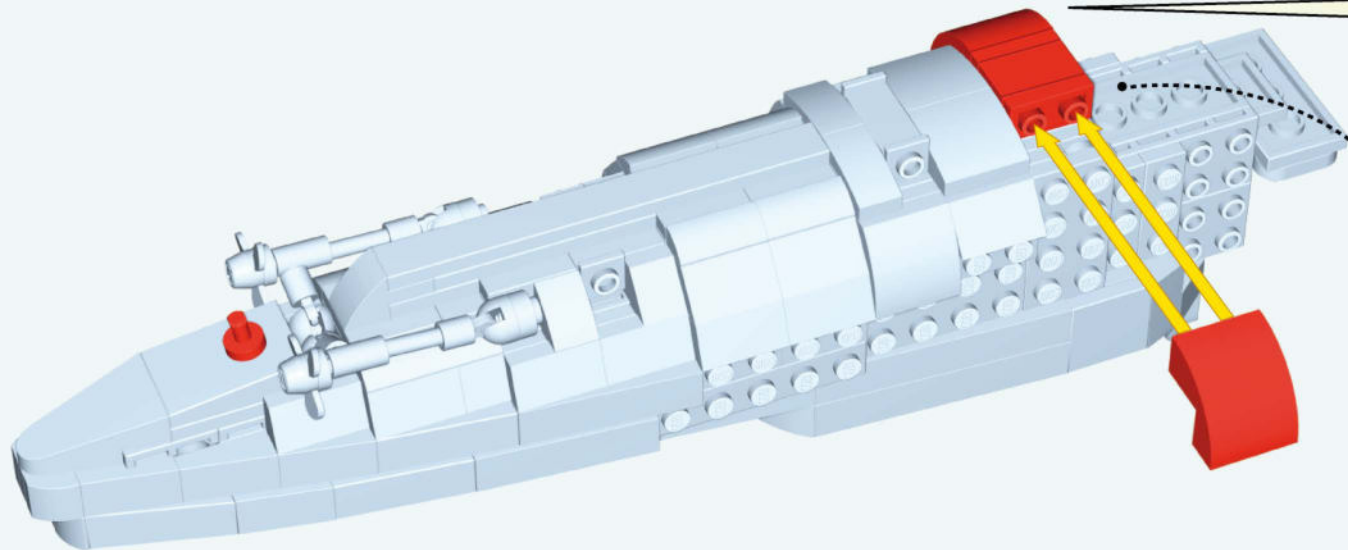

x1



x2



x2



x1

97

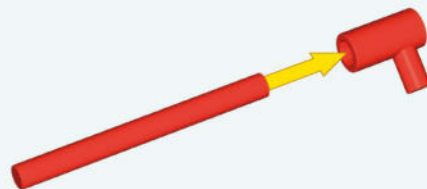
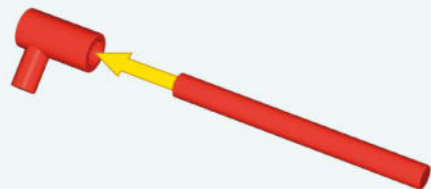

Ⓒ



x2



x2

98

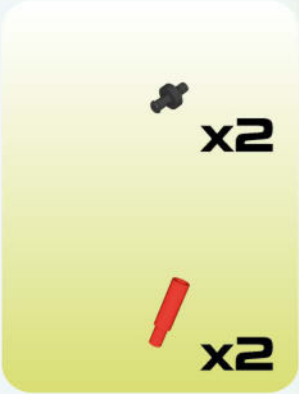
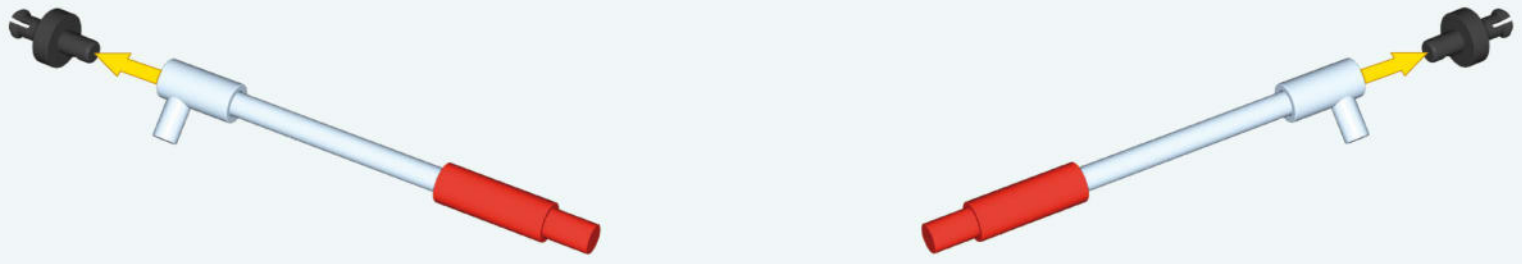

99

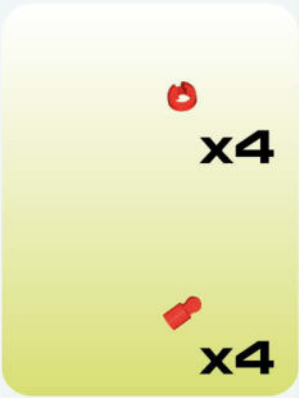
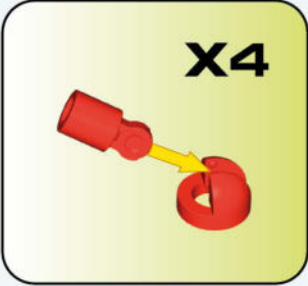
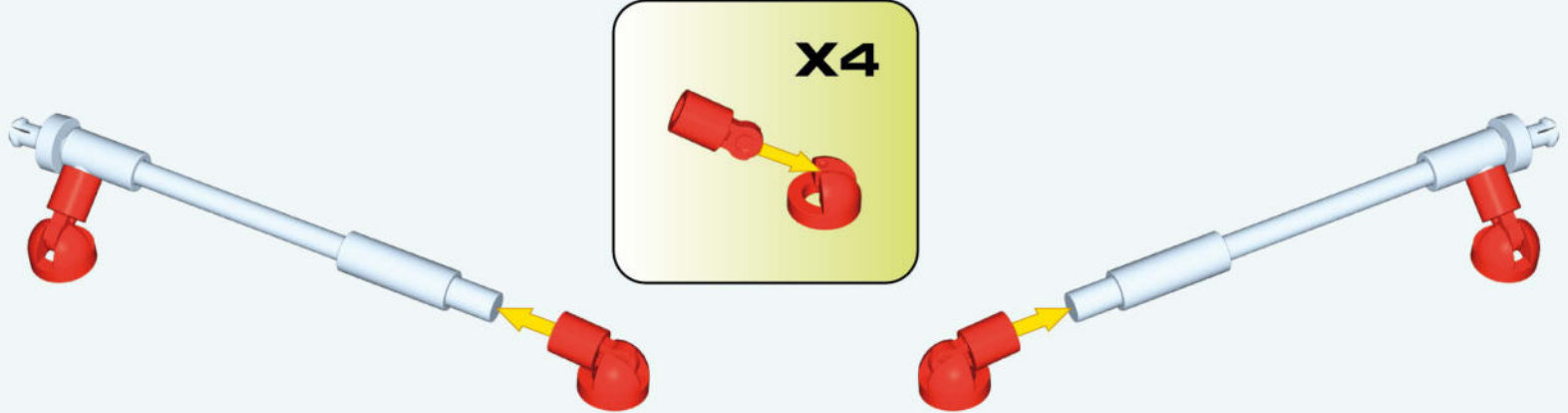

100

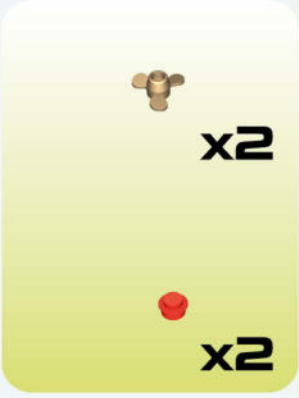
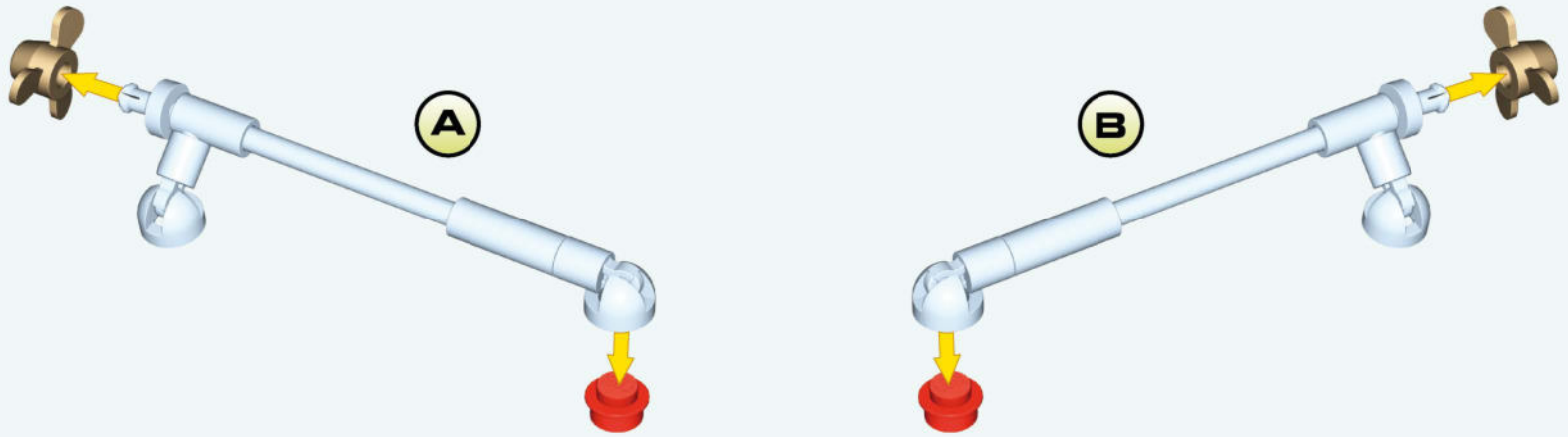

101

B

A

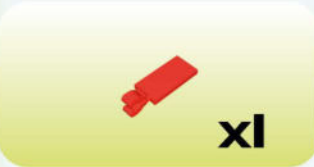
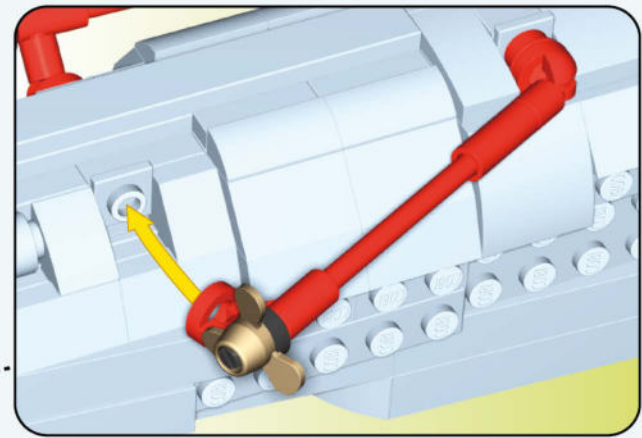
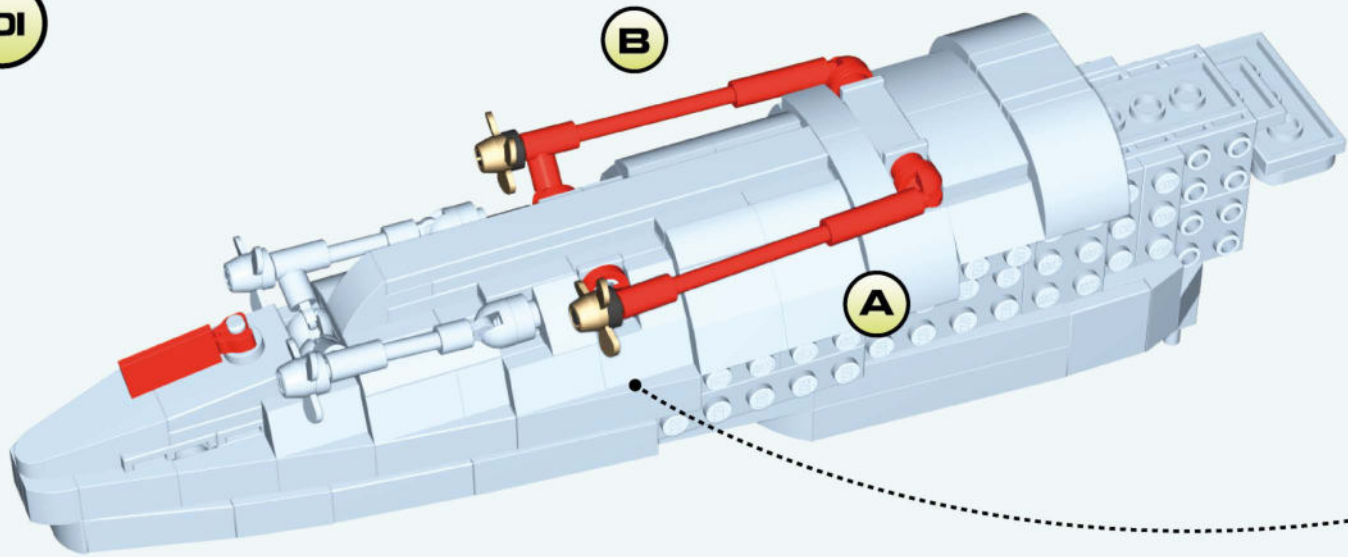

102

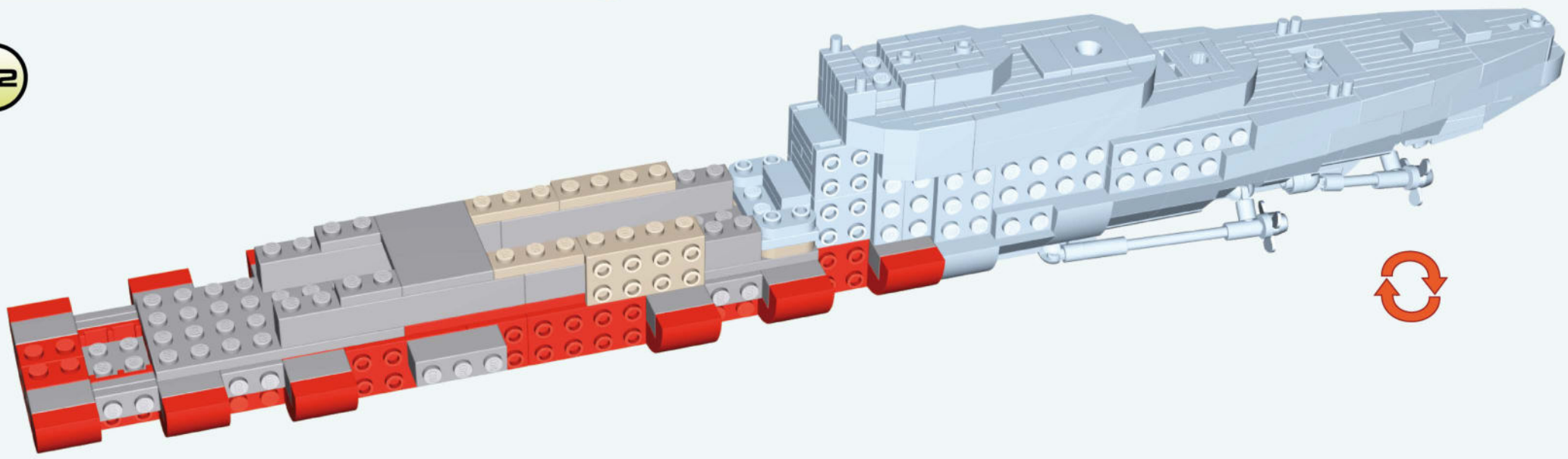

103



x2

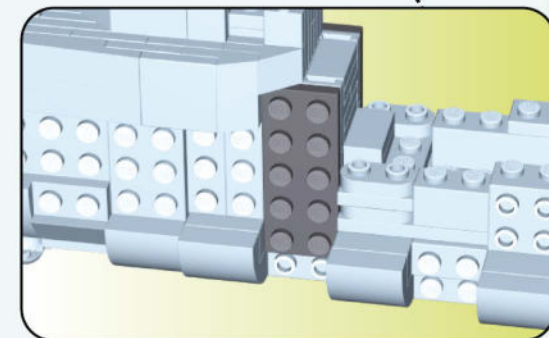
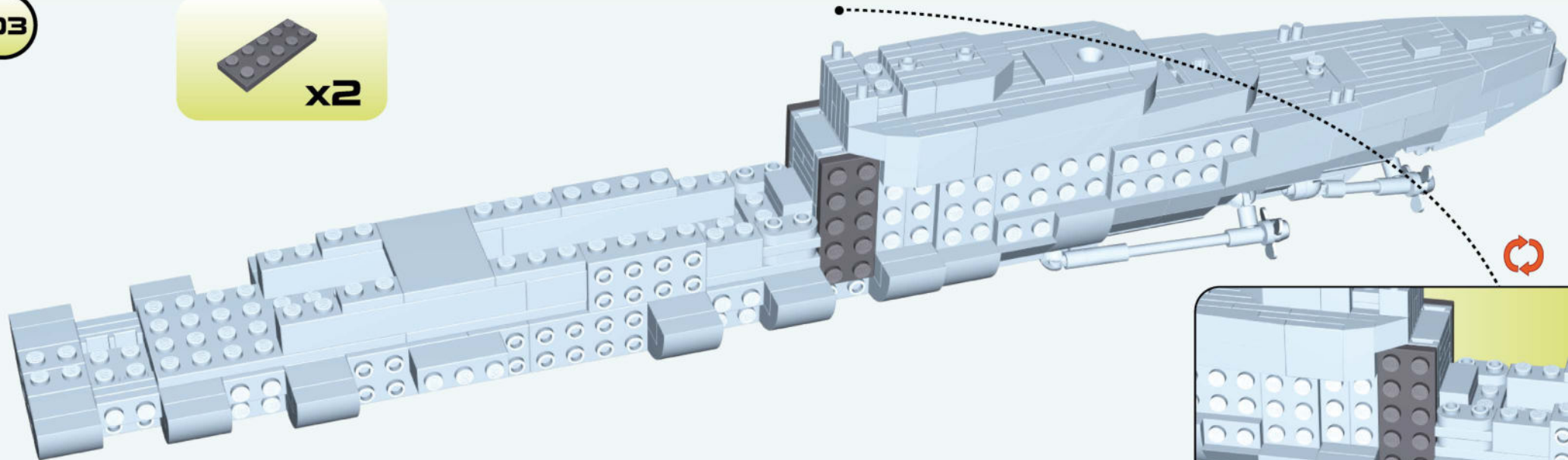

104



x2



x2

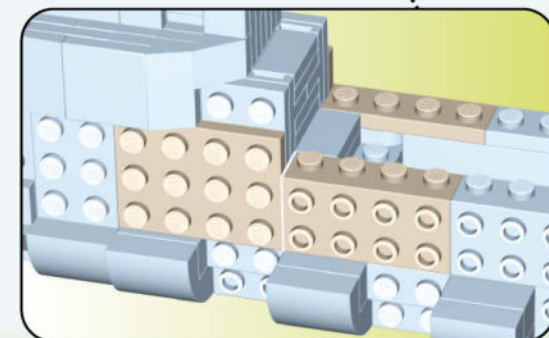
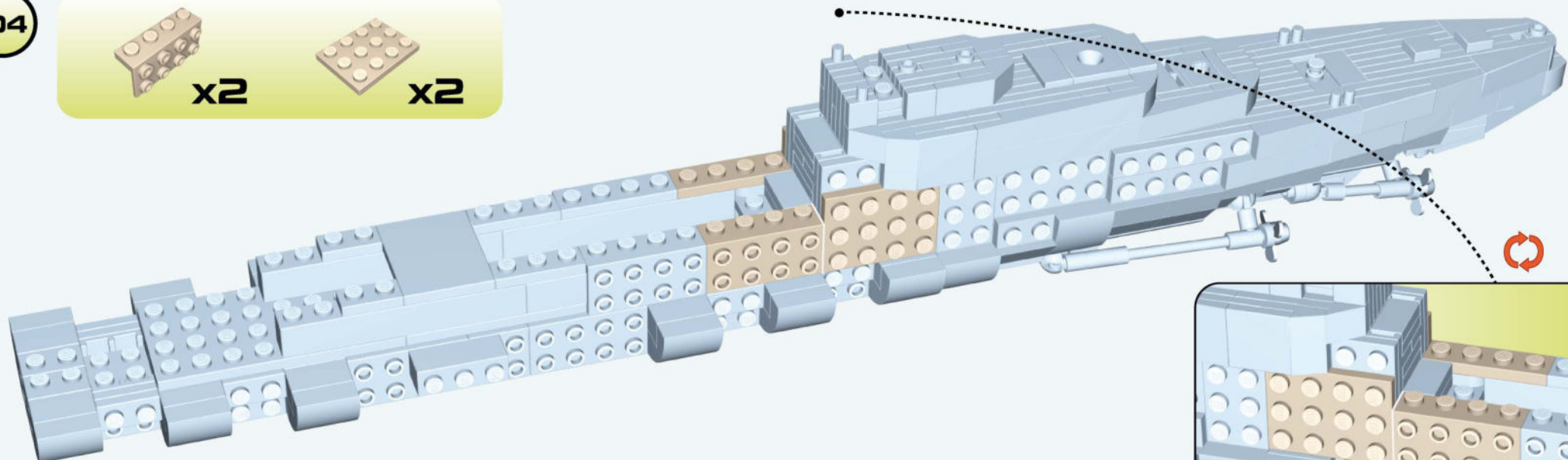

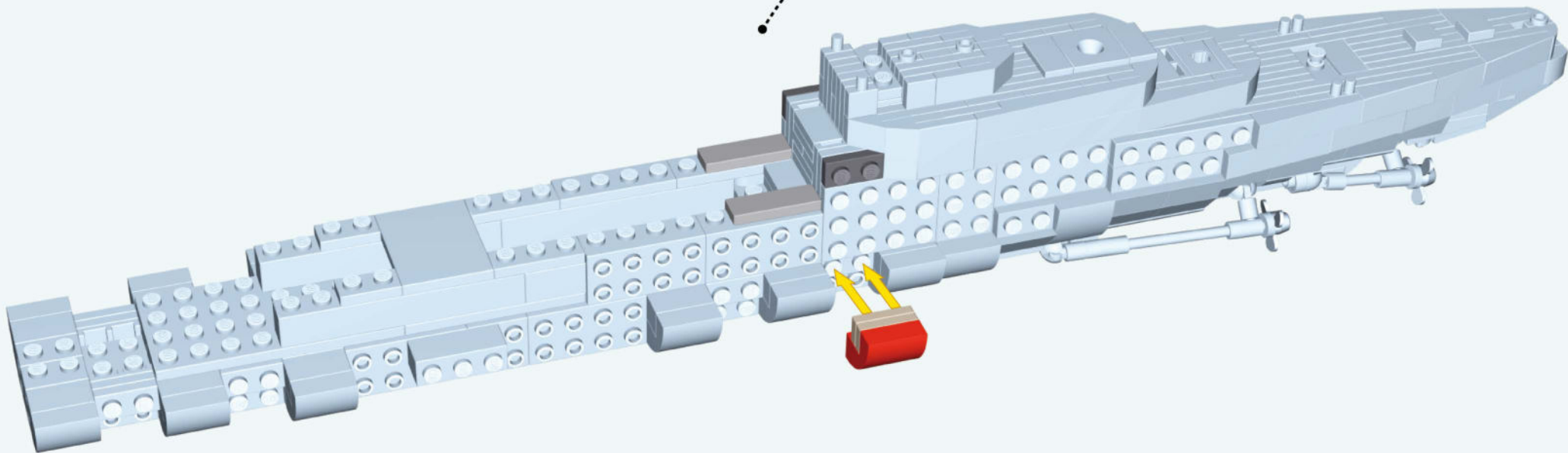
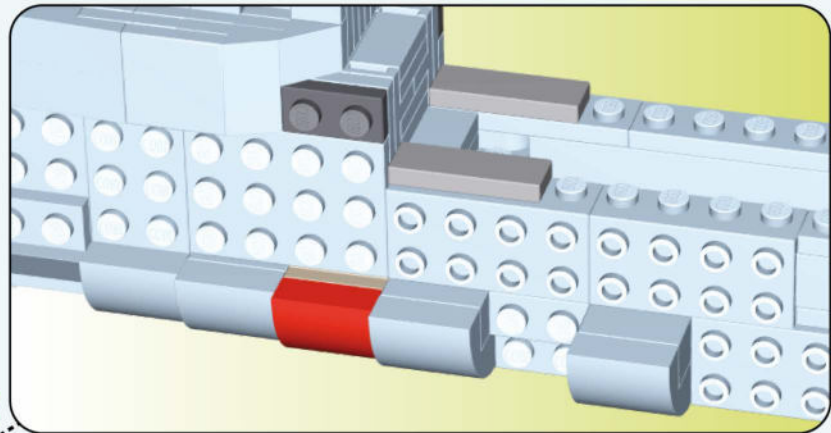
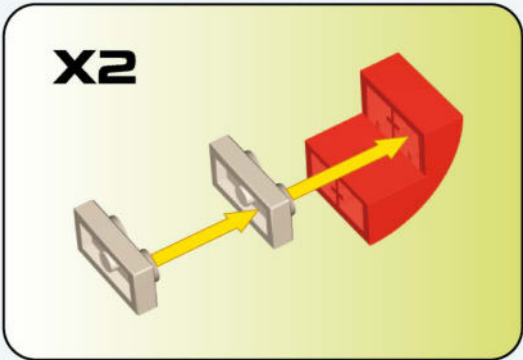

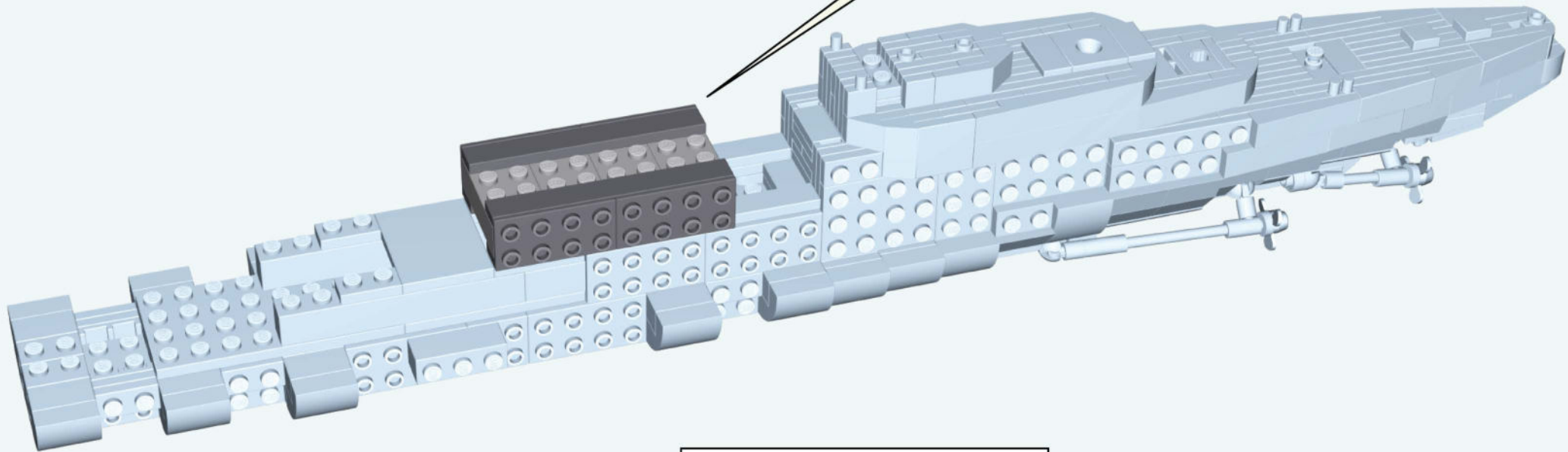
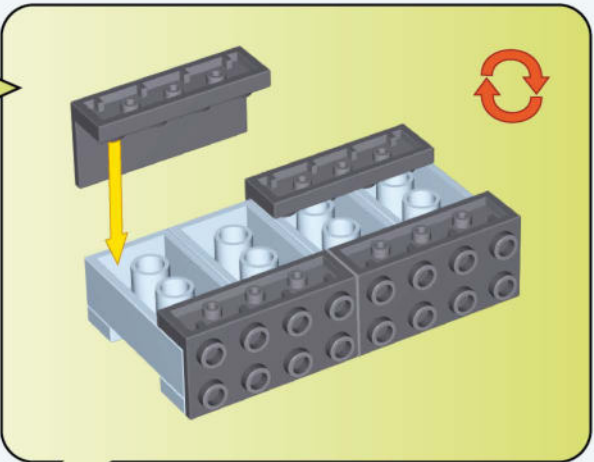
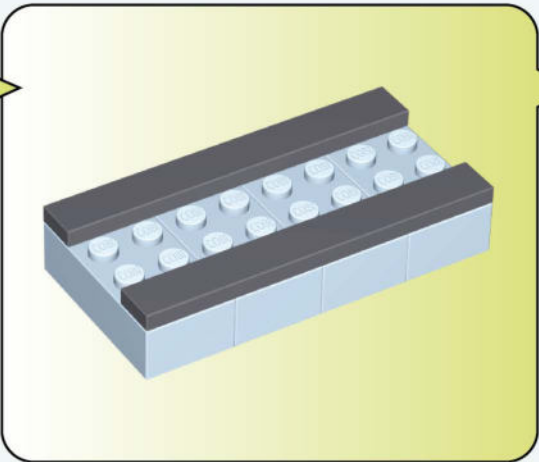
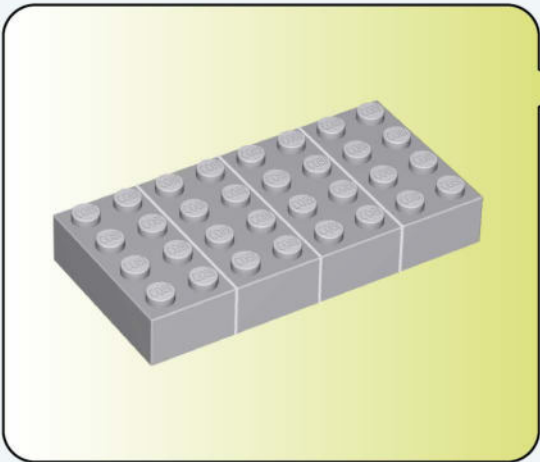

1:1

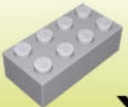

x4



x2



x4



107

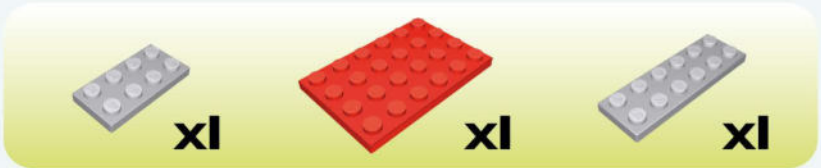
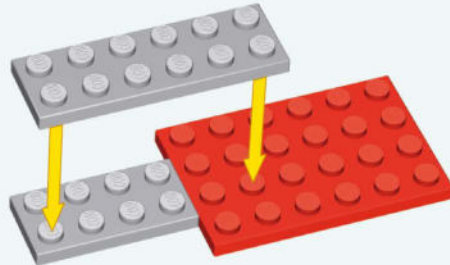

108

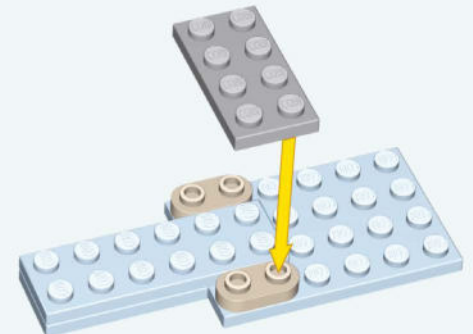

109



110

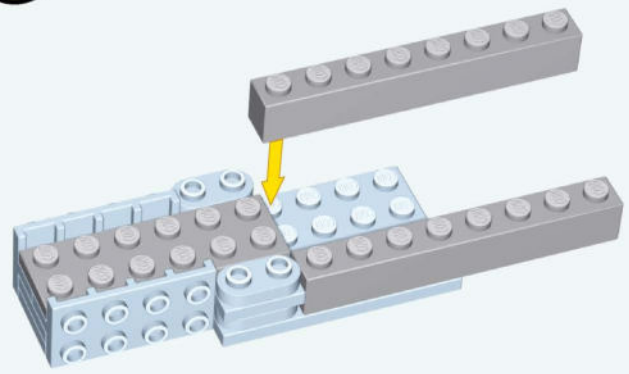

111

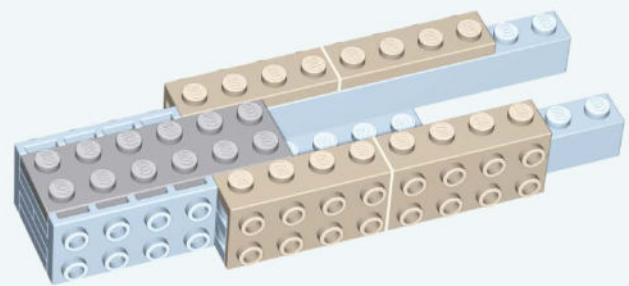

112

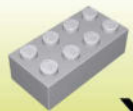
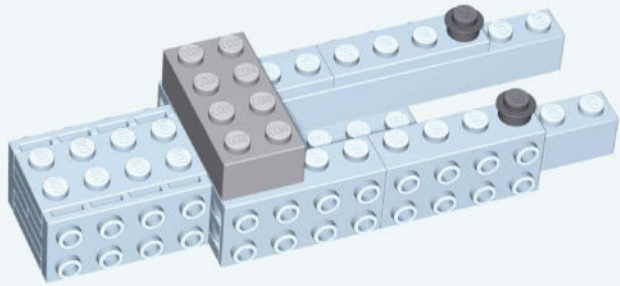

x1



x2

113

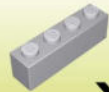
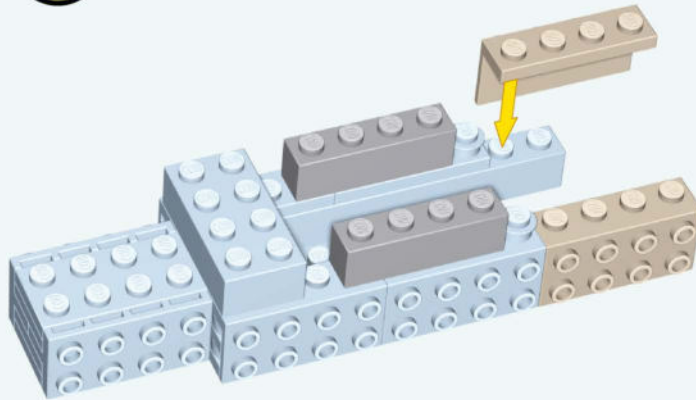

x2



x2

114

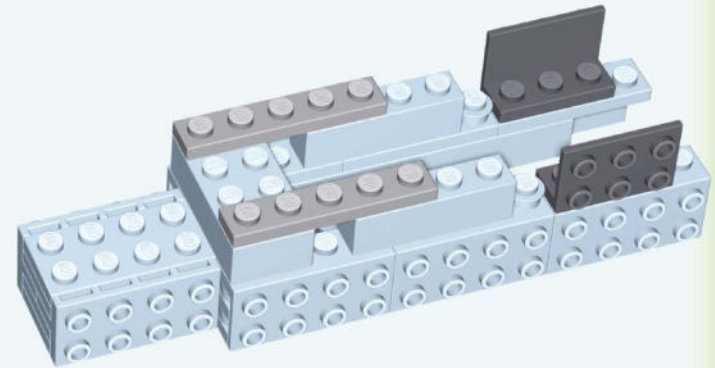

x2



x2

115

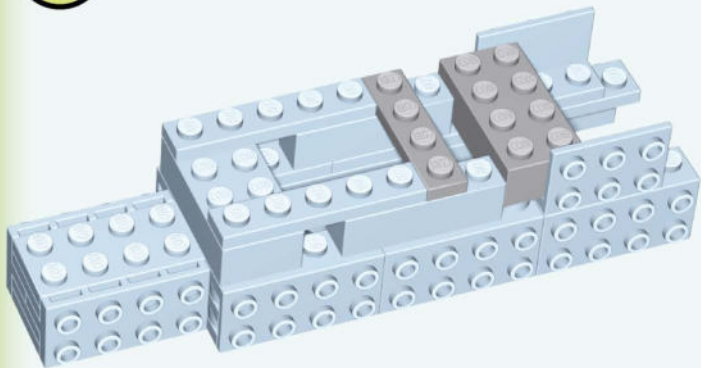

x1

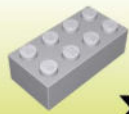

x1

116

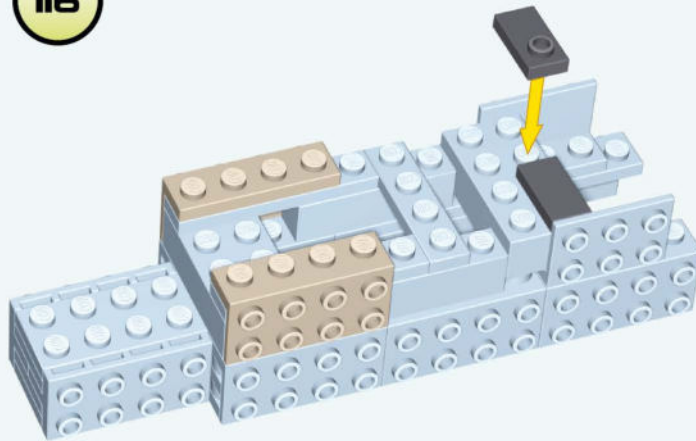

x2

1:1



x1



x1

117

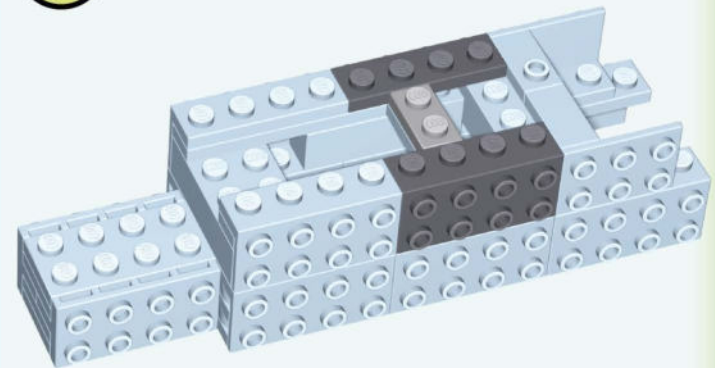

x2



x1

118

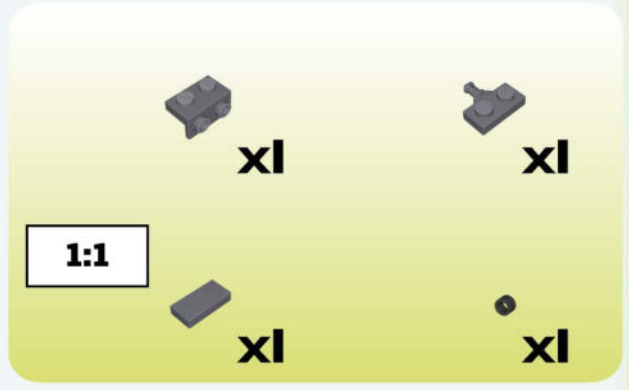
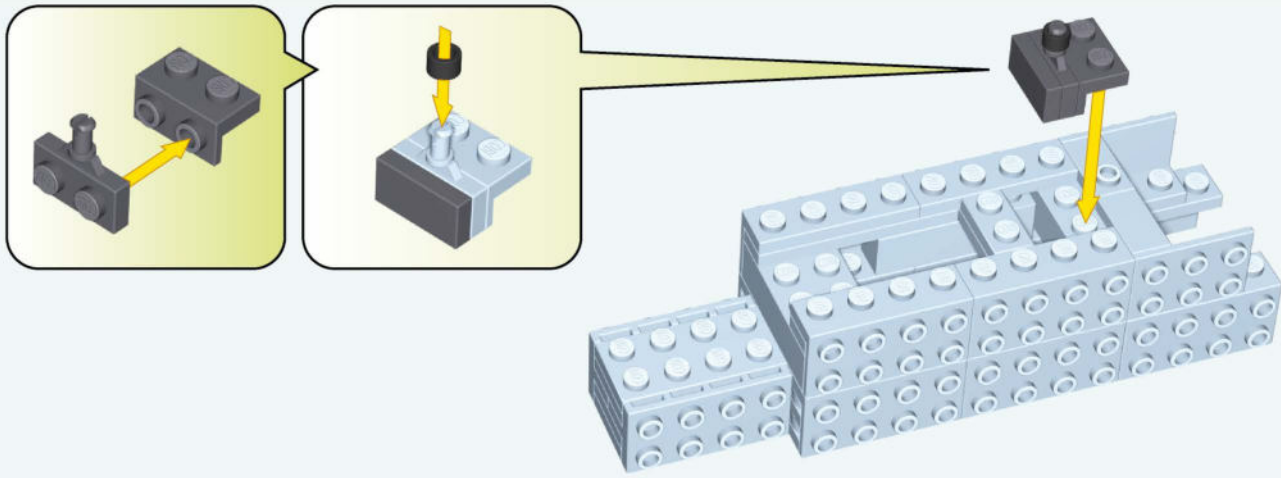

119

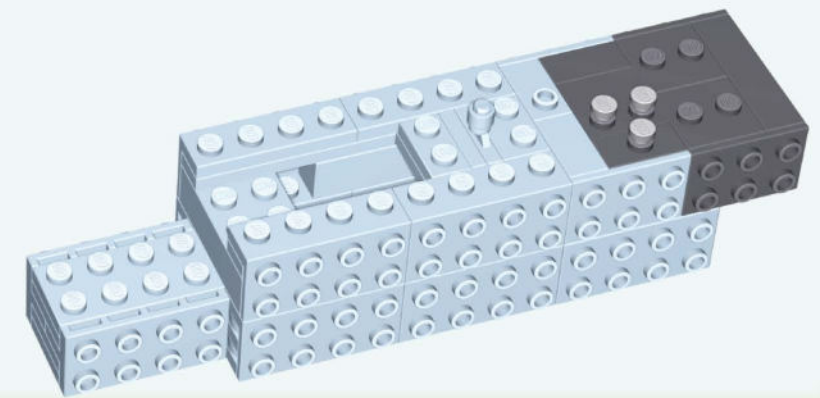
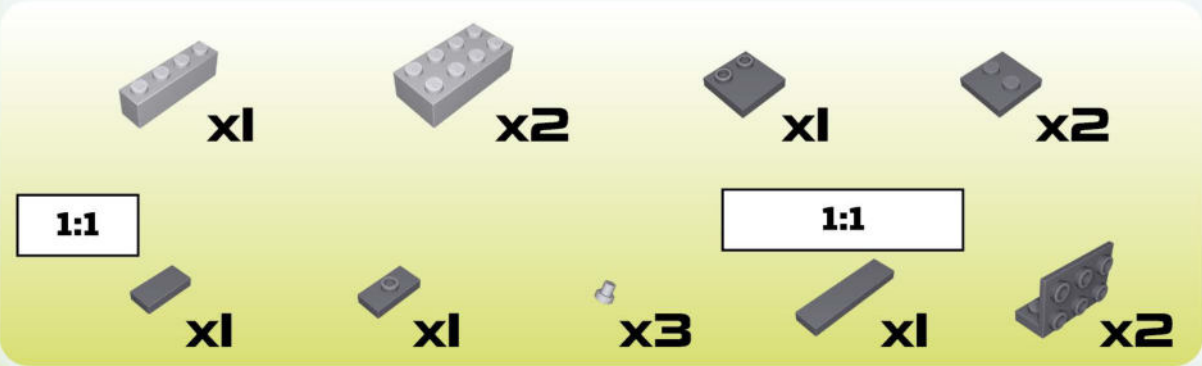
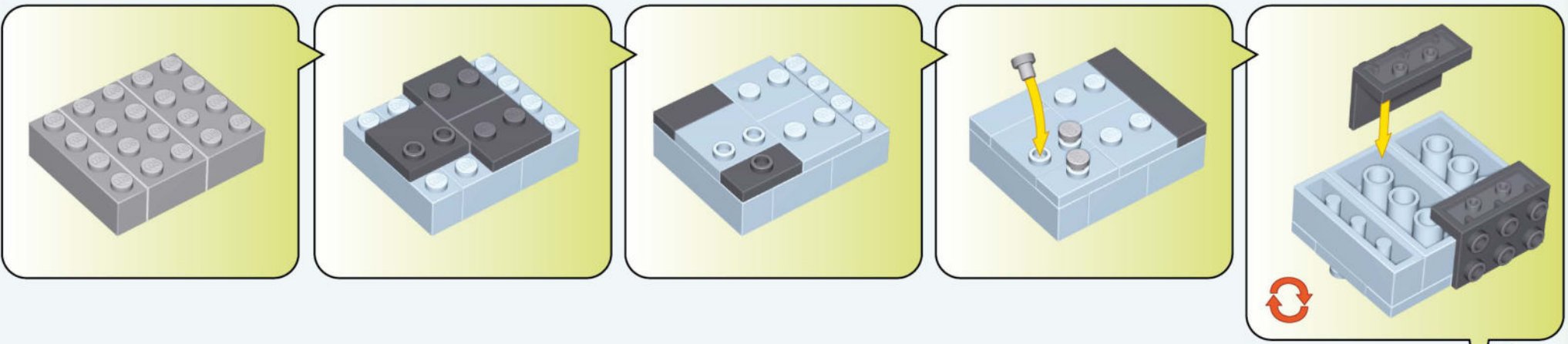

120



121

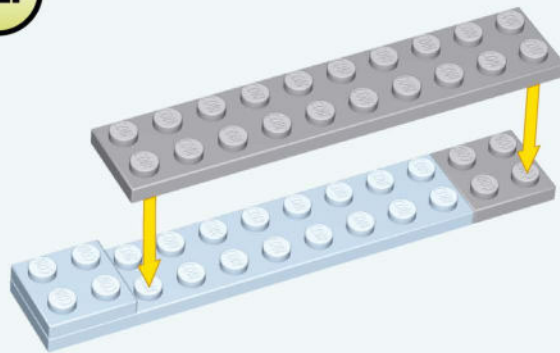

122

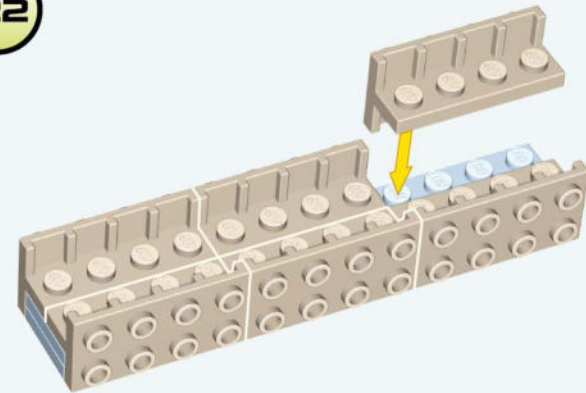

123

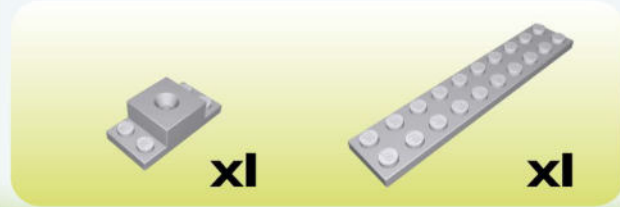
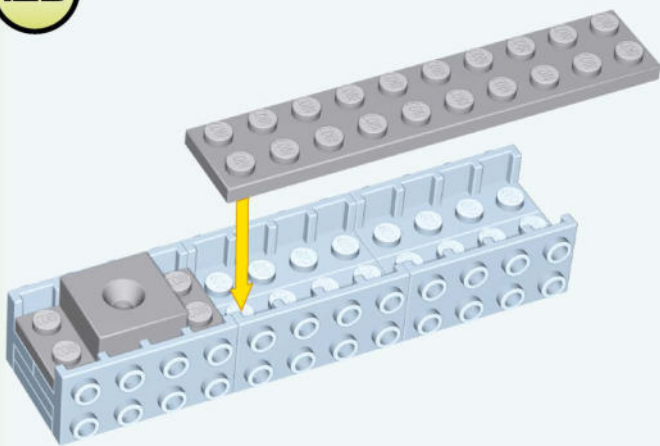

124

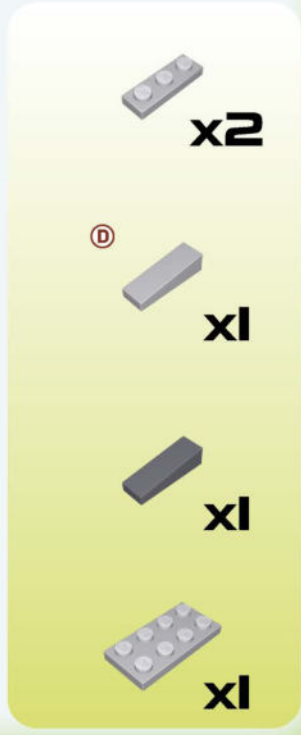
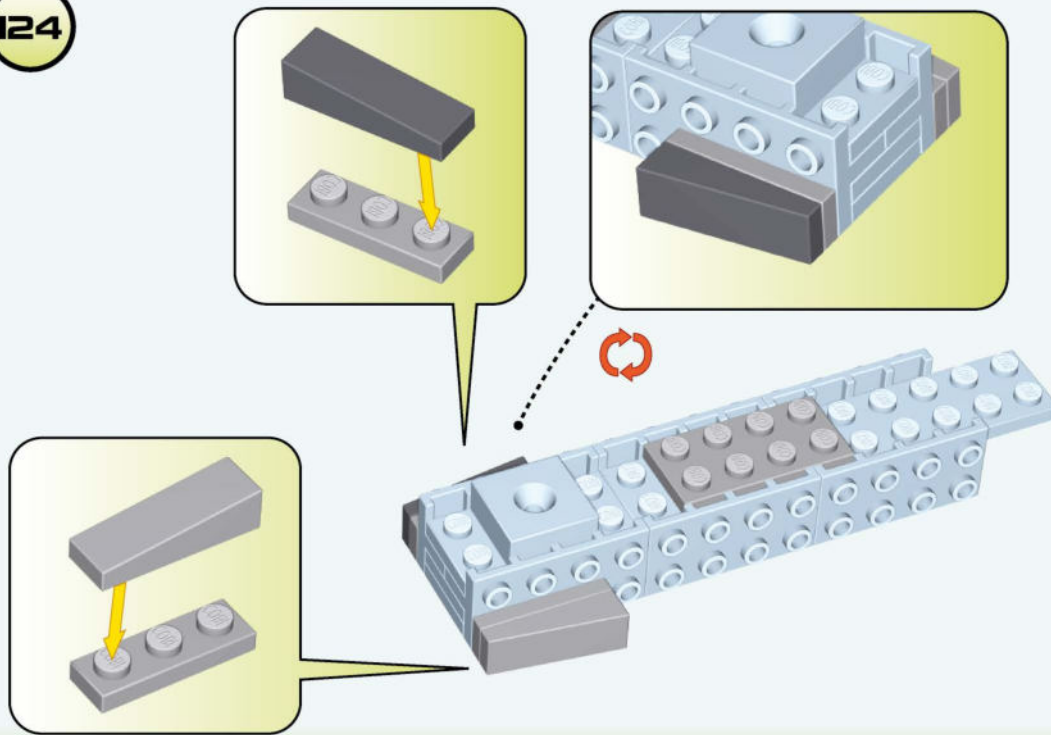

125

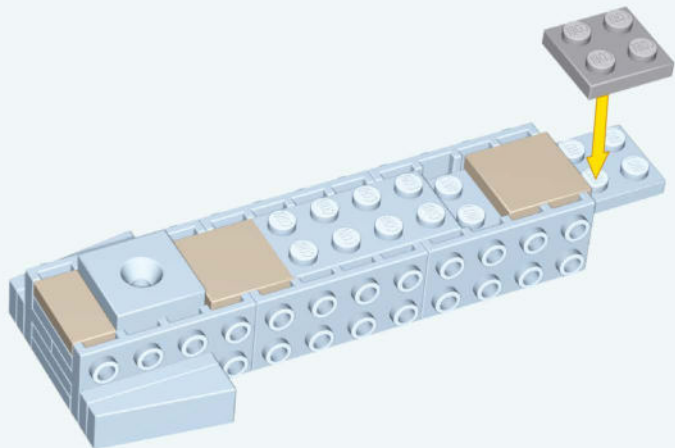

1:1



x1



x2



x1

126

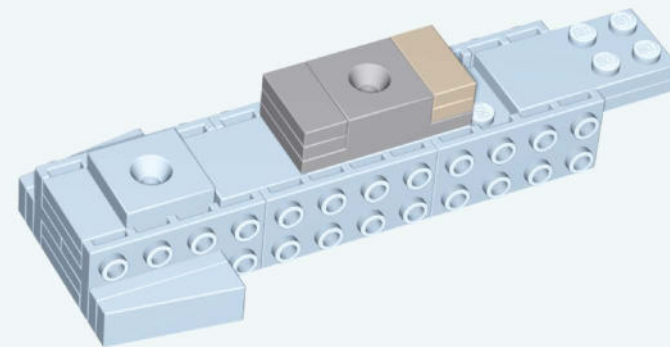
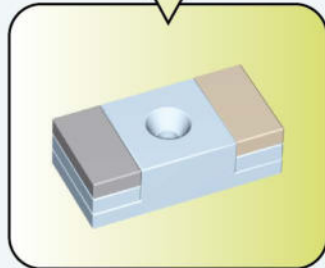
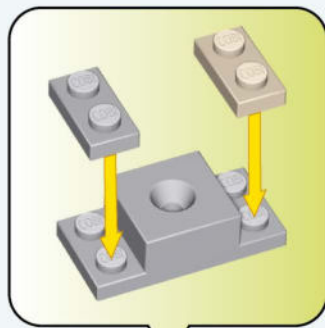

1:1

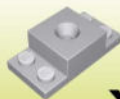

x1



x1



x1



x1



x1

127

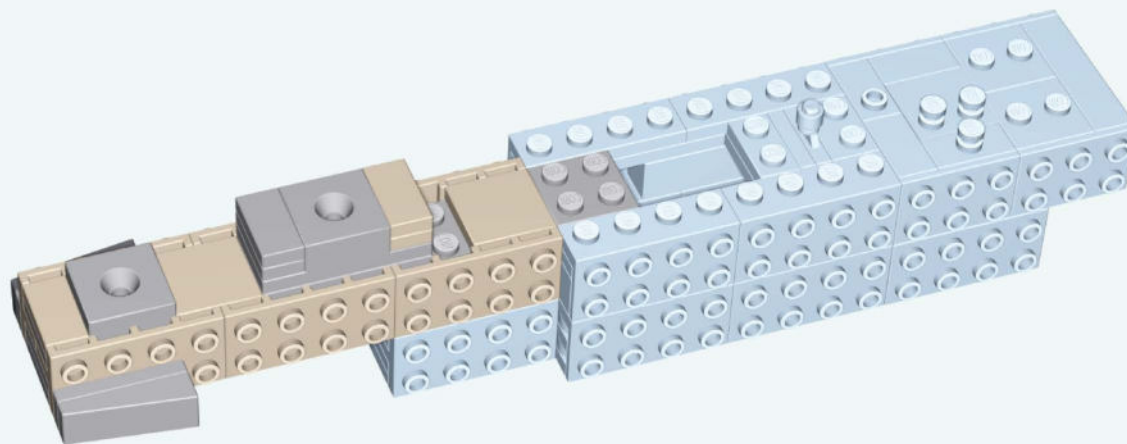

128

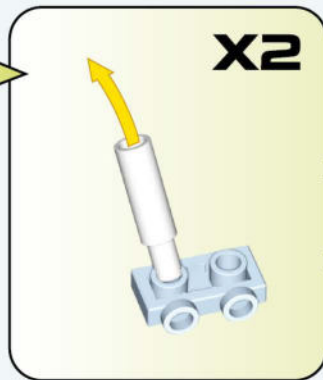
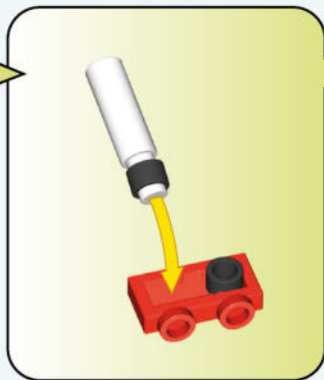
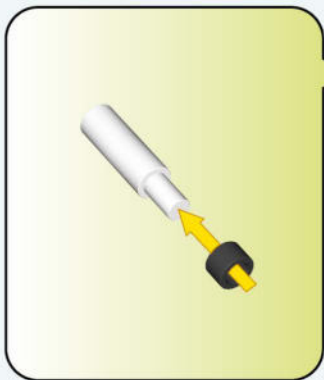

129

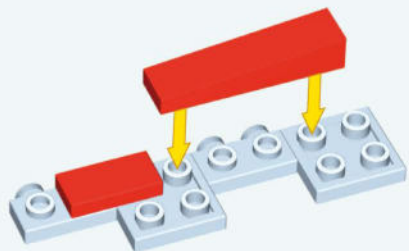

1:1



x1



x1

130

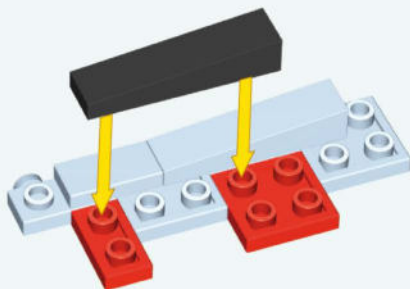

x1



x1



x1

131

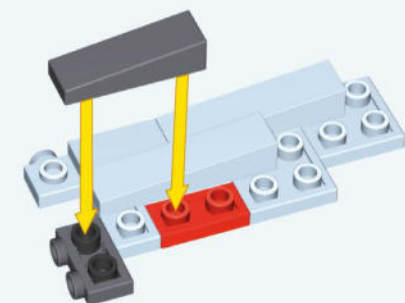
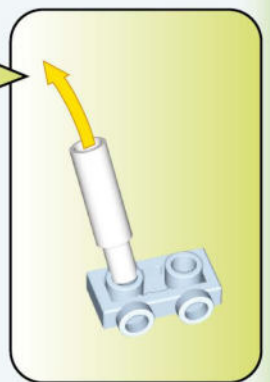
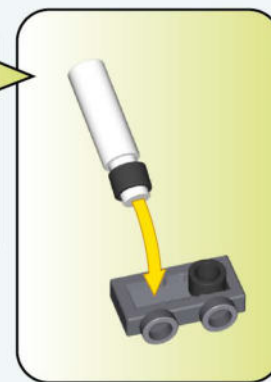
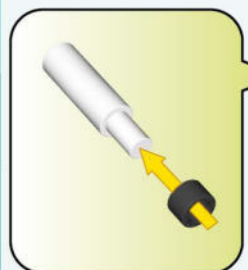

x1



x2



x1



x1

132

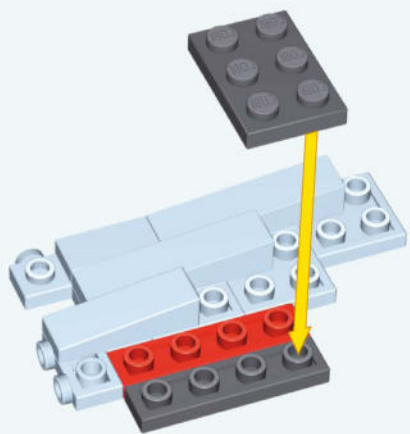

x1



x1



x1

133

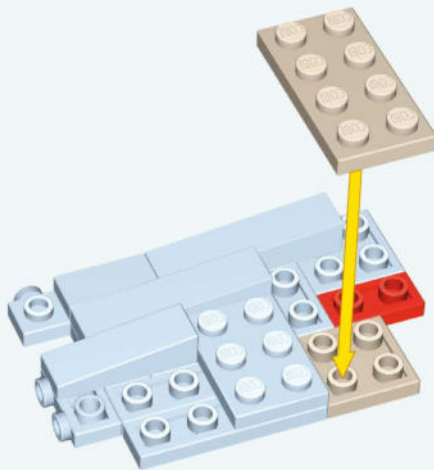

x1



x1



x1

134

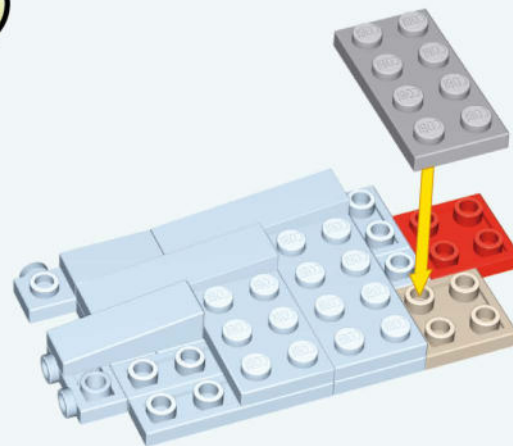

x1



x1



x1

135



x1



x1



x1



x1

136

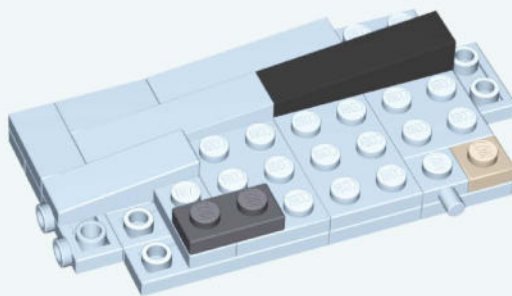

x1



x1



x1

137

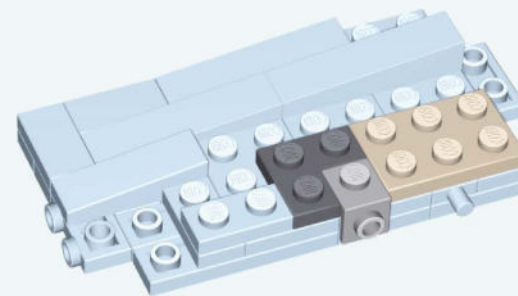

x1



x1



x1